



This is a digital copy of a book that was preserved for generations on library shelves before it was carefully scanned by Google as part of a project to make the world's books discoverable online.

It has survived long enough for the copyright to expire and the book to enter the public domain. A public domain book is one that was never subject to copyright or whose legal copyright term has expired. Whether a book is in the public domain may vary country to country. Public domain books are our gateways to the past, representing a wealth of history, culture and knowledge that's often difficult to discover.

Marks, notations and other marginalia present in the original volume will appear in this file - a reminder of this book's long journey from the publisher to a library and finally to you.

### **Usage guidelines**

Google is proud to partner with libraries to digitize public domain materials and make them widely accessible. Public domain books belong to the public and we are merely their custodians. Nevertheless, this work is expensive, so in order to keep providing this resource, we have taken steps to prevent abuse by commercial parties, including placing technical restrictions on automated querying.

We also ask that you:

- + *Make non-commercial use of the files* We designed Google Book Search for use by individuals, and we request that you use these files for personal, non-commercial purposes.
- + *Refrain from automated querying* Do not send automated queries of any sort to Google's system: If you are conducting research on machine translation, optical character recognition or other areas where access to a large amount of text is helpful, please contact us. We encourage the use of public domain materials for these purposes and may be able to help.
- + *Maintain attribution* The Google "watermark" you see on each file is essential for informing people about this project and helping them find additional materials through Google Book Search. Please do not remove it.
- + *Keep it legal* Whatever your use, remember that you are responsible for ensuring that what you are doing is legal. Do not assume that just because we believe a book is in the public domain for users in the United States, that the work is also in the public domain for users in other countries. Whether a book is still in copyright varies from country to country, and we can't offer guidance on whether any specific use of any specific book is allowed. Please do not assume that a book's appearance in Google Book Search means it can be used in any manner anywhere in the world. Copyright infringement liability can be quite severe.

### **About Google Book Search**

Google's mission is to organize the world's information and to make it universally accessible and useful. Google Book Search helps readers discover the world's books while helping authors and publishers reach new audiences. You can search through the full text of this book on the web at <http://books.google.com/>

GRINNALDS-TWYFORD  
COLLECTION PRESENTED TO THE  
UNIVERSITY OF VIRGINIA  
BY  
MR. AND MRS. JEFFERSON C. GRINNALDS  
AS A MEMORIAL TO HIS MOTHER  
ROBERTA SARAH TWYFORD

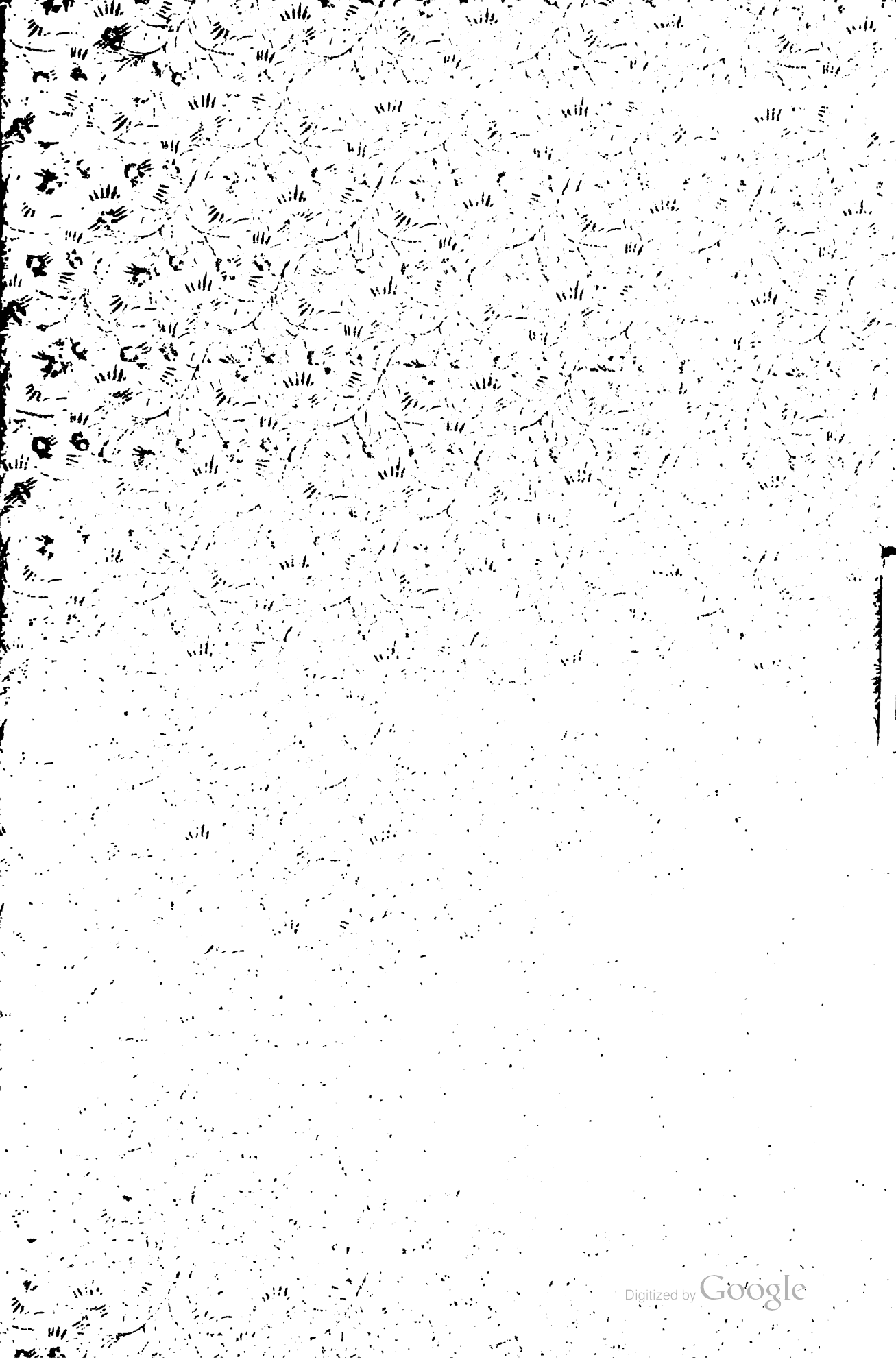

**NOT TO BE TAKEN  
FROM THE LIBRARY**









1. Man in doublet with deep waistcoat and short mantle. 2. Woman with hood, gown (embroidered bodice) and apron. 3. Man in slit costume with mantle, hat and sandals. 4. Woman with cape and turban. 5. Woman with farthingale and mill-stone (Elizabethan) ruff. 6. Man with cuirass, short mantle and mill-stone (Elizabethan) ruff. 7. Man in doublet, puffed breeches and short mantle. 8. Woman with overgarment, hat and calotte.



1. Costumes in the times of the Thirty Years' War, with waistcoat, lace collar, jackboots and spur-straps. 2. Woman with skirt bodice with sleeves, hat with feathers and ruff. 3. Man in short-sleeved jacket, skirt, trousers and mantle. 4. Woman in short-sleeved robe and undergarment. 5, 6. Costumes in the time of Louis XV. 7, 8. Costumes toward the end of the 18th century and at the time of the French Revolution.







THE  
NEW WERNER TWENTIETH CENTURY EDITION  
OF THE  
ENCYCLOPÆDIA BRITANNICA

A STANDARD WORK OF REFERENCE IN  
ART, LITERATURE, SCIENCE, HISTORY, GEOGRAPHY,  
COMMERCE, BIOGRAPHY, DISCOVERY  
AND INVENTION

*NEW MAPS AND FULLY ILLUSTRATED, WITH THOU-  
SANDS OF PORTRAITS, PLATES, AND ENGRAVINGS*

THE ENGLISH NINTH EDITION IN TWENTY-FIVE VOLUMES WAS EDITED BY  
PROFS. SPENCER BAYNES, LL.D., AND W. ROBERTSON SMITH, LL.D.

ASSISTED BY OVER ONE THOUSAND CONTRIBUTORS

*The first twenty-four volumes of the New Werner Edition contain thirty-one new and later articles, written  
by American authors, replacing articles on similar subjects written by different  
authors for the original ninth English (Foreign) Edition*

WITH

NEW AMERICAN SUPPLEMENT

COMPLETE IN THIRTY VOLUMES

VOLUME VI

THE WERNER COMPANY  
AKRON, OHIO

1907

ROBERTA SARAH TWYFORD  
MEMORIAL PUBLIC LIBRARY.  
PARKSLEY, VA.

AE  
5  
E36  
1907  
V.G  
Copy 1

MADE BY  
THE WERNER COMPANY  
AKRON, OHIO

# Encyclopædia Britannica.

NEW WERNER TWENTIETH CENTURY EDITION.

VOL. VI.—(CLI—DAY).

Total number of Articles, 761.

## PRINCIPAL CONTENTS.

- CLIMATE.** ALEX. BUCHAN, Secretary, Scottish Meteorological Society.
- CLIVE.** G. SMITH, LL.D., Editor of "Annals of Indian Administration, 1868-69."
- CLOCKS.** Right Hon. Lord GRIMSTHORPE, Q.C.
- CLUB.** Rev. Canon J. S. NORTHCOTE, and J. CLAUDE WEBSTER, Athenæum Club.
- COAL.** H. BAUERMAN, F.G.S., Royal School of Mines.
- COBDEN.** HENRY RICHARD, M.P.
- COCHIN CHINA.** C. MAUNOIR, Société de Géographie.
- COFFEE.** JAMES PATON, Corporation Galleries, Glasgow.
- COFFER-DAMS.** DAVID STEVENSON, C.E.
- COLEOPTERA.** JOHN GIBSON, Industrial Museum, Edinburgh.
- COLERIDGE.** Rev. G. D. BOYLE, M.A.
- COLOMBIA.** H. A. WEBSTER.
- COLOSSIANS.** Rev. W. SAUMAREZ SMITH, Principal, St. Aidan's College, Birkenhead.
- COMET.** J. RUSSELL HIND, F.R.S., Superintendent of the "Nautical Almanac."
- COMMERCE.** ROBERT SOMERS, Author of "Trade Unions."
- COMMUNISM.** Mrs. FAWCETT.
- COMPANY.** EDMUND ROBERTSON, LL.D., M.P., Professor of Roman Law, University College.
- COMPASS.** F. H. BUTLER, M.A. [London.]
- COMTE.** JOHN MORLEY, M.P., Editor of the "Men of Letters" Series.
- CONDILLAC.** Rev. D. BALSILLIE, M.A.
- CONDORCET.** ROBERT FLINT, D.D., Professor of Divinity, University of Edinburgh.
- CONFUCIUS.** Rev. JAMES LEGGE, Professor of Chinese, University of Oxford.
- CONGRESS.** HENRY REEVE, C.B.
- CONGREVE.** A. C. SWINBURNE.
- CONIC SECTIONS.** H. M. TAYLOR, Fellow of Trinity College, Cambridge.
- CONNECTICUT.** W. G. ABBOT, Hartford, Conn.
- CONSTANTINE.** W. BROWNING SMITH.
- CONSTANTINOPLE.** Rev. C. G. CURTIS, Chaplain to British Embassy, Pera.
- CONSTITUTION OF BODIES.** Prof. CLERK MAXWELL.
- CONTRABAND.** W. C. SMITH, LL.B., Advocate.
- CONVOCAION.** Sir TRAVERS TWISS, Q.C.
- COOKERY.** J. C. BUCKMASTER, South Kensington Museum, London.
- COOLIE.** R. WILSON.
- CO-OPERATION.** R. SOMERS.
- COPPER.** JAMES PATON.
- COPTS.** S. BIRCH, LL.D., D.C.L.
- COPYRIGHT.** Prof. ED. ROBERTSON (AMERICAN), E. S. DRONE.
- CORALS.** Prof. H. A. NICHOLSON.
- COREA.** H. A. WEBSTER.
- CORINTH.** PERCY GARDNER, British Museum.
- CORINTHIANS.** Rev. W. SAUMAREZ SMITH.
- CORK.** R. CAULFIELD, LL.D.
- CORN LAWS.** R. SOMERS.
- CORNEILLE.** GEORGE SAINTSBURY.
- CORNELIUS.** W. CAVE THOMAS.
- CORNWALL.** R. J. KING.
- CORONATION.** Rev. S. H. REYNOLDS.
- CORREGGIO.** W. M. ROSSETTI.
- COSMOGONY.** Rev. Prof. CHEYNE.
- COSTUME.** A. STUART MURRAY and Rev. CHARLES BOUTELL.
- COTTON.** ISAAC WATTS, Chairman of Cotton Supply Association, Manchester.
- COUNCIL.** D. PATRICK.
- COURT-MARTIAL.** W. C. SMITH, LL.B.
- COUSIN.** JOHN VEITCH, LL.D., Professor of Logic and Rhetoric, University of Glasgow.
- COWLEY.** EDMUND W. GOSSE, Author of "New Poems."
- COX.** W. B. SCOTT.
- CRANACH.** J. A. CROWE, Author of "Painting in Italy."
- CRANMER.** W. BROWNING SMITH.
- CREEDS.** Very Rev. Principal TULLOCH.
- CREMATION.** W. C. SMITH, LL.B.
- CRETE.** E. H. BUNBURY, Author of "History of Ancient Geography."
- CRIBBAGE.** HENRY JONES.
- CRICKET.** H. F. WILKINSON.
- CRIME.** L. O. PIKE, Author of "History of Crime in England."
- CRIMEA.** Commander J. B. TELFER, R.N.
- CRIMINAL LAW.** Prof. ED. ROBERTSON.
- CROMWELL, OLIVER.** ALEX. NICOLSON, LL.D.
- CROMWELL, THOMAS.** T. M'K. WOOD.
- CROQUET.** HENRY JONES.
- CROSS.** Rev. CHARLES BOUTELL.
- CROUP.** Dr. J. O. AFFLECK.
- CRUSADES.** Rev. Sir Geo. W. COX, Bart.
- CRUSTACEA.** HENRY WOODWARD, F.R.S., British Museum.
- CRYPT.** Rev. Canon VENABLES.
- CRYPTOGRAPHY.** J. E. BAILEY.
- CRYSTALLOGRAPHY.** JAMES NICOL, late Professor of Natural History, University of Aberdeen.
- CUBA.** KEITH JOHNSTON.
- CUCKOO.** ALFRED NEWTON, Professor of Zoölogy, etc., University of Cambridge.
- CUDWORTH.** Prof. R. FLINT, D.D.
- CUMBERLAND.** H. I. JENKINSON and J. C. WARD.
- CUMBERLAND (BISHOP).** Prof. FLINT.
- CUMBERLAND (DRAMATIST).** A. W. WARE, Professor of English Literature, Owens College, Manchester.
- CURVE.** ARTHUR CAYLEY, LL.D., F.R.S., Sadlerian Professor of Mathematics, Cambridge.
- CUTTLEFISH.** Prof. H. A. NICHOLSON.
- CUYP.** J. A. CROWE, Author of "Painting in Italy."
- CYPRUS.** E. H. BUNBURY.
- CYRUS.** Rev. Prof. A. H. SAYCE, Queen's College, Oxford.
- DACCA.** Hon. W. W. HUNTER, LL.D., Director-General of Indian Statistics.
- DAHOMY.** Col. W. K. ELLES, C.B.
- DALHOUSIE.** GEORGE SMITH, LL.D., Editor of "Annals of Indian Administration."
- DALLING.** CHARLES KENT.
- DALTON.** F. H. BUTLER.
- DAMASCUS.** J. L. PORTER, D.D., LL.D., Professor of Biblical Criticism, Belfast.
- DANCE.** W. C. SMITH, LL.B.
- DANIEL.** Rev. Prof. CHEYNE.
- DANTE.** OSCAR BROWNING, M.A., Fellow of King's College, Cambridge.
- DANTON.** JOHN MORLEY, M.P.
- DARIUS.** Rev. Prof. SAYCE.
- DAVID.** Prof. W. ROBERTSON SMITH, LL.D.

# LIST OF ILLUSTRATIONS

## VOLUME VI.

	PAGE		PAGE
Capitol, Washington, The.....	240	Orabs (Plate X).....	476-477
Clocks (28 Descriptive Cuts).....	13-35	Oracow, Austria, Plan of.....	479
Coal (Plate I).....	48-49	Crete, Mediterranean, Island of.....	508
Coal (Plates II to V).....	64-65	Cribbage Board.....	509
Coal (25 Descriptive Cuts).....	47-72	Cricket-Field, Diagram of.....	512
Ooblentz, Prussia, Plan of.....	83	Cronstadt, Russia, Sketch Map of.....	587
Cochin, China, Sketch Map of.....	85	Croquet (8 Diagrams).....	588
Cocoa Tree, Branch of.....	98	Cross (16 Descriptive Cuts).....	541, 542
Coffee (8 Descriptive Cuts).....	100-108	Crown (16 Descriptive Cuts).....	547, 548
Coffer-Dams (8 Descriptive Cuts).....	104, 105	Crustacea (88 Descriptive Cuts).....	559-560
Coke Oven, Coppée's.....	108	Cuba and Adjacent Islands, Sketch Map of.....	600
Colchester, England, Arms of.....	118	Curling-Rink, Diagram of.....	629
Coleoptera (Plates VI, VII and VIII).....	120-121	Curve, Diagrams of.....	632, 636
Cologne, Prussia, Descriptive Plan of.....	136	Cuttle-Fish (6 Descriptive Cuts).....	649-653
Columbus, Christopher.....	153	Cyprus, Mediterranean, Island of.....	659
Compass Card.....	201, 208	Dahomey, Africa, Chart of.....	674
Congleton, England, Arms of.....	285	Dairy Farm-steading, Elevation and Plan of... ..	678
Conic Sections (51 Diagrams).....	242-254	Dantzic, Prussia, Plan of.....	720
Connecticut, Sketch Map of.....	255	Darmstadt, Plan of.....	729
Constantinople, Descriptive Map of.....	272	Mosque of St. Sophia, Plan of.....	273
Copenhagen, Denmark, Plan of.....	305	Congressional Library.....	240
Corals (15 Descriptive Cuts).....	327-342		
Cordova, Spain, Plan of.....	346	<b>MAPS</b>	
Corea, Eastern Asia, Sketch Map of.....	347	Colorado.....	144-145
Cork, Ireland, Plan of.....	360	Connecticut.....	256-257
Corsica, Mediterranean, Island of.....	889	Cornwall.....	376-377
Costume (52 Descriptive Cuts).....	400-424	Cumberland.....	616-617
Cotton (14 Descriptive Cuts).....	428-442	North Dakota.....	680-681
Coventry, England, Arms of.....	470	South Dakota.....	680-681

# ENCYCLOPÆDIA BRITANNICA.

**CLICHY**, or **CLICHY LA GARENNE**, a village or township of France, in the department of Seine, situated on the right bank of the river, immediately to the north of the ramparts of Paris, of which it may almost be said to be part. It is the seat of a number of extensive industrial establishments, engaged in the manufacture of steam engines, chemical stuffs, and glass. The village is of high antiquity, and was the residence of some of the early kings of France. Its church was built in the 17th century under the direction of the famous Saint Vincent de Paul, who at that time had charge of the cure. Population in 1872, 14,599.

**CLIFTON**, a watering place and fashionable resort of England, in the county of Gloucestershire, forming practically a part of the city of Bristol. It is situated on the eastern heights above the gorge of the lower Avon, which divides it from the county of Somerset,—partly occupying a spacious table-land about 250 feet above the sea, and partly an abrupt declivity which sinks down to the once fashionable district of the Hotwells, on the same level as Bristol. Three ancient British earthworks bear witness to an early settlement on the spot, and a church was in existence as far back as the time of Henry II., when it was bestowed by William de Clyfton on the abbot of the Austin canons in Bristol; but, with the exception, perhaps, of Mardyke House, in Hotwells, there are no longer any architectural vestiges of an earlier date than the 18th century. Of the churches the most important are St. Andrew's parish church, an ungainly structure rebuilt in 1819; All Saints, erected in 1863 at a cost of £32,000, after the designs of G. E. Street, and remarkable for the width of its nave and the narrowness of its aisles; and the Roman Catholic pro-cathedral church of the Holy Apostles, with a convent and schools attached. Among the other buildings of note may be mentioned the Victoria Rooms, which are used for concerts and other public assemblies, the Fine Arts Academy, dating from 1857, and Clifton College, a well designed cluster of buildings in the Gothic style, founded in 1862 by a limited liability company, and giving education to 550 boys. The famous suspension bridge across the Avon, designed by Brunel and commenced in 1832, was completed in 1864. It has a span of 702 feet, and the roadway is 245 feet above high water; the total weight of the structure is 1500 tons, and it is calculated to stand a burden of 9 tons per square inch. Since it was opened a village called New Clifton has grown up on the opposite bank. The once famous hot springs of Clifton, to which, in fact, the town was indebted for its rise, are no longer frequented. They issue from an aperture at the foot of St. Vincent's Rock, and the water has a temperature of about 76° Fahr. The population of Clifton in 1712, the date of the second edition of Sir Thomas Alleyne's work on Gloucester, was only 450; in 1841 it amounted to 14,177; in 1857 to 17,634; in 1861 to 21,375; and in 1871 to 26,364. In the last-mentioned year there were 10,319 males and 16,045 females. The average annual mortality is about 14 per 1000.

**CLIMATE**. The word Climate, or *κλίμα*, being derived from the verb *κλίνω*, to incline, was applied by the ancients to signify that obliquity of the sphere with respect to the horizon from which results the inequality of day and

night. The great astronomer and geographer Ptolemy divided the surface of the globe, from the equator to the arctic circle, into climates or parallel zones, corresponding to the successive increase of a quarter of an hour in the length of midsummer-day. Within the tropics these zones are nearly of equal breadth; but, in the higher latitudes, they contract so much that it was deemed enough to reckon them by their doubles, answering consequently to intervals of half an hour in the extension of the longest day. To compute them is an easy problem in spherical trigonometry. As the sine of the excess of the semi-diurnal arc above a quadrant is to unity, so is the tangent of the obliquity of the ecliptic, or of 23° 28', to the cotangent of the latitude. The semi-diurnal arcs are assumed to be 91° 52½', 93° 45', 95° 37½', 97° 30', &c., and the following table, extracted from Ptolemy's great work, will give some general idea of his distribution of seasons over the surface of the globe. The numbers are calculated on the supposition that the obliquity of the ecliptic was 23° 51' 20'', to which, according to the theory of Laplace, it must have actually approached in the time of Ptolemy. They seem to be affected by some small errors, especially in the parallels beyond the seventeenth, as the irregular breadth of the zone abundantly shows; but they are, on the whole, more accurate than those given by Varenus.

Climate or Parallel.	Latitude.		Length of Midsummer Day.	Breadth of Zone.	Climate or Parallel.	Latitude.		Length of Midsummer Day.	Breadth of Zone.
	°	'				°	'		
I.	0	0	12 00	4 15	XIV.	43	4	15 15	1 57
II.	4	15	12 15	4 10	XV.	45	1	15 30	1 50
III.	8	25	12 30	4 5	XVI.	46	51	15 45	1 41
IV.	12	30	12 45	3 57	XVII.	48	32	16 00	1 32
V.	16	27	13 00	3 47	XVIII.	50	4	16 15	1 36
VI.	20	15	13 15	3 37	XIX.	51	40	16 30	1 10
VII.	23	51	13 30	3 21	XX.	52	50	16 45	1 40
VIII.	27	12	13 45	3 10	XXI.	54	30	17 00	1 30
IX.	30	22	14 00	2 56	XXII.	55	00	17 15	1 00
X.	33	18	14 15	2 42	XXIII.	56	00	17 30	1 00
XI.	36	00	14 30	2 35	XXIV.	57	00	17 45	1 00
XII.	38	35	14 45	2 21	XXV.	58	00	18 00	30
XIII.	40	56	15 00	2 9	XXVI.	59	30	18 30	

Climate in its modern acceptation signifies that peculiar state of the atmosphere in regard to heat and moisture which prevails in any given place, together with its meteorological conditions generally in so far as they exert an influence on animal and vegetable life. The infinitely diversified character which climate displays may be referred to the combined operation of different causes, which are chiefly reducible to these four—distance from the equator, height above the sea, distance from the sea, and prevailing winds, which may thus be regarded as forming the great bases of the law of climate.

Of these causes which determine climate incomparably the most potent is distance from the equator. The same sunbeam which, falling vertically, acts on a surface equal to its own sectional area, is, when falling obliquely, on the

earth, spread over a surface which becomes larger in inverse proportion to the sine of the obliquity. Consequently less and less heat continues to be received from the sun by the same extent of surface in proceeding from the equator toward the poles; and this diminution of heat with the increase of obliquity of incidence of the solar rays is enhanced by the circumstance that the sun's heat, being partially absorbed in its passage through the atmosphere, the absorption is greatest where the obliquity is greatest, because there the mass of air to be penetrated is greatest. Hence arise the broad features of the distribution of temperature over the globe, from the great heat of equatorial regions, falling by easy gradations with increase of latitude, to the extreme cold of the poles. If the earth's surface were uniform, and its atmosphere motionless, these gradations would run everywhere parallel with the latitudes, and Ptolemy's classification of the climates of the earth would accord with fact. But the distribution of land and water over the earth's surface and the prevailing winds bring about the subversion of what Humboldt has termed the solar climate of the earth, and present us with one of the most difficult, as certainly it is one of the most important problems of physical science, viz., the determination of the real climates of its separate regions and localities, and the causes on which they depend.

The decrease of temperature with height is perceptibly felt in ascending mountains, and is still more evident in the snow-clad mountains, which may be seen even in the tropics. The snow-line marks the height below which all the snow that falls annually melts during summer. The height of this line above the sea is chiefly determined by the following causes—by distance from the equator; by the exposure to the sun's rays of the slope of the mountain, and hence, in northern latitudes, it is higher on the south than on the north slopes of mountains, other things being equal; by situation with reference to the rain-bringing winds; by the steepness of the slope; and by the dryness or wetness of the district. Since, then, no general rule can be laid down for the height of the snow-line, it can only be ascertained by observation. Speaking generally it sinks little from the equator to 20° N. and S. lat.; from 20° to 70° it continues to fall equably, but from 70° it falls rapidly to 78°, where it is at sea-level.

The following are a few of the more noteworthy of the exceptions. On the north side of the Himalayas it is about 4000 feet higher than on the south side, owing to the greater depth of snow falling on the south side and the greater dryness of the climate of Tibet, resulting in a more active evaporation from the snows and stronger sun-heat on the north side, to which is to be added the comparative want of vegetation on the north side, thus favoring a more rapid melting of the snows. The snow-line is higher in the interior of continents than near their coasts, the rainfall there being less and the heat of summer greater; and similarly, owing to the greater prevalence of westerly over easterly winds in many regions of the globe, it is higher on the east than on the west sides of continents. In South America the snow-line rises very considerably from the equator to 18° S. lat. and more so, markedly, on the west than on the east slopes of the Cordilleras, because of the smaller amount of precipitation of the west side of this mountain range. It is as high in 33° as in 18° S. lat., but south of 33° it rapidly sinks owing to the heavy rains brought by the westerly winds which begin to prevail there. In the south of Chili it is 6000 feet lower than among the Rocky Mountains at the same distance from the equator, and 3000 feet lower than in the same latitudes in Western Europe. It is impossible to overestimate the importance of the snow-line as one of the factors of climate in its relations to the distribution of animal and vegetable life.

Glaisher, in his balloon ascents, made observations of temperature at different heights, the results of which may be thus summarized. Within the first 1000 feet the average space passed through for 1° was 223 feet with a cloudy sky and 182 feet with a clear sky; at 10,000 feet the space passed through for 1° was 455 feet for the former and 417 feet for the latter; and above 20,000 feet the space with both states of the sky was 1000 feet nearly for a decline of 1°. It must be noted, however, that these rates of decrease refer to the temperature of the atmosphere at different heights above the ground, which are in all probability altogether different from the rates of decrease for *ones on the earth's surface* at these heights above the level

of the sea—the problem with which climatologists have to deal.

Observation shows, as might have been expected, that the rate at which the temperature falls with the height is a very variable quantity,—varying with latitude, situation, the state of the air as regards moisture or dryness, and calm or windy weather, and particularly with the hour of the day and the season of the year. In reducing temperature observations for height, 1° for every 300 feet is generally adopted. In the present state of our knowledge this or any other estimation is at best no more than a rough approximation, since the law of decrease through its variations requires yet to be stated, being in truth one of the most intricate and difficult problems of climatology awaiting investigation at the hands of meteorologists. Among the most important climatic results to be determined in working out this problem are the heights at which in different seasons the following critical mean temperatures, which have important relations to animal and vegetable life, are met with in ascending from low-lying plains in different regions of the world, viz., 80°, 75°, 70°, 65°, 63°, 60°, 58°, 55°, 50°, 45°, 39° (the maximum density of fresh water), 32° (its freezing point), and 20°.

These results, which only affect the mean daily temperature in different seasons, and which are due exclusively to differences of absolute height, though of the greatest possible practical importance, yet leave untouched a whole field of climatological research—a field embracing the mean temperature of different hours of the day at different heights, for an explanation of which we must look to the physical configuration of the earth's surface and to the nature of that surface, whether rock, sand, black soil, or covered with vegetation.

Under this head by far the most important class of conditions are those which result in extraordinary modifications, amounting frequently to subversions, of the law of the decrease of temperature with the height. This will perhaps be best explained by supposing an extent of country diversified by plains, valleys, hills, and table-lands to be under atmospheric conditions favorable to rapid cooling by nocturnal radiation. Each part being under the same meteorological conditions, it is evident that terrestrial radiation will proceed over all at the same rate, but the effects of radiation will be felt in different degrees and intensities in different places. As the air in contact with the declivities of hills and rising grounds becomes cooled by contact with the cooled surface, it acquires greater density, and consequently flows down the slopes and accumulates on the low-lying ground at their base. It follows, therefore, that places on rising ground are never exposed to the full intensity of frosts at night; and the higher they are situated relatively to the immediately surrounding district the less are they exposed, since their relative elevation provides a ready escape downwards for the cold air almost as speedily as it is produced. On the other hand valleys surrounded by hills and high grounds not only retain their own cold of radiation, but also serve as reservoirs for the cold heavy air which pours down upon them from the neighboring heights. Hence mist is frequently formed in low situations whilst adjoining eminences are clear. Along low-lying situations in the valleys of the Tweed and other rivers of Great Britain laurels, araucarias, and other trees and shrubs were destroyed during the great frost of Christmas 1860, whereas the same species growing on relatively higher grounds escaped, thus showing by incontestable proof the great and rapid increase of temperature with height at places rising above the lower parts of the valleys.

This highly interesting subject has been admirably elucidated by the numerous meteorological stations of Switzerland. It is there observed in calm weather in winter, when the ground becomes colder than the air above it, that systems of descending currents of air set in over the whole face of the country. The direction and force of these descending currents follow the irregularities of the surface, and like currents of water they tend to converge and unite in the valleys and gorges, down which they flow like rivers in their beds. Since the place of these air-currents must be taken by others, it follows that on such occasions the temperature of the tops of mountains and high grounds is relatively high because the counter-currents come from a great height and are therefore warmer. Swiss villages are generally built on eminences rising out of the sides of the mountains



with ravines on both sides. They are thus admirably protected from the extremes of cold in winter, because the descending cold air-currents are diverted aside into the ravines, and the counter-currents are constantly supplying warmer air from the higher regions of the atmosphere.

Though the space filled by the down-flowing current of cold air in the bottom of a valley is of greater extent than the bed of a river, it is yet only a difference of degree, the space being in all cases limited and well defined, so that in rising above it in ascending the slope the increased warmth is readily felt, and, as we have seen, in extreme frosts the destruction to trees and shrubs is seen rapidly to diminish. The gradual narrowing of a valley tends to a more rapid lowering of the temperature for the obvious reason that the valley thereby resembles a basin almost closed, being thus a receptacle for the cold air-currents which descend from all sides. The bitterly cold furious gusts of wind which are often encountered in mountainous regions during night are simply the out-rush of cold air from such basins.

The two chief causes which tend to counteract these effects of terrestrial radiation are forests and sheets of water. If a deep lake fills the basin, the cold air which is poured down on its surface having cooled the surface water, the cooled water sinks to a greater depth, and thus the air resting over the lakes is little if at all lowered in temperature. Hence deep lakes may be regarded as sources of heat during winter, and places situated near their outlet are little exposed to cold gusts of wind, while places on their shores are free from the severe frosts which are peculiar to other low-lying situations. The frosts of winter are most severely felt in those localities where the slopes above them are destitute of vegetation, and consist only of bare rock and soil, or of snow. If, however, the slopes be covered with trees, the temperature is warmer at the base and up the sides of the mountain,—the beneficial influence of forests consisting in the obstacle they offer to the descending currents of cold air and in distributing the cold produced by terrestrial radiation through a stratum of the atmosphere equalling in thickness the height of the trees.

Hence as regards strictly local climates, an intelligent knowledge of which is of great practical value, it follows that the best security against the severity of cold in winter is afforded where the dwellings are situated on a gentle acclivity a little above the plain or valley from which it rises with an exposure to the south, and where the ground above is planted with trees. When it is borne in mind that in temperate climates, such as that of Great Britain, the majority of the deaths which occur in the winter months are occasioned or at least hastened by low temperatures, it will be recognized as of the most vital importance, especially to invalids, to know what are the local situations which afford the best protection against great cold. In truth, mere local situations may during periods of intense cold have the effect of maintaining a temperature many degrees above that which prevails close at hand—a difference which must mitigate suffering and not unfrequently prolong life.

In addition to mere elevation and relative configuration of surface, the land of the globe brings about important modifications of climate in the degree in which its surface is covered with vegetation or is a desert waste. Of all surfaces that the earth presents to the influences of solar and terrestrial radiation an extent of sand is accompanied with the most extreme fluctuations of climate, as these are dependent on the temperature and moisture of the air; whilst on the other hand, extensive forests tend to mitigate the extremes of temperature and distribute its daily changes more equably over the twenty-four hours.

As regards the influence of the sun's heat on the temperature of the air, attention is to be given almost exclusively to the temperature of the extreme upper surface of the earth heated by the sun with which the air is in immediate contact. Badly conducting surfaces, such as sand, will evidently have the greatest influence in raising the temperature of the air, for the simple reason that the heat produced by the sun's rays being conveyed downwards into the soil with extreme slowness must necessarily remain longer on the surface, in other words, remain in immediate contact with the atmosphere. Similarly at night, the cooling effects of terrestrial radiation being greatest on sandy surfaces, the climate of sandy deserts is characterized by nights of comparatively great cold. These daily

alternations of heat and cold are still further intensified by the great dryness of the air over extensive tracts of sand. In warm countries the surface temperature of sandy deserts often rises to 120°, 140°, or even to 200°, and the shade temperature has been observed as high as 125°. It is this hot air, loaded with particles of sand still hotter, and driven onwards by furious whirlwinds, which forms the dreaded simoon of the desert; and the irritating and enervatingairocco of the regions bordering the Mediterranean is to be traced to the same cause. It is in the deserts of Africa, Arabia, Persia, and the Punjab that the highest temperature on the globe occurs, the mean summer temperature of these regions rising to and exceeding 95°. The extreme surface of loam and clay soils is not heated during day nor cooled during night in so high a degree as that of sandy soils, because, the former being better conductors, the heat or the cold is more quickly conveyed downward, and therefore not allowed to accumulate on the surface.

When the ground is covered with vegetation the whole of the sun's heat falls on the vegetable covering, and as none of it falls directly on the soil its temperature does not rise so high as that of land with no vegetable covering. The temperature of plants exposed to the sun does not rise so high as that of soil, because a portion of the sun's heat is lost in evaporation, and the heat cannot accumulate on the surface of the leaves as it does on the soil. Hence the essential difference between the climates of two countries, the one well covered with vegetation, the other not, lies in this, that the heat of the day is more equally distributed over the twenty-four hours in the former case, and therefore less intense during the warmest part of the day.

But the effect of vegetation on the distribution of the temperature during the day is most markedly shown in the case of forests. Trees, like other bodies, are heated and cooled by radiation, but owing to their slow conducting power the times of the daily maximum and minimum temperature do not occur till some hours after the same phases of the temperature of the air. Again, the effects of radiation are in the case of trees not chiefly confined to a surface stratum of air a very few feet in thickness, but as already remarked, are to a very large extent diffused through a stratum of air equalling, in thickness at least, the height of the trees. Hence the conserving influence of forests on climate, making the nights warmer and the days cooler, imparting, in short, to the climates of districts clad with trees something of the character of insular climates. Evaporation proceeds slowly from the damp soil usually found beneath trees, since it is more or less screened from the sun. Since, however, the air under the trees is little agitated or put in circulation by the wind, the vapor arising from the soil is mostly left to accumulate among the trees, and hence it is probable that forests diminish the evaporation, but increase the humidity, of climates within their influence. The humidity of forests is further increased by the circumstance that when rain falls less of it passes immediately along the surface into streams and rivers; a considerable portion is at once taken up by the leaves of the trees and percolates the soil, owing to its greater friability in woods, to the roots of the trees, whence it is drawn up to the leaves and there evaporated, thus adding to the humidity of the atmosphere.

Much has been done by Dr. Marsh and others in elucidation of the influence on climate of forests and the denudation of trees, in so far as that can be done by the varying depths of lakes and rivers and other non-instrumental observations. Little comparatively has been done anywhere in the examination of the great practical question of the influence of forests on climate, by means of carefully devised and conducted observations made with thermometers, the evaporating dish, or the rain gauge. The most extensive inquiry on the subject yet set on foot has been for some years conducted in the forests of Bavaria under the direction of Professor Ebermeyer, and a like inquiry was begun in Germany in 1875,—the more important results being that during the day, particularly in the warm months, the temperature in the forest is considerably lower than outside in the open country, there being at the same time a slow but steady outflow of air from the forest; and that during the night the temperature in the forest is higher, while there is an inflow of air from the open country into the forest. The mean annual temperature in the forest increases from the surface of the ground to the tops of the trees (where it is observed to approximate to what is ob-

served in the open country), a result evidently due to the facility of descent to the surface of the cold air produced by terrestrial radiation, and to the obstruction offered by the trees to the solar influence at the surface. The mean annual temperature of the woodland soil from the surface to a depth of 4 feet is from 2° to 3° lower than that of the open country. A series of observations was begun at Carnwath, Lanarkshire, in 1873, at two stations, one outside a wood, and the other inside the wood in a small grass plot of about 50 feet diameter clear of trees. From these valuable results have been obtained relative to the differences in the daily march of temperature and the different rates of humidity, the most important being the substantial agreement of the mean annual temperature of the two places. The establishment of a station, with underground thermometers, which it is proposed to erect under the shade of the trees close to the station in the cleared space, will furnish data which will not only throw new light on the questions raised in this inquiry, but also on the movements and viscosity of the air and solar and terrestrial radiation.

When the sun's rays fall on water they are not as in the case of land arrested at the surface, but penetrate to a considerable depth, which, judging from observations made by Sir Robert Christison on Loch Lomond, and from those made on board the "Challenger," is probably in clear water about 600 feet. Of all known substances water has the greatest specific heat, this being, as compared with that of the soil and rocks composing the earth's crust, in the proportion of about 4 to 1. Hence water is heated much more slowly by the sun's rays and cooled more slowly by nocturnal radiation than the land. It is owing to these two essential differences between land and water with respect to heat that climates come to be grouped into the three great classes of oceanic, insular, and continental climates.

The maximum densities of fresh and salt water, which are respectively 39°·1 and 28°·2 (when the sea-water is the average degree of saltness), mark an essential distinction between the effects of sheets of fresh and salt water on climate. The surface temperature of sea-water falls very slowly from 39°·1 to 28°·4, its freezing point, because as it falls the temperature of the whole water through its depths must fall; whilst from 39°·1 to 32° the surface temperature of fresh water falls rapidly because it is only the portion floating on the surface which requires to be cooled. If the bottom temperature of fresh water exceed 39°·1 the cooling takes place also very slowly, since in this case the water through all its depth must be cooled down to 39°·1 as well as that of the surface.

The temperature at the greatest depths of Loch Lomond, which is practically constant at all seasons, is not 47°·8, the mean annual temperature of that part of Scotland, but 42°, which happens to be the mean temperature of the cold half of the year, or that half of the year when terrestrial radiation is the ruling element of the temperature. Thus, then, there is an immense volume of water at the bottom of this lake at a constant temperature 5°·8 below that of the mean annual temperature of the locality. From this follow two important consequences, viz.—(1) during each winter no inconsiderable portion of the cold produced by terrestrial radiation is conveyed away from the surface to the depths of the lake, where it therefore no longer exercises any influence whatever on the atmosphere or on the climate of the district in lowering the temperature; and (2) this annual accession of cold at these depths is wholly counteracted by the internal heat of the earth. In corroboration of this view it may be pointed out that the water of the Rhone as it issues from Lake Geneva is 3°·7 higher than that of the air at Geneva. Thus, the influence of lakes which do not freeze over is to mitigate in some degree the cold of winter over the district where they are situated. This is well illustrated on a large scale by the winter temperature of the lake region of North America. The influence of the sea is exactly akin to that of lakes. Over the surface of the ground slanting to the sea-shore the cold currents generated by radiation flow down to the sea, and the surface-water being thereby cooled sinks to lower depths. In the same manner no inconsiderable portion of the cold produced by radiation in all latitudes over the surface of the ocean and land adjoining is conveyed from the surface to greater depths. The enormous extent to which this transference goes on is evinced by the great physical fact disclosed to us in recent years by deep sea observations of temperature, viz. that the

whole of the depths of the sea is filled with water at or closely approaching to the freezing point of fresh water, which in the tropical regions is from 40° to 50° lower than the temperature of the surface. The withdrawal from the earth's surface in high latitudes of such an enormous accumulation of ice-cold water to the depths of the sea of tropical and subtropical regions, rendered possible by the present disposition of land and water over the globe, doubtless results in an amelioration to some extent of the climate of the whole globe, so far as that may be brought about by a higher surface temperature in polar and temperate regions.

Oceanic climates are the most equable of all climates, showing for the same latitudes the least differences between the mean temperatures of the different hours of the day and the different months of the year, and being at all times the least subject to violent changes of temperature. So far as man is concerned, oceanic climates are only to be met with on board ship. The hygienic value of these climates in the treatment of certain classes of chest and other complaints is very great, and doubtless when better understood in their curative effects they will be more largely taken advantage of. It is, for instance, believed by many well qualified to form an opinion that they afford absolute, or all but absolute, immunity from colds, which are so often the precursors of serious complicated disorders.

The nearest approach to such climates on land is on very small islands such as Monach, which is situated about seven miles to westward of the Hebrides, in the full sweep of the westerly winds of the Atlantic which there prevail. The mean January temperature of this island, which is nearly in the latitude of Inverness, is 43°·4, being 1°·8 higher than the mean of January at Ventnor, Isle of Wight, 0°·8 higher than that of Jersey and Guernsey, and almost as high as that of Truro. Again, Stornoway, being situated on the east coast of Lewis on the Minch, an inland arm of the Atlantic, has thus a less truly insular position than Monach. Its climate is therefore much less insular, and accordingly its mean temperature in January is 38°·7, or 4°·7 lower than that of Monach. From its position near the Moray Firth, on the east of Scotland, Culloden occupies a position still less insular; hence its January temperature is only 37°·1, being 1°·6 less than that of Stornoway, and 6°·3 less than that of Monach.

On the other hand, the mean temperature of July is 55°·0 at Monach, 57°·8 at Culloden, 61°·0 at Guernsey, and 62°·6 at Ventnor. Thus the conditions of temperature at these stations are completely reversed in summer, for while in January Monach is 1°·8 warmer than Ventnor, in summer it is 7°·6 colder. Since the prevailing winds in the British Isles are westerly, places on the east coast are less truly insular than are places similarly situated on the west, whence it follows that the winter and summer climates of the east coast approach more nearly the character of inland climates than do those of the west.

The facts of the temperature at such places as Monach in Scotland and Valentia in Ireland disclose the existence of an all but purely oceanic climate along the coasts, particularly of the west, so distinct and decided, and extending inland so short a distance, that it would be impossible to represent it on any map of land isothermals of ordinary size. The only way in which it can be graphically represented is by drawing on the same map the isothermals of the sea for the same months, as Petermann has done on his chart of the North Atlantic and continents adjoining. Such maps best lead to a knowledge of the true character of our seaside climates.

Though it is impossible to overestimate the climatological importance of seaside climates, as evinced by their curative effects on man, and their extraordinary influence on the distribution of animal and vegetable life, it must be confessed that we are yet only on the threshold of a rational inquiry into their true character. Undoubtedly the first step in this large inquiry is the establishing of a string of about six stations at various distances from a point close to high-water mark to about two miles inland, at which observations at different hours of the day would be made, particularly at 9 A.M. and 3 and 9 P.M., of the pressure, temperature, humidity, movements, and chemistry of the air.

Our large towns have climates of a peculiar character, which may be said to consist chiefly in certain disturbances in the diurnal and seasonal distribution of the temperature, an excess of carbonic acid, a deficiency of ozone, and the presence of noxious impurities. Systematic inquiries into the condition and composition of the air of our large towns have been instituted this year (1876) in Paris and Glasgow, in which the ozone, ammonia, nitric acid, and germs present in different districts of these cities are regularly observed. There yet remain to be devised some means of making truly comparable thermometric and hygrometric observations in different localities, including the more densely-peopled districts, for the investigation of what we may call the artificial climates peculiar to each district. While such an inquiry, at least in its earlier stages, must necessarily be regarded as a purely scientific one, it may fairly be expected to lead sooner or later to a knowledge of the causes which determine the course of many epidemics—why, for instance, diphtheria is more frequent and more fatal in the new than in the old town of Edinburgh, and why in some parts of Leicester diarrhoea is unknown as a fatal disease, while in other parts of the same town it rages every summer as a terrible pestilence among infants—and ultimately suggest the means by which they may be stamped out when they make their appearance.

It has been already pointed out (see *ATMOSPHERE*) that prevailing winds are the simple result of the relative distribution of atmospheric pressure, their direction and force being the flow of the air from a region of higher towards a region of lower pressure, or from where there is a surplus to where there is a deficiency of air. Since climate is practically determined by the temperature and moisture of the air, and since these are dependent on the prevailing winds which come charged with the temperature and moisture of the regions they have traversed, it is evident that isobaric charts, showing the mean pressure of the atmosphere, form the key to the climates of the different regions of the globe, particularly those different climates which are found to prevail in different regions having practically the same latitude and elevation. This principle is all the more important when it is considered that the prevailing winds determine in a very great degree the currents of the ocean which exercise so powerful an influence on climate.

Since winds bring with them the temperature of the regions they have traversed, southerly currents of air are warm winds, and northerly currents cold winds. Also since the temperature of the ocean is more uniform than that of the land, winds coming from the ocean do not cause such variations of temperature as winds from a continent. As air loaded with vapor obstructs both solar and terrestrial radiation, when clear as well as when clouded, moist ocean winds are accompanied by a mild temperature in winter and a cool temperature in summer, and dry winds coming from continents by cold winters and hot summers. Lastly, equatorial currents of air, losing heat as they proceed in their course, are thereby brought nearer the point of saturation, and consequently become moister winds; whereas northerly currents acquiring greater heat in their progress become drier winds.

It follows from these relations of the wind to temperature and moisture that the S.W. wind in the British Isles is a very moist wind, being both an oceanic and equatorial current; whereas the N.E. wind, on the other hand, is peculiarly dry and parching, because it is both a northerly and continental current. Owing to the circumstance of atmospheric pressure diminishing from the south of Europe northwards to Iceland, it follows that S.W. winds are the most prevalent in Great Britain; and since this diminution of pressure reaches its maximum amount and persistency during the winter months, S.W. winds are in the greatest preponderance at this season; hence the abnormally high winter temperature of these islands above what is due to mere latitude. The mean winter temperature of Lerwick, Shetland, in respect of latitude alone would be 3°, and of London 17°, but owing to the heat conveyed from the warm waters of the Atlantic across these islands by the winds, the temperature of Shetland is 39° and of London 38°. In Iceland and Norway the abnormal increase of temperature in winter is still greater. This influence of the Atlantic through the agency of the winds is so preponderating that the winter isothermals of Great Britain lie north and south, instead of the normal east and west direction.

This peculiar distribution of the winter temperature of the British Isles has important bearings on the treatment of diseases. Since the temperature of the whole of the eastern slope of Great Britain is the same, it is clear that to those for whom a milder winter climate is required a journey southward is attended with no practical advantage, unless directed to the west coast. As the temperature on the west is uniform from Shetland to Wales, Scotland is as favorable to weak constitutions during winter as any part of England, except the south-west, the highest winter temperatures being found from the Isle of Wight westward round the Cornish peninsula to the British Channel; and from Carnsore Point in Ireland to Galway Bay the temperature is also high.

The height and direction of mountain ranges form an important factor in determining the climatic characteristics of prevailing winds. If the range be perpendicular to the winds, the effect is to drain the winds which cross them of their moisture, thus rendering the winters colder and the summers hotter at all places to leeward, as compared with places to windward, by partially removing the protecting screen of vapor and thus exposing them more effectually to solar and terrestrial radiation. To this cause much of the observed difference between the west and east climates of Great Britain is due. In Ireland, on the other hand, where the mountains are not grouped in ranges running north and south, but in isolated masses, the difference between the climates of the east and west is very much less. In the east of the United States the prevailing winds in summer are S.W., and as the Alleghanies lie in the same direction the temperature is little affected by these mountains, and the rainfall is pretty evenly distributed on both sides of the range.

In its climatological relations the distribution of rain over the globe presents us with a body of facts which lead, when intelligently interpreted, to a knowledge of the laws regulating the distribution of plants more quickly and certainly than do the facts of temperature. It is to the prevailing winds we must look for an explanation of the rainfall, the broad principles of the connection being these:—1, The rainfall is moderately large when the wind has traversed a considerable extent of ocean; 2, if the winds advance into colder regions the rainfall is largely increased, and if a range of mountains lie across their path the amount precipitated on the side facing the winds is greatly augmented, but diminished over regions on the other side of the range; 3, if the winds, though coming from the ocean, have not traversed a considerable extent of it, the rainfall is not large; and 4, if the winds, even though having traversed a considerable part of the ocean, yet on arriving on the land proceed into lower latitudes, or regions markedly warmer, the rainfall is small or nil. It is this last consideration which accounts for the rainless character of the summer climates of California, of Southern Europe, and of Northern Africa.

The region extending from Alaska to Lower California presents more sudden transitions of climate, and climates more sharply contrasted with each other, than any other portion of the globe, this arising from the contour of its surface and the prevailing winds. A direct contrast to this is offered by the United States to the east of the Mississippi, a region characterized by a remarkable uniformity in the distribution of its rainfall in all seasons, which, taken in connection with its temperature, affords climatic conditions admirably adapted for a vigorous growth of trees and for the great staple products of agriculture. India and the region of the Caspian Sea and the Caucasus Mountains also present extraordinary contrasts of climate in all seasons, due to the prevailing winds, upper as well as lower winds, the relative distribution of land and water, and the physical configuration of the surface of the land.

In the above remarks the only question dealt with has been the average climate of localities and regions. There are, however, it need scarcely be added, vital elements of climate of which such a discussion can take no cognizance. These are the deviations which occur from the seasonal averages of climate, such as periods of extreme cold and heat, or of extreme humidity and dryness of air, liability to storms of wind, thunderstorms, fogs, and extraordinary downfalls of rain, hail, or snow. An illustration will show the climatic difference here insisted on. The mean winter temperature of the Southern States of America is almost the same as that of Lower Egypt.

Lower Egypt is singularly free from violent alternations of temperature as well as frost, whereas these are marked features of the winter climate of the States bordering on the Gulf of Mexico. Robert Russell, in his *Climate of America*, gives an instance of the temperature falling in Southern Texas with a norther from 81° to 18° in 41 hours, the norther blowing at the same time with great violence. A temperature of 18° accompanying a violent wind may be regarded as unknown in Great Britain.

It is to the cyclone and anticyclone (see ATMOSPHERE) we must look for an explanation of these violent weather changes. Climatically, the significance of the anticyclone or area of high pressure consists in the space covered for the time by it being on account of its dryness and clearness more fully under the influence of solar and terrestrial radiation, and consequently exposed to great cold in winter and great heat in summer; and of the cyclone or area of low pressure, in a moist warm atmosphere occupying its front and southern half, and a cold dry atmosphere its rear and northern half.

The low areas of the American cyclones, as they proceed eastward along the north shores of the Gulf of Mexico, are often immediately followed to west and north-westward by areas of very high pressure, the necessary consequence of which is the setting in of a violent norther over the Southern States. Since similar barometric conditions do not occur in the region of Lower Egypt, its climate is free from these sudden changes which are so injurious to the health even of the robust. Since many of the centres of the cyclones of North America follow the track of the lakes and advance on the Atlantic by the New England States and Newfoundland, these States and a large portion of Canada frequently experience cold raw easterly and northerly winds. The great majority of European storms travel eastward with their centres to northward of Faro, and hence the general mildness of the winter climate of the British Isles. When it happens, however, that cyclonic centres pass eastwards along the English Channel or through Belgium and North Germany, while high pressure prevails in the north, the winter is characterized by frosts and snows. The worst summer weather in Great Britain is when low pressures prevail over the North Sea, and the hottest and most brilliant weather when anticyclones lie over Great Britain and extend away to south and eastward.

Low pressures in the Mediterranean, along with high pressures to northward, are the conditions of the worst winter weather in the south of Europe. A cyclone in the Gulf of Lyons or of Genoa, and an anticyclone over Germany and Russia, have the mistral as their unfailing attendant, blowing with terrible force and dryness on the Mediterranean coasts of Spain, France, and North Italy, being alike in its origin and in its climatic qualities the exact counterpart of the norther of the Gulf of Mexico. It follows from the courses taken by the cyclones of the Mediterranean, and the anticyclones which attend on them, that also Algeria, Malta, and Greece are liable to violent alternations of temperature during the cold months.

The investigation of this phase of climate, which can only be carried out by the examination of many thousands of daily weather charts, is as important as it is difficult, since till it be done the advantages and hazards offered by different sanatoria cannot be compared and valued. It may in the meantime be enough to say that no place anywhere in Europe or even in Algeria offers an immunity from the risks arising from the occurrence of cold weather in winter at all comparable to that afforded by the climates of Egypt and Madeira. See ATMOSPHERE, METEOROLOGY, and PHYSICAL GEOGRAPHY. (A. B.)

CLINTON, a city of the United States, in Clinton County, Iowa, about 42 miles higher up than Davenport, on the Mississippi, which is crossed at this point by an iron drawbridge upwards of 4000 feet long. It is a thriving place, with workshops for the Chicago and North-Western Railway, and an extensive trade in timber. Several newspapers are published weekly. Population in 1870, 6129.

CLINTON, a town of the United States, in Worcester county, Massachusetts, on the Nashua River, about 32 miles west of Boston, at the junction of several railway lines. It is the seat of extensive manufacturing activity, chiefly expended in the production of cotton cloths, woollen

carpets, boots and shoes, combs, and machinery. The Lancaster mills rank as perhaps the best in the United States, and the wire cloth company has the credit of being the first to weave wire by the power-loom. Population in 1870, 5429.

CLINTON, DE WITT (1769-1828), an American statesman, born at Little Britain, in the State of New York, was the son of a gentleman of English extraction who served as brigadier-general in the war of independence, and of a lady belonging to the famous Dutch family of De Witts. He was educated at Columbia College; and in 1788 he was admitted to the bar. He at once joined the republican party, among the leaders of which was his uncle, George Clinton, governor of New York, whose secretary he became. At the same time he held the office of secretary to the board of regents of the university, and to the commissioners of fortifications. In 1797 he was elected member of the Assembly, in 1798 member of the Senate of the State of New York, and in 1801 member of the Senate of the United States. For twelve years, with two short breaks, which amounted only to three years, he occupied the position of mayor of New York. He was also again member of the Senate of New York from 1803 to 1811, and lieutenant-governor of the State from 1811 to 1813. In 1812 he became a candidate for the presidency; but he was defeated by Madison, and lost even his lieutenant-governorship. Throughout his whole career Clinton had been distinguished by his intelligent support of all schemes of improvement, and he now devoted himself to carrying out the proposal for the construction of canals from Lakes Erie and Champlain to the River Hudson. The Federal Government refused to undertake the work; but some time after, in 1815, the year in which he finally lost the mayoralty, he presented a memorial on the subject to the Legislature of New York, and the Legislature appointed a commission, of which he was made a member, to make surveys and draw up estimates. Having thus recovered his popularity, in 1816 Clinton was once more chosen governor of the State; in 1819 he was re-elected, and again in 1824 and 1826. In 1825 the Erie Canal was completed; and he afterwards saw the work which owed so much to him carried on by the construction of important branch canals.

De Witt Clinton published a *Memoir on the Antiquities of Western New York* (1818), *Letters on the Natural History and Internal Resources of New York* (1823), and *Speeches to the Legislature* (1823). His life was written by Hosack (1829) and Renwick (1840); and in 1849 appeared Campbell's *Life and Writings of De Witt Clinton*.

CLINTON, HENRY FYNES (1781-1852), an English classical scholar, was born at Gamston, in Nottinghamshire. He was descended from the second Earl of Lincoln; for some generations the name of his family was Fynes, but his father resumed the older family name of Clinton. Educated at Southwell school in his native county, at Westminster school, and at Christ Church College, Oxford, he devoted himself to the minute and almost uninterrupted study of classical literature and history. From 1806 to 1826 he was M. P. for Aldborough.

His chief works are—*Fasti Hellenici, a Civil and Literary Chronology of Greece*, which also contains dissertations on points of Grecian history and Scriptural chronology (4 vols., 1824, 1827, 1830, 1834); and *Fasti Romani, a Civil and Literary Chronology of Rome and Constantinople from the Death of Augustus to the Death of Heraclius* (2 vols., 1845 and 1851). In 1851 he published an epitome of the former, and an epitome of the latter appeared in 1853. *The Literary Remains of H. F. Clinton* was published by C. J. F. Clinton in 1864.

CLITHEROE, a manufacturing town and a municipal and parliamentary borough of England, in the county of Lancashire, situated not far from the Ribble, at the foot of Pendle Hills, about 28 miles by railway north of Manchester. It has several suburbs, known as Waterloo, Salford, and Bawdlands, and at the side of the river is the little village of Low Moor. Its principal buildings are the parish church of St. Michael's, a grammar school founded in 1554, the moothall, and the county court erected in 1864; and its industrial establishments comprise cotton-mills, extensive print-works, paper-mills, foundries, and brick and lime works. The cotton manufacture alone employed upwards of 2000 people in 1871. Clitheroe was a borough by prescription as early as the 11th century.

and in 1138 it is mentioned as the scene of a battle between the Scotch and English. Its castle, probably built not long after, was a fortress of the Lacy family, and continued a defensible position till 1649, when it was dismantled by the Parliamentary forces. The Honor of Clitheroe, for a long time a part of the duchy of Lancaster, and bestowed by Charles II. on General Monk, is now in the possession of the Buccleuch family. Population of the municipal borough in 1871, 8208; of the parliamentary, 11,786.

CLITOMACHUS, a leader of the New Academy, was a Carthaginian originally named Hasdrubal, who came to Athens about the middle of the 2d century B.C. He made himself well acquainted with Stoical and Peripatetic philosophy; but he principally studied under Carneades, whose views he adopted, and whom he succeeded as chief representative of the New Academy in 129 B.C. His works were some 400 in number; but we possess scarcely anything but a few titles, among which are *De sustinendis offensionibus*, *περι τροχης* (on suspension of judgment), and *περι αλθεων* (an account of various philosophical sects). In 146 he wrote a philosophical treatise to console his countrymen after the ruin of their city. One of his works was dedicated to the Latin poet Lucilius, another to L. Censorinus, who was consul in 149 B.C.

CLITOR, a town of ancient Greece, in that part of Arcadia which corresponds to the modern eparchy of Kalavryta. It stood in a fertile plain to the south of Mount Chelmos, the highest peak of the Aroanian Mountains, and not far from a stream of its own name, which joined the Aroanian, or Katzana. In the neighborhood was a fountain, the waters of which were said to deprive those who drank them of the taste for wine. The town was a place of considerable importance in Arcadia, and its inhabitants were noted for their love of liberty. It extended its territory over several neighboring towns, and in the Theban war fought against Orchomenos. As a member of the Achaean league it suffered siege at the hands of the Ætolians, and was on several occasions the seat of the federal assemblies. The ruins, which bear the common name of Paleopoli, or Old City, are still to be seen about three miles from a village that preserves the ancient designation. The greater part of the walls and several of the circular towers with which they were strengthened can be clearly made out; and there are also remains of a small Doric temple, the columns of which were adorned with strange capitals.

CLIVE, ROBERT (1725-1774), Baron Clive of Plassey, in the peerage of Ireland, was the statesman and general who founded the empire of British India before he was forty years of age. He is now represented by the Powis family, his son having been made earl of Powis in the peerage of the United Kingdom. Clive was born on the 29th September, 1725, at Styche, the family estate in the parish of Moreton-Say, Market-Drayton, Shropshire. We learn from himself, in his second speech in the House of Commons in 1773, that as the estate yielded only £500 a year, his father followed the profession of the law also. The Clives, or Clyves, formed one of the oldest families in the county of Shropshire, having held the manor of that name in the reign of Henry II. One Clive was Irish Chancellor of the Exchequer under Henry VIII.; another was a member of the Long Parliament; Robert's father sat for many years for Montgomeryshire. His mother, to whom throughout life he was tenderly attached, and who had a powerful influence on his career, was a daughter, and with her sister Lady Sempill co-heir, of Nathaniel Gaskell of Manchester. Robert was their eldest son. With his five sisters, all of whom were married in due time, he ever maintained the most affectionate relations. His only brother survived to 1825. Young Clive was the despair of his teachers. Sent from school to school, and for only a short time at the Merchant Taylors' school, which had then a high reputation, he neglected his books for boyish adventures, often of the most dangerous kind. But he was not so ignorant as it is the fashion of his biographers to represent. He could translate Horace in after life, at the opening of the book; and he must have laid in his youth the foundation of that clear and vigorous English style which marked all his despatches, and made Lord Chatham declare of one of his speeches in the House of Commons that it was the most eloquent he had ever heard. From his earliest years, however, his ambition was to lead his fellows; but he never sacrificed honor, as the word was

then understood, even to the fear of death. At eighteen he was sent out to Madras as a "factor" or "writer" in the civil service of the East India Company. The detention of the ship at Brazil for nine months enabled him to acquire the Portuguese language, which, at a time when few or none of the Company's servants learned the vernaculars of India, he often found of use during his service there. For the first two years of his residence he was miserable. He felt keenly the separation from home; he was always breaking through the restraints imposed on young "writers;" and he was rarely out of trouble with his fellows, with one of whom he fought a duel. Thus early, too, the effect of the climate on his health began to show itself in those fits of depression during one of which he afterwards prematurely ended his life. The story is told of him by his companions, though he himself never spoke of it, that he twice snapped a pistol at his head in vain. His one solace was found in the Governor's library, where he sought to make up for past carelessness, not only by much reading, but by a course of study. He was just of age, when in 1746 Madras was forced to capitulate to Labourdonnais, during the war of the Austrian Succession. The breach of that capitulation by Dupleix, then at the head of the French settlements in India, led Clive, with others, to escape from the town to the subordinate Fort St. David, some twenty miles to the south. There, disgusted with the state of affairs and the purely commercial duties of an East Indian civilian, as they then were, Clive obtained an ensign's commission.

At this time India was ready to become the prize of the first conqueror who to the dash of the soldier added the skill of the administrator. For the forty years since the death of the Emperor Aurungzebe, the power of the Great Mogul had gradually fallen into the hands of his provincial viceroys or soubadars. The three greatest of these were the nabab of the Deccan, or South and Central India, who ruled from Hyderabad, the nabab of Bengal, whose capital was Moorshedabad, and the nabab or vizier of Oudh. The prize lay between Dupleix, who had the genius of an administrator, or rather intriguer, but was no soldier, and Clive, the first of a century's brilliant succession of those "soldier-politicals," as they are called in the East, to whom, ending with Sir Henry Lawrence, Great Britain owes the conquest and consolidation of its greatest dependency. Clive successively established British ascendancy against French influence in the three great provinces under these nababs. But his merit lies especially in the ability and foresight with which he secured for his country, and for the good of the natives, the richest of the three, Bengal. First, as to Madras and the Deccan, Clive had hardly been able to commend himself to Major Stringer Lawrence, the commander of the British troops, by his courage and skill in several small engagements, when the peace of Aix-la-Chapelle forced him to return to his civil duties in a short time. An attack of the malady which so severely affected his spirits led him to visit Bengal, where he was soon to distinguish himself. On his return he found a contest going on between two sets of rival claimants for the position of viceroy of the Deccan, and for that of nabab of the Carnatic, the greatest of the subordinate states under the Deccan. Dupleix, who took the part of the pretenders to power in both places, was carrying all before him. The British had been weakened by the withdrawal of a large force under Admiral Boscawen, and by the return home, on leave, of Major Lawrence. But that officer had appointed Clive commissary for the supply of the troops with provisions, with the rank of captain. More than one disaster had taken place on a small scale, when Clive drew up a plan for dividing the enemy's forces, and offered to carry it out himself. The pretender, Chunda Sahib, had been made nabab of the Carnatic with Dupleix's assistance, while the British had taken up the cause of the more legitimate successor, Mahomed Ali. Chunda Sahib had left Arcot, the capital of the Carnatic, to reduce Trichinopoly, then held by a weak English battalion. Clive offered to attack Arcot that he might force Chunda Sahib to raise the siege of Trichinopoly. But Madras and Fort St. David could supply him with only 200 Europeans and 300 sepoys. Of the eight officers who led them, four were civilians like Clive himself, and six had never been in action. His force had but three field-pieces. The circumstance that Clive, at the head of this handful, had been seen marching during a storm of thunder and lightning,

led the enemy to evacuate the fort, which the British at once began to strengthen against a siege. Clive treated the great population of the city with so much consideration that they helped him, not only to fortify his position, but to make successful sallies against the enemy. As the days passed on, Chunda Sahib sent a large army under his son and his French supporters, who entered Arcot and closely besieged Clive in the citadel. An attempt to relieve him from Madras was defeated. Meanwhile the news of the marvellous defence of the English reached the Mahratta allies of Mahomed Ali, who advanced to Clive's rescue. This led the enemy to redouble their exertions, but in vain. After for fifty days besieging the fort, and offering large sums to Clive to capitulate, they retired from Arcot. The brave garrison had been so reduced by the gradual failure of provisions that the sepoys offered to be content with the thin gruel which resulted from the boiling of the rice, leaving the grain to their European comrades. Of the 200 Europeans 45 had been killed, and of the 300 sepoys 30 had fallen, while few of the survivors had escaped wounds. In India, we might say in all history, there is no parallel to this exploit of 1751 till we come to the siege of Lucknow in 1857. Clive, now reinforced, followed up his advantage, and Major Lawrence returned in time to carry the war to a successful issue. In 1754 the first of our Carnatic treaties was made provisionally, between Mr. T. Saunders, the Company's resident at Madras, and M. Godeheu, the French commander, in which the English protégé, Mahomed Ali, was virtually recognized as nawab, and both nations agreed to equalize their possessions. When war again broke out in 1758, and the French, during Clive's absence in Bengal, obtained successes in the northern districts, his efforts helped to drive them from their settlements. The Treaty of Paris in 1763 formally confirmed Mahomed Ali in the position which Clive had won for him. Two years after, the Madras work of Clive was completed by a firman from the emperor of Delhi, recognizing the British possessions in Southern India.

The siege of Arcot at once gave Clive a European reputation. Pitt pronounced the youth of twenty-seven who had done such deeds a "heaven-born general," thus endorsing the generous appreciation of his early commander, Major Lawrence. When the Court of Directors voted him a sword worth £700, he refused to receive it unless Lawrence was similarly honored. He left Madras for home, after ten years' absence, early in 1753, but not before marrying Miss Margaret Maskelyne, the sister of a friend, and of one who was afterward well known as astronomer royal. All his correspondence proves him to have been a good husband and father, at a time when society was far from pure, and scandal made havoc of the highest reputations. In after days, when Clive's uprightness and stern reform of the Company's civil and military services made him many enemies, a biography of him appeared under the assumed name of *Charles Carracioli, Gent.* All the evidence is against the probability of its scandalous stories being true. Clive's early life seems occasionally to have led him to yield to one of the vices of his time, loose or free talk among intimate friends, but beyond this nothing has been proved to his detriment. After he had been two years at home the state of affairs in India made the directors anxious for his return. He was sent out, in 1756, as governor of Fort St. David, with the reversion of the government of Madras, and he received the commission of lieutenant-colonel in the king's army. He took Bombay on his way, and there commanded the land force which captured Gheriah, the stronghold of the Mahratta pirate, Angria. In the distribution of prize money which followed this expedition he showed no little self denial. He took his seat as governor of Fort St. David on the day on which the nawab of Bengal captured Calcutta. Thither the Madras Government at once sent him, along with Admiral Watson. He entered on the second period of his career.

Since, in August, 1690, Job Charnock had landed at the village of Chuttanutti with a guard of one officer and 30 men, the infant capital of Calcutta had become a rich centre of trade. The successive nawabs or viceroys of Bengal had been friendly to it, till, in 1756, Suraj-ud-Dowlah succeeded his uncle at Moorshedabad. His predecessor's financial minister had fled to Calcutta to escape the extortion of the new nawab, and the English governor refused to deliver up the refugee. Enraged at this, Suraj-ud-Dowlah captured the old fort of Calcutta on the 5th

August, and plundered it of more than two millions sterling. Many of the English fled to the ships and dropped down the river. The 146 who remained were forced into "the Black Hole" in the stifling heat of the sultriest period of the year. Only 23 came out alive. The fleet was as strong, for those days, as the land force was weak. Disembarking his troops some miles below the city, Clive marched through the jungles, where he lost his way owing to the treachery of his guides, but soon invested Fort William, while the fire of the ships reduced it, on the 2d January, 1757. On the 4th February he defeated the whole army of the nawab, which had taken up a strong position just beyond what is now the most northerly suburb of Calcutta. The nawab hastened to conclude a treaty, under which favorable terms were conceded to the Company's trade, the factories and plundered property were restored, and an English mint was established. In the accompanying agreement, offensive and defensive, Clive appears under the name by which he was always known to the natives of India, Sabut Jung, or the daring in war. The hero of Arcot had, at Angria's stronghold, and now again under the walls of Calcutta, established his reputation as the first captain of the time. With 600 British soldiers, 800 sepoys, 7 field-pieces and 500 sailors to draw them, he had routed a force of 34,000 men with 40 pieces of heavy cannon, 50 elephants, and a camp that extended upwards of four miles in length. His own account, in a letter to the archbishop of Canterbury, gives a modest but vivid description of the battle, the importance of which has been overshadowed by Plassy. In spite of his double defeat and the treaty which followed it, the madness of the nawab burst forth again. As England and France were once more at war, Clive sent the fleet up the river against Chandernagore, while he besieged it by land. After consenting to the siege, the nawab sought to assist the French, but in vain. The capture of their principal settlement in India, next to Pondicherry, which had fallen in the previous war, gave the combined forces prize to the value of £130,000. The rule of Suraj-ud-Dowlah became as intolerable to his own people as to the English. They formed a confederacy to depose him, at the head of which was Jaffier Ali Khan, his commander-in-chief. Associating with himself Admiral Watson, Governor Drake, and Mr. Watta, Clive made a treaty in which it was agreed to give the office of soubah, or viceroy of Bengal, Behar, and Orissa, to Jaffier, who was to pay a million sterling to the Company for its losses in Calcutta and the cost of its troops, half a million to the English inhabitants of Calcutta, £200,000 to the native inhabitants, and £70,000 to its Armenian merchants. Up to this point all is clear. Suraj-ud-Dowlah was hopeless as a ruler. His relations alike to his master, the merely titular emperor of Delhi, and to the people left the province open to the strongest. After "the Black Hole," the battle of Calcutta, and the treachery at Chandernagore in spite of the treaty which followed that battle, the East India Company could treat the nawab only as an enemy. Clive, it is true, might have disregarded all native intrigue, marched on Moorshedabad, and at once held the delta of the Ganges in the Company's name. But the time was not ripe for this, and the consequences, with so small a force, might have been fatal. The idea of acting directly as rulers, or save under native charters and names, was not developed by events for half a century. The political morality of the time in Europe, as well as the comparative weakness of the Company in India, led Clive not only to meet the dishonesty of his native associate by equal dishonesty, but to justify his conduct by the declaration, years after, in Parliament, that he would do the same again. It became necessary to employ the richest Bengalee trader, Omichund, as an agent between Jaffier Ali and the English officials. Master of the secret of the confederacy against Suraj-ud-Dowlah, the Bengalee threatened to betray it unless he was guaranteed, in the treaty itself, £300,000. To dupe the villain, who was really paid by both sides, a second, or fictitious treaty, was shown him with a clause to this effect. This Admiral Watson refused to sign; "but," Clive deposed to the House of Commons, "to the best of his remembrance, he gave the gentleman who carried it leave to sign his name upon it; his lordship never made any secret of it; he thinks it warrantable in such a case, and would do it again a hundred times; he had no interested motive in doing it, and did it with a design of disappointing the expectations of a rapacious

man." Such is Clive's own defence of the one act which, in a long career of abounding temptations, stains his public life.

The whole hot season of 1757 was spent in these negotiations, till the middle of June, when Clive began his march from Chandernagore, the British in boats, and the sepoy along the right bank of the Hooghly. That river, above Calcutta, is, during the rainy season, fed by the overflow of the Ganges to the north through three streams, which in the hot months are nearly dry. On the left bank of the Bhagarutti, the most westerly of these, 100 miles above Chandernagore, stands Moorshedabad, the capital of the Mogul viceroys of Bengal, and then so vast that Clive compared it to the London of his day. Some miles farther down is the field of Plassy, then an extensive grove of mango trees, of which enough yet remains, in spite of the changing course of the stream, to enable the visitor to realize the scene. On the 21st June Clive arrived on the bank opposite Plassy, in the midst of that outburst of rain which ushers in the south-west monsoon of India. His whole army amounted to 1100 Europeans and 2100 native troops, with 10 field-pieces. The nawab had drawn up 18,000 horse, 50,000 foot, and 53 pieces of heavy ordnance, served by French artillerymen. For once in his career Clive hesitated, and called a council of sixteen officers to decide, as he put it, "whether in our present situation, without assistance, and on our own bottom, it would be prudent to attack the nawab, or whether we should wait till joined by some country power?" Clive himself headed the nine who voted for delay; Major (afterwards Sir) Eyre Coote, led the seven who counselled immediate attack. But, either because his daring asserted itself, or because, also, of a letter that he received from Jaffier Ali, as has been said, Clive was the first to change his mind and to communicate with Major Eyre Coote. One tradition, followed by Macaulay, represents him as spending an hour in thought under the shade of some trees, while he resolved the issues of what was to prove one of the decisive battles of the world. Another, turned into verse by an Anglo-Indian poet, pictures his resolution as the result of a dream. However that may be, he did well as a soldier to trust to the dash and even rashness that had gained Arcot and triumphed at Calcutta, and as a statesman, since retreat, or even delay, would have put back the civilization of India for years. When, after the heavy rain, the sun rose brightly on the 22d, the 3200 men and the ten guns crossed the river and took possession of the grove and its tanks of water, while Clive established his headquarters in a hunting lodge. On the 23d the engagement took place and lasted the whole day. Except the 40 Frenchmen and the guns which they worked, the enemy did little to reply to the British cannonade which, with the 39th Regiment, scattered the host, inflicting on it a loss of 500 men. Clive restrained the ardor of Major Kirkpatrick, for he trusted to Jaffier Ali's abstinence, if not desertion to his ranks, and knew the importance of sparing his own small force. He lost hardly a white soldier; in all 22 sepoy were killed and 50 wounded. His own account, written a month after the battle to the secret committee of the court of directors, is not less unaffected than that in which he had announced the defeat of the nawab at Calcutta. Suraj-ud-Dowlah fled from the field on a camel, secured what wealth he could, and came to an untimely end. Clive entered Moorshedabad, and established Jaffier Ali in the position which his descendants have ever since enjoyed, as pensioners, but have not unfrequently abused. When taken through the treasury, amid a million and a half sterling's worth of rupees, gold and silver plate, jewels, and rich goods, and besought to ask what he would, Clive was content with £160,000, while half a million was distributed among the army and navy, both in addition to gifts of £24,000 to each member of the Company's committee, and besides the public compensation stipulated for in the treaty. It was to this occasion that he referred in his defence before the House of Commons, when he declared that he marvelled at his moderation. He sought rather to increase the shares of the fleet and the troops at his own expense, as he had done at Gheriah, and did more than once afterwards, with prize of war. What he did take from the grateful nawab for himself was less than the circumstances justified from an Oriental point of view, was far less than was pressed upon him, not only by Jaffier Ali, but by the hundreds of the native nobles whose

gifts Clive steadily refused, and was openly acknowledged from the first. He followed a usage fully recognised by the Company, although the fruitful source of future evils which he himself was again sent out to correct. The Company itself acquired a revenue of £100,000 a year, and a contribution towards its losses and military expenditure of a million and a half sterling. Such was Jaffier Ali's gratitude to Clive that he afterwards presented him with the quit-rent of the Company's lands in and around Calcutta, amounting to an annuity of £27,000 for life, and left him by will the sum of £70,000, which Clive devoted to the army.

While busy with the civil administration, the conqueror of Plassy continued to follow up his military success. He sent Major Coote in pursuit of the French almost as far as Benares. He despatched Colonel Forde to Visagapatam and the northern districts of Madras, where that officer gained the battle of Condore, pronounced by Broome "one of the most brilliant actions on military record." He came into direct contact, for the first time, with the Great Mogul himself, an event which resulted in the most important consequences during the third period of his career. Shah Aalum, when Shahzada, or heir-apparent, quarrelled with his father Aalum Geer II, the emperor, and united with the viceroys of Oudh and Allahabad for the conquest of Bengal. He advanced as far as Patna, which he besieged with 40,000 men. Jaffier Ali, in terror, sent his son to its relief, and implored the aid of Clive. Major Cailland defeated the prince's army at the battle of Sirpore, and dispersed it. Finally, at this period, Clive repelled the aggression of the Dutch, and avenged the massacre of Amboyna, on that occasion when he wrote his famous letter, "Dear Forde, fight them immediately; I will send you the order of council to-morrow." Meanwhile he never ceased to improve the organization and drill of the sepoy army, after a European model, and enlisted into it many Mahometans of fine physique from Upper India. He re-fortified Calcutta. In 1760, after four years of labor so incessant and results so glorious, his health gave way and he returned to England. "It appeared," wrote a contemporary on the spot, "as if the soul was departing from the government of Bengal." He had been formally made governor of Bengal by the court of directors at a time when his nominal superiors in Madras sought to recall him to their help there. But he had discerned the importance of the province even during his first visit to its rich delta, mighty rivers, and teeming population. It should be noticed, also, that he had the kingly gift of selecting the ablest subordinates, for even thus early he had discovered the ability of young Warren Hastings, destined to be his great successor, and, a year after Plassy, made him "resident" at the nawab's court.

In 1760, at thirty-five years of age, Clive returned to England with a fortune of at least £300,000 and the quit-rent of £27,000 a year, after caring for the comfort of his parents and sisters, and giving Major Lawrence, his old commanding officer, who had early encouraged his military genius, £500 a year. The money had been honorably and publicly acquired, with the approval of the Company. The amount might have been four times what it was, had Clive been either greedy after wealth or ungenerous to the colleagues and the troops whom he led to victory. In the five years of his conquests and administration in Bengal the young man had crowded together a succession of exploits which led Lord Macaulay, in what that historian termed his "flashy" essay on the subject, to compare him to Napoleon Bonaparte. But there was this difference in Clive's favor, due not more to the circumstances of the time than to the object of his policy—he gave peace, security, prosperity, and such liberty as the case allowed of to a people now reckoned at 240 millions, who had for centuries been the prey of oppression, while Napoleon warred only for personal ambition, and the absolutism he established has left not a wreck behind. During the three years that Clive remained in England he sought a political position, chiefly that he might influence the course of events in India, which he had left full of promise. He had been well received at court, had been made Baron Clive of Plassy, in the peerage of Ireland, had bought estates, and had got not only himself but his friends returned to the House of Commons after the fashion of the time. Then it was that he set himself to reform the home system of the East India Company, and commenced a

bitter warfare with Mr. Sullivan, chairman of the court of directors, whom finally he defeated. In this he was aided by the news of reverses in Bengal. Vansittart, his successor, having no great influence over Jaffier Ali Khan, had put Kossim Ali Khan, the son-in-law, in his place in consideration of certain payments to the English officials. After a brief tenure Kossim Ali had fled, had ordered Summers, or Sumroo, a Swiss mercenary of his, to butcher the garrison of 150 English at Patna, and had disappeared under the protection of his brother viceroy of Oudh. The whole Company's service, civil and military, had become demoralized by such gifts, and by the monopoly of the inland as well as export trade, to such an extent that the natives were pauperized, and the Company was plundered of the revenues which Clive had acquired for them. The court of proprietors, accordingly, who elected the directors, forced them, in spite of Sullivan, to hurry out Lord Clive to Bengal with the double powers of governor and commander-in-chief.

What he had done for Madras, what he had accomplished for Bengal proper, and what he had effected in reforming the Company itself, he was now to complete in less than two years, in this the third period of his career, by putting his country politically in the place of the emperor of Delhi, and preventing for ever the possibility of the corruption to which the English in India had been driven by an evil system. On the 3d May, 1765, he landed at Calcutta to learn that Jaffier Ali Khan had died, leaving him personally £70,000, and had been succeeded by his son, though not before the Government had been further demoralized by taking £100,000, as a gift from the new nawab; while Kossim Ali had induced not only the viceroy of Oudh, but the emperor of Delhi himself, to invade Behar. After the first mutiny in the Bengal army, which was suppressed by blowing the sepoy ringleader from the guns, Major Munro, "the Napier of those times," scattered the united armies on the hard-fought field of Buxar. The emperor, Shah Aalum, detached himself from the league, while the Oudh viceroy threw himself on the mercy of the English. Clive had now an opportunity of repeating in Hindustan, or Upper India, what he had accomplished for the good of Bengal. He might have secured what are now called the North-Western Provinces and Oudh, and have rendered unnecessary the campaigns of Wellesley and Lake. But he had other work in the consolidation of rich Bengal itself, making it a base from which the mighty fabric of British India could afterwards steadily and proportionally grow. Hence he returned to the Oudh viceroy all his territory save the provinces of Allahabad and Corah, which he made over to the weak emperor. But from that emperor he secured the most important document in the whole of our Indian history up to that time, which appears in the records as "firman from the King Shah Aalum, granting the dewany of Bengal, Behar, and Orissa to the Company, 1765." The date was the 12th August, the place Benares, the throne an English dining-table covered with embroidered cloth and surmounted by a chair in Clive's tent. It is all pictured by a Mahometan contemporary, who indignantly exclaims that so great a "transaction was done and finished in less time than would have been taken up in the sale of a jackass." By this deed the Company became the real sovereign rulers of thirty millions of people, yielding a revenue of four millions sterling. All this had been accomplished by Clive in the few brief years since he had avenged "the Black Hole" of Calcutta. This would be a small matter, or might even be a cause of reproach, were it not that the Company's, now the Queen's, undisputed sovereignty proved, after a sore period of transition, the salvation of these millions. The lieutenant-governorship of Bengal, with some additions since Clive's time, now contains sixty millions of people, and yields an annual revenue of twelve millions sterling, of which eight goes every year to assist in the good government of the rest of India. But Clive, though thus moderate and even generous to an extent which called forth the astonishment of the natives, had all a statesman's foresight. On the same date, he obtained not only an imperial charter for the Company's possessions in the Carnatic also, thus completing the work he began at Arcot, but a third firman for the highest of all the lieutenantcies or soubaships of the empire, that of the Deccan itself. The fact has only recently been discovered, by distinct allusion to it in a letter from the secret committee of the court of directors to the

Madras Government, dated 27th April, 1768. Still so disproportionate seemed the British force, not only to the number and strength of the princes and people of India, but to the claims and ambition of French, Dutch, and Danish rivals, that Clive's last advice to the directors, as he finally left India in 1777, was this, given in a remarkable state paper but little known: "We are sensible that, since the acquisition of the dewany, the power formerly belonging to the soubah of those provinces is totally, in fact, vested in the East India Company. Nothing remains to him but the name and shadow of authority. This name, however, this shadow, it is indispensably necessary we should seem to venerate." On a wider arena, even that of the Great Mogul himself, the shadow was kept up till it obliterated itself in the massacre of English people in the Delhi palace in 1857; and the Queen was proclaimed, first, direct ruler on the 1st November, 1858, and then empress of India on the 1st January, 1877.

Having thus founded the empire of British India, Clive's painful duty was to create a pure and strong administration, such as alone would justify its possession by foreigners. The civil service was de-orientalized by raising the miserable salaries which had tempted its members to be corrupt, by forbidding the acceptance of gifts from natives, and by exacting covenants under which participation in the inland trade was stopped. Not less important were his military reforms. With his usual tact and nerve he put down a mutiny of the English officers, who chose to resent the veto against receiving presents and the reduction of batta at a time when two Mahratta armies were marching on Bengal. His reorganization of the army, on the lines of that which he had begun after Plassey, and which was neglected during his second visit to England, has since attracted the admiration of the ablest Indian officers. He divided the whole into three brigades, so as to make each a complete force, in itself equal to any single native army that could be brought against it. His one fault was that of his age and his position, with so small a number of men. He lacked a sufficient number of British artillerymen, and would not commit the mistake of his successors, who trained natives to work the guns, which were turned against us with such effect in 1857. It is sufficient to say that Government has returned to his policy, for not a native gunner is now to be found save in a few unhealthy and isolated frontier posts.

Clive's final return to England, a poorer man than he went out, in spite of still more tremendous temptations, was the signal for an outburst of his personal enemies, exceeded only by that which the malice of Sir Philip Francis afterwards excited against Warren Hastings. Every civilian whose illicit gains he had cut off, every officer whose conspiracy he had foiled, every proprietor or director, like Sullivan, whose selfish schemes he had thwarted, now sought their opportunity. He had, with consistent generosity, at once made over the legacy of £70,000 from the grateful Jaffier Ali, as the capital of what has since been known as "the Clive Fund," for the support of invalidated European soldiers, as well as officers, and their widows, and the Company had allowed 8 per cent. on the sum for an object which it was otherwise bound to meet. Burgoyne, of Saratoga memory, did his best to induce the House of Commons, in which Lord Clive was now member for Shrewsbury, to impeach the man who gave his country an empire, and the people of that empire peace and justice, and that, as we have seen, without blot on the gift, save in the matter of Omichund. The result, after the brilliant and honorable defences of his career which will be found in Almon's *Debates* for 1773, was a compromise that saved England this time from the dishonor which, when Warren Hastings had to run the gauntlet, put it in the same category with France in the treatment of its public benefactors abroad. On a division the House, by 155 to 95, carried the motion that Lord Clive "did obtain and possess himself" of £234,000 during his first administration of Bengal; but, refusing to express an opinion on the fact, it passed unanimously the second motion, at five in the morning, "that Robert, Lord Clive, did at the same time render great and meritorious services to his country." The one moral question, the one stain of all that brilliant and tempted life—the Omichund treaty—was not touched.

Only one who can personally understand what Clive's power and services were will rightly realize the effect on



him, though in the prime of life, of the discussions through which he had been dragged. We have referred to Warren Hastings's impeachment, but there is a more recent parallel. The marquis of Dalhousie did almost as much to complete the territorial area and civilized administration of British India in his eight years' term of office as Lord Clive to found the empire in a similar period. As Clive's accusers sought a new weapon in the great famine of 1770, for which he was in no sense responsible, so there were critics who accused Dalhousie of having caused that mutiny which, in truth, he would have prevented had the British Government listened to his counsel not to reduce the small English army in the country. Clive tells us his own feelings in a passage of first importance when we seek to form an opinion on the fatal act by which he ended his life. In the greatest of his speeches, in reply to Lord North, he said,—“My situation, sir, has not been an easy one for these twelve months past, and though my conscience could never accuse me, yet I felt for my friends who were involved in the same censure as myself. . . . I have been examined by the select committee more like a sheep-stealer than a member of this House.” Fully accepting that statement, and believing him to have been purer than his accusers in spite of temptations unknown to them, we see in Clive's end the result merely of physical suffering, of chronic disease which opium failed to abate, while the worry and chagrin caused by his enemies gave it full scope. This great man, who fell short only of the highest form of moral greatness on one supreme occasion, but who did more for his country than any soldier till Wellington, and more for the people and princes of India than any statesman in history, ceased to exist on the 22d November, 1774, in his fiftieth year.

The portrait of Clive, by Dance, in the Council Chamber of Government House, Calcutta, faithfully represents him. He was slightly above middle-size, with a countenance rendered heavy and almost sad by a natural fullness above the eyes. Reserved to the many, he was beloved by his own family and friends. His encouragement of scientific undertakings like Major Rennell's surveys, and of philological researches like Mr. Gladwin's, was marked by the two honorary distinctions of F.R.S. and LL.D.

The best authorities for his life, which has yet to be worthily written, are—article “Clive,” in the second or Kippis's edition of the *Biographia Britannica*, from materials supplied by his brother, Archdeacon Clive, by Henry Beaufoy, M.P.; Broome's *History of the Bengal Army*; Aitchison's *Treaties*, second edition, 1876; Orme's *History*; and Malcolm's *Life*. (G. SM.)

**CLOCKS.** The origin of clock work is involved in great obscurity. Notwithstanding the statements by many writers that clocks, *horologia*, were in use so early as the 9th century, and that they were then invented by an archdeacon of Verona, named Pacificus, there appears to be no clear evidence that they were machines at all resembling those which have been in use for the last five or six centuries. But it may be inferred from various allusions to *horologia*, and to their striking spontaneously, in the 12th century, that genuine clocks existed then, though there is no surviving description of any one until the 13th century, when it appears that a horologium was sent by the sultan of Egypt in 1232 to the Emperor Frederick II. “It resembled a celestial globe, in which the sun, moon, and planets moved, being impelled by weights and wheels, so that they pointed out the hour, day, and night with certainty.” A clock was put up in a former clock tower at Westminster with some great bells in 1288, out of a fine imposed on a corrupt chief-justice, and the motto *Discite justitiam, moniti*, inscribed upon it. The bells were sold or rather, it is said, gambled away, by Henry VIII. In 1292 one is mentioned in Canterbury Cathedral as costing £30. And another at St. Albans, by R. Wallingford the abbot in 1326, is said to have been such as there was not in all Europe, showing various astronomical phenomena. A description of one in Dover Castle with the date 1348 on it was published by the late Admiral Smyth, P.R.A.S., in 1851, and the clock itself was exhibited going, in the Scientific Exhibition of 1876. In the early editions of this *Encyclopedia* there was a picture of a very similar one, made by De Vick for the French king Charles V. about the same time, much like our common clocks of the last century, except that it had a vibrating balance, but no spring, instead of a pendulum, for pendulums were not invented till three centuries after that.

The general construction of the going part of all clocks, except large or turret clocks, which we shall treat separately, is substantially the same, and fig. 1 is a section of any ordinary house clock. B is the barrel with the rope coiled round it, generally 16 times for the 8 days; the barrel is fixed to its arbor K, which is prolonged into the winding square coming up to the face or dial of the clock; the dial is here shown as fixed either by small screws *x*, or by a socket and pin *s*, to the prolonged pillars *p*, *p*, which (4 or 5 in number) connect the plates or frame of the clock together, though the dial is commonly, but for no good reason, set on to the front plate by another set of pillars of its own. The great wheel G rides on the arbor, and is connected with the barrel by the ratchet R, the action of which is shown more fully in fig. 14. The intermediate wheel *r* in this drawing is for a purpose which will be described hereafter, and for the present it may be considered as omitted, and the click of the ratchet R as fixed to the great wheel. The great wheel drives the pinion *c* which

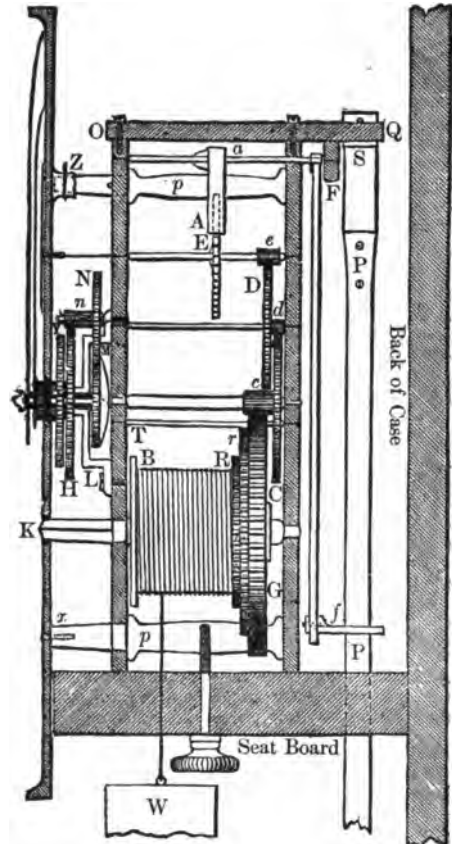

FIG. 1.—Section of House Clock.

is called the centre pinion, on the arbor of the *centre wheel*, C, which goes through to the dial, and carries the long, or minute-hand; this wheel always turns in an hour, and the great wheel generally in 12 hours, by having 12 times as many teeth as the centre pinion. The centre wheel drives the “second wheel” D by its pinion *d*, and that again drives the scape-wheel E by its pinion *e*. If the pinions *d* and *e* have each 8 teeth or *leaves* (as the teeth of pinions are usually called), C will have 64 teeth and D 60, in a clock of which the scape-wheel turns in a minute, so that the seconds hand may be set on its arbor prolonged to the dial. A represents the pallets of the escapement, which will be described presently, and their arbor *a* goes through a large hole in the back plate near F, and its back pivot turns in a cock OFQ screwed on to the back plate. From the pallet arbor at F descends the *crutch* Ff, ending in the *fork* f, which embraces the pendulum P, so that as the pendulum vibrates, the crutch and the pallets necessarily vibrate with it. The pendulum is hung by a thin spring S from the cock Q, so that the bending point of the spring may be just opposite the end of the pallet arbor, and the

edge of the spring as close to the end of that arbor as possible—a point too frequently neglected.

We may now go to the front (or left hand) of the clock, and describe the dial or "motion-work." The minute-hand fits on to a squared end of a brass socket, which is fixed to the wheel M, and fits close, but not tight, on the prolonged arbor of the centre wheel. Behind this wheel is a bent spring which is (or ought to be) set on the same arbor with a square hole (not a round one as it sometimes is) in the middle, so that it must turn with the arbor; the wheel is pressed up against this spring, and kept there by a cap and a small pin through the end of the arbor. The consequence is, that there is friction enough between the spring and the wheel to carry the hand round, but not enough to resist a moderate push with the finger for the purpose of altering the time indicated. This wheel M, which is sometimes called the minute-wheel, but is better called the *hour-wheel* as it turns in an hour, drives another wheel N, of the same number of teeth, which has a pinion attached to it; and that pinion drives the *twelve-hour wheel* H, which is also attached to a large socket or pipe carrying the hour hand, and riding on the former socket, or rather (in order to relieve the centre arbor of that extra weight) on an intermediate socket fixed to the *bridge* L, which is screwed to the front plate over the hour-wheel M. The weight W, which drives the train and gives the impulse to the pendulum through the escapement, is generally hung by a catgut line passing through a pulley attached to the weight, the other end of the cord being tied to some convenient place in the clock frame or *seat-board*, to which it is fixed by screws through the lower pillars. It has usually been the practice to make the case of house clocks and astronomical clocks not less than 6 feet high; but that is a very unnecessary waste of space and materials; for by either diminishing the size of the barrel, or the number of its turns, by increasing the size of the great wheel by one-half, or hanging the weights by a treble instead of a double line, a case just long enough for the pendulum will also be long enough for the fall of the weights in  $7\frac{1}{2}$  or 8 days. Of course the weights have to be increased in the same ratio, and indeed rather more, to overcome the increased friction; but that is of no consequence.

#### PENDULUM.

The claim to the invention of the pendulum, like the claim to most inventions, is disputed; and we have no intention of trying to settle it. It was, like many other discoveries and inventions, probably made by various persons independently, and almost simultaneously, when the state of science had become ripe for it. The discovery of that peculiarly valuable property of the pendulum called *isochronism*, or the disposition to vibrate different arcs in very nearly the same time (provided the arcs are none of them large), is commonly attributed to Galileo, in the well-known story of his being struck with the isochronism of a chandelier hung by a long chain from the roof of the church at Florence. And Galileo's son appears as a rival of Avicenna, Huyghens, Dr. Hooke, and a London clockmaker named Harris, for the honor of having first applied the pendulum to regulate the motion of a clock train, all in the early part of the 17th century. Be this as it may, there seems little doubt that Huyghens was the first who mathematically investigated, and therefore really knew, the true nature of those properties of the pendulum which may now be found explained in any mathematical book on mechanics. He discovered that if a *simple* pendulum (*i.e.*, a weight or bob consisting of a single point, and hung by a rod or string of no weight) can be made to describe, not a circle, but a cycloid of which the string would be the radius of curvature at the lowest point, all its vibrations, however large, will be performed in the same time. For a little distance near the bottom, the circle very nearly coincides with the cycloid; and hence it is that, for small arcs, a pendulum vibrating as usual in a circle is nearly enough isochronous for the purposes of horology; more especially when contrivances are introduced either to compensate for the variations of the arc, or, better still, to destroy them altogether, by making the force on the pendulum so constant that its arcs may never sensibly vary.

The difference between the time of any *small* arc of the circle and any arc of the cycloid varies nearly as the square of the circular arc; and again, the difference between the times of any two small and nearly equal circular arcs of the same pendulum, varies nearly as the arc itself. If  $a$ , the arc, is increased by a small amount  $da$ , the pendulum will lose 10800  $da$  seconds a day, which is rather more than 1 second, if  $a$  is  $2^\circ$  (from zero) and  $da$  is  $10'$ ; since the numerical value of  $2^\circ$  is  $\cdot 035$ . If the increase of arc is considerable, it will not do to reckon thus by differentials, but we must take the difference of

time for the day as  $5400 (\alpha^2 - \alpha'^2)$ , which will be just 8 seconds if  $\alpha = 2^\circ$  and  $\alpha' = 3^\circ$ . For many years it was thought of great importance to obtain cycloidal vibrations of clock pendulums, and it was done by making the suspension string or spring vibrate between *cycloidal cheeks*, as they were called. But it was in time discovered that all this is a delusion,—first, because there is and can be no such thing in reality as a simple pendulum, and cycloidal cheeks will only make a simple pendulum vibrate isochronously; secondly, because a very slight error in the form of the cheeks (as Huyghens himself discovered) would do more harm than the *circular error* uncorrected, even for an arc of  $10^\circ$ , which is much larger than the common pendulum arc; thirdly, because there was always some friction or adhesion between the cheeks and the string; and fourthly (a reason which applies equally to all the isochronous contrivances since invented), because a common clock escapement itself generally tends to produce an error exactly opposite to the circular error, or to make the pendulum vibrate quicker the farther it swings; and therefore the circular error is actually useful for the purpose of helping to counteract the error due to the escapement, and the clock goes better than it would with a simple pendulum, describing the most perfect cycloid. At the same time, the thin spring by which pendulums are always suspended, except in some French clocks where a silk string is used (a very inferior plan), causes the pendulum to deviate a little from circular and to approximate to cycloidal motion, because the bend does not take place at one point, but is spread over some length of the spring.

The accurate performance of a clock depends so essentially on the pendulum, that we shall go somewhat into detail respecting it. First then, the time of vibration depends entirely on the length of the pendulum, the effect of the spring being too small for consideration until we come to differences of a higher order. But the time does not vary as the length, but only as the square root of the length; *i.e.*, a pendulum to vibrate two seconds must be four times as long as a seconds pendulum. The relation between the time of vibration and the length of a pendulum is expressed thus:—

$$t = \pi \sqrt{\frac{l}{g}}$$

where  $t$  is the time in seconds,  $\pi$  the well-known

symbol for 3.14159, the ratio of the circumference of a circle to its diameter,  $l$  the length of the pendulum, and  $g$  the force of gravity at the latitude where it is intended to vibrate. This letter  $g$ , in the latitude of London, is the symbol for 32.2 feet, that being the velocity (or number of feet per second) at which a body is found by experiment to be moving at the end of the first second of its fall, being necessarily equal to twice the actual number of feet it has fallen in that second. Consequently, the length of a pendulum to beat seconds in London is 39.14 inches. But the same pendulum carried to the equator where the force of gravity is less, would lose  $2\frac{1}{2}$  minutes a day.

The seconds we are here speaking of are the seconds of a common clock indicating *mean solar time*. But as clocks are also required for sidereal time, it may be as well to mention the proportions between a mean and a sidereal pendulum. A sidereal day is the interval between two successive transits over the meridian of a place by that imaginary point in the heavens called  $\gamma$ , the first point of Aries, at the intersection of the equator and the ecliptic; and there is one more sidereal day than there are solar days in a year, since the earth has to turn more than once round in space before the sun can come a second time to the meridian, on account of the earth's own motion in its orbit during the day. A sidereal day or hour is shorter than a mean solar one in the ratio of .99727, and consequently a sidereal pendulum must be shorter than a mean time pendulum in the square of that ratio, or in the latitude of London the sidereal seconds pendulum is 38.87 inches. As we have mentioned what is 0 or 24 o'clock by sidereal time, we may as well add, that the mean day is also reckoned in astronomy by 24 hours, and not from midnight as in civil reckoning, but from the following noon; thus, what we call 11 A.M. May 1 in common life is 23 h. April 30 with astronomers.

It must be remembered that the pendulums whose lengths we have been speaking of are simple pendulums; and as that is a thing which can only exist in theory, the reader may ask how the length of a real pendulum to vibrate in any required time is ascertained. In every pendulum, that is to say, in every body hung so as to be capable of vibrating freely, there is a certain point, always somewhere below the centre of gravity, which possesses these remarkable properties—that if the pendulum were turned upside down, and set vibrating about this point, it would vibrate in the same time as before, and moreover, that the distance of this point from the point of suspension is exactly the length of that imaginary simple pendulum which would vibrate in the same time. This point is therefore called the *centre of oscillation*. The rules for finding it by calculation are too complicated for ordinary use, except in bodies of certain simple and regular forms; but they are fortunately not requisite in practice, because in all clock pendulums the centre of oscillation is only a short distance below the centre of gravity of the whole pendulum, and generally so near to

the centre of gravity of the bob—in fact a little above it—that there is no difficulty in making a pendulum for any given time of vibration near enough to the proper length at once, and then adjusting it by screwing the bob up or down until it is found to vibrate in the proper time.

#### Revolving or Conical Pendulum.

Thus far we have been speaking of vibrating pendulums; but the notice of pendulums would be incomplete without some allusion to revolving or conical pendulums, as they are called, because they describe a cone in revolving. Such pendulums are used where a continuous instead of an intermittent motion of the clock train is required, as in the clocks for keeping an equatorial telescope directed to a star, by driving it the opposite way to the motion of the earth, to whose axis the axis on which the telescope turns is made parallel. Clocks with such pendulums may also be used in bedrooms by persons who cannot bear the ticking of a common clock. The pendulum, instead of being hung by a flat spring, is hung by a thin piece of piano-forte wire; and it should be understood that it has no tendency to twist on its own axis, and so to twist off the wire, as may be apprehended; in fact, it would require some extra force to make it twist, if it were wanted to do so. The time of revolution of such a pendulum may be easily ascertained as follows:—Let  $l$  be its length;  $\alpha$  the angle which it makes with the vertical axis of the cone which it describes;  $\omega$  the angular velocity; then the centrifugal force  $=\omega^2 l \sin. \alpha$ ; and as this is the force which keeps the pendulum away from the vertical, it must balance the force which draws it to the vertical, which is  $g \tan.$

$\alpha$ : and therefore  $\sqrt{\frac{g}{l \cos. \alpha}}$  = the angular velocity, or the angle described in a second of time; and the time of complete revolution through the angle  $360^\circ$  or  $2\pi$  is  $\frac{2\pi}{\omega} = 2\pi \sqrt{\frac{l \cos. \alpha}{g}}$ ; that is to say, the time of revolution of a pendulum of any given length is less than the time of a double oscillation of the same pendulum, in the proportion of the cosine of the angle which it makes with the axis of revolution to unity.

A rotary pendulum is kept in motion by the train of the clock ending in a horizontal wheel with a vertical axis, from which projects an arm pressing against a spike at the bottom of the pendulum; and it has this disadvantage that any inequality in the force of the train, arising from variations of friction or any other cause, is immediately transmitted to the pendulum; whereas it will be seen that in several kinds of escapements which can be applied to a vibrating pendulum, the variations of force can be rendered nearly or quite insensible. And it is a mistake to imagine that there is any self-correcting power in a conical pendulum analogous to that of the governor of a steam-engine; for that apparatus, though it is a couple of conical pendulums, has also a communication by a system of levers with the valve which supplies the steam. The governor apparatus has itself been applied to telescope-driving clocks, with a lever ending in a spring which acts by friction on some revolving plate in the clock, increasing the friction, and so diminishing the force as the balls of the governor fly out farther under any increase in the force. And with the addition of some connection with the hand of the observer, by which the action can be farther moderated, the motion can be made sufficiently uniform for that purpose.

Various other contrivances have been invented for producing a continuous clock-motion. The great equatorial telescope at Greenwich is kept in motion by a kind of water clock called in books on hydrostatics Barker's Mill, in which two horizontal pipes branching out from a vertical tubular axis have each a hole near their ends on opposite sides, from which water flows, being poured constantly into the tubular axis, which revolves on a pivot. The resistance of the air to the water issuing from the holes drives the mill round, and there are means of regulating it. Another plan is to connect a clock train having a vibrating pendulum with another clock having a conical pendulum by one of the lower wheels in the train, with a spring connection; the telescope is driven by the revolving clock train, and the other pendulum keeps it sufficiently in order, though allowing it to exeatiate enough for each beat of the pendulum. The more complicated plan of Wagner of Paris described in Sir E. Beckett's *Elementary Treatise on Clocks and Watches and Bells* does not appear to have ever come into use, and therefore it is now omitted.

#### Pendulum Suspension.

The suspension of the pendulum on what are called *knife-edges*, like those of a scale-beam, has often been advocated. But though it may do well enough for short experiments, in which the effects of the elasticity of the spring are wanted to be eliminated, it fails altogether in use, even if the knife-edges and the plates which carry them are made of the hardest stones. The suspension which is now used universally, in all but some inferior foreign clocks, which have strings instead, is a thin and

short spring with one end let into the top of the pendulum, and the other screwed between two *chops* of metal with a pin through them, which rests firmly in a nick in the cock which carries the pendulum as shown in fig. 2 a little farther on; and the steadiness of this cock, and its firm fixing to a wall, are essential to the accurate performance of the clock. The thinner the spring the better; provided, of course, it is strong enough to carry the pendulum without being bent beyond its elasticity, or bent short; not that there is much risk of that in practice. Pendulum springs are much oftener too thick than too thin; and it is worth notice that, independently of their greater effect on the natural time of vibration of the pendulum, thick and narrow springs are more liable to break than thin and broad ones of the same strength. It is of great importance that the spring should be of uniform thickness throughout its breadth; and the bottom of the chops which carry it should be exactly horizontal; otherwise the pendulum will swing with a twist, as they may be often seen to do in ill-made clocks. If the bottom of the chops is left sharp, where they slip the spring, it is very likely to break there; and therefore the sharp edges should be taken off.

The bob of the pendulum used to be generally made in the shape of a lens, with a view to its passing through the air with the least resistance. But after the importance of making the bob heavy was discovered, it became almost necessary to adopt a form of more solid content in proportion to its surface. A sphere has been occasionally used, but it is not a good shape, because a slight error in the place of the hole for the rod may make a serious difference in the amount of weight on each side, and give the pendulum a tendency to twist in motion. The mercurial jar pendulum suggested the cylindrical form, which is now generally adopted for astronomical clocks, and in the best turret clocks, with a round top to prevent any bits of mortar or dirt falling and resting upon it, which would alter the time; it also looks better than a flat-topped cylinder. There is no rule to be given for the weight of pendulums. It will be shown hereafter that, whatever escapement may be used, the errors due to any variation of force are expressed in fractions which invariably have the weight and the length of the pendulum in the denominator, though some kind of escapements require a heavy pendulum to correct their errors much less than others. And as a heavy pendulum requires very little more force to keep it in motion than a light one, being less affected by the resistance of the air, we may almost say that the heavier and longer a pendulum can be made the better; at any rate, the only limit is one of convenience; for instance, it would obviously be inconvenient to put a large pendulum of 100 lb weight in the case of an astronomical or common house clock. It may perhaps be laid down as a rule, that no astronomical clock or *regulator* (as they are also called) will go as well as is now expected of such clocks with a pendulum of less than 28 lb weight, and no turret clock with less than 1 cwt. Long pendulums are generally made with heavier bobs than short ones; and such a clock as that of the Houses of Parliament, with a two-seconds pendulum of 6 cwt., ought to go 44 times as well as a small turret clock with a one-second pendulum of 60 lb. Pendulums longer than 14 feet (3 seconds) are inconvenient, liable to be disturbed by wind, and expensive to compensate, and they are now quite disused, and most or all of the old ones removed, with their clocks, for better ones.

#### Pendulum Regulation.

The regulation of pendulums, or their exact adjustment to the proper length, is primarily effected by a nut on the end of the rod, by which the bob can be screwed up or down. In the best clocks the rim of this nut is divided, with an index over it; so the exact quantity of rise or fall, or the exact acceleration or retardation, may be known, the amount due to one turn of the nut being previously ascertained. By the calculation used below for compensation of pendulums, it may be seen that if the length of the pendulum rod is  $l$ , and the breadth of one thread of the screw is called  $d$ , then one turn of the nut will alter the rate of the clock by  $48200 \frac{d}{l}$  seconds a day; which would be

just 30 seconds, if the pendulum rod is 45 inches long, and the screw has 32 threads in the inch. To accelerate the clock the nut has always to be turned to the right, as it is called, and *vice versa*. But in astronomical and in large turret clocks, it is desirable to avoid stopping, or in any way disturbing the pendulum; and for the finer adjustments other methods of regulation are adopted. The best is that fixing a collar, as shown in fig. 2, capable of having very small weights laid upon it, half-way down the pendulum, this being the place where the addition of any small weight produces the greatest effect, and where, if may be added, any moving of that weight up or down on the rod produces the least effect. If  $M$  is the weight of the pendulum and  $l$  its length (down to the centre of oscillation), and  $m$  a small weight added at the distance  $d$  below the centre of suspension or above the c.o. (since they are reciprocal),  $t$  the time of vibration, and  $-d$  the acceleration due to adding  $m$ ; then

$$\frac{-d}{t} = \frac{m}{2M} \left( \frac{d}{l} - \frac{d^2}{l^2} \right); \text{ Google}$$

from which it is evident, that if  $d = \frac{1}{2}$ , then  $-d T$  the daily acceleration =  $\frac{10800 m}{M}$ ; or if  $m$  is the 10800th of the weight of the pendulum it will accelerate the clock a second day, or 10 grains will do that on a pendulum of 15 lb. weight (7000 gr. being = 1 lb.), or an ounce on a pendulum of 6 cwt. In like manner if  $d = \frac{1}{3}$  from either top or bottom,  $m$  must =  $\frac{M}{7200}$  to accelerate the clock a second a day. The higher up the collar is the less risk there is of disturbing the pendulum in putting on or taking off the regulating weights. The weights should be made in a series, and marked  $\frac{1}{2}$ ,  $\frac{1}{3}$ , 1, 2, according to the number of seconds a day by which they will accelerate; and the pendulum adjusted at first to lose a little, perhaps a second a day, when there are no weights on the collar, so that it may always have some weight on, which can be diminished or increased from time to time with certainty, as the rate may vary.

**Compensation of Pendulums.**

Soon after pendulums began to be generally used in clocks, it was discovered that they contained within themselves a source of error independent of the action of the clock upon them, and that they lost time in the hot weather and gained in cold, in consequence of all the substances of which they could be made expanding as the temperature increases. If  $l$  is the length of a pendulum, and  $dl$  the small increase of it from increased heat,  $t$  time of the pendulum  $l$ , and  $t + dt$  that of the pendulum  $l + dl$ ; then

$$\frac{t + dt}{t} = \frac{\sqrt{l + dl}}{\sqrt{l}} = 1 + \frac{dl}{2l}$$

since  $\left(\frac{dl}{l}\right)^2$  may be neglected as very small; or  $dt = \frac{tdl}{2l}$ ; and

the daily loss of the clock will be  $43200 \frac{dl}{l}$  seconds. The following is a table of the values of  $\frac{dl}{l}$  for 1000° Fahr. of heat in different substances, and also the weight of a cubic inch of each:

	lb
White deal.....	.0024
Flint glass.....	.0048
Steel rod.....	.0064
Iron rod.....	.007
Brass.....	.010
Lead.....	.016
Zinc.....	.017
Mercury (in bulk, not in length).....	.100

Thus a common pendulum with an iron wire rod would lose  $43200 \times .00007 = 3$  seconds a day for 10° of heat; and if adjusted for the winter temperature it would lose about a minute a week in summer, unless something in the clock happened to produce a counteracting effect, as we shall see may be the case when we come to escapements. We want therefore some contrivance which will always keep that point of the pendulum on which its time depends, viz., the centre of oscillation, at the same distance from the point of suspension. A vast number of such contrivances have been made, but there are only three which can be said to be at all in common use: and the old *gridiron pendulum*, made of 9 alternate bars of brass and steel is not one of them, having been superseded by one of zinc and iron, exactly on the same principle, but requiring much fewer bars on account of the greater expansion of zinc than brass. The centre of oscillation so nearly coincides in most clock pendulums with the centre of the bob that we may practically say that the object of compensation is to keep the bob always at the same height. For this purpose we must hang the bob from the top of a column of some metal which has so much more expansion than the rod that its expansion upwards will neutralise that of the rod, and of the wires or tube by which the bob is hung, downwards. The complete calculation, taking into account the weight of all rods and tubes, is too long and complicated to be worth going through, especially as it must always be finally adjusted by trial either of that very pendulum or of one exactly similar. For practical purposes it is found sufficient to treat the expansion of zinc as being .016 to steel .0064, instead of .017 as it is really; and for large pendulums with very heavy tubes even the .016 is a little too much. Moreover the c.o. is higher above the c.g. of the bob in such large pendulums than in small ones with light rods and tubes.

But neglecting these minutiae for the first approximation, and supposing the bob either to be of iron, in which case it may be considered fixed anywhere to the iron tube which hangs from the top of the zinc tube, or a lead bob attached at its own centre, which obviates the slowness of the transmission of a change of temperature through it, the following calculation will hold. Let  $r$  be the length of the steel rod and spring,  $s$  that of the zinc tube,  $b$  half the height of the bob; the length of the iron

tube down the centre of the bob is  $s - b$ . If the iron tube is of steel for simplicity of calculation, we must evidently have  $.064(r + s - b) = 16s$ .  $\therefore s = \frac{3}{2}(r - b)$ . It is practically found that for a seconds pendulum with a lead cylindrical bob 9 in.  $\times$  3 hung by its middle  $r$  has to be about 44 inches, and  $s$  nearly 27. At any rate it is safest to make it 27 at first, especially if the second tube is iron, which expands a little more than steel; and the tube can be shortened after trial but not lengthened. The rod of the standard sidereal pendulum at Greenwich (down to the bottom of the bob, which is such as has been described and weighs 26lb), is 43 $\frac{1}{2}$  and  $s$  is 26 inches, the descending wires being steel. A solar time pendulum is about  $\frac{1}{2}$  inch longer, as stated above. If the bob were fixed at its bottom to the steel tube the sine would have to be 4.88 longer. Fig. 2 is a section of the great Westminster pendulum. The iron rod which runs from top to bottom ends in a screw, with a nut N, for adjusting the length of the pendulum after it was made by calculation as near the right length as possible. On this nut rests a collar C, which can slide up the rod a little, but is prevented from turning by a pin through the rod. On a groove or annular channel in the top of this collar stands a zinc tube 10 feet 6 inches long, and nearly half an inch thick, made of three tubes all drawn together, so as to become like one (for it should be observed that cast zinc cannot be depended on; it must be drawn). On the top of this tube or hollow column fits another collar with an annular groove much like the bottom one M. The object of these grooves is to keep the zinc column in its place, not touching the rod within it, as contact might produce friction, which would interfere with their relative motion under expansion and contraction. Round the collar C is screwed a large iron tube, also not touching the sine, and its lower end fits loosely on the collar M; and round its outside it has another collar D of its own fixed to it, on which the bob rests. The iron tube has a number of large holes in it down each side, to let the air get to the zinc tube; before that was done, it was found that the compensation lagged a day or two behind the changes of temperature, in consequence of the iron rod and tube being exposed, while the zinc tube was enclosed without touching the iron. The bottom of the bob is 14 feet 11 inches from the top of the spring A, and the bob itself is 18 inches



Fig. 2.—Section of high, with a dome-shaped top, and twelve Great Westminster pendulum. As it is a 2-seconds pendulum, its centre of oscillation is 13 feet from the top A, which is higher than usual above the centre of gravity of the bob, on account of the great weight of the compensation tubes. The whole weighs very nearly 700lb, and is probably the heaviest pendulum in the world.

The second kind of compensation pendulum in use is still more simple, but not so effective or certain in its action; and that is merely a wooden rod with a long lead bob resting on a nut at the bottom. According to the above table, it would appear that this bob ought to be 14 inches high in a 1-second pendulum; but the expansion of wood is so uncertain that this proportion is not found capable of being depended on, and a somewhat shorter bob is said to be generally more correct in point of compensation. All persons who have tried wooden pendulums severely have come to the same conclusion, that they are capricious in their action, and consequently unfit for the highest class of clocks.

The best of all the compensations was long thought to be the mercurial, which was invented by Graham, a London clock-maker, above a century ago, who also invented the well-known dead escapement for clocks, which will be hereafter explained, and the horizontal or cylinder escapement for watches. And the best form of the mercurial pendulum is that which was introduced by the late E. J. Dent, in which the mercury is enclosed in a cast iron jar or cylinder, into the top of which the steel rod is screwed, with its end plunged into the mercury itself. For by this means the mercury, the rod, and the jar all acquire the new temperature at any change more simultaneously than when the mercury is in a glass jar hung by a stirrup (as it is called) at the bottom of the rod; and moreover the pendulum is safe to carry about, and the jar can be made perfectly cylindrical by turning, and also air-tight, so as to protect the mercury from oxidation; and, if necessary, it can be heated in

the jar so as to drive off any moisture, without the risk of breaking. The height of mercury required in a cast-iron jar, 2 inches in diameter, is about 6.8 inches; for it must be remembered, in calculating the rise of the mercury, that the jar itself expands laterally, and that expansion has to be deducted from that of the mercury in bulk.

The success of the Westminster clock pendulum, however, and of smaller sine and steel pendulums at Greenwich and elsewhere, has established the conclusion that it is unnecessary to incur the expense of a heavy mercurial pendulum, which has become more serious from the great rise in the price of mercury and the admitted necessity for much heavier bobs than were once thought sufficient for astronomical clocks. The complete calculation for a compensated pendulum in which the rods and tubes form any considerable proportion of the whole weight, as they must in a sine pendulum, is too complicated to be worth undertaking generally, especially as it is always necessary to adjust them finally by trial, and for that purpose the tubes should be made at first a little longer than they ought to be by calculation, except where one is exactly copying pendulums previously tried.

**BAROMETRICAL ERROR.**

It has long been known that pendulums are affected by variations of density of the air as well as of temperature, though in a much less degree,—in fact, so little as to be immaterial, except in the best clocks, where all the other errors are reduced to a minimum. An increase of density of the air is equivalent to a diminution of the specific gravity of the pendulum, and that is equivalent to diminution of the force of gravity while the inertia remains the same. And as the velocity of the pendulum varies directly as the force of gravity and inversely as the inertia, an increase of density must diminish the velocity or increase the time. The late Francis Baily, P.R.A.S., also found from some elaborate experiments (see *Phil. Trans.* of 1832) that swinging pendulums carry so much air with them as to affect their specific gravity much beyond that due to the mere difference of stationary weight, and that this also varies with their shape,—a rod with a flat elliptical section dragging more air with it than a thicker round one (which is not what one would expect), though a lens-shaped bob was less affected than a spherical one of the same diameter, which of course is much heavier. The frictional effect of the air is necessarily greater with its increased density, and that diminishes the arc. In the *R.A.S. Memoirs* of 1893 Mr. Bloxam remarked also that the current produced in the descent of the pendulum goes along with it in ascending, and therefore does not retard the ascent as much as it did the descent, and therefore the two effects do not counteract each other, as Baily assumed that they did. He also found the circular error always less than its theoretical value, and considered that this was due to the resistance of the air. The conclusions which were arrived at by several eminent clockmakers as to the effect of the pendulum spring on the circular error about 40 years ago were evidently erroneous, and the effect due to other causes.

It appears from further investigation of the subject in several papers in the *R.A.S. Notices* of 1872 and 1873, that the barometrical error also varies with the nature of the escapement, and (as Baily had before concluded from calculation) with the arc of the pendulum, so that it can hardly be determined for any particular clock *a priori*, except by inference from a similar one. The barometrical error of an ordinary astronomical clock with a dead escapement was said to be a loss of nearly a second a day for an inch rise of barometer, but with a gravity escapement and a very heavy pendulum not more than .3 second. Dr. Robinson of Armagh (see *R.A.S. Mem.*, vol. v.) suggested the addition of a pair of barometer tubes to the sides of the pendulum, with a bulb at the bottom, and such a diameter of tube as would allow a sufficient quantity of mercury to be transported to the top by the expansion under heat, to balance the direct effect of the heat upon the pendulum. But it is not necessary to have two tubes. In a paper in the *R.A.S. Notices* of January, 1873, Mr. Demison (now Sir E. Beckett) gave the calculations requisite for the barometrical compensation of pendulums of various lengths and weights, the principle of which is just the same as that above given for regulating a pendulum by adding small weights near the middle of its length. The formula is also given at p. 69 of the sixth edition of his *Rudimentary Treatise on Clocks*. A barometrical correction of a different kind has been applied to the standard clock at Greenwich. An independent barometer is made to raise or lower a magnet so as to bring it into more or less action on the pendulum and so to accelerate or retard it. But we do not see why that should be better than the barometer tube attached to the pendulum. The necessity for this correction seems to be obviated altogether by giving the pendulum a sufficient arc of vibration. Baily calculated that if the arc (reckoned from 0) is about 2° 45' the barometrical error will be self-corrected. And it is remarkable that the Westminster clock pendulum, to which that large arc was given for other reasons, appears to be free from any barometric error, after trying the results of the daily rate as automatically recorded at Greenwich for the whole of the

year 1872. We shall see presently that all the escapement errors of clocks are represented by fractions which have the square or the cube of the arc in the denominator, and therefore if the arc can be increased and kept constant without any objectionable increase of force and friction, this is an additional reason for preferring a large arc to a small one, though that is contrary to the usual practice in astronomical clocks.

**ESCAPEMENTS.**

The escapement is that part of the clock in which the rotary motion of the wheels is converted into the vibratory motion of the balance or pendulum, which by some contrivance or other is made to let one tooth of the quickest wheel in the train escape at each vibration; and hence that wheel is called the "scape-wheel." Fig. 3 shows the form of the earliest clock escapement, if it is held sideways, so that the arms on which the two balls are set may vibrate on a horizontal plane. In that case the arms and weights form a balance, and the farther out the weights are set, the slower would be the vibrations. If

we now turn it as it stands here, and consider the upper weight left out, it becomes the earliest form of the pendulum clock, with the *crown-wheel* or *vertical* escapement. CA and CB are two flat pieces of steel, called *pallets*, projecting from the axis about at right angles to each other, one of them over the front of the wheel as it stands, and the other over the back. The tooth D is just escaping from the front pallet CA, and at the same time the tooth at the back of the wheel falls on the other pallet CB, a little above its edge. But the pendulum which is now moving to the right does not stop immediately, but swings a little further (otherwise the least failure in the force of the train would stop the clock, as the scape would not take place), and in so doing it is evident that the pallet

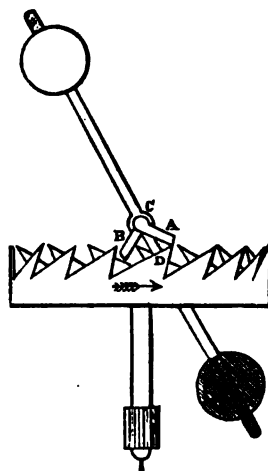

Fig. 3.—Recoil Escapement.

B will drive the wheel back a little, and produce what is called the *recoil*; which is visible enough in any common clock with a seconds-hand, either with this escapement or the one which will be next described.

It will be seen, on looking at figure 3, that the pallet B must turn through a considerable angle before the tooth can escape;

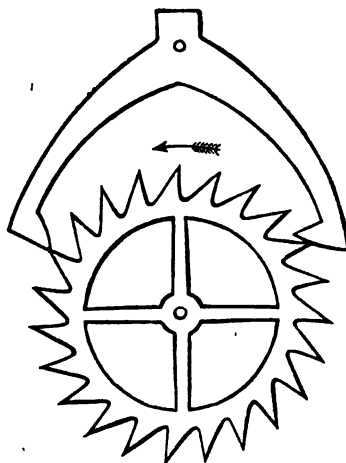

Fig. 4.—Anchor Escapement.

in other words, the crown-wheel escapement requires a long vibration of the pendulum. This is objectionable on several accounts,—first, because it requires a great force in the clock train, and a great pressure, and therefore friction, on the pallets; and besides that, any variation in a large arc, as was explained before, produces a much greater variation of time due to the circular error than an equal variation of a small arc. The crown-wheel escapement may indeed be made so as to allow a more moderate arc of the pendulum, though not so small

as the 2° usually adopted in the best clocks, by putting the pallet arbor a good deal higher above the scape-wheel, and giving a small number of teeth to the wheel; and that also diminishes the length of the run of the teeth, and consequently the friction, on the pallets, though it makes the recoil very great and sudden; but, oddly enough, it never appears to have been resorted to until long after the escapement had become superseded by the "anchor" escapement, which we shall now describe, and which appears to have been invented by the celebrated Dr. Hooke as early as the year 1656, very soon after the invention of pendulums.

In fig. 4 a tooth of the scape-wheel is just escaping from the left pallet, and another tooth at the same time falls upon the right hand pallet at some distance from its point. As the pendulum moves on in the same direction, the tooth slides farther up the pallet, thus producing a recoil, as in the crown-wheel escapement. The acting faces of the pallets should be concave, and not flat, as they are generally made, much less concave, as they have sometimes been made, with a view of checking the motion of the pendulum, which is more likely to injure the rate of the clock than to improve it. But when they are flat, and of course still more when they are concave, the points of the teeth always wear a hole in the pallets at the extremity of their usual swing, and the motion is obviously easier and therefore better when the pallets are made convex; in fact they then approach more nearly to the "dead" escapement, which will be described presently. We have already alluded to the effect of some escapements in not only counteracting the circular error, or the natural increase of the time of a pendulum as the arc increases, but overbalancing it by an error of the contrary kind. The recoil escapement does so; for it is almost invariably found that whatever may be the shape of these pallets, the clock loses as the arc of the pendulum falls off, and *vice versa*. It is unfortunately impossible so to arrange the pallets that the circular error may be thus exactly neutralized, because the escapement error depends, in a manner reducible to no law, upon variations in friction of the pallets themselves and of the clock train, which produce different effects; and the result is that it is impossible to obtain very accurate time-keeping from any clock of this construction.

But before we pass on to the dead escapement, it may be proper to notice an escapement of the recoiling class, which was invented for the purpose of doing without oil, by the famous Harrison, who was at first a carpenter in Lincolnshire, but afterwards obtained the first Government reward for the improvement of chronometers. We shall not however stop to describe it, since it never came into general use, and it is said that nobody but Harrison himself could make it go at all. It was also objectionable on account of its being directly affected by all variations in the force of the clock. It had the peculiarity of being very nearly silent, though the recoil was very great. Those who are curious about such things will find it described in the seventh edition of this *Encyclopædia*. The recorded performance of one of these clocks, which is given in some accounts of it, is evidently fabulous.

#### Dead Escapements.

The escapement which has now for a century and a half been considered the best practical clock escapement (though there

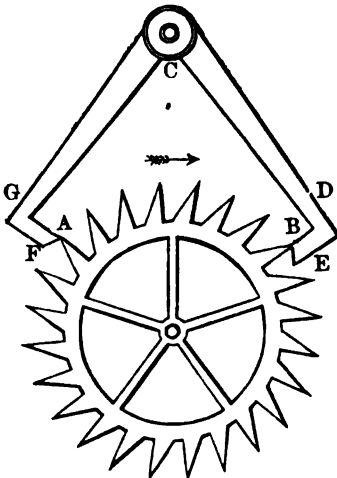

Fig. 5.—Dead Escapement.

have been constant attempts to invent one free from the defects which it must be admitted to possess) is the *dead escapement*, or, as the French call it with equal expressiveness, *l'échappement*

*d repose*,—because instead of the recoil of the tooth upon the pallet, which took place in the previous escapements, it falls dead upon the pallet, and reposes there until the pendulum returns and lets it off again. It is represented in fig. 5. It will be observed that the teeth of the scape-wheel have their points set the opposite way to those of the recoil escapement in fig. 4, the wheels themselves both turning the same way; or (as our engraver has represented it), *vice versa*. The tooth B is here also represented in the act of dropping on to the right hand pallet as the tooth A escapes from the left pallet. But instead of the pallet having a continuous face as in the recoil escapement, it is divided into two, of which BE on the right pallet, and FA on the left, are called the impulse faces, and BD, FG, the dead faces. The dead faces are portions of circles (not necessarily of the same circle), having the axis of the pallets C for their centre; and the consequence evidently is, that as the pendulum goes on, carrying the pallet still nearer to the wheel than the position in which a tooth falls on to the corner A or B of the impulse and the dead faces, the tooth still rests on the dead faces without any recoil, until the pendulum returns and lets the tooth slide down the impulse face, giving the impulse to the pendulum as it goes.

The great merit of this escapement is that a moderate variation in the force of the clock train produces a very slight effect in the time of the pendulum. This may be shown in a general way, without resorting to mathematics, thus:—Since the tooth B drops on to the corner of the pallet (or ought to do so) immediately after the tooth A has escaped, and since the impulse will begin at B when the pendulum returns to the same point at which the impulse ceased on A, it follows that the impulse received by the pendulum before and after its vertical position is very nearly the same. Now that part of the impulse which takes place before zero, or while the pendulum is descending, tends to augment the natural force of gravity on the pendulum, or to make it move faster; but in the descending arc the impulse on the pallets acts against the gravity of the pendulum, and prevents it from being stopped so soon; and so the two parts of the impulse tend to neutralise each other's disturbing effects on the times of the pendulum, though they both concur in increasing the arc, or (what is the same thing) maintaining it against the loss from friction and resistance of the air. However, on the whole, the effect of the impulse is to retard the pendulum a little, because the tooth must fall, not exactly on the corner of the pallet, but (for safety), a little above it; and the next impulse does not begin until that same corner of the pallet has come as far as the point of the tooth; in other words, the retarding part of the impulse, or that which takes place after zero, acts rather longer than the accelerating part before zero. Again, the friction on the dead part of the pallets tends to produce the same effect on the time; the arc of course it tends to diminish. For in the descent of the pendulum the friction acts against gravity, but in the ascent with gravity, and so shortens the time; and there is rather less action on the dead part of the pallets in the ascent than in the descent. For these reasons the time of vibration of a pendulum driven by a dead escapement is a little greater than of the same pendulum vibrating the same arc freely; and when you come to the next difference, the variation of time of the same pendulum with the dead escapement, under a moderate variation in the force, is very small indeed, which is not the case in the recoil escapement, for there the impulse begins at each end of the arc, and there is much more of it during the descent of the pendulum than during the ascent from zero to the arc at which the escape takes place and the recoil begins on the opposite tooth; and then the recoil itself acts on the pendulum in its ascent in the same direction as gravity, and so shortens the time. And hence it is that an increase of the arc of the pendulum with a recoil escapement is always accompanied with a decrease of the time. Something more than this general reasoning is requisite in order to compare the real value of the dead escapement with others of equal or higher pretensions, or of the several contrivances that have been suggested for remedying its defects. But we must refer to the *Rudimentary Treatise on Clocks* for details of the mathematical calculations by which the numerical results are obtained, and the relative value of the different kinds of escapements determined.

It cannot be determined *a priori* whether cleaning and oiling a dead escapement clock will accelerate or retard it, for reasons explained in those calculations; but it may be said conclusively that the larger the arc is for any given weight  $\times$  the fall per day, the better the clock will be; and in order to diminish the friction and the necessity for using oil as far as possible, the best clocks are made with jewels (sapphires are the best for the purpose) let into the pallets.

The pallets are generally made to embrace about one-third of the circumference of the wheel, and it is not at all desirable that they should embrace more; for the longer they are, the longer is the run of the teeth upon them, and the greater the friction. There is a good deal of difference in the practice of clockmakers as to the length of the impulse, or the amount of the angle  $\gamma + \beta$  if the impulse begins at  $\beta$  before zero and at  $\gamma$

after zero. Sometimes you see clocks in which the seconds hand moves very slowly and rests a very short time, showing that  $\gamma + \beta$  is large in proportion to  $2\alpha$ ; and in others the contrary. The late Mr. Dent was decidedly of the opinion that a short impulse was the best, probably because there is less of the force of the impulse wasted in friction than. It is not to be forgotten that the scape-wheel tooth does not overtake the face of the pallet immediately, on account of the moment of inertia of the wheel. The wheels of astronomical clocks, and indeed of all

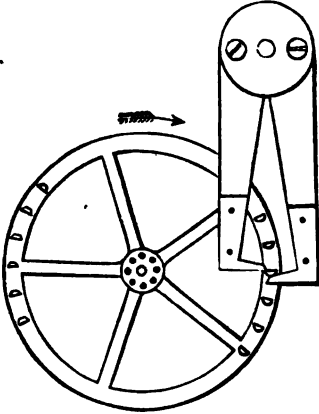

FIG. 6.—Pin-Wheel Escapement.

English house-clocks, are generally made too heavy, especially the scape-wheel, which, by increasing the moment of inertia, requires a larger force, and consequently has more friction. We shall see presently, from another escapement, how much of the force is really wasted in friction in the dead escapement.

But before proceeding to other escapements, it is proper to notice a very useful form of the dead escapement, which is adopted in many of the best turret clocks, called the *pin-wheel escapement*. Fig. 6 will sufficiently explain its action and construction. Its advantages are—that it does not require so much accuracy as the other; if a pin gets broken it is easily replaced, whereas in the other the wheel is ruined if the point of a tooth is injured; a wheel of given size will work with more pins than teeth, and therefore a train of less velocity will do, and that sometimes amounts to a saving of one wheel in the train, and a good deal of friction; and the blow on both pallets being downwards, instead of one up and the other down, the action is more steady; all which things are of more consequence in the heavy and rough work of a turret clock than in an astronomical one. The details of the construction are given in the *Rudimentary Treatise*. It has been found expedient to make the dead faces not quite dead, but with a very slight recoil, which rather tends to check the variations of arc, and also the general disposition to lose time if the arc is increased; when so made the escapement is generally called "half-dead."

Passing by the various other modifications of the dead escapement which have been suggested and tried with little or no success, we proceed to describe one of an entirely different form, which was patented in 1851 by Mr. C. Maedowall, though it appeared afterwards that one very similar had been tried before, but failed from the proportions being badly arranged. It is represented in fig. 7. The scape-wheel is only a small disc with a single pin in it, made of ruby, parallel and very near to the arbor. The disc turns half round at every beat of the pendulum, and the pin gives the impulse on the vertical faces of the pallets, and the dead friction takes place on the horizontal faces. Its advantages are—that the greatest part of the impulse is given directly across the line of centres, and consequently with very little friction; and therefore also, the friction on the dead faces is less than usual, and scarcely any oil is required; moreover, it is very easy to make. But there must be two more wheels in the train, consuming a good deal of the force of the clock-weight by their friction, which rather more than makes up for the friction saved in the escapement. It was applied successfully to watches,

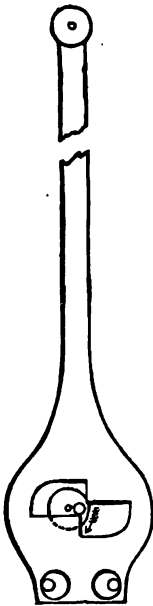

FIG. 7.  
Maedowall's Escapement.

but the expense of the additional wheels prevented their adoption. In order to make the angle of escape not more than  $10^\circ$ , the distance of the pin from the centre of the disc must not be more than  $\frac{1}{3}$  of the distance of centres of the disc and pallets.

With the view of getting rid of one of these extra wheels in the train, and that part of the impulse which is least effective and most oblique, Mr. Denison shortly afterwards invented the *three-legged dead escapement*; which, though afterwards superseded by his *three-legged gravity escapement*, is still worth notice on account of the exceedingly small force which it requires, thereby giving a practical proof of the large proportion of the force which is wasted in friction in all the other impulse escapements.

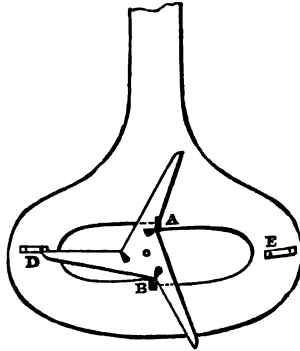

FIG. 8.—Denison's Three-Legged Escapement.

here shown, the long tooth will slip past the dead pallet or stop D, and the pin at B will run after and catch the corner of that impulse pallet and drive it until the wheel has turned through  $60^\circ$ , and then it will escape; and by that time the uppermost tooth will arrive at the stop E, and will slide along it as in the common dead escapement, but with a pressure as much less than that which gives the impulse as the points of the teeth are farther from the centre of the wheel than the impulse pins are. But the impulse is here given with so little friction, that even where the points of the teeth were made identical with the pins, the clock-weight required to keep the same pendulum with the same train (a common turret-clock movement) swinging to  $2^\circ$ , was only one-fifth of what had been required with the pin-wheel escapement; and the scape-wheel which kept the Govt. pendulum of the Westminster clock going for half-a-year, until superseded by the gravity escapement, weighed only a sixth of an ounce. It appears also that it would be possible so to adjust the recoil of the half-dead pallets that the time would not be affected by any small variation of the force and the arc; since it was found that, when a certain amount of recoil was given, the clock gained instead of losing, under an increase of arc due to an increase of clock-weight. And if the force were kept constant by a train remontoire, such as will be described hereafter, there would in fact be nothing capable of altering the arc or the time. But on account of the small depth of intersection of the circles of the pins and the pallets, on which its action depends, this escapement requires very careful adjustment of the pallets, except where they are on a large scale; and considering the superior qualities of the corresponding gravity escapement, it is not likely to be used, except perhaps in clocks required to go a long time, in which economy of force is a matter of consequence. The pallets should be connected with the pendulum by a spring fork (which indeed is advisable in the common dead escapement with a heavy pendulum, especially the pin-wheel escapement), to prevent the risk of their driving backwards against the scape-wheel when it is not in motion, as it will not clear itself. The distance of the centres should be not less than 25 times the radius of the circle of the edges of the impulse pins.

#### Detached Escapements.

In all the escapements hitherto described the pallets are never out of moving contact with the scape-wheel, and there have been several contrivances for keeping them detached except during the impulse and at the moment of passing a click which is to release the wheel to give the impulse. This is an imitation of the chronometer escapement in watches which is sometimes called the "detached." There are only two of such contrivances which appear worth special notice. One was proposed by Sir G. Airy in vol. ii. of the *Cambridge Transactions*, but not executed (so far as we know) till a few years ago in the standard sidereal clock at Greenwich, which is reported to go extremely well. Suppose a dead escapement consisting of a single pallet only, say the right hand one of the pin-wheel escapement (fig. 6), for the Greenwich clock has a pin escapement, and that the wheel is locked generally by a spring detent hooking into any one of its teeth, and capable of being lifted or pushed aside by the pendulum, i.e., by a pin somewhere on the single pallet as it passes to the right, but also capable of being passed without

being lifted as the pendulum goes to the left. We shall see afterwards how this is done, in the article *WATCHES*. Then as the pendulum goes to the right, it first lifts the detent at about  $1^\circ$  before zero, and then a tooth or a pin drops on to the pallet and gives the impulse, exactly as in the dead pin-wheel escapement, and with exactly the same amount of friction, substituting only for the dead friction the resistance and friction of passing the detent one way and lifting it the other.

A different escapement on the same principle but involving less friction was adopted by Sir E. Beckett in a clock described in the later editions of his book as having gone for above ten years very satisfactorily, except that, like all direct impulse escapements, including Sir G. Airy's, it must vary with the force of the clock train, due to different states of the oil. The scape-wheel (fig. 9) is five-legged, and has five sharp-edged pins which give the impulse to the hard steel pallet P whenever it passes to the right, provided the wheel is then free to move. It is stopped by the detent DEF, which turns on a pivot F, not in the pendulum crutch, as it looks in the drawing, but on the clock-frame. When the pendulum going to the right arrives at the position here drawn, the click CE on the crutch pushes the detent aside and so unlocks the wheel, which then gives the impulse, moving through  $72^\circ$  until another tooth arrives at the detent and is stopped, the click having then got far beyond it. When the pendulum returns the click lightly trips over the top of the detent. Here there is practically no friction in giving the impulse, as it is directly across the line of centres, as in the three-legged dead escapement, and the friction of passing and unlocking is as little as possible, for the pressure on the locking tooth is less than half of that of the impulse pins.

In practice the pallet P is a separate bit of steel, screwed on, and therefore adjustable. The locking teeth are about 6 inches long from the centre, and the impulse pin-edges  $\frac{1}{2}$  in. from the centre, which is 7 in. below the top of the pendulum and crutch, so that the impulse begins  $1^\circ$  before zero and ends  $1^\circ$  after, corresponding each to  $86^\circ$  turn of the scape-wheel. If  $r$  is the distance of the pins from the centre and  $p$  the length of the crutch down to the centre,  $r \sin. 86^\circ$  must =  $p \sin. 1^\circ$ , if you want an impulse of  $1^\circ$  on each side of 0; which makes  $p = 83.7r$ . BB are eccentric beat pins for adjusting the beat to whatever position of the pendulum you please, i.e., you can make it less than  $1^\circ$  before or after zero as you please. In some respects it would be better to have no

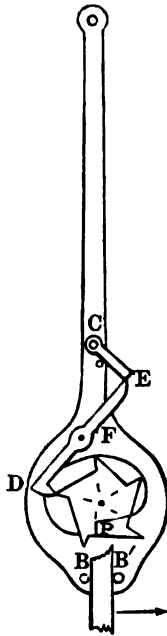

FIG. 9.

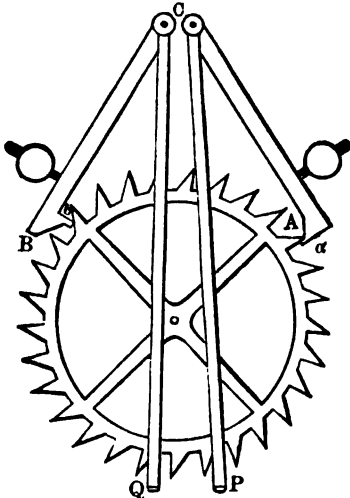

FIG. 10.—Mudge's Gravity Escapement.

crutch, but it would be very difficult to make the adjustments. This escapement should evidently be at the bottom of the clock-frame instead of the top, as in the gravity escapements which will be described presently. The back part of the scape-wheel is carried by a long cock or bridge within which the crutch also moves.

*Remontoire or Gravity Escapements.*

A remontoire escapement is one in which the pendulum does not receive its impulse from the scape-wheel, but from some small weight or spring which is lifted or wound up by the scape-wheel at every beat, and the pendulum has nothing to do with the scape-wheel except unlocking it. When this impulse is received from a weight the escapement is also called a *gravity escapement*; and inasmuch as all the remontoire clock escapements that are worth notice have been gravity escapements, we may use that term for them at once. The importance of getting the impulse given to the pendulum in this way was recognized long before all the properties of the dead escapement, as above investigated, were known. For it was soon discovered that, however superior to the old recoil escapement, it was far from perfect, and that its success depended on reducing the friction of the train and the pallets as far as possible, which involves the necessity of high-numbered pinions and wheels, small pivots, jewelled pallets, and a generally expensive style of workmanship. Accordingly the invention of an escapement which will give a constant impulse to the pendulum, and be nearly free from friction, has been for a century the great problem of clock-making. We can do no more than shortly notice a very few of the attempts which have been made to solve it. The most simple form of gravity escapement, and the one which will serve the best for investigating their mathematical properties (though it fails in some essential mechanical conditions), is that invented by Mudge. The tooth A of the scape-wheel in fig. 10 is resting against the stop or detent  $\alpha$  at the end of the pallet CA, from the axis or arbor of which descends the half fork CP to touch the pendulum. From the other pallet CB descends the other half fork CO. The two arbors are set as near the point of suspension, or top of the pendulum spring, as possible. The pendulum, as here represented, must be moving to the right, and just leaving contact with the left pallet and going to take up the right one; as soon as it has raised that pallet a little it will evidently unlock the wheel and let it turn, and then the tooth B will raise the left pallet until it is caught by the stop  $\beta$  on that pallet, and then it will stay until the pendulum returns and releases it by raising that pallet still higher. Each pallet therefore descends with the pendulum to a lower point than that where it is taken up, and the difference between them is supplied by the lifting of each pallet by the clock, which does not act on the pendulum at all; so that the pendulum is independent of all variations of force and friction in the train.

Again referring to the *Rudimentary Treatise on Clocks* for the mathematical investigation of the errors of this class of escapements, or to a paper by the late J. M. Bloxam, in the *R.A.S. Memoirs* of 1853, we may say it is proved that though the time of a gravity escapement pendulum differs from that of a free pendulum more than from that of a dead escapement, yet the variations of that difference (which are the real variations of the clock) may be made much less than in any kind of dead escapement.

The difficulty which long prevented the success of gravity escapements was their liability to what is called *tripping*. Referring again to fig. 10, it will be seen at once that if the scape-wheel should happen to move too fast when it is released, the left pallet will not be raised gradually by the tooth B, but be thrown up with a jerk, perhaps so high that the tooth slips past the hook; and then not only will that tooth slip, but several more, and at last when the wheel is stopped it will be running fast, and the points of some of the teeth will probably be bent or broken by catching against the pallets. And even if the pallet is not raised high enough for the tooth to get past or completely trip, it may still be raised so high that the point of the tooth does not rest on the hook exactly where the slope of the pallet ends, but lower, and the friction between them is quite enough to keep the pallet there; and consequently the pendulum does not begin to lift it at the proper angle  $\gamma$ , but at some larger angle; and as the pallet always descends with the pendulum to the same point, the duration of the impulse is increased, and the pendulum made to swing farther. Sir E. Beckett called this *approximate tripping*, and though not so injurious to the clock as actual tripping, it is obviously fatal to its accurate performance, though it appears never to have been noticed before he pointed it out in 1851. Various contrivances have been resorted to for preventing tripping. But on account of the delicacy required in all of them, and other objections, none of them ever came into use until the invention of the three-legged and four-legged escapements to be mentioned presently. The only one which approached near enough to satisfying all the requisite conditions to be worth description is Mr. Bloxam's, and we accordingly give a sketch of it in fig. 11, which is copied (with a little alteration for distinctness) from his own description of it, communicated in 1853 to the Astronomical Society, some years after he had had it in action in a clock of his own. This drawing will enable any one conversant with these matters to understand its action. He made the pallet arbors cranked, to embrace the pendulum-spring, so that their centres of motion might coincide with that of the pendulum as nearly as possi-



ble,—perhaps an unnecessary refinement; at least the three-legged and four-legged gravity escapements answer very well with the pallet arbors set on each side of the top of the spring. The size of the wheel determines the length of the pallets, as they must be at such an angle to each other that the radii of the wheel when in contact with each stop may be at right angles to the pallet arm; and therefore, for a wheel of this size, the depth of locking can only be very small. The pinion in Mr. Bloxam's clock only raises the pallet through 40' at each beat; i. e., the angle which we called  $\gamma$  is only 20'; and probably, if it were increased to anything

like  $\frac{\alpha}{\sqrt{2}}$ , the escapement would trip immediately. The two broad pins marked E, F, are the fork-pins. The clock which Mr. Bloxam had went very well; but it had an extremely fine train, with pinions of 18; and nobody else appears to have been able to make one to answer. In short Bloxam's was not a practical solution of the gravity escapement problem, any more than those of Captain Kater, or Hardy, or various other inventors. A few clocks of Hardy's alone still exist.

The only gravity escapement or escapements that really have come into common use are the "four-legged" and the "double three-legged" escapements of Sir E. Beckett. They passed through various phases before settling into the present form, of which it is unnecessary to say more now than that the first was the single three-legs described in the last edition of this *Encyclopædia*, which was suggested by his three-legged dead escapement. A five-legged one was also tried; but though it had some slight advantages they are quite overbalanced by disadvantages, and it requires much more delicacy of construction than either the double three-legs or the four-legs which we shall now describe, remarking that the latter is the best for "regulators," and the former in large clocks. Fig. 12 is a back view of the escapement part of an astronomical clock with the four-legged wheel; seen from the front the wheel would turn the other way. The long locking teeth are made about 2 inches long from the centre, and the lifting pins, of which there are four pointing forwards, and the other four intermediate pointing backwards, are at not more than one-30th of the distance between the centres EC, of the wheel and pallets; or rather C is the top of the pendulum spring to which the pallets CB, CS' converge, though their actual action is a little below C. It is not worth while to crank them as Mr. Bloxam did, in order to make them coincide exactly with the top of the pendulum, as the friction of the beat pins on the pendulum at P is insignificant, and even then would not be quite destroyed. The pallets are not in the same plane, but one is behind and the other in front of the wheel, with one stop pointing backwards and the other forwards to receive the teeth alternately,—it does not matter which; in this figure the stop B is behind and the stop S' forward. The pendulum is now going to the right, and just beginning to lift the right pallet and free the stop S'; then the wheel will begin to turn and lift the other pallet by one of the pins which is now lowest, and which moves through 45° across the line of centres, and therefore lifts with very little friction. It goes on till the tooth now below S reaches S and is stopped there. Meanwhile the pallet CS' goes on with the pendulum as far as it may go, to the end of the arc which we have throughout called  $\alpha$ , starting from  $\gamma$ ; but it falls with the pendulum again,

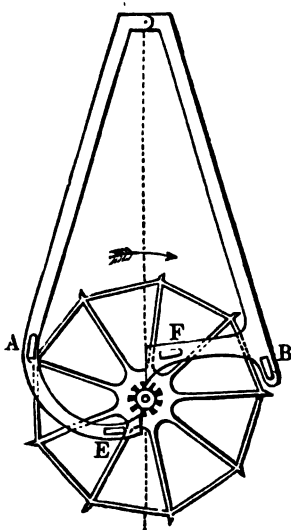

FIG. 11.—Bloxam's Gravity Escapement.

not only to  $\gamma$  but to  $-\gamma$  on the other side of 0, so that the impulse is due to the weight of each pallet alternately falling through  $2\gamma$ ; and the magnitude of the impulse also depends on the obliqueness of the pallet on the whole, i. e., on the distance of its centre of gravity from the vertical through C. The defect of the original three-legged escapement was that the pallets were too nearly vertical.

Another most material element of these escapements with very few teeth is that they admit of a fly KK on the scape-wheel arbor to moderate its velocity, which both obviates all risk of tripping, wholly or partially, and also prevents the bang which goes all through the clock where there is no fly. The fly is set on with a friction spring like the common striking-part fly, and should be as long as there is room for, length being much more effective than width. For this purpose the second wheel arbor is shortened and set in a cock fixed on the front plate of the clock, which leaves room for a fly with vanes 2 inches long. The back pivot of the scape-wheel is carried by a long cock behind the back plate, so that the escapement is entirely behind it, close to the pendulum. The pallet arbors are short, as they come just behind the centre wheel, which is here also necessarily above the escapement, and the great wheel arbor on a level with it, and at the left hand (from the front) or the string would be in the way of the fly. No beat screws are required, as the pallets end in mere wires which are easily bent. It is found better to make the tails of the pallets long, rather than short as Mr. Bloxam did. It is essential too, that the angle CSE formed by the tooth and the pallet which is struck upwards should not the least fall short of a right angle, nor the other angle CS'E be the least obtuse, or the escapement may very likely trip. Practically, therefore, it is safer to let CSE be just greater than 90° and CS'E a little less, so that there may not be the least tendency in the blow on the stops to drive the pallets outwards. For the purpose of calculation, however, we must make them both 90°, and then it follows that, calling the length of the teeth  $t$ , and the distance of centres  $d$ , and the length of the pallets from C down to the stops  $p$ ,  $r$  must =  $d \sin. 22\frac{1}{2}^\circ$  and  $p = d \cos. 22\frac{1}{2}^\circ$ . Therefore if  $r$  is made 2 inches CE or  $d$  will be 5.22, say 5½ inches, and  $p = 4.82$ . The distance of the lifting pins from the centre will be  $\frac{1}{4}$  of an inch to make the angle  $\gamma = 1^\circ$ . It is certainly not desirable to make it more, and even that requires such light pallets for a pendulum of 30 or 40 lb, that  $\frac{1}{4}$  inch distance from the centre is more convenient as giving the smaller lift, assuming the scape-wheel to be from 2 to 2½ inches in diameter.

Gravity escapements require more weight than a direct impulse escapement with an equally fine train; and they try the accuracy of the wheelcutting more severely. If there is a weak place in the train of a common clock the scape-wheel only follows the pendulum more weakly; but in a gravity escapement it always has to raise the pallets, and ought to raise them quickly, and especially in clocks for astronomical purposes where you take its exact time from the sound of the beats, and so the lifting must not lag and sound uneven. Therefore although a fine train of high numbers is not requisite it must be perfectly well out. And as the force of the weight does not reach the pendulum its increase is of no consequence, within reasonable limits. It is worth while to put large friction wheels under the arbor of the great wheel in all astronomical clocks, and it makes a material difference in the friction on account of the necessary thickness of the winding arbor. A variation of arc in dead escapement clocks is sometimes visible between the beginning and the end of the weak according as the string is nearest to the thick or the thin end of the great arbor, when there are no friction wheels.

The other form of the gravity escapement, which is now adopted for large clocks by all the best makers, having been first used in the great Westminster clock, is the double three-legged which is shown in fig. 13. The principle of it is the same as of the four-legs; but instead of the pallets being one behind and the other in front of the wheel, with two sets of lifting pins, there are two wheels ABC, abc, with the three lifting pins and the two pallets between them like a lantern pinion. One stop B points forward and the other A backward. The two wheels have their teeth set intermediately or 60° apart, though that is not essential, and the angle of 120° may be divided between them in any other proportions, as 70° and 50°, and in that way the pallets may be still more oblique than 30° from the vertical, which however is found enough to prevent tripping even if the fly gets loose, which is

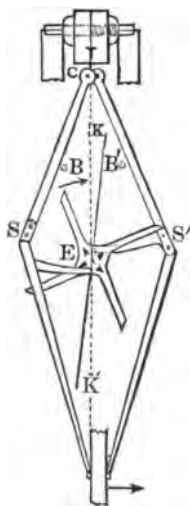

FIG. 12.—Four-Legged Gravity Escapement.

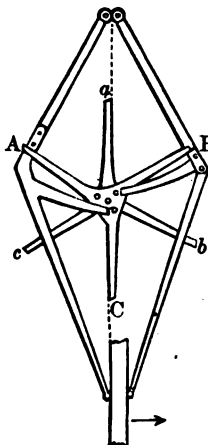

FIG. 13.—Double Three-Legged Escapement.

more likely to happen from carelessness in large clocks than in astronomical ones. The Westminster one was once found to have been left with the spring loose for several days, and it had not gained a second, and therefore had never tripped. The two wheels must be both squared on the arbor, or on a collar common to them both, and must not depend upon the three pins or they will shake loose. If the wheels are set with the teeth equidistant, their centre is evidently twice the length of the teeth below C, the theoretical centre of the pallets. The pins should not be farther from the centre than one-24th of the radius of the wheel; and they should be so placed that the one which is going to lift next may be vertically over the one which has just lifted, and is then holding up the other pallet. The third will then be level with the centre; i.e., they will stand on the radii which form the acting faces of the teeth of one of the wheels, and half way between those of the other.

Of course the fly for those escapements in large clocks, with weights heavy enough to drive the hands in all weather, must be much larger than in small ones. For average church clocks with  $1\frac{1}{2}$  sec. pendulum the legs of the scape-wheels are generally made 4 inches long and the fly from 6 to 7 inches long in each vane by  $1\frac{1}{2}$  or  $1\frac{1}{4}$  wide. For  $1\frac{1}{2}$  sec. pendulums the scape-wheels are generally made  $4\frac{1}{2}$  radius. At Westminster they are 6 inches.

Sir E. Beckett has come to the conclusion that these escapements act better, especially in regulators, if the pallets do not fall quite on the lifting pins, but on a banking, or stops at any convenient place, so as to leave the wheel free at the moment of starting; just as the striking of a common house clock will sometimes fail to start unless the wheel with the pins has a little run before a pin begins to lift the hammer. The best way to manage the banking is to make the beat-pins long enough to reach a little way behind the pendulum, and let the banking be a thin plate of any metal screwed adjustably to the back of the case. This plate cannot well be shown in the drawings together with the pendulum, which, it may be added, should take up one pallet just when it leaves the other.

It is no longer doubtful that these two escapements are far the best of all for large clocks, the three-legs for very large ones, while the four-legs does very well for smaller turret clocks. And they cost no more to make, though rather more is charged for them by some makers under the pretence that they do. It is absolutely impossible for any large clock exposed to the variations of weather and dust to keep as good time as an ordinary good house clock unless it has either a gravity escapement, or a train remontoire, which last is much more expensive, to intercept the variations of force before they reach the pendulum. And though a detached escapement clock while kept clean and the oil in good condition is as good as a gravity one and perhaps better, the gravity one is less affected by variations of the oil, and its rate is altogether more constant. They seem also to have a smaller barometric error.

#### GOING BARRELS.

A clock which is capable of going accurately must have some contrivance to keep it going while you are winding it up. In

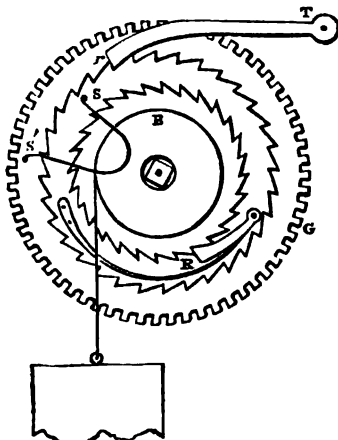

FIG. 14.—Harrison's Going-Ratchet.

the old-fashioned house clocks, which were wound up by merely pulling one of the strings, and in which one such winding served for both the going and striking parts, this was done by what is called the endless chain of Huyghens, which consists of a string or chain with the ends joined together, and passing over two pulleys on the arbors of the great wheels, with deep grooves and spikes in them, to prevent the chain from slipping. In one of the two loops or festoons which hang from the upper pulleys is

a loose pulley without spikes, carrying the clock-weight, and in the other a small weight only heavy enough to keep the chain close to the upper pulleys. Now, suppose one of those pulleys to be on the arbor of the great wheel of the striking part, with a ratchet and click, and the other pulley fixed to the arbor of the great wheel of the going part; then (whenever the clock is not striking) you may pull up the weight by pulling down that part of the string which hangs from the other side of the striking part; and yet the weight will be acting on the going part all the time. And it would be just the same if you wound up the striking part and its pulley with a key, instead of pulling the string, and also the same, if there were no striking part at all, but the second pulley were put on a blank arbor, except that in that case the weight would take twice as long to run down, supposing that the striking part generally requires the same weight  $\times$  fall as the going part.

This kind of going barrel, however, is evidently not suited to the delicacy of an astronomical clock; and Harrison's going ratchet is now universally adopted in such clocks, and also in chronometers and watches for keeping the action of the train on the escapement during the winding. Fig. 14 (in which the same letters are used as in the corresponding parts of fig. 1) shows its construction. The click of the barrel-ratchet R is set upon another larger ratchet-wheel, with its teeth pointing the opposite way, and its click rT is set in the clock-frame. That ratchet is connected with the great wheel by a spring s' pressing against the two pins s in the ratchet and s' in the wheel. When you wind up the weight (which is equivalent to taking it off), the click Tr prevents that ratchet from turning back or to the right; and as the spring s' is kept by the weight in a state of tension equivalent to the weight itself, it will drive the wheel to the left for a short distance, when its end s is held fast, with the same force as if that end was pulled forward by the weight; and as the great wheel has to move very little during the short time the clock is winding, the spring will keep the clock going long enough.

In the commoner kind of turret clocks a more simple apparatus is used, which goes by the name of the *bolt and shutter*, because it consists of a weighted lever with a broad end, which shuts up the winding-hole until you lift it, and then a spring-bolt attached to the lever, or its arbor, runs into the teeth of one of the wheels, and the weight of the lever keeps the train going until the bolt has run itself out of gear. In the common construction of this apparatus there is nothing to ensure its being raised high enough to keep in gear the whole time of winding, if the man loiters over it. For this purpose Sir E. Beckett has the arbor of the bolt and shutter made to *pump* in and out of gear; and, instead of the shutter covering the winding-hole, it ends in a circular arc advanced just far enough to prevent the key or winder from being put on, by obstructing a ring set on the end of the pipe. In order to get the winder on, you *must* raise the lever high enough for the arc to clear the ring. During the two or three minutes which the clock may take to wind, the arc will be descending again behind the ring, so that now you cannot get the winder off again without also pulling the maintaining power out of gear; so that even if it is constructed to keep in action ten minutes, if required, still it will never remain in action longer than the actual time of winding. The circular arc must be thick enough, or have a projecting flange added to it deep enough, to prevent the winder being put on by merely pushing back the maintaining power lever without lifting it.

In large clocks with a train remontoire, or even with a gravity escapement, it is hardly safe to use a spring going barrel, because it is very likely to be exhausted too much to wind up the remontoire, or raise the gravity pallets, before the winding is finished, if it takes more than two or three minutes; whereas, with the common escapement, the wheel has only to escape, as the pendulum will keep itself going for some time without any impulse.

#### EQUATION CLOCKS.

It would occupy too much space to describe the various contrivances for making clocks show the variations of solar compared with mean time (called equation clocks), the days of the month, periods of the moon, and other phenomena. The old day of the month clocks required setting at the end of every month which has not 31 days, and have long been obsolete. Clocks are now made even to provide for leap year. But we doubt whether practically anybody ever takes his day of the month from a clock face, especially as the figures are too small to be seen except quite near. Several persons have taken patents for methods of exhibiting the time by figures appearing through a hole in the dial, on the principle of the "numbering machine." But they do not reflect that no such figures, on any practicable scale, are as conspicuous as a pair of hands; and that nobody really reads the figures on a dial, but judges of the time in a moment from the position of the hands; for which reason the minute hand should be straight and plain, while the hour hand has a "heart" near the end; 12 large marks and 48 small ones make a more distinguishable dial than one with figures; and the smaller the figures are the better, as they only tend to obscure the hands.

## STRIKING CLOCKS.

There are two kinds of striking work used in clocks. The older of them, which is still used in most foreign clocks, and in turret clocks in England also, will not allow the striking of any hour to be either omitted or repeated, without making the next hour strike wrong; whereas, in that which is used in all English house clocks, the number of blows to be struck depends merely on the position of a wheel attached to the going part; and therefore the striking of any hour may be omitted or repeated without deranging the following ones. In turret clocks there is no occasion for the repeating movement; and for the purpose of describing the other, which is called the *locking-plate* movement, we may as well refer to fig. 22, which is the front view of a large clock, striking both hours and quarters on this plan. In the hour part (on the left), you observe a bent lever BAH, called the "lifting-piece," of which the end H has just been left off by the snail on the hour-wheel 40 of the going part; and at the other end there are two stops on the back side of the lever, one behind, and rather below the other; and against the upper one a pin in the end of a short lever 9 B, which is fixed to the arbor of the fly, is now resting, and thereby the train is stopped from running, and the clock from striking any more. The stops are shown on the quarter lifting-piece in the figure (27) of the Westminster clock. We omit the description of the action of the wheels, because it is evident enough. At D may be seen a piece projecting from the lever AB, and dropping into a notch in the wheel 78. That wheel is the locking-wheel or locking-plate; and it has in reality notches such as D all round it, at distances 2, 3, up to 12, from any given point in the circumference, which may be considered as marked off into 78 spaces, that being the number of blows struck in 12 hours. These notches are shown in the locking-plate of the quarter part in fig. 22, but not in the hour part, for want of size to show them distinctly.

When the arm AB of the lifting-piece is raised by the snail depressing the other end H, a few minutes before the hour, the fly-pin slips past the first of the stops at B, but is stopped by the second and lower one, until the lever is dropped again exactly at the hour. Thus the pin can pass, and would go once round, allowing the train to go on a little; but before it has got once round, AB has been lifted again high enough to carry both stops out of the way of the fly-pin, by means of the cylinder with two slices taken off it, which is set on the arbor of the wheel 90, and on which the end of the lifting-piece rests, with a small roller to diminish the friction. If the clock has only to strike one, the lifting-piece will then drop again, and the fly-pin will be caught by the first stop, having made (according to the numbers of the teeth given in fig. 22) 5 turns. But if it has to strike more, the locking-wheel comes into action. That wheel turns with the train, being either driven by pinion 20 on the arbor of the great wheel, or by a gathering pallet on the arbor of the second wheel, like G in fig. 15; and when once the lifting-piece is lifted out of a notch in the locking-plate, it cannot fall again until another notch has come under the bit D; and as the distance of the notches is proportioned to the hours, the locking-plate thus determines the number of blows struck. It may occur to the reader, that the cylinder 10 and roller are not really wanted, and that the locking-plate would do as well without; and sometimes clocks are so made, but it is not safe, for the motion of the locking-plate is so slow, that unless everything is very carefully adjusted and no *shakes* left, the corner of the notch may not have got fairly under the bit D before the fly has got once round, and then the lifting-piece will drop before the clock can strike at all; or it may hold on too long and strike 13, as St. Paul's clock did once at midnight, when it was heard at Windsor by a sentinel.

Small French clocks, which generally have the striking part made in this way, very commonly strike the half hours also, by having a wide slit, like that for one o'clock, in the locking-plate at every hour. But such clocks are unfit for any place except a room, as they strike one three times between 12 and 2, and accordingly turret clocks, or even large house clocks are never made so. Sir E. Beckett has lately introduced the plan of making turret clocks strike one at all the half hours except 12½ and 1½, so that any striking of one that is heard between 11½ and 2½ must needs be one o'clock. This is done by having a 12-hour

wheel driven by the going part, either continuously or by a gathering pallet moving that wheel only once an hour, and it has two high steps which come under another piece like D in the lifting detent a little before 12½ and 1½ so as to prevent it falling when let off by the snail. In the English or rack striking movement, to be presently described, the same thing may be done by a kind of star wheel with flat ends to the rays, attached to the 12-hour snail, which will let the rack fall enough to strike one at every half hour, but with two longer rays to prevent it falling at all at 12½ and 1½; or it would be better to let those rays, by means of an intervening lever, prevent the lifting piece from falling, as that would involve less friction of the tail of the rack.

In all cases the locking-plate must be considered as divided into as many parts as the number of blows to be struck in 12 hours, i. e., 78, 90, or 88, according as half hours are or are not struck; and it must have the same number of teeth, driven by a pinion on the striking wheel arbor of as many teeth as the striking cams, or in the same ratio.

Fig. 15 is a front view of a common English house clock with the face taken off, showing the repeating or rack striking movement. Here, as in fig. 1, M is the hour-wheel, on the pipe of which the minute hand is set, N the reversed hour-wheel, and n its pinion, driving the 12-hour wheel H, on whose socket is fixed what is called the snail Y, which belongs to the striking work exclusively. The hammer is raised by the eight pins in the rim of the second wheel in the striking train, in the manner which is obvious.

The hammer does not quite touch the bell, as it would jar in striking if it did, and prevent the full sound; and if you observe the form of the hammer-shank at the arbor where the spring S acts upon it, you will see that the spring both drives the hammer against the bell when the tail T is raised, and also checks it just before it reaches the bell, and so the blow on the bell is given by the hammer having acquired momentum enough to go a little farther than its place of rest. Sometimes two springs are used, one for impelling the hammer, and the other for checking it. A piece of vulcanized India-rubber, tied round the pillar just where the hammer-shank nearly touches it, forms as good a check spring as anything. But nothing will check the chattering of a heavy hammer, except making it lean forward so as to act, partially at least, by its weight. The pinion of the striking-wheel generally has eight leaves, the same number as the pins; and as a clock strikes 78 blows in 12 hours, the great wheel will turn in that time if it has 78 teeth instead of 96, which the great wheel of the going part has for a centre pinion of eight. The striking-wheel drives the wheel above it once round for each blow, and that wheel drives a fourth (in which you observe a single pin P), six, or any other integral number of turns, for one turn of its own, and that drives a fan-fly to moderate the velocity of the train by the resistance of the air, an expedient at least as old as De Vick's clock in 1370.

The wheel N is so adjusted that, within a few minutes of the hour, the pin in it raises the *lifting-piece*, LONF so far that that piece lifts the click C out of the teeth of the rack, BKRV, which immediately falls back (helped by a spring near the bottom) as far as its tail V can go by reason of the snail Y, against which it falls; and it is so arranged that the number of teeth which pass the click is proportionate to the depth of the snail; and as there is one step in the snail for each hour, and it goes round with the hour-hand, the rack always drops just as many teeth as the number of the hour to be struck. This drop makes the noise of "giving warning." But the clock is not yet ready to strike till the lifting-piece has fallen again; for, as soon as the rack was let off, the tail of the thing called the *gathering pallet* G, on the prolonged arbor of the third wheel, was enabled to pass the pin K of the rack on which it was pressing before, and the striking train began to move; but before the fourth wheel had got half round, its pin P was caught by the end of the lifting-piece, which is bent back and goes through a hole in the plate, and when raised stands in the way of the pin P, so that the train cannot go on till the lifting-piece drops, which it does exactly at the hour, by the pin N then slipping past it. Then the train is free; the striking wheel begins to lift the hammer, and the gathering pallet gathers up the

rack, a tooth for each blow, until it has returned to the place at which the pallet is stopped by the pin K coming under it. In this figure the lifting-piece is prolonged to F, where there is a string hung to it, as this is the proper place for such a string when it is wanted for the purpose of learning the hour in the dark, and not (as it is generally put) on the click C; for if it is put there and you hold the string a little too long, the clock will strike too many; and if the string accidentally sticks in the case, it will go on striking till it is run down; neither of which things can happen when the string is put on the lifting-piece.

The snail is sometimes set on a separate stud with the apparatus called a *star-wheel* and *jumper*; but as this only

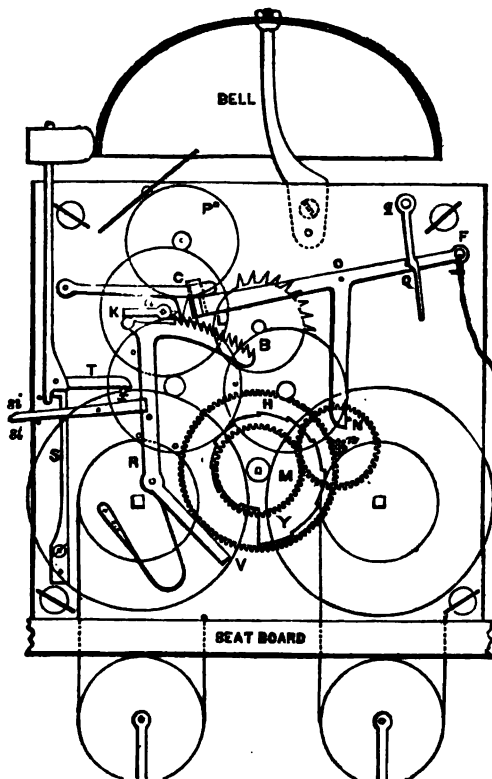

FIG. 15.—Front view of Common English House Clock.

increases the cost without any advantage that we can see, we omit any further reference to it. On the left side of the frame we have placed a lever *z*, with the letters *st* below it, and *st* above. If it is pushed up to *st*, the other end will come against a pin in the rack, and prevent it from falling, and will thus make the clock silent; and this is much more simple than the old-fashioned "strike and silent" apparatus, which we shall therefore not describe, especially as it is seldom used now.

If the clock is required to strike quarters, a third "part" or train of wheels is added on the right hand of the going part; and its general construction is the same as the hour-striking part; only there are two more bells, and two hammers so placed that one is raised a little after the other. If there are more quarter-bells than two, the hammers are generally raised by a chime-barrel, which is merely a cylinder set on the arbor of the striking-wheel (in that case generally the third in the train), with short pins stuck into it in the proper places to raise the hammers in the order required for the tune of the chimes. The quarters are usually made to let off the hour, and this connection may be made in two ways. If the chimes are different in tune for each quarter, and not merely the same tune repeated two, three, and four times, the repetition movement must not be used for them, as it would throw the tunes into confusion, but the old locking-plate movement, as in turret clocks; and therefore, if we conceive the hour lifting-piece connected with the quarter locking-plate, as it is with the wheel N, in fig. 15, it is evident that the pin will discharge the hour striking part as the fourth quarter finishes.

But where the repetition movement is required for the quarters, the matter is not quite so simple. The principle of it may shortly be described thus. The quarters themselves have a rack and snail, etc., just like the hours, except that the snail is fixed on one of the hour-wheels M or N, instead of on the twelve-hour wheel, and has only four steps in it. Now suppose the quarter-rack to be so placed that when it falls for the fourth quarter (its greatest drop), it falls against the hour lifting-piece somewhere between O and N, so as to raise it and the click C. Then the pin Q will be caught by the click Q<sub>g</sub>, and so the lifting-piece will remain up until all the teeth of the quarter-rack are gathered up; and as that is done, it may be made to disengage the click Q<sub>g</sub>, and so complete the letting off the hour striking part. This click Q<sub>g</sub> has no existence except where there are quarters.

These quarter clocks are sometimes made so as only to strike the quarters at the time when a string is pulled—as by a person in bed, just like repeating watches, which are rarely made now, on account of the difficulty of keeping in order such a complicated machine in such a small space. In this case, the act of pulling the string to make the clock strike winds up the quarter-barrel, which is that of a spring clock (not yet described), as far as it is allowed to be wound up by the position of a snail on the hour-wheel against which a lever is pulled, just as the tail of the common striking-rack falls against the snail on the twelve-hour wheel; and it is easy to see that the number of blows struck by the two quarter hammers may thus be made to depend upon the extent to which the spring that drives the train is wound up; and it may even be made to indicate half-quarters; for instance, if the snail has eight steps in it, the seventh of them may be just deep enough to let the two hammers strike three times, and the first of them once more, which would indicate  $7\frac{1}{2}$  minutes to the hour. It is generally so arranged that the hour is struck first, and the quarters afterwards.

#### Alarums.

In connection with these bedroom clocks we ought to mention *alarums*. Perhaps the best illustration of the mode of striking an alarm is to refer to either of the recoil escapements (figs. 3 and 4). If you suppose a short hammer instead of a long pendulum attached to the axis of the pallets, and the wheel to be driven with sufficient force, it will evidently swing the hammer rapidly backwards and forwards; and the position and length of the hammer head may be so adjusted as to strike a bell inside, first on one side and then on the other. Then as to the mode of letting off the alarm at the time required; if it was always to be let off at the same time, you would only have to set a pin in the twelve-hour wheel at the proper place to raise the lifting-piece which lets off the alarm at that time. But as you want it to be capable of alteration, this discharging pin must be set in another wheel (without teeth), which rides with a friction-spring on the socket of the twelve-hour wheel, with a small movable dial attached to it, having figures so arranged with reference to the pin that whatever figure is made to come to a small pointer, set as a tail to the hour hand, the alarm shall be let off at that hour. The letting off does not require the same apparatus as a common striking part, because an alarm has not to strike a definite number of blows, but to go on till it is run down; and therefore the lifting-piece is nothing but a lever with a stop or hook upon it, which, when it is dropped, takes hold of one of the alarm wheels, and lets them go while it is raised high enough to disengage it. You must of course not wind up an alarm till within twelve hours of the time when it is wanted to go off.

The *watchman's* or *tell-tale* clock may be seen in one of the lobbies of the House of Commons, and in prisons, and some other places where they want to make sure of a watchman being on the spot and awake all the night; it is a clock with a set of spikes, generally 48 or 96, sticking out all round the dial, and a handle somewhere in the case, by pulling which you can press in that one of the spikes which is opposite to it, or to some lever connected with it, for a few minutes; and it will be observed that this wheel of spikes is carried round with the hour-hand, which in these clocks is generally a twenty-four hour one. It is evident that every spike which is seen still sticking out in the morning indicates that at the particular time to which that spike belongs the watchman was not there to push it in—or at

any rate, that he did not; and hence its name. At some other part of their circuit, the inner ends of the pins are carried over a roller or an inclined plane which pushes them out again ready for business the next night.

#### SPRING CLOCKS.

Hitherto we have supposed all clocks to be kept going by a weight. But, as is well known, many of them are driven by a spring coiled up in a barrel. In this respect they differ nothing from watches, and therefore for consideration of the construction of parts belonging to the spring reference is made to the article WATCHES. It may, however, be mentioned here that the earliest form in which a spring seems to have been used was not that of a spiral ribbon of steel rolled up, but a straight stiff spring held fast to the clock frame at one end, and a string from the other end going round the barrel, which was wound up; but such a spring would have a very small range. Spring clocks are generally resorted to for the purpose of saving length; for as clocks are generally made in England, it is impossible to make a weight-clock capable of going a week, without either a case nearly 4 feet high, or else the weights so heavy as to produce a great pressure and friction on the arbor of the great wheel. But this arises from nothing but the heaviness of the wheels and the badness of the pinions used in most English clocks, as is amply proved by the fact that the American and Austrian clocks go a week with smaller weights and much less fall for them than the English ones, and the American ones with no assistance from fine workmanship for the purpose of diminishing friction, as they are remarkable for their want of what is called "finish" in the machinery, on which so much time and money is wasted in English clock-work.

All the ornamental French clocks, and all the short "dials," as those clocks are called which look no larger than the dial, or very little, and many of the American clocks, are made with springs. Indeed we might omit the word "French" after "ornamental" for the manufacture of ornamental clocks has practically ceased in England, and we are losing more of all branches of the horological trade yearly, as we are unable, *i. e.*, our workmen do not choose, to compete with the cheaper labor of the Continent, or with the much more systematic manufacture of clocks and watches by machinery in America than exists here, though labor there is much dearer. It is true that most of the American clocks are very bad, indeed no better than the old-fashioned Dutch clocks (really German) made most ingeniously of wood and wire, besides the wheels. But some better American ones are also made now, and they will no doubt improve as their machine-made watches have done. Though this has been going on now for 30 years and more, no steps appear to have been taken to establish anything of the kind in this country, except that watch "movements," which means only the wheels set in the frame, are to a certain extent made by machinery in Lancashire and Coventry for the trade, who finish them in London and elsewhere. That is the real meaning of the advertisements of "machine-made watches" here.

The French clocks have also been greatly improved within the same time, and are now, at least some of them, quite different both in construction and execution from the old-fashioned French drawing-room clock which generally goes worse than the cheapest "Dutchman," and is nearly always striking wrong, because they have the locking-plate striking work, which if once let to strike wrong, either by altering the hands or letting it run down, cannot be set right again except by striking the hours all round, which few people know how to do, even if they can get their fingers in behind the clock to do it. The Americans have a slight wire hanging down a little below the dial which you can push up and so make the clock strike. All locking-plate clocks ought to have a similar provision.

There is not much use in having clocks to go more than a little over eight days (to allow the possible forgetting of a day), as a week is the easiest period to remember. The French spring-clocks generally go a fortnight, but most people wind them up weekly. Occasionally English clocks are made to go a month by adding another wheel; and even a year by adding two. But in the latter case it is better to have two barrels and great wheels acting on opposite sides of a very strong pinion between them, as it both reduces

the strain on the teeth and the friction of the pivot of that pinion. Such clocks sometimes have a 5 feet or  $1\frac{1}{2}$  sec. pendulum, as the case must be a tall one. The great thing is to make the scape-wheel light, and even then you can never get more than a small arc of vibration, which is undesirable for the reason given above, and such a long train is peculiarly sensitive to friction.

In the American clocks the pinions are all of the kind called *lantern pinions*, which have their leaves made only of bits of wire set round the axis in two collars; and, oddly enough, they are the oldest form of pinion, as well as the best, acting with the least friction, and requiring the least accuracy in the wheels, but now universally disused in all English and French house clocks. The American clocks prove that they are not too expensive to be used with advantage when properly made; although, so long as there are no *manufactories* of clocks here as there are in America, it may be cheaper to make pinions in the slovenly way of cutting off all the ribs of a piece of pinion wire, so as to reduce it to a pinion a quarter of an inch wide, and an arbor 2 or 3 inches long. On the whole, the common English house clocks, so far from having improved with the general progress of machinery, are worse than they were fifty years ago, and at the same time are of such a price that they are being fast driven out of the market by the American plain clocks and by the French and German ornamental ones.

Clocks have been contrived to wind themselves up by the alternate expansion and contraction of mercury and other fluids under variations of temperature. Wind-mill clocks might be made still more easily, the wind winding up a weight occasionally. Water-clocks have also been made,—not on the clepsydra principle, where the flow of the water determined the time very inaccurately; but the water is merely the weight, flowing from a tap into a hollow horizontal axis, and thence by branches into buckets, which empty themselves as they pass the lowest point of the circle in which they move, or flowing directly into buckets, so emptying themselves. But the slopping of the water, and the rusting of any parts made of iron, and the cost of the water itself always running, destroy all chance of such things coming into use.

#### ELECTRICAL CLOCKS.

It should be understood that under this term two, or we may say three, very different things are comprehended. The first is a mere clock movement—*i. e.*, the works of a clock without either weight or pendulum—which is kept going by electrical connection with some other clock of any kind (these ought to be called *electrical dials*, not clocks); the second is a clock with a weight, but with the escapement worked by electrical connection with another clock instead of by a pendulum; and the third alone are truly *electrical clocks*, the motive power being electricity instead of gravity; for although they have a pendulum, which of course swings by the action of gravity, yet the requisite impulse for maintaining its vibrations against friction and resistance of the air is supplied by a galvanic battery, instead of by the winding up of a weight.

If you take the weight off a common recoil escapement clock, and work the pallets backward and forwards by hand, you will drive the hands round only the wrong way; consequently, if the escapement is reversed, and the pallets are driven by magnets alternatively made and unmade, by the well-known method of sending an electrical current through a wire coil set round a bar of soft iron, the contact being made at every beat of the pendulum of a standard clock, the clock without the weight will evidently keep exact time with the standard clock; and the only question is as to the best mode of making the contact, which is not so easy a matter as it appears to be, and though various plans apparently succeeded for a time, and were mechanically perfect, not one has succeeded permanently—*i. e.*, the contact sometimes fails to produce the current of sufficient strength to lift the weight or spring on which the driving of the subordinate clock depends. It is therefore unnecessary to repeat the description of the various contrivances for this purpose by Wheatstone and others.

The first person who succeeded in making one clock regulate or govern others by electricity, Mr. E. L. Jones, accordingly abandoned the idea of electrical driving of one clock by another; and instead of making the electrical connection with a standard clock (whether itself an electrical one or

not) drive the others, he makes it simply let the pallets or the pendulum of the subordinate clock, driven by a weight or spring, be influenced by attraction at every beat of the standard clock; and, by way of helping it, the pallets are made what we called half-dead in describing the dead escapement, except that they have no impulse faces, but the dead faces have just so much slope that they would overcome their own friction, and escape of themselves under the pressure of the clock train, except while they are held by the magnet, which is formed at every beat of the standard clock, or at every half-minute contact, if it is intended to work the dial by half-minute jumps. This plan has been extensively used for regulating distant clocks from Greenwich Observatory.

The first electrical clocks, in the proper sense of the term, were invented by Mr. Bain in 1840, who availed himself of the discovery of Oersted that a coil of insulated wire in the form of a hollow cylinder is attracted in one direction or the other by a permanent magnet within the coil, not touching it, when the ends of the coil are connected with the poles of a battery; and if the connection is reversed, or the poles changed, so that the current at one time goes one way through the coil from the - or copper plate to the + or zinc plate, and at other times the other way, the direction of the attraction is reversed. Mr. Bain made the bob of his pendulum of such a coil enclosed in a brass case so that it looked like a hollow brass cylinder lying horizontal and moving in the direction of its own

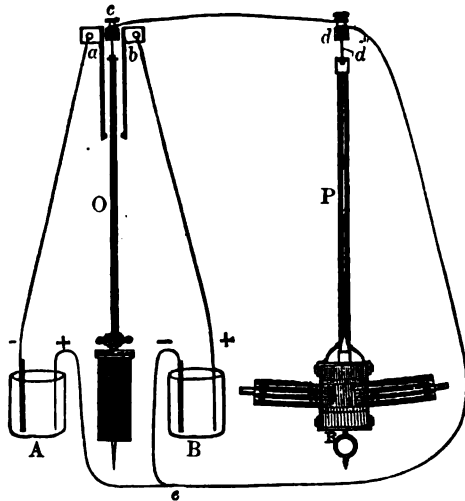

FIG. 16.—Bain's Pendulum.

axis, and in that axis stood the ends of two permanent magnets with the north poles pointed at each other and nearly touching, as in the right hand part of fig. 16. The pendulum pushed a small sliding bar backwards and forwards so as to reverse the current through the coil as the pendulum passed the middle of the arc, and so caused each magnet in turn to attract the bob. But this also failed practically, and especially in time-keeping, as might have been expected, from the friction and varying resistance of the bar to the motion of the pendulum, and in the attractions.

Mr. Ritchie of Edinburgh, however, has combined the principle of Bain's and Jones's clocks in a manner which is testified to be completely successful in enabling one standard clock to control and keep going any number of subordinate ones, which do not require winding up as Jones's do, but are driven entirely by their pendulums. This differs from Wheatstone's plan in this, that his subordinate clocks had no pendulum swinging naturally and only wanting its vibrations helping a little, but the pallets had to be made to vibrate solely by the electrical force. The figures are taken from Mr. Ritchie's paper read before the Royal Scottish Society of Arts in 1873. The controlled pendulum P is that just now described as Bain's (seen in fig. 17 the other way, across the plane of vibration); the rod and spring are double, and the wire *od* is connected with one spring and rod (say the front one) and

the wire *d'e* with the other; so that the current has to pass down one spring and one rod and through the coil in the bob and up the other spring.

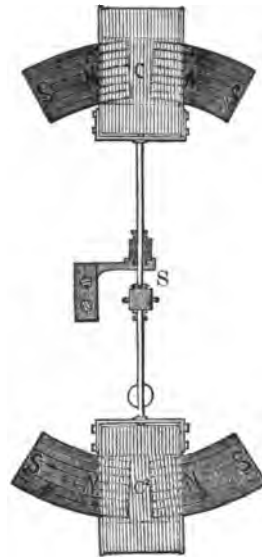

FIG. 17.—Ritchie's Pendulum.

weak, the natural swing of the pendulum will keep it going for a short time with force enough to drive its clock through a reversed escapement; and further, if that pendulum is naturally a little too fast or too slow the attraction from the standard pendulums will retard or accelerate it. In practice, however, it is found better not to make the contact by springs, which, however light, disturb the pendulum a little, but by a wheel in the train making and breaking contact at every beat; and if the clock has a gravity escapement there is no danger of this friction affecting the pendulum at all.



FIG. 18.—Ritchie's Elliptical Escapement.

In order to get the machinery into a smaller compass than a 39 inches pendulum requires, Mr. Ritchie uses a short and slow pendulum with two bobs, one above and the other below the suspension, as shown in fig. 17. Such a pendulum, like a common scale-beam, may be made to vibrate as slow as you like by bringing the suspension nearer to the centre of gravity of the whole mass. But they are quite unfit for independent clock pendulums, having very little regulating power, or what we may call force of vibration. He applies magnets to both the bobs, so as to double the electrical force. Fig. 17 is the section across the plane of vibration.

Fig. 18 shows the kind of reversed escapement, or "propellent," used with these short and slow pendulums. The pendulum here is returning from the extreme right, and has just deposited the right hand pallet BCD with its end D pressing on a tooth of the scape-wheel, but unable to turn it because another tooth is held by the stop G on the left pallet. As soon as the pendulum lifts that pallet the weight of the other pallet turns the wheel, until a tooth falls against the stop C. When the pendulum returns from the left the left pallet presses on a tooth at E but cannot turn the wheel because it is yet held by C, until that is released. In order to prevent the hands being

driven back by wind where they are exposed to it, a click is added to the teeth. The wind cannot drive the hands forward by reason of the stops C, G.

#### CHURCH AND TURRET CLOCKS.

Seeing that a clock—at least the going part of it—is a machine in which the only work to be done is the overcoming of its own friction and the resistance of the air, it is evident, that when the friction and resistance are much increased, it may become necessary to resort to expedients for neutralizing their effects which are not required in a smaller machine with less friction. In a turret clock the friction is enormously increased by the great weight of all the parts; and the resistance of the wind, and sometimes snow, to the motion of the hands, further aggravates the difficulty of maintaining a constant force on the pendulum; and besides that, there is the exposure of the clock to the dirt and dust which are always found in towers, and of the oil to a temperature which nearly or quite freezes it all through the usual cold of winter. This last circumstance alone will generally make the arc of the pendulum at least half a degree more in summer than in winter; and inasmuch as the time is materially affected by the force which arrives at the pendulum, as well as the friction on the pallets when it does arrive there, it is evidently impossible for any turret clock of the ordinary construction, especially with large dials, to keep any constant rate through the various changes of temperature, weather, and dirt, to which it is exposed.

Within the last twenty years all the best clock-makers have accordingly adopted the four-legged or three-legged gravity escapement for turret clocks above the smallest size; though inferior ones still persist in using the dead escapement, which is incapable of maintaining a constant rate under a variable state of friction, as has been shown before. When the Astronomer Royal in 1844 laid down the condition for the Westminster clock that it was not to vary more than a second a day, the London Company of Clockmakers pronounced it impossible, and the late Mr. Vulliamy, who had been for many years the best maker of large clocks, refused to tender for it at those terms. The introduction of the gravity escapement enabled the largest and coarsest looking clocks with cast-iron wheels and pinions to go for long periods with a variation much nearer a second a week than a second a day. And the consequence was that the price for large clocks was reduced to about one-third of what it used to be for an article inferior in performance though more showy in appearance.

Another great alteration, made by the French clockmakers before ours, was in the shape and construction of the frame. The old form of turret clock-frame was that of a large iron

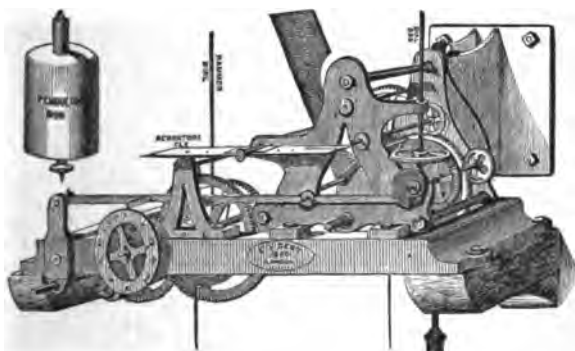

FIG. 19.—Clock at Meanwood Church, Leeds.

cage, of which some of the vertical bars take off, and are fitted with brass bushes for the pivots of the wheels to run in; and the wheels of each train, i. e., the striking, the going, and the quarter trains, have their pivots all in the vertical bar belonging to that part. Occasionally they advanced so far as to make the bushes movable, i. e., fixed with screws instead of rivetted in, so that one wheel may be taken out without the others. This cage generally stood upon a wooden stool on the floor of the clock room. The French clockmakers long ago saw the objections to this kind of arrangement, and adopted the plan of a hor-

izontal frame or bed, cast all in one piece, and with such smaller frames or cocks set upon it as might be required for such of the wheels as could not be conveniently got on the same level. The accompanying sketch (fig. 19) of the clock of Meanwood church, near Leeds, one of the first on that plan, will sufficiently explain it. All the wheels of the going part, except the great wheel, are set in a separate frame called the movement frame, which is complete in itself, and light enough to take off and carry away entire,

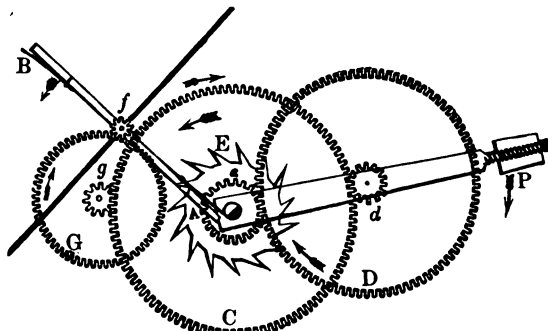

FIG. 20.—Gravity Train Remontoire.

so that any cleaning or repairs required in the most delicate part of the work can be done in the clock factory, and the great wheel, barrel, and rope need never be disturbed at all. Even this movement frame is now dispensed with; but we will reserve the description of the still more simple kind of frame in which all the wheels lie on or under the great horizontal bed, until we have described train remontoires.

#### Train Remontoires.

Although the importance of these is lessened by the invention of an effective gravity escapement, they are still occasionally used, and are an essential part of the theory of clock-making. It was long ago perceived that all the variations of force, except friction of the pallets, might be out off by making the force of the scape-wheel depend on a small weight or spring wound up at short intervals by the great clock weight and the train of wheels.

This also has the advantage of giving a sudden and visible motion to the minute hand at those intervals, say of half a minute, when the remontoire work is let off, so that time may be taken from the minute hand of a large public clock as exactly as from the seconds hand of an astronomical clock; and besides that, greater accuracy may be obtained in the letting off the striking part. We believe the first maker of a large clock with a train remontoire was Mr. Thomas Reid of Edinburgh, who wrote the article on clocks in the first edition of this *Encyclopædia*, which was afterwards expanded into a well-known book, in which his remontoire was described. The scape-wheel was driven by a small weight hung by a Huyghens's endless chain, of which one of the pulleys was fixed to the arbor, and the other rode upon the arbor, with the pinion attached to it, and the pinion was driven and the weight wound up by the wheel below (which we will call the third wheel), as follows. Assuming the scape-wheel to turn in a minute, its arbor has a notch out half through it on opposite sides in two places near to each other; on the arbor of the wheel, which turns in ten minutes, suppose, there is another wheel with 20 spikes sticking out of its rim, but alternately in two different planes, so that one set of spikes can only pass through one of the notches in the scape-wheel arbor, and the other set only through the other. Whenever, then, the scape-wheel completes a half turn, one spike is let go, and the third wheel is able to move, and with it the whole clock-train and the hands, until the next spike of the other set is stopped by the scape-wheel arbor; at the same time the pinion on that arbor is turned half round, winding up the remontoire weight, but without taking its pressure off the scape-wheel. Reid says that, so long as this apparatus was kept in good order, the clock went better than it did after it was removed in consequence of its getting out of order from the constant banging of the spikes against the arbor.

The Royal Exchange clock was at first made in 1844 on the same principle, except that, instead of the endless chain, an internal wheel was used, with the spikes set on it externally, which is one of the modes by which an occasional secondary motion may be given to a wheel without disturbing its primary and regular motion. A drawing of the original Exchange clock re-

remontoire is given in the *Rudimentary Treatise on Clocks*; but for the reasons which will appear presently, it need not be repeated here, especially as the following is a more simple arrangement of a gravity train remontoire, much more frequently used in principle. Let *E* in fig. 20 be the scape-wheel turning in a minute, and *e* its pinion, which is driven by the wheel *D* having a pinion *d* driven by the wheel *C*, which we may suppose to turn in an hour. The arbors of the scape-wheel and hour-wheel are distinct, their pivots meeting in a bush fixed somewhere between the wheels. The pivots of the wheel *D* are set in the frame *AP*, which rides on the arbors of the hour-wheel and scape-wheel, or on another short arbor between them. The hour-wheel also drives another wheel *G*, which again drives the pinion *f* on the arbor which carries the two arms *f A, f B*; and on the same arbor is set a fly with a ratchet, like a common striking fly, and the numbers of the teeth are so arranged that the fly will turn once for each turn of the scape-wheel. The ends of the remontoire arms *f A, f B* are capable of alternately passing the notches out half through the arbor of the scape-wheel, as those notches successively come into the proper position at the end of every half minute; as soon as that happens the hour-wheel raises the movable wheel *D* and its frame through a small angle; but nevertheless, that wheel keeps pressing on the scape-wheel as if it were not moving, the point of contact of the wheel *C* and the pinion *d* being the fulcrum or centre of motion of the lever *A d P*. It will be observed that the remontoire arms *f A, f B* have springs set on them to diminish the blow on the scape-wheel arbor, as it is desirable not to have the fly so large as to make the motion of the train, and consequently of the hands, too slow to be distinct. For the same reason it is not desirable to drive the fly by an endless screw, as was done in most of the French clocks on this principle in the 1851 Exhibition. There is also an enormous loss of force by friction in driving an endless screw, and consequently considerable risk of the clock stopping either from cold or from wasting of the oil.

Another kind of remontoire is on the principle of one bevelled wheel lying between two others at right angles to it. The first of the bevelled wheels is driven by the train, and the third is fixed to the arbor of the scape-wheel; and the intermediate bevelled wheel, of any size, rides on its arbor at right angles to the other two arbors which are in the same line. The scape-wheel will evidently turn with the same average velocity as the first bevelled wheel, though the intermediate one may move up and down at intervals. The transverse arbor which carries it is let off and lifted a little at half-minute intervals, as in the remontoire just now described; and it gradually works down as the scape-wheel turns under its pressure, until it is freed again and lifted by the clock train.

In all these gravity remontoires, however, it must have been observed that we only get rid of the friction of the heavy parts of the train and the dial-work, and that the scape-wheel is still subject to the friction of the remontoire wheels, which, though much less than the other, is still something considerable. And accordingly, attempts have frequently been made to drive the scape-wheel by a spiral spring, like the mainspring of a watch. One of these was described in the 7th edition of this *Encyclopædia*; and Sir G. Airy, a few years ago, invented another on the same principle, of which two or three specimens were made. But it was found, and indeed it ought to have been foreseen, that these contrivances were all defective in the mode of attaching the spring, by making another wheel or pinion ride on the arbor of the scape-wheel, which produced a very mischievous friction, and so only increased the expense of the clock without any corresponding advantage; and the consequence was that spring remontoires, and remontoires in general, had come to be regarded as a mere delusion. It has however now been fully proved that they are not so; for, by a very simple alteration of the previous plans, a spiral spring remontoire may be made to act with absolutely no friction, except that of the scape-wheel pivots, and the letting-off springs *A, B*, in the last drawing. The Meanwood clock (fig. 17) was the first of this kind; but it will be necessary to give a separate view of the remontoire work.

In the next figure (21), *A, B, D, E, e, f* are the same things as in fig. 20. But *e*, the scape-wheel pinion, is no longer fixed to the arbor, nor does it ride on the arbor, as had been the case in all the previous spring remontoires, thereby producing probably more friction than was saved in other respects; but it rides on a stud *k*, which is set in the clock-frame. On the face of the pinion is a plate, of which the only use is to carry a pin *h* (and consequently its shape is immaterial), and in front of the plate is set a bush *b*, with a hole through it, of which half is occupied by the end of the stud *k* to which the bush is fixed by a small pin, and the other half is the pivot-hole for the scape-wheel arbor. On the arbor is set the remontoire spring *e* (a moderate-sized musical-box spring is generally used) of which the outer end is bent into a loop to take hold of the pin *h*. In fact, there are two pins at *A*, one a little behind the other, to keep the coils of the spring from touching each other. Now, it is evident that the spring may be wound up half or a quarter of a turn at the proper intervals without taking the

force off the scape-wheel, and also without affecting it by any friction whatever. When the scape-wheel turns in a minute, the letting-off would be done as before described, by a couple of notches in the scape-wheel arbor, through which the spikes *A, B*, as in fig. 20, would pass alternately. But in clocks with only three wheels in the train it is best to make the scape-wheel turn in two minutes, and consequently you would want four notches and four remontoire arms, and the fly would only make a quarter of a turn. And therefore Sir E. Beckett, who invented this remontoire, made the following provision for diminishing the friction of the letting-off work. The fly pinion *f* has only half the number of teeth of the scape-wheel pinion, being a lantern pinion of 7 or 8, while the other is a leaved pinion of 14 or 16, and therefore the same wheel *D* will properly drive both, as will be seen hereafter. The scape-wheel arbor ends in a cylinder about  $\frac{1}{4}$  inch in diameter, with two notches at right angles out in its face, one of them narrow and deep, and the other broad and shallow, so that a long and thin pin *B* can pass only through one, and a broad and short pin *A* through the other. Consequently, at each quarter of a turn of the scape-wheel, the remontoire fly, on which the pins *A, B* are set on springs, as in fig. 20, can turn half round. It is set on

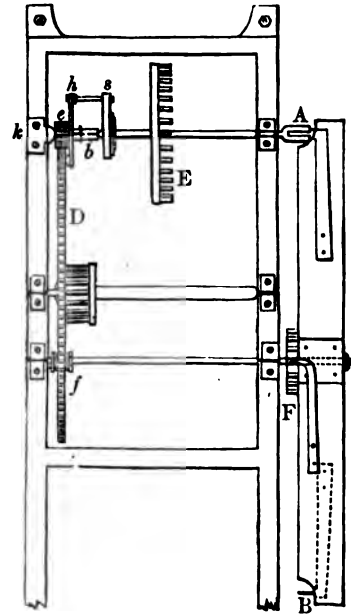

FIG. 21.

its arbor *f* by a square ratchet and click, which enables you to adjust the spring to the requisite tension to obtain the proper vibration of the pendulum. A better construction, afterwards introduced, is to make the fly separate from the letting-off arms, whereby the blow on the cylinder is diminished, the fly being allowed to go on as in the gravity escapement. The performance of this is so much more satisfactory than that of the gravity remontoires, that Mr. Dent altered that of the Royal Exchange to a spring one in 1854, which had the effect of reducing the clock-weight by one-third, besides improving the rate of going. It should be observed, however, that even a spring remontoire requires a larger weight than the same clock without one; but as none of that additional force reaches the pendulum, that is of no consequence. The variation of force of the remontoire spring from temperature, as it only affects the pendulum through the medium of the dead escapement, is far too small to produce any appreciable effect; and it is found that clocks of this kind, with a compensated pendulum 8 feet long, and of about 2 cwt., will not vary above a second a month, if the pallets are kept clean and well oiled. No turret clock without either a train remontoire or a gravity escapement will approach that degree of accuracy. The King's Cross clock, which was the first of this kind, went with a variation of about a second in three weeks in the 1851 Exhibition, and has sometimes gone for two months without any discoverable error, though it wants the jewelled pallets which the Exchange clock has. But these clocks require more care than gravity escapement ones, and are certain to be spoilt as soon as they get into ignorant or careless hands; and consequently the gravity ones have superseded them.

The introduction of this remontoire led to another very important alteration in the construction of large clocks. Hitherto it had always been considered necessary, with a view to dimin-



ish the friction as far as possible, to make the wheels of brass or gun-metal, with the teeth cut in an engine. The French clockmakers had begun to use cast-iron striking parts, and cast-iron wheels had been occasionally used in the going part of inferior clocks for the sake of cheapness; but they had never been used in any clock making pretensions to accuracy before the one just mentioned. In consequence of the success of that, it was determined by the astronomer royal and Mr. Denison, who were jointly consulted by the Board of Works about the great Westminster clock in 1852, to alter the original requisition for gun-metal wheels there to cast-iron. Some persons expressed their apprehension of iron wheels rusting; but nothing can be more unfounded, for the non-acting surfaces are always painted, and the acting surfaces oiled. A remarkable proof of the folly of the clockmakers' denunciations of the cast-iron wheels was afforded at the Royal Exchange the next year. In consequence of the bad ventilation of the clock-room, together with the effects of the London atmosphere, some thin parts of the brass work had become so much corroded that they had to be renewed, and some of it was replaced with iron; for all the polished iron and brass work had become as rough as if it had never been polished at all; the only parts of the clock which had not suffered from the damp and the bad air were the painted iron work. The room was also ventilated, with a draught through it, and all the iron work, except acting surfaces, painted. Even in the most favorable positions brass or gun-metal loses its surface long before cast-iron wants repainting.

There is, however, a curious point to be attended to in using cast-iron wheels. They must drive cast-iron pinions, for they

will wear out steel. The smaller wheels of the going part may be of brass driving steel pinions; but the whole of the striking wheels and pinions may be of iron. A great deal of nonsense is talked about gun-metal, as if it was necessarily superior to brass. The best gun-metal may be, and is, for wheels which are too thick to hammer; but there is great variety in the quality of gun-metal; it is often unsound, and has hard and soft places; and, on the whole, it has no advantage over good brass, when not too thick to be hammered. In clocks made under the pressure of competing tenders, if the brass is likely not to be hammered, the gun-metal is quite as likely to be the cheapest and the worst possible, like everything else which is always specified to be "best," as the clockmakers know very well that it is a hundred to one if anybody sees their work that can tell the difference between the best and the worst.

*Turret Clocks with Gravity Escapement.*

Fig. 22 is a front view of a large quarter clock of Sir E. Beckett's design, with all the wheels on the great horizontal bed, a gravity escapement, and a compensated pendulum. They are made in two sizes, one with the great striking wheels 18 inches wide, and the other 14. The striking is done by cams cast on the great wheels, about 1½ inch broad in the large-sized clocks, which are strong enough for an hour bell of thirty cwt., and corresponding quarters. Wire ropes are used, not only because they last longer, if kept greased, but because a sufficient number of coils will go on a barrel of less than half the length that would be required for hemp ropes of the same strength, without overlapping, which it is as well to avoid, if possible,

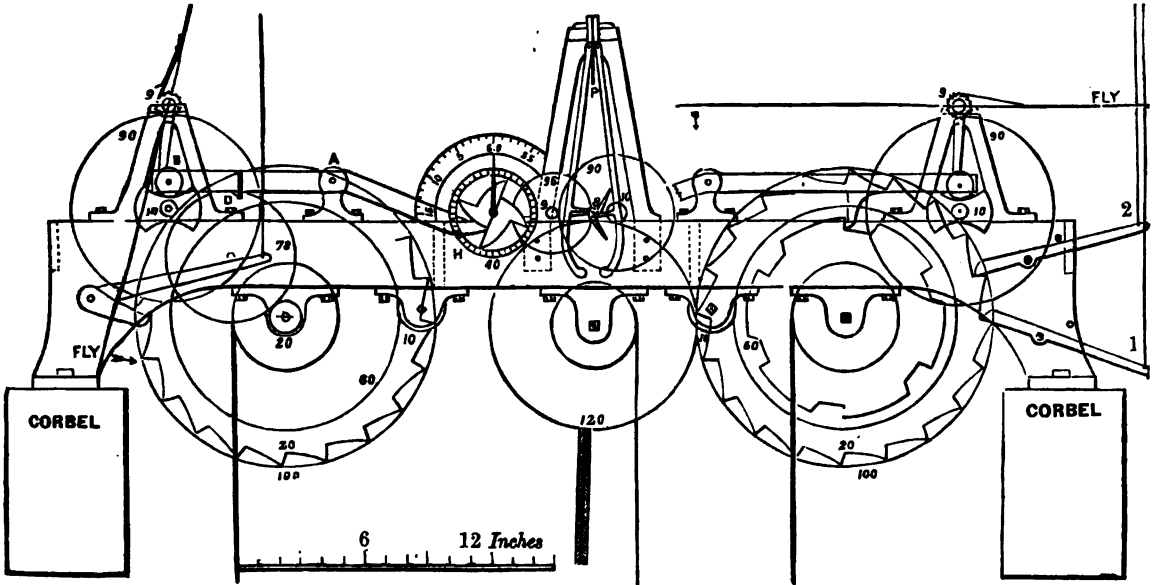

FIG. 22.—Front view of Turret Quarter Clock.

though it is not so injurious to wire ropes as it is to hemp ones. By this means also the striking cams can be put on the great wheel, instead of the second wheel, which saves more in friction than could be imagined by any one who had not tried both. In clocks of the common construction two-thirds of the power is often wasted in friction and in the bad arrangement of the hammer work, and the clock is wearing itself out in doing nothing.

The same number of cams are given here to the quarter as to the hour-striking wheel, rather for the purpose of suggesting the expediency of omitting the 4th quarter, as has been done in many clocks made from this design. It is of no use to strike ding-dong quarters at the hour, and it nearly doubles the work to be done; and if it is omitted it allows the bells to be larger, and therefore louder, because the 1st quarter bell ought to be an octave above the hour bell, if they are struck at the hour; whereas, if they are not heard together the quarters may be on the 4th and 7th of a peal of eight bells. Moreover, the repetition of the four ding-dongs can give no musical pleasure to any one.

The case is different with the Cambridge and Westminster quarter chimes on 4 bells, and the chime at the hour is the most complete and pleasing of all. It is singular that those beautiful chimes (which are partly attributed to Handel) had been heard by thousands of men scattered all over England for 70 years before any one thought of copying them, but since they were introduced by Sir E. Beckett in the great Westminster clock, on a much larger scale and with a slight difference in the intervals, they have been copied very extensively, and are already almost as numerous in new clocks as the old-fashioned

ding-dong quarters. Properly, as at Cambridge and Westminster, the hour bell should be an octave below the third (or largest but one) quarter bell; but as the interval between the quarters and hour is always considerable, it is practically found that the ear is not offended by a less interval. At Worcester cathedral the great 4½ ton hour bell is only 1½ notes below the 50 cwt. tenor bell of the peal, which is made the fourth quarter bell; and at some other places the quarters are the 2d, 3d, 4th, and 7th of a peal of 8, and the hour bell the 8th. Thereby you get more powerful and altogether better sounding quarters. The quarter bells are the 1st, 2d, 3d, and 6th of a peal of 6— independent of the hour bell; and the following is their arrangement:—

2d	{ 3126	} 4th
	{ 3218	
3d	{ 1326	
	{ 3213	} 1st
	{ 1236	
hour.....	10	

The interval between each successive chime of four should be two or at most two and a half times that between the successive blows. At Cambridge it is three times,—decidedly too slow; at Westminster twice, which is rather too fast; at Worcester cathedral and most of the later large clocks 2½ times, which sounds the best.

At Cambridge the chimes are set on a barrel which turns twice in the hour, as this table indicates, and which is driven

by the great wheel with a great waste of power; the clock is wound up every day. An eight-day clock would require a very heavy weight, and a very much greater strain on the wheels, and they are altogether inexpedient for these quarters on any large scale of bells.

Indeed there is some reason for doubting whether the modern introduction of eight-day clocks is an improvement, where they have to strike at all on large bells. Such clocks hardly ever bring the full sound out of the bells; because, in order to do so, the weights would have to be so heavy, and the clock so large, as to increase the price considerably. A good bell, even of the ordinary thickness, which is less than in the Westminster bells, requires a hammer of not less than  $\frac{1}{4}$ th of its weight, rising 8 or 9 inches from the bell, to bring out the full sound; and therefore, allowing for the loss by friction, a bell of 30 cwt., which is not an uncommon tenor for a large peal, would require a clock weight of 15 cwt., with a clear fall of 40 feet; and either the Cambridge quarters on a peal of ten, or the Doncaster ones on the 2d, 3d, 4th, and 7th bells of a peal of eight, would require above a ton, according to the usual scale of bells in a ringing peal (which is thinner than the Westminster clock bells). Very few clocks are adapted for such weights as these; and without abundance of strength and great size in all the parts, it would be unsafe to use them. But if the striking parts are made to wind up every day, of course  $\frac{1}{4}$ th of these weights will do; and you may have a more powerful clock in effect, and a safer one to manage, in half the compass, and for much less cost. Churches with such bells as these have always a sexton or some other person belonging to them, and in attendance every day, who can wind up the clock just as well as a clockmaker's man. The going part always requires a much lighter weight, and may as well go a week, and be in the charge of a clockmaker, where it is possible.

There should be some provision for holding the hammers off the bells while ringing, and at the same time a friction-spring or weight should be brought to bear on the fly arbor, to compensate for the removal of the weight of the hammers; otherwise there is a risk of the train running too fast and being broken when it is stopped.

No particular number of cams is required in the striking wheel; any number from 10 to 20 will do; but when four quarters on two bells are used, the quarter-striking wheel should have half as many cams again as the hour-wheel; for, if not, the rope will go a second time over half of the barrel, as there are 120 blows on each quarter bell in the 12 hours to 78 of the hours, while with the three quarters there are only 72. If the two quarter levers are on the same arbor, there must be two sets of cams, one on each side of the wheel; but one set will do, and the same wheel as the hour-wheel, if they are placed as in fig. 23. The hour-striking lever, it will be seen, is differently shaped, so as to diminish the pressure on its arbor by making it only the difference, instead of the sum, of the pressures at the two points of action. This can be done with the two quarter levers, as shown in the *Rudimentary Treatise*; but the arrangement involves a good deal of extra work, and as the quarter hammers are always lighter than the hour one, it is hardly worth while to resort to it. The shape of the cams is a matter requiring some attention, but it will be more properly considered when we come to the *teeth of wheels*. The 4th quarter bell in the Cambridge and Westminster quarters should have two hammers and sets of cams longer than the others, acting alternately, on account of the quick repetition of the blows.

The fly ratchets should not be made of cast-iron, as they sometimes are by clockmakers who will not use cast-iron wheels on any account, because the teeth get broken off by the click. This breaking may perhaps be avoided by making the teeth rectangular, like a number of inverted V's set round a circle, and the click only reaching so far that the face of the tooth which it touches is at right angles to the click; but, as before observed, cast-iron and steel do not work well together.

The hammer of a large clock ought to be left "on the lift," when the clock has done striking, if the first blow is to be struck exactly at the hour, as there are always a good many seconds lost in the train getting into action and raising the hammer. Moreover, when it stops on the lift, the pressure on the stops, and on all the pinions above the great wheel, is only that due to the excess of the power of the clock over the weight of the hammer, and not the full force of the weight, and it is therefore easier for the going part to discharge, and less likely to break the stops.

In fig. 22 the wheel marked 60 in each of the striking parts is a winding wheel on the front end of the barrel, and the winding pinion is numbered 10; a larger pinion will do where the hammer does not exceed 40 lb; and in small clocks no auxiliary winding wheel is needed. But in that case the locking-plate must be driven by a gathering pallet, or pinion with two teeth, on the arbor of the second wheel, with a spring click to keep it steady. In all cases the hammer shanks and tails should not be less than two feet long, if possible; for the shorter they are, the more is lost by the change of inclination for any given rise from the bell. In some clocks with fixed (not swinging) bells,

the hammer-head is set on a double shank embracing the bell, with the pivots, not above it in the French way, which makes the hammer strike at a wrong angle, but on each side of the bell, a little below the top. On this plan less of the rise is lost than in the common mode of fixing. The Westminster clock hammers are all fixed in this way.

The first thing to remark in the going part of fig. 22 is that the hour-wheel which carries the snails for letting off the quarters and striking is not part of the train leading up to the scape-wheel, but independent, so that the train from the great wheel to the scape-wheel is one of three wheels only. If it were a dead escapement, instead of a gravity escapement clock, the wheel numbered 96 would be the scape-wheel; and as it turns in 90 seconds, it would require 36 teeth or pins for a  $1\frac{1}{2}$  sec. pendulum which most of these gravity-escapement clocks have; it is about 6 feet long to the bottom of the bob, which, if sunk just below the floor, brings the clock-frame to a very convenient height. The hour-wheel rides loose on its arbor, or rather the arbor can turn within it, carrying the snails and the regulating hand and the bevelled wheel which drives all the dials, and it is fixed to the hour-wheel by means of clamping screws on the edge of a round plate on the arbor just behind it, which turn by hand. In a gravity escapement clock this adjusting work is not really necessary; because you can set the clock by merely lifting the pallets off the scape-wheel, and letting the train run till the hands point right. The regulating hand, you observe, in fig. 22 turns the wrong way; because, where the dial is opposite to the back of the clock, no bevelled wheels are wanted, and the arbor leads straight off to the dial. It used to be the fashion to put clocks in the middle of the room, so that the leading-off rod might go straight up to the horizontal bevelled wheel in the middle, which drove all the dials. But the clock can be set much more firmly on stone corbels, or on cast-iron brackets built into the wall; and it is not at all necessary for the leading-off rod to be vertical. Provided it is only in a vertical plane parallel to the wall, or the teeth of the bevelled wheels adapted to the inclination, the rod may stand as obliquely as you please; and when it does, it ought on no account to be made, as it generally is, with universal joints, but the pivots should go into oblique pivot-holes at the top and bottom. The joints increase the friction considerably, and are of no use whatever, except where the rod is too long to keep itself straight. Where the rod does happen to be in the middle of the room, and there are three or four dials, the two horizontal bevelled wheels at each end of it must be a little larger than all the others—both the one in the clock and those of the dial-work; for otherwise the three or four wheels in the middle will meet each other and stick fast.

When the pendulum is very long and heavy, it should be suspended from the wall, unless the clock-frame has some strong support near the middle; but a six-foot pendulum, of not more than two cwt., may be suspended from the clock-frame, provided it is as strong as it ought to be for the general construction of the clock, and supported on corbels or iron beams. It has generally been the practice to hang the pendulum behind the clock-frame; but inasmuch as the rope of the going part may always be thinner than that of the striking part, and that part requires less depth in other respects, a different and more compact plan is adopted in the clocks we are describing. The back pivots of the going wheels run in bushes in an intermediate bar, three or four inches from the back of the frame, joining the two cross bars, of which the ends are dotted in the drawing. The pendulum cock is set on the back frame, and the pendulum hangs within it. And in the gravity escapement clocks there is yet another thin bar—about half way between the back frame and the bar on which the bushes of the wheels are set—the only use of which is to carry the bush of the scape-wheel, which is set behind the fly; the wheel, the fly, and the pallets, or gravity-arms, stand between these two intermediate bars; and the pallet-arbors are set in a brass cock screwed to the top of the pendulum-cock. The beat-pins should be of brass, not steel, and no oil put to them, or they are sure to stick. The escapement in fig. 22 is not drawn rightly for the present form of them, which is given in fig. 13.

The same general arrangement will serve for a dead escapement clock with or without a train remontoire; only the pendulum will not stand so high, and the front end of the pallet arbor must be set in a cock like those of the striking dies, on the front bar of the frame. And for a dead escapement, if there are large dials and no remontoire, the pendulum should be longer and heavier than that which is quite sufficient for a gravity escapement. The rod of a wooden pendulum should be as thin as it can conveniently be made, and varnished, to prevent its absorbing moisture.

#### *Dials and Hands.*

The old established form of dial for turret clocks is a sheet of copper made convex, to preserve its shape; and this is just the worst form which could have been contrived for it. For, in the first place, the minute-hand, being necessarily outside of the hour-hand, is thrown still farther off the minutes to which

It has to point, by the convexity of the dial; and consequently, when it is in any position except nearly vertical, it is impossible to see accurately where it is pointing; and if it is bent enough to avoid this effect of parallax, it looks very ill. Secondly, a convex dial at a considerable height from the ground looks even more convex than it really is, because the lines of sight from the middle and the top of the dial make a smaller angle with the eye than the lines from the middle and the bottom, in proportion to the degree of convexity. The obvious remedy for these defects, is simply to make the dial concave instead of convex. As convex dials look more curved than they are, concave ones look less curved than they are, and in fact might easily be taken for flat ones, though the curvature is exactly the same as usual. Old convex dials are easily altered to concave, and the improvement is very striking where it has been done. There is no reason why the same form should not be adopted in stone, cement, slate, or cast-iron, of which materials dials are sometimes and properly enough made, with the middle part counter-sunk for the hour hand, so that the minute-hand may go close to the figures and avoid parallax. When dials are large, copper, or even iron or slate, is quite a useless expense, if the stonework is moderately smooth, as most kinds of stone take and retain paint very well, and the gilding will stand upon it better than it often does on copper or iron.

The figures are generally made much too large. People have a pattern dial painted; and if the figures are not as long as one-third of the radius, and therefore occupying, with the minutes, about two-thirds of the whole area of the dial, they fancy they are not large enough to be read at a distance; whereas the fact is, the more the dial is occupied by the figures, the less distinct they are, and the more difficult it is to distinguish the position of the hands, which is what people really want to see, and not to read the figures, which may very well be replaced by twelve large spots. The figures after all, do not mean what they say, as you read "twenty minutes to" something, when the minute-hand points to VIII. The rule which has been adopted, after various experiments, as the best for the proportions of the dial, is this. Divide the radius into three, and leave the inner two-thirds clear and flat, and of some color forming a strong contrast to the color of the hands, black or dark blue if they are gilt, and white if they are black. The figures, if there are any, should occupy the next two-thirds of the remaining third, and the minutes be set in the remainder, near the edge, and with every fifth minute more strongly marked than the rest; and there should not be a rim round the dial of the same color or gilding as the figures. The worst kind of dial of all are the things called skeleton-dials, which either have no middle except the stone-work, forming no contrast to the hands, or else taking special trouble to perplex the spectator by filling up the middle with radiating bars. Where a dial cannot be put without interfering with the architecture, it is much better to have none, as is the case in many cathedrals, and large churches, leaving the information to be given by the striking of the hours and quarters. This also will save something, perhaps a good deal, in the size and cost of the clock, and if it is one without a train remontoire or gravity escapement, will enable it to go better. The size of public dials is often very inadequate to their height and the distance at which they are intended to be seen. They ought to be at least 1 foot in diameter for every 10 feet of height above the ground, and more whenever the dial will be seen far off; and this rule ought to be enforced on architects, as they are often not aware of it; and indeed they seldom make proper provisions for the clock or the weights in building a tower, or, in short, know anything about the matter.

The art of illuminating dials cannot be said to be in a satisfactory state. Where there happens to be, as there seldom is, a projecting roof at some little distance below the dial, it may be illuminated by reflection, like that at the Horse Guards—about the only merit which that superstitiously venerated and bad clock has; and the same thing may be done in some places by movable lamp reflectors, like those put before shop windows at night, to be turned back against the wall during the day. It has also been proposed to sink the dial within the wall, and illuminate it by jets of gas pointing inwards from a kind of projecting rim, like what is called in church windows a "hood-moulding," carried all round. But it is a great objection to sunk dials, even of less depth than would be required here, that they do not receive light enough by day, and do not get their faces washed by the rain. The common mode of illumination is by making the dials, either entirely, or all except the figures and minutes and a ring to carry them, of glass, either ground or lined in the inside with linen (paint loses its color from the gas). The gas is kept always alight, but the clock is made to turn it nearly off and full on at the proper times by a 24-hour wheel, with pins set in it by hand as the length of the day varies. Self-acting apparatus has been applied, but it is somewhat complicated, and an unnecessary expense. But these dials always look very ill by day; and it seems often to be forgotten that dials are wanted much more by day than by night; and also, that the annual expense of lighting 3 or 4 dials far exceeds the interest of the entire cost of any ordinary clock. Sometimes it

exceeds the whole cost of the clock annually. The use of white opaque glass with black figures is very superior to the common method. It is used in the great Westminster clock dials. It is somewhat of an objection to illuminating large dials from the inside, that it makes it impossible to counterpoise the hands outside, except with very short, and therefore very heavy, counterpoises. And if hands are only counterpoised inside, there is no counterpoise at all to the force of the wind, which is then constantly tending to loosen them on the arbor, and that tendency is aggravated by the hand itself pressing on the arbor one way as it ascends, and the other way as it descends; and if a large hand once gets in the smallest degree loose, it becomes rapidly worse by the constant shaking. It is mentioned in Reid's book that the minute-hand of St. Paul's cathedral, which is above 8 feet long, used to fall over above a minute as it passed from the left to the right side of XII, before it was counterpoised outside. In the conditions to be followed in the Westminster clock it was expressly required that "the hands be counterpoised externally, for wind as well as weight." The long hand should be straight and plain, to distinguish it as much as possible from the hour hand, which should end in a "heart" or swell. Many clockmakers and architects, on the contrary, seem to aim at making the hands as like each other as they can; and it is not uncommon to see even the counterpoises gilt, probably with the same object of producing apparent symmetry and the same result of producing real confusion.

The old fashion of having chimes or tunes played by machinery on church bells at certain hours of the day has greatly revived in the last few years, and it has extended to town halls, as also that of having very large clock bells, which had almost become extinct until the making of the Westminster clock. The old kind of chime machinery consisted merely of a large wooden barrel about 2 feet in diameter with pins stuck in it like those of a musical box, which pulled down levers that lifted hammers on the bells. Generally there were several tunes "pricked" on the barrel, which had an endway motion acting automatically, so as to make a shift after each tune, and with a special adjustment by hand to make it play a psalm tune on Sundays. But though these tunes were very pleasing and popular in the places where such chimes existed they were generally feeble and irregular, because the pins and levers were not strong enough to lift hammers of sufficient weight for the large bells, and there were no means of regulating the time of dropping off the levers. Probably the last large chime work of this kind was that put up by Dent to play on 16 bells at the Royal Exchange in 1845, with the improvement of a cast-iron barrel and stronger pins than in the old wooden barrels.

A much improved chime machine has been introduced since, at first by an inventor named Imhoff, who sold his patent, or the right to use it, to Messrs. Gillett and Bland of Croydon, and also to Messrs. Lund and Blockley of Pall Mall, who have both added further improvements of their own. The principle of it is this: instead of the hammers being lifted by the pins which let them off, they are lifted whenever they are down by an independent set of cam wheels of ample strength; and all that the pins on the barrel have to do is to trip them up by a set of comparatively light levers or detents. Consequently the pins are as small as those of a barrel organ, and many more tunes can be set on the same barrel than in the old plan, and besides that, any number of barrels can be kept, and put in from time to time as you please; so that you may have as many tunes as the peal of bells will admit. There are various provisions for regulating and adjusting the time, and the machinery is altogether of a very perfect kind for its purpose, but it must be seen to be understood.

It is always necessary in chimes to have at least two hammers to each bell to enable a note to be repeated quickly. Some ambitious musicians determined to try "chords" or double notes struck at once, in spite of warning that they could not be made to strike quite simultaneously, and so it turned out, and it is useless to attempt them. The largest peals and chimes yet made have been at Worcester cathedral, and the town halls of Bradford and Rochdale, and a still larger one is now making for Manchester, all by Gillett and Bland. The clock at Worcester, which as yet ranks next to Westminster, was made by Mr. Joyce of Whitechurch; the others are by Gillett and Bland. At Boston church they have chimes in imitation of some of the foreign ones on above 40 small bells, which were added for that purpose to the eight of the peal; but they are not successful, and it is stated in Sir E. Beckett's book on clocks and bells, that he warned them that the large and small bells would not harmonize, though either might be used separately. Other persons have attempted chimes on hemispherical bells, like those of house clocks; but they also are a failure for external bells to be heard at a distance. This however belongs rather to the subject of bells; and we must refer to that book for all practical information about them.

#### TEETH OF WHEELS.

Before explaining the construction of the largest clock in the world it is necessary to consider the shape of wheel teeth suitable for different purposes, and also of the cams requisite to

raise heavy hammers, which had been too much neglected by clockmakers previously. At the same time we are not going to write a treatise on all the branches of the important subject of wheel-cutting; but, assuming a knowledge of the general principles of it, to apply them to the points chiefly involved in clock-making. The most comprehensive mathematical view of it is perhaps to be found in a paper by the astronomer royal in the *Cambridge Transactions* many years ago, which is further expanded in Professor Willis's *Principles of Mechanism*. Respecting the latter book, however, we should advise the reader to be content with the *mathematical* rules there given, which are very simple, without attending much to those of the *odontograph*, which seem to give not less but more trouble than the mathematical, and are only approximate after all, and also do not explain themselves, or convey any knowledge of the principle to those who use them.

For all wheels that are to work together, the first thing to do is to fix the *geometrical*, or *primitive*, or *pitch circles* of the two wheels, i.e., the two circles which, if they rolled perfectly together, would give the velocity-ratio you want. Draw a straight line joining the two centres; then the action which takes place between any two teeth as they are approaching that line is said to be before the line of centres; and the action while they are separating is said to be after the line of centres. Now, with a view to reduce the friction, it is essential to have as little action before the line of centres as you can; for if you make any rude sketch, on a large scale, of a pair of wheels acting together, and *serrate* the edges of the teeth (which is an exaggeration of the roughness which produces friction), you will see that the further the contact begins before the line of centres, the more the serration will interfere with the motion, and that at a certain distance no force whatever could drive the wheels, but would only jam the teeth faster; and you will see also that this cannot happen after the line of centres. But with pinions of the numbers generally used in clocks you cannot always get rid of action before the line of centres; for it may be proved (but the proof is too long to give here), that if a pinion has less than 11 leaves, no wheel of any number of teeth can drive it without some action before the line of centres. And generally it may be stated that the greater the number of teeth the less friction there will be, as indeed is evident enough from considering that if the teeth were infinite in number, and infinitesimal in size, there would be no friction at all, but simple rolling of one pitch circle on the other. And since in clock-work the wheels always drive the pinions, except the hour pinion in the dial work, and the winding pinions in large clocks, it has long been recognised as important to have high numbered pinions, except where there is a train remontre, or a gravity escapement, to obviate that necessity.

And with regard to this matter, the art of clock-making has in one sense retrograded; for the pinions which are now almost universally used in English and French clocks are of a worse form than those of several centuries ago, to which we have several times alluded under the name of *lantern pinions*, so called from their resembling a lantern with upright ribs. A sketch of one, with a cross section on a large scale, is given at fig. 24. Now it is a property of these pinions, that when they are driven, the action begins just when the centre of the pin is on the line of centres, however few the pins may be; and thus the action of a lantern pinion of 6 is about equal to that of a leaved pinion of 10; and indeed, for some reason or other, it appears in practice to be even better, possibly from the teeth of the wheel not requiring to be cut so accurately, and from the pinion never getting clogged with dirt. Certainly the running of the American clocks, which all have these pinions, is remarkably smooth, and they require a much smaller going weight than English clocks; and the same may be said of the common "Dutch," i.e., German clocks. It should be understood, however, that as the action upon these pinions is all after the line of centres when they are driven, it will be all before the line of centres if they drive, and therefore they are not suitable for that purpose. In some of the French clocks in the 1851 Exhibition they were wrongly used, not only for the train, but for winding pinions; and some of them also had the pins not fixed in the lantern, but rolling,—a very useless refinement, and considerably diminishing the strength of the pinion. For it is one of the advantages of lantern pinions with fixed pins, that they are very strong, and there is no risk of their being broken in hardening, as there is with common pinions.

The fundamental rule for the tracing of teeth, though very simple, is not so well known as it ought to be, and therefore we will give it, premising that so much of a tooth as lies within the pitch circle of the wheel is called its *root* or *flank*, and the part beyond the pitch circle is called the *point*, or the *curve*, or the *addendum*; and moreover, that before the line of centres the action is always between the flanks of the driver and the points of the driven wheel or *runner* (as it may be called, more appropriately than the usual term *follower*); and after the line of centres, the action is always between the points of the driver and the flanks of the runner. Consequently, if there is no action before the line of centres, no points are required for the teeth of the runner.

In fig. 23, let AQX be the pitch circle of the runner, and ARY that of the driver; and let GAP be any curve whatever of smaller curvature than AQX (of course a circle is always the kind of curve used); and QP the curve which is traced out by any point P in the generating circle GAP, as it rolls in the pitch circle AQX; and again let RP be the curve traced by the point P, as the generating circle GAP is rolled on the pitch circle ARY; then RP will be the form of the point of a tooth on the driver ARY, which will drive with uniform and proper motion the flank QP of the runner; though not without some friction, because that can only be done with *involute* teeth, which are traced in a different way, and are subject to other conditions, rendering them practically useless for machinery, as may be seen in Professor Willis's book. If the motion is reversed, so that the runner becomes the driver, then the flank QP is of the proper form to drive the point RP, if any action has to take place before the line of centres.

And again, any generating curve, not even necessarily the same as before, may be used to trace the flanks of the driver and the points of the runner, by being rolled within the circle ARY, and on the circle AQX.

Now then, to apply this rule to particular cases. Suppose the generating circle is the same as the pitch circle of the driven pinion itself, it evidently cannot roll at all; and the tooth of the pinion is represented by the mere point P on the circumference of the pitch circle; and the tooth to drive it will be simply an *epicycloid* traced by rolling the pitch circle of the pinion on that of the wheel. And we know that in that case there is no action before the line of centres, and no necessity for any flanks on the teeth of the driver. But inasmuch as the pins of a lantern pinion must have some thickness, and cannot be

mere lines, a further process is necessary to get the exact form of the teeth; thus if RP, fig. 24, is the tooth that would drive a pinion with pins of no sensible thickness, the tooth to drive a pin of the thickness 2 Pp must have the width Pp or Rr gauged off it all round. This, in fact, brings it very nearly to a smaller tooth traced with the same generating circle; and therefore in practice this mode of construction is not much adhered to, and the teeth are made of the same shape, only thinner, as if the pins of the pinion had no thickness. Of course they should be thin enough to allow a little shake, or "back-lash," but in clock-work the backs of the teeth never come in contact at all.

Next suppose the generating circle to be half the size of the pitch circle of the pinion. The curve, or *hypocycloid*, traced by rolling this within the pinion, is no other than the diameter of the pinion; and consequently the flanks of the pinion teeth will be merely radii of it, and such teeth or leaves are called *radial teeth*; and they are far the most common; indeed, no others are ever made (except lanterns) for clock-work. The corresponding epicycloidal points of the teeth of the driver are more curved, or a less pointed arc, than those required for

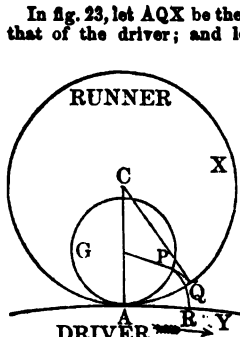

FIG. 23.

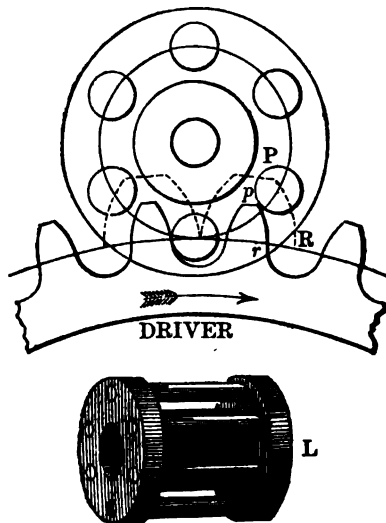

FIG. 24.—Lantern Pinion.

mere lines, a further process is necessary to get the exact form of the teeth; thus if RP, fig. 24, is the tooth that would drive a pinion with pins of no sensible thickness, the tooth to drive a pin of the thickness 2 Pp must have the width Pp or Rr gauged off it all round. This, in fact, brings it very nearly to a smaller tooth traced with the same generating circle; and therefore in practice this mode of construction is not much adhered to, and the teeth are made of the same shape, only thinner, as if the pins of the pinion had no thickness. Of course they should be thin enough to allow a little shake, or "back-lash," but in clock-work the backs of the teeth never come in contact at all.

Next suppose the generating circle to be half the size of the pitch circle of the pinion. The curve, or *hypocycloid*, traced by rolling this within the pinion, is no other than the diameter of the pinion; and consequently the flanks of the pinion teeth will be merely radii of it, and such teeth or leaves are called *radial teeth*; and they are far the most common; indeed, no others are ever made (except lanterns) for clock-work. The corresponding epicycloidal points of the teeth of the driver are more curved, or a less pointed arc, than those required for

lantern pinion of the same size and number. The teeth in fig. 25 are made of a different form on the opposite sides of the line of centres CA, in order to show the difference between driving and driven or running teeth, where the number of the pinion happens to be as much as 12, so that no points are required to its teeth when driven, since with that number all the action may be after the line of centres. The great Westminster clock affords a very good illustration of this. In both the striking parts the great wheel of the train and the great winding-wheel on the other end of the barrel are about the same size; but in the train the wheel drives, and in winding the pinion drives. And therefore in the train the pinion-teeth

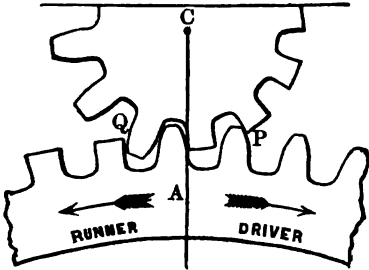

FIG. 25.

have their points out off, and wheel-teeth have their points on, as on the right side of fig. 25, and in the winding-wheels the converse; and thus in both cases the action is made to take place in the way in which there is the least friction. Willis gives the following table, "derived organically" (i. e., by actual trial with large models), of the least numbers which will work together without any action before the line of centres, provided there are no points to the teeth of the runner, assuming them to be radial teeth, as usual:

Driver .....	54	30	24	20	17	15	14	13	12	11	10	9	8	7	6
Runner .....	11	12	13	14	15	16	17	18	19	21	23	27	35	32	176

In practice it is hardly safe to leave the driven teeth without points, unless the numbers slightly exceed these; because, if there is any irregularity in them, the square edges of those teeth would not work smoothly with the teeth of the driver. Sometimes it happens that the same wheel has to drive two pinions of different numbers. It is evident that, if both are lanterns, or both pinions with radial teeth, they cannot properly be driven by the same wheel, because they would require teeth of a different shape. It is true that on account of the greater indifference of lantern pinions to the accuracy of the teeth which are to drive them, the same wheel will drive two pinions of that kind, differing in the numbers in the ratio of even 2 to 1, with hardly any sensible shake; but that would not be so with radial pinions, and of course it is not correct. Accordingly, in clocks with the spring remontoire, as in fig. 21, where the scape-wheel or remontoire pinion is double the size of the fly pinion, the larger one is made with radial teeth and the smaller a lantern, which makes the same wheel teeth exactly right for both. In clocks of the same construction as fig. 22, and in the Westminster clock, there is a case of a different kind, which cannot be so accommodated; for there the great wheel has to drive both the second wheel's pinion of 10 or 12, and the hour-wheel of 40 or 48; the teeth of the great wheel were therefore made to suit the lantern pinion, and those of the hour-wheel (i. e., their flanks) then depend on those of the great wheel, and they were accordingly traced by rolling a generating circle of the size of the lantern pinion on the inside of the pitch circle of the hour-wheel; the result is a tooth thicker at the bottom than usual. These are by no means unnecessary refinements; for if the teeth of a set of wheels are not properly shaped so as to work smoothly and regularly into each other, it increases their tendency to wear out in proportion to their inaccuracy, besides increasing the inequalities of force in the train. Sometimes turret clocks are worn out in a few years from the defects in their teeth, especially when they are made of brass or soft gun-metal.

In the construction of clocks which have to raise heavy hammers it is important to obtain the best form for the cams, as pins are quite unfit for the purpose. The conditions which are most important are—that the action should begin at the greatest advantage, and therefore at the end of the lever, that when it ceases the face of the lever should be a tangent to the cam at both their points, and that in no part of the motion should the end of the lever scrape on the cam. In the common construction of clocks the first condition is deviated from as far as possible, by the striking pins beginning to act at some distance from the end of the lever; and consequently, at the time when the most force is required to lift the hammer there is the least given, and a great deal is wasted afterwards.

The construction of curve for the cams, which is the most perfect mathematically, is that which is described in mathematical books under the name of the *tractrix*. But there are such practical difficulties in describing it that it is of no use. It should be observed that, in a well-known book with an appropriate name (*Camus on the Teeth of Wheels*), a rule for drawing cams has been inserted by some translator, which is quite wrong. It may be proved that epicycloidal cams described as follows are so nearly of the proper mathematical form that they may be used without any sensible error. Let  $r$  be the radius of the circle or barrel on which the cams are to be set theoretically, i. e., allowing nothing for the clearance which must be cut out afterwards, for fear the lever should scrape the back of the cams in falling; in other words,  $r$  is the radius of the pitch circle of the cams. Call the length of the lever  $l$ . Then the epicycloidal cams may be traced by rolling on the pitch circle a smaller one whose diameter is  $\sqrt{r^2 + l^2} - r$ . Thus, if  $l$  is 4 inches and  $r$  8 inches (which is about the proper size for an 18-inch striking wheel with 20 cams) the radius of the tracing circle from the cams will be 0.9 inch. The advantage of cams of this kind is that they waste as little force as possible in the lift, and keep the lever acting upon them as a tangent at its point the whole way; and the cams themselves may be of any length according to the angle through which you want the lever to move.

Most people, however, prefer dealing with circles, when they can, instead of epicycloids; and drawing by compasses is safer than calculating in most hands. We therefore give another rule, suggested by Mr. E. J. Lawrence, a member of the horological jury in the 1851 Exhibition, which is easier to work, and satisfies the principal conditions stated just now, though it wastes rather more in lift than the epicycloidal curve; and the cams must not have their points out off, as epicycloidal ones may, to make the lever drop off sooner; because a short cam has to be drawn with a different radius from a long one, to work a lever of any given length. But, on the other hand, the same curve for the cams will suit a lever of any length, whereas with epicycloidal cams you must take care to put the centre or axis of the lever at the exact distance from the centre of the wheel for which the curve was calculated—an easy enough thing to do, of course, but for the usual disposition of workmen to deviate from your plans, apparently for the mere pleasure of doing wrong. It is astonishing how, by continually making one machine after another, with a little deviation each time, the thing gradually assumes a form in which you can hardly recognize your original design at all. The prevention of this kind of blundering is one of the many advantages of making machines by machinery, for which no machine offers more facilities than clocks, and yet there is none to which it is less applied.

In fig. 26 let CA be a radius of the wheel, L in the same straight line the centre of the lever, and AB the space of one cam on the pitch circle of the cams, A being a little below the line of centres; AP is the arc of the lever. Draw a tangent to the two circles at A, and a tangent to the cam circle at B; then T, their point of intersection, will be the centre of the circle which is the face of the cam BP; and TB also = TA, which is a convenient test of the tangents being rightly drawn. The action begins at the point of the lever, and advances a little way up, but recedes again to the point, and ends with the lever as a tangent to the cam at P. The backs of the cams must be cut out rather deeper than the circle AP, but retaining the point P, to allow enough for clearance of the lever, which should fall against some fixed stop or banking, on the clock-frame, before

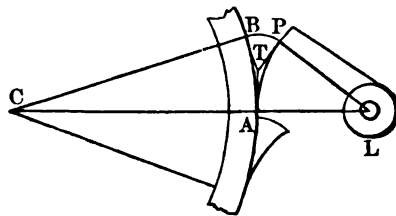

FIG. 26.

the next cam reaches it. The point of the lever must not be left quite sharp, for if it is, it will in time cut off the points of the cast-iron cams.

#### OIL FOR CLOCKS.

We will add a few words on the subject of oil for clocks. Olive-oil is most commonly used, sometimes purified in various ways, and sometimes not purified at all. We believe, however, that purified animal oil is better than any of the vegetable oils, as some of them are too thin, while others soon get thick and viscid. For turret clocks and common house clocks, good sperm oil is fine enough, and is probably the best. For finer work the oil requires some purification. Even common neat's foot oil may

be made fine and clear by the following method. Mix it with about the same quantity of water, and shake it in a large bottle, not full, until it becomes like a white soup; then let it stand till fine oil appears at the top, which may be skimmed off; it will take several months before it has all separated—into water at the bottom, dirt in the middle, and fine oil at the top. And it should be done in cold weather, because heat makes some oil come out as fine, which in cold would remain among the dirty oil in the middle, and in cold weather that fine oil of hot weather will become muddy. There are various vegetable oils sold at tool-shops as oil for watches, including some for which a prize medal was awarded in the Exhibition, but not by any of the mechanical juries; we have no information as to the test which was applied to it, and none but actual use for a considerable time would be of much value.

#### THE WESTMINSTER CLOCK.

It is unnecessary to repeat the account of the long dispute between the Government, the architect of the House of Parliament, the astronomer royal, Sir E. Beckett, and some of the London clock-makers, which ended in the employment of the late E. J. Dent and his successor F. Dent from the designs and under the superintendence of Sir E. Beckett, as the inscription on it records. The fullest account of these was given in the 4th and 5th editions of the *Treatise on Clocks*, and we shall now only describe its construction. Fig. 27 is a front elevation or section lengthwise of the clock. The frame is 16 feet long and 5½ wide, and it rests on two iron plates lying on the top of the walls of the shaft near the middle of the tower, down which the weights descend. That wall reaches up to the bell chamber, and those iron plates are built right through it, and so is the great cock

which carries the pendulum. The clock-room is 28 feet × 19, the remaining 9 of the square being occupied by the staircase and an air-shaft for ventilating the whole building.

The going part of the clock, however, not requiring such a long barrel as the striking parts, which have steel wire ropes ½ inch thick, is shorter than they are, and is carried by an intermediate bar or frame bolted to the cross bars of the principal frame. The back of them is about 2½ feet from the wall, to leave room for a man behind, and the pendulum clock is so made as to let his head come within it in order to look square at the escapement. The escapement is the double three legs (fig. 13), and the length of the teeth or legs is 6 inches. The drawing represents the wheels (except the bevelled wheels leading off to the dials) as mere circles to prevent confusion. The numbers of teeth and the time of revolution of the principal ones are inserted and require no further notice. Their size can be taken from the scale; the great wheels of the striking parts are 2½ and of the going part 2 inches thick, and all the wheels are of cast-iron except the smaller ones of the escapement, which are brass, but are painted like the iron ones.

The maintaining power for keeping the clock going while winding is peculiar and probably unique. None of those already described could have kept in gear long enough, maintaining sufficient force all the time, as that part takes 10 minutes to wind, even if the man does not loiter over it. This is managed without a single extra wheel beyond the ordinary winding pinion of large clocks. The winding wheel on the end of the barrel is close to the great wheel, and you see the pinion with the winding arbor in the oblique piece of the front frame of the clock. Consequently that arbor is about 6 feet long, and a little movement of its back end makes no material obliquity in

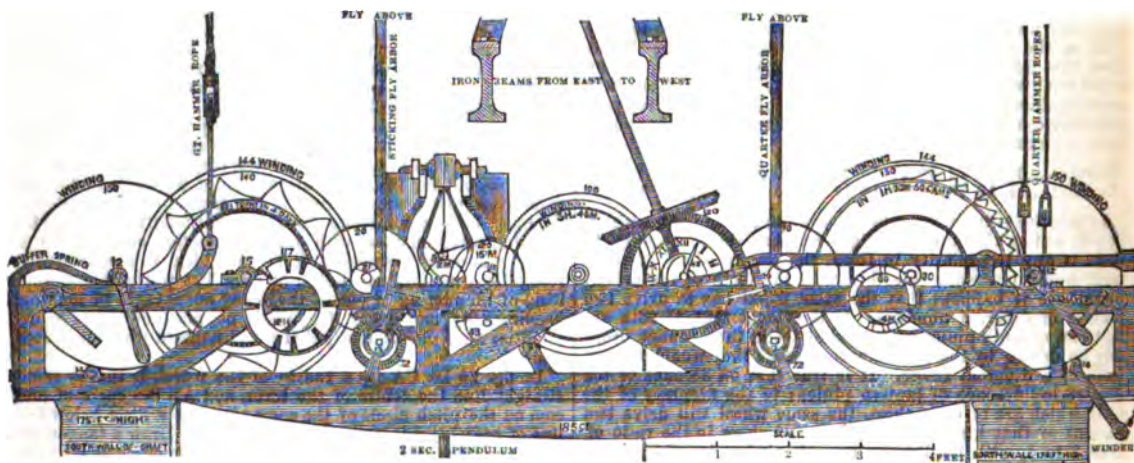

FIG. 27.—Section of Westminster Clock.

the two bushes; &c., it may go a little out of parallel with all the other arbors in the clock without any impediment to its action. Its back pivot is carried, not in a fixed bush, but in the lower end of a bar a little longer than the great wheel's radius, hanging from the back of the great arbor; and that bar has a spring click upon it which takes into ratchet teeth cast on the back of the great wheel. When the great wheel is turning, and you are not winding, the ratchets pass the click as usual, but as soon as you begin to wind the back end of the winding arbor would rise but for the click catching those teeth, and so the great wheel itself becomes the fulcrum for winding for the time. After the winding has gone a few minutes a long tooth projecting from the back of the arbor catches against a stop, because that end of the hanging bar and pinion have all risen a little with the motion of the great wheel. Then the man is obliged to turn the handle back a little, which lets down the pinion, &c., and the click takes up some lower teeth; and so if he chooses to loiter an hour over the winding he can do no harm. The winding pinion "pumps" into gear and out again as usual. The going part will go 8½ days, to provide for the possible forgetting of a day in winding. The weight is about 160lb; but only one-14th of the whole force of that weight is requisite to drive the pendulum, as was found by trial; the rest goes in overcoming the friction of all the machinery, including a ton and a half of hands and counterpoises, and in providing force enough to drive them through all weathers, except heavy snows, which occasionally accumulate thick enough on several minute hands at once, on the left side of the dials, to stop the clock, those hands being 11 feet long. For the dials are 22½ feet in diameter, or contain 400 square feet each, and there are very few rooms where such a dial could be painted on the floor. They are made of iron framing filled in with opal glass. Each minute is 14 inches wide. The only larger dial in the world is in

Mechlin church, which is 40 feet wide; but it has no minute hand, which makes an enormous difference in the force required in the clock. They are completely walled off from the clock-room by a passage all round, and there are a multitude of gas lights behind them, which are lighted by hand, though provision was originally made in the clock for doing it automatically. The hour hands go so slow that their weight is immaterial, and were left as they were made of gun metal under the architect's direction; but it was impossible to have minute hands of that construction and weight without injury to the clock, and so they were removed by Sir E. Beckett, and others made of copper tubes, with a section composed of two circular arcs put together, and are consequently very stiff, while weighing only 28lb. The great weight is in the wheels, tubes, and counterpoises. The minute hands are partly counterpoised outside, making their total length 14 feet, to relieve the strain upon their arbors. They all run on friction wheels imbedded in the larger tubes 5½ inches wide, which carry the hour hands, which themselves run on fixed friction wheels.

There is nothing peculiar in the quarter striking part except its size, and perhaps in the barrel turning in an hour and a half, &c., in three repetitions of the five chimes already described. The cams are of wrought iron with hard steel faces. Each bell has two hammers, which enables the cams to be longer and the pressure on them less. The hour-striking wheel has ten cams 2½ in. wide cast on it; but those cams have solid steel faces screwed on them. All this work was made for a hammer of 7 cwt., lifted 13 inches from the bell, &c., about 9 inches of vertical lift. The hammer was reduced to 4 cwt. after the partial cracking of the bell. The rod from the lever to the hammer is made of the same wire rope as the weight ropes, and the result is that there is no noise in the room while the clock is striking. The lever is 5 feet 4 inches long, and strikes

against the buffer spring shown in the drawing, to prevent concussion on the clock-frame, of which you cannot feel the least. The quarter hammer levers have smaller springs for the same purpose, and the stops of the striking part are also set on springs instead of rigid as usual. The flies, for which there was not room in the drawing, are near the top of the room and are each 3 feet 4 inches square. They make a considerable wind in the room when revolving. The only noise made in striking is their running on over their ratchets when the striking stops. Each striking-weight is a ton and a half—or was before the great hammer was reduced. They take 5 hours to wind up, and it has to be done twice a week, which was thought better than making the parts larger and the teeth more numerous and the weights twice as much, to go a week, and of course the winding must have taken twice as long, as it was adapted to what a man can do continuously for some hours. Consequently it was necessary to contrive something to stop the man winding just before each time of stiking. And that is done by a lever being tipped over by the snail at that time, which at once stops the winding. When the striking is done the man can put the lever up again and go on. The loose winding wheels are not pumped in and out of gear as usual, being too heavy, but one end of the arbor is pushed into gear by an eccentric bush turned by the oblique handle or lever which you see near the upper corner of each striking part, and they can be turned in a moment. They are held in their place for gear by a spring catch to prevent any risk of slipping out. Moreover the ropes themselves stop the winding when the weights come to the top, pretty much as they do in a spring clock or a watch, though not exactly.

The mode of letting off the hour striking is peculiar, with a view to the first blow of the hour being exactly at the 60th second of the 60th minute. It was found that this could not be depended on to a single beat of the pendulum, and probably it never can in any clock, by a mere small turning in an hour, unless it was of a very inconvenient size. Therefore the common snail only lets it off partially, and the striking stop still rests against a lever which is not dropped but tipped up with a slight blow by another weighted lever resting on a snail on the 15-minute wheel, which moves more exactly with the escapement than the common snail lower in the train. The hammer is left on the lift, ready to fall, and it always does fall within half a second after the last beat of the pendulum at the hour. This is shown in fig. 28, where BE is the spring stop noticed above, and P the ordinary first stop on the long lifting lever PQ (which goes on far beyond the reach of this figure to the hour snail). The second or warning stop is CD, and BAS is the extra lever with its heavy end at S on the 15-minute snail. When that falls the end B tips up CD with certainty by the blow, and then the striking is free. The first, second, and third quarters begin at the proper times; but the fourth quarter chimes begin about 20 seconds before the hour.

The clock reports its own rate to Greenwich Observatory by galvanic action twice a day, i. e., an electric circuit is made

used at Westminster, but was superseded by the gravity escapement.

The great hour bell, of the note E, weighs 13½ tons and is 9 feet diameter and 9 inches thick. The quarter bells weigh respectively 78, 33½, 26, and 21 cwt.; with diameters 6 feet, 4½, 4, and 3 feet 9 inches, and notes B, E, F sh. and G sh. The hammers are on double levers embracing the bells, and turning on pivots projecting from the iron collars which carry the mushroom-shaped tops of the bells. The bells, including £750 for recasting the first great bell, cost nearly £6000, and the clock £4080. The bell frame, which is of wrought iron plates, and the dials and hands, all provided by the architect, cost £11,924—a curious case of the accessories costing more than the principals. (x. s.)

CLOISTER (Latin, *claustrum*; French, *cloître*; Italian, *chiostro*; Spanish, *claustró*; German, *kloster*). The word "cloister," though now restricted to the four-sided enclosure, surrounded with covered ambulatories, usually attached to conventual and cathedral churches, and sometimes to colleges, or by a still further limitation to the ambulatories themselves, originally signified the entire monastery. In this sense it is of frequent occurrence in our earlier literature (e.g., Shakespeare, *Meas. for Meas.* i. 3, "This day my sister should the cloister enter"), and is still employed in poetry. The Latin *claustrum*, as its derivation implies, primarily denoted no more than the enclosing wall of a religious house, and then came to be used for the whole building enclosed within the wall. To this sense the German "kloster" is still limited, the covered walks, or cloister in the modern sense, being called "kloster-gang," or "kreuz-gang." In French, as with us, the word *cloître* retains the double sense.

In the special sense now most common, the word "cloister" denotes the quadrilateral area in a monastery or college of canons, round which the principal buildings are ranged, and which is usually provided with a covered way or ambulatory running all round, and affording a means of communication between the various centres of the ecclesiastical life, without exposure to the weather. According to the Benedictine arrangement, which from its suitability to the requirements of monastic life was generally adopted in the West, one side of the cloister was formed by the church, the refectory occupying the side opposite to it, that the worshippers might have the least annoyance from the noise or smell of the repasts. On the eastern side the chapter-house was placed, with other apartments belonging to the common life of the brethren adjacent to it, and, as a common rule, the dormitory occupied the whole of the upper story. On the opposite or western side were generally the cellarer's lodgings, with the cellars and store-houses, in which the provisions necessary for the sustenance of the confraternity were housed. In Cistercian monasteries the western side was usually occupied by the "domus conversorum," or lodgings of the lay brethren, with their day-rooms and workshops below, and dormitory above. The cloister, with its surrounding buildings, generally stood on the south side of the church, to secure as much sunshine as possible. A very early example of this disposition is seen in the plan of the monastery of St. Gall (ABBWY, vol. i. p. 18). Local requirements, in some instances, caused the cloister to be placed to the north of the church. This is the case in the English cathedrals, formerly Benedictine abbeys, of Canterbury, Gloucester, and Chester, as well as in that of Lincoln. Other examples of the northward situation are at Tintern, Buildwas, and Sherborne. Although the covered ambulatories are absolutely essential to the completeness of a monastic cloister, a chief object of which was to enable the inmates to pass from one part of the monastery to another without inconvenience from rain, wind, or sun, it appears that they were sometimes wanting. The cloister at St. Alban's seems to have been deficient in ambulatories till the abbacy of Robert of Gorham, 1151-1166, when the eastern walk was erected. This, as was often the case with the earliest ambulatories, was of wood covered with a pentice roof. We learn from Osborn's account of the conflagration of the monastery of Christ Church, Canterbury, 1067, that a cloister with covered ways existed at that time, affording communication between the church, the dormitory, and the refectory. We learn from an early drawing of the monastery of Canterbury that this cloister was formed by an arcade of Norman arches supported on shafts, and covered by a shed roof. A fragment of an arcaded cloister of this pattern is still found on the eastern side of the infirmary-cloister of the

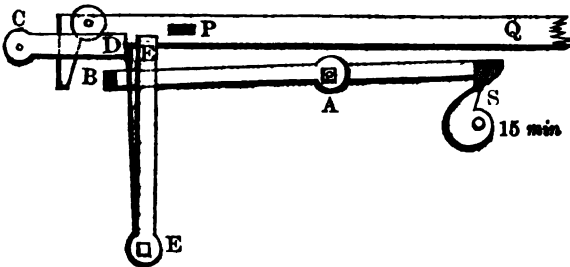

FIG. 28.

and broken by the pressing together of certain springs at two given hours. And in this way the rate of the clock is ascertained and recorded, and the general results published by the astronomer royal in his annual report. This has been for some years so remarkably uniform, that the error has only reached 3 seconds on 3 per cent. of the days in the year, and is generally under two. He has also reported that "the rate of the clock is certain to much less than a second a week"—subject to abnormal disturbances by thunder storms which sometimes amount to seven or eight seconds, and other casualties, which are easily distinguishable from the spontaneous variations. The original stipulation in 1845 was that the rate should not vary more than a second a day—not a week; and this was pronounced impossible by Mr. Valliam and the London Company of Clockmakers, and it is true that up to that time no such rate had ever been attained by any large clock. In 1851 it was by the above-mentioned clock, now at King's Cross Station, by means of the train remontoire, which was then intended to be

same foundation. This earlier form of cloister has been generally superseded with us by a range of windows, usually unglazed, but sometimes, as at Gloucester, provided with glass, lighting a vaulted ambulatory, of which the cloisters of Westminster Abbey, Salisbury, and Norwich are typical examples. The older design was preserved in the South, where "the cloister is never a window, or anything in the least approaching to it in design, but a range of small elegant pillars, sometimes single, sometimes coupled, and supporting arches of a light and elegant design, all the features being of a character suited to the place where they are used, and to that only" (Fergusson, *Hist. of Arch.*, i. p. 610). As examples of this description of cloister, we may refer to the exquisite cloisters of St. John Lateran, and St. Paul's without the walls, at Rome, where the coupled shafts and arches are richly ornamented with ribbons of mosaic, and those of the convent of St. Scholastica at Subiaco, all of the 13th century, and to the beautiful cloisters at Arles, in southern France, "than which no building in this style, perhaps, has been so often drawn or so much admired" (Fergusson); and those of Aix, Fontfroide, Elne, &c., are of the same type; as also the Romanesque cloisters at Zurich, where the design suffers from the deep abacus having only a single slender shaft to support it, and at Laach, where the quadrangle occupies the place of the "atrium" of the early basilicas at the west end, as at St. Clement's at Rome, and St. Ambrose at Milan. Spain also presents some magnificent cloisters of both types, of which that of the royal convent of Huelgas, near Burgos, of the arcaded form, is, according to Mr. Fergusson, "unrivalled for beauty both of detail and design, and is perhaps unsurpassed by anything in its age and style in any part of Europe." Few cloisters are more beautiful than those of Monreale and Cefalu in Sicily, where the arrangement is the same, of slender columns in pairs with capitals of elaborate foliage supporting pointed arches of great elegance of form.

All other cloisters are surpassed in dimensions and in sumptuousness of decoration by the "Campo Santo," at Pisa. This magnificent cloister consists of four ambulatories as wide and lofty as the nave of a church erected in 1278 by Giovanni Pisano round a cemetery composed of soil brought from Palestine by Archbishop Lanfranchi in the middle of the 12th century. The window openings are semicircular, filled with elaborate tracery in the latter half of the 15th century. The inner walls are covered with frescoes invaluable in the history of art by Orgagna, Simone Memmi, Buffalmacco, Benozzo Gozzoli, and other early painters of the Florentine school. The ambulatories now serve as a museum of sculpture. The internal dimensions are 415 feet 6 inches in length, 137 feet 10 inches in breadth, while each ambulatory is 34 feet 6 inches wide by 48 feet high.

The cloister of a religious house was the scene of a large part of the life of the inmates of a monastery. When not in church, refectory, or dormitory, or engaged in manual labor, the monks were usually to be found here. The north walk of the cloister of St. Gall appears to have served as the chapter-house. The cloister was the place of education for the younger members, and of study for the elders. A canon of the Roman council held under Eugenius II., in 826, enjoins the erection of a cloister as an essential portion of an ecclesiastical establishment for the better discipline and instruction of the clerks. Peter of Blois (*Serm.* 25) describes schools for the novices as being in the west walk, and moral lectures delivered in that next the church. At Canterbury the monks' school was in the western ambulatory, and it was in the same walk that the novices were taught at Durham (Willis, *Monastic Buildings of Canterbury*, p. 44; *Rites of Durham*, p. 71). The other alleys, especially that next the church, were devoted to the studies of the elder monks. The constitutions of Hildemar and Dunstan enact that between the services of the church the brethren should sit in the cloister and read theology. For this purpose small studies, known as *carrols*, from their square shape, were often found in the recesses of the windows. Of this arrangement we have examples at Gloucester, Chester (recently restored), and elsewhere. The use of these studies is thus described in the *Rites of Durham*:—"In every wyndowe" in the north alley "were iii pewes or carrolls, where every one of the olde monkes had his carrell severally by himselfe, that when they had dynded they dyd resorte to that place of cloister, and

there studied upon their books, every one in his carrell all the afternonne unto evensong tyme. This was there exercise every daie." On the opposite wall were cupboards full of books for the use of the students in the carrols. The cloister arrangements at Canterbury were similar to those just described. New studies were made by Prior De Estria in 1317, and Prior Selling (1472-94) glazed the south alley for the use of the studious brethren, and constructed "the new framed contrivances, of late styled carrol" (Willis, *Mon. Buildings*, p. 45). The cloisters were used not for study only but also for recreation. The constitutions of Archbishop Lanfranc, sect. 3, permitted the brethren to converse together there at certain hours of the day. To maintain necessary discipline a special officer was appointed under the title of *prior claustrari*. The cloister was always furnished with a stone bench running along the side. It was also provided with a lavatory, usually adjacent to the refectory, but sometimes standing in the central area, termed the cloister-garth, as at Durham. The cloister-garth was used as a place of sepulture, as well as the surrounding alleys. The cloister was in some few instances of two stories, as at Old St. Paul's and St. Stephen's Chapel, Westminster, and occasionally, as at Wells, Chichester, and Hereford, had only three alleys, there being no ambulatory under the church wall.

The larger monastic establishments had more than one cloister; there was usually a second connected with the infirmary, of which we have examples at Westminster Abbey and at Canterbury; and sometimes one giving access to the kitchen and other domestic offices.

The cloister was not an appendage of monastic houses exclusively. We find it also attached to colleges of secular canons, as at the cathedrals of Lincoln, Salisbury, Wells, Hereford, and Chichester, and formerly at St. Paul's and Exeter. It is, however, absent at York, Lichfield, Beverley, Ripon, Southwell, and Wimborne. A cloister forms an essential part of the colleges of Eton and of St. Mary's, Winchester, and New and Magdalen at Oxford, and was designed by Wolsey at Christ Church. These were used for religious processions and lectures, for ambulatories for the studious at all times, and for places of exercise for the inmates generally in wet weather, as well as in some instances for sepulture.

For the arrangements of the Carthusian cloisters, as well as for some account of those appended to the monasteries of the East, see the article ABBEY. (E. V.)

CLONMEL, a parliamentary and municipal borough of Ireland, in the province of Munster, partly in the south riding of Tipperary and partly in Waterford county, 104 miles south-west from Dublin. It is built on both sides of the Suir, and also occupies Moore and Long Islands, which are connected with the mainland by three bridges. The principal buildings are the parish church, two Roman Catholic churches, a Franciscan friary, two convents, an endowed school dating from 1685, a model school under the national board, a mechanics' institute, a court-house and prison, a fever hospital and dispensary, two lunatic asylums, a market-house, a workhouse, and barracks. Till the Union the woollen manufacture established in 1667 was extensively carried on. The town contains a brewery, flour-mills, and tanneries, publishes two newspapers, and has a considerable export trade in grain, cattle, butter, and provisions. The river is navigable for barges of 60 tons to Waterford. Clonmel is a station on the Waterford and Limerick Railway, and the centre of a system, established by Mr. Bianconi, for the conveyance of travellers on light cars, extending over a great part of Leinster, Munster, and Connaught. It is governed by a corporation, consisting of a mayor, free burgesses, and a commonalty, and returns one member to parliament. Population in 1851, 15,203; in 1871, 10,112.

Clonmel, or *Cluain mealla*, the Vale of Honey, is a place of undoubted antiquity. In 1269 it was chosen as the seat of a Franciscan friary by Otho de Grandison, the first English possessor of the district; and it frequently comes into notice in the following centuries. In 1641 it declared for the Roman Catholic party, and in 1650 it was gallantly defended by Hugh O'Neal against the English under Cromwell. Compelled at last to capitulate, it was completely dismantled, and has never again been fortified. Sterne was born in the town in 1713.

CLOOTZ, JEAN BAPTISTE, BARON (1755-1794), better known as Anacharsis Clootz, was born near Cleves. A baron by descent, and heir to a great fortune, he was sent



at eleven to Paris to complete his education. There he imbibed the theories of his uncle, Cornelius de Pauw, and of the great anarchists of the epoch. He rejected his title and his baptismal names, adopted the pseudonym of Anarcharis from the famous philosophical romance of Abbé Barthélemy, and traversed Europe, preaching the new ideas as an apostle, and spending his money as a man of pleasure. On the breaking out of the Revolution he returned in 1789 to Paris. In the exercise of the function he assumed of "Orator of the Human Race," he demanded at the bar of the National Assembly a share in the federation for all nations, presenting at the same time a petition against the despots of the world. In 1792 he placed 12,000 livres at the disposal of the Republic—"for the arming of forty or fifty fighters in the sacred cause of man against tyrant." The 10th of August impelled him to a still higher flight; he declared himself the personal enemy of Jesus Christ, abjured all revealed religions, and commenced preaching materialism. In the same month he had the rights of citizenship conferred on him; and having in September been elected a member of the Convention, he voted the king's death in the name of the human race. Excluded at the instance of Robespierre from the Jacobin Club, he was soon afterwards implicated in an accusation levelled against Hébert and others. His innocence was manifest, but he was condemned and put to death.

Cloutz left several works in which his extravagances are developed with much solemnity. The principal of these are *La Certitude des Preuves du Mahométisme*, *L'Orateur du Genre Humain*, and *La République Universelle*.

CLOT, ANTOINE (1795-1868), was born in the neighborhood of Marseilles, and was brought up at the charity school of that town. After studying at Montpellier he commenced to practice as surgeon in his native place; but at the age of twenty-eight he was made chief surgeon to Mehemet Ali, viceroy of Egypt. At Abuzabel, near Cairo, he founded a hospital and schools for all branches of medical instruction, as well as for the study of the French language; and, notwithstanding the most serious religious difficulties, he prevailed on some of the Arabs to study anatomy by means of dissection. In 1832 Mehemet Ali gave him the dignity of bey without requiring him to abjure his religion; and in 1836 he received the rank of general, and was appointed head of the medical administration of the country. In 1849 he returned to Marseilles. Clot published—*Relation des épidémies de cholera qui ont régné à P.Héggius, à Suez, et en Egypte* (1832); *De la peste observée en Egypte* (1840); *Aperçu général sur l'Egypte* (1840); *Ouvr d'œil sur la peste et les quarantaines* (1851); *De l'ophtalmie* (1864).

CLOTILDA, SAINT (475-545), was the daughter of Chilperic, king of Burgundy, and the wife of Clovis, king of the Franks. Her father, mother, and brothers were put to death by Gundebald, her uncle, but Clotilda was spared and educated. Gundebald opposed her marriage with Clovis, but by the aid of the clergy she escaped to the Frankish court (493), was married, and, having adhered all along to the pure Catholic faith of her mother, effected the conversion of Clovis to Christianity (496). He lost no time in avenging the murder of his wife's parents; Gundebald was defeated, and became his tributary. After her husband's death Clotilda persuaded her three sons—Clodomir, Childebert, and Clotaire—to renew the quarrel, and to visit on Sigismund, Gundebald's son, his father's crime. The war which followed resulted in the union of Burgundy to the Frank empire. Clotilda retired to Tours, and practised there the austerities of a devout life till her death. She was buried in the Parisian church of St. Geneviève, which Clovis had built, and was canonized a few years afterwards by Pelagius I. Her remains, preserved till the Revolution, were burned at that period by the devout Abbé Rousselet, who dreaded their desecration; the ashes are now in the little church of St. Leu. A statue of her adorns the Luxembourg, and a splendid church has recently been erected in her honor in Paris, not far from the spot where her bones rested during so many centuries. See FRANCE.

CLOUGH, ARTHUR HUGH (1819-1861), a minor English poet, was born at Liverpool in 1819, and belonged to a family of old Welsh descent. His father, a cotton merchant, having removed to the United States about 1823, Arthur spent a number of years at home in Charleston; but in 1828 he was brought back to England and sent to school. From Rugby, where he was a favorite pupil of Dr. Ar-

nold's, he passed in 1836 to Oxford; and there, in spite of an almost unaccountable failure in some of his examinations, he attained a high reputation for scholarship, ability, and character. In 1842 he was chosen fellow of Oriel, and in 1843 appointed tutor in the same college; but he soon grew dissatisfied with his position, and ultimately decided that it was his duty to resign. Under the influence of the great religious fermentation which had been going on during his university career, he had become deeply skeptical in his habits of thought; and all connection seemed impossible with a system that interfered with the liberty of speculative investigation. After his resignation in 1848 he was for some time principal of University Hall, London. In 1852 he visited America, where he enjoyed the friendship of Longfellow and Emerson; and in the following year he was called home to accept an appointment as examiner in the Education Office of the Privy Council. During the succeeding years he was frequently abroad; and it was on a tour in Italy in 1861 that he was suddenly cut off by fever at Florence. Clough was a man of singular purity and integrity of character, with great sensitiveness of feeling, and fine subtlety of thought, at once reserved and retiring and full of a genial humanity of disposition, with much humor and mirthfulness, and yet capable of a righteous indignation that could hardly have been expected to find fuel in so kindly a breast. A disciple of the great master of Rugby, in the midst of his most relentless skepticism he maintained a spirit of reverence and worship; and his most daring attacks on the popular creed are modified by an undercurrent of toleration and diffidence. His poems are his principal works, and of these the best known is the *Bothie of Tober-na-Vuolich*. It was written and published in 1848, after his removal from Oxford; and while warmly praised by such men as Canon Kingsley it was condemned by others as immoral and communistic. The interest of the poem depends on its graphic description of Scottish scenery and the fine analysis of contrasted characters. Under the influence partly of Longfellow's *Evangeline*, which had been published in 1847, and partly of his own attachment to the old classical forms, he employed the so-called hexameter; but it is seldom that he attains the tuneful cadence of the American poet, and much of the versification is rugged and broken in the extreme. Of greater power than the *Bothie*, at least in individual passages, is the strange irregular tragedy of *Dipsychus*, which shines at times with jagged fragments of satire and irony. *Amours de Voyage*, a rhymed epistolary novelette, and *Mari Magno*, a small collection of tales after the fashion of the *Wayside Inn*, along with various minor poems, have been republished in the second volume of *The Poems and Prose Remains of Arthur H. Clough*, edited by his wife, and accompanied by a sketch of his life by F. T. Palgrave. 1869. These will probably do less to keep green the poet's name than the noble poem of *Thyrsis*, which Matthew Arnold dedicated to his memory. One work of importance remains to be mentioned,—a careful and scholarly rehabilitation of Dryden's Translation of Plutarch, published in 1859.

CLOVES are the unexpanded flower-buds of *Caryophyllus aromaticus*, a tree belonging to the natural order *Myrtaceæ*. They are so named from the French word *clou*, on account of their resemblance to a nail. The clove tree is a beautiful evergreen which grows to a height of from 30 to 40 feet, having large oblong leaves and crimson flowers in numerous groups of terminal cymes. The flower-buds are at first of a pale color and gradually become green. After which they develop into a bright red, when they are ready for collecting. Cloves are rather more than half an inch in length, and consist of a long cylindrical calyx; terminating in four spreading sepals, and four unopened petals which form a small ball in the centre. The tree is a native of the small group of islands in the Indian Archipelago called the Moluccas, or Spice Islands; but it was long cultivated by the Dutch in Amboyna and two or three small neighboring islands. Cloves were one of the principal Oriental spices which early excited the cupidity of Western commercial communities, having been the basis of a rich and lucrative trade from an early part of the Christian era. The Portuguese, by doubling the Cape of Good Hope, obtained possession of the principal portion of the clove trade, which they continued to hold for nearly a century, when, in 1605, they were expelled from

the Moluccas by the Dutch. That power exerted great and inhuman efforts to obtain a complete monopoly of the trade, attempting to extirpate all the clove trees growing in their native islands, and to concentrate the whole production in the Amboyna Islands. With great difficulty the French succeeded in introducing the clove tree into Mauritius in the year 1770; subsequently the cultivation was introduced into Guiana, and at the end of the century the trees were planted at Zanzibar. The chief commercial sources of supply are now Zanzibar and its neighboring island Pemba on the East African coast, and Amboyna. Cloves are also grown in Java, Sumatra, Réunion, Guiana, and the West India Islands.

Cloves as they come into the market have a deep brown color, a powerfully fragrant odor, and a taste too hot and acrid to be pleasant. When pressed with the nail they exude a volatile oil with which they are charged to the unusual proportion of about 18 per cent. The oil is obtained as a commercial product by submitting the cloves with water to repeated distillation. It is, when new and properly prepared, a pale yellow or almost colorless fluid, becoming after some time of a brown color; and it possesses the odor and taste peculiar to cloves. The essential oil of cloves is a mixture of two oils—one a hydrocarbon isomeric with oil of turpentine, and the other an oxygenated oil, eugenol or eugenic acid, which possesses the taste and odor of cloves. Cloves are employed principally as a condiment in culinary operations, in confectionery, and in the preparation of liqueurs. In medicine they are tonic and carminative, but they are little used except as adjuncts to other substances on account of their flavor, or with purgatives to prevent nausea and griping. The essential oil forms a convenient medium for using cloves for flavoring or medicinal purposes, and it also is frequently employed to relieve toothache.

CLOVIO, GIULIO (1498–1578), by birth a Croat and by profession a priest, is said to have learned the elements of design in his own country, and to have studied afterwards with intense diligence at Rome under Giulio Romano, and at Verona under Girolamo de' Libri. He excelled in historical pieces and portraits, painting as for microscopical examination, and yet contriving to handle his subjects with great force and precision. In the Vatican library is preserved a MS. life of Frederick, duke of Urbino, superbly illustrated by Clovio, who is *facile princeps* among Italian miniaturists.

CLOVIS, king of the Franks. See FRANCE.

CLOYNE (in Irish Cluain-Uamha, or the Meadow of the Cave), a market town and formerly an episcopal see of Ireland, in the county of Cork, and about four miles from the east side of Cork harbor. It is now a small place of 1200 inhabitants, but it still gives its name to a Roman Catholic diocese. The cathedral, which was founded in the 6th century by Colman, a disciple of Fin-Bane of Cork, is still in existence. It contains a few handsome monuments to its former bishops, but, singular to say, nothing to preserve the memory of the illustrious Dr. George Berkeley, who filled the see from 1734 to 1753. Opposite the cathedral is a very fine round tower still 96 feet in height, though the conical roof was destroyed by lightning in 1748. The Roman Catholic church is a spacious building with a highly decorated front. The town was several times plundered by the Danes in the 9th century; it was laid waste by Dermot O'Brien in 1071, and was burned in 1137. In 1430 the bishopric was united to that of Cork; in 1636 it again became independent, and in 1660 it was again united to Cork and Ross. In 1678 it was once more declared independent, and so continued till 1835, when it was again joined to Cork and Ross. The Pipe Roll of Cloyne, compiled by Bishop Swaffham in 1364, is a very remarkable record, embracing a full account of the feudal tenures of the see, the nature of the impositions, and the duties the *puri homines Sancti Colmani* were bound to perform at a very early period. The roll is now in the Record Office, Dublin. It was edited by Richard Caulfield in 1859.

CLUB. The records of all nations agree in attributing the institution of clubs and private companies to the earliest, or one of the earliest, rulers or legislators of whom they have retained any memory. Indeed such associations seem, as Addison has said, "to be a natural and necessary offshoot of men's gregarious and social nature." In the infancy of national existences, they are almost essential for purposes

of mutual support and protection, and to supply the shortcomings of a weak Government. But over and above those fellowships which spring from the inalienable right of self-preservation, and which are founded either in the ties of kindred or community of material interests, there are commonly found, even in matured and well-organized states, a number of secondary or accidental societies, established for the promotion of some common object; and a wise and strong Government usually protects and encourages them as a most important condition of human progress. They may be roughly divided into four different classes, according to their several objects; they may be either religious, political, commercial, or merely social; and an attempt has been sometimes made to assign these to different periods of national development. Such a distinction, however, cannot be successfully maintained, since the various elements were often most closely united in the same clubs, almost (or quite) from their very foundation. Thus, the corporations in Rome whose foundation was attributed to Numa would seem at first sight to have been merely for convenience of trade. But we are told that they had also a social or political purpose, viz., to break down the barriers which separated Romans from Sabines in the infant state. Moreover, Plutarch introduces a religious element into them also, saying that Numa "fixed certain times of meeting for these companies, and certain honors to the gods, assigning to each what was suitable for them." So again in Greece we have the testimony of Aristotle that members of the same tribe or borough used to club together, men following the same occupations, as soldiers or sailors, and others again for mere social amusement; yet he immediately adds—"these meet together for the sake of one another's company, and to offer sacrifices; when they meet they both pay certain honors to the gods, and at the same time take pleasurable relaxation among themselves." It is clear, then, that whatever may have been the precise object with which each private club or association was originally formed in pagan times, these distinctive marks were very soon blurred, and finally, in the lapse of time, altogether obliterated.

We need not say anything of the religious sodalities which were appointed in a regular way both in Greece and Rome for the worship of the gods recognized by the state. It is the history of secret confraternities for the exercise of foreign religious rites unknown to the state and strictly forbidden that is more curious and attractive. In Athens the penalty of death stood enacted in the statute book against those who should introduce the worship of strange gods; but it is only on very rare and scandalous occasions that we hear of this statute in real life. There was a great invasion of foreign gods into Attica after the Persian war, and they were not so easily driven out as were the hosts of Xerxes who had imported them. Moreover, independently of foreign armies, the mere commercial activity of Athens herself did much to promote the same evil. Her sailors and soldiers, colonists and merchants, had explored the coasts of the Ægean Sea, and had brought home from Thrace, from Phrygia, from Cyprus, and elsewhere, a whole host of deities, not more false indeed, but certainly more dangerous, than those whom they had been wont to worship at home. These gods and goddesses soon found little knots of devotees, who were led to form a kind of confraternity among themselves, for the support of the forbidden worship. Fragments both of tragic and comic poets have preserved to us some notice of the kind of worship that was offered, and it was obviously in every way less respectable than the worship sanctioned by the state. In the state temples the priests and other officers were obliged to be freemen, citizens, and the sons of citizens; any taint of servile or foreign blood was a fatal disqualification. But here slaves, foreigners, and women were admitted indiscriminately. Indeed, if we may judge from monuments that have recently come to light, these secret confraternities found their principal support among these classes. At Rhodes there was one consisting exclusively of the lowest class of slaves,—the public slaves of the town; at Salamis, one exclusively of women; in that of Cnidus eleven members out of twelve were foreigners. All these monuments come from islands; and of course it was there, and in the seaport towns of the peninsula, that such illicit corporations were likely to be first introduced and to take deepest root. By and by it became necessary even to give an official recognition to some of them, e.g., in the Piræus, for the convenience of

foreigners who were either detained there for a considerable time by business, or perhaps had even taken up their permanent abode there. Excavations made within the last twenty years in the Piræus, and still more recently in the neighborhood of the silver mines of Laurium, enable us to assist at the birth and early growth of some of these illicit clubs, but there is nothing in the history specially inviting. In Rome the general policy of the state towards foreign religions was more tolerant than in Greece. Nevertheless here also the practice of certain religions was forbidden, and the prohibition naturally produced certain secret societies amongst those who were attached to them. The law indeed forbade the worship of any deity that had not been approved by the senate, but then the senate was by no means illiberal in granting its diploma of approbation, and as often as a new deity was introduced, or even a new temple built to an old deity, a new sodality seems to have sprung up, or to have been officially appointed, to look after its interests. It is disputed whether the prohibition of the worship of unknown, unrecognized gods applied only to acts of public worship, or extended even to the innermost secrecy of private life. Cicero may be quoted in defence of the latter view, Livy of the former. Probably the letter of the law favored the stricter side and spoke universally, but traditional practice ruled differently. Certainly the Romans had a scruple about interfering with anything which even pretended to lay claim to a religious character. Even when they repressed with such severity the secret meetings of the Bacchanals, this was done not so much in the interest of the other gods, as of public order and morality and the security of the state. They even continued to tolerate such foul associations as these, only they imposed the condition that not more than five worshippers should meet together at once; and under cover of this permission the number of *thias* was much multiplied in the city, and these exercised a powerful attraction over women by the promise which they made of effecting a real purification of the soul. At a later period, when Augustus destroyed all the temples of Serapis which had been erected in Rome during his absence, he was careful to assign a political motive for this unusual interference with religious liberty.

If we turn from these religious associations to consider the craft-guilds in ancient Rome, the first thing that strikes us is their extraordinary number. In the days of Numa we are told that there were only eight; but as time went on they so multiplied that in the imperial period we count more than fourscore of them, including almost every profession and handicraft one can think of, from bankers and doctors down to donkey-drivers and muleteers. Nor does the mere enumeration of the different trades and professions give us at all an adequate idea of their number; for when a club became very large, it was first subdivided into ceataries, and then these again broke off into separate clubs. Again, there was one club or company of the watermen who plied their trade on the Saone, and another of the watermen on the Rhone, though both these companies had their headquarters at Lyons. The other navigable rivers, too, each had its own company. Thus, the most ancient notice we have of Paris is derived from a monument which has come down to us of the watermen on the Seine. We find mention, also, of more craft-guilds than one even in a single street of Rome; nay, further still, within the limits of a single house, e.g., of the imperial palace, and probably of other princely establishments, which counted their hundreds of thousands of dependants. Each class of slaves engaged in different domestic occupations had their own clubs. Thus the *chef de cuisine* (*magister coquorum*) of Augustus bequeathed a sum of money to the collegium, or club, of cooks, in his imperial majesty's household, and there is evidence that there were five or six other clubs in the palace at the same time. We do not know how large each club may have been; an old inscription tells us of forty seats reserved for a particular club in the amphitheatre at Nîmes, but these belonged probably to the officers of the club, not to the ordinary members indiscriminately. Sometimes the number of members was limited, either by the original constitution of the body, or by conditions subsequently imposed by benefactors who did not wish their donations to be frittered away and rendered useless by too minute subdivisions. As to the internal organization of the clubs, the general laws and principles which governed their constitution, both in Athens and in

Rome, they were moulded, as was only natural, very much after the pattern of the civil institutions of the country. They were republican therefore in spirit, the administration of affairs being wholly in the hands of the members themselves, all of whom had equal rights; their watchful control was incessant, and their authority absolute; their officers were elected by universal suffrage, sometimes by acclamation; they were called by the same names as were borne by the magistrates of the state, *ἀρχοντες*, *questores*, *magistri quinquennales*, *curatores*, &c.; they were elected annually, and on entering into office they took an oath that they would observe the constitution and laws of the corporation; and on retiring from office they gave an account of their stewardship to the assembled members, who exercised a right of judgment over them. This judgment seems to have been almost uniformly favorable; a commendatory decree was voted almost as much a matter of course as a vote of thanks to the chairman of our own public meetings. In Greece this vote was accompanied by the offering of a crown of leaves, of olive, ivy, or poplar, according to the supposed choice of the god or goddess to whom the club was dedicated. In the East, e.g., Bithynia, we find crowns of ribands and flowers; in Rhodes, Delos, and the adjacent islands, it was not uncommonly of gold,—of very little intrinsic worth, however, and provided by special contributions at each monthly meeting. But the most valued part of the reward to these retiring officers (in Greece) seems to have been the proclamation of the honor obtained, which proclamation took place either after the ceremonies of the chief annual festival, or sometimes on every occasion of meeting. It was also engraved on a column which was set up in some conspicuous spot in or near their place of meeting. When any special services seemed to call for special recognition, the title of benefactor or benefactress was awarded, and this, too, was of course added to the inscription. A still higher and rarer honor was to offer the retiring officer a statue or portrait of himself, either full length or half figure only or sometimes both together, and even more than one of each. But only once among Greek inscriptions belonging to these clubs do we find any mention of a salary awarded to the secretary, in consideration of the zeal and justice with which he had attended to the general interests of the community, the exactness with which he had rendered his own reports and accounts, as well as audited those of others who from time to time had been specially deputed to do anything for the club, and his constant devotion to the interests of all the members both collectively and individually. Even in this instance, however, the zealous and disinterested secretary or treasurer declined the proffered salary, whereupon the club voted him a golden crown, which again he gave up for the decoration of the temple in which they met. And this, indeed, was the usual fate of these complimentary offerings. The officers fulfilled the duties of their post gratuitously, and often at great expense to themselves, just as the civil magistrates were obliged to do; and it seems to have been pretty generally understood, that any extraordinary compliments, such as the offer of a statue or portrait, should, if accepted, be carried out at the expense, not of the donor, but of the receiver. In Rome, also, whenever an inscription states that the members of a *collegium* decree that a statue shall be erected in honor of some patron or benefactor, it is generally added that he undertook to pay for the statue himself (*honore contentus, impensam remisit*). Besides the acting officials of these clubs, there were also certain honorary patrons, whose connection with them was probably much the same as that of most patrons of benevolent societies in our own day. It was a compliment to invite them to become patrons, and they were expected to contribute to the funds in return.

It only remains that we should say a few words about the merely social clubs of pagan times,—those clubs which had no other bond of union, either commercial, political, or religious, but which aimed only at the amusement or private advantage of their members. There was nothing in the functions of these clubs to obtain for them a place in the page of history. The evidence, therefore, of their existence and constitution is but scanty. Monumental inscriptions, however, tell us of clubs of Roman citizens in some of the cities of Spain, of a club of strangers from Asia resident in Malaga, of Phœnician residents at Pozzuoli, and of other strangers elsewhere. These all were probably devised as remedies against that sense of *ennui*

and isolation which is apt to come over a number of foreigners residing at a distance from their native country. Something of the same kind of feeling may have led to the toleration of a club consisting of old soldiers who had been in the armies of Augustus; these were allowed to meet and fight their battles over again, spite of the legal prohibition of military clubs. Another military club of a different kind existed among the officers of a regiment engaged in foreign service in Africa. Its existence can have been no secret, for its rules were engraved on pillars which were set up near the headquarters of the general, where they have lately been found in the ruins of the camp. The contribution of each member on admission scarcely fell short of £25, and two-thirds of this sum were to be paid to his heir or representative on the occasion of his death, or he might himself recover this proportion of his original subscription on retirement from military service. The peculiarity, however, of this aristocratic *collegium* was this, that it provided that a portion of the funds might also be spent for other useful purposes, e.g., for foreign travelling. It is to be presumed that a member who had availed himself of this privilege thereby forfeited all claim to be buried at the expense of his club.

Clubs were by no means the exclusive privilege of the male sex in ancient days. Women also were united in similar associations. Their religious sodalities, indeed, were not generally edifying; but they combined together also for social and political purposes. The most remarkable of these was the great assembly of matrons, called at one time, in a mock-heroic way, "the minor senate." This ladies' club received its title from imperial authority, which also legislated as to the needful qualifications of its members, the times of its meeting, and the subjects of its debates. These concerned the gravest questions of etiquette, such as what dress ladies should wear according to their social rank; who was to take precedence one of another on public occasions of state, in processions, or other ceremonies; who might ride in a carriage drawn by horses; who must be content to sit behind mules; whose sedan-chair might have fittings of ivory, whose of silver, &c. Not all ladies could attain to a seat in this little senate, which dealt with such delicate questions of etiquette; but we find them forming other clubs of their own which occasionally meddled with questions of municipal, if not of general, interest. They deliberated on the rewards to be given to this or that magistrate, and voted funds for monuments and statues in honor of those who had earned their approbation. The names of women are not unfrequently set down as patronesses of certain craft-guilds, of which they can hardly have been ordinary members; and in one instance at least in Africa, and in another in Majorca, inscriptions distinctly mention that certain ladies had filled all the official posts in a *collegium*. (J. S. N.)

*Modern Clubs.*—The word *club*, denoting the promotion of intercommunity and good fellowship, is not very old, and only became common in the time of the *Tatler* and *Spectator*; it claims a descent, however, from the Anglo-Saxon, being derived from *cleofan*, to divide, because the expenses are divided into shares. Thomas Occleve (*temp.* Henry IV.) mentions a club designated *La Court de Bone Compaignie* of which he was a member. Aubrey (1659) speaks thus of the word: "We now use the word *clubbe* for a sodality in a tavern." He also mentions the ballot box, that potential instrument too often used in modern days for the indulgence of secret spleen: "Here we had (very formally) a *balloting box*, and balloted how things should be carried." Dr. Johnson, according to Boswell, defines a club to be an "assembly of good fellows meeting under certain conditions." And to the same authority may be traced the words "clubbable" and "unclubbable."

The numerous London clubs which sprang into existence in the last and previous century had their place and origin almost entirely in the coffee-houses and taverns then so much in vogue. Of these the earliest known was the *Bread Street* or *Friday Street Club* originated by Sir Walter Raleigh, and meeting at the Mermaid Tavern. Shakespeare, Beaumont, Fletcher, Selden, Donne, and others were members of this club. Other clubs were subsequently formed, such as that meeting at the Devil Tavern near Temple Bar, of which Ben Jonson was supposed to be the founder; and later on (in 1764) we find the *Literary Club* was established chiefly at the instance of Sir Joshua Reynolds, which soon acquired a renown no more than

proportionate to its merits—a renown maintained and brought down to the present day.

Addison, in the *Spectator*, has a paper on the clubs of his day (No. 9, vol. i. 1710). Of the description of club there sketched many exist at the present time, having no object but that of good fellowship and dining. In this category may be included the *Royal Society Club*, the history of which has been written by the late Admiral Wm. Henry Smyth, F.R.S., in the privately printed *Sketch of the Rise and Progress of the Royal Society Club*, published in 1860.

Of the more notable of the clubs of the past and the early part of the present century but few resemble the club of the Victorian era. Of those which survive may be mentioned *White's*, originally established in 1698. This club was formerly of a high Tory character, and though no longer political is still somewhat conservative and undoubtedly aristocratic. *Brooks's* club, similar to *White's* in the character of its members, and nearly coeval in date, has continued to maintain a political aspect, and is considered to be identified with Whig principles. *Boodle's*, of later date, has always been deemed the resort of country gentlemen, and especially of masters of fox-hounds. *Arthur's*, in some respects an offshoot of *White's*, was established fully a century ago, and continues to this day a club of gentlemen associated for no special purpose, but united only by congeniality of tastes and ideas.

The number of regularly established clubs in London is upwards of fifty, divided into political, literary and scientific, university, naval and military, and general clubs. Of the political clubs the principal are the *Carlton*, the *Conservative*, the *Junior Carlton*, and the *St. Stephen's*, the *Reform*, and the *Devonshire* (a kind of junior *Reform* club), the conditions of admission into which are of a political nature. Of the literary and scientific, the *Athenæum* was "instituted for the association of individuals known for their scientific or literary attainments, artists of eminence in any class of the fine arts, and noblemen and gentlemen distinguished as liberal patrons of science, literature, or the arts," and has long enjoyed a high reputation, rendering admission to its ranks both tedious as regards the length of time a candidate has to wait before being put up for ballot, and difficult when he is subjected to that crucial test. Of university clubs the *United University* is the oldest, the others being the *Oxford* and *Cambridge*, the *New University*, and others, the qualification for membership of which would be that of connection with the chief universities. The naval and military clubs include the *United Service*, the *Junior United Service*, the *Army and Navy*, with numerous others intended for military and naval officers, and in some instances for officers of militia. The general clubs include the *Travellers'*, to be deemed eligible for which a candidate must have "travelled out of the British Islands to a distance of at least 500 miles from London in a direct line" (not a very onerous condition in the present day, but one of some weight in 1815 when the club was founded), and the *Oriental* and *East India United Service* clubs, intended more especially for members of Her Majesty's Indian services both civil and military. Besides these there are numerous clubs of a special character, such as the *Windham*, whose object is stated to be "to secure a convenient and agreeable place of meeting for a society of gentlemen all connected with each other by a common bond of literary or personal acquaintance;" the *National* club, consisting of "members who hold the doctrines and principles of the Reformed faith, as revealed in Holy Scripture, asserted at the Reformation, and generally embodied in the articles of the Church of England;" or the *Garrick*, which was instituted in 1831 for "the general patronage of the drama, for bringing together the supporters of the drama, and for the formation of a theatrical library with works on costume."

This list might be extended, but the general aims of the modern style of club are sufficiently indicated in this reference to the salient features of the clubs named.

The architectural elevations of the London club-houses are such as have lent dignity and character to the parts of London in which they are situated. Pall Mall notably is thus now a street of palaces. Nor should the contents of these handsome and convenient mansions pass unnoticed. The *Athenæum* has probably the choicest library of its kind, consisting mainly of books of reference, and including 45,000 volumes. The *Garrick* club has an exceedingly

valuable collection of oil and water-color paintings, chiefly, as might be expected, relating to dramatic episodes. The *United Service*, the *Reform*, the *Oriental*, and some other clubs have an assemblage of portraits of members who have won fame, or of paintings of celebrated battles and public events. The furniture and arrangements of the different apartments correspond to the exteriors, every convenience and luxury being placed at the disposal of the members.

The mode of election of members varies. In some clubs the committee alone have the power of choosing new members. In others the election is by ballot of the whole club, one black ball in ten ordinarily excluding. In the *Athenæum*, whilst the principle of election by ballot of the whole club obtains, the duty is also cast upon the committee of annually selecting nine members who are to be "of distinguished eminence in science, literature, or the arts, or for public services," and the rule makes stringent provision for the conduct of these elections. On the committee of the same club is likewise conferred power to elect without ballot princes of the blood royal, Cabinet ministers, bishops, speaker of the House of Commons, judges, etc.

The general concerns of clubs are managed by committees constituted of the trustees, who are usually permanent members thereof, and of ordinarily twenty-four other members, chosen by the club at large, one-third of whom go out of office annually. These committees have plenary powers to deal with the affairs of the club committed to their charge, assembling weekly to transact current business and audit the accounts. Once a year a meeting of the whole club is held, before which a report is laid, and any action taken thereupon which may be necessary.

The entrance fee varies from £40 at the *United Service* and *Army and Navy* clubs to 20 guineas at the *Carlton* club. The annual subscription in like manner ranges from 10 guineas in the *Carlton*, *Reform*, and several others, to 7 guineas in the *United Service* club. The largest income derived from these and all other sources may be stated to be that of the *Army and Navy* club, which in the year 1875 amounted to £30,813, of which £19,383 was raised by entrance fees and subscriptions alone. The expenditure is, however, most commonly of nearly equal amount, and of few of the clubs can it be said that they are entirely free from debt. The number of members included in a London club varies from 2200 in the *Army and Navy* to 475 in the *St. James's* club.

Numerous provincial clubs are established throughout the country. In both Edinburgh and Dublin are clubs fully coming up to the metropolitan societies. Nor is this great public convenience lacking in the cities and towns of Europe, the United States, and the British colonies.

Of a different nature and with widely different objects are the learned bodies designated publishing clubs, of which the *Abbotsford*, the *Bannatyne*, the *Roxburghe*, and others are examples. These societies devote themselves solely to the editing of unpublished MSS., or the reprinting of rare and valuable works. (J. C. W.)

Arnold (Walter), *Life and Death of the Sublime Society of Beesfoote*, 1871; Aubrey (John), *Letters of Eminent Persons*, 2 vols.; Marsh (C.), *Clubs of London, with Anecdotes of their Members, Sketches of Character and Conversation*, 1832, 2 vols.; *Notes and Queries*, 3d series, vols. 1, 9, and 10; Pyne (W. H.), *Wine and Walnuts*, 1823, 2 vols.; Smvth (Admiral), *Sketch of the Rise and Progress of the Royal Society Club*, 1860; Timbs (John), *Club Life of London, with Anecdotes of Clubs, Coffee-Houses, and Taverns*, 1866, 2 vols., and *History of Clubs and Club Life*, 1872; Walker (Th.), *The Original*, fifth edition, by W. A. Guy, 1875; *The Secret History of Clubs of all Descriptions* [by Ned Ward], 1709; *Complete and Humorous Account of all the Remarkable Clubs and Societies in the Cities of London and Westminster* [by Ned Ward], seventh edition, 1758; *The London Clubs: their Anecdotes, History, Private Rules, and Regulations*, 1853, 12mo; Hume (Rev. A.), *Learned Societies and Printing Clubs*, 1847.

**CLUB-FOOT (Talipes).** The pathology and treatment of the various deformities of the foot, which are included under the above general title, come strictly under orthopedic surgery. Several forms of club-foot have been recognized by surgeons. There are four primary forms:—(1) *Talipes equinus*, in which the heel does not touch the ground, the child resting on the toes; (2) *Talipes varus*, in which the foot is turned inwards and shortened, the inner edge raised, the outer edge of the foot only touching the ground; (3) *Talipes calcaneus*, a rare form, in which the heel only touches

the ground, the toes being raised; (4) *Talipes valgus*, in which the foot is turned outwards. The third and fourth varieties are so rare that they are of no practical interest, and need not be further alluded to. It is possible to confound true talipes valgus with flat-foot, a deformity which is the result of undue stretching, from weakness, of the fascial and ligamentous structures which maintain the arched form of the foot. In flat-foot the arch is lost, the patient is splay or flat-footed, and as a secondary deformity the foot is turned outwards, resembling and often confounded with true talipes valgus.

The two common primary forms of club-foot are *talipes equinus* and *talipes varus*. These two varieties are frequently combined; the deformity is then termed *talipes equino-varus*. A shortening or contraction of one group, or of allied groups, of muscles is always to be observed; as, for instance, in *talipes equinus*, to which the muscles of the calf are contracted, or in *talipes varus*, in which the group of muscles which turn the foot inwards are contracted, or in *talipes equino-varus*, in which both sets are at fault. This contraction is due either to excessive primary irritation of the muscular group implicated, or is secondary to and the result of paralysis of an opposing group of muscles. In certain cases the paralysis affects more or less all the muscles of the limb; the result of this is a deformity in the direction of the most powerful group. The primary cause of these diseased conditions is some irritation of the cerebro-spinal central nervous system, either occurring before birth, and termed congenital, or appearing after birth, generally during the period of first dentition, and termed non-congenital. As a rule well-marked cases are congenital. Such deformities are frequently hereditary. Both feet may or may not be affected. Recognition of club-foot is of importance, because if not treated early a change takes place in the shape of the bones of the foot, which renders treatment much more difficult, and in some neglected cases it is impossible to restore the foot to its normal shape.

It is to Stromeyer in Germany (1837), and to Little and Adams in England, that we owe a true understanding of the pathology and treatment of these affections.

The following broad principles, which govern the treatment, are now universally understood and adopted by surgeons:—(1) A subcutaneous division, by the operation of tenotomy, of the contracted tendons; and (2) A stretching of the newly-formed embryonic tissue which is deposited between the cut extremities of the tendons in the interspace, the result of their retraction after division. This is managed by means of a mechanical appliance termed a club-foot boot. Various forms of boot have been used by surgeons; in all the essential feature is that the foot is fixed to the boot by sticking-plaster or by straps, and the stretching is gradually accomplished by the elasticity of India-rubber bands, or by steel springs, or by screws. In this way the foot gradually assumes a normal appearance.

As a general rule, after it is evident that the deformity is a persistent one, the earlier the operation is performed the better. Only in exceptional cases should interference be delayed beyond the third or fourth month of life. If a change takes place in the bones, or if the child is allowed to walk before treatment of the deformity, the cure is rendered more difficult and more tedious. In many cases when the child is young the cutting operation will not be necessary; the foot can be restored to its normal position by mechanical appliances alone.

Various rules have been laid down for the proper performance of tenotomy. The simple rule to begin with the most tense tendon, and to divide it where it is most tense, is of universal application. In *talipes equinus* the *tendo achillis*, in *talipes varus* the *tibialis posticus* and *tibialis anticus* require division. In the common form, *talipes equino-varus*, both groups must be operated on. Very frequently the plantar fascia is shortened, and has also to be divided. After the operation, which is greatly facilitated by the administration of chloroform, the foot is kept at rest with a bandage for three or four days until the small punctures are healed. The boot is then carefully applied, and gradually the foot is restored to its normal shape *without causing pain*, which interferes with the object in view, namely, a moulding (by stretching) of the newly-formed tissues between the divided ends of the tendons. If there is distinct paralysis the appropriate remedies—friction, passive exercise, and the electric battery—may be indicated. The boot should be worn for

some time after the foot has regained its normal appearance, because there is always a tendency for a considerable period to the return of the deformity. (J. C.)

CLUNY, or CLUGNI, a town of France, in the department of Saône-et-Loire, about twelve miles by rail north-west of Macon, on the left bank of the Grône, a tributary of the Saône, crossed there by two bridges. It is a place of upwards of 4000 inhabitants, and carries on a considerable agricultural trade, and the manufacture of pottery, paper, and vinegar. The main interest in the town is due to its specimens of mediæval architecture, which include, besides its celebrated abbey, the church of Notre Dame, dating from the 13th century; the church of Saint Marceuil with a beautiful spire; the ruins of Saint Mayeul; portions of the ancient fortifications; and a number of picturesque houses belonging to various periods from the 12th century downwards, classed among the historic monuments of France. A mere village at the time when William the Pious and Bernon, abbot of Gigny and Baume, laid the foundations of what was destined to be one of the principal monasteries of Europe, it gradually increased with the development of the religious fraternity, and was raised to the rank of a town. Before the erection of St. Peter's at Rome, the abbey church, which was consecrated by Innocent II., was recognized as the largest building of its kind in Europe, its length being no less than 656 feet and its breadth 130. During the wars of the 16th century the abbatial buildings were greatly damaged; and in the Revolution of 1789 a great part of them were completely demolished. Restorations have since been effected at various times, and different portions of the enormous pile are appropriated to civic purposes. The abbot's palace contains a museum and a library; the cloisters are occupied by a school; and the site of the abbey church affords room for a Government stud. The 12th century was the period at which the monks of Cluny reached the height of their prosperity; and about that time no fewer than 2000 religious establishments throughout Europe acknowledged allegiance. Shortly after they began to decline from the ancient rigidity of their rule; and their influence gave way before the rising power of the Cistercians. Among the great men whom they have produced are Gregory VII., Urban II., and Pascal II. The town residence erected in Paris by the abbots of Cluny about the end of the 15th century is still extant, and, under the name of Hôtel de Cluny, is occupied by the Sommerard archaeological collection; but the Collège de Cluny, which was founded in 1269 by Yves de Vargy, has disappeared.

CLUSIUM. See CRESUS.

CLUVER, PHILIP (1580-1623), a German geographer still regarded as an authority, was born at Danzig in 1580. After travelling in Poland and Germany, he commenced the study of law at Leyden; but he soon turned his attention to geography, which was then taught there by Joseph Scaliger. Displeased with his desertion of the law, his father refused to support him, and he was forced to enter the army, with which he served for two years in Bohemia and Hungary. After leaving the army he undertook to get printed in Holland an apology for Baron Popel, who had been imprisoned by the emperor; and in consequence he was himself thrown into prison. On his release he visited England, where he married, and became acquainted with Dr. Holland and Dr. Prideaux. After spending some time in Scotland and France, he returned to Holland; and in 1611 he commenced to publish his works, being, after 1616, supported by a pension from the Academy of Leyden. His principal works are—*Germania Antiqua* (1618), *Sicilia Antiqua libri duo*, *Sardinia et Corsica Antiqua* (1619), *Italia Antiqua* (1624), *Introductio in Universam Geographiam* (1629).

CLYDE, the most important river of Scotland, and the third in point of magnitude, has its origin from numerous small streams rising at a height of about 1400 feet above the level of the sea, in the mountains which separate Lanarkshire from the counties of Peebles and Dumfries. It flows first in a northerly direction, with a slight inclination eastward as far as Biggar, where, in time of floods, a junction is sometimes established with the system of the Tweed by means of the Biggar Water. After uniting with the Douglas near Harperfield, it takes a north-west course, passing Lanark, Hamilton, and Glasgow, and merges in the Firth of Clyde below Dumbarton. From its source to Dumbarton it is about 73 miles in length, the direct distance

being about 52. Its principal tributaries are the Douglas, the Nethan, the Avon, and the Cart from the left, and the Medwyn, the Mounse, the Calder, the Kelvin, and the Leven from the right. Of the celebrated Falls of Clyde, three are above and one below Lanark; the uppermost is Bonnington Linn, the height of which is about 80 feet; the second is Corra Linn, where the water dashes over the rock in three distinct leaps, and resumes its course at a level 84 feet lower. Dundaff Linn is a small fall of 10 feet; and at Stonebyres there are three successive falls, together measuring 76 feet in height. At high water the Clyde is navigable to Glasgow for the largest class of merchant vessels. See GLASGOW.

CLYDE, LORD (1792-1863), better known as Sir COLIN CAMPBELL, was born at Glasgow on the 16th of October, 1792. He received his education at the high school of that city, and when only sixteen years of age obtained an ensigncy in the 9th foot, through the influence of Colonel Campbell, his maternal uncle. The youthful officer had an early opportunity of engaging in active service. He fought under Sir Arthur Wellesley at Vimiera, took part in the retreat of Sir John Moore, and was present at the battle of Coruña. He shared in all the fighting of the next Peninsular campaign, and was severely wounded while leading a storming-party at the attack on San Sebastian. He was again wounded at the passage of the Bidassoa, and compelled to return to England, when his conspicuous gallantry was rewarded with the rank of captain and lieutenant, without purchase. Campbell held a command in the American expedition of 1814, and after the peace of the following year he devoted himself to studying the theoretical branches of his profession. In 1823 he quelled the negro insurrection in Demerara, and two years later obtained his majority by purchase. In 1832 he became lieutenant-colonel of the 96th foot, and with that regiment rendered distinguished service in the Chinese war of 1842. Colonel Campbell was next employed in the Sikh war of 1848-49, under Lord Gough. At Chillianwalla, where he was wounded, and at the decisive victory of Goojerat, his skill and valor largely contributed to the success of the British arms; and his "steady coolness and military precision" were highly praised in official despatches. He was created a K. C. B. in 1849, and specially named in the thanks of Parliament. After rendering important services in India, Sir Colin Campbell returned home in 1853. Next year the Crimean war broke out, and he accepted the command of the Highland brigade, which formed the left wing of the duke of Cambridge's division. The success of the British at the Alma was mainly due to his intrepidity; and with his "thin red line" of Highlanders he repulsed the Russian attack on Balaklava. At the close of the war Sir Colin was promoted to be Knight Grand Cross of the Bath, and elected honorary D.C.L. of Oxford. His military services, however, had as yet met with tardy recognition; but, when the crisis came, his true worth was appreciated. The outbreak of the Indian Mutiny called for a general of tried experience; and on July 11, 1857, the command was offered to him by Lord Palmerston. On being asked when he would be ready to set out, the veteran replied, "Within twenty-four hours." He was as good as his word; he left England the next evening, and reached Calcutta on August 13. The position was one of unusual difficulty, but his energy and resource did not fail for a moment. Having formed an army as hastily as possible, he marched with 6000 men and 36 guns to the relief of Lucknow. The odds against him were great, and nothing save consummate dexterity of manœuvring could have achieved success. When the British guns were silenced by the fire of the rebels, Sir Colin himself headed the final assault, carried the fort, and saved the besieged. He afterwards, by his skilful tactics, thoroughly defeated the enemy, and captured their strongholds,—thus crushing the mutiny and preserving the British rule in India. For these services he was raised to the peerage in 1858, by the title of Lord Clyde; and returning to England in the next year he received the thanks of both Houses of Parliament. He enjoyed a pension of £2000 a year until his death, which occurred on the 14th of August, 1863.

Lord Clyde possessed in abundant measure all the qualities which go to make a successful general. He combined the daring of the subaltern with the calm prudence of the veteran commander. The soldiers whom he led

were devotedly attached to him; and his courteous demeanor and manly independence of character won him unvarying respect. Though adequate recognition of his merits came slowly, he never allowed any feeling of pique to interfere with duty; and he deserves to be regarded as one of the most distinguished generals that Britain has produced.

**CLYTÆMNESTRA**, the daughter of Tyndareus and Leda, and wife of Agamemnon. See **AGAMEMNON**.

**CNIDUS**, now **TEKIR**, an ancient city of Caria, in Asia Minor, situated at the extremity of the long peninsula that forms the southern side of the Sinus Ceramicus, or Gulf of Cos. It was built partly on the mainland and partly on the Island of Triopion, or Cape Krio, which anciently communicated with the continent by a causeway and bridge, and is now permanently connected by a narrow sandy isthmus. By means of the causeway the channel between island and mainland was formed into two harbors, of which the larger, or southern, now known as Port Freano, was further enclosed by two strongly-built moles that are still in good part entire. The extreme length of the city was little less than a mile, and the whole intramural area is still thickly strewn with architectural remains. The walls, both insular and continental, can be traced throughout their whole circuit; and in many places, especially round the acropolis, at the north-east corner of the city, they are remarkably perfect. Our knowledge of the site is largely due to the mission of the Dilettanti Society in 1812, and the excavations executed by Mr. C. T. Newton in 1857-8. The agora, the theatre, an odeum, a temple of Dionysus, a temple of the Muses, a temple of Venus, and a great number of minor buildings have been identified, and the general plan of the city has been very clearly made out. In a temple-enclosure Mr. Newton discovered a fine seated statue of Demeter, which now adorns the British Museum; and about three miles south-east of the city he came upon the ruins of a splendid tomb, and a colossal figure of a lion carved out of one block of Pentelic marble, 10 feet in length and 6 in height, which has been supposed to commemorate the great naval victory of Conon over the Lacedæmonians in 394 B.C. (see **ARCHITECTURE**, vol. ii. p. 361). Among the minor antiquities obtained from the city itself, or the great necropolis to the east, perhaps the most interesting are the leaden *κατάσκευα*, or imprecationary tablets, found in the temple of Demeter, and copied in facsimile in the appendix to the second volume of Newton's work.

Cnidus was a city of high antiquity and probably of Lacedæmonian colonization. Along with Halicarnassus and Cos, and the Rhodian cities of Lindus, Camirus, and Ialysus, it formed the Dorian Hexapolis, which held its confederate assemblies on the Triopion headland, and there celebrated games in honor of Apollo, Poseidon, and the nymphs. The city was at first governed by an oligarchic senate, composed of sixty members, known as *ἀρχημονες*, and presided over by a magistrate called an *ἀρχοστής*; but, though it is proved by inscriptions that the old names continued to a very late period, the constitution underwent a popular transformation. The situation of the city was favorable for commerce, and the Cnidians acquired considerable wealth, and were able to colonize the island of Lépara and founded the city of Coreyra Nigra in the Adriatic. They ultimately submitted to Cyrus, and from the battle of Eurymedon to the latter part of the Peloponnesian war they were subject to Athens. The Romans easily obtained their allegiance, and rewarded them by leaving them the freedom of their city. During the Byzantine period there must still have been a considerable population; for the ruins contain a large number of buildings belonging to the Byzantine style, and Christian sepulchres are common in the neighborhood. Eudexus, the astronomer, Ctesias, the writer on Persian history, and Sestratus, the builder of the celebrated Pharos at Alexandria, are the most remarkable of the Cnidians mentioned in history.

See Beaufort's *Ionian Antiquities*, 1811, and Karamania, 1818; Hamilton's *Researches*, 1842; Newton's *Travels and Discoveries in the Levant*, 1865; and Waddington in the *Revue Numismatique*, 1851.

**CNOSSUS**, or **GNOSSUS**, the most important city of Crete, on the left bank of the Ceratus, a small stream which falls into the sea on the north side of the island. The city was situated at a distance of about 3 miles from the coast, and, according to the old traditions, was founded

by Minos, the mythical king of Crete. The locality was associated with a number of the most interesting legends of Grecian mythology, particularly with those which related to Jupiter, who was said to have been born, to have been married, and to have been buried in the vicinity. Cnossus is also assigned as the site of the fabled labyrinth in which the Minotaur was confined, and a physical basis for the legend may perhaps have been found in the caverns and excavations of the district. As the city was originally peopled by Dorians, the manners, customs, and political institutions of its inhabitants were all Dorian. Along with Gortyna and Cydonia, it held for many years the supremacy over the whole of Crete; and it always took a prominent part in the civil wars which, from time to time desolated the island. When the rest of Crete fell under the Roman dominion, Cnossus shared the same fate, and became a Roman colony. Ænesidemus, the skeptic philosopher, and Chersiphron, the architect of the temple of Diana at Ephesus, were natives of Cnossus.

**COAL**. In its most general sense the term coal includes all varieties of carbonaceous minerals used as fuel, but it is now usual in England to restrict it to the particular varieties of such minerals occurring in the older Carboniferous formations. On the continent of Europe it is customary to consider coal as divisible into two great classes, depending upon differences of color, namely, *brown coal*, corresponding to the term "lignite" used in England and France, and *black or stone coal*, which is equivalent to coal as understood in England. Stone coal is also a local English term, but with a signification restricted to the substance known by mineralogists as anthracite. In old English writings the terms pit-coal and sea-coal are commonly used. These have reference to the mode in which the mineral is obtained, and the manner in which it is transported to market.

The root *kol* is common to all the Teutonic nations, while in French and other Romance languages derivatives of the Latin *carbo* are used, e.g., *charbon de terre*. In France and Belgium, however, a peculiar word, *houille*, is generally used to signify mineral coal. This word is supposed to be derived from the Walloon *hoie*, corresponding to the mediæval Latin *hulla*. Littré suggests that it may be related to the Gothic *haurja*, coal. Anthracite is from the Greek *ἀνθραξ*, and the term *litanthraz*, stone coal, still survives, with the same meaning, in the Italian *litantrace*.

It must be borne in mind that the signification now attached to the word coal is different from that which formerly obtained when wood was the only fuel in general use. Coal then meant the carbonaceous residue obtained in the destructive distillation of wood, or what is known as charcoal, and the name collier was applied indifferently to both coal-miners and charcoal-burners.

The spelling "cole" was generally used up to the middle of the 17th century, when it was gradually superseded by the modern form "coal." The plural, coals, seems to have been used from a very early period to signify the broken fragments of the mineral as prepared for use.

Coal is an amorphous substance of variable composition, and therefore cannot be as strictly defined as a crystallised or definite mineral can. Physical properties.

It varies in color from a light brown in the newest lignites to a pure black, often with a bluish or yellowish tint in the more compact anthracite of the older formations. It is opaque, except in exceedingly thin slices, such as made for microscopic investigation, which are imperfectly transparent, and of a dark brown color by transmitted light. The streak is black in anthracite, but more or less brown in the softer varieties. The maximum hardness is from 2.5 to 3 in anthracite and hard bituminous coals, but considerably less in lignites, which are nearly as soft as rotten wood. A greater hardness is due to the presence of earthy impurities. The densest anthracite is often of a semi-metallic lustre, resembling somewhat that of graphite. Bright, glassy, or pitch coal is another brilliant variety, brittle, and breaking into regular fragments of a black color and pitchy lustre. Lignite and cannel are usually dull and earthy, and of an irregular fracture, the latter being much tougher than the black coal. Some lignites are, however, quite as brilliant as anthracite; cannel and jet may be turned in the lathe, and are susceptible of taking a brilliant polish. The specific gravity is highest in anthracite and lowest in lignite, bituminous coals giving

intermediate values (see Table I.). As a rule the density increases with the amount of carbon, but in some instances a very high specific gravity is due to intermixed earthy matters, which may be separated by mechanical treatment.

Coal is perfectly amorphous, the nearest approach to anything like crystalline structure being a compound fibrous grouping resembling that of gypsum or arragonite, which occurs in some of the steam coals of S. Wales, and is locally known as "cone in cone," but no definite form or arrangement can be made out of the fibres. The impressions of leaves, woody fibre, and other vegetable remains are to be considered as pseudomorphs in coaly matter of the original plant structures, and do not actually represent the structure of the coal itself. There is generally a tendency in coals towards cleaving into cubical or prismatic blocks, but sometimes the cohesion between the particles is so feeble that the mass breaks up into dust when struck. These peculiarities of structure may vary very considerably within small areas; and the position of the divisional planes or cleats with reference to the mass, and the proportion of small coal or slack to the larger fragments when the coal is broken up by cutting-tools, are points of great importance in the working of coal on a large scale.

The divisional planes often contain small films of other minerals, the commonest being calcite, gypsum, and iron pyrites, but in some cases zeolitic minerals and galena have been observed. Salt, in the form of brine, is sometimes present in coal. Some years ago a weak brine occurring in this way was utilized at a bathing establishment at Ashby-de-la-Zouche. Hydrocarbons, such as petroleum, bitumen, paraffin, &c., are also found occasionally in coal, but more generally in the associated sandstones and limestones of the Carboniferous formation. Gases, consisting principally of light carburetted hydrogen or marsh gas, are often present in considerable quantity in coal, in a dissolved or occluded state, and the evolution of these upon exposure to the air, especially when a sudden diminution of atmospheric pressure takes place, constitutes one of the most formidable dangers that the coal miner has to encounter.

The classification of the different kinds of coal may be considered from various points of view, such as their chemical composition, their behavior when subjected to heat or when burnt, and their geological position and origin. They all contain carbon, hydrogen, oxygen, and nitrogen, forming the carbonaceous or combustible portion, and some quantity of mineral

TABLE I.—Elementary Composition of Coal (the figures denote the amounts per cent.).

Localities.	Specific Gravity.	Carbon.	Hydrogen.	Oxygen.	Nitrogen.	Sulphur.	Ash.	Water.	Composition calculated exclusive of Water, Sulphur, and Ash.			
									Carbon.	Hydrogen.	O. and N.	
<i>Anthracite.</i>												
1. South Wales.....	1.392	90.39	3.28	2.98	0.83	0.91	1.61	2.00	93.54	3.39	3.82	
2. Pennsylvania.....	1.462	90.45	2.43	2.45	...	...	4.67	...	94.89	2.64	2.57	
3. Peru.....	...	82.70	1.41	...	0.85	10.35	8.75	0.94	97.34	1.66	1.00	
<i>Bituminous Steam and Coking Coal.</i>												
4. Risca, South Wales.....	...	75.49	4.73	...	6.78	1.21	10.67	1.12	86.78	5.43	7.79	
5. Aberdare, Do. ....	...	86.80	4.25	...	3.06	0.83	4.40	0.66	92.24	4.51	3.25	
6. Hartley, Northumberland..	...	78.65	4.66	...	13.36	0.66	2.49	...	80.67	4.76	14.5	
7. Dudley, Staffordshire.....	1.278	78.57	5.29	12.88	1.84	0.39	1.03	1.13	79.70	5.37	14.9	
8. Stranitzan, Styria.....	...	79.90	4.85	12.75	0.64	0.20	1.66	...	81.45	4.92	13.63	
<i>Cannel or Gas Coal.</i>												
9. Wigan, Lancashire.....	1.276	80.07	5.53	8.08	2.12	1.50	2.70	0.91	85.48	5.90	8.62	
10. Boghead, Scotland.....	...	63.10	8.91	...	7.25	0.96	19.78	...	79.61	11.24	9.15	
11. Albertite, Nova Scotia.....	...	82.67	9.14	...	8.19	...	...	...	82.67	9.14	8.19	
12. Tasmanite, Van Dieman's Land.....	1.18	79.34	10.41	...	4.93	5.32	...	...	83.80	10.99	5.21	
<i>Lignite and Brown Coal.</i>												
13. Cologne.....	1.100	63.29	4.98	...	26.24	...	8.49	...	66.97	5.27	27.76	
14. Bovey, Devonshire.....	...	66.31	5.63	22.86	0.57	2.36	2.36	...	69.53	5.90	24.57	
15. Trifail, Styria.....	...	50.72	5.34	33.18	2.80	0.90	7.86	...	55.11	5.80	39.09	

matter, which remains after combustion as a residue or "ash." As the amount of ash varies very considerably in different coals, and stands in no relation to the proportion of the other constituents, it is necessary in forming a chemical classification to compute the results of analysis after deduction of the ash and hygroscopic water. Examples of analyses treated in this manner are furnished in the last column of Table I., from which it will be seen that the nearest approach to pure carbon is furnished by anthracite, which contains above 90 per cent. This class of coal burns with a very small amount of flame, producing intense local heat and no smoke. It is especially used for drying hops and malt, and in air or blast furnaces where a high temperature is required, but is not suited for reverberatory furnaces. The American anthracite is largely used in iron smelting, as is also that of South Wales, but to a less extent, the latter having the disadvantageous property of decrepitating when first heated.

The most important class of coals is that generally known as bituminous, from their property of softening or undergoing an apparent fusion when heated to a temperature far below that at which actual combustion takes place. This term is founded on a misapprehension of the nature of the occurrence, since, although the softening takes place at a low temperature, still it marks the point at which destructive distillation commences, and hydrocarbons both of a solid and gaseous

character are formed. That nothing analogous to bitumen exists in coals is proved by the fact that the ordinary solvents for bituminous substances, such as bisulphide of carbon and benzole, have no effect upon them, as would be the case if they contained bitumen soluble in these re-agents. The term is, however, a convenient one, and one whose use is almost a necessity, from its having an almost universal currency among coal miners. The proportion of carbon in bituminous coals may vary from 80 to 90 per cent.—the amount being highest as they approach the character of anthracite, and least in those which are nearest to lignites. The amount of hydrogen is from 4½ to 6 per cent., while the oxygen may vary within much wider limits, or from about 3 to 14 per cent. These variations in composition are attended with corresponding differences in qualities, which are distinguished by special names. Thus the semi-anthracitic coals of South Wales are known as "dry" or "steam coals," being especially valuable for use in marine steam-boilers, as they burn more readily than anthracite and with a larger amount of flame, while giving out a great amount of heat, and practically without producing smoke. Coals richer in hydrogen, on the other hand, are more useful for burning in open fires—smiths' forges and furnaces—where a long flame is required.

The excess of hydrogen in a coal, above the amount necessary to combine with its oxygen to form water, is known as "disposable" hydrogen, and is a measure of the



Gas coal. fitness of the coal for use in gas-making. This excess is greatest in what we know as cannel coal, the Lancashire kennel or candle coal, so named from the bright light it gives out when burning. This, although of very small value as fuel, commands a specially high price for gas-making. Cannel is more compact and duller than ordinary coal, and can be wrought in the lathe and polished. These properties are most highly developed in the substance known as jet, which is a variety of cannel found in the lower oolitic strata of Yorkshire, and is almost entirely used for ornamental purposes, the whole quantity produced near Whitby, together with a further supply from Spain, being manufactured into articles of jewelry at that town.

Caking coals. When coal is heated to redness out of contact with the air, the more volatile constituents, water, hydrogen, oxygen, and nitrogen, are expelled, a portion of the carbon being also volatilized in the form of hydrocarbons and carbonic oxide,—the greater part, however, remaining behind, together with all the mineral matter or ash, in the form of coke, or, as it is also called, "fixed carbon." The proportion of this residue is greatest in the more anthracitic or drier coals, but a more valuable product is yielded by those richer in hydrogen. Very important distinctions—those of caking or non-caking—are founded on the behavior of coals when subjected to the process of coking. The former class undergo an incipient fusion or softening when heated, so that the fragments coalesce and yield a compact coke, while the latter (also called free-burning) preserve their form, producing a coke which is only serviceable when made from large pieces of coal, the smaller pieces being incoherent and of no value. The reason of this difference is not clearly made out, as non-caking coals are often of very similar ultimate chemical composition as those in which the caking property is very highly developed. As matter of experience, it is found that caking coals lose that property when exposed to the action of the air for a lengthened period, or by heating to about 300° C., and that the dust or slack of non-caking coal may, in some instances, be converted into a coherent cake by exposing it suddenly to a very high temperature.

Lignite. Lignite or brown coal includes all varieties which are intermediate in properties between wood and coals of the older formations. A coal of this kind is generally to be distinguished by its brown color, either in mass or in the blacker varieties in the streak. The proportion of carbon is comparatively low, usually not exceeding 70 per cent., while the oxygen and hygroscopic water are much higher than in true coals. The property of caking or yielding a coherent cake is usually absent, and the ash is often very high. The specific gravity is low when not brought up by an excessive amount of earthy matter. Sometimes it is almost pasty, and crumbles to powder when dried so as to be susceptible of use as a pigment, forming the color known as Cologne earth, which resembles umber or sepia. In Nassau and Bavaria woody structure is very common, and it is from this circumstance that the term lignite is derived. The best varieties are black and pitchy in lustre, or even bright and scarcely to be distinguished from true coals. These kinds are most common in Eastern Europe. Lignite, as a rule, are generally found in strata of a newer geological age, but there are many instances of perfect coals being found in such strata.

Ash of coal. By the term "ash" is understood the mineral matter remaining unconsumed after the complete combustion of the carbonaceous portion of a coal. This represents part of the mineral matter

TABLE II.—Composition of the Ashes of Coals.

	Silice.	Alumina.	Ferric Oxide.	Lime.	Magnesia.	Potash.	Sulphuric acid.	Phosphoric acid.	Total.
<i>True Coals.</i>									
Dowlais, South Wales...	29.64	39.20	11.84	1.81	2.58	..	4.99	3.01	98.06
Ebbw Vale, do	33.00	35.01	..	3.94	2.20	..	0.28	0.28	99.22
Kilgerrube, Silica...	52.41	18.25	16.98	3.21	1.37	2.66	1.73	0.28	99.54
Old...	44.80	41.10	7.40	3.61	1.25	1.82	0.59	0.28	100.00
<i>Lignites.</i>									
Helmstedt, Saxony.....	17.27	11.57	5.57	22.87	3.58	2.64	38.58	..	97.13
Békény, Hungary.....	35.01	23.97	5.95	15.43	3.84	2.28	12.26	..	99.13

present in the plants from which the coal was originally formed, with such further addition by infiltration and mechanical admixture as may have arisen during consolida-

tion and subsequent changes. The composition of the ashes of different coals is subject to considerable variation, as will be seen by the foregoing list of analyses.

The composition of the ash of true coal approximates to that of a fire-aly, allowance being made for lime, which may be present either as carbonate or sulphate, and for sulphuric acid. The latter is derived mainly from iron pyrites, which yields sulphate by combustion. An indication of the character of the ash of a coal is afforded by its color, white ash coals being generally freer from sulphur than those containing iron pyrites, which yield a red ash. There are, however, several striking exceptions, as for instance in the anthracite from Peru, given in Table I., which contains more than 10 per cent. of sulphur, and yields but a very small percentage of a white ash. In this coal, as well as in the lignite of Tasmania, known as white coal or Tasmanite, the sulphur occurs in organic combination, but is so firmly held that it can only be very partially expelled, even by exposure to a very high and continued heating out of contact with the air. An anthracite occurring in connection with the old volcanic rocks of Arthur's Seat, Edinburgh, which contains a large amount of sulphur in proportion to the ash, has been found to behave in a similar manner. Under ordinary conditions, from  $\frac{1}{2}$  to  $\frac{2}{3}$  of the whole amount of sulphur in a coal is volatilized during combustion, the remaining  $\frac{1}{3}$  to  $\frac{1}{4}$  being found in the ash.

The amount of water present in freshly raised coals varies very considerably. It is generally largest in lignites, which may sometimes contain 30 per cent. or even more, while in the coals of the coal measures it does not usually exceed from 5 to 10 per cent. The loss of weight by exposure to the atmosphere from drying may be from  $\frac{1}{2}$  to  $\frac{2}{3}$  of the total amount of water contained.

Coal is undoubtedly the result of the transformation of vegetable matter, mainly woody fibre, by the partial elimination of oxygen and hydrogen giving rise to a substance richer in carbon than the original wood,—the mineral matter being modified simultaneously by the almost entire removal of the alkalies and lime, and the addition of materials analogous in composition to clay, as will be seen by comparing the analyses in Table II. The following table, given by Percy, shows the relative proportions of the different components of mineral fuels.

TABLE III.—Composition of Fuels (assuming Carbon = 100).

	Carbon.	Hydrogen.	Oxygen.	Disposable Hydrogen.
Wood .....	100	12.18	83.07	1.80
Peat.....	100	9.85	55.67	2.89
Lignite.....	100	8.37	42.42	3.07
Thick Coal, S. Staffordshire.	100	6.12	21.23	3.47
Hartley Steam Coal.....	100	5.91	18.32	3.62
South Wales Coals.....	100	4.75	5.28	4.09
American Anthracite.....	100	2.84	1.74	2.63

Mohr has computed that the transformation of wood into coal is attended with a loss of about 75 per cent. in weight; and, having regard to the difference in density of the two substances, the volume of the coal can only be from  $\frac{1}{4}$  to  $\frac{1}{3}$  of the woody fibre from which it is derived.

The nature of the change is essentially a slow oxidation under water or any covering sufficient to protect the dead wood from the direct action of atmospheric air, as in the latter case the vegetable mould or humus would be produced. The products of such decomposition vary with the length of time and the nature of the plants acted on, and in the case of anthracite the change is so great that no portion of the original plant structure can be recognized, at the same time the density and conductivity for heat and electricity are increased. This, however, is a case of metamorphosis analogous to the transformation of sedimentary into crystalline rocks, the extreme term of such metamorphosis being the production of graphite or plumbago. Daubrée has shown that wood may be converted into an thracite by exposure to the action of superheated water at a temperature of 400° C.

The plants concerned in the production of coal vary very considerably in different geological periods. In the coal measures proper, acro-

Sulphur in coal.

Water in coal.

Origin of coal.

Coal-producing plants.

gens, ferns, equisetums, and similar allied forms are most abundant. It is stated by some observers that entire beds of coal are sometimes made up of the spores of ferns. This, however, appears to depend upon the inspection of microscopic sections, and may not be capable of rigorous quantitative demonstration. In the coals of newer date exogenous wood and leaves are more common than in those of the coal measures; the former also contains resins, sometimes in considerable quantity.

The number of species of land plants in the British sedimentary formations, which may be taken as a measure of the comparative prevalence of coal in the different series, is as follows:—

Devonian strata.....	9 species.
Carboniferous do.....	320 "
Permian do.....	20 "
Triassic do.....	9 "
Lias and Oolitic do.....	160 "
Purbeck and Wealden do.....	38 "
Cretaceous do.....	19 "
Tertiary do.....	224 "

The most generally received opinion is that much if not all coal results from the transformation of plants upon the site of their growth. The principal evidence in favor of such a supposition is afforded by the common occurrence of a bed of clay, the so-called "under-clay," containing the roots of plants, representing the old soil, immediately below every coal seam—a fact that was first pointed out by the late Sir W. E. Logan in South Wales. In Yorkshire the same thing is observed in the siliceous rock called ganister occurring in similar positions, showing that the coal plants grew there upon sandy soils.

The action of water in bringing down drift wood may have also contributed some material, but much less than the local growth. This may probably have been concerned in the production of the very thick masses of coal of small extent found in some coal-fields in Southern Europe.

Another theory, that proposed by Dr. Mohr, deserves notice, namely, that coal may be of marine origin, and derived from the carbonization of sea weeds, such as the great kelp plant of the Pacific Ocean. This has been very ingeniously elaborated by the author, and much apparently good evidence adduced in support (see his *Geschichte der Erde*, Bonn, 1875). But the positive evidence afforded by roots found in the under-clays is sufficient to render such an hypothesis unnecessary in the majority of instances.

It must be remembered, however, that, although cellulose or wood fibre is most probably the chief material concerned in the production of coal, this substance is readily convertible into dextrine by the action of protein or analogous fermentescible matters containing nitrogen, a change that is attended with the loss of structure, the fibre being converted into a gummy mass. Some forms of cellulose, such as that in the lichens known as Iceland moss, are soluble in water, and are without fibre. The preservation of recognizable woody tissue therefore in coals can only be regarded as accidental, and any argument founded upon the relative quantity of the recognizable vegetable structures in microscopic sections is likely to be unsound, unless the relative durability of the different portions of the plants be taken into account. Thus the bark of trees is, as a rule, less perishable than the solid wood, while tissues impregnated with resinous matters are almost indestructible by atmospheric agency. Instances of this are afforded by the fossil trees found in the coal measures, which are often entirely converted into siliceous masses, the bulk of the wood having decayed and been replaced by silica, while the bark is represented by an external layer of bright coal. Fossil resins, such as amber, are of common occurrence in coals, especially those of secondary or tertiary age.

In an investigation of the coking properties of the Saarbrücken coals by Schondorff, it was found that they could be separated into three different materials, which he distinguished as glance or bright coal, dull or striped coal, and fibrous coal. The last, which is known in England as "mother of coal," resembles a soft, dull, black charcoal, containing abundant traces of vegetable fibre, and yielding a high proportion of non-coherent coke, behaving, in fact, like charcoal. The bright or glance coal is without any apparent structure, cleaving into cubical masses, contains but little mineral matter, and yields a strong coke. The striped coal consists mainly of a dull substance, with fine alternations of bright matter, and is essentially a gas coal

yielding only an inferior coke. These differences are supposed to be due to original differences in the substances from which the coals have been derived. Thus the fibrous coal may result from unaltered cellulose, the glance coal from the insoluble mucilage derived from the maceration of the plants in water, and the dull coal from the soluble parts, such as gum and dextrine, either original or produced by the transformation of cellulose and starch. That something analogous to a pulping process has gone on in the production of coal is evident from the intimate intermixture of the mineral matter constituting the ash, which is quite unrecognizable before burning in the majority of instances.

F. Muck (*Chemische Aphorismen über Steinkohlen*, Bochum, 1873) has recorded some interesting experiments on the behavior of the three isomeric carbohydrates,—cellulose, starch, and gum arabic,—which are all of the same ultimate composition, namely,  $C_6H_{10}O_5$ . When subjected to the process of coking, cellulose, in the form of Swedish filter paper, gave a residue of 6.74 per cent. of a perfectly non-coherent coke, starch 11.30 per cent. of a bright vesicular coke like that from strongly coking coal, and gum arabic 20.42 per cent. of a hard dull coke resembling that produced from imperfectly coking gas coals. The volume of gas given off by cellulose and starch is much larger and of a higher illuminating power than that produced from gum under the same conditions.

The conditions favorable to the production of coal seem therefore to have been—forest growth in swampy ground about the mouths of rivers, and rapid oscillation of level, the coal produced during subsidence being covered up by the sediment brought down by the river forming beds of sand or clay, which, on re-elevation, formed the soil for fresh growths, the alteration being occasionally broken by the deposit of purely marine beds. We might therefore expect to find coal wherever strata of estuarine origin are developed in great mass; and this is actually the case,—the Carboniferous, Cretaceous, and Oolitic series being all coal bearing horizons, though in unequal degrees,—the first being known as the coal measures proper, while the others are of small economic value in Great Britain, though more productive in workable coals on the continent of Europe. The coal measures which form part of the Paleozoic or oldest of the three great geological divisions are mainly confined to the countries north of the Equator, Mesozoic coals being more abundant in the southern hemisphere, while Tertiary coals seem to be tolerably uniformly distributed irrespective of latitude.

The nature of the coal measures will be best understood by considering in detail the areas within which they occur in Britain, together with the rocks with which they are most intimately associated. The general succession of these rocks is given in fig. 1 (cols. 1 to 4), which is taken from the index of strata issued by the Geological Survey. The commencement of the carboniferous period is marked by a mass of limestones known as the Carboniferous or mountain limestone, which contains a large assemblage of marine fossils, and has a maximum thickness in S.W. England and Wales of about 2000 feet. The upper portion of this group consists of shales and sandstones known as the Yoredale Rocks, which are highly developed in the moorland region between Lancashire and the north side of Yorkshire. These are also called the upper limestone shale, a similar group being found in places below the limestone, and called the lower limestone shale, or, in the North of England, the Tuedian group. Going northward the beds of limestone diminish in thickness, with a proportional increase in the intercalated sandstones and shales, until in Scotland they are entirely subordinate to a mass of coal-bearing strata, which forms the most productive members of the Scotch coal fields. The next member of the series is a mass of coarse sandstones, with some slates and a few thin coals, known as the Millstone Grit, which is about equally developed in England and in Scotland. In the southern coal-fields it is usually known by the miner's name of Farewell Rock, from its marking the lower limit of possible coal working. The Coal Measures, forming the third great member of the carboniferous series, consist of alternations of shales and sandstones, with beds of coal and nodular ironstones, which together make up a thickness of many thousands of feet—from 12,000 to 14,000 feet when at the maximum of development. They are divisible into

Sequence  
of carbon-  
iferous  
strata.

three parts, the lower coal measures, the middle or Pennant, a mass of sandstone containing some coals, and the upper coal measures, also containing workable coal. The

often difficult to decide upon the true line of demarcation between the two formations. These are not, however, always found together, the coal measures being often covered by strata belonging to the Trias or upper New Red Sandstone series.

The areas containing productive coal measures are usually known as coal fields or basins, within which coal occurs in more or less regular beds, also called seams or veins, which can often be followed over a considerable length of country without change of character, although, like all stratified rocks, their continuity may be interrupted by faults or dislocations, also known as slips, hitches, heaves, or troubles (fig. 2).

The thickness of coal seams varies in this country from a mere film to 35 or 40 feet; but in the south of France and in India masses of coal are known up to 200 feet in thickness. These very thick seams are, however, rarely constant in character for any great distance, being found commonly to degenerate into carbonaceous shales, or to split up into thinner beds by the intercalation of shale bands or partings. One of the most striking examples of this is afforded by the thick or ten-yard seam of South Staffordshire, which is from 30 to 45 feet thick in one connected mass in the neighborhood of Dudley, but splits up into eight seams, which, with the intermediate shales and sandstones, are of a total thickness of 400 feet in the northern part of the coal-field in Cannock Chase. Seams of a medium thickness of 3 to 7 feet are usually the most regular and continuous in character. Cannel coals are generally variable in quality, being liable to change into shales or black-band ironstones within very short horizontal limits. In some instances the coal seams may be changed as a whole, as for instance in South Wales, where the coking coals of the eastern side of the basin pass through the state of dry steam coal in the centre, and become anthracite in the western side.

*British Coal-fields.*

There are about twenty principal coal-fields of Great Britain, besides several smaller ones, whose position is shown in Plate L, which may be classed under three heads:—1. Those forming complete basins, entirely circumscribed by the lower members of the carboniferous series; 2. Those in which one limb of the basin only is visible, the opposite one being obscured by Permian or other strata of newer date; and 3. Those in which the boundaries are formed by faults, which bring down the upper overlying strata into contact with the coal measures. The South Wales and Dean Forest basins are examples of the first of the above classes, the North of England and Yorkshire and Derbyshire fields of the second, and the South Staffordshire of the third. The last two classes are of the greatest geological interest, as giving rise to the important problem of their probable extension within workable limit beneath the overlying strata. Examples of the three different cases are given in Plate II,—the first being represented by the section across the Forest of Dean, fig. 1; the second by that of the Lancashire coal-fields, fig. 2; and the third by the North Staffordshire section, fig. 3.

The largest and most important of the British coal-fields is that of South Wales, South Wales coal-field, which extends from Pontypool in Monmouthshire on the east, to Kidwelly in Pembrokeshire, a length of about 50 miles, and from Tredegar on the north to Llantrissant on the south, a breadth of about 18 miles, in addition to which a further narrow slip of about 20 miles long, E. and W., extends across Pembrokeshire. Excluding the latter portion, it forms a complete basin of an approximately elliptical shape, surrounded by older rocks, the Carboniferous limestone and Devonian shale dipping generally towards the centre. The basin-shaped structure is, however, modified by a central anticlinal axis, which brings the lower bed within reach of the surface. The total thickness of the coal measures is estimated at about 11,000 feet on the south, and 7000 feet on the north side in the western district. In the central portion between Britton Ferry and the River Taff, it diminishes to 4800 feet on the north side, and is still further reduced in Monmouthshire and on the east side generally to about 2500 feet. The coal-bearing portions are divisible into three groups:

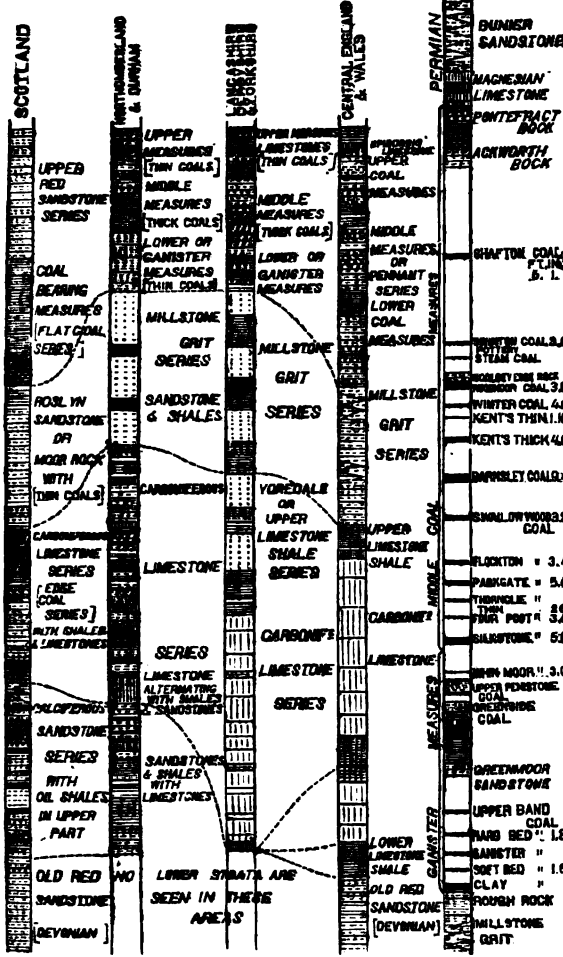

FIG. 1.—Succession of Carboniferous Strata.

latter member is marked by a thin limestone band near the top, containing *Spirorbis carbonarius*, a small marine univalve.

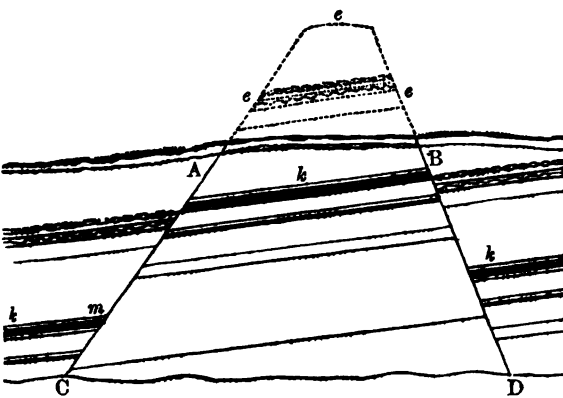

FIG. 2, representing a seam of coal k, worked towards m, interrupted by faults or hitches. The fault at AC is called an up-throw, that at BD a downthrow.

The uppermost portion of the coal measures consists of red sandstone so closely resembling that of the Permian group, which are next in geological sequence, that it is

1. Upper Pennant series.
2. Lower Pennant series.
3. White Ash series.

The Upper Pennant series attains the maximum development of about 3000 feet on the south rise of the measures near Swansea; at Neath the thickness is reduced to about 1200 feet, and in Monmouthshire to between 500 and 700 feet. It contains all the free burning and bituminous coals of the Swansea and Neath districts, and the household coals of Monmouthshire and the eastern districts, which latter contain 26 seams above 12 inches thick, making a total of about 100 feet of coal, an amount that increases westward to 82 seams and 182 feet. The Lower Pennant series averages from 1100 to 1500 feet between the Taff Vale and Llanelly, but on the north side of the anticlinal thickens to 3000 feet. The average total of workable coal in seams which do not exceed 3 feet is 25 feet, among which are some fair steam coals, associated in places with black-band ironstone and good manufacturing and household coals, yielding slack suitable for coking,—the most valuable among them being those of the Rhondda valley. The lowest or White Ash series contains the bulk of the valuable steam and iron making coals which have given the coal field its great reputation. It is about 500 feet thick on the eastern side, and about 1000 feet in the centre of the basin. The coals and accompanying ironstone are generally thicker and more abundant on the south than on the north coast. The workable coals in this division amount to about 50 feet, in seams varying from 3 to 9 feet in thickness. The western extension into Pembrokehire belongs to this part of the series; it covers about 70 square miles, extending in a narrow east and west belt, varying from 2 to 6 miles in breadth from Tenby to St. Bride's Bay. The measures are very much disturbed, but are probably about 1500 feet, containing in the upper 1000 feet 8 seams of anthracite of about 18 feet total thickness.

The total area of the coal-field is about 1000 square miles, of which amount about 153 square miles lie beneath the sea in Swansea and Carmarthen Bays. Only one square mile is covered by newer formations.

According to the quantity of the coal produced, the area is divided as follows:—

Bituminous coal district.....	410 square miles.
Anthracite “ .....	410 “
Intermediate, or Semi-Anthracite... 180	“

The most valuable class of South Wales coals is the semi-anthracite or smokeless steam coal of the lower measures, which is in constant demand for the use of ocean steamers all over the world. It is principally exported from Cardiff, Neath, and Swansea.

The configuration of the ground, owing to the deep north and south valleys of the Usk, Ebbw, Taff, Rhondda, and Neath Rivers, and the longitudinal anticlinal axis, renders the coal of comparatively easy access. The surface rises to a height of about 2000 feet above the sea-level, and in the valleys a greater vertical range is brought within working limits than is the case in any other coal-field of similar thickness.

The Forest of Dean basin is an outlying portion of that of South Wales, from which, as is shown by Ramsay, it has been separated by denudation. It is of triangular form, occupying an area of 34 square miles, between the Wye and the Severn estuary, with a total thickness of 2765 feet and 31 seams, together 42 feet thick, only 9 of which are above 2 feet in thickness. The depth from the surface to the bottom of the basin, in the centre, is about 2500 feet. The lower beds of sandstone and the Carboniferous limestone contain considerable quantities of brown hematite, in irregular deposits, which is smelted in part on the spot and partly exported to other districts. Owing to the symmetrical basin-shaped form of the measures (Plate II., fig. 1), the coals have been worked from the surface downwards along the outcrops of the seams, leaving large hollows for the accumulation of water, which render the working of the lower ground difficult, on account of the great pumping-power required to keep down the water flowing in from the old shallow mines.

North of the Malvern Hills a straggling patch of coal measures extends about 35 miles N. and S., from near Worcester to Newport in Shropshire. This is divisible into two nearly

Severn Valley coal-fields.

equal areas of triangular form. The southern part is known as Forest of Wyre, and the northern as Colebrookdale. The former is unimportant, having a great thickness of measures which rest directly on the Devonian rocks, but scarcely any workable coal seams. The Colebrookdale measures rest upon the Upper Silurian rocks, are about 800 feet thick, with about 50 feet of coal in 18 seams, and many beds of nodular ironstone, which has given the district a celebrity in the production of iron-work, especially high-class castings. The eastern boundary is concealed by overlying Permian strata, and it was formerly supposed that the productive measures had been removed by denudation on this side; but there is little doubt of their continuity towards South Staffordshire.

To the westward of Colebrookdale are the two small fields of Leebotwood and Shrewsbury. These lie on the Silurian rocks. The exposed area of the former extends to 12 square miles; that of the latter (which stretches in a crescent shape to the south and west of Shrewsbury) to 18. Both are partly hidden by Permian strata.

The South Staffordshire coal-field extends about 22 miles N. and S., from Rugeley to Halesowen, with a greatest breadth of about 10 miles from Wolverhampton to Oldbury. It is entirely surrounded by New Red Sandstone rocks, which in some places are faulted against the coal measures, rendering it difficult to decide upon the chances of a profitable extension beneath the visible boundaries. The coal measures rest upon the Upper Silurian rocks, which are exposed at several points within the area, especially at Dudley and the Wren's Nest. This district is remarkable as containing the thickest known coal seam in England, the Thick or Ten Yard Seam, which varies from 30 to 45 feet in thickness in the neighborhood of Dudley, but splits up northwards into several thinner seams in the northern or Cannock Chase district. There are 6 principal seams, with a total of from 57 to 70 feet in 1300 feet of measures. The field was formerly very productive of clay ironstone, but the supply has now considerably diminished. The coals are also subject to curious alterations in places, from the intrusion of igneous rock, especially in the Rowley Hills, near Dudley.

The Warwickshire or Tamworth coal-field is a narrow strip of measures, with a maximum thickness of 3000 feet, extending about 12 miles in a N.W. and S.E. line from Coventry to Tamworth. It contains 5 seams, which are mainly worked for house coal and steam purposes. It is entirely surrounded by New Red Sandstone strata, except for a short distance near Atherstone, where it is seen to rest upon the millstone grit, which is altered into quartzite by intrusive igneous rocks.

The Leicestershire or Ashby coal-field is an irregular patch of 30 square miles, on the east side of Charnwood Forest, about midway between Leicester and Burton-on-Trent. It has 7 principal seams, and probably rests upon the mountain limestone, except at the eastern end, where it may lie upon the old slaty rocks of Charnwood Forest. Southward it extends under the New Red marl towards Leicester. In the centre is a patch of barren measures upon which the town of Ashby-de-la-Zouche stands, after which the coal-field is often named. The eastern side, which contains the mines of Whitwick, Snibston, and Cole-Orton, contains some igneous rocks apparently connected with those of Charnwood Forest, which are not seen on the western or Moira side, which contains the more important workings. None of the seams occurring in either division can be identified with certainty in the other, although only a few miles distant. The total thickness of the coal measures is about 2500 feet, the principal seams occurring about the middle, as is also the case in Warwickshire.

North of the Trent the carboniferous strata present a more complete and regular development than is seen in the central coal-fields. The Carboniferous limestone and millstone grit formations form a central ridge of high moorlands and hills, the so-called Pennine chain, in a gently sloping anticlinal, running nearly north and south from the north of Derbyshire to the borders of Scotland. The coal measures occur on both flanks of this ridge, the largest connected mass being that of the Derbyshire and Yorkshire coal-field, which extends north and south for about 60 miles from Bradford to within a few miles from Derby, where it

S. Staffordshire coal-field.

Tamworth coal-field.

Leicestershire coal-field.

Derbyshire and Yorkshire coal-field.





# COAL

## Map of the COAL FIELDS of GREAT BRITAIN

SHOWING THE AREAS OF EXPOSED  
AND CONCEALED COAL MEASURES

Scale of Miles  
1 Inch = 20 Miles

### Index

-  Coal measures exposed
-  Coal measures covered by newer rocks
-  Pre-carboniferous rocks
-  Post-carboniferous rocks
-  Sedimentary coal workings

The concealed coal measures are indicated only within a depth of 6000 feet from surface. The areas colored black in Scotland indicate the Carboniferous basements.

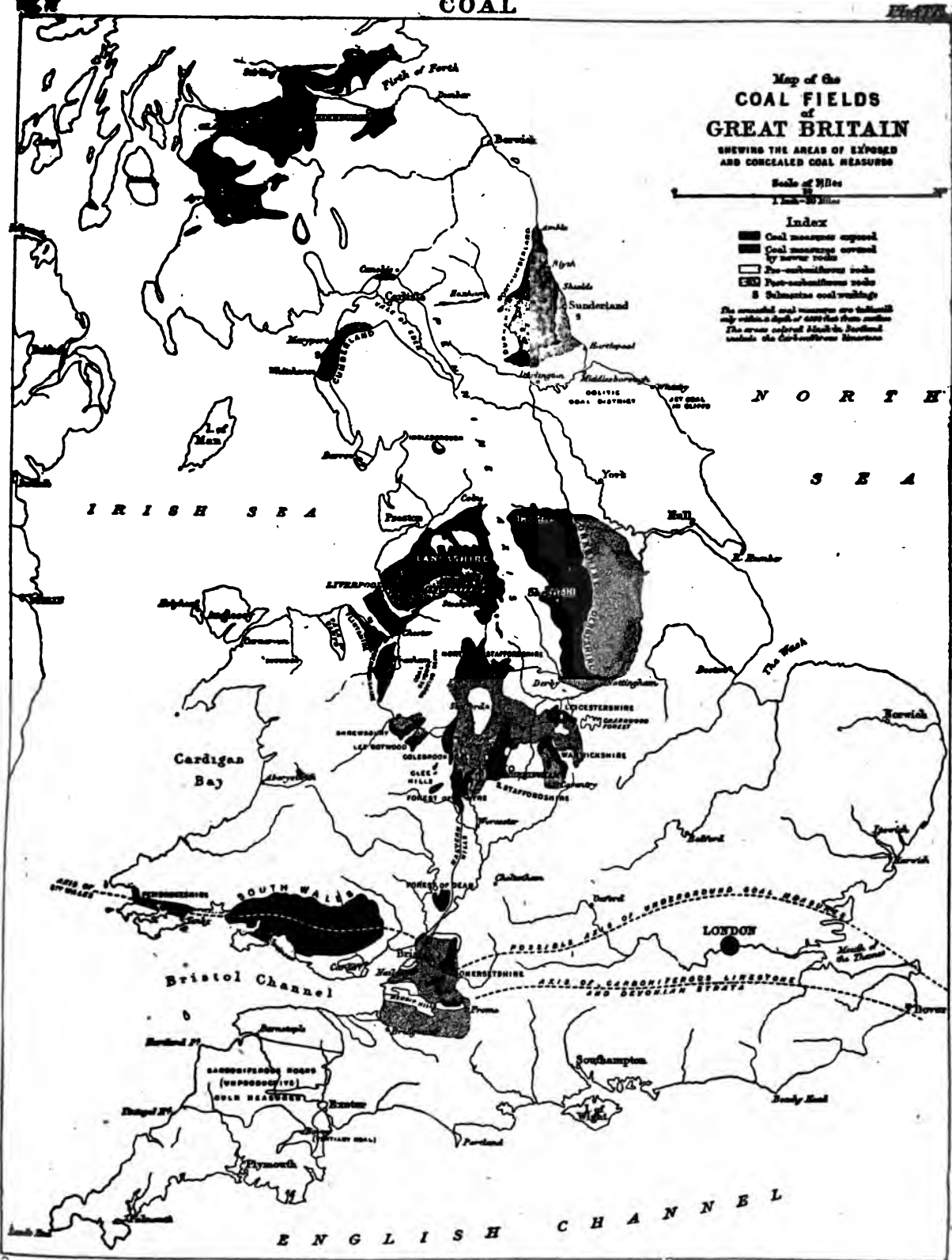



is covered by the New Red Sandstone formation. The exposed breadth varies from 9 miles at the south end to 22 miles at the north. The measures dip regularly at a low angle to the eastward, and pass under the Permian or magnesian limestone formation, which forms the eastern boundary continuously from Nottingham through Worksop and Doncaster to Wakefield. The total thickness of measures is about 4000 feet (with about 20 seams), belonging to the middle and lower ganister series, the upper series being absent. A generalized section of the strata in this coal-field is given in the fifth column of fig. 1. The principal seams are the Black shale, or Silkstone, from 5 to 7 feet thick, which is extensively worked as a house coal, and the Top hard, or Barnsley coal, which is much used for steam purposes. At the north end of the field, in the neighborhood of Leeds and Bradford, two thin seams, known as the Low Moor black bed and better bed, remarkable for their exceptional purity, are used for iron-making purposes at Bowling and Low Moor. Iron ores are also found in considerable quantity on the Derbyshire side of the field, which are smelted at Butterly and other works near Chesterfield. The area covered by the magnesian limestone formation has been proved by several borings and sinkings, the first winning having been opened at Shireoak near Worksop, where the Top hard coal was reached at 1548 feet below the surface. It is estimated that about two-thirds of the total area of this field is to be looked for within the concealed part.

**North Staffordshire coal-field.**

On the west side of the Pennine axis, and between the same parallels as the Derbyshire and Yorkshire coal-fields, are those of North Staffordshire and Lancashire, which extend from Longton on the south to Colne on the north, the continuity being, however, broken by a small fold of the Carboniferous limestone shales, which is brought to the surface between Macclesfield and Congleton. Parallel to this group, however, and to the eastward of it, is situated the small but important coal-field of North Staffordshire, also known as the Pottery coal-field. It has an exposed area of about 94 square miles, which is very irregular in form, being 17 miles in greatest breadth E. to W., and about 13 miles from N. to S. The south-eastern portion, which is nearly detached, is known as the basin of Cheadle, or Froghall, which is chiefly remarkable for a band of calcareous iron ore formerly exported to Staffordshire, but now nearly exhausted. The main or western portion consists of a mass of strata about 5000 feet thick, with 37 seams of coal, out of which 22, measuring together 97 feet, are over 2 feet in thickness; in addition to which there are many valuable beds of ironstone, both argillaceous and black-band. The strata, which are less regularly arranged than those of S. Lancashire, as will be seen by the transverse sections, figs. 2 and 3 in Plate II., being bent in contrasted curves, and much broken by faults, form the eastern limb of a basin having a general westerly dip, which carries them in a short distance below the New Red marl plain of Cheshire.

**Lancashire coal-field.**

The Lancashire coal-field is of an irregular four-sided form. The greatest breadth, from Oldham on the east to Saint Helen's on the west, is about 52 miles, and the length, from Burnley on the north to Ashton-under-Lyne, about 19 miles. Within the area are, however, two large islands of the millstone grit, which divide the northern or Burnley district from the main coal-field of Wigan and Manchester. This barren area is about compensated by a tongue of coal measure, which extends southward from Stockport to Macclesfield. The thickness of the measure is very great, and as the ground is much broken by faults, and the beds dip at a high angle, the workings have extended a greater depth than in any other district, the deepest workings being at Rose Bridge pits near Wigan, which have been sunk to 815 yards, and at Dukinfield, east of Manchester, where the Astley pit is 672 yards deep, and the coals have been wrought to a total depth of 772 yards by inclines. The greatest thickness is observed in the Manchester district, where the total section is as follows, according to Hull.

Upper Coal Measures 2013 feet.	{	Limestone series.....	600 feet.
		To Oppenshaw Coal.....	600 "
		To Yard Coal.....	485 "
Middle Coal Measures 4247 feet.	{	Barren Measures.....	1678 "
		Unknown Strata.....	.....
		Sod Mine to Black Mine.....	2000 "

Lower Coal Measures	{	Black Mine to Royley Mine. 897 feet.	
		Ganister, 1370 feet. { Royley Mine to Rough Rook. 1370 "	
		Millstone Grit.....	2000 "
		Limestone Shale, about.....	2000 "

There is a total of 100 feet of coal in workable seams (exceeding 2 feet), which are chiefly situated in the 3000 feet forming the bottom of the middle and top of the lower coal measures. In the Wigan district there are 18 workable seams, about 65 feet in all, the total section being:—

Upper Measures, barren.....	1500 feet.
Middle Measures, mass seams.....	2550 "
Ganister Measures.....	1800 "

The Wigan district is remarkable for the production of a large quantity of cannel coal.

In the Burnley district the lower and middle coal measures together are from 2500 to 3000 feet in thickness, the upper measures being unrepresented.

The coal-field of Northumberland and Durham lies north of that of Yorkshire, on the east side of the Pennine axis. In the intermediate ground between Leeds and Darlington, about 55 miles, the lower Carboniferous rocks are directly overlain by the magnesian limestone, which preserves the north and south course observed further south until it reaches the sea at the mouth of the Tyne. The coal-field extends north and south from Darlington through Durham to the mouth of the Coquet, about 65 miles, with a greatest breadth of about 22 miles in Durham. From the Tyne to the Coquet the eastern boundary is formed by the sea, while in the remaining area, from the Tyne to the Tees, which is included in Durham, the coal measures dip beneath the magnesian limestone. The measures are, as a rule, very regular, their dip being lower than that observed in other districts. The total thickness is about 2000 feet, with 16 seams of coal, together about 47 feet thick. The millstone grit is continuously exposed below the coal measures along the eastern edge as far as the Tees, where it is overlapped by the magnesian limestone and Triassic rocks, so that there is a portion of the coal-field hidden beyond the exposed southern boundary, but the extent is probably not large. The seaward extension has been proved in several deep mines in the neighborhood of Sunderland more especially at Ryhope and Monkwearmouth, which are worked at a depth of about 1850 feet to a short distance from the shore. At these points the coals are nearly flat, but at Harton, near Shields, they rise to the eastward, proving that the centre of the basin has there been passed. The best estimate gives 11 feet of coal, and about 16 square miles of area, as the probable extent of this submarine portion of the coal measures. The character of the coal produced varies in the different parts of the basin. The southern and western districts adjoining Bishop Auckland and Ferryhill produce a strongly caking coal, which is chiefly employed in the manufacture of a pure and dense coke for use in the Cleveland and Cumberland iron works, a considerable amount being also exported for foundry use. The central district, adjoining Newcastle and Sunderland, produces the best class of house coal, known in London under the name of Wallsend, from the pits on the Tyne where it was originally mined, which were close to the eastern termination of the wall built by the Romans to protect the country between the Tyne and the Solway from the incursions of the Picts. These collieries have been long since abandoned, but the name is still given in the London market to the best Durham house coals, and even to much that has been produced in other places, as indicating a coal of superlative excellence. The great merit of Wallsend coal is in its small proportion of ash, which also, being dark-colored, is not so obtrusive on the hearth as the white ash generally characteristic of the Midland coals. The strongly caking property, and the large amount of gas given out in burning, tend to produce a bright and enduring fire. In the district north of the Tyne the produce is principally steam coal, which is known as Hartley coal, being named after one of the principal collieries. It is largely used for sea-going steamers, and was lately in use in the Royal Navy mixed with South Wales coal, a combination which was supposed to give a higher evaporating value in raising steam than when either class was burnt alone. Although of a lower calorific power, and making more smoke than South Wales

**Northumberland and Durham coal-field.**

Northumberland and Durham coal-field.

coal, the north country coal deteriorates less rapidly than the former when stored in hot climates. There are two small coal-fields in the mountain limestone district of the Tyne near Hexham, and another on the Solway at Canobie; these are, however, of small importance.

The Cumberland field extends along the coast of the South Irish Channel from Saint Bees northward for 15 miles to Maryport, where it turns eastward for about 17 miles, and is exposed with constantly diminishing breadth until it disappears under the Permian rocks of the Vale of Eden. The greatest breadth is about 5 miles at Whitehaven and Workington, but, as in Northumberland and Durham, the beds dip and the coals have been worked below the sea to a distance of 1½ miles from the shore or 2½ miles from the pit. The total thickness of the measures is 1500 feet, with three workable seams. The produce is largely consumed within the district, a considerable portion of the export being to Belfast and other Irish ports.

The coal measures of North Staffordshire and Lancashire reappear on the western side of the plain of Cheshire in the coal-fields of Denbighshire and Flintshire, which form a nearly continuous tract from the neighborhood of Oswestry through Ruabon and Wrexham to the mouth of the Dee, and along the Welsh coast near Mostyn. The separation between them is formed by a slight roll in the mountain limestone near Gresford, corresponding to that dividing the two coal-fields on the eastern out-crop. The Denbighshire field is about 18 miles long, having 7 seams, together from 26 to 30 feet in thickness. The principal workings are near Ruabon, where there are several large collieries producing a much esteemed house coal. The Flintshire field is about 15 miles long. The greatest breadth is in the neighborhood of Mold, whence it narrows in a N. W. direction, being covered by the estuary of the Dea. At Mostyn coal has been extensively worked under the river, but great difficulty was experienced in keeping the mines clear of water. The details of the measures in this district have not been fully worked out, but the southern portion is the most valuable. The higher measures contain six seams, including some valuable beds of cannel, the total being about 28 feet. In the northern district bordering the Dee the beds are much disturbed by faults, but the deeper coals are said to be of good quality.

The basin formed by the North Wales, Lancashire, and North Staffordshire coal-field is probably the most extensive tract of coal measures in the country, as it may be assumed to extend under the overlying Triassic strata under the Dee and the Mersey to South Lancashire and across the plain of Cheshire, an area of 800 to 1000 square miles. Much of this, however, is far beyond workable limits, the depth to the top of the coal measures being estimated at 10,000 feet below the surface at the point of greatest depression. The area within the limits of 4000 feet below the surface, which has been assumed as a possible maximum working depth, may be seen by reference to Plate I.

There is a small coal-field in the Island of Anglesea. Anglesea, which is interesting for its geological peculiarities, but it is of very small economic value.

The Somersetshire coal-field appears at the surface in the form of several disconnected patches, the largest of which extends northward of Bristol for about 12 miles, while the remainder stretches southward for about the same distance to the Mendip hills. The Carboniferous limestone is seen at many places along the western flank, but the connection is generally hidden by a peculiar modification of the New Red Sandstone known as the Dolomitic Conglomerate, which overlaps both formations indifferently. Towards the east the measures are further obscured by the overlap of the lias and oolitic rocks, this being the only field in which such an overlap takes place in England. The exposed area of the coal measures is only about 14 square miles, but it is estimated that they extend over 238 square miles, the remainder being concealed by overlying strata. The character of the measures is similar to those of South Wales and Dean Forest, namely an upper and lower productive series separated by a nearly barren mass of Pennant sandstones. The sections, which vary very considerably, are summarized by Prestwich as follows:

Upper series.....	2600 feet thick, with 14 seams, together 26 ft. 10 in. thick			
Pennant sandstone.....	2500 to 3000	"	4	"
Lower series.....	2600	"	26	"
Together.....	7800 to 8400		46	4

The disturbance of the strata by faults is much greater than in any other British coal-field. The whole series is squeezed into a comparatively narrow trough, which throws the bottom of the basin to about 8000 feet below the surface. The coals are in some instances tilted up vertically, or even turned over, a kind of disturbance which is usually attended with considerable shattering of the strata. In one instance the upper series of measures have been shifted horizontally by an inclined or slide fault for a distance of about 200 feet above the lower series. In spite of the difficulties caused by these disturbances, coal seams of only a foot in thickness are regularly worked in Somersetshire, which is far below the limits considered to be profitable in other districts.

The coal-bearing strata of Scotland<sup>1</sup> are confined to the Carboniferous formation, the only exceptions being the little patch of Oolitic coal Scottish coal-fields. at Brora in Sutherland and certain thin seams which occur intercalated among the Miocene volcanic rocks of the Western Islands. The Scottish Carboniferous Formation is divisible into four series, viz.—1. Coal Measures; 2. Millstone Grit; 3. Carboniferous Limestone series; 4. Calciferous Sandstone series. Coal is confined chiefly to the first and third of these groups, but in West Lothian and Mid-Lothian the lowest (calciferous sandstones) yields some coals, one of which has been worked (Houston coal, 6 feet thick). These coals are associated with the well-known "oil-shales," forming a peculiar development of the upper portion of the calciferous sandstone series which is not repeated elsewhere in Scotland. The millstone grit contains no workable coals. The coal-bearing strata of the coal measures and limestone series are irregularly distributed over the central or lowland district of the country between a line drawn from St. Andrews to Ardrrossan, and a second line traced parallel to the first from Dunbar to Girvan. Throughout this region the strata are disposed in a series of basins, of which there are properly speaking only three, namely,—(1) The basin of Mid-Lothian and Fifeshire, which is bounded on the west by the calciferous sandstone series and some older strata, forming the Pentland hills, Arthur's Seat, the rolling ground that extends west of Edinburgh into Linlithgowshire, and the heights behind Burtnisland in Fifeshire, and in the east by the barren sandstones and igneous rocks of the calciferous sandstone series in the east of Haddingtonshire and Fifeshire; (2) The basin of Lanarkshire and Stirlingshire, the eastern boundary of which begins in the south at Wilsontown, and runs north by Bathgate and Borrowstonness to the borders of Clackmannan, extends west to the foot of the Campsie and Kilbarchan Hills, and is separated by the Paisley and Dunlop Hills from (3) the basin of Ayrshire, the main mass of which is bounded in the south and east by the valley of the Doon, the Silurian uplands behind Dalmellington and New Cumnock, and the calciferous sandstone and Old Red Sandstone heights which overlook the heads of the Ayr and Irvine valleys. Two small outlying coal-fields lie beyond these boundary lines, viz., the Girvan and Sanquhar (Dumfriesshire) coal-fields, but both belong geologically to the Ayrshire basin. Although there are thus only three great basins, it is usual, nevertheless, to speak of five principal coal-fields, each of which is named after the county in which it is most abundantly developed. Thus we have the coal-fields of Ayrshire, Lanarkshire, Stirlingshire, Fifeshire, and Mid-Lothian.

*Ayrshire Coal-fields.*—The Ayrshire basin, owing to undulations and faultings of the Ayrshire strata, comprises a number of subsidiary coal-fields, such as those of Girvan, Sanquhar (Dumfriesshire), Dalmellington, New Cumnock, Lugar and Muirkirk, Kilmarnock, Kilwinning, Dalry, &c. The coal measures of this basin are of variable thickness; they contain from 5 to 8 and 11 principal coal-seams, yielding a united thickness of from 13 ft. to 40 ft. The Carboniferous limestone series of Ayrshire sometimes contains no workable seams of coal, while occasionally its seams equal or surpass in number and thickness those of the coal measures. Thus in the Girvan field there are 7 coals with an aggregate thickness of 50 feet, while at Muirkirk the same number yield a thickness of

<sup>1</sup> For the following account of the coal-fields of Scotland the writer is indebted to Mr. J. Geikie, F. R. S.



40 feet of workable coal. The Ayrshire coals consist chiefly of common coals, including "hard" or "splint" and "soft" varieties. In some districts the intrusion of igneous rocks has converted certain seams into "blind coal," a kind of anthracite, much used for steam purposes. Gas or parrot coal (so called from its decrepitating or chattering when heated) is met with here and there, chiefly near New Cumnock. Parrot coal often occurs in thin lines or bands, which, when intercalated and alternating with dark carbonaceous ironstone and coaly matter, form seams of what is called black-band ironstone. The Ayrshire black-bands occur chiefly at Dalry, Lugar, and Dalsellington.

**Lanarkshire Coal-fields.**—These are the most extensive in Scotland, covering an area of not less than 150 square miles. The coal measures, which attain a thickness of upward of 2000 feet, contain about 18 workable coals; but all these are not continuous throughout the whole coal-field, while some are too thin in places to pay the cost of working. At their best they yield an aggregate thickness of 70 feet or thereabout, but in many places they do not average more than 40 or 50 feet, or even less. The limestone series is well-developed in the Lanarkshire coal-fields, but it is a very variable group, as indeed is the case throughout Scotland. It consists of upper, middle, and lower groups, the coals being confined chiefly to the middle group, only one or two seams occurring in the lower, while in the upper only one seam occasionally attains a workable thickness. The principal coals of the limestone series vary in number from 1 to 9, their aggregate thickness seldom reaching more than 15 feet. The Lanarkshire coals consist chiefly of varieties of common coal, namely, hard or splint, soft, dross, &c. But here and there excellent gas coal is worked, as at Auchenheth, Wilsontown, &c., the former being considered the finest of all the Scotch gas coals. Another well-known parrot coal is that of Boghead near Bathgate, the subject of much litigation. Parrot or gas coal frequently occurs forming a part of mussel-band and black-band ironstones, which seams, when traced along their crop, are often seen to pass into gas coal. The best known black-bands are those wrought at Palaeccraig, Airdrie, and Quarter, Bellside, Calderbraes, Bowhousebay and Braco, Goodockhill and Crofthead, Earnockmuir, Possil, Garscaden, and Johnstone.

At Quarrelton, Renfrewshire, an abnormal development of coal seams occurs below the horizon of the main or Hurlet limestone, which is usually the lowest important bed in the limestone series. The strata underlying that limestone contain here and there irregular lenticular patches of coal, never of any value. At Quarrelton, however, a number of these seams come together, and form a mass of coal more than 30 feet thick.

**Stirlingshire Coal-fields.**—These embrace the coal-fields of Falkirk, Carron, and Grangemouth, Slamannan, Clackmannan, and Borrowstonness. In the Falkirk, Carron, and Grangemouth fields, the coal measures are about 600 feet thick, and contain 9 workable seams of coal, yielding an aggregate thickness of 30 or 31 feet; the thickest seam is only 4 feet. In the Slamannan field, the coal measures are some 720 feet thick, and show 6 workable coals, yielding an aggregate thickness of 15 or 16 feet, the thickest seam being 4½ feet. A small outlier of coal measures at Coneypark, however, gives a depth of 1140 feet of strata, containing 12 workable coals (two of which are 7 feet thick respectively), which yield an aggregate thickness of 44 feet. The coal measures of the Clackmannan district attain a thickness of 900 feet, and yield 10 workable seams of coal (thickest seam 9 feet) with a united thickness of 41 feet. The limestone measures of the Stirlingshire basins contain, as a rule, few coal seams. Where these are best developed, they vary in number from 5 (Bannockburn) to 11 seams (Oakley); and their aggregate thickness ranges from 11½ feet to 37 feet. The coals embrace the variety usually met with in Scotland, viz., hard (or splint) and soft coals, some of the seams being good caking coals. Good gas coal was formerly obtained at Oakley; and other coarse parrot coals occur in various parts of the fields. Oil shale and black-band ironstone are also met with. The coal-field of Borrowstonness is remarkable for containing thick sheets of basalt rocks, which are of contemporaneous origin, and do not alter the beds that rest upon them.

**Mid-Lothian and Fifeshire Coal-fields.**—The Mid-Lothian coal-field is disposed in what are <sup>Mid-Lothian</sup> for Scotland unusually symmetrical and unbroken lines. The basins lie with their principal synclinal axes from north to south. In the deepest basin the coal measures lie in a trough 2½ miles broad and 9 miles in length, stretching from the sea at Mussalburgh through Dalkeith to Carrington. The trough is underlain by the millstone grit (Roslin Sandstone or Moor Rock), whose outcrop surrounds that of the coal measures in a band rarely more than half a mile broad. The Carboniferous limestone series rises from beneath the basin of millstone grit and coal measures on its west side, and crosses at a high angle, in a band about a mile in breadth, through Portobello, Gilmerton, and Penicuik. South of Penicuik the millstone grit forms another basin at Auchencorse Moss, but the trough is not deep enough to bring in the coal measures. West of Dalkeith the limestone series forms a shallow undulating basin with an outcrop of about 7 miles broad, extending from the sea at Cockenzie by Tranent and Pathhead. The Dalkeith basin of the coal measures has a total thickness of 1180 feet. There are 14 coal seams of a workable thickness, with an aggregate of 43 ft. 4 in. The limestone series of Mid-Lothian contains numerous coal seams. The total thickness of the series is 1582 feet, with 23 workable coal seams, aggregating 68 ft. 3 in. The "great seam" averages between 8 and 11 feet, and in one place is 12 ft. 6 in. thick. The coals of the Mid-Lothian basins are of the usual varieties met with in Scotland. The basins of the Mid-Lothian coal-fields reappear on the <sup>Fifeshire</sup> southern coast of Fife, and are undoubtedly continuous (though somewhat denuded) beneath the Firth of Forth. A segment of the western half of the coal measures trough (the prolongation of that of Dalkeith) extends from Dysart by Markinch, Kennoway, and Largo Bay. On the north this trough is bounded by faults, and on the east and south it is covered by the sea. Measured from Coalton to Methil (at right angles to the line of strike) the thickness of the coal measure strata exposed to view may be roughly estimated at 4600 feet; but as the centre of the basin is not reached at the coast, the total thickness of strata is not seen. There are about 11 workable seams, with an aggregate of 61 feet. The Dysart Main coal is 16 feet thick. Another little basin, comprising the lower seams of the coal measures, occurs at Kinglassie. The Dysart or Leven coal measure basin occupies about 18 square miles, and that of Kinglassie from 3 to 4. The limestone series of Fife lies in several much broken basins on the south side of the Ochils and Lomond Hills from Alloa to Earlsferry. The principal coal fields in this series are those of Dunfermline, Halbeath, Lochgelly, and Kelty; but coals have been worked in many other places, as at Ceres, Radernie, Largo Ward, Markinch, &c. The coal-bearing strata vary in thickness, but do not exceed 600 feet. In the Dunfermline coal-field there are 10 seams, with an aggregate thickness of 41 feet. Halbeath coal-field yields 8 seams, with an aggregate thickness of 29½ feet; Lochgelly coal-field contains some 14 seams, with an aggregate thickness of about 65 feet; in the Kelty and Beath coal-field there are 12 seams, yielding an aggregate of 43½ feet. The workable seams in these separate fields range in thickness from about 2 feet up to 10 and 14 feet. The 14 feet coal of Lochgelly is divided by thin ribs of stone which thicken out eventually so as to divide the coal into 5 separate workable seams, which, with the intervening strata, yield a thickness of 10 fathoms of strata. It is worth noting that, in the lower Carboniferous rocks of Fifeshire, two coals are worked at Balcarro and elsewhere. As a rule, this series in Scotland is barren.

The carboniferous strata of Ireland consist <sup>Ireland</sup> chiefly of the Carboniferous limestone, which covers the greater portion of the island in one connected mass. The coal measures have probably been at one time nearly as extensive, but they have been almost entirely removed by denudation, the largest remaining basins being that of Castlecomer, near Kilkenny, and another in the west, between Tralee, Mallow, and Killarney. In the north the small basin of Coal Island, on the west side of Lough Neagh, is partly covered by New Red Sandstone strata, and trials have been made to discover a possible extension of the coal measures in the valley of the Lagan, between Belfast and Lisburn.

The two coal-fields of South Wales and Somersetshire

Probable coal measures in S.E. of England.

differ from those of the central and, northern counties in their strike or direction, their longer axes being placed east and west, instead of north and south, which is the prevailing direction of the latter,—the strata in the Somersetshire area being sharply bent and broken on a north and south line in a manner which is not seen elsewhere in this country, but is reproduced on a much larger scale in the north of France and Belgium. The most easterly point in England at which the coal measures have been worked is near Bath, where the overlying Liassic and New Red Sandstone strata are about 360 feet thick, beneath which the coal has been followed for some 5 or 6 miles from the outcrop. From this point nothing certain is known of their extension until we reach the neighborhood of Valenciennes, where a coal-field, known as that of Hainault and Valenciennes, extends with a general east and west strike as far as Namur, a distance of 65 miles. At Namur the width is about 2 miles, near Charleroi from 7 to 8, and through the north of France from 6 to 7. Only the eastern half, between Charleroi and Namur, comes to the surface, the western portion being covered by Tertiary and Cretaceous strata. Within 30 miles of Calais the coal measures end, the shales of the Carboniferous limestone having been pierced in a boring of 1113 feet deep at the latter place. East of Namur the coal measures come in again at Liège, continuing for about 45 miles, with a width of from 3 to 8 miles to beyond Aix-la-Chapelle, where they are divided by a ridge of Carboniferous limestone into two parallel basins, covered by Cretaceous and newer deposits, till they appear again on the right bank of the Rhine in the valley of the Ruhr, in the great Westphalian basin, which is probably the largest in Europe.

The same general structure is apparent along the whole of this line, which, from the western end of the South Wales basin to Frome, and from the N. of France to the Ruhr, is about 470 miles long. The measures generally dip regularly from N. to S. along the northern line of outcrop where it is known, but on the southern side they are bent into sharp folds by the elevation force which has uplifted the underlying Carboniferous limestone and Devonian strata along an east and west line, extending from the old slaty rock of the Ardennes to the Mendip Hills and the western part of Pembrokeshire. The known coal fields extend for about 350 miles out of the above amount of 470, and from the similarity of their position and structure many geologists are of opinion that other basins similarly placed may be reasonably supposed to exist in the intermediate ground between Somersetshire and Belgium. This subject has been treated in great detail by Mr. Godwin Austen and Prof. Prestwich in the Reports of the Royal Commission upon Coal. The probable direction of this axis is shown on the map, Plate I. The only actual determinations of the rocks made within this area have been in two borings at Kentish Town and Harwich. In the former, sandstones, supposed to be of Devonian age, were reached below the Cretaceous strata at 1113 feet, and in the latter the Carboniferous limestone shale at 1025 feet. The most likely positions for the coal measure trough are considered by Prestwich to be in Essex and Hertfordshire, while Mr. Godwin Austen places them in the valley of the Thames or under the North Downs. The latter seems to be the more probable than the line further north. The point, however, is purely speculative in the absence of any trial borings as guides; and a great number of these would certainly be required before any generalization as to the position of workable coal measures even within a wide range could be accepted. The deep boring on the southern part of the Wealden area, near Hastings, which it was supposed would have thrown a considerable amount of light on this matter, has hitherto been without other result than the proof of the existence of a totally unexpected and exceedingly great thickness of the upper Oolitic clays, similar to what is known on the French coast, near Boulogne.

On the south side of the Mendip axis a very large area in Devonshire is occupied by the lowest coal measures or culm series, which consist almost entirely of clay slates, with a few beds of anthracite in the northern portion of the district, near Barnstaple and Bideford. These are only worked to a small extent, their principal use being, not for fuel, but as a pigment for covering iron-work, which is known as Bideford black.

The coal-bearing areas of Secondary and Tertiary age in the United Kingdom are of very small importance. In Devonshire a lignite-bearing series of strata of Miocene age occurs in the flank of the granite of Dartmoor at Bovey Tracey, near Newton Abbot. This is principally remarkable for its associated clays, which are derived from the waste of the granite, and contain numerous impressions of dicotyledonous leaves and other plant remains. The coal is a lignite resembling a mere heap of tree stems drifted together and partially decomposed. It is not now worked, the original excavations being filled with water; and as the demand is restricted to supplying the wants of the local potteries, there is no opening for profitable mining.

British Secondary and Tertiary coals.

In the great Oolite of Yorkshire some thin seams of coal or lignite were formerly worked at numerous points upon the moors between the Cleveland Hills and the Vale of Pickering. The most important product of this district, however, is the jet which is obtained from the waste of coal-bearing strata of the same age along the cliffs near Whitby, where it is manufactured into ornaments. The largest Oolitic coal deposit in this country is that of Brora, in Sutherland, where a seam of about 3½ feet in thickness has been worked at intervals for a considerable period, but never to any considerable extent except during the prevalence of high prices in the coal trade.

Another area in which coal is found in strata of Secondary age is that of Scania, near Helsingborg, in south-western Sweden, in the three coal-fields of Hoganas, Stabbarp, and Rödödinge. These are situated in the uppermost Triassic or Rhenish series. At the first, which is the most important locality, the strata vary from 100 to 800 feet in thickness, with two seams of coal respectively 1 and 4½ feet in thickness. There is a good fire-clay associated with the lower seam, which is extensively worked for fire bricks and pottery, a large proportion of the coal being used on the spot. In the Danish Island of Bornholm similar coal-bearing strata, probably of Liassic age, form a narrow belt along the south and south-west coast, which it is supposed may continue under the alluvial plain of the Baltic into Pomernia.

Continental Secondary coals.

#### *The Coal-fields of the Continent of Europe.*

The coal-fields of the continent of Europe, though more scattered and disturbed than those of England, may be similarly divided into two groups according to their geological structure, the first being those in which the series is complete, the coal measures being symmetrically arranged upon the Carboniferous limestone and Devonian strata. Examples of this structure are afforded by the long line of coal-fields extending through the north of France and Belgium to the Rhine valley on the north side of the Ardennes, and those of the more easterly district of Silesia and of the north of Spain. The remaining and far more numerous European coal-fields are either contained in hollows in crystalline schists, or rest on the older Palaeozoic rocks, e.g., the central and southern French basins, and those of Saxony and Bohemia. Further east, in central and southern Russia, the order observed in Scotland is reproduced, there being a large development of coal in Carboniferous limestone strata, and something of the same kind seems to be probably the case in China.

The best developed portions of the Franco-Belgian coal-field are seen within the territory of Belgium, the westerly extension into France being entirely covered by a great thickness of newer strata. Commencing at the eastern side, the first field or basin is that of Liège, which extends from the Prussian frontier near Verviers in a S.W. direction for about 45 miles, the greatest breadth being about 9 miles near Liège. The principal working points are concentrated on the western edge, where the lower beds rest on the Carboniferous limestone, the eastern portion being partly covered by Cretaceous and Tertiary strata. The number of coal seams is 83, the upper series of 31 being so-called fat coals, suitable for coking and smiths' fires; the middle series of 21 seams are semi-dry or flaming coals; and the remainder or lower series of 31 are dry, lean, or semi-anthracitic coals. The upper series, which are the most valued, are found only in a small area near the centre of the basin at Ougrée, near Liège. The seams vary from 6 inches

Franco-Belgian coal-fields.

to 5½ feet in thickness, the average being barely 3 feet. This order of succession is observed in the whole of the districts along this axis. The same general structure also prevails throughout the strata which have a comparatively small slope on the northern crop, and are very sharply contorted, faulted, or broken along on the south side of the basins. The local terms *plateaux* and *dressants* are used to distinguish the flat and steep portions of the coals respectively.

The next basin, that of the Sambre, extends for about 30 miles from Namur to Charleroi, the greatest exposed breadth being about 9½ miles. The western and a greater part of the northern side are covered by Tertiary strata, which are very heavily watered. At Montceau, near Charleroi, there are 73 seams, which pass through the various conditions of fat, flaming, and dry coals, from above downwards, according to the order already described.

The most important development of the coal measures in Belgium is in the basin of Mons, which extends from Mons to Thulin, a length of about 14 miles, with a breadth of about 7 or 8 miles, a large portion of the area being covered by newer strata. The number of known coal seams is 157, out of which number from 117 to 122 are considered to be workable, their thickness varying generally between 10 and 28 inches, only a very few exceeding 3 feet. These are classified, according to position, into the following groups, which are taken as a standard for the whole of the north of France and Belgium:—

1. Upper series (*charbon fenu*) 47 seams. These, which occur chiefly in the neighborhood of Mons, are very rich bituminous coals, especially adapted for gasmaking.

2. Hard coal series (*charbon dur*), 21 seams. These are, in spite of their name, soft caking coals, less rich in volatile matter than the fenu, but excellent for coking purposes.

3. Forge coal series, 29 seams. These are chiefly used for smithy purposes and iron works, but the lower members approximate to dry steam coals.

4. Dry or lean coals, 20 to 25 seams, forming the bottom series. They are of small value, being chiefly used for brick or lime burning.

The amount of compression to which the strata have been subjected in these coal-fields, has caused them to be sharply contorted into zig-zag folds. In the neighborhood of Mons a single seam may be passed through six times in a pit of 350 yards vertical depth, and the strata, which if flat would be 9 miles broad, are squeezed into a space 7 miles across and about 8200 feet deep to the bottom of the basin. At Charleroi the compression is still greater, a breadth of 8½ miles of flat strata being narrowed to rather less than half that quantity by contortion into 22 zig-zag folds.

The thickness of the overlying Tertiary and Cretaceous strata in the neighborhood of Mons is from 500 to 900 feet; towards the French frontier the thickness is between 200 and 400 feet, and at Valenciennes about 250 feet. At A niche these overlying measures, or *terrains morts*, are 400 feet thick, below which the coal measures are found to contain 23 feet of coal in 12 seams. At Anzin, near Denain, there are 18 seams, together 39 feet, which is about the maximum development in the north of France. This coal-field, which was unknown before 1734, has reached a very high state of production in spite of great difficulties interposed by the water-bearing strata covering the coal measures. It extends for about 45 miles, diminishing in extent and value to the westward. The structure is very similar to that of the Belgian, one of the most remarkable features being the inclined fault called the *cran à retour*, which brings the lower or dry coal series of the north side against the higher coking coals of the south side, as shown in the section, Plate II. fig. 4.

At Hardingen, near Boulogne, a small patch of disturbed coal strata was formerly worked. These are now supposed to be of the age of the Carboniferous limestone.

The coal-fields of central and southern France are mostly small in area and irregular in structure, with at times remarkable single accumulations of coal of enormous thickness, which do not, however, extend for any distance. The most important basin is that of Saint Etienne and Rive de Gier, south of Lyons, on the right bank of the Rhone. It is of triangular form; about 28 miles long, with a base of 8 miles. The thickness of the three principal seams at the

latter place is about 33 feet, but at Saint Etienne there are from 15 to 18 seams, making together about 112 feet in a total depth of measures of about 2500 feet.

The basin of the Saône et Loire, near Chalons and Autun, is about 25 miles long in a S.W. and N.E. line. At Creusot, on the north crop, the coals, which are in places extremely thick (the main seam averaging 40 feet, but occasionally swelling out to 130 feet), dip at a high angle below a covering of New Red Sandstone strata, and appear in a modified form, both as regards thickness and position, on the south side at Blanzay. An attempt has been made to prove the continuity of the series in the bottom of the basin by a deep boring, which was, however, abandoned at a depth of over 3000 feet without passing through the overlying strata. At Montchanin a remarkable seam or mass of coal was found extending for about 650 yards, with a thickness varying from 60 to 200 feet at the surface, which, however, diminished to one half 60 yards down, and wedged out at 140 yards deep. Another coal-field of considerable importance is that of Alais and Grand Combe, near Nîmes, which is partly covered by Liassic strata, and has a total maximum thickness of 80 feet of coal.

In addition to these must be mentioned the anthracitic series of the Alps, which extend along the flanks of that chain from Savoy and the Tarentaise into Styria and Carinthia. They are of small economic importance.

The Secondary and Tertiary coals of France are of comparatively small importance. Lignite is worked, among other places, near Dax in the Pyrenees, and at Trets and Fuveau near Marseilles.

The coal-fields of Prussia, situated on the German extension of the Franco-Belgian axis, are the two small basins of the Inde and Worm, east of Adelnau, near Stolberg and Eschweiler, which are included in single sharply sloped folds of the mountain limestone, and the great Westphalian basin east of the Rhine, in the valley of the Ruhr. The latter, which is one of the most important in Europe, extends for about 30 miles east and west from Essen to Dortmund. The breadth is unknown; the beds are exposed for about 15 miles at the broadest part, but the actual boundaries to the north and north-east are hidden by Cretaceous rocks. The greatest depth from the surface to the bottom of the basin is probably about 5000 feet. It is divided lengthways by transverse axes of elevation into four principal basins, besides several smaller ones. The total thickness of measures already proved is from 6000 to 8000 feet, with about 130 seams of coal, together about 300 feet thick. These are divided into three series by two bands of barren measures. The thickness of the individual coal seams varies from 8 inches to 7 feet. Seventy-six are considered to be workable, having a combined thickness of 205 feet, and 54 are unworkable, containing 42 feet of coal. The proportion of workable coal to the whole thickness of strata is as 1 to 33. The order of succession as regards quality is similar to that observed in Belgium, the most highly valued gas and coking coals being at the top of the series, and the dry semi-anthracitic seams at the bottom. On the south side of the axis of the Rhenish Devonian strata, which is the high ground known as the Eifel and Hunsrück, carboniferous strata reappear in what is known as the Pfalz-Saarbrücken basin, occupying a rectangular area between Bingen, Donnersberg, Saarbrücken, and Mettlach, about 60 miles long and 20 miles broad, the productive coal measures being restricted to a triangular space of about 175 square miles in the S.W. corner. The Carboniferous limestone is absent, but the thickness of the coal measures is very great, the upper or Ottweiler series measuring from 6500 to 11,700 feet, with about 20 feet of coal in different parts of the district, and the lower or Saarbrücken series from 9000 to 5200 feet, with 82 workable and 142 unworkable coal seams, making a total of about 350 to 400 feet of coal. The greatest thickness of the upper strata is found in those localities where the lower are thinnest, but the total thickness is computed to be about 20,000 feet in the thickest known section. The coals of the lower division are divided into groups by certain well-marked horizons, usually prominent seams, which have this peculiarity, that the best coking and gas coals are found in the bottom of the series, and the drier ones at the top, thus reversing the order observed in the basins on the northern slope. The amount of hygroscopic water in the coal is also found to diminish downwards.

In the district between the Ems and the Weser, are situated the small coal-fields of Ibbenbüren, on the easterly extension of the Westphalian basin, and the Piesberg, near Osnabrück, which are of true Carboniferous age. Besides these, there is a curious development of coal in the Wealden strata which extend in a narrow discontinuous band E. and W. for about 150 miles. The coals are or have been worked at Tecklenburg and Borgloh in the Teutoburger Wald, at Bückeburg in Schaumburg, and in the Osterwald south of Hanover. The coal seams are small and of inferior quality, but are interesting as showing how nearly the conditions prevailing at the time of the older coal measures were repeated over a part of the same era in Cretaceous times. There are traces of thin discontinuous coal-beds in the Wealden strata of Sussex, but nowhere approaching to the extent of those in the Wealden strata of N. Germany.

In the low ground north of Halle, small and irregular patches of coal measures are found at Westin, Löbejun, and Plötz. These are probably the remains of a single coal-field which has been disturbed and broken up at the time of the eruption of a great mass of igneous rocks which is found in a nearly central position between them. The coal measures are also found in the Thüringer Wald, the Schwarzwald, on the south side of the Harz, and in the Bavarian Oberpfalz, but none of these localities are important as centres of production. In Saxony there are two principal coal-fields, the first being that of the Plauensche Grund, near Dresden, which is chiefly interesting for the very disturbed condition of the measures, and the consequent difficulty in working; and the other that of Zwickau, which is one of the most important in Europe. It forms an elliptical basin, about 20 miles long, between Zwickau and Chemnitz, and from 6 to 7 miles in maximum breadth, the greater portion being covered by New Red Sandstone strata. The coal measures, which rest upon old argillaceous schists, are about 1760 feet thick at a maximum, containing 12 principal seams of coal, besides several smaller ones. The most important is the so-called soot coal (Russkohle), which at times attains to a thickness of 25 feet. The series is divided by Geinitz into groups, according to the prevailing character of the associated fossil plants, as follows:—

1. Zone of Ferns, corresponding to the upper group.
2. Zone of Annularia and Calamites, or middle group.
3. Zone of Sigillaria, or lower group.

A fourth or Sagenaria zone, found in Silesia, corresponding to the culm measures of Devonshire, completes this classification.

The most important coal-fields of Eastern Europe are those of Silesia. The Carboniferous limestone series and the lowest coal measures or culm strata reappear in these basins, and are associated with numerous valuable mineral deposits, mainly of zinc and lead ore. The coal-field of Lower Silesia and Bohemia forms a basin between Glatz, Waldenburg, Landshüt, and Schatzlar, about 38 miles long and 22 miles broad. The number of seams from 3½ to 5 feet thick is very considerable (from 35 to 50); but it is difficult to trace any one continuously for any great distance, as they are liable to change suddenly in character. The lower seams usually lie at a higher angle than those above them. There does not appear to be any relation between the coking power of the coals and their geological position, and the same seam often varies in quality in neighboring mines.

The upper Silesian coal district extends in several disconnected masses from Mährisch-Osttau in Moravia, in a N.W. direction, by Rybnik and Gleiwitz in Prussia, and Myslowitz in Poland, being held partly by Austria, Prussia, and Russia, the Prussian portion between Zrabze and Myslowitz being the most important, extending over 20 miles in length, by nearly 15 in breadth. The greatest thickness of coal in workable seams (from 2½ to 60 feet thick) is estimated at a total of 333 feet, the thickness of the measures being about 10,000 feet. A very large proportion of this coal-field is hidden by New Red and Cretaceous strata.

The Tertiary coals or lignites of Germany are of considerable importance, being distributed over large areas, the seams often attaining a great thickness, although rarely continuous for any great distance. The principal deposits are situated in the lower parts of the valleys of the Rhine and the Elbe, in Nassau, and in the high ground of the Rhon in Bavaria. The lignite district of the Rhine ex-

tends from near Bonn down to Deutz and Bensberg below Cologne. The pigment known as Cologne earth is a sepia-colored lignite, which can be ground to a fine powder when dried. In Nassau the so-called bituminous wood, a variety of lignite containing flattened masses of wood of a light brown color, is very common. The produce of these districts is mainly consumed for house fuel and steam boilers, some small quantity having been used for the production of paraffine and photogen oil.

The coal-fields of the empire of Austria-Hungary are of very considerable interest, from <sup>Austria.</sup> the great diversity in their geological position. Coals of Carboniferous age are mainly confined to the northern provinces of Bohemia, Moravia, and Silesia; but in Hungary and the Alpine lands, especially in Styria, coals of Tertiary age are found, which approach very closely in composition and quality to those of the coal measures.

First in importance among the former class, is the basin of Pilsen in Bohemia, which covers an area of about 300 square miles. It rests upon Silurian shale, and is covered unconformably by Permian conglomerate and sandstone. The coals vary considerably in different localities; the total thickness of the workable seams, from 3 to 5 in number, does not exceed 20 feet. There is a remarkable bed of slaty canal in the upper part of the series, which contains animal remains of Permian types associated with the ordinary coal flora. Another important basin, that of Schlan-Kladno, E. of Prague, appears along the north edge of the Silurian strata, extending for about 35 miles E. and W. At Kladno, where it is best developed, it contains two principal seams, of which the upper is from 10 to 20 feet, and the lower or main seam from 19 to 40 feet thick.

At Rossitz, near Brünn, in Moravia, a belt of coal measure, resting upon crystalline rocks, has been considerably worked. There are three seams, together from 27 to 30 feet thick. These beds are said to be the equivalent of the upper seams of Pilsen and Kladno.

In Moravia, Silesia, and Poland the coal measures are associated with the mountain limestone, which in Central Germany, east of Westphalia, is generally absent. The upper Silesian coal-field is situated in Prussia, Austria, Silesia, and Russian Poland, the largest portion being in the first country. The area of this basin is about 1700 square miles, a considerable portion of it being hidden by Secondary and Tertiary strata. In the Austrian portion at Ostrau in Moravia there are 370 seams, of which 117 are workable, with a thickness of about 350 feet of coal. The largest seams are situated in the upper series, the principal one being about 13 feet thick. The coals of the neighborhood of Ostrau are very full of gas, which occasionally finds its way into the cellars of the houses in the town, besides giving off large quantities of fire damp in the workings. A bore hole put down 150 feet to a seam of coal in 1852, gave off a stream of gas which was ignited at the surface, and has continued to burn, with a flame many feet in length, to the present time. The same coal-field extends into the district of Cracow, where it contains numerous seams of great thickness, which, however, have been but partially explored. In the Austrian Alps anthracitic coals occur at various points along the northern slopes, in strata of the age of the culm measures, but nowhere in any great quantity. In the Carpathian countries true coal measures are not largely developed, the principal locality being near Reschitza in the Banat, where 4 seams, from 3 to 10 feet in thickness, are worked to a certain extent.

At Steyerdorf, near Oravicza on the Danube, a remarkable coal-field is found in the Lias. There are 5 seams, from 3 to 7 feet in thickness, which are bent into an antidual, besides being disturbed by numerous faults. The coal is of a very good quality, yielding a coke suitable for iron-smelting. The annual production is about 260,000 tons. Similar coals occur in the Lias at Drenkowa, and near Fünfkirchen, where there are 25 workable seams, together about 80 feet thick, also of a good coking quality, but very tender in working, making a great deal of slack.

Secondary coals occur in the Trias and Oolitic strata at various points in the Alps, but are only of local interest.

In the Gosau strata belonging to the chalk, coal is worked at various points in the Alpine lands, the average annual production being about 25,000 tons. Eocene coals occur in Dalmatia, and Miocene lignite in the Vienna basin in

Southern Moravia, one seam, about 10 feet thick, covering an area of about 120 square miles. In the Styria-Hungarian Tertiary basin, Tertiary coals are developed on a very great scale, especially in Styria, at Salgo Tarjan in N. Hungary, and in the depression between the Matra and the crystalline rocks of Upper Hungary. These localities represent only those best known by workings, many more being undeveloped. The lignite beds are often of great thickness, e.g., 70 feet at Hrasnigg, and 130 feet at Trifail. The production of Tertiary coal in Styria is about 500,000 tons annually. At Leoben and Fohnsdorf, lignites are worked of a quality closely approaching to that of Carboniferous coal, and are largely consumed in the production of iron and steel, having almost entirely replaced charcoal in the local forges. In Bohemia, Miocene brown coal strata cover a very large area, the principal basins being those of Eger, Carlsbad, and Teplitz, together about 600 square miles, the main seam occasionally attaining a thickness of over 100 feet. The trade in this coal is very considerable along the entire valley of the Elbe.

**Russia.** The coal-fields of Russia have been but imperfectly known until a comparatively recent period, when the demand for fuel caused by the extension of railways and the increase of manufacturing industries has stimulated explorations, which have resulted in the discovery of coal-bearing strata of considerable magnitude and extent. These belong to the period of the Carboniferous limestone, like the lower coals of Scotland.

In Central Russia the coal-bearing area belonging to the Carboniferous limestone is said to cover about 13,000 square miles, the centre of the basin being at Tula, S. of Moscow. There are two principal seams, 3 ft. 6 in. and 7 feet thick, in the bottom of the series near the top of the Old Red Sandstone. The coal is of inferior quality, containing about 12 to 16 per cent. of ash, and from 2 to 5 per cent. of sulphur.

In Southern Russia, between the river Donetz and the head of the sea of Azoff, a more important coal-field occurs, also in the Carboniferous limestone, covering an area of 11,000 square miles. There are sixty seams of coal, forty-four being workable, with a total thickness of 114 feet. The best is a dry or semi-anthracitic coal, resembling that of South Wales. At Lugan and Lissitchia Balka, a thickness of 30 feet of coal is found in 900 feet of strata.

In the Ural, coal is found in sandstones, interstratified in the Carboniferous limestone in the district north of Perm, between the parallels of 57° and 60° N. latitude. The strata dip at a high angle to the west, under the Permian strata. The thickest coals are at Lithwinsk at the northern end, where there are three seams worked, measuring from 30 to 40 feet each; further south they become thinner. The coals appear to be similar in quality to those of the central coal-field.

In Poland, about Bendzin and Lagorze, N. of Myslowitz, an extension of the Upper Silesian coal-field covers an area of about 80 square miles, being partly covered by Permian strata. Nine seams of coal are known, varying from 3 to 20 feet in thickness; but they do not occur together, except in a small part of the centre of the basin. The aggregate thickness of coal is about 60 feet. This is the only district in which true coal measure strata are found in European Russia.

**Spain.** Among the southern countries of Europe, the first place must be given to the coal-fields of Spain, but even these are of comparatively small importance, when measured by a northern standard, consisting of a few small and scattered basins, in which both Carboniferous and Secondary coals are represented. The Carboniferous limestone acquires a considerable development in the Cantabrian chain along the north coast, and is associated with overlying coal measures near Oviedo and Leon. In the former area the coals are often considerably disturbed, becoming anthracitic at the same time. The best seams are from 5 to 8 feet thick. In the Sotero valley near Sotillo, N.E. of Leon, a seam called El Carmen, averaging 60 feet, is sometimes 100 feet thick, and is said to be in places associated with another which is occasionally 180 feet thick. Another basin of importance is that of Belmez and Espiel, occupying a narrow valley in older Palaeozoic strata, about 20 miles north of Cordova, which has recently been traversed by a railway connecting it with the main lines from Lisbon and Cadiz. This produces coking and gas coals of good quality, which are in considerable demand for smelting in the lead

and other mineral districts in the neighborhood. The other principal localities are at Villanueva del Rio near Seville, and San Juan de la Abaderas in Catalonia. Coals of Neocomian age are found at Montalban, in the province of Teruel, and lignites of Miocene age, among other places, at Alcoy in Valencia, and Calas in Catalonia.

In Portugal a small tract of lower Carboniferous strata, containing anthracite, occurs at San Pedro de Cova, near Coimbra, but the produce is very small. Portugal.

In Italy there is very little Carboniferous coal, what does occur being mainly of an anthracitic character in very disturbed strata in the Piedmontese Alps. Tertiary lignites are worked at several places in Tuscany and in Naples, but the total output is inconsiderable when measured by the standards of more northern countries. Italy.

#### *Extra-European Coal-fields.*

In Turkey, Carboniferous coal is found at Heraclea in Asia Minor, and has been worked from time to time, but hitherto without much influence upon the coal produce of Europe. Lignites are known to occur near Smyrna, and in the Lebanon and various other points in Syria. Turkey.

It is doubtful whether any Carboniferous coal exists in Africa. Coal-bearing strata, probably of the age of the New Red Sandstone, the so-called Karoo beds, cover a considerable area, both in the Cape Colony and Natal, but little is known of the details of the coal-beds beyond statements of the excellence of the quality of the coals. Lignite occurs in the high lands of Abyssinia, and probably at numerous other points in the interior. Africa.

The coal-bearing strata of India occur in numerous detached basins, which are widely distributed over the whole peninsula, their aggregate area, however, being but small. The principal development is in the valley of the Damodar river, one of the southern tributaries of the Hugli, the largest coal field being that of Raniganj, on the line of the East Indian Railway, about 140 miles W. of Calcutta, which covers an area of 500 square miles. It is a basin resting upon crystalline schists, and partly covered by Triassic sandstones in the centre, and by jungle and alluvium to the eastward, so that the real area is not yet known. The strata are divisible into three series as follows:— India.

- Upper or Raniganj series—coal-bearing.
- Middle or Ironstone series—no coals.
- Lower or Barrakur series—coal-bearing.

The total thickness may be from 3000 to 4000 feet; the ironstone series is a group of shales containing nodular ironstone about 1500 feet thick, but diminishing westward. Numerous coal seams are worked at different points, but they cannot be traced continuously for more than a short distance without change. In the upper series an average of 11 seams, together about 120 feet thick, are known in the eastern or Raniganj district, and 13 seams, together 100 feet, on the western side. Occasionally single seams acquire a great thickness (from 20 to 80 feet), but the average of those worked locally is from 12 to 18 feet. In the lower series, 4 seams, together 69 feet, are known. The coals are generally of inferior quality, containing a considerable amount of ash, and are non-coking in character. The coals of the lower series are better, yielding fairly good coking and gas coal at Sanktoria, near the Barrakur River.

A small coal-field at Kurhurbali, near Luckeeserai, on the East Indian Railway, has recently been developed to a considerable extent for locomotive purposes. It covers about 11 square miles, with an aggregate of 3 seams, varying from 9 to 33 feet in thickness. They are of better quality than those of any other Indian coal-field at present known, and are of great value to the railway, which is now supplied with fuel at a lower rate than probably any other railway company in the world.

There are several other coal-fields in Bengal, especially that at Jherria, near the sacred mountain of Parismath, those south of Hazaribagh, and those on the Some River, but none are as yet developed to any extent, being away from the great lines of communication. On the western side of India the principal workings are at Mopani, on the Nerbudda, on the line of the Great Indian Peninsula Railway, the coal being used by the railway. It is of inferior

quality, and the strata are inclined at a considerable angle, rendering the working difficult.

In the Central Provinces a new coal-field of considerable extent has been recently discovered, almost entirely by boring, on the Wardha and Chanda districts, on the upper tributaries of the Godavari, a considerable portion being within the Nizam's province of Berar. It is probable that this may become one of the most important sources of coal supply for Central and Western India, but no great amount of work has as yet been done upon it.

Besides the above, there are several other known coal-fields, for details of which the reader is referred to the Reports of the Geological Society of India.

The age of the Indian coals is generally supposed to be Permian, the only fossils that have been found in them being plants which are referred to Permian types in Europe. If, however, the overlying sandstones, containing reptilian fossils, generally reputed to be of Triassic age, should, as seems likely, prove to be Permian, it is not improbable that the coal-bearing strata may actually belong to the period of the upper coal measures, and the Indian coal-fields would then be strictly analogous to the deep irregular basins of Southern France and Central Europe, with which they have many structural points in common. No marine strata, or anything approximating to the character of the Carboniferous limestone, are known anywhere on the plains of India, although they are found in the salt range of the Punjab and in the Himalayas.

The coal-fields of China are known, from the researches of Baron von Richthofen, Prof. Pampelly, and other travellers, to cover a very large area, comparable only with those of North America; but, as may be imagined, no very detailed information has as yet been obtained concerning them. According to the first-named authority, there are no newer formations than the Trias in China other than alluvial deposits of enormous thickness, but Palæozoic strata, from the Silurian upwards, are developed on a very large scale. Coal of Carboniferous age exists in Manchuria, mostly in inaccessible mountain valleys, and further west all along the Great Wall. Near Peking there are beds 95 feet thick, which supply the city with fuel. The most extensive development is to the west and north-west, on the south of the great mountain range which stretches across Western China, where there is an area of Carboniferous strata of 100,000 square miles. The great plain of China is bounded by a limestone escarpment from 2000 to 3000 feet high, which is capped by a plateau covered by 30,000 square miles of coal measures, in which the coal seams, 30 feet thick, lie perfectly horizontal for 200 miles, and are reported to extend beyond the frontier into Mongolia. Most of the localities are, however, far in the interior. The coal of Shantung, though not near good harbors, is the most accessible of all Chinese coal from the sea. It also occurs in the other maritime provinces, but in districts offering fewer facilities for export. It is obvious, from the enormous dimensions given to these coal-fields, that it will be a long time before anything like a moderately accurate estimate of their value can be obtained.

In Japan coal is worked at several points, but no detailed account of the mode of its occurrence has been published. At the island of Takasima, near Nagasaki, a colliery is worked by the Japanese Government for the supply of their steamers on a tolerably large scale.

In the great islands of the Indian and South Pacific Oceans, coal-bearing strata are known at many different points; but in the absence of systematic investigation, no general estimate can be formed of their position, extent, or value. In the Dutch settlements, coal has been found in

**Borneo.** Sumatra and Borneo, the best known deposit being that of Pengaron, on the south-east of the latter island, where a mine has been worked by the Dutch authorities for several years. The section of the strata, as proved by a level, shows a series of 15 seams above 1 foot in thickness, together about 36 feet, in about 520 feet of measures, 6 of these having been worked. The best appear to be somewhat similar to the steam coal of the North of England. In the British settlement of Labuan, off the north coast of Borneo, 5 workable

**Labuan.** seams, together about 27 feet thick, are estimated to cover the whole island. This is probably of Tertiary age, but approximates in composition to many of the non-coking coals of the coal measures. The Labuan coal

is also remarkable for containing large masses of fossil resin.

The most important southern coal deposits, **Australia.** however, are those of Australia, which extend, with short intervals, from the Gulf of Carpentaria to Bass's Straits. In the northern districts, the distribution appears to be somewhat similar to that seen in South America, Secondary and Tertiary basins occupying the ground near the sea, while true Carboniferous coal is found further inland; but in New South Wales, where their development is greatest, older coal-bearing strata extend along the eastern slope of the continent, between the parallels of 29 and 35 degrees S. latitude, covering a very large area in several detached portions, the largest probably exceeding 12,000 miles, and come down to the sea. The principal workings are situated near Newcastle, at the mouth of the Hunter River, at Wollongong, 60 miles south of Sydney, and at Hartley, about 90 miles inland. The coal seams vary from 3 to 30 feet in thickness in the Newcastle district, 16 seams above three feet thick being known. The coals are mainly of a free-burning class, but some are bituminous, giving a good coke. In the uppermost part of the series oil shales and cannel are found. The age of the Australian coal measures has been the subject of considerable controversy. Formerly it was supposed that they were Oolitic, from the supposed affinities of the fossil plants; but it has since been shown that the coal-bearing portions of the series are interstratified with marine strata, containing fossils of Carboniferous and Devonian types. The same association is observed in the coal series of Bowen River in Queensland, and on those of the Mersey River in Tasmania, showing the extension of the Carboniferous strata in a chain of detached basins from the 20th to the 40th parallel of S. lat., or about 1400 miles. In Queensland the strata are estimated to cover an area of 24,000 square miles, without taking into account possible extension under the Cretaceous strata of the interior. Up to the present time, however, very little has been done towards their development, the districts in which they occur being too far from the settled portions of the country. The principal mines now open are on newer strata of Cretaceous age nearer the sea, at Ipswich, in the neighborhood of Brisbane. Some of these coals are remarkably like those of South Durham, and yield a good hard coke, suitable for blast-furnace purposes.

True coal measures are not known to exist in **New Zealand.** but coal-bearing strata of two different periods have been described by Dr. Hector, Dr. Haast, Captain Hutton, and other geologists. The newer series yield a lignite, which is described in the reports as hydrous coal; while the older, which is probably of Cretaceous or Jurassic age, yields a superior class of combustible, known as anhydrous coal. These minerals occur at many different points in the two larger islands, and although no systematic detailed account of them is as yet available, a considerable amount of information on this subject is contained in the various geological reports published by the New Zealand surveyors.

In North America, the Carboniferous strata are divided by geologists into two principal **North America.** groups,—the lower or sub-Carboniferous, which correspond to the Carboniferous limestone of Europe, and the Carboniferous, which includes the millstone grit and coal measures.

The first of these is about 5000 feet thick in Pennsylvania, consisting mainly of shales and sandstones; but in the Mississippi valley, in Illinois, Iowa, and Missouri, a considerable thickness of limestone is developed in this part of the series. In the former region some thin coal seams are found, the relation between the two areas being in this respect similar to that of the Carboniferous limestone in England to the coal-bearing formations of similar age in Scotland.

The millstone grit forms a mass of sandstones and conglomerates from 1200 to 1400 feet thick in Eastern Pennsylvania, but thins rapidly to the westward, being only from 100 to 250 feet thick in Ohio and Tennessee. In Arkansas, the compact siliceous rock known as novaculite, or Arkansas hone stone, occurs in this member of the Carboniferous series.

The coal measures proper cover a very large area, both in the United States and in Canada. First in importance is the Appalachian coal-field, covering about 60,000 square miles, extending through parts of Pennsylvania, Ohio,

Virginia, eastern Kentucky, Tennessee, and Alabama. The maximum thickness of strata is from 2500 to 3000 feet; that of included coal is 120 feet near Pottsville, 62 feet at Wilkesbarre, and about 25 feet at Pittsburg, showing a gradual diminution to the westward. The most persistent coal is the Pittsburg seam, which is known over an area measuring 225 miles by 100 miles, but with a thickness varying from 2 to 14 feet.

The anthracite district of central Pennsylvania occupies an area of about 650 miles on the left bank of the Susquehanna River. The strata between Pottsville and Wyoming, which belong to the lowest portion of the coal measures, are probably about 3000 feet thick, but it is difficult to arrive at an exact estimate, owing to the numerous folds and contortions. There are from ten to twelve seams above 3 feet in thickness; the principal one, known as the Mammoth or Baltimore vein, is 29½ feet thick at Wilkesbarre, and in places even exceeds 60 feet.

The Illinois and Missouri basin covers a considerable part of these States, as well as of Indiana and Kentucky, Iowa, Kansas, and Arkansas. Its area is estimated at 60,000 square miles, the thickness varying from 600 feet in Missouri to 3000 feet in western Kentucky. The aggregate thickness of coal is about 70 feet. A good furnace coal is obtained in Indiana, the so-called block coal of Brazil near Indianapolis, which, like the splint coals of Scotland and those of Staffordshire, can be used in the blast furnace without coking.

In Michigan a nearly circular area of coal measures, of about 5000 square miles, occurs in the lower peninsula between lakes Huron and Michigan. The thickness is only 120 feet, and the coals unimportant.

Other coal-bearing areas of less value are known in Texas and Rhode Island.

The Carboniferous strata are largely developed in the eastern provinces of the Dominion of Canada, notably in New Brunswick and Nova Scotia. The lower Carboniferous group here consists of about 6000 feet of red sandstones and green marls, with thick beds of fossiliferous limestones, accompanied by gypsum. The limestones increase in thickness southward. In this series occurs the peculiar pitch-like or asphaltic coal of the Albert mine in New Brunswick, of which an analysis is given in Table I, *supra*. The overlying coal measures, including the millstone grit, occupy an area estimated at 18,000 square miles. The whole thickness of this group at South Joggins is about 14,750 feet, with 78 included coal seams, together 45 feet in thickness, which are contained in the middle division of the series. At Pictou there are six seams, together measuring 80 feet in thickness. The coal measures in this area approach more nearly to the great coal-fields of Europe in thickness than those of the other American Carboniferous districts. Rocks of Carboniferous age occur in various places on both flanks of the Rocky Mountains, and in the Arctic Archipelago, but have not yet been explored.

Lignite-bearing strata of Cretaceous and Tertiary age occupy a very considerable area in the central and western portions of North America, especially in the upper Missouri and Saskatchewan valleys, in Utah and Texas, and in California, Oregon, and Vancouver Island. In the last locality coal has been extensively mined near Nanaimo, on the east coast, for several years past, in strata of Cretaceous age. Tertiary lignites are worked in Bellingham Bay, at Coose Bay in Oregon, and at Monte Diabolo, near San Francisco. The lignitic formations of the eastern flank of the Rocky Mountains, which are considered by Hayden to occupy a position between the Cretaceous and Eocene Tertiary strata, occupy an area estimated at about 50,000 square miles within the United States, and extend both northward into Canada and southward into Mexico.

In South America coal, probably of Carboniferous age, is found in the Brazilian provinces of São Pedro, Rio Grande do Sul, and Santa Catharina, and in the neighboring state of Uruguay. The largest area is that known as the Candiota coal-field, which is exposed for about 50 miles in the valley of the river of the same name. The sections exposed show 5 seams from 9 to 25 feet each, or together about 65 feet of coal. Other basins are known at S. Sepé and S. Jeronimo, on the Jacahabay River. The latter is the only point at which mines are worked, as the coals, though thinner than those of the other localities mentioned, are situated within the reach

of navigable waters, having only to bear a land carriage of 8 miles to the river.

On the west coast of South America, Cretaceous coals are worked at Lota, in Chili, and at Sandy Point, in the Straits of Magellan. In Peru both Secondary and Carboniferous coals are known at various points in the interior, the former occupying a position on the first rise of the table land of the Andes, while the latter occur in higher ground, at a greater distance from the coast. Good coal is also found at many points in the Santa Valley.

Much of the Peruvian coal has undergone considerable disturbance and metamorphism subsequent to its deposition. At Porton, 45 miles east of Truxillo, a ridge of coal-bearing sandstones has been changed into a hard quartzite, with an interstratified seam of anthracite in a nearly vertical position. The coal is remarkable as containing a large amount of sulphur (see analysis Table I.). The hitherto inaccessible position of these places, which are usually more than 10,000 feet above the sea-level, has prevented the development of coal-mining in Peru; but the extension of railways into the mountains will probably bring them into importance, by stimulating a local demand for fuel.

*Extent of existing Workable Coal.*

The following summary of the amount of coal estimated as workable remaining in the different districts, which is taken from the report of the Royal Commission on coal, and founded upon investigations made in the years 1866-71, furnishes an approximate measure of the comparative value, present and prospective, of the different coal-fields of the United Kingdom. The quantities represent the probable aggregate yield of all seams above 1 foot thick.

Coal-Fields.	Coal remaining in exposed Coal-fields.	
	Within 4000 feet. Tons.	Below 4000 feet. Tons.
South Wales.....	32,456,208,913	4,109,987,004
Forest of Dean.....	265,000,000	
Somersetshire.....	4,218,970,762	1,885,340,220
North Staffordshire.....	1,906,119,768	
Shropshire.....		
Forest of Wyre.....		
Clee Hills.....		
Leicestershire.....	836,798,734	
Warwickshire.....	458,652,714	
North Wales.....	2,005,000,000	
Anglesea.....	5,000,000	
North Staffordshire.....	3,825,488,105	1,000,785,488
Yorkshire and Derbyshire.....	18,172,071,453	234,728,010
Yorkshire (Oolitic, &c.).....	70,000,000	
Lancashire and Cheshire.....	5,546,000,000	90,000,000
Northumberland and Durham.....	10,038,660,236	
Cumberland.....	405,203,792	
Scotland.....	9,839,965,930	
“ (Oolitic).....	3,500,000	
Ireland.....	155,600,000	
	90,206,240,387	7,320,840,722

The quantity estimated as lying above the workable limit of 4000 feet under the Permian and other formations, in the central and northern counties of England, is 56,248,000,000 tons, covering an area of 2044 square miles, in addition to which, in the flat ground between the Mersey, Denbighshire, the North Staffordshire hills, Cannock Chase, and Colebrookdale, a further area of 843 square miles at inaccessible depths is computed to contain—

Between 4000 and 6000 feet.....	29,341,649,067 tons.
“ 6000 “ 10000 “.....	15,802,741,333 “
	44,644,390,400 “
Adding to this the amount below 4000 feet from the previous table...	7,320,840,722 “
Total unavailable coal.....	51,965,231,122 “
As compared with.....	146,454,240,387 “

the quantity of workable coal, as made up of the two amounts, 90,206,240,387 and 56,248,000,000 tons, given above. From this it follows that, out of the probable total quantity of coal in the British coal measures, rather more than three-fourths may become available for consumption, or about 1170 times the amount of the present annual output of 125 million tons.

Similar estimates have been formed for the coal-fields of other countries, especially in France and Germany; but it is doubtful whether the necessary structural details are suf-

ciently well known to admit of more than a tolerably rough guess being made.

#### COAL-MINING.

The opening and laying out, or, as it is generally called, "winning," of new collieries is rarely undertaken without a preliminary examination of the character of the strata by means of borings, either for the purpose of determining the number and nature of the coal-seams in new ground, or the position of the particular seam or seams which it is proposed to work in extensions of known coal-fields.

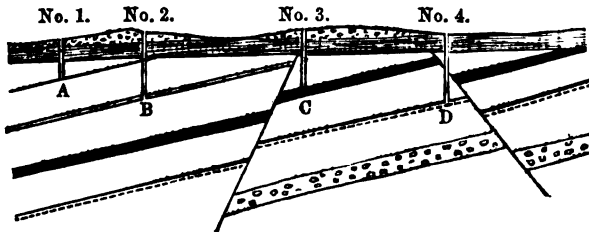

FIG. 3.

The principle of proving a mineral field by boring is illustrated by figure 3, which represents a line direct from the dip to the rise of the field, the inclination of the strata being one in eight. No. 1 bore is commenced at the outcrop, and reaches a seam of coal A, at 40 fathoms; at this depth it is considered proper to remove nearer to the outcrop, so that lower strata may be bored into at a less depth, and a second bore is commenced. To find the position of No. 2, so as to form a continuous section, it is necessary to reckon the inclination of the strata, which is 1 in 8; and as bore No. 1 was 40 fathoms in depth, we multiply the depth by the rate of inclination,  $40 \times 8 = 320$  fathoms, which gives the point at which the coal seam A should reach the surface. But there is generally a certain depth of alluvial cover which requires to be deducted, and which we call 3 fathoms, then  $(40 - 3 - 37) \times 8 = 296$  fathoms; or say 296 fathoms is the distance that the second bore should be placed to the rise of the first, so as to have for certain the seam of coal A in clear connection with the seam of coal B. In bore No. 3, where the seam B, according to the same system of arrangement, should have been found at or near the surface, another seam C is proved at a considerable depth, differing in character and thickness from either of the preceding. This derangement being carefully noted, another bore to the outcrop on the same principle is put down for the purpose of proving the seam C; the nature of the strata at first is found to agree with the latter part of that bored through in No. 3, but immediately on crossing the dislocation seen in the figure it is changed, and the deeper seam D is found.

The evidence therefore of these bores (3 and 4) indicates some material derangement, which is then proved by other bores, either towards the dip or the outcrop, according to the judgment of the borer, so as to ascertain the best position for sinking pits.

The methods of boring are similar to those adopted for deep wells, or in other departments of mining. For shallow bores, the boring is generally with wrought iron rods screwed together in lengths, armed with a cutting chisel, and working by percussion, the tool being lifted by hand and allowed to fall with its full weight upon the rock. The pounded material is removed at intervals, by substituting a shell pump or tube with valves at the bottom, whose action is similar to that of the foot valves of an ordinary lifting pump. The sludge brought to the surface indicates the nature of the ground passed through. In very deep borings, however, the use of rigid rods and fixed tools is found to present two serious evils, namely, the excessive weight on the tool caused by the increased length of the rods, and the great length of time required to withdraw the tool and remove the detritus. The first of these difficulties has been overcome by the use of the free falling cutters, where the tool, instead of being attached rigidly to the rod, moves in a guide-block in such a manner as to be lifted with the rods, falling freely when the top of the stroke is reached. The

rods, when lowered, pick up the tool at the bottom of the hole in readiness for the next lift. By this means the momentum of the tool is kept constant whatever may be the weight of rods employed.

The use of a wire rope winding on a drum, instead of rods for suspending the boring tool, allows the latter to be withdrawn and replaced with much greater rapidity than can be done with rods. This method has been very successfully adopted by Messrs. Mather & Platt of Salford. But perhaps the best methods of expeditious boring are those (Fauvelle's) whereby the detritus is removed as it forms by continuously flushing out the hole with water, hollow rods being used down which the water flows while it rises through the annular space between the rod and the lining tube of the bore hole. This has the advantage of giving a clear surface for the tool to cut on, instead of its having to work through its own sludge, as is the case when the shell pump is only used at intervals. Of late years the value of boring for exploratory purposes has been much increased by the adoption of tubular or crown borers, which cut out an annular groove, leaving a core of unbroken rock in the centre, which is then brought out by a grapple in a solid piece. One of the most successful of these methods is that due to Leschot of Geneva, where a rotating cutter, armed with amorphous black diamond, the hardest known substance, is used, the detritus being continuously removed by water on Fauvelle's plan. The machinery adopted for this purpose, as modified by Messrs. Beaumont & Appleby, has been employed with great success to bore holes exceeding 2000 feet in depth.

The working of coal may be conducted either by means of levels or galleries driven from the outcrop in a valley, or by shafts or pits sunk from the surface. In the early days of coal mining, open working, or quarrying from the outcrop of the seams, was practised to a considerable extent; but there are now few if any places in England where this can be done. In 1873 there could be seen, in the thick coal seams of Bengal, near Raniganj, a seam about 50 feet thick laid bare, over an area of several acres, by stripping off a superficial covering varying from 10 to 30 feet, in order to remove the whole of the coal without loss by pillars. Such a case, however, is quite exceptional. The operations by which the coal is reached and laid out for removal are known as "winning," the actual working or extraction of the coal being termed "getting." In the accompanying figure, No. 4, A B is a cross cut-level, by which the seams of coal 1 and 2 are won, and C D a vertical shaft by which the seams 1, 2, and 3 are won. When the field is won by the former method, the coal lying above the level is said to be "level-free." The mode of winning

Methods of working.

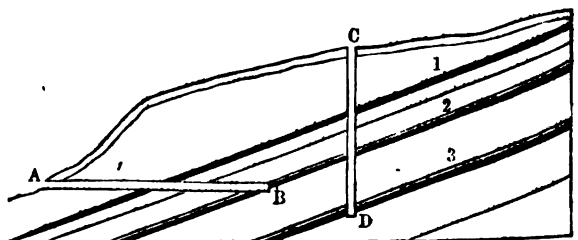

FIG. 4.

by level is of less general application than that by shafts, as the capacity for production is less, owing to the smaller size of roadways by which the coal must be brought to the surface, levels of large section being expensive and difficult to keep open when the mine has been for some time at work. Shafts, on the other hand, may be made of almost any capacity, owing to the high speed in drawing which is attainable with proper mechanism, and allow of the use of more perfect arrangements at the surface than can usually be adopted at the mouth of a level on a hill side. A more cogent reason, however, is to be found in the fact that the principal coal-fields are in flat countries, and where the coal can only be reached by vertical sinking.

The methods adopted in driving levels for collieries are generally similar to those adopted in other mines. The ground is secured by tim-

Sinking of shafts.



bering, or more usually by arching in masonry or brick-work. Levels like that in fig. 4, which are driven across the stratification, or generally anywhere not in coal, are known as "stone drifts." The sinking of colliery shafts, however, differs considerably from that of other mines, owing to their generally large size and the difficulties that are often encountered from water during the sinking. The actual coal measure strata, consisting mainly of shales and clays, are generally impervious to water, but when strata of a permeable character are sunk through, such as the magnesian limestone of the north of England, the Permian sandstones of the central counties, or the chalk and greensand in the north of France and Westphalia, special methods are required in order to pass the water-bearing beds, and to protect the shaft and workings from the influx of water subsequently. Of these methods one of the chief is the

#### Tabbing.

plan of tabbing, or lining the excavation with an impermeable casing of wood or iron, generally the latter, which is built up in segments forming rings, that are piled upon each other throughout the whole depth of the water-bearing strata. This method necessitates the use of very considerable pumping power during the sinking, as the water has to be kept down in order to allow the sinkers to reach a water-tight stratum upon which the foundation of the tabbing can be placed. This consists in a heavy cast-iron ring, known as a wedging crib, or curb, also fitted together in segments; which is lodged in a square-edged groove cut for its reception, tightly caulked with moss, and wedged into position. Upon this the tabbing is built up in segments, usually from 10 to 12 being required for the entire circumference, the edges being made perfectly true. The thickness varies according to the pressure expected, but may be taken at from  $\frac{1}{4}$  to  $1\frac{1}{2}$  inches. The inner face is smooth, but the back is strengthened with angle brackets at the corners. A small hole is left in the centre of each segment, which is kept open during the fitting to prevent undue pressure upon any one, but is stopped as soon as the circle is completed. In the north of France and Belgium wooden tabbings, built of polygonal rings, were at one time in general use. The polygons adopted were of 20 or more sides approximating to a circular form.

#### Pneumatic sinking.

The second principal method of sinking through water-bearing ground is that which was first adopted by M. Triger, in France, and has also been used by civil engineers in putting down deep foundations for bridge piers, namely, by compressed air. The shaft is lined with a cylinder of wrought iron, within which a tubular chamber, provided with doors above and below, known as an air-lock, is fitted by a telescopic joint, which is tightly packed so as to close the top of the shaft air-tight. Air is then forced into the inclosed space by means of a compressing engine, until the pressure is sufficient to oppose the flow of water into the excavation, and to drive out any that may collect in the bottom of the shaft through a pipe which is carried through the air-slucice to the surface. The miners work in the bottom in the same manner as divers in an ordinary diving-bell. Access to the surface is obtained through the double doors of the air-slucice, the pressure being reduced to that of the external atmosphere when it is desired to open the upper door, and increased to that of the working space below when it is intended to communicate with the sinkers, or to raise the stuff broken in the bottom. This method has been adopted in various sinkings on the Continent. At Bracquenie, near Mons, the miners worked in an atmosphere up to 45 lb pressure on the square inch, without experiencing any great difficulty, but they were found to be more susceptible to pulmonary disorder upon changes of weather than those who worked under the ordinary conditions of pressure.

#### Shaft boring.

The third method of sinking through water-bearing strata is that of boring, adopted by Messrs. Kind & Chaudron in Belgium and Germany. For this purpose a horizontal bar armed with vertical cutting chisels is used, which cuts out the whole section of the shaft simultaneously. In the first instance, a smaller cutting frame is used, boring a hole from 3 to 5 feet in diameter, which is kept some 50 or 60 feet in advance, so as to receive the detritus, which is removed by a shell pump of large size. The large trepan or cutter weighs about 16 tons, and cuts a hole of from 9 to 15 feet in diameter. The water-tight lining may be either a wrought-iron tube, which is pressed down by jack screws

as the bore hole advances, or cast-iron tabbing put together in short complete rings, in contradistinction to the old plan of building them up of segments. The tabbing, which is considerably less in diameter than the bore hole, is suspended by rods from the surface until a bed suitable for a foundation is reached, upon which a sliding length of tube, known as the moss box, bearing a shoulder, which is filled with dried moss, is placed. The whole weight of the tabbing is made to bear on the moss, which squeezes outwards, forming a completely water-tight joint. The interval between the back of the tabbing and the sides of the bore hole is then filled up with concrete, which on setting fixes the tabbing firmly in position.

The introduction of these special methods has considerably simplified the problem of sinking through water-bearing strata. Some of the earlier sinkings of this kind, when pumps had to be depended on for keeping down the water, were conducted at great cost, as, for instance, at South Heston, and more recently Ryhope, near Sunderland, through the magnesian limestone of Durham.

The size and form of colliery shafts varies in different districts, but the tendency is now generally to make them round, and from 12 to 15 feet in diameter. In the Midland counties, from 7 to 9 feet is a very common size, but larger dimensions are adopted where a large production is required. At Bagillt, on the Dee, a shaft of 22 feet in diameter was commenced a few years ago, but was reduced in diameter a short distance down. Since the accident at Hartley colliery—caused by the breaking of the pumping engine beam, which fell into the shaft and blocked it up, whereby the whole company of men in the mine were starved to death—it has been made compulsory upon mine owners to have two pits for each working, in place of the single one divided by walls or brattices which was formerly thought sufficient. The use of two independent connections—whether separate pits or sections of the same pit, between the surface and the workings—is necessary for the service of the ventilation,—fresh air from the surface being carried down one, known as the "downcast," while the foul or return air of the mine rises through the other or "upcast" pit back to the surface. Where the mine is heavily watered, it is often necessary to establish a special engine pit, with pumps permanently fixed, or a division of one of the pits may be devoted to this purpose. The use of direct-acting high-pressure pumping engines placed at the bottom of the shaft has become common during the last ten years. They have the advantage of doing away with the heavy reciprocating rod from the engine at the surface, and may be worked either by steam pipes carried down the pit, or, what is now more common, by boilers underground, which supply also steam for the underground hauling engines. Where the water does not accumulate very rapidly it is a very common practice to allow it to collect in a pit or sump below the working bottom of the shaft, and to draw it off in a water-tub or bucket by the main engine, when the latter is not employed in raising coal.

The laying out of a colliery, after the coal has been won, by sinkings or levels, may be accomplished in various ways, according to the nature of the coal, its thickness and dip, and the extent of ground to be worked. In the South Staffordshire and other Midland coal-fields, where only shallow pits are required, and the coals are thick, a pair of pits may be sunk for a very few acres, while in the North of England, on the other hand, where sinking is expensive, an area of some thousands of acres may be commanded from the same number of pits. In the latter case, which represents the most approved practice, the sinking is usually placed about the centre of the ground, so that the workings may radiate in every direction from the pit bottom, with the view of employing the greatest number of hands to advantage. Where a large area cannot be commanded, it is best to sink to the lowest point of the field for the convenience of drawing the coal and water which become level-free in regard to the pit. Where properties are much divided, it is always necessary to maintain a thick barrier of unwrought coal between the boundary of the mine and the neighboring workings, especially if the latter are to the dip. If a prominent line of fault crosses the area, it may usually be a convenient division of the field into sections or districts. The first process in laying out the workings consists in driving a gallery on the level

along the course of the coal seam, which is known as a "dip head level," and a lower parallel one, in which the water collects, known as a "lodgment level." Galleries driven at right angles to these are known as "dip" or

falling down the shaft, and prevent them falling into the workings. This is an unusually large example, but is taken from a pit in the highest state of development, and making a very large daily output.

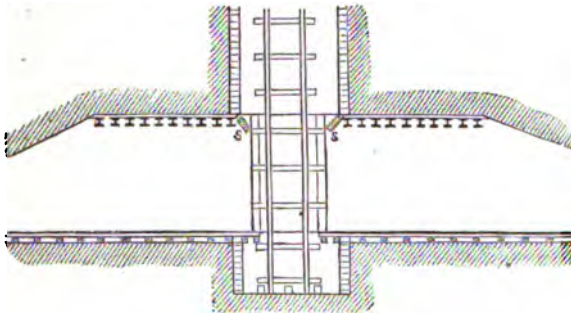

Fig. 5.—Pit eye, Cambois Colliery—Vertical Section.

"rise headings," according to their position above or below the pit bottom. In Staffordshire the main levels are also known as "gate roads." To secure the perpendicularity of the shaft, it is necessary to leave a large mass or pillar of the seam untouched around the pit bottom. This pillar is known in Scotland as the "pit bottom stoop." The junction of the levels with the pit is known as the "pit eye;" it is usually of an enlarged section, and lined with masonry or brickwork, so as to afford room for handling the wagons or trams of coal brought from the working faces. In this portion of the pit are generally placed the furnaces for ventilation, and the boilers required for working steam engines underground, as well as the stables and lamp cabin.

Figs. 5 and 6 represent the pit bottom arrangements at Cambois colliery in Northumberland, which are of an extremely commodious character. There are four large Cornish boilers, supplying steam to the engines drawing coals from the workings, as well as to a direct-acting pumping engine, the flame and smoke being discharged by drifts into the upcast pit. For the purpose of handling large pieces of machinery and boilers, the level at the

The removal of the coal after the roads have been driven may be effected in many different ways, according to the custom of the district. These may, however, all be considered as modifications of two systems, viz., pillar work and long-wall work. In the former, which is also known as "port and stall" or "bord and pillar" in the north of England, "pillar and stall" in South Wales, and "stoop and room" in Scotland, the field is divided into strips by numerous openings driven parallel to the main rise headings, called "bords" or "bord gates," which are again divided by cutting through them at intervals, so as to leave a series of pillars arranged chequer-wise over the entire area. These pillars are left for the support of the roof as the workings advance, so as to keep the mine open and free from waste. Fig. 1, Plate III. represents the oldest form of this class of working as practised in Scotland, from which it will be seen that if the size of the pillar is equal to the width of the stall or excavation, about  $\frac{1}{2}$  of the whole seam will be removed, the remainder being left in the pillars. A portion of this may be got by the process

Method of working out coal.  
Pillar working.

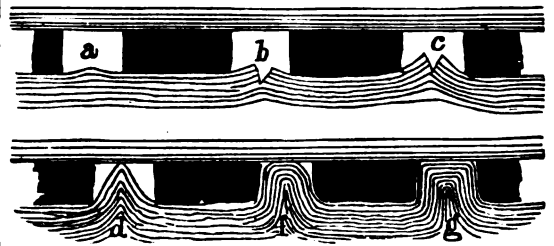

Fig. 7.—"Creeps" in Coal-Mines.

known as robbing the pillars, but the coal so obtained is liable to be very much crushed from the pressure of the superincumbent strata. This crushing may take place either from above or below, producing what are known as "creeps" or "sits."

A coal seam with a soft pavement and a hard roof is the most subject to a "creep." The first indication is a dull hollow sound heard when treading on the pavement or floor, probably occasioned by some of the individual layers parting from each other as shown at a fig. 7; the succeeding stages of creep are shown at b, c, d, f, and g, in the same figure; the last being the final stage, when the coal begins to sustain the pressure from the overlying strata, in common with the disturbed pavement.

"Sits" are the reverse of creeps; in the one case the pavement is forced up, and in the other the roof

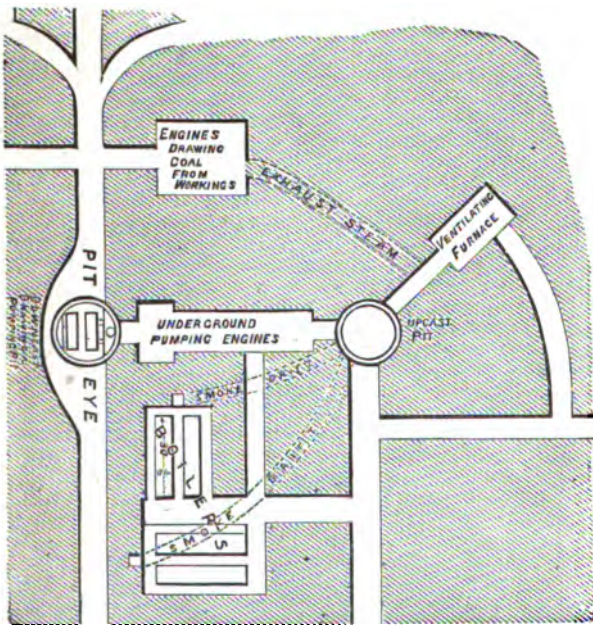

Fig. 6.—Pit bottom arrangements, Cambois Colliery.

bottom is increased to a chamber 18 feet high, and roofed with rolled iron girders of a double T section. To protect the fillers working at the bottom, strong diagonal guard timbers are placed at S in order to deflect any materials

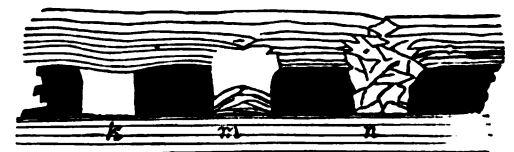

Fig. 8.—"Sits" in Mines.

is forced or falls down, for want of proper support or tenacity in itself. This accident generally arises from an improper size of pillars; some roofs, however, are so difficult to support that sits take place where the half of the coal is left in pillars.

Fig. 8 will convey a general idea of the appearance of sits,—k, m, n showing different stages.

The modern method of pillar working is shown in Plate IV. In the Northumberland steam-coal district, where it is carried out in the most perfect manner, the boards are 5 to 6 yards in width, while the pillars are 22 yards broad and 30 yards long, which are subsequently got out on coming back. In the same figure is also shown the method of working whole coal and pillars at the same time, a bar

rier of two or three ranges of pillars or a rib of solid coal being left between the working in the solid and those in the pillars. The space from which the entire quantity of coal has been removed is known in different districts as the "goaf," "gob," or "waste."

Fig. 9 represents the Lancashire system of pillar working. The area is laid out by two pairs of level drifts,

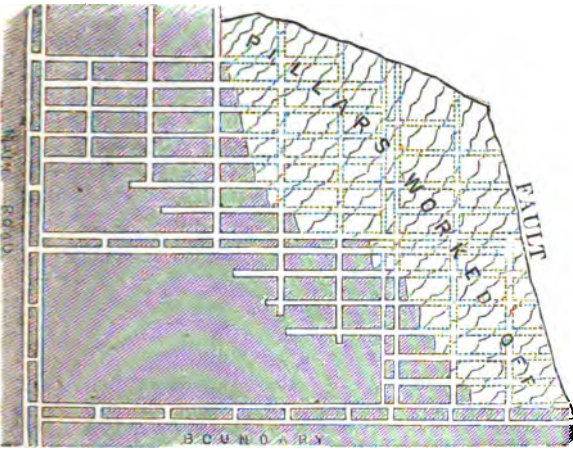

FIG. 9.—Lancashire method of working Coal.

parallel to each other, about 150 yards apart, which are carried to the boundary. About 100 yards back from the boundary a communication is made between these levels, from which other levels are driven forward, dividing the coal into ribs of about 25 or 30 yards wide, which are then cut back by taking off the coal in slices from the level towards the rise in breadths of about six yards. By this method the whole of the coal is got backwards, the main roads being kept in solid coal; the intermediate levels not being driven till they are wanted, a greater amount of support is given, and the pillars are less crushed than is usual in pillar working.

In the South Wales system of working, cross headings are driven from the main roads obliquely across the rise to get a sufficiently easy gradient for horse roads, and from these the stalls are opened out with a narrow entrance, in order to leave support on either side of the road, but afterwards widening to as great a breadth as the seam will allow, leaving pillars of a minimum thickness. The character of such workings is very irregular in plan, and as the ventilation is attended with considerable difficulty, it is now becoming generally superseded by more improved methods.

The second great principle of working is that known as long-wall or long-work, in which the coal is taken away either in broad faces

away at a second working. The roof is temporarily supported by wooden props or pack walling of stone for a sufficient breadth along the face to protect the workmen, and allow them to work together behind. The general character of a long-wall working is shown in fig. 10, which represents an area of about 500 acres of the bottom hard steam coal at Shipley in Derbyshire. The principal road extends from the shafts southward; and on both sides of it the coal has been removed from the light-shaded area by cutting it back perpendicularly towards the boundaries, along faces about 50 yards in length, those nearest to the shaft being kept in advance of those farther away, producing a step-shaped outline to the face of the whole coal. It will be seen that by this method the whole of the seam, with the exception of the pillars left to protect the main roadways, is removed. The roads for drawing the coal from the working faces to the shaft are kept open by walling through the waste or goaf produced by the fall of the unsupported roof. The straight roads are the air-ways for carrying pure air from the down-cast shaft to the working faces, while the return air passes along the faces and back to the up-cast by the curved road. The above is the method of working long-wall forward, i.e., taking the coal in advance from the pit towards the boundary, with roads kept open through the gob. Another method consists in driving towards the boundary, and taking the coal backward towards the shafts, or working homeward, allowing the waste to close up without roads having to be kept open through it. This is of course preferable, but is only applicable where the owner of the mine can afford to expend the capital required to reach the limit of the field in excess of that necessary when the raising of coal proceeds *pari passu* with the extension of the main roads. Fig. 9 is substantially a modification of this kind of long-wall work.

Plate III. fig. 2, represents a method of working practised in the South Yorkshire district, known as bords and banks. The field is divided by levels and headings into rectangular banks, while from the main levels bords or wickets about 30 yards wide, separated from each other by banks of about the same width, are carried forward in long-wall work, as shown on the left side of the figure, the waste being carefully packed behind so as to secure the ventilation. When these have been worked up to the extremity, as shown on the right side, the intermediate bank is removed by working backward towards the level. This system, therefore, combines both methods of long-wall working, but is not generally applicable, owing to the difficulty of ventilation, due to the great length of air-way that has to be kept open around the waste on each bank.

The relative advantages of the different methods may be generally stated as follows. Long-wall work is best suited for thin coals, and those having a good roof, i.e., one that gives way gradually and fills up the excavation made by removing the coal without scaling off suddenly and falling into the working faces, when practically the whole of the coal may be removed. Against these advantages must be placed the difficulties attending the maintenance of roads through the goaves, and in some cases the large proportion of slack to round or large coal obtained. Pillar working, in the whole coal, is generally reputed to give a more advantageous proportion of round coal to slack, the latter being more abundantly produced on the removal of the pillars, but as these form only a small portion of the whole seam, the general yield is more advantageous than in the former method. The ventilation of pillar working is often attended with difficulty, and the coal is longer exposed to the influence of the air, a point of importance in some coals, which deteriorate in quality when exposed to a hot damp atmosphere. The great increase in the size of the pillars in the best modern collieries worked upon this principle has, however, done much to approximate the two systems to an equality in other respects.

The working of very thick seams presents certain special peculiarities, owing to the difficulties of supporting the roof in the excavated portions, and supplying fresh air to the workings. The most typical example of this kind of working in England is afforded by the thick coal of South Staffordshire, which consists of a series of closely associated coal seams, varying from 8 to 12 or 13, divided from each other by their partings, but making together one great bed

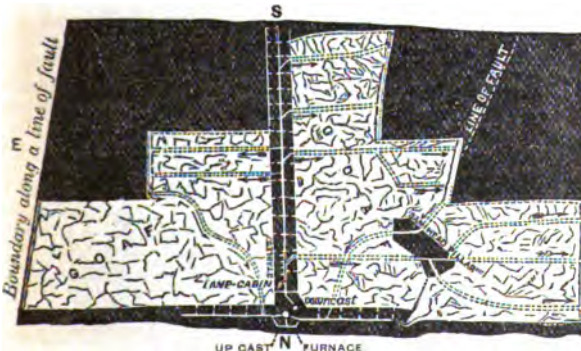

FIG. 10.—Long-wall method of working Coal in Derbyshire.

from roads about 40 or 50 yards apart and parallel to each other, or along curved faces between roads radiating from the pit bottom—the essential feature in both cases being the removal of the whole of the coal at once, without first sub-dividing it into pillars, to be taken

South Yorkshire method.

Working thick seams.

of from 25 to 40 feet or more in thickness. The partings together do not amount to more than 2 or 3 feet. The method of working which has been long in use is represented in fig. 11. The main level or gate road is driven in the benches coal, or lower part of the seam, while a smaller drift for ventilation, called an air heading, is carried above it in one of the upper beds called the slipper

manual labor, the tool employed being a sharp-pointed double-armed pick, which is nearly straight, except when required for use in hard rock, when the arms are made with an inclination or "anchored." The terms pike, pick, mandril, and slitter are applied to the collier's pick in different districts, the men being known as pikemen or hewers. In driving levels it is necessary to cut grooves vertically parallel to the walls, a process known as shearing; but the most important operation is that known as holing or kirving, which consists in cutting a notch or groove in the floor of the seam to a depth of about 8 feet, measured back from the face, so as to leave the overhanging part unsupported, which then either falls of its own accord within a few hours, or is brought down either by driving wedges along the top, or by blasting with gunpowder. The process of holing in coal is one of the severest kinds of human labor. It has to be performed in a constrained position, and the miner lying on his side has to cut to a much greater height, in order to get room to carry the groove in to a sufficient depth, than is required to bring the coal down, giving rise to a great waste in slack as compared with machine work. This is sometimes obviated by holing in the beds below the coal, or in any portion of a seam of inferior quality that may not be worth working. This loss is proportionately greater in thin than in thick seams, the same quantity being cut to waste in either case. The method of cutting coal on the long-wall system is seen in fig. 12, representing the working at the Shipley colliery. The coal is 40 inches thick, with a seam of fire-clay and a roof of black shale; about 6 inches of the upper part, known as the roof coal, not being worth working, is left behind. A groove of triangular section of 30 inches base and 9 inches high is cut along the face, inclined timber props being placed at intervals to support the overhanging portion until the required length is cut. These are then removed, and the coal is allowed to fall, wedges or blasting

Methods of cutting coal.

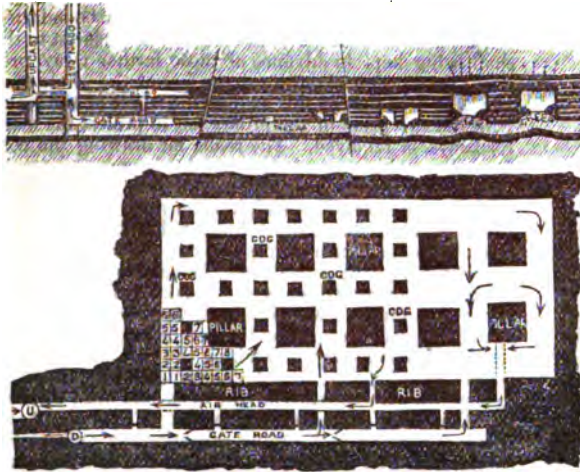

FIG. 11.—South Staffordshire method of working Thick Coal.

coal. From the gate road a heading called a bolt-hole is opened, and extended into a large rectangular chamber, known as a "side of work," large pillars being left at regular intervals, besides smaller ones or cogs. The order in which the coal is cut is shown in the dotted and numbered squares in the figure. The coal is first cut to the top of the slipper coal from below, after which the upper portion is either broken down by wedging or falls of itself. The working of these upper portions is exceedingly dangerous, owing to the great height of the excavations, and fatal accidents from falls of roof are in consequence more common in South Staffordshire than in any other coal-field in this country. The air from the down-cast shaft enters from the gate road, and passes to the up-cast through the air heading above. About one-half of the total coal (or less) is obtained in the first working; the roof is then allowed to fall, and when the gob is sufficiently consolidated, fresh roads are driven through it to obtain the ribs and pillars left behind by a second or even, in some cases, a third working. The loss of coal by this method is very considerable, besides great risk to life and danger from fire. It has, therefore, been to some extent superseded by the long-wall method, the upper half being taken at the first working, and removed as completely as possible, working backwards from the boundaries to the shaft. The lower half is then taken in the same manner, after the fallen roof has become sufficiently consolidated to allow the mine to be reopened.

In the working of thick seams inclined at a high angle, such as those in the south of France, and in the lignite mines of Styria and Bohemia, the method of working in horizontal slices, about 12 or 15 feet thick, and filling up the excavation with broken rock and earth from the surface, is now generally adopted in preference to the systems formerly used. At Monceaux les Mines, in France, a seam 40 feet thick, and dipping at an angle of 20 degrees, is worked in the following manner. A level is driven in a sandstone forming the floor, along the course of the coal, into which communications are made by cross cuts at intervals of 16 yards, which are driven across to the roof, dividing up the area to be worked into panels. These are worked backwards, the coal being taken to a height of 20 feet, the opening being packed up with stone sent down from the surface. As each stage is worked out, the floor level is connected with that next below it by means of an incline, which facilitates the introduction of the packing material. Stuff containing a considerable amount of clay is found to be the best suited for the purpose of filling, as it consolidates readily under pressure.

The actual cutting of the coal is chiefly performed by

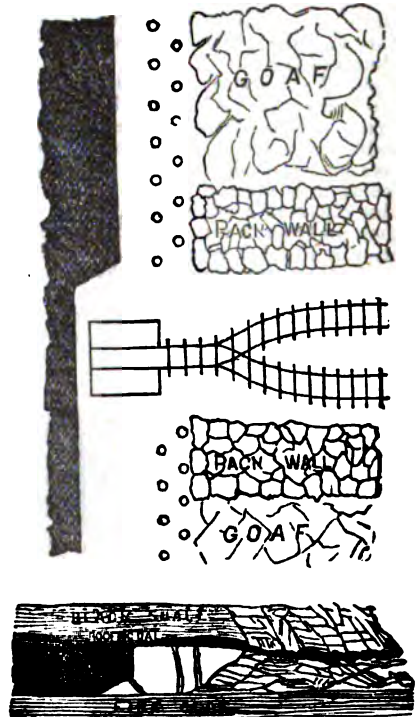

FIG. 12.—Long-wall working-face—Plan and Section.

being employed when necessary. The roof of the excavation is supported as the coal is removed, by packing up the waste material, and by a double row of props, two feet from each other, placed temporarily along the face. These are placed 5 feet apart, the props of the back row alternating with those in front. The props used are preferably of

small oak or English larch, but large quantities of fir props, cut to the right length, are also imported from the north of Europe. As the work proceeds onwards, the props are withdrawn and replaced in advance, except those that may be crushed by the pressure or buried by sudden falls of the roof.

In Yorkshire hollow square pillars, formed by piling up short blocks of wood or chocks, are often used instead of props formed of a single stem. Iron pit props have been proposed at different times, but their use has not become general. When the coal has been under-cut for a sufficient length, the struts are withdrawn, and the overhanging mass is allowed to fall during the time that the workmen are out of the pit, or it may be brought down by driving wedges, or if it be of a compact character a blast of gunpowder in a bore hole near the roof may be required. Sometimes, but rarely, it happens that it is necessary to cut vertical grooves in the face to determine the limit of the fall, such limits being usually dependent upon the cleet or divisional planes in the coal, especially when the work is carried perpendicular to them or on the end.

Coal-cutting machines.

The substitution of machinery for hand labor in cutting coal has long been a favorite problem with inventors, the earliest plan being that of Menzies, in 1761, who proposed to work a

heavy pick underground by power transmitted from an engine at the surface, through the agencies of spear-rods and chains passing over pulleys; but none of the methods suggested proved to be practically successful until the general introduction of compressed air into mines furnished a convenient motive power, susceptible of being carried to considerable distances without any great loss of pressure. This agent has of late years been applied in various ways, in machines which either imitate the action of the collier by cutting with a pick or make a groove by rotating cutters attached to an endless chain or a revolving disc or wheel. The most successful of the first class, or pick machines, is that of Mr. William Firth of Sheffield, represented in fig. 13. It consists essentially of a horizontal piston and cylinder engine fixed upon a platform carried upon four wheels, which are coupled together by side rods, so that on motion being communicated by means of a mitre wheel in the hind axle, it can be moved forward by hand. On the forward end of the frame are two bosses forming the centres for a pair of bell cranks or bent levers placed close to the ground, and facing in opposite directions, either one of which can be connected with the piston rod. The outer arm of each lever carries a square socket, into which is fixed the pick, which has two cutting heads, one placed a little in front of the other so as to cut to the whole depth at one

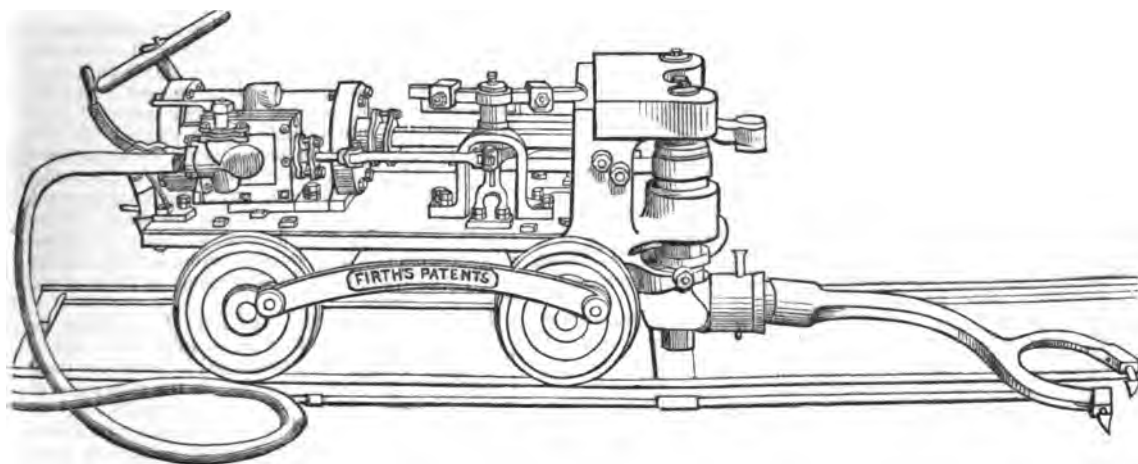

FIG. 13.—Firth's Coal-cutting Machine.

operation. In the older forms picks of different length were used, and it was necessary to go over the work a second or third time, in order to hole to the full depth. The cutting points are loose, being secured by cotters to the pick head, so that broken or blunted ones can be readily replaced without removing the pick arm. The power used is air, at about 40 to 60 lb above atmospheric pressure. It is conducted from the reservoir connected with a compressing engine at the surface, through iron pipes fixed in the pit, and along the main roads to the working face, where thick vulcanized india-rubber pipes are used, sufficient length of pipe lying loose on the ground to allow the engine to move freely, the connection being made by a screwed joint at the back of the slide-valve chest. The valve is worked by tappets on the piston-rod, so as to be perfectly self-acting when properly adjusted; it can also be moved by hand. The pick holders face in opposite directions, in order that the machine may be worked from either side. The size of the machine as ordinarily made is about 4 feet in length, 2 feet 2 inches high, and from 18 to 24 inches gauge of rails. The weight is about 15 cwt. The working speed is from 60 to 90 strokes per minute, corresponding to a length of from 10 to 20 yards, cut to a depth of 3 feet per hour. At the former rate, or 60 yards per shift of 6 hours, the work done corresponds to that of 12 average men. The width of the groove is from 2 to 3 inches at the face, diminishing to 1½ inches at the back, the proportion of waste being very considerably diminished as compared with the system of holing by hand. The use of this machine has allowed a thin seam of cannel, from 10 to 14 inches in thickness, to be worked to profit, which had formerly been abandoned as too hard to be worked by hand-labor.

An earlier form of the second class of machine, in which

the cutters have a continuous motion like those of a slotting machine, is that invented by Mr. William Peace in the Wigan district, which is reproduced from the last edition as illustrating the principle which has since been carried out by other inventors in a more convenient and simplified form. It is represented in Plate V., figs. 1, 2, and 3. AAA is the frame, upon which are fixed one or more cylinders B, arranged so as to turn a crank shaft C, fixed to the frame, as is also another shaft D. This latter is capable of being turned by the former, by means of mitre or bevel wheels EEE; upon the lower end of the latter shaft D is placed a wheel termed the driving wheel, having upon its periphery a groove with suitable projections for working into and propelling a chain or band. Beneath or to the side of the frame (or both) is fixed temporarily or otherwise a lever, the extremity of which is constructed to carry a wheel called the terminal wheel, marked HH; a chain or band is made to pass round the driving and terminal wheels, and by means of the driving wheel FF it is made to revolve. Into the chain are fixed cutters of different forms (see the parts marked, figs. 4, 5, 6, and 7), which, when the machine is in action, revolve with it, and upon being pressed or drawn against the coal, erode and excavate the same. The distance of the excavation from the face of the coal is governed by the dimensions of the machine, and by the length of the lever and the distance between the driving and terminal wheels. The arrangements of the lever allow it to revolve, and to excavate any given range; see dotted lines fig. 1.

If found necessary, two or even three levers may be in operation at the same time, and arranged to cut in any direction. Other parts of the machine not particularly described are capable of elevating and depressing the front

part of the machine, marked V, T, U, W; and those marked X, Y, Z, and K are capable of propelling the machine whilst at work, by acting against the prop.

The Gatherrie machine of Messrs. Baird is of the same character, but the chain of cutters works round a fixed frame or jib projecting at right angles from the engine carriage, instead of traversing upon a centre, an arrangement which makes it necessary to cut from the end of the block of coal to the full depth, instead of holing into it from the face. The forward feed is given by a chain winding upon a drum, which hauls upon a pulley fixed to a prop about 30 yards in advance. This is one of the most compact form of machines, the smaller size being only 20 inches high. With an air pressure of from 35 to 40 lb per square inch, a length of from 300 to 350 feet of coal is holed, 2 ft. 9 in. deep, in the shift of from 8 to 10 hours.

One of the simplest forms of coal-cutting machines is that of Messrs. Winstanly & Barker (fig. 14), which is driven by a pair of oscillating engines placed on a frame running on rails in the usual way. The crank shaft carries a pinion which gears into a toothed wheel of a coarse pitch, carrying cutters at the ends of the teeth. This wheel is mounted on a carrier which, being movable about its centre by a screw gearing worked by hand, gives a radial sweep to the cutting edges, as in the machine figured in Plate V. When at work it is slowly turned until the carrier is at right angles to the frame, when the cut has at-

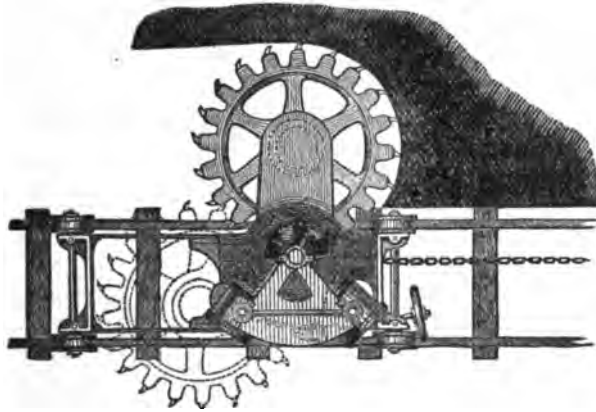

FIG. 14.—Winstanly & Barker's Coal-cutting Machine—Plan.

tained the full depth. The forward motion is given by a chain winding upon a crab placed in front, which is worked by a boy who hauls it slowly forward. With 25 lb pressure it will hole 3 feet deep, at the rate of 30 yards per hour, the cut being only 2½ in. high, but it will only work on one side of the carriage.

Another kind of application of machinery to coal mining is that of Messrs. Bidder & Jones, which is intended to replace the use of blasting with gunpowder for bringing down the coal, a practice which in fiery collieries is often attended with considerable danger from the flash of the explosion firing the gas given off the coal. It consists of a small hydraulic press, which forces a set of expanding bits or wedges into a bore-hole previously bored by a long screw auger or drill, worked by hand, the action of the press being continued until a sufficient strain is obtained to bring down the coal. The arrangement is, in fact, a modification of the plug and feather system used in stone quarrying for obtaining large blocks, but with the substitution of the powerful rending force of the hydraulic press for hand-power in driving up the wedges. This apparatus has been used at Harecastle in North Staffordshire, and found to work well, but with the disadvantage of bringing down the coal in unmanageably large masses. The use of gunpowder in very fiery mines is always attended with danger, and a method of wedging down coal sufficiently perfected to be of general application would add greatly to the security of the colliers in working such mines.

Under-ground conveyance.

The removal of the coal when broken from the working faces to the pit bottom or to the main levels is effected mainly by hand labor when the mine is small, and the distances to be

traversed inconsiderable, and in mines of greater extent by horse or steam traction. The simplest method is that of loading the broken coal on to a sledge, which is dragged along the floor to the level, but now the practice of carrying railways to the face is almost universal. The old form of flat rail or tram is still largely used, the wagons having sharp-edged disc wheels, but probably edge rails and flanged wheels are now more general. The class of rail used is generally a flat-bottomed or bridge section, weighing from 15 to 25 lb per yard, laid upon cross sleepers, which, in roads that are intended to be kept open for some time, are fixed down firmly, but are laid in a temporary manner along the working faces, and in similar positions where it is necessary to be continually shifting them, as, for instance, where coal-cutting machines are used. The arrangement of the drawing roads at the face of a long-wall colliery is seen in the plan fig. 12, where the rails are brought to the face upon a smooth iron plate, upon which the trams can be easily handled by turning on the flanges of the wheels. The names applied to the vehicles in which the coal is carried vary considerably, as do also their size and capacity. The word "corf" or "corve," representing the old basket sledge, is one of the most generally used, as are "tram," signifying a tram wagon, and "tub," of the same signification as the last, but a representative of the old method of drawing in wooden buckets. In South Staffordshire and other Midland districts, a contrivance called a "skip" is the representative method of conveyance; this consists of a platform with tram wheels, upon which the coal is built up to a considerable height, the large pieces round the sides being kept together by loose rings of sheet iron, and the intermediate spaces packed full with small coal,—the whole arrangement representing a kind of cask. This, however, like most of the similar primitive methods, is giving way to the more improved system of tubs or trams. These are small railway trucks, generally with flanged wheels and square-sided bodies, either of wood or wrought iron, varying in capacity from 4 cwt. in thin seams to 10 or 12 cwt. in thicker seams.

In the removal of the coal from the workings the first portion of the journey is generally performed by hand-power, boys being employed to push the trams before them to the main roads. In the thin seams of South Yorkshire and other places, considerable journeys are often performed in this way, the boys known as "hurriers" or "putters" being obliged to crawl at full length, owing to the lowness of the excavation. As a general rule boys are not allowed to work in collieries when below 12 years of age, but in these thin mines special exemptions are granted, permitting the use of younger boys as putters when required. Where the levels are large, horse traction is in common use; the trams are formed up into trains, and from 6 to 15 vehicles are drawn by one horse. A considerable number of ponies are imported into the northern parts of this country from Norway and Iceland for this purpose every year. The supply of horses is, however, becoming scarcer, and the price higher, so that the use of underground engines is generally adopted where the output is sufficiently large to justify the expenditure. This is done by hauling or, as it is called in the North of England, leading the trains of tubs by rope traction. In a large colliery where the shafts are situated near the centre of the field, and the workings extend on all sides, both to the dip and rise, the drawing roads for the coal may be of three different kinds,—(1) levels driven at right angles to the dip, suitable for horse roads, (2) rise ways, known as jinny roads, jigs-brows, or up-brows, which, when of sufficient slope, may be used as self-acting planes, i.e., the loaded wagons may be made to pull back the empty ones to the working faces, and (3) dip or down-brows, requiring engine power. A road may be used as a self-acting or gravitating incline when the gradient is 1 in 30 or steeper, in which case the train is lowered by a rope passing over a pulley or brake drum at the upper end, the return empty train being attached to the opposite end of the rope and hauled up by the descending load. The arrangements for this purpose vary, of course, with the amount of work to be done with one fixing of the machinery; where it is likely to be used for a considerable time, the drum and brake are solidly constructed, and the ropes of steel or iron wire carefully guided over friction rollers, placed at intervals between the

FIG. 1  
FOREST OF DEAN COAL BASIN  
Length about 11 miles

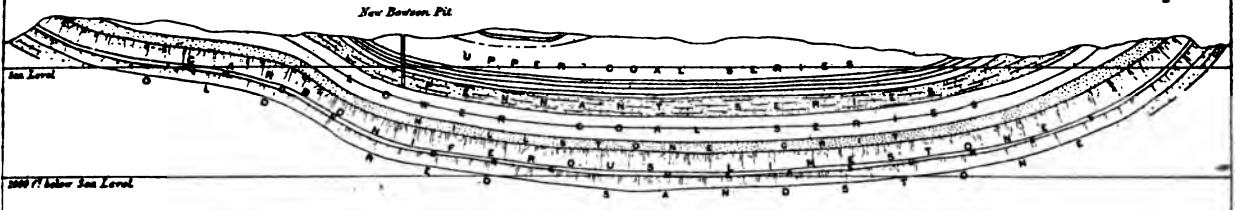

FIG. 2  
SOUTH PART OF THE LANCASHIRE COALFIELD  
Length 7 1/2 miles

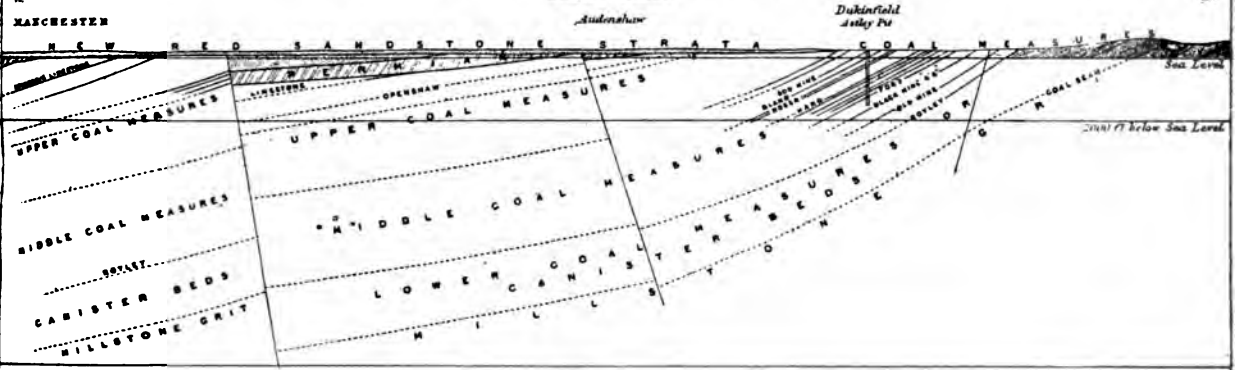

FIG. 3  
NORTH STAFFORDSHIRE COALFIELD  
Length 7 1/2 miles

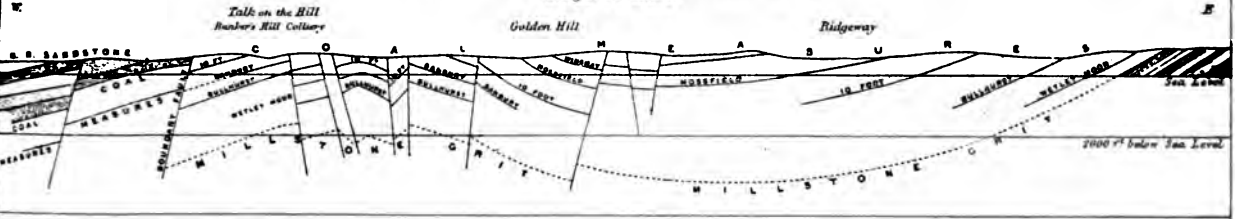
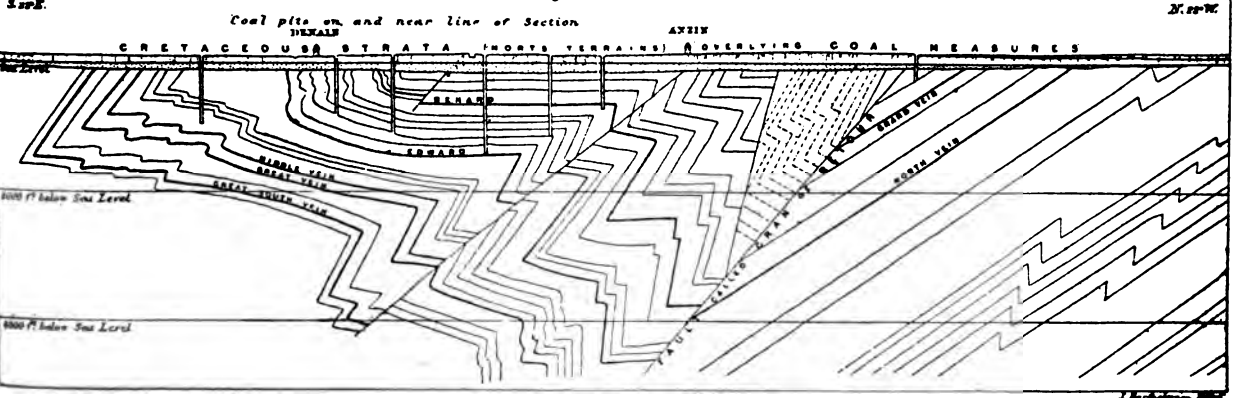

FIG. 4  
SECTION ACROSS PART OF THE NORTH OF FRANCE COALFIELD  
Length about 5 1/4 miles



Scale 1 inch = 60 yards.

Fig. 1.  
PILLAR WORKING

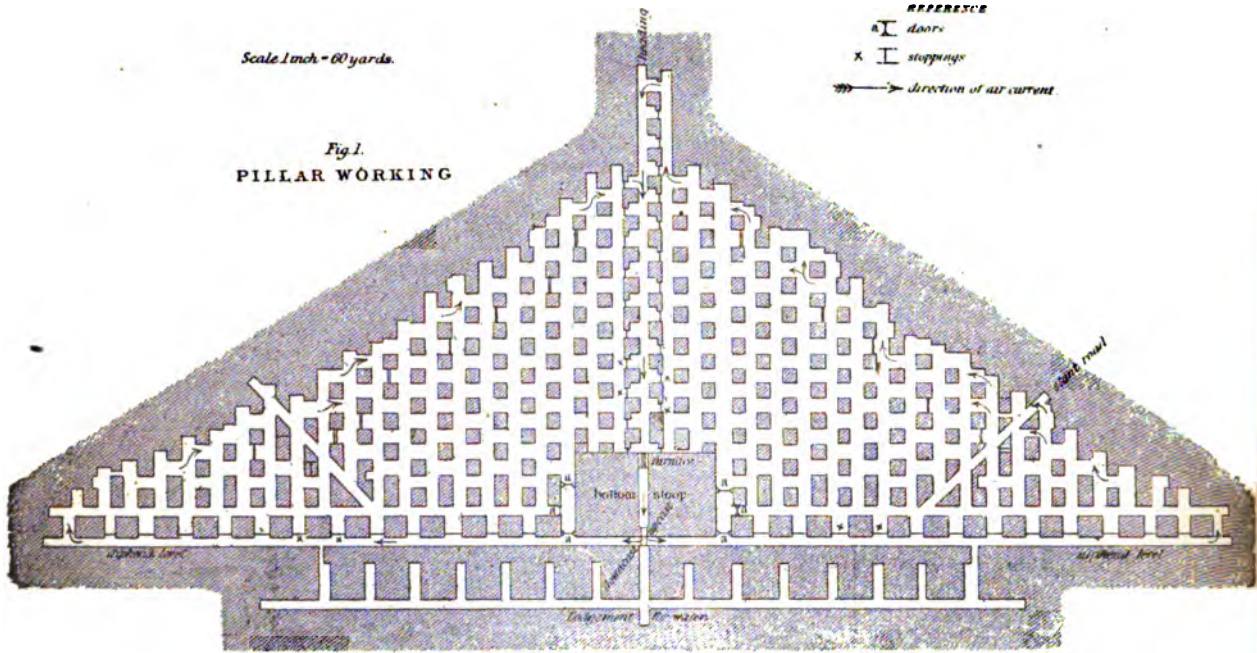
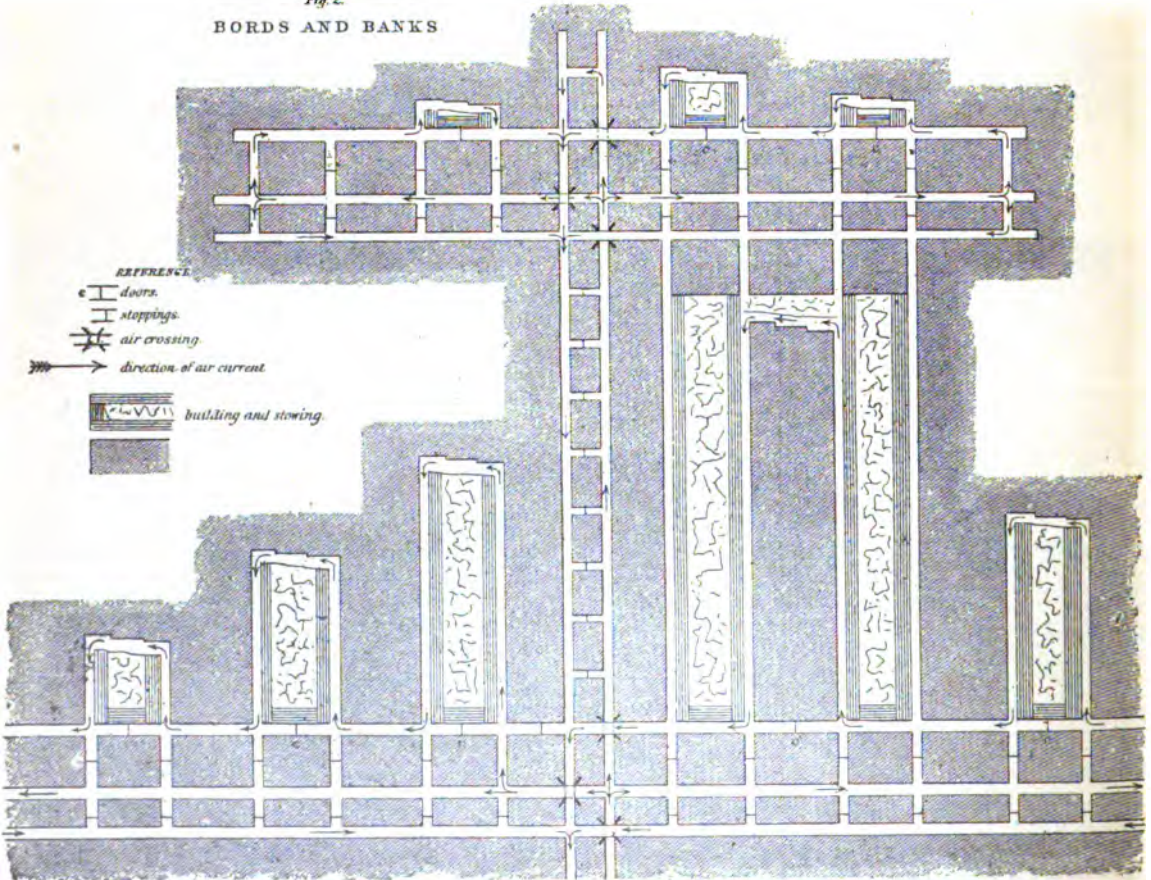
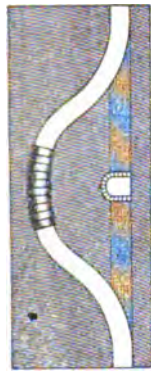

Fig. 2.  
BORDS AND BANKS







AIR CROSSING

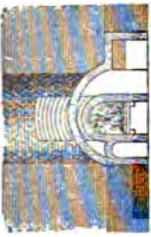
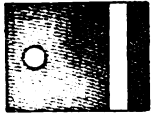

VENTILATING FURNACE SECTION

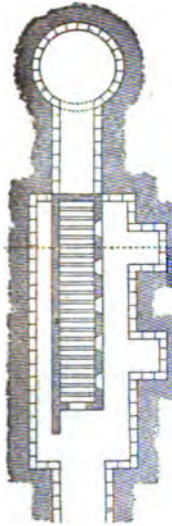

VENTILATING FURNACE PLAN



BORD AND PILLAR WORKING

Showing the method of working whole coal and pillars at the same time.

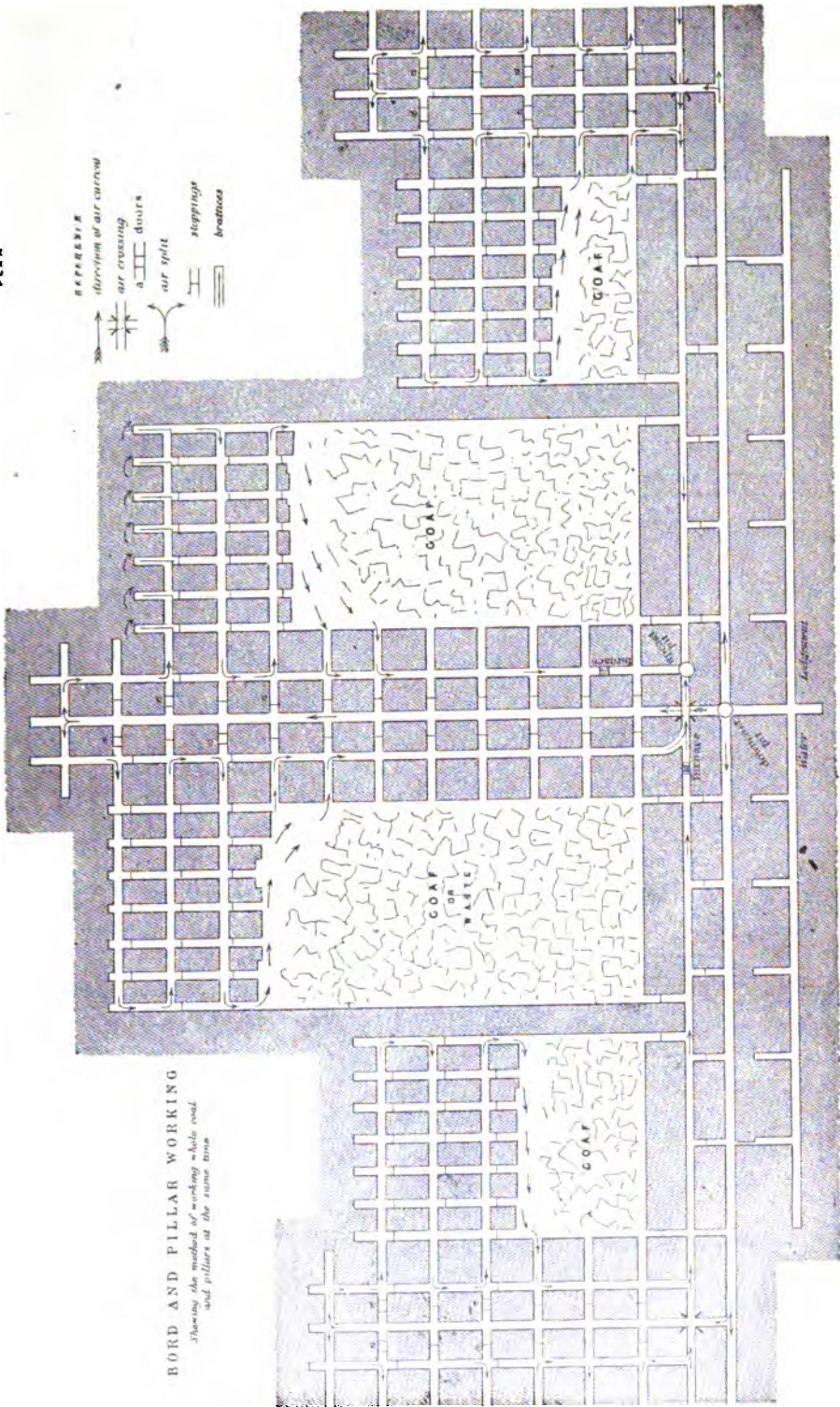

**COAL.  
CUTTING MACHINE.**

**PLATE V**

**VOL. IV**

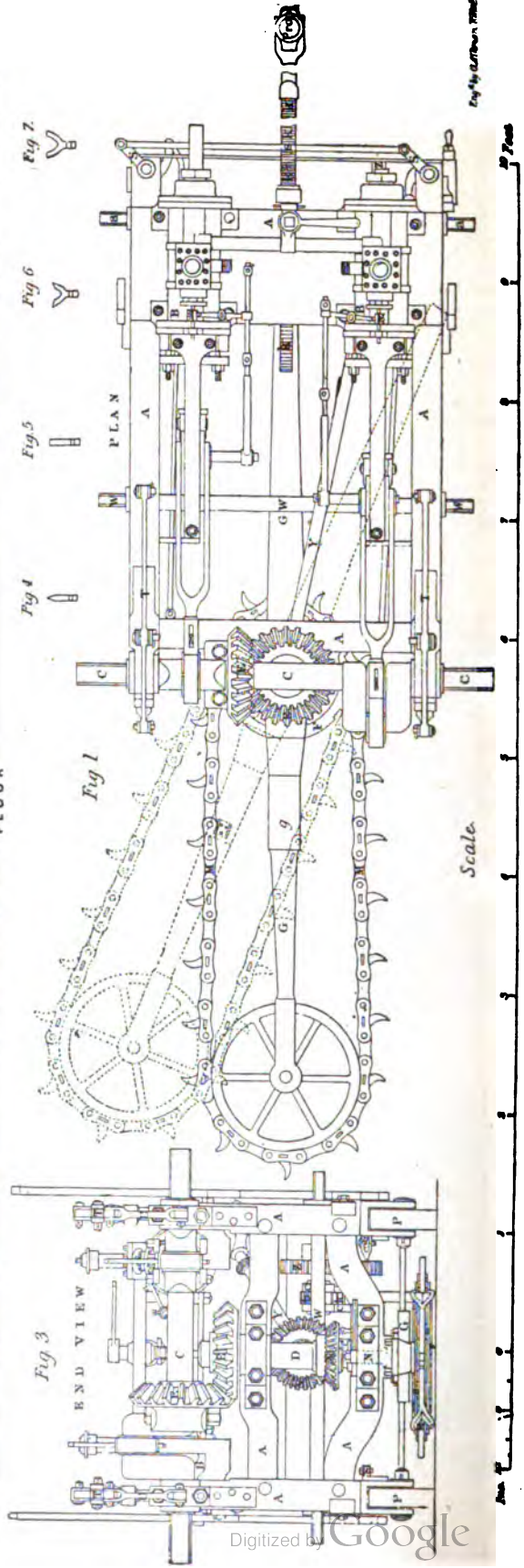
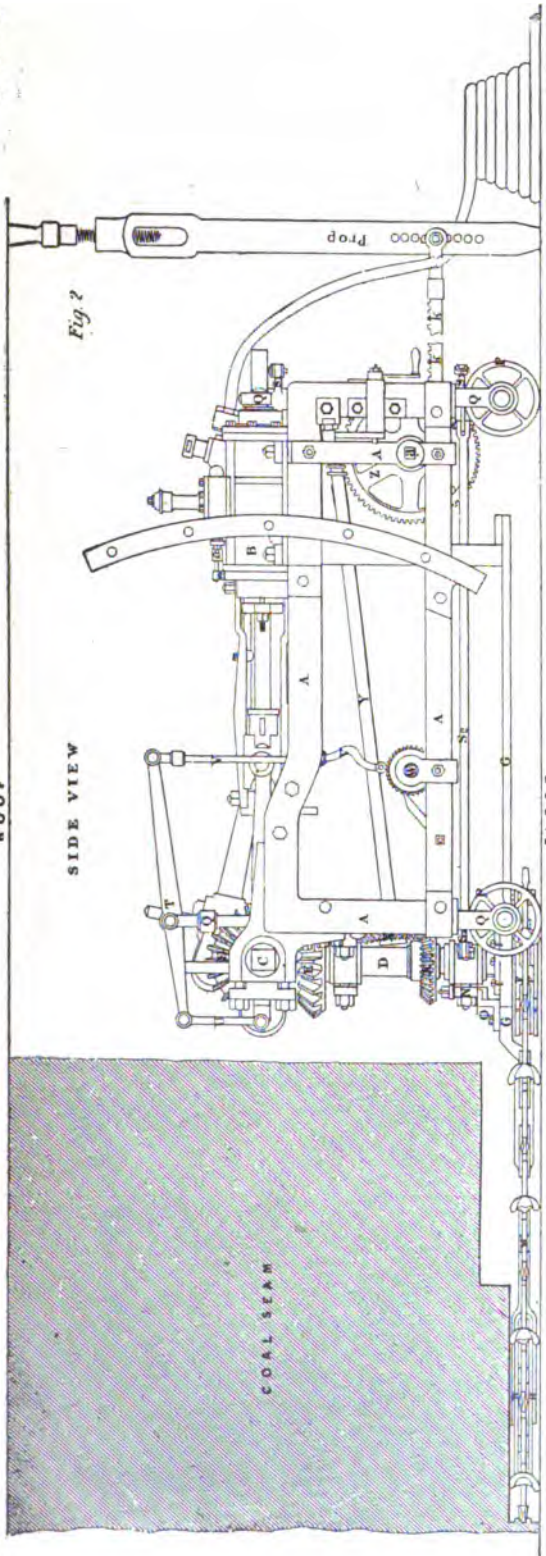

Eng'g. & Archt. Staff



rails to prevent them from chafing and wearing out on the ground. Where the load has to be hauled up a rising gradient, underground engines, driven by steam or compressed air, are now generally used. In some cases steam generated in boilers at the surface is carried in pipes to the engines below, but this can be done with less loss of power by sending down compressed air in the same way. The use of underground boilers placed near the upcast pit, as in fig. 6, so that the smoke and gases help the ventilating furnace, is most convenient in the majority of cases. Water-pressure engines, driven by a column of water equal to the depth of the pit, have also been employed for hauling. These can, however, only be used advantageously where there are fixed pumps, the fall of water generating the power resulting in a load to be removed by the expenditure of an equivalent amount of power in the pumping engine above that necessary for keeping down the mine water.

There are four principal methods in which steam power can be applied to underground traction. These, which have been discussed in the fullest manner in the Report of the North of England Institute of Mining Engineers for 1867-68, are as follows:—

1. Tail rope system.
2. Endless chain system.
3. Endless rope system on the ground.
4. Endless rope system overhead.

The three last may be considered as modifications of the same principle. In the first, which is that generally used in Northumberland and Durham, a single line of rails is used, the loaded tubs being drawn "out bye," i.e., towards the shaft, and the empty ones returned "in bye," or towards the working faces, by reversing the engine; while in the other systems, double lines, with the rope travelling continuously in the same direction, are the rule. On the tail rope plan the engine has two drums worked by spur gearing, which can be connected with, or cast loose from, the driving shaft at pleasure. The main rope, which draws out the loaded tubs, coils upon one drum, and passes near the floor over guide sheaves placed about 20 feet apart. The tail rope, which is of lighter section than the main one, is coiled on the second drum, passes over similar guide sheaves placed near the roof or side of the gallery round a pulley at the bottom of the plane, and is fixed to the end of the train or set of tubs. When the load is being drawn out, the engine pulls directly on the main rope, coiling it on to its own drum, while the tail drum runs loose paying out its rope, a slight brake pressure being used to prevent its running out too fast. When the set arrives out by, the main rope will be wound up, and the tail rope pass out from the drum to the end and back, i.e., twice the length of the way; the set is returned in bye, by reversing the engine, casting loose the main, and coupling up the tail drum, so that the tail rope is wound up, and the main rope paid out. This method, which is the oldest, having been in use for twenty-five years or more in the North of England, is best adapted for ways that are nearly level, or when many branches are intended to be worked from one engine, and can be carried round curves of small radius without deranging the trains; but as it is intermittent in action, considerable engine-power is required in order to get up the required speed, which is from 8 to 10 miles per hour. From 8 to 10 tubs are usually drawn in a set, the ways being often from 2000 to 3000 yards long. In dip workings the tail rope is often made to work a pump connected with the bottom pulley, which forces the water back to the cistern of the main pumping engine in the pit.

For the endless chain system, which is much used in the Wigan district, a double line of way is necessary, one line for full and the other for empty tubs. The chain passes over a pulley driven by the engine, placed at such a height as to allow it to rest upon the tops of the tubs, and round a similar pulley at the far end of the plane. The forward edge of the tub carries a projecting pin or horn, with a notch into which the chain falls which drags the tub forward. The road at the outer end is made of a less slope than the chain, so that on arrival the tub is lowered, clears the pin, and so becomes detached from the chain. The tubs are placed on at intervals of about 20 yards, the chain moving continuously at a speed of from 2½ to 4 miles per hour. This system presents the greatest advantages in point of economy of driving power, especially where the gradients are variable, but is expensive in first cost, and is not

well suited for curves, and branch roads cannot be worked continuously, as a fresh set of pulleys worked by bevel gearing is required for each branch.

The endless rope system may be used with either a single or double line of way, but the latter is more generally advantageous. The rope, which is guided upon sheaves between the rails, is taken twice round the head pulley; or a

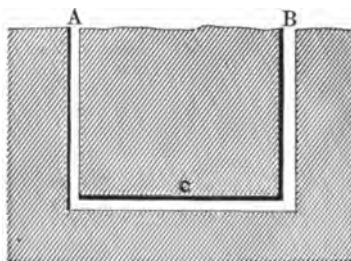

FIG. 15.

Fowler's clip pulley may be used. It is also customary to use a stretching pulley to keep the rope strained when the pull of the load diminishes. This is done by passing a loop at the upper end round a pulley mounted in a travelling frame, to which is attached a weight of about 15 cwt. hanging by a chain. This weight pulls directly against the rope; so if the latter slacks, the weight pulls out the pulley frame and tightens it up again. The tubs are usually formed into sets of from 2 to 12, the front one being coupled up by a short length of chain to a clamping hook formed of two jaws moulded to the curve of the rope which are attached by the "run rider," as the driver accompanying the train is called. This system in many respects resembles the tail rope, but has the advantage of working with one-third less length of rope for the same length of way.

The endless rope system overhead is substantially similar to the endless chain. The wagons are attached at intervals by short lengths of chains lapped twice round the rope and hooked into one of the links, or in some cases the chains are hooked into hempen loops on the main rope.

One of the most important branches of colliery work is the management of the ventilation, involving as it does the supply of fresh air to the men working in the pit, as well as the removal of inflammable gases that may be given off by the coal. This is effected by carrying through the workings a large volume of air which is kept continually moving in the same direction, descending from the surface by one or more pits known as intake or downcast pits, and leaving the mine by a return or upcast pit. Such a circulation of air can only be effected by mechanical means when the

Ventilation.

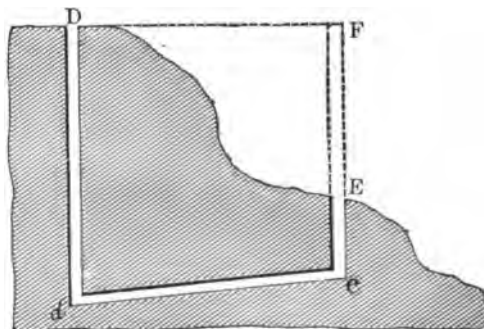

FIG. 16.

workings are of any extent, as will be apparent from the following considerations:—

If the shafts A and B, fig. 15, were of equal depth from the horizontal plane, and connected by the mine C, the air would fill the openings and remain quiescent. If the one were to the dip of the other, but communicating with the surface at a higher level, as by fig. 16, it would sometimes happen, in summer, that D would be the downcast, and E the upcast, and in winter, E the downcast, and D the upcast. These conditions are induced by the temperature of

the earth at a certain depth being nearly constant, while the atmosphere is changeable,—the column of air in D d being at a lower temperature in summer than the column of air E e, and the reverse in winter.

The methods actually adopted are—(1) The rarefaction of the air in the upcast pit by a furnace placed at the bottom; and (2) Exhaustion by machinery at the surface.

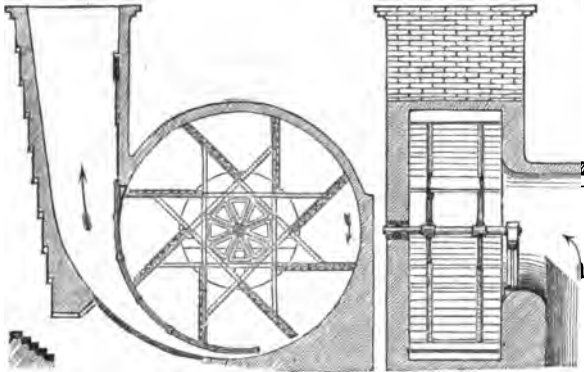

Fig. 17.—Guibal's Fan.

The former plan, although hitherto most generally used, is in many places becoming replaced by some form of machine.

The usual form of ventilating furnace is a plain firegrate placed under an arch, and communicating with the upcast shaft by an inclined drift. It is separated from the coal by a narrow passage walled and arched in brick-work on both sides. The size of the grate varies with the requirements of the ventilation, but from 6 to 10 feet broad and from 6 to 8 feet long are usual dimensions. At Shireoaks Colliery, in Nottinghamshire, a furnace consuming 6 tons of slack per 24 hours upon a grate surface of 72 square feet maintains a circulation of about 120,000 cubic feet per minute. At Hetton Colliery, Durham, the grate is a long, narrow rectangle, 25 feet by 5 feet, with numerous furnace-doors on the long side, so arranged that the surface fired may be varied according to the amount of draught required. There are two bunker-holes for coals, and a stoking passage, 7 feet wide, in front of the furnace. The fire should be kept as thin and bright as possible, to reduce the amount of smoke in the upcast. When the mine is free from gas, the furnace may be worked by the return air, but it is better to take fresh air directly from the downcast by a scale, or split, from the main current. The return air from fiery workings is never allowed to

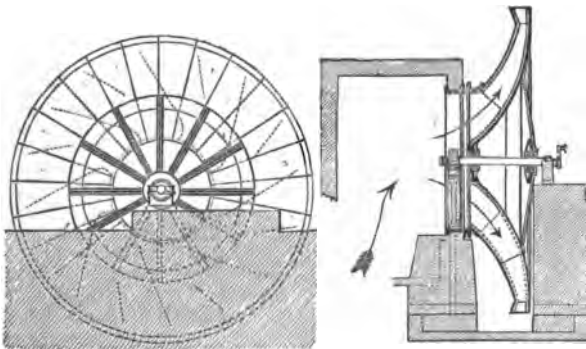

Fig. 18.—Waddle's Fan.

approach the furnace, but is carried into the upcast by a special channel, called a dumb drift, some distance above the furnace drift, so as not to come in contact with the products of combustion until they have been cooled below the igniting point of fire-damp. Where the upcast pit is used for drawing coal, it is usual to discharge the smoke and gases through a short lateral drift near the surface into a tall chimney, so as to keep the pit-top as clear as possible for working. Otherwise the chimney is built directly over the mouth of the pit.

Various kinds of machines for ventilation, both by direct exhaustion and centrifugal displacement, have been tried both in England and in Belgium. Of the former class are the great bell machines, resembling gasometers, 12 feet to 22 feet in diameter, and 9 feet high, moving in a water tank with balanced flap valves for alternately admitting and exhausting the air. These were used at Marihaye, near Liège, and at Cwm Avon in South Wales, by Mr. Struvé. Perhaps the largest of the class of piston machines is that at Nixon's Navigation Pit, near Aberdare, which has rectangular pistons, 30 feet by 22 feet, moving horizontally through a stroke of 7 feet, the lower edge being supported by rollers running on rails. The great weight of the moving parts in this class of machine makes them incapable of acting at any very high speed, and consequently expensive for the amount of work done. This is in some degree obviated in the rotary piston machines of Fabry and Lemielle, the former resembling in principle Roof's blower, now so much used in blowing foundry and smiths' fires, but on a larger scale. Lemielle's ventilator is a vertical drum revolving eccentrically within a cylindrical casing. The drum carries three jointed blades, which are drawn in or out by radius bars as it revolves, so as to enclose and sweep out at each revolution the body of air included between the two cylinders. This is one of the best machines of its class, producing a comparatively high effect for the power expended. An American machine of this kind is described and figured in the article BELLOWS, vol. iii. p. 476, fig. 5.

Of late years various kinds of centrifugal machines, or fans, have come into use instead of ventilating furnaces. One of the most successful of these is that invented by Mr. Guibal of Liège, represented in fig. 17. The fan has eight arms, framed together of wrought-iron bars, with diagonal struts, so as to obtain rigidity with comparative lightness, carrying flat close-boarded blades at their extremities. It revolves with the smallest possible clearance in a chamber of masonry, one of the side walls being perforated by a large round hole, through which the air from the mine is admitted to the centre of the fan. The lower quadrant of the casing is enlarged spirally, so as to leave a narrow rectangular opening at the bottom, through which the air is discharged into a chimney of gradually increasing section carried to a height of about 25 feet. The size of the discharge aperture can be varied by means of a flexible wooden shutter sliding in a groove in a cast-iron plate, curved to the slope of the casing. By the use of the spiral guide casing and the chimney, the velocity of the effluent air is gradually reduced up to the point of final discharge into the atmosphere, whereby a greater useful effect is realized than is the case when the air streams freely from the circumference with a velocity equal to that of the rotating fan. The power is applied by steam acting directly on a crank at one end of the axle. In most of the newer examples, which are generally of large size, the power is divided, an engine being placed on each side. At Washington Colliery, Durham, a machine of 36 feet diameter, 12 feet breadth of face, and 13 feet diameter of intake passage, draws 120,000 cubic feet of air per minute, when making 38 revolutions. Another at Usworth, 48 feet diameter and 12 feet breadth of face, driven by two high-pressure engines, with cylinders 3 feet in diameter and 3 feet stroke, equal to about 280 horse-power, exhausts 200,000 cubic feet per minute. The useful effect realized under the most favorable conditions is as much as 50 per cent. of that of the steam power employed.

Waddle's fan, represented in fig. 18, is an example of another class of centrifugal ventilator, in which a close casing is not used, the air exhausted being discharged from the circumference directly into the atmosphere. It consists of a hollow sheet-iron drum formed by two conical tubes, united together by numerous guide blades, dividing it up into a series of rectangular tubes of diminishing section, attached to a horizontal axle by cast-iron bosses and wrought-iron arms. The tubes at their smallest part are connected to a cast-iron ring, 10 feet in diameter, but at their outer circumference they are only 2 feet apart. The extreme diameter is 25 feet. A fan of these dimensions at Brownhills in Staffordshire, in making 50 revolutions

per minute, circulates 47,000 cubic feet of air through the workings. It has also been in use for some years in South Wales, and is found to work well; it is less expensive in first cost than Guibal's, although proportionally less economical from the smaller effect realized for the power expended.

Another method of colliery ventilation is that by jets of steam blowing off at a high velocity into the upcast shaft, and producing a draught similar to that of the exhaust blast in the chimney of a locomotive. This plan found several advocates some years since, and was the subject of numerous comparative trials against the ventilating furnace in the North of England, but the results were unfavorable, the amount of air circulation produced being exceedingly small for the fuel expended. It seems probable, however, that this want of success was in great part due to the defective character of the apparatus applied, and that, with properly-constructed aspirators and discharge passages, the steam jet may prove to be a very efficient means of ventilation.

The comparative merits of furnace and machine ventilation have long been discussed without any definite result. The former was at one time regarded in England as practically superior in every respect, but this opinion has been modified since the introduction of the improved forms of fans which have been worked to a considerable extent. In France and Belgium, on the contrary, machine ventilation has been more generally in favor. For a deep and extensive mine where the coal is not fiery, the furnace is undoubtedly the simplest and most efficacious method of producing a large circulation of air; but for moderate depths, especially with fiery return air, a ventilating machine at the surface is in many cases to be preferred. There is also an important advantage procured by the latter, namely, that of reserve power, so that a large circulation may be obtained immediately in case of need, e. g., when the barometer falls suddenly, by merely increasing the speed of rotation, which cannot so readily be done with the furnace, which has a tendency to slacken at the time when the increased work is wanted.

The quantity of air required for a large colliery depends upon the number of men employed, as for actual respiration from 100 to 200 cubic feet per minute should be allowed. In fiery mines, however, a very much larger amount must be provided in order to dilute the gas to the point of safety. Even with the best arrangements a dangerous increase in the amount of gas is not unfrequent from the sudden release of stored up masses in the coal, which, overpowering the ventilation, produce magazines of explosive material ready for ignition when brought into contact with the flame of a lamp or the blast of a shot. The management of such places, therefore, requires the most constant vigilance on the part of the workmen, especially in the examination of the working places that have been standing empty during the night, in which gas may have accumulated, to see that they are properly cleared before the new shift commences.

The actual conveyance or coursing of the air from the intake to the working faces is effected by splitting or dividing the current at different points in its course, so as to carry it as directly as possible to the places where it is required. In laying out the mine, it is customary to drive the levels or roads in pairs, communication being made between them at intervals by cutting through the intermediate pillar, the air then passes along one, and returns by the other. As the roads advance other pillars are driven through in the same manner, the passages first made being closed by stoppings of broken rock, or built up with brick and mortar walls, or both. When it is desired to preserve a way from one road or similar class of working to another, double doors placed at sufficient intervals apart to take in one or more trams between them when closed are used, forming a kind of lock or sluice. These are made to shut air-tight against their frames, so as to prevent the air from taking a short cut back to the upcast, while preserving free access between the different districts without following the whole round of the airways. The ventilation of ends is effected by means of brattices or temporary partitions of thin boards placed midway in the drift, and extending to within a few feet of the face. The air passes along one side of the brattice, courses round the free end, and returns on the other side. In many cases a light but air-proof

cloth, specially made for the purpose, is used instead of wood for brattices, as being more handy and more easily removed. In large mines where the air-ways are numerous and complicated, it often happens that currents travelling in opposite directions are brought together at one point. In these cases it is necessary to cross them in the manner shown in fig. 2, Plate III. The return air is usually made to pass over the intake by a curved drift carried some distance above in the solid measures, both ways being arched in brick work, or even in some cases lined with sheet iron so as to ensure a separation not likely to be destroyed in case of an explosion. The relation of the ventilation to the workings under the different systems is indicated on the several plates by arrows and other signs, from which the general character of the arrangements adopted can be made out without further description.

The lighting of underground workings in collieries is closely connected with the subject of ventilation. In many of the smaller pits in the Midland districts, and generally in South Staffordshire, the coals are sufficiently free from gas, or rather the gases are not liable to become explosive when mixed with air, to allow the use of naked lights, candles being generally used. Oil lamps are employed in many of the Scotch collieries, and are almost universally used in Belgium and other Continental countries. The buildings near the pit bottom, such as the stables and lamp cabin, and even the main roads for some distance, are often in large collieries lighted with gas brought from the surface, or in some cases the gas given off by the coal is used for the same purpose. Where the gases are fiery, the use of protected lights or safety lamps becomes a necessity.

The nature of the gases evolved by coal when freshly exposed to the atmosphere has been investigated by several chemists, more particularly by Playfair and Meyer. The latter observer found the gases given off by coal from the district of Newcastle and Durham to contain carbonic acid (anhydride), marsh gas or light carburetted hydrogen (the fire-damp of the miner), oxygen, and nitrogen. A newer investigation, by Mr. J. W. Thomas, of the gases dissolved or occluded in coals from South Wales basin shows them to vary considerably with the class of coal. The results given below, which are selected from a much larger series published in the *Journal of the Chemical Society*, were obtained by heating samples of the different coals in vacuo for several hours at the temperature of boiling water.

Quality.	Colliery.	Volume per ton in cubic feet.	Composition in volumes per cent.			
			Carb. acid.	Oxy. gas.	Marsh gas.	Nitro-gas.
Bituminous .....	Cwm Clydach.....	19.72	5.44	1.05	63.76	29.75
" .....	Lantwit.....	14.34	9.43	2.25	81.95	56.84
Steam.....	Navigation.....	89.62	13.21	0.49	81.64	4.66
Anthracite.....	Bonville's Court }	198.95	2.62	.....	93.13	4.25

In one instance, about 1 per cent. of hydride of ethyl was found in the gas from a blower in a pit in the Rhondda district, which was collected in a tube and brought to the surface to be used in lighting the engine-room and pit-bank. The gases from the bituminous house coals of South Wales are comparatively free from marsh gas, as compared with those from the steam coal and anthracite pits. The latter class of coal contains the largest proportion of this dangerous gas, but holds it more tenaciously than do the steam coals, thus rendering the workings comparatively safer. It was found that, of the entire volume of occluded gas in an anthracite, only one-third could be expelled at the temperature of boiling water, and that the whole quantity, amounting to 650 cubic feet per ton, was only to be driven out by a heat of 300° C. Steam coals being softer and more porous give off enormous volumes of gas from the working face in most of the deep pits, many of which have been the scene of disastrous explosions.

The gases evolved from the sudden outbursts or blowers in coal, which are often given off at a considerable tension, are the most dangerous enemy that the collier has to contend with. They consist almost entirely of marsh gas, with only a small quantity of carbonic acid, usually under 1 per cent., and from 1 to 4 per cent. of nitrogen.

Fire-damp when mixed with from four to twelve times its volume of atmospheric air is explosive; but when the

Crossings.

Lighting.

Composition of gas evolved by coal.

proportion is above or below these limits, it is inflammable, burning quietly with a pale blue flame. When a lighted candle is exposed in a non-explosive mixture of this gas, the flame gradually elongates, forming a conical cap, floating above the wick, which may be extinguished by cautious withdrawal without communicating the fire to the surrounding atmosphere. This method of testing for gas in the working places and wastes, which is obviously only to be trusted in skilled hands, used to be commonly practised, but since the introduction of safety-lamps it has fallen into disuse.

The principle involved in the construction of safety-lamps consists in surrounding the flame of a lamp by a protecting metal case, perforated with numerous small holes, through which the air for feeding the flame may freely enter, and the products of combustion pass out, while the passage of flame, or gases sufficiently heated to cause the ignition of the external air when laden with explosive gases, is prevented. In 1816 Sir Humphry Davy made the great discovery that these conditions are fulfilled by the use of tubes reduced to a mere section, such as the apertures in wire gauze, when the substance of the wire is rightly proportioned to the size of the aperture. The standard adopted as the limit for safety at that time was a gauze of 28 iron wires to the linear inch, having 784 apertures per square inch, which has been used ever since. The common safety or Davy lamp consists of a small cylindrical oil lamp, covered with a cylinder of wire gauze about six inches long and  $1\frac{1}{2}$  inches in diameter, with a flat gauze top. The upper part of the gauze is doubled to prevent its being worn into holes by the products of combustion, and the air for feeding the flame enters round the wick. The gauze is mounted in a cage, consisting of three upright wires, screwed into a flat brass ring at each end. A handle is attached to the upper ring, while the lower one screws on to a collar on the oil-vessel of the lamp. When the two parts are screwed together the lamp is locked by a bolt passing through both parts, which is screwed down flush with or below the surface of the outer ring, so that the gauze cannot be removed without the use of a key.

In Stephenson's safety-lamp, generally known as the "Geordie," from the inventor George Stephenson, the light is covered by a glass chimney, surrounded by an outer casing and top of wire gauze. The feed air is admitted through numerous small holes in a copper ring a little below the level of the wick. This is one of the safest forms of lamp, but requires considerable care in use, especially in keeping the small feed holes clear from dust and oil; the glass protects the gauze from becoming overheated, and when the air is dangerously charged with gas the light is extinguished.

Various forms of safety-lamps have been introduced at different times, for the purpose of increasing the amount of light by substituting a glass cylinder for the lower portion of the wire gauze. The oldest of these is that of Dr. Clanny, contemporary with those of Davy and Stephenson. The air for supplying the flame, entering at the bottom of the gauze, and passing down the inner side of the glass, protects the latter to some extent from becoming overheated, but a large amount of light is lost by absorption in the glass, so that there is no great advantage over the ordinary Davy lamp to compensate for the extra weight and cost, especially as the safety property of the lamp depends upon the glass cylinder, which may be readily broken when subjected to the ordinary accidents of working. A more perfect form of lamp of the same character is that of Museler, which is extensively used in Belgium. It differs from Clanny's lamp by the addition of a conical chimney above the flame, which produces a rapid draught, and consequently a more perfect cooling of the glass cylinder by the down-draught of feed air for the flame.

Boty's lamp, which was recommended by a commission of the Belgian Government as being safe in use, is essentially that of Dr. Clanny with Stephenson's perforated ring for admitting air at the level of the wick. Another Belgian variety is that of Eloin, in which the glass is shaped to the surface produced by the revolution of a parabolic arc, so as to disperse the light in parallel lines. The air is admitted by a Stephenson ring, combined with an Argand cap, the glass being surrounded by a brass chimney with a gauze top. In another form of the same lamp Museler's chimney is added.

The locking of safety lamps, so as to render them incapable of being opened by the miners when at work, is a point that has given play to a large amount of ingenuity. One of the most favorite devices is a combination of the wick-holder with the locking-bolt, so that the latter cannot be withdrawn without lowering the wick and extinguishing the flame. Another method consists in the use of a lead rivet, uniting the two parts of the lamp, impressed with a seal, which cannot be removed without defacing the device. All this class of contrivances have the defect of only being efficacious when the miners are not provided with matches, or other means of obtaining a light. A more physically perfect method is that adopted by Bidder, where the locking-bolt is magnetized and held in place by a force which can only be overcome by the application of a battery of heavy and powerful steel magnets. These are kept in the lamp cabin at the pit bottom, where the lamps are cleaned and served out lighted to the miners at the commencement of the shift, and are collected before they return to the surface.

When a Davy lamp is exposed to an atmosphere containing less than 8 per cent. of marsh gas, the flame lengthens and becomes smoky; when that amount is reached the flame returns to its usual size, but a column of blue flame rises to the top of the gauze. With 10 per cent. the flame of the wick is extinguished, the whole of the space within the gauze being filled with a blue flame of burning gas. If the lamp is allowed to remain too long in a fiery atmosphere it becomes dangerous, as the gauze being heated to redness may fire the gas. The safety of the lamp is also endangered by an exposure to a current of gas moving at the rate of more than 6 or 8 feet per second, as the flame can then be readily driven through the gauze. It is therefore usual to protect the flame by a sliding shield of tin plate, horn, or mica from the direct action of any sudden outburst of gas in the workings. Lamps with glass cylinders are generally very safe, except from the risk of accidental breakage, which, however, is less frequent than might be imagined, and those taking air through a feed ring, such as Stephenson's, are readily extinguished in a foul atmosphere.

The danger arising from gas in the workings may be considerably increased by the presence of coal dust in the air. This point has been the subject of investigation by Galloway, who found that an explosion may be produced by igniting particles of coal dust through the agency of a safety-lamp which under ordinary circumstances would be perfectly trustworthy. At Blanzay, in France, several fatal explosions have been traced to the firing of coal dust from the flame of a shot, even in cases where no fire-damp was present in the workings.

An electric lamp, where the light is obtained from the discharge in a Geissler vacuum tube, has been proposed by Benoit-Dumas, instead of the ordinary safety-lamps, or for use in exploring after explosions or in bad air-ways. This consists of a box containing a galvanic battery, consisting of two Bunsen cells, and a small induction coil, with connecting wires which convey the current to the lamp. The Bunsen cells may be conveniently replaced by a single bottle-shaped bichromate battery. The cost and complication of this apparatus must necessarily limit its use. Electric lamps.

Apparatus, originating in France, known as *aërophores*, which enable the miner to carry sufficient fresh air for his own respiration, and to keep a lamp alight for a short time in a totally irrespirable atmosphere, have of late years come into use for the purpose of saving life after explosions, and repairing shafts and pit-work under water. There are two principal patterns, those of Galibert and Denayrouze. The former, which is the simplest, consists of an air-tight bag of about 12 cubic feet capacity, containing air at a little above atmospheric pressure, which is carried on the miner's back like a knapsack. The air, after being used, is returned with the products of respiration into the bag, and can be used over again until it becomes too impure for further use. It is obvious, therefore, that such an apparatus must be of very limited application, but its simplicity and cheapness are points in its favor for use in sudden emergencies. The Denayrouze apparatus consists of a series of sheet metal cylinders, containing air compressed to 300 or 350 lb to the square inch, which can be carried on the back, and served out at a pressure very Aërophores.

lightly above that of the atmosphere by means of a reducing valve, whose construction is essentially the same in principle as that of the ordinary pressure regulator used in gas-works, i. e., a conical plug closed against its seat by the pressure of the air in the reservoir, which is constantly opposed by an external force tending to open it. This force is supplied by a disc of vulcanized india-rubber, which opens the valve at each inspiration, and allows a fresh supply of air to escape into the chamber of the regulator through the small aperture of the valve. Of course, all communication with the external air must be cut off, so that respiration can only take place through the mouth, the air-tube being attached by an india-rubber mask called a mouth-closer, and the nostrils closed by a spring clip. A similar regulator valve, so constructed as to keep the india-rubber spring under a slight excess pressure in order to maintain a flow of air, is in connection with the lamp. This is of the ordinary Museler construction, with the addition of a chamber outside the gauze to receive the products of combustion, which are discharged through a conical valve at the top, a reflux of the exterior gases being prevented by the pressure of a counter spring. The air is carried to the lamp by an india-rubber tube, which is sufficiently flexible to allow a certain freedom of motion. The distance that an explorer can penetrate with this apparatus is obviously limited by the capacity of the air-cylinders. These have been made large enough to supply air to a man with a lamp for an hour, but this is an inconvenient size, being too large to be carried on the back.

**Fires in mines.** Underground fires are not uncommon accidents in coal-mines. In the thick coal workings in South Staffordshire the slack left behind in the sides of work is especially liable to fire from so-called spontaneous combustion, due to the rapid oxidization that is set up, when finely-divided coal is brought in contact with air. The best remedy in such cases is to prevent the air from gaining access to the coal by building a wall round the burning portion, which can in this way be isolated from the remainder of the working, and the fire prevented from spreading, even if it cannot be extinguished. When the coal is fired by the blast of an explosion it is often necessary to completely isolate the mine by stopping up the mouths of the pits with earth, or in extreme cases it must be flooded with water or carbonic acid before the fire can be brought under. There have been several instances of this being done in the fiery pits in the Barnsley district, notably at the great explosion at the Oaks colliery in 1866, when 360 lives were lost.

**Methods of winding.** The drawing or winding of the coal from the pit bottom to the surface is one of the most important operations in coal mining, and probably the department in which mechanical appliances have been brought to the highest state of development. In the simplest case where the mine is worked by levels, the trains of coal may be drawn from the working faces directly to the level mouth by horse power, or in some exceptional cases locomotives worked by compressed air are used. In South Wales the power for lifting the load in the shaft is still in some small workings furnished by a water balance, that is, a box which is filled with water at a high level, and in descending raises the loaded trucks by a rope passing over a pulley at the surface. This method is only available when there is a free drainage level for the water to run off when the box reaches the lowest point. Other hydraulic motors, such as wheels, pressure engines, &c., are used in different localities as well as animal power, where the amount of coal to be drawn is small, but as a general rule it is necessary to have recourse to steam power to maintain an adequate output. The old custom of drawing the coals in tubs or hutches (*cuffat* of the French miner), swinging freely from the end of the drawing rope, is now almost entirely superseded by the adoption of cages sliding between fixed guides, which allow the load to move freely up and down while checking lateral oscillation. This improvement, which is due to Mr. John Curr of Sheffield, was originally introduced in 1798, but made surprisingly little progress for nearly half a century. It was first brought into general use in the North of England, but in many of the smaller pits of the Midland counties the older custom prevailed until recently.

**Cage.** The different elements making up the drawing arrangements of a colliery are—(1) the

cage, (2) the shaft or pit fittings, (3) the drawing-rope, (4) the engine, and (5) the surface arrangements. The cage, as its name implies, consists of one or more platforms connected by an open framework of vertical bars of wrought iron or steel, with a top bar to which the drawing-rope is attached. It is customary to have a curved sheet-iron roof or bonnet when the cage is used for raising or lowering the miners, to prevent them from injury by falling materials. The number of platforms or decks varies considerably; in small mines only a single one may be used, but in the larger modern pits two, three, or even four-decked cages are used. The use of several decks is necessary in old pits of small section, where only a single tram can be carried on each. In the large shafts of the Northern and Wigan districts the cages are made about 8 feet long and 3½ feet broad, being sufficient to carry two large trams on one deck. These are received upon a railway made of two strips of angle iron of the proper gauge for the wheels, and are locked fast by a latch falling over their ends.

The guides or conductors in the pit may be constructed of wood, in which case rectangular fir beams, about 3 by 4 inches, are used, attached at intervals of a few feet to buntons or cross-beams, built into the lining of the pit. Two guides are required for each cage; they may be placed opposite each other, either on the long or short sides—the latter being preferable. The cage is guided by shoes of wrought iron, a few inches long and bell-mouthed at the ends, attached to the horizontal bars of the framing, which pass loosely over the guides on three sides. In some of the large collieries in Northumberland wrought iron guides have been adopted with advantage. They are applied on one side of the cage only, forming a complete vertical railway,—light flange rails such as are used for the roadways underground being used instead of wooden rods and iron cross sleepers, with proper seats for the rails instead of wooden buntons; the cage is guided by curved shoes of a proper section to cover the heads of the rails. Rigid guides connected with the walling of the pit are probably the best and safest, but they have the disadvantage of being liable to distortion, in case of the pit altering its form, owing to irregular movements of the ground, or other causes. Wooden guides being of considerable size, block up a certain portion of the area of the pit, and thus offer an impediment to the ventilation, especially in upcast shafts, where the high temperature, when furnace ventilation is used, is also against their use. In the Wigan district, wire-rope guides have been introduced to a very considerable extent, with a view of meeting the above objections. These are simply wire-ropes, from ¾ to 1½ inches in diameter, hanging from a cross-bar connected with the pit-head framing at the surface, and attached to a similar bar at the bottom, which are kept straight by a stretching weight of from 30 cwt. to 4 tons attached to the lower bar. In some cases four guides are used—two to each of the long sides of the cage; but a more general arrangement is to have three—two on one side, and the third in an intermediate position on the opposite side. Many colliery managers, however, prefer to have only two opposite guides, as being safer. The cage is connected by tubular clips, made in two pieces and bolted together, which slide over the ropes. In addition to this, it is necessary to have an extra system of fixed guides at the surface and at the bottom, where it is necessary to keep the cage steady during the operations of loading and landing, there being a much greater amount of oscillation during the passage of the cage than with fixed guides. For the same reason it is necessary to give a considerable clearance between the two lines of guides, which are kept from 15 to 18 inches apart, to prevent the possibility of the two cages striking each other in passing. With proper precautions, however, wire guides are perfectly safe for use at the highest travelling speed.

The cage is connected with the drawing-rope by short lengths of chain from the corners known as tackling chains, gathered into a central ring, to which the rope is attached. Round steel wire-ropes, about 2 inches in diameter, are now commonly used; but in very deep pits they are sometimes tapered in section to reduce the dead weight lifted. Flat ropes of steel or iron wire were and are still used to a great extent, but round ones are now generally preferred. In Belgium flat ropes of aloë fibre are in high repute, being considered

preferable by many colliery managers to wire, in spite of their great weight. In South Staffordshire, flat link chains made with three or more parallel links, with a stud of wood filling up the hollow, are or were in general use in the numerous shallow pits working the thick coal in the neighborhood of Dudley, &c.

The best modern engines for drawing in collieries are usually direct-acting, with either horizontal or vertical cylinders. In the north of England a single engine with a heavy fly-wheel is often used, but the more general arrangement is to have two engines coupled to the opposite ends of the winding drum-shaft. In almost all cases steam is used at high pressure without condensation.

The drum, when round ropes are used, is a plain broad cylinder, with flanged rims, and cased with soft wood packing, upon which the rope is coiled; the breadth is made sufficient to take the whole length of the rope at two laps. One drum is usually fixed to the shaft, while the other is loose, with a screw link or other means of coupling, in order to be able to adjust the two ropes to exactly the same length, so that one cage may be at the surface when the other is at the bottom, without having to pay out or take up any slack rope by the engine.

For flat ropes, the drum or bobbin consists of a solid disc, of the width of the rope fixed upon the shaft, with numerous parallel pairs of arms or horns, arranged radially on both sides, the space between being just sufficient to allow the rope to enter and coil regularly upon the preceding lap. This method has the advantage of equalizing the work of the engine throughout the journey, for when the load is greatest, with the full cage at the bottom and the whole length of rope out, the duty required in the first revolution of the engine is measured by the length of the smallest circumference; while the assistance derived from gravitating action of the descending cage in the same period is equal to the weight of the falling mass through a height corresponding to the length of the largest lap, and so on, the speed being increased as the weight diminishes, and *vice versa*.

The same thing can be effected in a more perfect manner by the use of spiral or scroll drums, in which the rope is made to coil in a spiral groove upon the surface of the drum, which is formed by the frusta of two obtuse cones placed with their smaller diameters outwards. This plan, though mechanically a very good one, has certain defects, especially in the possibility of danger resulting from the rope slipping sideways, if the grooves in the bed are not perfectly true. The great size and weight of such drums are also disadvantages, as giving rather unmanageable dimensions in a very deep pit.

The use of a counterbalance chain for the winding engines is common in the collieries of the Midland districts of England. In this method a third drum is used to receive a heavy flat link chain, shorter than the main drawing-ropes, the end of which hangs down a special or balance pit. At starting, when the full load is to be lifted, the balance chain uncoils, and continues to do so until the desired equilibrium between the working loads is attained, when it is coiled up again in the reverse direction, to be again given out on the return trip.

The surface arrangements of a modern colliery are often of considerable extent and complexity, the most important feature being the pit-frame carrying the guide-pulleys or rope-rolls which lead the drawing-ropes from the vertical line of the pit to the engine-drum. This consists essentially of an upright framework, carefully braced together, and strutted by diagonal beams against the wall of the engine-house, or other solid abutment. It is generally necessary to have a clear head-room, 10 or 20 feet or more, for the working arrangements at the surface above the level of the ground, especially in flat countries; the pit-frames are made of considerable height, from 50 to 70 feet being not uncommon; and when, as is generally the case, they are made of wood, they afford opportunities for the exercise of skilful carpentry. Of late years, however, wrought-iron pit-frames have been adopted to some extent, which allows of a comparatively simpler construction being used, the main elements of the frame consisting of hollow latticed pillars and beams, similar to the construction now generally adopted for the pillars of railway signals, but of course of a more solid construction. They have one great advantage

over wooden frames, in not being liable to destruction by fire, an accident which has occasionally happened with the latter. The guide-pulleys for iron or steel wire-ropes are made of very large dimensions, to avoid strain upon the wires by sudden change of direction when moving at a high speed. The usual construction is a deep channeled rim or tire of cast-iron, from 7 to 20 feet in diameter, supported by numerous thin wrought-iron arms, inclining inwards from a central cast-iron boss,—a form combining rigidity with comparative lightness. They are in fact very similar to the driving wheels of the large modern bicycles, supposing a channeled rim to be substituted for the India-rubber tire.

To prevent accidents from the breakage of the rope on the shaft, or from overwinding when the engine is not stopped at the right moment, whereby the cage may be dragged up to the head pulleys (both which kinds of accident are unhappily not uncommon), various forms of safety catch and disengaging hooks have been proposed. These consist of variously-constructed toothed levers, cams, or eccentrics, mounted

Safety catches.

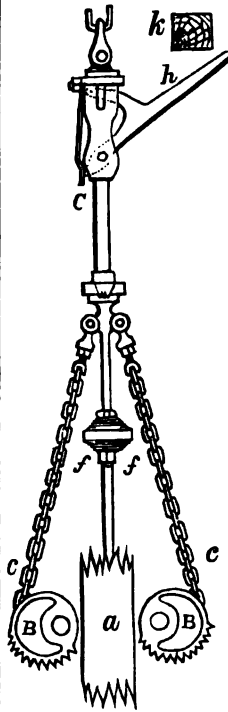

FIG. 19.

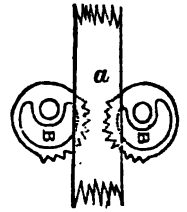

FIG. 20.

upon transverse axes, attached to the top of the cage, whose function is to take hold of the guides, and support the cage in the event of its becoming detached from the rope. They are generally applied by means of springs acting against the pull of the rope. Figs. 19-21 represent a form of safety catch, introduced some years since by Messrs. White and Grant of Glasgow. The catches BB consist of partially toothed eccentrics, which when released are forced inwards against the wooden guide *a* by the coiled springs *d d*, as shown in fig. 21.

When the rope is drawing, the catches are lifted by the pull of the chains attached to the pulleys *c c*, which turn the broad-toothed portions outwards, and away from the

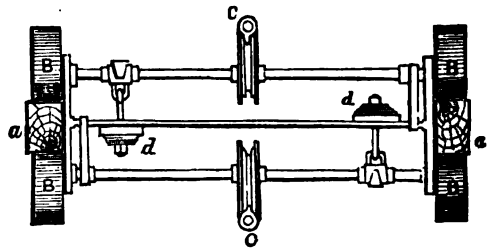

FIG. 21.

FIGS. 19-21.—White and Grant's Safety Catch.

guides. The connection with the rope is made by the slide bar *C* and spring catch *h* having a projecting trigger, which, if the cage is lifted too high, strikes against the cross-bar of the framing *k*, and detaches the cage, which is then left hanging by the catches to the guides in the pit. The use of safety catches is more common in the collieries of France, Belgium, and Germany than in England, where they are not generally popular, owing to their uncertainty in action, as they are often found to fail



when most wanted. The constant drag of the catches on the guides when the rope slacks is also objectionable, but this has been overcome to a great extent in a very ingenious contrivance invented by Mr. Calow, where the catches are not brought into action unless the cage is actually falling clear of the rope, with a certain acquired momentum of its own. The only real safeguards against

draw from 600 to 1200 tons in the shift of 10 hours. When the pits are of small depth it is better to increase the weight of the load than to draw at a very high speed, as the loss of time in filling and unloading or striking the cages is the same for a short as for a long journey, so that it becomes advantageous to diminish the number of journeys for a given quantity of coal drawn.

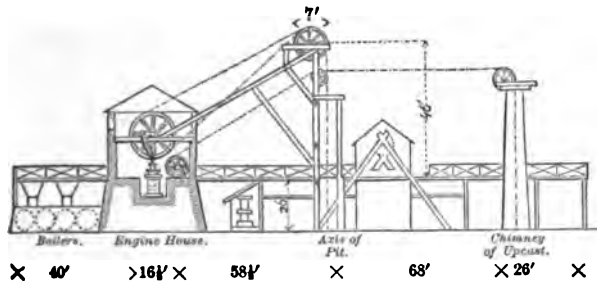

FIG. 22.—Elevation.

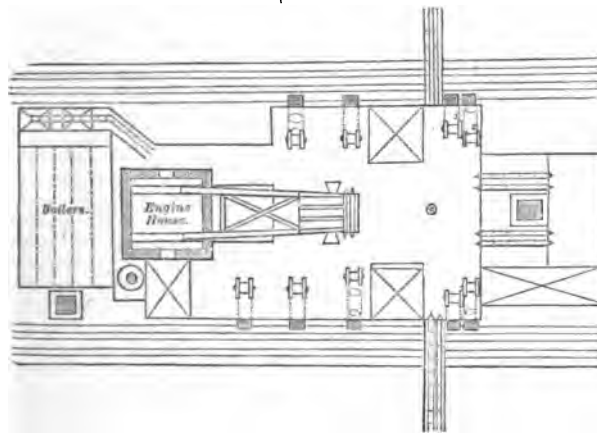

FIG. 23.—Plan.

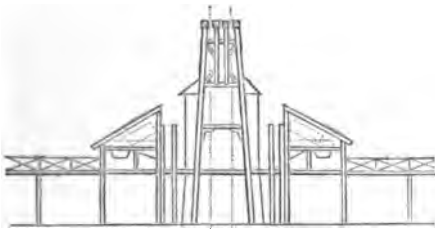

FIG. 24.—Transverse Elevation.

FIGS. 22-24.—Surface arrangements of Colliery.

accidents in winding are to be found in constant vigilance, in maintaining the ropes in working efficiency, and in the use of proper signals and brake power in the engine house.

The speed attained by the load in the shaft in the best-appointed English collieries is very considerable, and may be paralleled with that of a fast railway train. At Shireoaks Colliery, Nottinghamshire, the cage with a load of 34 cwt. of coal in five tubs, and weighing in all 60 cwt., or with the rope at the bottom 92½ cwt., is raised from a depth of 516 yards in 45 seconds, corresponding to an average of 35 feet per second, or 24 miles per hour, the maximum speed when the load is midway being 60 feet per second, or nearly 35 miles an hour. The ropes used are round, of steel wire, weighing 13 lbs. to the yard, winding on to a spiral drum, increasing from 17 to 20 feet in diameter. There are two engines with vertical cylinders, 32 inches diameter and 6 feet stroke, developing a useful effect of about 320 horse-power. The guide pulleys are 12 feet in diameter.

The above may be taken as a good example of the modern class of winding engines, such as are required to

corresponding to those of the cage, carried on the head of a plunger movable by hydraulic pressure in a vertical cylinder. The empty tubs are carried by a corresponding arrangement on the opposite side. By this means the time of stoppage is reduced to a minimum, 8 seconds for a three-decked cage as against 28 seconds, as the operations of lowering the tubs to the level of the pit-top, discharging and replacing them are performed during the time that the following load is being drawn up the pit.

The tub when brought to the surface, after passing over a weigh-bridge, where it is weighed and tallied by a weigher specially appointed for the purpose by the men and the owner jointly, is run into a tipping cage, and the contents are discharged into an inclined screen with bars about 1 inch to 1½ inches apart. The large coal remaining passes through a spout into a railway wagon placed below, the discharge being regulated by a valve at the lower end. The small coal passing through is either sold as such, or may be lifted by an elevator to a second series of screens, either fixed or rotating, with half-inch apertures. These make a further separation of larger pieces, which are sold as "nuts," while the small, or slack, passing through is sent to the coke ovens, if the quality of the coal is suitable. As a rule, non-caking coals are not very closely screened, as the small is of comparatively little value, and therefore must have a proportion of larger sizes mixed with it to form salable slack.

Figs. 22-24, representing the surface arrangements adopted at a pair of pits in the Wigan district, may be taken as fairly representative of the fittings of a large modern colliery, where a considerable output of coal has to be screened and loaded in an ordinary working day of less than twelve hours. The details, of course, will vary, according to the nature of the outlet or vend, which may be by retailing into carts sent by purchasers, or by canals or rail-

Illustrations of surface arrangements.

ways, or by a combination of all three. In the example selected, the coal is loaded directly from the screens into full-sized trucks, each carrying from 6 to 8 tons, on a main line of railway. Of the two pits, one is an upcast, and is surmounted by a chimney at the surface,—the drawing being confined to the downcast, which is 310 yards deep and 10½ feet in diameter. 600 tons of coal are drawn from this depth in 10 hours by a pair of direct-acting engines, with vertical cylinders working a spiral drum, increasing from 13½ feet to 17½ feet in diameter. The pit-head frame is of wood, with guide pulleys 7 feet in diameter,—a much smaller size than is now usually adopted; the iron wire drawing-ropes are round, weighing 5 lb to the yard. Double-decked cages of a light construction in wrought iron are used, carrying four tubs at a time. The landing platform is raised upon pillars 20 feet above the surface of the ground, and covered with iron plates. As soon as the cage arrives at the surface, the tubs are run into tumbling cages, which discharge their contents on to fixed screens, with bars of 1 to 1½ inch aperture. The large coal passes

over to protect the workmen from the weather. The second pit, which occupies a corresponding position on the opposite side of the engine house, is in every respect similar.

The large collieries in the steam-coal district of Northumberland are among the most productive; thus, at Bedlington, near Morpeth, 1200 tons are raised daily, and at North Seaton from 1500 to 1800 tons.

When the coal is very much mixed with shale, the slack often contains so much mineral matter as to be quite worthless, until at least a partial separation has been effected. This is now done by means of coal-washing machines, which were first adopted in France, but have now become general in other countries. There are many different forms, but the most usual is a fixed sieve plate, upon which the slack is received and subjected to the action of a current of water forced through the holes by the action of a fast-moving short stroke plunger-pump, which puts the whole of the materials into suspension, and allows them to fall through the water at each stroke. By this means the coal, being the lighter material, travels to the surface, and the heavier shale and stone going to the bottom are discharged through a valve there. The apparatus is in fact a form of the hydraulic jiggling hutch used for the dressing of lead and other ores, except that in this case the lighter and not the heavier part is the valuable mineral. In another form of coal-dressing machine introduced by Mr. Evrard, the jiggling action is produced by a jet of steam acting directly upon the water instead of a plunger piston. Washed slack when suitable is used for conversion into coke, but in France and Belgium it is now generally employed in the production of agglomerated fuel, or briquettes, or what is usually known in England as patent fuel. These consist of coal dust mixed with a sufficient amount of gas-pitch to be moulded into coherent bricks or cylinders, which are afterwards dried at a high temperature, but below the point of carbonization. The consolidation of the slack may also be effected by the use of starch or dextrine, or even by cement or clay. This class of fuel is much used upon the French railways, being convenient for stowage and economical in use; but as a rule it is disagreeable to the passengers from the large amount of coal dust carried off by the exhaust steam, and the unpleasant vapors produced by the burning pitch. The principal production of patent fuel in Britain is in South Wales.

The anthracite coal of Pennsylvania is subjected to the exceptional treatment of breaking between toothed rollers, and an elaborate system of screening before it is fit for sale. The largest or lump coal is that which remains upon a riddle having the bars four inches apart; the second, or steamboat coal, is above 3 inches; broken coal includes sizes above 2½ or 2¾ inches; egg coal, pieces above 2½ inches square; large stove coal, 1½ inches; small stove, 1 to 1½ or 1½ inches; chestnut coal, ¾ to ¾ inch; pea coal, ½ inch; and buckwheat coal, ¼ inch. The most valuable of these are the egg and stove sizes, which are broken to the proper dimensions for household use, the larger lumps being unfit for burning in open fire-places.

The proportion of coal utilized in the working, as compared with the total contents of the seam, varies very considerably in different districts, being greatest in seams of moderate thickness, from 3 to 5 feet, which on the long-wall system can be entirely removed. In thick coals, such as the ten-yard seam of South Staffordshire, the waste is very considerable. In Cheshire and Lancashire about 1330 tons of salable coal are obtained from an acre for each foot of thickness in the seam, only 8 per cent. of the total being left behind in the workings.

At Dowlais, on the north of the South Wales coal-field, the yield is 1190 tons to the foot by long-wall, but only 866 tons when the same seam was worked by the pillar and stall system; but on the south side of the basin, where the seams lie at a steep slope, the loss is often much greater, being from 20 to 50 per cent. on pillar and stall workings. In the Barnsley district, the yield is from 1150 to 1280 tons in thick seams, and a maximum of 1417 tons has been obtained in a thin seam, the solid contents of the whole

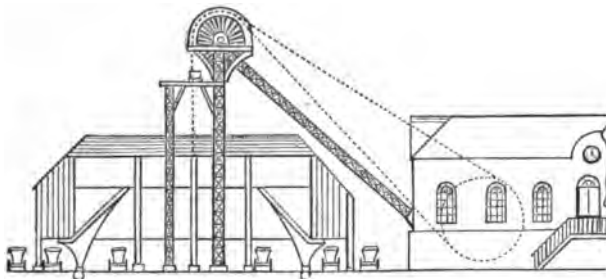

Elevation.

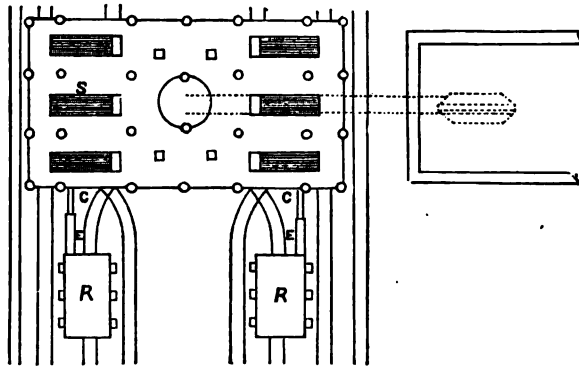

Plan.

Fig. 25.—Surface arrangements, Pemberton Pit, Wigan.

by a shoot directly into the railway wagon, while the first screenings fall into a channel below, which is traversed by a series of scrapers attached to an endless chain, and are carried to an elevator or Jacob's ladder, and discharged into rotatory drum sieves of about ½ inch aperture, producing a second size of salable coal, known as nuts, and slack, which is sent away to the coke ovens attached to the colliery. The whole of the labor required in the screening the output of 600 tons in the day of ten hours is performed by one engineman, who has charge of all the mechanical arrangements, and nine boys, who pick out any large lumps of stone from the coal as it passes the first screens. The engine driving the screens and elevators is in charge of a special engineman.

Fig. 25 represents one of a pair of pits at Pemberton Colliery, near Wigan, having the pit frames constructed in wrought-iron lattice truss-work instead of wood. The screens for large coal (S) are arranged symmetrically on the landing platform, three on each side of the pit top, and discharge directly into wagons on the railway below. The small coal from these screens is passed by a screw creeper C, like those used in flour mills, to a bucket elevator E, which delivers it at the top of the second set of screens R, where the nuts and slack are separated. The platform, as in most of the new collieries in this district, is roofed

Proportion of coal obtained in working.

coal being estimated at 1556 tons per foot per acre. In Northumberland about 1200 tons are got out of a total of 1300. In the thick coal of South Staffordshire, from 12,000 to 16,000 tons per acre are got at the first working on an average thickness of 25½ feet, or about 640 tons to the foot, or from 50 to 60 per cent. of the whole, which is increased by the second and third working to 70 or 75 per cent., making a loss of from 25 to 30 per cent. This amount is reduced, however, by the long-wall method of working.

Probably from 10 to 15 per cent. may be taken as the unavoidable loss in working under the most favorable conditions, but in many cases the proportion is considerably higher.

In the United Kingdom the ownership of coal, like that of other minerals, is in the proprietor of the soil, and passes with it, except when specially reserved in the sale. The greater number of collieries are worked upon leases, the rents or royalties being variously charged in different localities. A minimum reserved rent to cover a certain output, with a rate per ton on any quantity in excess, is the most general practice; but in Lancashire and Yorkshire the royalties are charged at a fixed rate per acre per annum upon each seam worked, and in South Staffordshire at a proportion (from ¼ to ⅓) of the coal at the pit's mouth.

Coal lying under the sea below low-water mark belongs to the Crown, and can only be worked upon payment of royalties, even when it is approached from shafts sunk upon land in private ownership.

In the Forest of Dean, which is the property of the Crown as a royal forest, there are certain curious rights held by a portion of the inhabitants known as the Free Miners of the Forest, who are entitled to mine for coal and iron ore, under leases, known as gales, granted by the principal agent or gaveler representing the Crown, in tracts not otherwise occupied. This is the only instance in Great Britain of the custom of free mining under a government grant or concession, which is the rule in almost every country on the Continent.

The working of collieries in the United Kingdom is subject to the provisions of the Coal Mines Regulation Act of 1872, 35 and 36 Vict. cap. 76, which is administered by inspectors appointed by the Home Office, and forms a complete disciplinary code in all matters connected with coal-mining. Among the chief provisions of the Act are the following:—

1. Females and boys under 10 are not allowed to work underground.
2. Boys between 10 and 12 are not allowed to work except in thin mines.
3. No boy under 12 to drive a gin horse, or under 18 a steam-engine.
4. Wages not to be paid at public-houses.
5. Working of mines by a single shaft prohibited.
6. Managers to be certificated as competent by a board of examiners.
7. Annual return of coal wrought to be made to Inspector.
8. Notice of accidents to be sent to Inspector.
9. Openings of abandoned workings to be fenced.
10. Plans to be kept up to within six months of date.
11. Plans of abandoned mines to be deposited with Home Office.
12. General rules for the safety of miners in fiery mines, management of ventilation, safety lamps, and gunpowder, protection against accidents in shafts and levels, &c.
13. Power to frame special rules subject to approval of the Secretary of State.

Breaches of the provisions of the Act are punishable by fine and imprisonment by a court of summary jurisdiction, subject to appeal to the Quarter Sessions, or to the Circuit Court in Scotland.

The relation between the number of hands employed and the output of collieries varies considerably in different districts, being highest in those where the coal is moderately soft, easily cut, regularly shaped, and with a good roof, and least in faulted and disturbed seams, and those with a bad roof, where the accessory operations of timbering and driving stone drifts require the employment of a large proportion of the working staff on non-productive work, i.e., other than cutting coal. The following figures give the relative force employed above and below ground in two

large steam-coal collieries in South Wales, each producing about 500 tons per day:—

Colliers cutting coal.....	225	200
Other underground hands.....	229	174
Surface hands.....	43	36
	497	410

showing in the one case an average of about 1 ton, in the other about 1½ tons, per hand per day, but if the hands cutting coal be alone considered, the amount is about the same in both cases, or a little over two tons per day.

The annual output per man on the total force employed in several of the principal European coal-fields has been computed as follows:—

Newcastle.....	315 tons per man per annum.
Westphalia.....	215 " "
Saarbrücken.....	170 " "
France—Loire.....	200 " "
" Nord.....	149 " "
Belgium—Charleroi.....	147 " "
" Mons.....	124 " "

These figures refer to some years back, and are probably not quite accurate at the present date, as the amount of work done by the individual collier has sensibly decreased in most countries. It will be seen that the output is smallest in the thin disturbed measures of the Franco-Belgian coal-field.

In Prussia in 1874, with an output of 33,000,000 tons of coal and 8,000,000 tons of lignite, the average per underground hand was about 243 tons for the former and about 600 tons for the latter. The larger comparative yield in lignite mines is due to the fact that a very large proportion are worked as quarries.

The annual production of coal throughout the world may be roughly estimated at about 260 millions of tons for 1874, which quantity includes about 17 million tons of lignite and coal from formations newer than the coal measures in Europe. Nearly one-half of the total is raised in the United Kingdom, the approximate quantities of the different countries being as follows:—

	Tons.	
United Kingdom.....	125,000,000	
United States of America...	48,000,000	
Germany.....	35,000,800	Lignite, 9,000,000
Belgium.....	17,000,000	
France.....	17,500,000	" 320,000
Austria.....	4,700,000	" 5,700,000
New South Wales.....	1,300,000	
Russia.....	1,000,000	" 30,000
Spain.....	750,000	" 50,000
India.....	700,000	
Smaller European States....	125,000	" 105,000
British North America.....	750,000	
Chili.....	200,000	
Other Australian Colonies...	50,000	

There is no trustworthy information as to the produce of China and Japan, but these probably do not exceed 100,000 tons. In the larger coal-producing European countries the output was very high in 1873, the following year having shown a slight falling off, but in America the annual increase was maintained.

The quantities of coal consumed by the different branches of manufacturing industry as well as for lighting, heating, and other purposes was investigated by the Royal Commission on Coal, from vol. iii. of whose Report, published in 1870, the following summary is taken. The figures refer to the year 1869.

	Tons.
Total quantity of coal raised.....	107,427,537
Do. exported.....	9,775,470
Leaving for home consumption.....	97,652,067
1. Coal used for iron manufacture.....	32,446,606
2. Do. producing power and general manufacturing purposes....	25,327,213
3. Do. domestic purposes.....	18,481,527
4. Do. gas and water supply.....	7,811,980
5. Do. mines and collieries.....	7,225,423
6. Do. steam navigation.....	3,277,562
7. Do. railways.....	2,027,500
8. Do. smelting metals other than iron.....	859,281
9. Do. miscellaneous purposes.....	195,045
	97,652,067

The above quantities may be proportionally classified as follows:—

Mineral and metallurgical industries (1, 5, 8).....	44 pr. ct.
Domestic consumption, including gas and water (3, 4).....	26 “
General manufacturing purposes (2).....	25 “
Locomotion by sea and land (6, 7).....	5 “
	100

According to the official mineral statistics, the produce of coal in the United Kingdom for the years 1873, 1874, 1875, classified according to districts, was as shown in the following table, from which it will be seen that the check in 1874 was followed by great increase of production in 1875:—

	1873.	1874.	1875.
	Tons.	Tons.	Tons.
N. Durham.....	12,204,340	6,180,000	12,640,789
Northumberland....	1,747,064	6,463,550	1,226,737
Cumberland.....	1,972	1,102,267	
Westmoreland.....	1,972	1,200	
S. Durham.....	17,436,045	17,900,250	19,456,534
Yorkshire.....	15,311,778	14,812,515	15,425,278
Derbyshire.....		7,150,570	7,091,325
Nottinghamshire....		3,127,750	3,250,000
Leicestershire.....	11,568,000	1,100,465	1,154,619
Warwickshire.....		851,500	799,750
S. Staffordshire.....	9,463,539	8,389,343	9,251,791
Worcestershire.....			
Shropshire.....	1,570,000	1,187,950	1,229,785
N. Staffordshire.....	3,892,019	4,315,096	4,496,213
Cheshire.....	1,150,500	615,105	658,945
N. and E. Lancashire	9,560,000	8,095,570	8,825,798
W. Lancashire.....	7,500,000	7,442,950	8,250,246
N. Wales.....	2,450,000	2,425,300	2,337,308
Gloucestershire.....	1,858,540	1,147,272	1,273,080
Somersetshire.....		609,684	654,878
Monmouthshire.....	4,500,000	5,038,820	3,525,975
S. Wales.....	9,841,523	10,184,885	10,632,597
Scotland E.....	10,142,039	10,182,326	11,419,619
Do. W.....	6,715,733	6,608,335	7,177,888
Ireland.....	103,435	139,213	127,750
Total.....	127,016,527	125,067,916	130,906,905
Amount exported, including coke and patent fuel	12,748,390	14,045,325	14,544,916
Leaving for home consumption....	116,268,137	111,022,591	116,361,989
Value at pit's mouth	£47,629,787	£45,848,194	£43,969,370

Coal-mining is unfortunately a dangerous occupation, more than a thousand deaths from accident being reported annually by the inspectors of mines as occurring in the collieries of the United Kingdom. The following table shows the number of lives lost during the last five years, classified according to the inspectors' returns:—

Year.	Explosions of fire-damp.	Falls of ground.	Other under-ground accidents.	Accidents in shafts.	Accidents at surface.	Total.
1871	269	435	176	123	72	1075
1872	154	456	217	155	78	1060
1873	100	491	221	171	86	1069
1874	166	413	214	154	109	1056
1875	288	458	227	172	99	1244

The principal sources of danger to the collier, as distinguished from other miners, are explosion of fire-damp and falls of roof in getting coal,—these together make up about 70 per cent. of the whole number of deaths. It will be seen that the former class of accidents, though attended with great loss of life at one time, are less fatal than the latter. The great increase in the deaths from explosion in 1875, over the preceding year, is to be attributed to the Swaith Main explosion at Barnsley on December 6th, when 143 lives were lost.

The following return expresses the relation between the fatal accidents and the total number of miners employed, and the amount of coal raised for each death. The latter quantities are in some degree conjectural, being dependent upon estimated returns of produce, and are probably somewhat too large.

Year.	1 death for	
1871.....	345 miners employed	109,246 tons coal raised
1872.....	394 “ “	116,409 “ “
1873.....	479 “ “	133,667 “ “
1874.....	510 “ “	133,251 “ “
1875.....	430 “ “	118,730 “ “

In Prussia, in the year 1874, there were 484 deaths from accidents, which corresponds to about three deaths per thousand hands employed, or, according to the above classification, 1 in 334, with a produce of about 65,000 tons of coal for each death. It would appear, therefore, that the proportional loss of life, in the collieries of the United Kingdom, is less than that in foreign countries.

**Assay and Analysis.**—The chemical examination of a coal may be either complete or partial. When it is desired to obtain information as to the exact composition, the analysis is conducted in the same manner as the analysis of organic compounds by combustion with oxide of copper or chromate of lead in a hard glass tube, the carbonic acid and water formed being absorbed by solution of hydrate of potassium and dry chloride of calcium respectively, and the proportion of carbon and hydrogen being calculated from the increase of weight in the tubes containing the absorbing media. It is usual to operate upon a small sample (about 5 grains), which is very finely powdered and placed in a small trough or boat of platinum in the tube, the combustion being aided by a stream of oxygen from a gasholder. By this means the incombustible residue or ash is left in a condition for weighing, being free from admixture of foreign substances. Sulphur is determined by the fusion of a weighed quantity with a mixture of salt and nitrate of potassium in a platinum vessel, producing sulphate of potassium, which, on the addition of a salt of barium, is precipitated as sulphate of barium. Care must be taken to perform the operation over a flame free from the vapor of sulphur compounds, which may vitiate the result by apparently increasing the amount of sulphur present. For this reason, the flame of a spirit lamp is to be preferred in making the fusion to that of coal gas, which is rarely free from sulphur compounds. Sulphur existing in the form of gypsum or sulphate of calcium may be removed by washing a sample with boiling water, and determining the sulphuric acid in the solution. The washed sample is then fused with nitre in the usual way to determine the proportion of sulphur existing as iron pyrites. This distinction is of importance in the examination of coals intended for iron smelting, as the sulphates of the earthy metals are reduced by the gases of the furnace to sulphides, which pass into the slag without affecting the quality of the iron produced, while the sulphur of the metallic sulphides in the ash acts prejudicially upon the metal.

The difference between the original weight of the sample and that of the carbon, hydrogen, sulphur, and ash, after making allowance for hygroscopic water, is attributed to oxygen and nitrogen, which are not directly determined.

The character of the ash affords some guide to the quality of the coal from which it is derived. Thus, a red tint is generally indicative of the presence of iron pyrites, and a light or white color of its absence. Phosphorus if present will be found in the ash, and may be determined by the ordinary processes of analysis. A useful approximate method of determining the character of a coal is by exposing a coarsely powdered sample of known weight, in a covered crucible, to a strong red heat as long as inflammable vapors are given off, when it is cooled and weighed. The loss of weight represents the volatile constituents—hydrogen, oxygen, and hydrocarbon gases, produced by destructive distillation, while the residual coke includes the ash, and is called fixed carbon. The character of the button of coke obtained is a good indication as to the caking or non-caking quality of the coal from which it is derived, and the amount of ash may be determined by burning it in a muffle or over the flame of a Bunsen burner. The fitness of a coal for gas making is usually determined by operating upon a sample of a few pounds' weight in a special apparatus which reproduces the processes of manufacture upon a small scale.

One of the most important factors in the economic valuation of a coal, is the so-called calorific power or value, by which is usually understood the number of pounds of

water at boiling point that can be evaporated by the complete combustion of one pound of coal. This may be obtained theoretically, when the composition of the coal is known, by computing the heating effect of the carbon and the disposable hydrogen; but in the absence of an analysis, it may also be determined directly by several approximate methods. One of the most convenient instruments for this purpose is Thompson's calorimeter. This consists of a copper cylinder in which a weighed quantity of coal intimately mixed with chlorate or nitrate of potassium is deflagrated under a copper case like a diving-bell, placed at the bottom of a deep glass jar filled with a known weight of water. The gases produced by the combustion rising through the water are cooled, with a corresponding increase of temperature in the latter, so that the difference between the temperature observed before and after the experiment furnishes a measure of the evaporative power desired. The instrument is so constructed that 30 grains of coal are burnt in 29,010 grains of water, or in the proportion of 1 to 937, these numbers being selected that the observed rise of temperature in Fahrenheit degrees corresponds to the required evaporative value in pounds, subject only to a correction for the amount of heat absorbed by the mass of the instruments, for which a special co-efficient is required, and must be experimentally determined. Another approximate method, due to Berthier, is based upon the reduction of oxide of lead by the carbon and hydrogen of the coal, the amount of lead reduced affording a measure of the oxygen expended, whence the heating power may be calculated, 1 part of pure carbon being capable of producing 34½ times its weight of lead. The operation is performed by mixing the weighed sample with a large excess of litharge in a crucible, and exposing it to a bright red heat for a short time. After cooling, the crucible is broken and the reduced button of lead is cleaned and weighed. The results obtained by this method are less accurate with coals containing much disposable hydrogen and iron pyrites than with those approximating to anthracite, as the heat equivalent of the hydrogen in excess of that required to form water with the oxygen of the coal is calculated as carbon, while it is really about four times as great. Sulphur in iron pyrites also acts as a reducing agent upon litharge, and increases the apparent effect in a similar manner.

The theoretical evaporative power of a coal found by either of the above methods is always considerably above that obtained by actual combustion under a steam boiler, as in the latter case numerous sources of loss, such as imperfect combustion of gases, loss of unburnt coal in cinders, &c., come into play, which cannot be allowed for in theoretical experiments. It is usual, therefore, to determine the value of a coal by the combustion of a weighed quantity in the furnace of a standard boiler, and measuring the amount of water evaporated by the heat developed. Various investigations of this kind have been made at different times, both in Europe and America, the most extensive being the following:—

Johnson, *Report on American Coals*, Washington, 1844; De la Beche and Playfair, *Three Reports on Coal suited to the Steam Navy*, London, 1848-49-51; P. W. Brix, *On the Heating Power of Fuel used in Prussia*, Berlin, 1853; Hartig, *Heating Power of Saxon Coal*, Dresden, 1860.

The following table of the average results obtained from these investigations shows the number of pounds of water evaporated for every pound of the different kinds of coal burnt:

De la Beche & Playfair.	S. Wales—Average of 37 kinds,	9.05 lb
	N. of England,	17 " 8.37
	Lancashire,	28 " 7.94
	Scotland,	8 " 7.70
	Derbyshire,	8 " 7.58
Brix.	Wood,	7 " 3.66 to 4.10
	Peat,	5 " 3.43 to 3.66
	Lignite,	6 " 2.41 to 3.92
	Coal (Prussian),	51 " 6.42 to 8.16

**Literature.** The literature relating to coal and coal mining is very extensive, but the following list includes the titles of the more important works upon these subjects.

**ENGLAND AND AMERICA.**—*The Report of the Royal Coal Commission* (3 vols., fol., with Atlas, London, 1870). This is the most comprehensive work upon the subject. Hull, *Coal Fields of Great Britain* (3d ed. London, 1873). *Reports and Maps of the Geological Surveys of the United Kingdom*. Descriptive memoirs of each coal field published as completed. Percy,

*Metallurgy* (vol. i., on Fuel, 2d ed. London, 1877), containing full details of the chemistry of coal. Greenwell, *Practical Treatise on Mine Engineering* (2d ed. London, 1869). Andra, *Practical Treatise on Coal Mining* (London, 1876). Smyth, *Coal and Coal Mining* (2d ed. London, 1872). Jevons, *The Coal Question* (2d ed. London, 1866). Rogers, *Geology of Pennsylvania* (2 vols. Edinburgh, 1850). *Proceedings of the South Wales Institute of Engineering* (8 vols., Merthyr, 1858-73). *Transactions of the North of England Institute of Mining Engineers* (23 vols., Newcastle, 1852-74). Various Geological Reports of the State and General Governments of the United States; including Newberry's *Ohio Reports*, Cox's *Indiana Reports*, and Hayden's *Reports of Geological Survey of the Territories*.

**FRANCE AND BELGIUM.**—Burat, *Géologie de la France* (8vo, Paris, 1864). *Cours d'Exploitation de Mines* (1871). *Matériel des Houillères en France, &c.* (1861-68). *Bulletin de la Société de l'Industrie Minière, S. Etienne* (20 vols. since 1855). Ponson, *Traité de l'Exploitation des Mines de Houille* (2d ed. Liege, 1868-71). Supplement to the above (1867-72). De Knuyper, *Revue Universelle des Mines, &c.* (Liège, since 1854.).

**GERMANY.**—Geinitz, *Die Steinkohlen Deutschlands, &c.* (3 vols. 4to, Munich, 1866). This is the most complete book on the subject. Zincken, *Die Braunkohle* (2 vols., Hanover, 1865-71). *Zeitschrift für Berg Hütten und Salinwesen, &c.* (4to, Berlin, 22 vols. since 1854). (H. B.)

**COANZA, or QUANZA**, an important river of Western Africa, in the country of Angola. It takes its rise in the Mossamba Mountains, not far from the source of the Cunene, probably in 14° S. lat., and its total length is about 600 miles. It receives a large number of tributaries, the most important of which are the Loando and the Cutato in the upper part of its course, the Gango and the Quige in the middle portion, and the Lucalla in the lower. Its progress is broken by several falls, and in the last 200 miles of its journey it descends no less than 4800 feet. This diminishes its value as a means of transit; but it is navigable for large boats about 140 miles from its mouth, which is situated 50 miles south of Loando, in 9° 15' S. lat. It there forms a number of islands, and pours into the sea a turbid current, which is visible for some distance onwards by its contrast of color.

**COATBRIDGE**, a town of Scotland, in the county of Lanark, and parish of Old Monkland, ten miles east of Glasgow by rail, and about two miles west of Airdrie. It owes its rise to the importance of the surrounding district as a mining field. The town itself is of a straggling description, and is intersected by a branch of the North Calder Water, the Monkland Canal, and the Caledonian Railway. It contains eight places of worship, a literary association, and five branch banks. In the immediate neighborhood are the Gartsherrie iron works, and there are engineering establishments in the town itself. The population of the town in 1871, including Gartsherrie, High Sunnyside, and Langloan, numbered 15,802, of whom 8599 were males and 7203 females.

**COBALT**, a metal of the iron group. The name is derived from the German *Kobold*, a miner's term for gnome, or evil spirit, akin to the English *goblin*, which was applied to a mineral found associated with silver ores, and often replacing them in the mines of Schneeberg in Saxony. The use of the oxide of cobalt in coloring glass was only discovered in 1640 by Scheurer, and till then the metal had been supposed to be worthless. It was first produced, but in an imperfectly purified condition, in 1733, by Brandt.

Cobalt is found alloyed in small quantity together with nickel in many meteoric irons. The principal mode of occurrence, however, is in various complex minerals containing arsenic and sulphur and the allied metal nickel. The following are the most important:—

1. Smalltine or speiss cobalt, an arsenide of the isomorphous bases, cobalt, nickel, and iron, of the formula  $(\text{CoNiFe})\text{As}_2$ , is a mineral of the cubical system, forming steel or lead-grey crystals of a metallic lustre, tarnishing in damp air to a pink or green tint according to the preponderance of cobalt or nickel that is present. In the purest condition it may contain 28.2 per cent. of cobalt to 71.8 per cent. of arsenic, but nickel and iron are almost invariably present to some extent. The principal locality is at Schneeberg in Saxony, where it is associated with silver, bismuth, and nickel ores.

2. Cobalt glance, or cobaltine, is a compound of sulphide and arsenide of cobalt,  $\text{CoS}_2 + \text{CoAs}_2$ , the typical composition being cobalt 35.5, arsenic 45.2, and sulphur 19.3 per cent. It occurs in very brilliant complex crystals belonging to the cubical system, the principal locality being at

Tunaberg in Sweden. A part of the metal is sometimes replaced by iron, but as a rule it is free from nickel.

3. Linnæite, or cobalt pyrites, is analogous in composition to copper pyrites, being represented by the formula  $\text{Co}_2\text{S} + \text{Co}_2\text{S}_2$  with 53 per cent. of cobalt and 42 of sulphur. As a general rule a portion of the base is replaced by copper, nickel, or iron. It is a rare mineral, being found only in the Siegen district in Prussia and in Sweden. Cobalt bloom is a hydrated arseniate produced by the action of air and water upon the above minerals; the composition is  $\text{Co}_2\text{As}_2\text{O}_7 + 8\text{H}_2\text{O}$ , i. e., 37½ per cent. of oxide of cobalt. Earthy cobalt ore is a variety of bog manganese, or wad, a mineral of indefinite composition, but containing at times as much as 8 or 10 per cent. of oxide of cobalt with oxides of manganese, iron, and copper. Cobaltic bismuth ore is a mixture of finely crystalline speiss cobalt with native bismuth, found occasionally in the Schneeberg mines.

The materials from which cobalt is produced by the smelter consist generally of iron or arsenical pyrites, containing a minute quantity of the two metals cobalt and nickel, or various products derived from the smelting of the ores of silver and copper in which these metals are concentrated as sulphur or arsenic compounds.

When in a compact form cobalt is a steel-grey metal with a slightly reddish tint, taking a very high lustre when polished, and breaking with a finely granular fracture. The specific gravity is variously stated at from 8.52 to 8.70. It is slightly malleable, and when quite pure of a higher degree of tenacity than iron, according to Deville. The brittle character attributed to it by former observers is due to impurities, such as arsenic and manganese. It melts at about the same temperature as iron, or a little lower, requiring the strongest heat of a wind furnace. The specific heat is 0.10696 (Regnault). It is susceptible of being magnetized by touch, and retains its magnetism at temperatures below a strong red heat when free from arsenic. Chemically it belongs to the same group as iron, zinc, nickel, manganese, and chromium, which cannot be separated as sulphides by  $\text{H}_2\text{S}$  from an acid solution. It is diatomic; its atomic weight is 58.6, and its symbol Co. Like iron it may be reduced from its oxides by heating with charcoal or in hydrogen gas; in the former case a small quantity of carbon is retained, forming a substance analogous to cast-iron. When reduced by hydrogen at a low temperature it forms a black powder which is pyrophoric, or ignites spontaneously in the air, especially if mixed with finely-divided alumina. At a red heat it decomposes water vapor, producing hydrogen and oxide of cobalt.

There are two principal oxides. The protoxide,  $\text{CoO}$ , is obtained as a black powder by calcining the hydrate  $\text{CoH}_2\text{O}_2$ . The latter is a red substance obtained by precipitation with alkalis from the solution of a cobalt salt. The higher, or sesquioxide,  $\text{Co}_2\text{O}_3$ , is produced in a hydrated form from the hydrated protoxide by the action of chlorine, bromine, chloride of lime, or similar oxidizing agents. It may be rendered anhydrous by careful heating, but at a red heat it decomposes, giving off part of its oxygen, and produces a compound analogous in composition to magnetic oxide of iron,  $\text{Fe}_3\text{O}_4$ .

The protoxide forms numerous salts, which are usually of a fine rose-red color. A weak solution of the nitrate or chloride forms the so-called *sympathetic ink*, which gives a colorless writing when cold, but appears of a bluish-green color when heated, and fades again on cooling. This effect may be reproduced a great number of times if the writing is not too strongly heated, in which case the color becomes permanent from the formation of a basic salt. With ammonia the oxides of cobalt form a series of compound bases, which give rise to salts of great interest and complexity; these may be regarded as ammonium salts, in which part of the hydrogen is replaced by ammonium and another part by cobalt in various conditions of atomicity corresponding to the oxides.

The alloys of cobalt are not of much importance. It combines most readily with arsenic or antimony, forming the highly crystalline compounds known by the general name of *speiss*, which can scarcely be considered as alloys. With gold and silver it forms brittle compounds, with mercury a silver-white magnetic amalgam. With copper and zinc the alloy is white, resembling the corresponding compounds of the same metals with nickel and manganese. With tin it forms a somewhat ductile alloy of a violet

color. The presence of cobalt in the alloy of copper, zinc, and nickel, known as German silver, is objectionable, as it renders it hard and difficult to roll.

The chief use of cobalt in the arts is for the preparation of colors. The protoxide has an intense coloring power when vitrified, and forms the basis of all the blue colors used in glass and porcelain manufacture. The purity of the tint is much affected by traces even of other metallic oxides, especially those of iron, nickel, or copper. Another preparation, known as *smalts*, is a glass formed by melting cobalt oxide with pure quartz sand and carbonate of potassium. Sometimes the first two substances are subjected to a preliminary heating to produce fritted silicate of a reddish or purple color, known as *zaffre*, which when fused with the alkaline carbonate in an ordinary glass furnace produces a deep blue glass. This is rendered friable by running it into water, and is then ground between granite millstones, and finally levigated in water. The various products of the levigation are classified into different qualities according to the fineness of the grain and the strength of the color,—the best being those occupying a medium position, the color diminishing as the fineness of the grain increases. The coarsest variety, known as *strewing blue*, consisting of rough angular fragments up to about ¼ inch diameter, is used for the ground-work of the old-fashioned blue and gold signboards, a very effective and durable kind of surface ornamentation. The highest colored varieties contain from 6 to 7 per cent. of oxide of cobalt. Glass containing only ¼ part of the oxide is of a distinct blue; with more than 18 per cent. it is black.

The principal use of *smalts* is for bluing paper; it was formerly employed almost exclusively for this purpose, but has now been to a very considerable extent superseded by the use of artificial ultramarine, which is cheaper and more easily applied, but is less permanent, as the color is easily discharged by acids, which is not the case when *smalts* is used. The pigment known as cobalt blue, used both in oil and water-color painting, is obtained by mixing the solutions of a cobalt salt and alum, precipitating with an alkaline carbonate, and strongly heating the gelatinous precipitate of the hydrated oxides of the two metals. Thenard's blue, a phosphate of cobalt and alumina, is produced in a similar manner, by precipitation with an alkaline phosphate. Cobalt green, or Rinman's green, is a mixture of the oxides of zinc and cobalt produced from the solutions of their sulphates by precipitation with carbonate of sodium and ignition.

In analysis cobalt is always determined as protoxide, but the separation from the metals with which it is usually associated, especially nickel, is a difficult and tedious operation. Many different processes have been devised, but the most accurate are those of H. Rose and Liebig. The former depends upon the power possessed by chlorine (or bromine) of converting protoxide of cobalt when in solution into sesquioxide, while the corresponding oxide of nickel is not changed. The solution when completely saturated with chlorine is precipitated by carbonate of barium, which carries down the whole of the cobalt as sesquioxide; the precipitate is redissolved in hydrochloric acid, the whole of the barium salt separated by sulphuric acid, and the cobalt finally precipitated by means of hydrate of potassium. In Liebig's method the oxides of the two metals are heated with cyanide of potassium and boiled, which produces cobaltcyanide of potassium,  $\text{K}_2\text{Co}_2\text{Cy}_6$ , and cyanide of nickel and potassium,  $\text{KNiCy}_2$ . By the addition of finely-divided red oxide of mercury the whole of the nickel is precipitated, partly as cyanide and partly as hydrate, while the cobalt compound remains in solution, and is afterwards separated by means of sulphate of copper as cobaltcyanide of copper, which is redissolved; the copper is separated by sulphuretted hydrogen, and the cobalt then obtained as oxide by boiling with caustic potash. The complexity of the composition of the ores, and the high value of the two metals, has led to the application of more refined methods of chemical analysis in their investigation than are required in the assay of the ores of the commoner metals. Plattner's method of dry assay of cobalt and nickel ores is much more rapidly performed than an analysis, and in practised hands is susceptible of considerable accuracy. It depends upon the fact that when a speiss or arsenical compound, containing the four metals—iron, cobalt, nickel, and copper—is melted with a vitreous flux such as borax in an oxidizing atmosphere, the metals will

be oxidized and pass into a slag with the borax in the order indicated above, no cobalt being taken up until the iron has been entirely removed, and similarly the nickel remaining until the cobalt has been completely oxidized. The steps in the process may be easily recognized owing to the difference in the characteristic color of the oxides, the dark green or black of the iron slag being rendered distinctly blue by the faintest trace of cobalt, and the blue of the latter being similarly affected by nickel, which has a strong brown coloring power. The arsenides of cobalt and nickel, being of a constant composition, are weighed at each step of the process in the proportion of the metal removed calculated from the difference. Cobalt may be readily detected by the blow-pipe even when in very small quantity, or by the characteristic blue imparted to a bead of borax or salt of phosphorus.

On the large scale cobalt is produced chiefly as an accessory in the treatment of nickel ores. These consist chiefly of mixtures of small quantities of the purer minerals with pyrites, sulphuretted copper ores, or lead and silver ores, which require to be subjected to concentrating processes in order to get rid of the bulk of the iron, sulphur, and arsenic, and produce a small amount of enriched regulus or metal, in which the more valuable metals are in combination with sulphur and arsenic. This is done by calcination, which drives off the sulphur and arsenic combined with the iron, the latter being oxidized and subsequently converted into slag by fusion with fluxes containing silica. Small quantities of cobalt, nickel, and copper ores, when associated with lead and silver ores, are in like manner gradually accumulated in a regulus by passing the regulus of the first fusion several times through the smelting furnace, whereby the lead and silver are in great part removed. The treatment of these purified and enriched products is conducted on the large scale in a somewhat similar manner to a chemical analysis, in order to obtain both cobalt and nickel. The speiss, or regulus, is calcined and treated with strong hydrochloric acid to dissolve the oxides formed. By the addition of caustic lime, iron and arsenic are precipitated, and the clear liquid is treated with sulphuretted hydrogen so long as metallic sulphides are produced, the precipitate being allowed to settle. The solution then containing only cobalt and nickel compounds, the former is separated by the addition of bleaching powder and caustic lime as sesquioxide,  $\text{Co}_2\text{O}_3$ , and the latter as hydrated oxide by a subsequent precipitation with lime.

In making smalts the purer arsenical ores are used. They are first calcined in a reverberatory or muffle furnace provided with chambers for condensing the arsenical fumes as completely as possible. The roasted ore, if it does not contain quartz, is mixed with a proportion of fine glass-house sand and carbonate of potassium, but when it is sufficiently siliceous, as in the mixtures of cobalt ore and silica known as zaffre, only the alkaline carbonate is required. The fusion takes place in pots like those used in plate-glass making, and requires about eight hours. The blue glass is led out into water till the pot is nearly empty, when a speiss containing the whole of the nickel of the ore is found at the bottom. The blue glass is then ground and levigated as already described.

The chief localities producing cobalt ores are Modum in Norway, Tunaberg in Sweden, Schneeberg in Saxony, Munsen in Rhenish Prussia, and Mine Lamotte in Missouri; a considerable amount has also been obtained from Bolivia. In the Transvaal in South Africa a very pure variety of speiss cobalt free from nickel has been recently discovered. Smaller quantities of speiss or regulus are obtained from the smelting of silver and lead ores, at Freiburg, in the Harz, in Bohemia, and elsewhere. (H. B.)

COBAN, or SANTO DOMINGO COBAN, a city of Central America, in the republic of Guatemala, and the department of Vera Paz, situated about 90 miles north of the city of Guatemala, on the direct route to Flores, not far from the source of the Rio de Cajabon, which flows into the Golfo Dulce. It occupies the slopes of a rounded hill, on the top of which is the central square or plaza, with the cathedral and the ruins of the once magnificent Dominican monastery on the one side, and on the others the shops and houses of the merchants and artisans. The houses of Cobán are low and covered with tiles; and, as each with its garden and croft attached is curtailed by a dense and lofty hedge, the streets have rather the appearance of

woodland avenues. The cathedral is a large and imposing edifice, decorated in the interior with a barbaric profusion of ornament; but like the rest of the public buildings of the town it shows signs of decay. Since the removal of the seat of the Provincial Government to Salama, the prosperity of Cobán has greatly declined, but it still contains about 12,000 inhabitants, who carry on the weaving of cotton cloth, the cultivation of coffee, sugar, and pimento, and a considerable trade with the neighboring provinces. The Spanish and Ladino part of the population does not exceed 2000; and the rest are Indians originally from the mountains of Chichen and Jucamel, who still speak the Kaochi or Quecchi language. Cobán owes its origin to the missionary labors of the Dominicans of the 16th century, and more especially to Fray Pedro de Angulo, whose portrait is preserved in the cathedral. It was made the political capital of the province of Vera Paz, and obtained the arms of a city of the first rank.

COBBETT, WILLIAM (1766-1835), one of the most vigorous of English political writers, was born near Farnham in Surrey, according to his own statement, on the 9th March, 1766. He was the grandson of a farm-laborer, and the son of a small farmer; and during his early life he worked on his father's farm. At the age of sixteen, inspired with patriotic feeling by the sight of the men-of-war in Portsmouth harbor, he offered himself as a sailor; and at seventeen (May, 1783) having, while on his way to Guildford fair, met the London coach, he suddenly resolved to accompany it to its destination. He arrived at Ludgate Hill with exactly half-a-crown in his pocket, but an old gentleman who had travelled with him invited him to his house, and obtained for him the situation of copying clerk in an attorney's office. He greatly disliked his new occupation; and rejecting all his father's entreaties that he would return home, he went down to Chatham early in 1784 with the intention of joining the marines. By some mistake, however, he was enlisted in a regiment of the line, which rather more than a year after proceeded to St. John's, New Brunswick. All his leisure time during the months he remained at Chatham was devoted to reading the contents of the circulating library of the town, and getting up by heart Lowth's *English Grammar*. His uniform good conduct, and the power of writing correctly which he had acquired, quickly raised him to the rank of corporal, from which, without passing through the intermediate grade of sergeant, he was promoted to that of sergeant-major. In November, 1791, he was discharged at his own request, and received the official thanks of the major and the general who signed his discharge. But Cobbett's connection with the regiment did not end in this agreeable manner. He brought a serious charge against some of its officers, and instead of appearing at the trial fled to France (March, 1792). The inquiry which was held in his absence resulted in a complete acquittal of the accused.

In the previous February Cobbett had married the daughter of a sergeant-major of artillery; he had met her some years before in New Brunswick, and had proved her to be endowed with energy and self-control equal to his own. In September of the same year (1792) he crossed to the United States, and for a time supported himself at Wilmington by teaching English to French emigrants. Among these was Talleyrand, who employed him, according to Cobbett's story, not because he was ignorant of English, but because he wished to purchase his pen. Cobbett made his first literary sensation by his *Observations on the Emigration of a Martyr to the Cause of Liberty*, a clever retort on Dr. Priestley, who had just landed in America complaining of the treatment he had received in England. This pamphlet was followed by a number of papers, signed "Peter Porcupine," and entitled *Prospect from the Congress Gallery*, the *Political Censor*, and *Peter Porcupine's Gazette*. In the spring of 1796, having quarrelled with his publisher, he set up in Philadelphia as bookseller and publisher of his own works. On the day of opening, his windows were filled with prints of the most extravagant of the French Revolutionists and of the founders of the American Republic placed side by side, along with portraits of George III., the British ministers, and any one else he could find likely to be obnoxious to the people; and he continued to pour forth praises of Great Britain and scorn of the institutions of the United States, with special abuse of the French party. Abuse and threats were of course in turn showered

upon him, and in August, for one of his attacks on Spain, he was prosecuted, though unsuccessfully, by the Spanish ambassador. Immediately on this he was taken up for libels upon American statesmen, and bound in recognizances to the amount of \$4000, and shortly after he was prosecuted a third time for saying that a certain Dr. Rush, who was much addicted to bleeding, killed nearly all the patients he attended. The trial was repeatedly deferred, and was not settled till the end of 1799, when he was fined \$5000. After this last misfortune, for a few months Cobbett carried on a newspaper called the *Rushlight*; but in June, 1800, he set sail for England.

At home he found himself regarded as the champion of order and monarchy. Windham invited him to dinner, introduced him to Pitt, and begged him to accept a share in the *True Briton*. He refused the offer and joined an old friend, John Morgan, in opening a book shop in Pall Mall. For some time he published the *Porcupine Gazette*, which was followed in January, 1802, by the *Weekly Political Register*. In 1801 appeared his Letters to Lord Hawkesbury (afterwards earl of Liverpool) and Mr. Addington, in opposition to the peace of Amiens, the terms of which had been agreed to by the former on behalf of Great Britain in the October of that year, but which was not finally concluded till 1802. On the conclusion of the peace Cobbett made a still bolder protest; he determined to take no part in the general illumination, and—assisted by the sympathy of his wife, who, being in delicate health, removed to the house of a friend—he carried out his resolve, allowing his windows to be smashed and his door broken open by the angry mob. The Letters to the *Rt. Hon. Henry Addington* are among the most polished and dignified of Cobbett's writings; but by 1803 he was once more revelling in personalities. The government of Ireland was singled out for wholesale attack; and a letter published in the *Register* remarked of Hardwicke, the lord-lieutenant, that the appointment was like setting the surgeon's apprentice to bleed the pauper patients. For this, though not a word had been uttered against Hardwicke's character, Cobbett was fined £500; and two days after the conclusion of this trial a second commenced, at the suit of Plunkett, the solicitor-general for Ireland, which resulted in a similar fine. About this time he began to write in support of Radical views, and to cultivate the friendship of Sir Francis Burdett, from whom he received considerable sums of money, and other favors, for which he gave no very grateful return. In 1809 he was once more in the most serious trouble. He had bitterly commented on the flogging of some militia, because their mutiny had been repressed and their sentence carried out by the aid of a body of German troops, and in consequence he was fined £1000 and imprisoned for two years. His indomitable vigor was never better displayed. He still continued to publish the *Register*, and to superintend the affairs of his farm; a hamper containing specimens of its produce and other provisions came to him every week; and he amused himself with the company of some of his children and with weekly letters from the rest. On his release a public dinner, presided over by Sir F. Burdett, was held in honor of the event. He returned to his farm at Botley in Hampshire, and continued in his old course, extending his influence by the publication of the *Twopenny Trash*, which, not being periodical, escaped the newspaper stamp tax. Meanwhile, however, he had contracted debts to the amount of £34,000 (for it is said that, notwithstanding the aversion he publicly expressed to paper currency, he had carried on his business by the aid of accommodation bills to a very large amount); and in March, 1817, he fled to the United States. But his pen was as active as ever; from Long Island the *Register* was regularly despatched to England; and it was here that he wrote his clear and interesting *English Grammar*, of which 10,000 copies were sold in a month.

His return to England was accompanied by his weakest exhibition—the exhuming and bringing over of the bones of Tom Paine, whom he had once heartily abused, but on whom he now wrote a panegyric ode. Nobody paid any attention to the affair; the relics he offered were not purchased; and the bones were reinterred.

Cobbett's great aim was now to obtain a seat in the House of Commons. He calmly suggested that his friends should assist him by raising the sum of £5000; it would be much better, he said, than a meeting of 50,000 persons.

He first offered himself for Coventry, but failed; in 1826 he was by a large number of votes last of the candidates for Preston; and in 1828 he could find no one to propose him for the office of common councillor. In 1830, that year of revolutions, he was prosecuted for inciting to rebellion, but the jury disagreed, and soon after, through the influence of one of his admirers, Mr. Fielden, who was himself a candidate for Oldham, he was returned for that town. In the House his speeches were listened to with amused attention. His position is sufficiently marked by the sneer of Peel that he would attend to Mr. Cobbett's observations exactly as if they had been those of a "respectable member;" and the only striking part of his career was his absurd motion that the king should be prayed to remove Sir Robert Peel's name from the list of the privy council, because of the change he had proposed in the currency in 1819. In 1834 Cobbett was again member for Oldham, but his health now began to give way and in June, 1835, he left London for his farm, where he died on the 16th of that month.

Cobbett's account of his home-life makes him appear singularly happy; his love and admiration of his wife never failed; and his education of his children seems to have been distinguished by great-kindliness, and by a good deal of healthy wisdom, mingled with the prejudices due to the peculiarities of his temper and circumstances. Cobbett's ruling characteristic was a sturdy egotism which had in it something of the nobler element of self-respect. A firm will, a strong brain, feelings not over-sensitive, an intense love of fighting, a resolve to get on, in the sense of making himself a power in the world—these are the principal qualities which account for the success of his career. His opinions were the fruits of his emotions. It was enough for him to get a thorough grasp of one side of a question; about the other side he did not trouble himself, but he always firmly seizes the facts which make for his view, and expresses them with unflinching clearness. His argument, which is never subtle, has always the appearance of weight, however flimsy it may be in fact. His sarcasm is seldom polished or delicate, but usually rough, and often abusive, while coarse nicknames were his special delight. His style is always extremely forcible and marked by unusual grammatical correctness.

Cobbett's contributions to periodical literature occupy 100 volumes, twelve of which consist of the papers published at Philadelphia between 1794 and 1800, and the rest of the *Weekly Political Register*, which ended only with Cobbett's life (June, 1835). An abridgment of these works, with notes, has been published by his sons, John M. Cobbett and James P. Cobbett. Besides this he published—*An Account of the Horrors of the French Revolution*, and a work tracing all these horrors to "the licentious politics and infidel philosophy of the present age" (both 1798); *A Year's Residence in the United States*; *Parliamentary History of England from the Norman Conquest to 1800* (1806); *Cottage Economy*; *Roman History*; *French Grammar*, and *English Grammar*, both in the form of letters; *Geographical Dictionary of England and Wales*; *History of the Regency and Reign of George IV.*, containing a defence of Queen Caroline, whose cause he warmly advocated (1830-4); *Life of Andrew Jackson, President of the United States* (1834); *Legacy to Laborers*; *Legacy to Peel*; *Legacy to Parsons*, an attack on the secular claims of the Established Church; *Doom of Tories*; *Rural Rides*; *Advice to Young Men and Women*; *Cobbett's Corn*; and *History of the Protestant Reformation in England and Ireland*, in which he defends the monasteries, Queen Mary, and Bonner, and attacks the Reformation, Henry VIII., Elizabeth, and all who helped to bring it about, with such vehemence that the work was translated into French and Italian, and extensively circulated among Roman Catholics.

In 1798 Cobbett published in America an account of his early life, under the title of *The Life and Adventures of Peter Porcupine*; and he left papers relating to his subsequent career. These materials were embodied in an anonymous *Life of Cobbett* which appeared soon after his death. See also Sir Henry Bulwer's *Historical Characters*; *Biographies of John Wilkes and William Cobbett* by Rev. John Watson; and the abridged and annotated edition of the *Register*.

COBDEN, RICHARD (1804-1865), was born at a farmhouse called Dunford, near Midhurst, in Sussex, on the 2d of June, 1804. The family had been resident in that neighborhood for many generations, occupied partly in trade and partly in agriculture. Formerly there had been in the town of Midhurst a small manufactory of hosiery with which the Cobdens were connected, though all trace of it had disappeared before the birth of Richard. His



grandfather was a maltster in that town, an energetic and prosperous man, almost always the bailiff or chief magistrate, and taking rather a notable part in county matters. But his father, forsaking that trade, took to farming at an unpropitious time. He was amiable and kind-hearted, and greatly liked by his neighbors, but not a man of business habits, and he did not succeed in his farming enterprise. He died when his son Richard was a child, and the care of the family devolved upon the mother, who was a woman of strong sense and of great energy of character, and who, after her husband's death, left Dunford and returned to Midhurst.

The educational advantages of Richard Cobden were not very ample. There was a grammar school at Midhurst, which at one time had enjoyed considerable reputation, but which had fallen into decay. It was there that he had to pick up such rudiments of knowledge as formed his first equipment in life, but from his earliest years he was indefatigable in the work of self-cultivation. When fifteen or sixteen years of age he went to London to the warehouse of Messrs. Partridge and Price, in East Cheap, one of the partners being his uncle. His relative noting the lad's passionate addiction to study, solemnly warned him against indulging such a taste, as likely to prove a fatal obstacle to his success in commercial life. Happily the admonition was unheeded, for while unweariedly diligent in business, as his rapid after success abundantly proved, he was in his intervals of leisure a most assiduous student. During his residence in London he found access to the London Institution, and made ample use of its large and well-selected library.

When he was about twenty years of age he became a commercial traveller, and throwing into that, as he ever did into whatever his hand found to do, all the thoroughness and vigor of his nature, he soon became eminently successful in his calling. But never content to sink into the mere trader, he sought to introduce among those he met on the "road" a higher tone of conversation than usually marks the commercial room, and there were many of his associates who, when he had attained eminence, recalled the discussions on political economy and kindred topics with which he was wont to enliven and elevate the travellers' table. In 1830 Cobden learnt that Messrs. Fort, calico printers at Sabden, near Clitheroe, were about to retire from business, and he, with two other young men, Messrs. Sheriff and Gillet, who were engaged in the same commercial house as himself, determined to make an effort to acquire the succession. They had, however, very little capital among them. But it may be taken as an illustration of the instinctive confidence which Cobden through life inspired in those with whom he came into contact, that Messrs. Fort consented to leave to these untried young men a large portion of their capital in the business. Nor was their confidence misplaced. The new firm had soon three establishments,—one at Sabden, where the printing works were, one in London, and one in Manchester for the sale of their goods. This last was under the direct management of Cobden, who, in 1830 or 1831, settled in the city with which his name became afterwards so closely associated. The success of this enterprise was decisive and rapid, and the "Cobden prints" soon became known through the country as of rare value both for excellence of material and beauty of design. There can be no doubt that if Cobden had been satisfied to devote all his energies to commercial life he might soon have attained to great opulence, for it is understood that his share in the profits of the business he had established amounted to from £8000 to £10,000 a year. But he had other tastes, which impelled him irresistibly to pursue those studies which, as Lord Bacon says, "serve for delight, for ornament, and for ability." Mr. Prentice, the historian of the Anti-Corn-Law League, who was then editor of the *Manchester Times*, describes how, in the year 1835, he received for publication in his paper a series of admirably written letters, under the signature of "Libra," discussing commercial and economical questions with rare ability. After some time he discovered that the author of these letters was Cobden, whose name was until then quite unknown to him.

In 1835 he published his first pamphlet, entitled *England, Ireland, and America, by a Manchester Manufacturer*. It attracted great attention, and ran rapidly through several editions. It was marked by a breadth and boldness

<sup>1</sup> [A Parliamentary reformer (1811-89), of great eloquence, was in the House of Commons for Durham, Manchester, and Birmingham successively for forty-six years, was president of Board of Trade, chancellor of Lancaster, a friend of American Union, opposed Crimean War and Gladstone's Irish Home Rule.—AM. Ed.]

of views on political and social questions which betokened an original mind. In this production Cobden advocated the same principles of peace, non-intervention, retrenchment, and free trade to which he continued faithful to the last day of his life. Immediately after the publication of this pamphlet, he paid a visit to the United States, landing in New York on the 7th June, 1835. He devoted about three months to this tour, passing rapidly through the seaboard States and the adjacent portion of Canada, and collecting as he went large stores of information respecting the condition, resources, and prospects of the great Western Republic. Soon after his return to England he began to prepare another work for the press, which appeared towards the end of 1836, under the title of *Russia*. It was mainly designed to combat a wild outbreak of Russophobia which, under the inspiration of Mr. Daniel Urquhart, was at that time taking possession of the public mind. But it contained also a bold indictment of the whole system of foreign policy then in vogue, founded on ideas as to the balance of power and the necessity of large armaments for the protection of commerce. While this pamphlet was in the press, delicate health obliged him to leave England, and for several months, at the end of 1836 and the beginning of 1837, he travelled in Spain, Turkey, and Egypt. During his visit to Egypt he had an interview with the redoubtable ruler of that country, Mehemet Ali, of whose character as a reforming monarch he did not bring away a very favorable impression. He returned to England in April, 1837. From that time Cobden became a conspicuous figure in Manchester, taking a leading part in the local politics of the town and district. Largely owing to his exertions, the Manchester Athenæum was established, at the opening of which he was chosen to deliver the inaugural address. He became a member of the Chamber of Commerce, and soon infused new life into that body. He threw himself with great energy into the agitation which led to the incorporation of the city, and was elected one of its first aldermen. He began also to take a warm interest in the cause of popular education. Some of his first attempts in public speaking were at meetings which he convened at Manchester, Salford, Bolton, Rochdale, and other adjacent towns, to advocate the establishment of British schools. It was while on a mission for this purpose to Rochdale that he first formed the acquaintance of Mr. John Bright, who afterwards became his distinguished coadjutor in the free trade agitation. Nor was it long before his fitness for parliamentary life was recognized by his friends. In 1837, the death of William IV. and the accession of Queen Victoria led to a general election. Cobden was candidate for Stockport, but was defeated, though not by a large majority.

In 1838 an Anti-Corn-Law Association was formed at Manchester, which, on his suggestion, was afterwards changed into a national association, under the title of the Anti-Corn-Law League. This is not the place to recount the history of that famous association, of which from first to last Cobden was the presiding genius and the animating soul. During the seven years between the formation of the league and its final triumph, he devoted himself wholly to the work of teaching his countrymen sound economical doctrines, for the agitation which he and his associates conducted with such signal ability and success was pre-eminently an educational agitation. His labors were as various as they were incessant,—now guiding the councils of the League, now addressing crowded and enthusiastic meetings of his supporters in London or the large towns of England and Scotland, now invading the agricultural districts, and challenging the landlords to meet him in the presence of their own farmers, to discuss the question in dispute, and now encountering the Chartists led on by Feargus O'Connor, who had deluded a portion of the working classes into fanatical opposition to free trade. But whatever was the character of his audience he never failed, by the clearness of his statements, the force of his reasoning, and the felicity of his illustrations, to carry conviction to the minds of his hearers.

In 1841, Sir Robert Peel having defeated the Melbourne ministry in Parliament, there was a general election, when Cobden was returned for Stockport. His opponents had confidently predicted that he would fail utterly in the House of Commons. He did not wait long, after his admission into that assembly, in bringing their predictions to the test. Parliament met on the 19th August. On the

24th, in course of the debate on the Address, Cobden delivered his first speech. "It was remarked," says Miss Martineau, in her *History of the Peace*, "that he was not treated in the House with the courtesy usually accorded to a new member, and it was perceived that he did not need such observance." With perfect self-possession, which was not disturbed by the jeers that greeted some of his statements, and with the utmost simplicity, directness, and force, he presented the argument against the corn-laws in such a form as startled his audience, and also irritated some of them, for it was a style of eloquence very unlike the conventional style which prevailed in Parliament.

From that day he became an acknowledged power in the House, and though addressing a most unfriendly audience, he compelled attention by his thorough mastery of his subject, and by the courageous boldness with which he charged the ranks of his adversaries. He soon came to be recognized as one of the foremost debaters on those economical and commercial questions which at that time so much occupied the attention of Parliament; and the most prejudiced and bitter of his opponents were fain to acknowledge that they had to deal with a man whom the most practised and powerful orators of their party found it hard to cope with, and to whose eloquence, indeed, the great statesman in whom they put their trust was obliged ultimately to surrender. On the 17th of February, 1848, an extraordinary scene took place in the House of Commons. Cobden had spoken with great fervor of the deplorable suffering and distress which at that time prevailed in the country, for which, he added, he held Sir Robert Peel, as the head of the Government, responsible. This remark, when it was spoken, passed unnoticed, being indeed nothing more than one of the commonplaces of party warfare. But a few weeks before, Mr. Drummond, who was Sir Robert Peel's private secretary, had been shot dead in the street by a lunatic. In consequence of this, and the manifold anxieties of the time with which he was harassed, the mind of the great statesman was no doubt in a moody and morbid condition, and when he arose to speak later in the evening, he referred in excited and agitated tones to the remark, as an incitement to violence against his person. Sir Robert Peel's party, catching at this hint, threw themselves into a frantic state of excitement, and when Cobden attempted to explain that he meant official, not personal responsibility, they drowned his voice with clamorous and insulting shouts. But Peel lived to make ample and honorable amend for this unfortunate ebullition, for not only did he "fully and unequivocally withdraw the imputation which was thrown out in the heat of debate under an erroneous impression," but when the great free trade battle had been won, he took the wreath of victory from his own brow, and placed it on that of his old opponent, in the following graceful words:—"The name which ought to be, and will be associated with the success of these measures, is not mine, or that of the noble Lord (Russell), but the name of one who, acting I believe from pure and disinterested motives, has, with untiring energy, made appeals to our reason, and has enforced those appeals with an eloquence the more to be admired because it was unaffected and unadorned; the name which ought to be chiefly associated with the success of these measures is the name of Richard Cobden." Cobden had, indeed, with unexampled devotion, sacrificed his business, his domestic comforts, and for a time his health to the public interests. His friends therefore felt, at the close of that long campaign, that the nation owed him some substantial token of gratitude and admiration for those sacrifices. No sooner was the idea of such a tribute started than liberal contributions came from all quarters, which enabled his friends to present him with a sum of £30,000. Had he been inspired with personal ambition, he might have entered upon the race of political advancement with the prospect of attaining the highest official prizes. Lord John Russell, who, soon after the repeal of the corn laws, succeeded Sir Robert Peel as first minister, invited Cobden to join his Government. But he preferred keeping himself at liberty to serve his countrymen unshackled by official ties, and declined the invitation. He withdrew for a time from England. His first intention was to seek complete seclusion in Egypt or Italy, to recover health and strength after his long and exhausting labors. But his fame had gone forth throughout

Europe, and intimations reached him from many quarters that his voice would be listened to everywhere with favor, in advocacy of the doctrines to the triumph of which he had so much contributed at home. Writing to a friend in July, 1846, he says,—“I am going to tell you of a fresh project that has been brewing in my brain. I have given up all idea of burying myself in Egypt or Italy. I am going on an agitating tour through the continent of Europe.” Then, referring to messages he had received from influential persons in France, Prussia, Austria, Russia, and Spain to the effect mentioned above, he adds:—"Well, I will, with God's assistance, during the next twelve months, visit all the large states of Europe, see their potentates or statesmen, and endeavor to enforce those truths which have been irresistible at home. Why should I rust in inactivity? If the public spirit of my countrymen affords me the means of travelling as their missionary, I will be the first ambassador from the people of this country to the nations of the Continent. I am impelled to this by an instinctive emotion such as has never deceived me. I feel that I could succeed in making out a stronger case for the prohibitive nations of Europe to compel them to adopt a freer system than I had here to overturn our protection policy." This programme he fulfilled. He visited in succession France, Spain, Italy, Germany, and Russia. He was received everywhere with marks of distinction and honor. In many of the principal capitals he was invited to public banquets, which afforded him an opportunity of propagating those principles of which he was regarded as the apostle. But besides these public demonstrations he sought and found access in private to many of the leading statesmen, in the various countries he visited, with a view to indoctrinate them with the same principles. During his absence there was a general election, and he was returned for Stockport and for the West Riding of Yorkshire. He chose to sit for the latter.

When Cobden returned from the Continent he addressed himself to what seemed to him the logical complement of free trade, namely, the promotion of peace and the reduction of naval and military armaments. His abhorrence of war amounted to a passion. Throughout his long labors in behalf of unrestricted commerce he never lost sight of this, as being the most precious result of the work in which he was engaged,—its tendency to diminish the hazards of war and to bring the nations of the world into closer and more lasting relations of peace and friendship with each other. He was not deterred by the fear of ridicule or the reproach of Utopianism from associating himself openly, and with all the ardor of his nature, with the peace party in England. In 1849 he brought forward a proposal in Parliament in favor of international arbitration, and in 1851 a motion for mutual reduction of armaments. He was not successful in either case, nor did he expect to be. In pursuance of the same object, he identified himself with a series of remarkable peace congresses—international assemblies designed to unite the intelligence and philanthropy of the nations of Christendom in a league against war—which from 1848 to 1851 were held successively in Brussels, Paris, Frankfort, London, Manchester, and Edinburgh.

On the establishment of the French empire in 1851-2 a violent panic took possession of the public mind. Without the shadow of producible evidence the leaders of opinion in the press promulgated the wildest alarms as to the intentions of Louis Napoleon, who was represented as contemplating a sudden and piratical descent upon the English coast without pretext or provocation. Shocked by this pitiful display of national folly, Cobden did not hesitate to throw himself into the breach and withstand the madness of the hour. By a series of powerful speeches in and out of Parliament, and by the publication of his masterly pamphlet, *1793 and 1853*, he sought to calm the passions of his countrymen. By this course he sacrificed the great popularity he had won as the champion of free trade, and became for a time the best abused man in England. Immediately afterwards, owing to the quarrel about the Holy Places which arose in the east of Europe, public opinion suddenly veered round, and all the suspicion and hatred which had been directed against the emperor of the French were diverted from him to the emperor of Russia. Louis Napoleon was taken into favor as our faithful ally, and in a whirlwind of popular excitement the nation was swept

into the Crimean war. Cobden, who had travelled in Turkey, and had studied the condition of that country with great care for many years, utterly discredited the outcry about maintaining the independence and integrity of the Ottoman empire which was the battle-cry of the day. He denied that it was possible to maintain them, and no less strenuously denied that it was desirable even if it were possible. He believed that the jealousy of Russian aggrandizement and the dread of Russian power to which our countrymen delivered themselves at that time were absurd exaggerations. He maintained that the future of European Turkey was in the hands of the Christian population, and that it would have been our wisdom to ally ourselves with them rather than with the doomed and decaying Mahometan power. "You must address yourselves," he said in the House of Commons, "as men of sense and men of energy, to the question—what are you to do with the Christian population? for Mahometanism cannot be maintained, and I should be sorry to see this country fighting for the maintenance of Mahometanism. . . . You may keep Turkey on the map of Europe, you may call the country by the name of Turkey if you like, but do not think you can keep up the Mahometan rule in the country." The reader may be left to judge how far his sagacity and statesmanship have been vindicated by the event. But for the time the torrent of popular sentiment in favor of war was irresistible; and Messrs. Cobden and Bright, who with admirable courage and eloquence withstood what they deemed the delusion of the hour, were overwhelmed with obloquy.

At the beginning of 1857 tidings from China reached England of a rupture between the British plenipotentiary in that country and the governor of the Canton provinces in reference to a small vessel or lorch called the "Arrow," which had resulted in the English admiral destroying the river forts, burning 23 ships belonging to the Chinese navy, and bombarding the city of Canton. After a careful investigation of the official documents, Cobden became convinced that these were utterly unrighteous proceedings. He brought forward a motion in Parliament to this effect, which led to a long and memorable debate, lasting over four nights, in which he was supported by Mr. Sydney Herbert, Sir James Graham, Mr. Gladstone, Lord John Russell, and Mr. Disraeli, and which ended in the defeat of Lord Palmerston by a majority of sixteen. But this triumph cost him his seat in Parliament. On the dissolution which followed Lord Palmerston's defeat, Cobden became candidate for Huddersfield, but the voters of that town gave the preference to his opponent, who had supported the Russian war and approved of the proceedings at Canton. Cobden was thus relegated to private life, and retiring to his country house at Dunford, he spent his time in perfect contentment in cultivating his land and feeding his pigs.

He took advantage of this season of leisure to pay another visit to the United States. During his absence the general election of 1859 occurred, when he was returned unopposed for Rochdale. Lord Palmerston was again prime minister, and having discovered that the advanced liberal party was not so easily "crushed" as he had apprehended, he made overtures of reconciliation, and invited Cobden and Milner Gibson to become members of his government. In a frank, cordial letter which was delivered to Cobden on his landing in Liverpool, Lord Palmerston offered him the Presidency of the Board of Trade, with a seat in the Cabinet. Many of his friends urgently pressed him to accept; but without a moment's hesitation he determined to decline the proposed honor. On his arrival in London he called on Lord Palmerston, and with the utmost frankness told him that he had opposed and denounced him so frequently in public, and that he still differed so widely from his views, especially on questions of foreign policy, that he could not, without doing violence to his own sense of duty and consistency, serve under him as minister. Lord Palmerston tried good-humoredly to combat his objections, but without success.

But though he declined to share the responsibility of Lord Palmerston's administration, he was willing to act as its representative in promoting freer commercial intercourse between England and France. But the negotiations for this purpose originated with himself in conjunction with Mr. Bright and M. Michel Chevalier. Toward the close of 1859 he called upon Lord Palmerston, Lord John

Russell, and Mr. Gladstone, and signified his intention to visit France and get into communication with the emperor and his ministers, with a view to promote this object. These statesmen expressed in general terms their approval of his purpose, but he went entirely on his own account, clothed at first with no official authority. His name, however, carried an authority of its own. On his arrival in Paris he had a long audience with Napoleon, in which he urged many arguments in favor of removing those obstacles which prevented the two countries from being brought into closer dependence on one another, and he succeeded in making a considerable impression on his mind in favor of free trade. He then addressed himself to the French ministers, and had much earnest conversation, especially with M. Foulde, *Ministre d'État*, and M. Rouher, minister of commerce, both of whom, and especially the latter, he found well inclined to the economical and commercial principles which he advocated. After a good deal of time spent in these preliminary and unofficial negotiations, the question of a treaty of commerce between the two countries having entered into the arena of diplomacy, Cobden was requested by the British Government to act as their plenipotentiary in the matter in conjunction with Lord Cowley, their ambassador in France. But it proved a very long and laborious undertaking. He had to contend with the bitter hostility of the French protectionists, which occasioned a good deal of vacillation on the part of the emperor and his ministers. There were also delays, hesitations, and cavils at home, which were more inexplicable. He was, moreover, assailed with great violence by a powerful section of the English press, while the large number of minute details with which he had to deal in connection with proposed changes in the French tariff, involved a tax on his patience and industry which would have daunted a less resolute man. But there was one source of embarrassment greater than all the rest. One strong motive which had impelled him to engage in this enterprise was his anxious desire to establish more friendly relations between England and France, and to dispel those feelings of mutual jealousy and alarm which were so frequently breaking forth and jeopardizing peace between the two countries. This was the most powerful argument with which he had plied the emperor and the members of the French Government, and which he had found most efficacious with them. But unhappily, while he was in the very thick of the negotiations, Lord Palmerston brought forward in the House of Commons a measure for fortifying the naval arsenals of England, which he introduced in a warlike speech pointedly directed against France, as the source of danger of invasion and attack, against which it was necessary to guard. This produced irritation and resentment in Paris, and but for the influence which Cobden had acquired, and the perfect trust reposed in his sincerity, the negotiations would probably have been altogether wrecked. At last, however, after nearly twelve months' incessant labor, the work was completed in November, 1860. "Rare," said Mr. Gladstone, "is the privilege of any man who, having fourteen years ago rendered to his country one signal service, now again, within the same brief span of life, decorated neither by land nor title, bearing no mark to distinguish him from the people he loves, has been permitted to perform another great and memorable service to his sovereign and his country."

On the conclusion of this work honors were offered to Cobden by the Government of both the countries which he had so greatly benefited. Lord Palmerston offered him a baronetcy and a seat in the Privy Council, and the emperor of the French would gladly have conferred upon him some distinguished mark of his favor; but with characteristic disinterestedness and modesty he declined all such honors.

It has already been remarked that Cobden's efforts in furtherance of free trade were always subordinated to the highest moral purposes—the promotion of peace on earth and good-will among men. This was his desire and hope as respects the Commercial Treaty with France. He was therefore deeply disappointed and distressed to find the old feeling of distrust towards our neighbors still actively fomented by the press and some of the leading politicians of the country. He therefore, in 1862, published his pamphlet entitled *The Three Panics*, the object of which was to trace the history and expose the folly of those

periodical visitations of alarm as respects the designs of our neighbors with which this country had been afflicted for the preceding fifteen or sixteen years.

There was one other conspicuous service which Cobden rendered, or tried to render, to his country before his death. When the great civil war threatened to break out in the United States, it was matter to him of profound affliction. But after the conflict became inevitable his sympathies were wholly with the North, because the South was fighting for slavery. His great anxiety, however, was that the British nation should not be committed to any unworthy course during the progress of that struggle. And when our relations with America were becoming critical and menacing in consequence of the depredations committed on American commerce by vessels issuing from British ports, he brought the question before the House of Commons in a series of speeches of rare clearness and force, in which he pointed out the perilous responsibilities we were incurring by connivance or neglect in regard to those vessels. He was first attacked with great animosity both in and out of Parliament for taking this line, but after results amply vindicated his political sagacity and patriotism.

For several years Cobden had been suffering severely at intervals from a bronchial irritation and a difficulty of breathing. Owing to this he had spent the winter of 1860 in Algeria, and every subsequent winter he had to be very careful and confine himself to the house, especially in damp and foggy weather. In November, 1864, he went down to Rochdale and delivered a speech to his constituents—the last he ever delivered. That effort was followed by great physical prostration, and he determined not to quit his retirement at Midhurst until spring had fairly set in. But in the month of March there were discussions in the House of Commons on the alleged necessity of constructing large defensive works in Canada. He was deeply impressed with the folly of such a project, and he was seized with a strong desire to go up to London and deliver his sentiments on the subject. But on the 21st of March, the day on which he left home, a bitter easterly wind blew, and struck him in the throat and chest. He recovered a little for a few days after his arrival in London; but on the 29th there was a relapse, and on the 2d of April, 1865, he expired peacefully at his apartments in Suffolk Street.

On the following day there was a remarkable scene in the House of Commons. When the clerk read the orders of the day Lord Palmerston rose, and in impressive and solemn tones declared "it was not possible for the House to proceed to business without every member recalling to his mind the great loss which the House and country had sustained by the event which took place yesterday morning." He then paid a generous tribute to the virtues, the abilities, and services of Cobden, and he was followed by Mr. Disraeli, who with great force and felicity of language delineated the character of the deceased statesman, who, he said, "was an ornament to the House of Commons and an honor to England." Mr. Bright also attempted to address the House, but after a sentence or two delivered in a tremulous voice, he was overpowered with emotion, and declared he must leave to a calmer moment what he had to say on the life and character of the manliest and gentlest spirit that ever quitted or tenanted a human form.

In the French Corps Législatif, also, the vice-president, M. Forcade la Roquette, referred to his death, and warm expressions of esteem were repeated and applauded on every side. "The death of Richard Cobden," said M. la Roquette, "is not alone a misfortune for England, but a cause of mourning for France and humanity." M. Drouyn de Lhuys, the French minister of foreign affairs, made his death the subject of a special despatch, desiring the French ambassador to express to the Government the mournful sympathy and truly national regret which the death, as lamented as premature, of Richard Cobden had excited on that side of the Channel. "He is above all," he added, "in our eyes the representative of those sentiments and those cosmopolitan principles before which national frontiers and rivalries disappear; whilst essentially of his country, he was still more of his time; he knew what mutual relations could accomplish in our day for the prosperity of peoples. Cobden, if I may be permitted to say so, was an international man."

He was buried at West Lavington Church, on the 7th of

April, by the side of his only son, whose death, eight or nine years before, had nearly broken his father's heart. His grave was surrounded by a large crowd of mourners, among whom were Mr. Gladstone, Mr. Bright, Mr. Milner Gibson, Mr. Villiers, and a host besides from all parts of the country. (H. E.)

COBIJA, or, as it is officially called in honor of the first president of the republic, PUERTO LA MAR, is the principal port of Bolivia, and the chief town of the province of Atacama or Cobija. It is situated on the coast of the Pacific, about 800 miles north of Valparaiso in Chili, in 22° 32' 50'' S. lat. and 70° 21' 2'' W. long.; and it occupies a low-lying position on the beach, at the foot of a lofty range of hills. The surrounding district is desolate in the extreme, and Cobija is totally dependent on importation even for the common necessities of life. Water is very scarce; the wells only satisfy the wants of about 400 or 500 persons, and the rest of the population has to be supplied by the distillation of the salt water from the sea. At one time fish formed a valuable article of consumption; but since the rise of the mining industries the fishers have for the most part forsaken their nets. The town itself is poorly built, and consists of little more than one broad, long street. The harbor is comparatively safe; but the landing-place is bad, and the danger from the surf considerable. As a free port and the principal means of communication with the interior, Cobija attracts a considerable amount of foreign trade. It owes its foundation in the course of last century to Charles III. of Spain; it was declared a free port in 1827; and it attained the rank of capital of the department in 1837. In 1827 it consisted of little more than a few huts inhabited by Changas, or seafaring Indians; and in 1855 it only numbered 500 or 600 of a population. In 1858, however, the permanent inhabitants were no fewer than 2000, and the floating population amounted to 4000 souls. (See Tschudi, *Reise von San Pedro de Atacama nach Cobija*, 1860.)

COBLENTZ (German, *Coblens*), the capital of Rhenish Prussia, is pleasantly situated at the confluence of the Rhine and Moselle. From this circumstance it derived its ancient name of *Confluentes*, of which Coblentz is a corruption. This city is still of consequence from a military point of view, since it commands the junction of two great rivers. Its fortifications, which are very extensive, not only protect the town, but connect the works on the left bank of the Rhine with the fortress of Ehrenbreitstein on the other side of the river. The city is almost triangular in shape; two sides are bounded by the Rhine and Moselle, the third by strong fortifications. These are pierced by two massive gates, the Löhr and Mayence gates, with draw-bridges over the fosse. The military works, which were constructed on the combined systems of Carnot and Montalembert, include no fewer than 26 forts, and form a fortified camp capable of containing 100,000 men. The Rhine is crossed here by a bridge of boats 485 yards long, and by the Iron Bridge, built for railway purposes in 1866. The Moselle is spanned by a Gothic freestone bridge of 14 arches, 1100 feet in length, erected in 1344, and also by a railway bridge. In the more ancient part of Coblentz are several buildings which possess an historical interest. Prominent among these, at the point of confluence of the rivers, is the church of St. Castor, built in the early Lombard style of architecture, and surmounted by four towers. The church was originally founded in 836 by Lewis the Pious, but the present edifice is considerably less ancient. It was here that the sons of Charlemagne met in 843, when they divided the empire into France, Germany, and Italy. In front of the church of St. Castor stands a fountain, erected by the French in 1812, with an inscription to commemorate Napoleon's invasion of Russia. Not long after, the Russian troops occupied Coblentz; and St. Priest, their commander, added in irony these words—"Vu et approuvé par nous, Commandant Russe de la Ville de Coblenc: Janvier 1er, 1814." In this quarter of the town there is also the Liebfrauenkirche, a fine specimen of the old cathedral style, built in 1259; the ancient town-hall; the Castle of the Electors of Treves, erected in 1280, now converted into a manufactory of japan-ware; and the family-house of the Metternichs, where Prince Metternich, the Austrian statesman, was born in 1772. The more modern part of the town has open, regular streets, and many of these public buildings are handsome. The principal of these is the Palace or Royal Castle, with one

<sup>1</sup> [Ceded with the territory of Antofagasta to Chili by treaty of November, 1884. v. *Almanach de Gotha*, p. 621, for 1886. —Am. Ed.]

front looking towards the Rhine, the other into the Neustadt, or Great Square. It was built in 1778-86, and contains among other curiosities some fine Gobelin tapestry work. Another large edifice is the Palace of Justice, where the law courts sit, and assizes are held every three months. Coblenz has also a gymnasium (formerly a convent of Jesuits), a hospital, managed by the sisters of charity, an orphan asylum, a valuable town library, a theatre, a casino, a picture gallery, a musical institute, and a medical school. Above the Iron Bridge are Anlagen, or pleasure-grounds, much resorted to by the town's-people. The manufactures consist chiefly of linens, cottons, japan-ware, furniture, and tobacco. Coblenz is a free port, and carries on an extensive commerce by means of the Rhine, Moselle, and Lahn. Being in the centre of



Plan of Coblenz.

- |                                   |   |
|-----------------------------------|---|
| 1. Military Prison and Lasaretto. | 11. Theatre.                              |
| 2. Florina Church (Evang.)        | 12. Post Office.                          |
| 3. Market Hall.                   | 13. Prison (Civil).                       |
| 4. School of Art.                 | 14. Government Buildings.                 |
| 5. Hospital.                      | 15. Building-yard for the Fortifications. |
| 6. General Commando.              | 16. Government.                           |
| 7. Deutsches Haus.                | 17. Commandantur.                         |
| 8. Liebfrauenkirche.              | 18. Castle.                               |
| 9. Casino (Civil).                | 19. Capuchin Church.                      |
| 10. Commissariat Magazine.        |   |
| A. Weisser Thor.                  | C. Mainzer Thor.                          |
| B. Loehr Thor.                    | D. Mosel Thor.                            |

the hock wine district, a large trade in this class of produce is carried on with Great Britain, Holland, and other countries. Large exports of mineral waters are also made, about one million jars of seltzer being shipped annually. Among the products of the neighboring provinces which are exported from Coblenz are corn, iron, volcanic stones, potter's clay, stoneware, and bark. The population is 28,000.

Coblenz was one of the military posts established by Drusus about 9 b. c. It is not unfrequently mentioned during the early centuries of the Christian era as the residence of the Frankish kings, and in 860 and 932 it was the seat of ecclesiastical councils. In 1018 it obtained the rights of a city from Henry II., but at the same time was made subject to the Bishop of Treves, who entrusted the administration to the count palatine of the Rhine. In the following century the fief was held by the counts of Arnstein and the counts of Nassau; but it returned to the bishops in 1253. Archbishop Arnold surrounded the city with new walls in 1249-54, and, in spite of an insurrection on the part of the inhabitants, founded the citadel which still overlooks the town. As a member of the League of the Rhenish cities which took its rise in the 13th century, Coblenz attained to great prosperity; and it continued to advance till the disasters of the Thirty Years' War occasioned a rapid decline. When in 1632 the Elector Philip Christopher of Sötern surrendered Ehrenbreitstein to the French, the town received an im-

perial garrison, which was soon, however, expelled by the Swedes. They in their turn handed the city over to the French, but the imperial forces succeeded in retaking it by storm. In 1688 it was besieged by the French Marshal Boufflers, but was successfully defended by Count Lippe. In 1786 the elector of Treves, Clemens Wenceslas, took up his residence in the town, and gave great assistance in its extension and improvement; and a few years later it became, through the invitation of his minister, Duminque, one of the principal rendezvous of the French émigrés. In 1794 it was taken by the Revolution army, and, after the peace of Lunéville, it was made the chief town of the Rhine and Moselle department. In 1814 it was occupied by the Russians, and by the Congress at Vienna it was assigned to Prussia.

COBRA (*Naja tripudians*), a poisonous Colubrine Snake, belonging to the family *Elapidae*, known also as the Hooded Snake, or Cobra di Capello. In this species the anterior ribs are elongated, and by raising and bringing forward these, the neck, which otherwise is not distinct from the head, can be expanded at will into a broad disc or hood, the markings on which bear a striking resemblance to a pair of barnacles, hence the name "Spectacle Snake" also applied to the cobra. It possesses two rows of palatine teeth in the upper jaw, while the maxillary bones bear the fangs, of which the anterior one only is in connection with the poison gland, the others in various stages of growth remaining loose in the surrounding flesh until the destruction of the poison fang brings the one immediately behind to the front, which then gets ankylosed to the maxillary bone, and into connection with the gland secreting the poison, which in the cobra is about the size of an almond. Behind the poison fangs there are usually one or two ordinary teeth. The cobra attains a length of nearly 6 feet and a girth of about 6 inches, and with the exception of the markings on the hood is of a uniform brown color above and bluish-white beneath. There are, however, many distinct varieties, in some of which the spectacle markings on the hood are wanting. The cobra may be regarded as nocturnal in its habits, being most active by night, although not unfrequently found in motion during the day. It usually conceals itself under logs of wood, in the roofs of huts, and in holes in old walls and ruins, where it is often come upon inadvertently, inflicting a death wound before it has been observed. It feeds on small quadrupeds, frogs, lizards, insects, and the eggs of birds, in search of which it sometimes ascends trees. When seeking its prey it glides slowly along the ground, holding the anterior third of its body aloft, with its hood distended, on the alert for anything that may come in its way. "This attitude," says Sir J. Fayer, "is very striking, and few objects are more calculated to inspire awe than a large cobra when, with his hood erect, hissing loudly, and his eyes glaring, he prepares to strike." It is said to drink large quantities of water, although like reptiles in general it will live for many months without food or drink. The cobra is oviparous; and

its eggs, which are from 18 to 25 in number, are of a pure white color, somewhat resembling in size and appearance the eggs of the pigeon, but sometimes larger. These it leaves to be hatched by the heat of the sun. It is found in all parts of India from Ceylon to the Himalayas, where it occurs at a height of 8000 feet, and it is justly regarded as the most deadly of the Indian Thanatophidia. A large proportion of the deaths from snake-bite, where the species inflicting the wound has been ascertained, is shown to be due to the cobra; and it is estimated that fully one-half of the 20,000 deaths that annually occur in India from this cause may be attributed to this unluckily common species. The bite of a vigorous cobra will often prove fatal in a few minutes, and as there is no known antidote to the poison, it is only in rare instances that such mechanical expedients as cauterizing, constriction, or amputation can be applied with sufficient promptitude to prevent the virus from entering the circulation. Of late years, owing to a small reward offered by the Indian government for the head of each poisonous snake, great numbers of cobras have been destroyed; but only low caste Hindus will engage in such work, the cobra being regarded by the natives generally with superstitious reverence as a divinity powerful to injure, and therefore to be propitiated; and thus oftentimes when found in their dwellings this snake is allowed

to remain, and is fed and protected. "Should fear," says Sir J. Fayer, "and perhaps the death of some inmate bitten by accident, prove stronger than superstition, it may be caught, tenderly handled, and deported to some field, where it is released and allowed to depart in peace, not killed" (*Thanatophidia of India*). Great numbers, especially of young cobras, are killed by the adjutant birds and by the mungoes—a small mammal which attacks it with impunity, apparently not from want of susceptibility to the poison, but by its dexterity in eluding the bite of the cobra. Mere scratching or tearing does not appear to be sufficient to bring the poison from the glands; it is only when the fangs are firmly implanted by the jaws being pressed together that the virus enters the wound, and in those circumstances it has been shown by actual experiment that the mungoes, like all other warm-blooded animals, succumb to the poison. In the case of reptiles, the cobra poison takes effect much more slowly, while it has been proved to have no effect whatever on other venomous serpents. The cobra is the snake usually exhibited by the Indian jugglers, who show great dexterity in handling it, even when not deprived of its fangs. Usually, however, the front fang at least is extracted, the creature being thus rendered harmless until the succeeding tooth takes its place, and in many cases all the fangs, with the germs behind, are removed—the cobra being thus rendered innocuous for life. The snake charmer usually plays a few simple notes on the flute, and the cobra, apparently delighted, rears half its length in the air and sways its head and body about, keeping time to the music. The cobra, like almost all poisonous snakes, is by no means aggressive, and when it gets timely warning of the approach of man endeavors to get out of his way. It is only when trampled upon inadvertently, or otherwise irritated, that it attempts to use its fangs. It is a good swimmer, often crossing broad rivers, and probably even narrow arms of the sea, for it has been met with at sea at least a quarter of a mile from land.

COBURG, or in German *Koburg*, the capital of the duchy of Saxe-Coburg-Gotha, and, alternately with Gotha, the residence of the duke and the seat of the administration, is situated on the left bank of the Itz, an affluent of the Regen, and on the southern slope of the Frankenwald, 40 miles S.S.E. of Gotha. The town is for the most part old, and contains a large number of remarkable buildings. The ducal palace, or Ehrenburg, is a fine Gothic edifice, with an extensive library, and collections of coins, paintings, and specimens in natural history; it was originally a convent of the Barefooted Friars, received its present appropriation from John Ernest in 1549, and was restored by Ernest in 1844. In front of the palace is a bronze statue of the latter duke by Schwanthaler, and in the court-garden is the ducal mausoleum. Among the churches the most remarkable is the Moritzkirche, with a tower 335 feet high, the beautiful Hofkirche, and the modern Roman Catholic church. The educational institutions include a gymnasium, founded in 1604 by Casimir, and thus known as the Casimirianum; a Realschule, established in 1848, a normal college, a deaf and dumb asylum, and a school of architecture. The arsenal contains a public library; and the so-called *Augustenstift*, where the ministry of the duchy is located, has an extensive collection of objects in natural history. Coburg further possesses a town-house, Government buildings, an observatory, and a theatre. On a commanding eminence in the vicinity is the ancient castle of Coburg, which dates at least from the 11th century. Till 1348 it was the residence of the counts of Henneberg, and till 1547 belonged to the dukes of Saxony; in 1781 it was turned into a penitentiary and lunatic asylum; but in 1835-8 it received a complete restoration. The most interesting room in this building is that which was occupied by Luther for three months in 1530, and thus became the birthplace of his famous hymn, *Eine feste Burg ist unser Gott*; the bed on which he slept and the pulpit from which he preached in the old chapel are still shown. Coburg is a place of considerable industry, and possesses a large brewery, factories for the weaving of linen and cotton goods, tanneries, and dye-works; and there is an important trade in the cattle reared in the neighborhood. Among various places of interest in the vicinity are the ducal residences of Callenberg and Rosenau, in the latter of which Albert, the Prince Consort, was born in 1819; the castle of Lauterberg; and the village of Neuses, with the house of the poet Rückert, who died there in 1866, and on the other side of the river

the tomb of the poet Thümmel. Population in 1871, 12,819.

COCA. See CUCA.

COCCEIUS, or COCH, JOHANN (1603-1669), a Dutch theologian, was born at Bremen. After studying at Hamburg and Franeker he became in 1629 professor of Hebrew in his native town. In 1638 he was transferred to Franeker, where he held the chair of Hebrew, and from 1643 the chair of theology also, until 1650, when he became professor of theology at Leyden. He died on the 4th November, 1669. Cocceius was a profound Oriental scholar, and his chief services were rendered in the department of Hebrew philology and exegesis. The common statement that he held that every passage has as many meanings as it can be made to bear is founded on an entire misconception of his fundamental law of interpretation. What he really maintained was the sound principle that individual words and phrases are to be interpreted according to their contextual connection, and not according to any predetermined dogmatic system, whether patristic or scholastic. As one of the leading exponents of the "federal" theology, he spiritualized the Hebrew scriptures to such an extent that it was said that Cocceius found Christ everywhere in the Old Testament and Grotius found him nowhere. He held millenarian views, and was the founder of a school of theologians who were called after him Cocceians. His most distinguished pupil was the celebrated Vitringa. He wrote commentaries on most of the books of the Old Testament, but his most valuable work was his *Lexicon et Commentarius Sermonis Heb. et Chald.* (Leyden, 1669), which has been frequently republished. The federal or covenant theology which he taught is fully expounded in his *Summa Doctrinæ de Fœdere et Testamento Dei* (1648). His collected works were published in twelve folio volumes at Amsterdam in 1701.

COCHABAMBA, a city and bishop's see of Bolivia, capital of a province and department, is situated about 8370 feet above the level of the sea, on both banks of the Rio de la Rocha, a sub-tributary of the Rio Grande, to the south of a considerable cordillera. It is about 122 miles N.N.W. of Sucre, its latitude is 17° 27' S., and its longitude 65° 46' W. The streets are broad, and the houses for the most part of one story and surrounded by gardens, so that the area of the city is great in comparison with its population. There are fifteen churches, a gymnasium, and a cabildo; and an extensive industry is maintained in the production of woollen and cotton stuffs, leather, soap, glass-ware, and pottery. The population is largely composed of Indians; and the prevailing language is Quichua. Cochabamba was founded in the 16th century, and for a time was called Oropesa. In the revolution of 1815 the women of the city distinguished themselves by their bravery, and successfully attacked the Spanish camp; and in 1818 a number of the heroines were put to death by the Spanish forces. In 1874 the city was seized by Miguel Aguirre, and a large part of it laid in ruins, but peace was soon afterwards restored, and the regular authorities reinstated. The population in 1858 was 40,678.

COCHIN, a feudatory state of Southern India, situated within the presidency of Fort St. George or Madras, between 9° 48' and 10° 50' N. lat., and between 76° 5' and 76° 58' E. long. The state, which is of irregular shape, is bounded on the W., N., and E. by the districts of South Malabar and Coimbatore, and for some distance on the W. by the Indian Ocean; on the S. it is bounded by the state of Travancore. Cochin contains a total area of 1361 square miles, and a population, according to a census taken in 1875, of 598,353 souls, dwelling in 118,196 houses. The state is divided into seven *taluks*, or sub-districts, viz., Cochin, Cannanore, Mugundapuram, Trichur, Tallapalli, Chitur, and Cranganore.

Cochin consists for the most part of a maritime lowland hemmed in between the sea and the *GHâts*. It includes, however, the mountains which thus wall it out from inner India, and the lower portion is copiously watered by the torrents which pour down them. These torrents dwindle in the hot weather to rivulets, but during the rains they swell into great cataracts, rising in one instance at least 16 feet in twenty-four hours. On the lowlands, they unite as elsewhere on the western coast into shallow lakes or "backwaters," lying behind the beach line and below its level. In the monsoon the Cochin backwaters are broad navigable channels and lakes; in the hot weather they contract into

shallows in many places not 2 feet deep. The vegetation is luxuriant; rich crops of rice are grown on the lowlands; the hills send down vast quantities of timber by means of the torrents. The remains of once fine forests of teak are preserved in the north-eastern corner of the state, and still form a considerable source of wealth. Coffee has of late years received much attention and promises well. The other products are the usual ones of an Indian state,—cotton, pepper, betel-nut, chillies, ginger, various spices, cardamoms, arrowroot, &c. An excellent account of Cochin will be found in Dr. Day's *Land of the Permauls*. The rajas of Cochin claim to hold the territory by descent from Chermán Perumál, who governed the whole of the surrounding country, including Travancore and Malabar, as viceroy of the Chola kings, about the beginning of the 9th century, and who afterwards established himself as an independent raja. In 1776 Cochin was subjugated by and became tributary to Hyder Ali. In 1792 Tippu ceded the sovereignty to the British, who made over the country to the hereditary raja, subject to a tribute of Rs. 100,000. The state is now in subsidiary alliance with the British Government, under a treaty dated 17th October, 1809. By this engagement, which was entered into on the suppression of an insurrection on the part of the rajas of Cochin and Travancore against the British power, the Cochin chief agreed to pay, in addition to the tribute of Rs. 100,000, an annual sum, equal to the expense of maintaining a battalion of native infantry, or Arcot Rs. 176,037, making an aggregate annual payment of Rs. 276,037. In return for this payment, and certain engagements entered into by the raja, the East India Company undertook to defend the integrity of the state territory against all enemies. Subsequently the annual tribute to the British Government was reduced to Rs. 240,000, and again afterwards to Rs. 200,000 (£20,000) at which it now stands. A British resident represents the government of India in Cochin conjointly with Travancore. The present raja succeeded to the throne in March, 1864.

The total revenue of Cochin for the Malabar year 1049 (1873-74 A.D.), amounted to £130,851, being the highest income recorded for any year; the principal items were the land revenue, £61,764; customs, £11,035; and salt, £15,713. The disbursements for the same year amounted to £111,858, leaving a surplus for the year of £18,993. The state has now the sum of £200,000 invested in British Government securities. A high school, with an average of 170 pupils, and 5 district schools are maintained by the state. Hospitals and dispensaries and a post-office are also kept up, and a considerable sum, amounting to £13,669 in 1874, is annually spent in public works. The military force is a nominal one of 1 commissioned officer and 340 non-commissioned officers and men. The two trading ports (exclusive of the British port of Cochin) are Malipuram and Narakel, at which 31 vessels, a burden of 22,626 tons, arrived in 1873-74. The capabilities of Narakel as a port of shelter during the S.W. monsoon have been satisfactorily proved, and the mail-steamers of the British India Company touch there for four or five months of the year, when the neighboring English port of Cochin is unapproachable.

COCHIN, a town and port of British India, belonging to the Malabar district of Madras, situated in 9° 58' 57" N. lat. and 76° 13' 55" E. long. The town lies at the southern extremity of a strip of land about twelve miles in length, but at few places more than a mile in breadth, which is nearly insulated by inlets of the sea and estuaries of streams flowing from the Western Ghats. These form the Cochin backwater described in the article on the Cochin state. The town of Cochin is about a mile in length by half a mile in breadth. Its first European possessors were the Portuguese, from whom it was captured by the Dutch in 1663. Under the Dutch the town prospered, and about 1778 an English traveller describes it as a place of great trade; "a harbor filled with ships, streets crowded with merchants, and warehouses stored with goods from every part of Asia and Europe, marked the industry, the commerce, and the wealth of the inhabitants." In 1796 Cochin was captured from the Dutch by the British, and in 1806 the fortifications and public buildings were blown up by order of the authorities. The explosion destroyed much private property, and for a long time seriously affected the

prosperity of the town. Under Dutch rule Cochin was very populous, containing Europeans, Moplas or Musalmans, Hindus, Arabs, Persians, and Christians of various sects, comprising natives, Armenians, Indo-Portuguese, and those denominated Syrian Christians. The Jews have also a settlement here. They are of two classes, the Fair or White Jews, of more recent arrival and settlement in the country, and the Black Jews, who reside apart in a village outside the town. According to the census of 1871, Cochin town contains 2731 houses and a population of 13,840 souls, classified as follows:—Hindus, 3883, Muham-madans, 2174; Christians, 7783; and "Others," 46. The town is constituted a municipality, and in 1873-74 the municipal income (excluding balances) amounted to £1573 10s., and the expenditure to £1560 10s. The entrance to the port of Cochin is obstructed by a bar across the mouth of the river, and during the S.W. monsoon, which lasts for four or five months, vessels can neither enter nor depart from it in safety. Notwithstanding the difficulties of navigation, however, the port has a considerable maritime trade. In 1873-74, 171 British vessels of a burden of 108,579 tons, 27 foreign vessels of 7010 tons, and 1644 native craft of a total of 49,215 tons burden entered the port, and paid a total of £1974 as port dues,—by far the greater part, £1520, being paid by the British ships. The value of the exports in 1873-74 amounted to £755,796, and of the imports to £547,252, paying a total customs duty of £5161. A lighthouse at the south entrance of the harbor marks the entrance to the port, and is visible at a distance of 15 miles.

COCHIN CHINA, a name applied to the eastern division of the Indo-Chinese peninsula, composed of the terri-



Sketch-Map of Cochin China.

ories of Anam proper, Tong-king, and the French colony of Cochin China. It forms a long strip of country which stretches in an arc of a circle along a coast-line of 1240 miles from 8° 30' to 23° N. lat. With a breadth of 372 miles in the north of Tong-king, it is afterwards narrowed by a chain of mountains parallel to the China Sea, and has no more than 50 miles of breadth in the greater part of the kingdom of Hué; but in Lower Cochin China it widens out again to about 190 miles. The most western point, in Tong-king, reaches 102° 20' E. long., and the most eastern, Cape Varela, in Cochin China, is in 109° 40'. The boundaries are—on the N. the Chinese provinces of Yun-nan and Kwang-se, on the E. and S. the China Sea, on the W. the Gulf of Siam, the kingdom of Cambodia, and the Laos country tributary to the Siamese empire. According to the most probable estimates the empire of Anam has an area of from 190,000 to 230,000 square miles, or about the same extent as France; while the

French colony occupies about 21,630. The western limits of this empire, are, however, very imperfectly determined, and the regions to the west of Tong-king are still unexplored. The N. of Cochin China is washed by the Gulf of Tong-king, a great inlet formed by the coast of Tong-king on the W. and the island of Hai-nan and the peninsula of Lien-chow on the E. At its mouth, towards Tiger Island and the S.W. part of Hai-nan, the gulf has a breadth of about 138 English miles, which almost represents its medium breadth. Near the west coast are several islands, and towards the head of the gulf a great number of islets and banks. From soundings which have been taken throughout its whole extent, it has been found that in the middle of the entrance there is a depth of from 210 to 330 feet, which diminishes towards the coasts; and the depth is less half way up the gulf, where the bottom is generally soft.

Passing along the coast from Cape Pak-loung, where the frontier commences between China and Tong-king, we find that all the part north of the Gulf of Tong-king is little known; it is said to be fringed with banks and rocks, and some large islands have been visited by English vessels in pursuit of pirates. The most important are the Pirate Islands, a group of multitudinous islets in a bay of which the Chinese name is Fie-tzi-long, and the Pearl Islands. Next we find the mouth of the River Lach-Huyen, which is deep, but obstructed about a mile inland by a bar preventing the entrance of any vessel drawing more than 11½ feet. Next come the mouths of the River of Tong-king, Song-Coi, or Hong-kiang (Red River). The delta of this river is formed by four main branches—Cua<sup>1</sup> trà lay, Cua lac, Cua dhai, Cua ba lat—which communicate with each other both by natural channels, called arroyos, and by artificial canals. These are charged with alluvial matter, and produce considerable increase of soil. Mr. E. Ploix, a hydrographic engineer who visited the gulf between 1857 and 1859, estimates the annual advance of the coast at about 330 feet. It is by these rivers that Ke-cho, or Ha-noi, the capital of Tong-king can be reached. This town and the port of Ninh-hai, in the province of Hai-dzuong, were opened to foreign commerce by a treaty concluded between France and the Government of Hué, March 15, 1874. To allow a ship to pass up the river at any season its draught must not exceed 5½ feet, and from the end of May to the end of November, vessels drawing 12 feet can cross the bars.

About 18° 10' N. lat. lies the island of Hon-tseu, or Goats' Island, near a prominent cape about 1410 feet high. A little to the south of Hon-tseu is the point to the north of which there is only one tide in 24 hours, except during a period of two weeks, when on three or four days there are two tides of little force. At Cape Boung-Qui-hoa there is a good anchorage well sheltered by islands, of which the chief is South Watcher Island, or South Vigie. In front of Cape Lay is the little Tiger Island, where the west coast of the gulf of Tong-king terminates. On the China Sea the coast presents successively, as we pass southward, the mouth of the river Hué, defended by a fort; the Bay of Tourane, wide, deep, and well sheltered, but unfortunately situated in an unhealthy district, and in the poorest part of the country; the Bay of Quit-Quit, a very good anchorage, and the safest on this coast during the N.E. monsoon; the Island Cu-lao-ré, or Pulo Canton; the port of Qui-nhon, or Binh dhinh, in the province of this name, opened to European commerce by the treaty of March, 1874; the bay and the commodious port of Phuyen; Cape Varela, or Mui-nai, a very lofty peak visible 30 nautical miles out at sea, and to the south of the cape the port of Hon-ro, safe at all seasons of the year; the Bay of Phan-rang and Cape Padaran, or Mui-Din, districts bordered by coral banks; Cape Ke-ga; and Cape Ba-kee, which forms the limit between lower Cochin China and the kingdom of Anam. Between Cape Padaran and Cape Ba-kee the coast is low, and bordered by dangerous banks. In front are the little islands of Pulo Cecir, Catwick, and Pulo Sapate, of difficult access.

The whole of lower Cochin China being formed of alluvial deposits, its coast is very low, has little irregularity of surface, and is covered with mangroves. The different mouths of the River Cambodia or Me-kong form a delta of more than 70 miles in extent. The soil is subject to frequent changes on account of the alluvial deposits of the

<sup>1</sup> Cua signifies embouchure.

river, which is bordered by sand banks stretching seawards out of sight of land. At the entrance of the river Donnai, which leads to Saigon, rises Cape St. Jacques, a peak 920 feet above the level of the sea. At 45 sea-miles from the coast and from the mouths of the Me-kong, is the island of Pulo Condore, with a good port, and a penitentiary established by the French Government. On the west coast of Lower Cochin China, in the Gulf of Siam, is the port of Ha-Tien, communicating by a canal with one of the arms of the Me-kong.

To the north of Tong-king terminate the last underfalls of the high plateau of Thibet; a long chain stretches parallel to the Sea of China as far as the south of the kingdom of Anam of which it forms the western boundary. The highest point of this chain does not exceed 5250 feet. Between the last ramifications of the mountains of Thibet there descend from the plateau of Yun-nan and in a south-east direction the affluents of the great River Song-Coi or Hong-kiang, which undergoes periodic variations in the supply of its waters. In the month of March it is very low; but every year about the month of July it leaves its channel, floods a part of the country, and rolls along with a very powerful current. Before passing Ha-noi it receives the tribute of two great rivers known to the natives by the names of the Black River and the Clear River.

The kingdom of Anam, closely shut in between the mountains and the sea, is drained by numerous but unimportant streams. Lower Cochin China, or French Cochin China, is abundantly watered by the numerous mouths and the canals which form the delta of the Me-kong or Cambodia. This river takes its rise in the mountains of Thibet, waters the southern provinces of China and the district of Laos tributary to Siam, and crosses through the kingdom of Cambodia, where it divides into three branches. The first, which does not penetrate into Cochin China, turns towards the north-west and loses itself in the lake of Tonli Sap. The second, which takes the name of Hinder River (Hau-giang or Song-sau), flows south-east, enters Cochin China, communicates with the Sea of Siam by the Canal Vinh-te of Ha-tien and by that of Rach-gia, and enters the China Sea by two mouths. The third branch, named Front River (Tien-giang or Song-truoc), flows parallel to the preceding, divides at Vinh-long into four arms, and debouches by six mouths. These streams form numerous islands and communicate with each other by means of canals or arroyos. In spite of the length of its course and the great mass of its waters, the Me-kong cannot be utilized as a means of communication with Central China, because of the numerous rapids and rapids which encumber its course. It is besides subject to an annual flood; the waters begin to rise in May, attain their maximum in October, and decrease until March. From the month of March to the month of May the level is almost constant. Two other streams water the east of Lower Cochin China,—the Vaico, divided into two branches, and the Donnai. These rivers communicate with each other and with the mouths of the Me-kong by numerous arroyos. The Donnai receives the Saigon River; and it is by this means that the largest vessels reach the town of that name.

The climate of the north of Anam differs much from that of the south. In Tong-king, though it is usual to divide the year into a dry and a wet season, there is properly speaking no dry season. In December and January the thermometer falls to 41° or 43° Fahr. Summer corresponds to the period of the rains from the end of April to the month of August; and at that time it is excessively hot. Storms are frequent, and the coasts are often visited by typhoons. At the same time Tong-king is a healthy country; the weather during four months is excellent; and the French colony of Saigon might find there—what has never been discovered in Cochin China proper—a suitable site for a sanatorium. The climate of the French colony is unhealthy for Europeans; they cannot be acclimatized. The mortality of the troops is rather high; and before their residence was shortened to two years it might be calculated at 9 or 10 per cent. for a three years' residence. The chief cause of the maladies which affect Europeans is the character of the soil. On the banks of the rivers, in the salt marshes, and along the shores of the sea, intermittent fevers of great severity are frequent. In the forest land rages the terrible wood fever, from which the



native himself cannot escape, though he lives unharmed in the midst of the rice swamps. But the great plague of Lower Cochin China is dysentery,—a disease which, endemic in all warm countries, proves in Cochin China particularly fatal. It is to it that the greater part of the deaths among Europeans are to be ascribed; and they often succumb to its effects after their return to their native country. Most of the children born of European parents in Cochin China die a short time after birth. White women are there exposed to many dangers, especially during their delivery; and there is consequently little hope of forming there a race of creoles. The native women, on the contrary, are very prolific, and suffer surprisingly little in childbirth. It is also interesting to observe that the Anamites, like the races of the extreme East, recover from wounds of the greatest severity, which would infallibly kill Europeans even in their own country.

The mean temperature of Lower Cochin China is 83° Fahr. The greatest heat in April and May within doors is 97° Fahr. In the mornings of December the temperature falls to 65° Fahr. The year is divided into the dry season, which corresponds to the N.E. monsoon, and the rainy season, which corresponds to the S.W. monsoon. What renders the climate peculiarly injurious and enervating is that, besides the very slight difference between the temperatures of day and night, the hygrometric readings are always very high. The surface of Cochin China, composed of recent alluvial deposits, is absolutely flat, and in some places is below the level of the sea. The slightness of the slope of this vast plain allows the tide to advance far inland, and the borders of the rivers to be alternately covered with water and exposed to the perpendicular rays of the sun. All the coasts are covered by mangroves (the marsh-tree of the tropics), which with their dull monotonous foliage everywhere betoken the unhealthiness of the soil.

**Animals.** The finest species of tiger, the royal tiger, is to be met with from the mountains which bound Tong-king on the north as far as the south of Lower Cochin China; and a short time ago it was still to be found in the wooded hills close to Saigon. The other wild animals are the panther, the rhinoceros, the elephant—which the people of Anam have not learned to domesticate—the cocoon bear, the stag, the wild boar, the wild ox, and monkeys of various kinds. The domestic animals are goats, horses, buffaloes (with which the Indo-Chinese carry on the difficult and unhealthy cultivation of the rice-fields), and pigs, which are kept in great numbers. There are numerous birds of many species, which—as in all tropical regions—are remarkable for the beauty of their plumage. Among the rest may be mentioned pea-fowl, pheasants, turtle-doves, the green pigeons of Pulo Condore, paroquets, hornbills, sultana fowls, and various species of wading birds and palmipeds. The rivers abound with life; and the fish, though of poor quality, form an important part of the food of the people. They are caught, along with frogs and snakes, even in the mud of the rice-fields. The crocodile is frequently met with, and adds another item to the native cuisine. This hot damp country swarms with reptiles, of which some species are very dangerous. Among these are the huge cobra di capello (*Naja*), many species of adders, and the immense python, which is of much use in destroying during the night all kinds of rats, including the intolerable musk-rat.

**Vegetable products.** The forests furnish several kinds of timber for building. In the plains and valleys are numerous fruit-trees,—the banana, the guava, the papaw, the medlar-tree, the orange, the citron, and, most abundant of all, the cabbage-palm and the cocoa-tree, and the cinnamon, of which Tong-king furnishes a superior quality. The people of Anam are essentially agricultural. Besides rice, which is the chief production of the country, the cultivated lands furnish cotton, mulberry, sugar-cane, maize, betel-nut, and vegetables, especially potatoes, earth-nuts, and pepper. Tea is cultivated also, especially in Tong-king, but the people of Anam do not know how to prepare it.

**Minerals.** To the traveller who pays only a brief visit the kingdom of Anam appears ill provided with metals. If a mine be discovered the natives forbid access to it, and still more frequently, for fear of the authorities, are unwilling to give any information. Two excellent authors, Messrs. T. Crawford and M'Culloch, have supported this false opinion in their works. More precise

information, has, however, been obtained, recent explorers of the country stating that Tong-king is very rich in metals, and furnishes especially gold, silver, brass, zinc, and iron. It is from Tong-king that the famous tam-tams, the manufacture of which is still a secret to Europeans, are obtained. Cochin China, properly so called, furnishes also gold, silver, brass, and marble; and coal is found there in several places. Lower Cochin China, like all alluvial plains, is poor in minerals; quarries, however, of granite and of jet are worked.

There is little industrial activity in Anam, but in Tong-king the manufacture of articles inlaid with mother-of-pearl is carried on. From China Cochin China receives a large quantity of manufactured goods, cotton and silk stuffs, porcelain, and tea. The importation from France is also very considerable. The principal exports are rice (which forms of itself half the sum total), salt fish, provided principally by the fisheries at the mouth of the two chief rivers, salt, undyed cotton, pepper, and the skins of animals. The great commercial importance of Cochin China arises from the excellence of its situation, as a way of communication with the rich and populous provinces of middle China. England has long been seeking to open a route for trade between the north-east of India, or Pegu, and the south-west of China, but up to the present time, notwithstanding the courage and devotion of explorers, these attempts have failed.

From 1866 to 1868 a French expedition, commanded by Captain Doudart de Lagrée, followed up the course of the Me-kong, and penetrated into middle China. This expedition cost its chief his life, for he died in consequence of the fatigue which he underwent in Yun-nan. This examination of the Me-kong proved that this fine river is, as already noticed, unfit for regular navigation. Another route, however, by the Tong-king, may be opened up; and it is comparatively easy and habitually used by the natives. In 1872 Mr. Dupuis, a French merchant, passed up the course of the Hong-kiang as far as Mang-Hao, a town of Yun-nan, where the river ceases to be navigable. He came down the river again in 1873. He declares it to be navigable in every season, and has thus solved the problem which Captain Doudart de Lagrée sought to solve by means of the Me-kong. M. Dupuis's expedition led the French authorities, at the solicitation of the Government of Hué, to despatch M. Francis Garnier to the Tong-king; but the gallant explorer was assassinated by pirates in the neighborhood of Ha-noi.

The native of Anam is the worst built and the ugliest of all the Indo-Chinese who belong to the Mongolian race. He is scarcely of middle height, and is shorter and less vigorous than his neighbors. His complexion is tawny, darker than that of the Chinese, but clearer than that of the Cambodian; his skin is thick; his forehead low; his skull slightly depressed at the top, but well developed at the sides. His face is flat, with highly-protruding cheek-bones, and is lozenge-shaped or eurygnathous to a degree that is nowhere exceeded. His nose is not only the flattest, but also the smallest among the Indo-Chinese; his mouth is large, and his lips thick; his teeth are blackened and his gums destroyed by the constant use of the betel-nut, the areca-nut, and lime, a custom which perhaps originated in hygienic reasons. His neck is short, his shoulders slope greatly, his body is thick-set, large, all of one piece, as it were, and wanting in suppleness. His pelvis is large, with a considerable separation of the upper part of the femora, giving to his gait a curious swagger, which has, not without reason, been described as theatrical. This odd swagger by itself suffices to distinguish the Anamese from every other Indo-Chinese people without exception. Another peculiarity, which especially distinguishes this race from the other Indo-Chinese branches, is a greater separation of the big toe from the rest than is found in any of the other peoples that walk bare footed. It is sufficiently general and well marked to serve as an ethnographic test; and it indicates that the people of Anam are not descended—as some authors have asserted—from a mingling of indigenous savages with the Chinese, but have existed as a distinct race for a long time. According to Father Legrand de la Liraye (*Notes historiques sur la nation Annamite*, Saigon, 1865), this curious feature has served to distinguish the people of Anam since the year 2285 B.C., that is to say, 63 years after the biblical deluge.

This statement, taken as it is from the Chinese annals, shows that the Anamese could not have received this characteristic from their neighbors; and it is a very curious fact that it has been transmitted to the present inhabitants despite the frequent intermarriages with other races which must have taken place during this period of forty centuries. The inhabitants of Lower Cochin China are evidently weaker and smaller than those of Tong-king, and this probably results from their dwelling in marshy rice-fields.

In the midst of the Anamese live Cambodians and immigrant Chinese, the latter, associated together according to the districts they come from, carrying on nearly all the commerce of the country. In the forests on the frontiers of Cochin China dwell certain wretched savages called Mois, or Stiengs, of whom little is known; and alongside of these are the Chams, a Mahometan people which appear to be of Arab origin, and, in spite of a strong infusion of Chinese blood, preserve the warlike qualities of their ancestors, their love of fighting, their gay and open character, and their abstinence from theft. Their stature is tall, and they are characterized by the enormous projection of the soft parts of the abdomen. Their women, while mixing freely in society without veiling, have a high-spirited virtue which forms a contrast to the corruption that prevails around them. Their language shows that they once knew the lion and the chamois; and while they are now inferior in civilization, they preserve traces in their vocabulary of a higher condition. Among the different races which inhabit Indo-China numerous mixtures take place. There are crosses of the Anamites with the Hindu, with the Malay, with the Cambodian, and with the Chinese. The last of these half breeds, who are called Min-huongs, are the most numerous and interesting.

**Language.** Evidently derived from the Chinese, of which it appears to be a very ancient dialect, the Anamese language is composed of monosyllables, of slightly varied articulation, expressing absolutely different ideas according to the tone in which they are pronounced. It is quite impossible to connect with our musical system the utterance of the sounds of which the Chinese and Anamese languages are composed. What is understood by a "tone" in this language is distinguished in reality, not by the number of sonorous vibrations which belong to it, but rather by a use of the vocal apparatus special to each. Thus, the sense will to a native be completely changed according as the sound is the result of an aspiration or of a simple utterance of the voice. Thence the difficulty of substituting our phonetic alphabet for the ideographic characters of the Chinese, as well as for the ideophonetic writing partly borrowed by the Anamese from the letters of the celestial empire. We owe to the Jesuit missionaries the introduction of an ingenious though very complicated system, which has caused remarkable progress to be made in the employment of phonetic characters. By means of six accents, one bar, and a crotchet, it is possible to note with sufficient precision the indications of tone without which the Anamese words have no sense for the native. This system is universally adopted in French Cochin China, and the new generation, almost without exception, are able to read and write in Latin characters.

**National character and customs.** The Anamese are idle, incapable of deep emotion, and fond of ease. They show much outward respect for superiors and parents, but they take great delight in mocking and banter. They cherish great love of their native soil and native village, and cannot long remain far from home. On the whole they are mild, or rather apathetic, but the facility with which they learn is remarkable. Buddhism, mingled with coarse popular beliefs, is the dominant creed, but the learned hold the doctrine of Confucius, and in truth the people of Anam are but slightly religious. Nevertheless, like their neighbors, the Chinese and the Cambodians, they have a great respect for the dead, and their worship almost entirely consists of ceremonies in honor of their ancestors. Like the Chinese they dispose of the body by inhumation. Among the savage tribes of the interior there is scarcely any idea of a God, and the superstitious practices to which they are addicted can scarcely be considered as the expression of a definite religious idea. Christianity counts 400,000 adherents in Tong-king and 5000 in Lower China.

**Government.** The system of government in the empire of Anam is pure and absolute monarchy without any other constitution than powerful custom.

The succession to the throne follows the order of primogeniture. Between the citizens there exists the most complete equality, since public offices are open to all, and there are no other social distinctions than those due to office or fortune. The sovereign, at once high priest and supreme judge, governs despotically with the assistance of six ministers. The army, or rather the military list, for a large part of the force exists only on paper, is composed of 80 regiments, with 500 men in each. It is recruited from Cochin China; Tong-king furnishes no soldiers. It is under the command of a commander-in-chief, a kind of constable of the kingdom, or grand marshal, who is personally responsible for the defence of the citadel of Hué. The marine, which has no ships, is composed of 30 regiments, under an admiral-in-chief, who is assisted by a vice-admiral and two rear-admirals, each of whom commands 10 regiments. The mandarins, as in China, form two distinct classes—the civil and the military. The first class are scholars who have passed literary examinations. The latter are chosen chiefly on account of physical fitness; and it is only in the highest ranks that well-educated, respectable men are to be found. The people have a great regard for the learned, who have all received a higher moral education,—that of Confucius. The mandarins are divided into nine degrees, and each degree comprises two classes. Besides the French colony, the empire of Anam is divided into 24 provinces placed each under the authority of a governor. The province is subdivided into departments, arrondissements, cantons, and communes. The French colony, administered by a governor assisted by a privy council, comprehends the six ancient provinces of the south. It is now divided into four provinces, bearing the names of their chief cities,—Saigon, Mt-thô, Vinh-long, and Bassac. The provinces form together 19 inspectorships with an administrator of native affairs at the head of each.

The chief town and the ancient capital of Tong-king, Ha-noi, or Ke-cho (i.e., the market), <sup>Chief town.</sup> situated on one of the branches of the Song-Coi, though at present greatly fallen, still contains at least 50,000 inhabitants. It possesses a very large citadel, which serves as the residence of the viceroy and of the special envoy or royal commissioner, who is the first authority in Tong-king. This citadel, at present badly kept in repair and poorly equipped, was built in the course of last century according to plans furnished by European engineers. The provincial capitals of Hai-duong (30,000 inhabitants), Bac-Ninh, Nam-Dinh, likewise possess important citadels; and that of Minh-binh, also the chief town of a province, is the strongest of all Tong-king. Hué, or Phu-tua-tien, capital of the kingdom of Anam, is composed of two portions—the inner town, a vast fortress built on the Vauban system according to the plans of French engineers, and occupied by the Government; and the outer town, which is inhabited by the mass of the population, who are estimated at 100,000 souls. Mention may also be made of Tourane and Quin-nhon, or Binh-dinh, important ports open to European commerce. Saigon, the capital of the French colony, is composed of three towns:—1st, an Asiatic town, inhabited by Anamese husbandmen, fishers, or servants, by mercantile Chinamen, by Malays, Tagals, and Hindus engaged in various occupations; 2d, the town of the colonists; and 3d, the Government town, inhabited by the Government employés, administrators, officers, and physicians. The houses are mainly built of brick. Two gardens, one belonging to the governor and the other the botanical, overlook the town. The latter is very interesting, containing as it does a fine collection of trees and plants, both indigenous and exotic, as well as a very curious menagerie. At the port of Saigon 387 vessels entered and 398 left in 1874, which forms about half of the whole maritime trade in the colony. Eight miles from Saigon is the town of Cho-len (i.e., the great market), a Chinese town with an extensive commerce, and according to some writers 80,000, according to others 30,000 or 40,000 inhabitants. The other towns of the colony are Go-cong to the south-west of Saigon, where, in the midst of the rice fields, there lives an agricultural population which presents in all its purity the true Anamese type, Mt-thô, a port on one of the arms of Me-kong, and the second town of the colony; the fort and the town of Vinh-long; the fort and town of Chaudoc; Ha-tien, on the Gulf of Siam, one of the most unhealthy places on the coast,

inhabited by Chinese and Anamese; and at the Cape St. Jacques, the military port and fort of Ba-ria.

**Population.** It is difficult to state the exact number of the population of the empire of Anam, and authors vary greatly in their estimates. The data which appear most worthy of credit give a total sum of 10 or 12 millions. As to the French colony, the last official census of which the results have been published was made in 1873; it gives 1,487,200 inhabitants, of whom 49,500 were Chinese and 82,700 Cambodians. The Europeans numbered 1114, exclusive of the Government officials and the garrison.

**History.** The Anamese, according to their own annals, are natives of the south of China. "In the 2d or 3d century before Abraham," says Père Legrand de la Liraije, "four barbarous tribes occupied the limits of the Chinese empire; to the south was the tribe of the Giao-chi." It is from this tribe that the Anamese claim to have descended; and at the time when history begins to acquire some degree of certitude, about 2357 before our era, the Chinese annals mention the Anamese under the name of Giao-chi, which signifies "with the big toe." According to native scholars the history of this epoch is of a legendary character. It results from their labors that for twenty centuries the race of Giao-chi was governed in vassalage to the empire by a dynasty of Chinese origin, which lasted till 257 B.C. From that date till 110 before the Christian era the throne was held by two other vassal dynasties; and from 110 B.C. till 907 A.D. these dynasties were replaced by Chinese governors. In the beginning of the 10th century some of the native chiefs, weary of the Chinese rule, revolted; and their efforts were crowned with success. From 960 downwards, under the government of native princes, the Anamese lived independent, and preserved rather the name than the reality of vassalage to the Chinese empire. Since that time the nation, with a most remarkable aptitude for expansion, has aggrandized itself at the expense of its neighbors, and has conquered from the Cambodians Tsiampa and the six provinces of the south which now form the French colony. It is to be noted that the Cambodians, though endowed with physical force far superior to that of the Cochin Chinese, have been beaten by them in every encounter.

It is nearly a century since the first treaty of alliance was signed between France and the kingdom of Anam. By this treaty, dated the 28th November, 1787, the king of Cochin China ceded to France in full property the Peninsula of Tourane and the Isle of Pulo-Condore. The agreement was only partially executed, but it was sufficient to render the influence of France predominant in Cochin China; and Christianity made rapid progress in Tong-king. At the death of the king Gia-long, in 1820, the party hostile to strangers prevailed; and several attempts to protect the French missionaries and establish the French influence had failed, when in 1858, in consequence of the murder of M. Diaz,—who was put to death by order of the king, merely on account of the news that a French ship was cruising in sight of the coast,—a squadron was sent under the command of Admiral Rigault de Genouilly, who seized Tourane. Shortly after the admiral made explorations in the south, seeking a better situation for a settlement than Tourane, and passing up the River Don-naï, he took possession of Saigon, the true capital of Lower Cochin China. On the 5th June, 1862, the court of Hué accepted a treaty, by which it abandoned three provinces to France, and bound itself to pay an indemnity of war. After various expeditions occasioned by revolts, France occupied in 1867 the three other provinces of Lower Cochin China, and after long negotiations a treaty was signed at Saigon, on the 15th March, 1874, definitively abandoning the six provinces to France. This treaty opens besides to the commerce of all nations one port in eastern Cochin China and one port in Tong-king, and guarantees liberty of transit from the sea as far as Yun-nan.

**Bibliography.**—M. Barbié du Bocage, secretary of the Central Commission of the Geographical Society at Paris, published in 1867 a very complete bibliography of the books, periodicals, manuscripts, and plans relating to the history and geography of Anam, in a pamphlet of 105 pages, 8vo. In M. Vivien de Saint Martin's well-known work—*L'Année Géographique*, Hachette and Cie—there is to be found a list well up to date of new works on Indo-China, among which we may mention—Fr. von Richthofen, *Sur les Provinces Sud-ouest de la Chine*; MacMahon (Colonel A. P.), *Routes du Sud-ouest de la Chine*; *Edinburgh Review*, April, 1873; F. Vial, *Les premières années*

*de la Cochinchine*, 1874; Romanet du Caillaux, *La France au Tong King*; Aymonnier, *Dictionnaire français-cambodgien et Géographie du Cambodge*, 1876; G. Coryton, "On the Routes between British Burmah and the West of China," in vol. xix. of *Journ. R. G. S.*, 1849; Papers read by Docteur Mondières and Docteur A. Mories before the Société d'Anthropologie, in Jan., 1875; Dr. Harmand, *Aperçu pathologique sur la Cochinchine*; Bigrel, *Carte générale de la Cochinchine française*, with an interesting note on the proper names. The following recent works have not been mentioned in the *Année Géographique: Instructions nautiques publiées par le Ministère de la Marine; Tableaux de Population, de Culture, de Commerce, et de Navigation, publiées par le Ministère de la Marine; Petit cours de Géographie de la Basse Cochinchine*, by P. J. B. Truong-vinh-ky, Saigon, 1875; *Cours d'histoire annamite et l'usage des écoles de la Basse Cochinchine*, by Truong-vinh-ky, Saigon; *Voyage d'Exploration en Indo-Chine pendant les années 1866, 1867, 1868, sous le Commandement de M. Doudart de Lagrée, publié sous la direction de M. Francis Garnier*, 2 vols., Hachette, 1873—a magnificent work. The following are of earlier date: *Viaggi di Tre Vescevi in 1669*; Barrow, *A Voyage to Cochin China in the years 1792 and 1793*; Bissachère, *Etat actuel de Cochinchine*, 1812; Crawford's *Embassy to the Courts of Siam and Cochin China*, 1828; Gutzlaff "Geography of the Cochin Chinese Empire," in *Journ. Roy. Soc.*, 1849; Bouillevaux, *Voyage dans l'Indo-Chine*, 1848–56, Paris, 1858; Vuillot, *La Cochinchine et la Tonquin*, 1859; Cortambert and De Rosny, *Tableau de la Cochinchine*; Mouhot, *Siam, Cambodia, and Lao*, 1864. A *Dictionarium anamiticum, lusitanum, et latinum* was published at Rome in 1671 by Père Alex. de Rhode; and another, the combined work of Pigneux and Tabard, appeared in 1838. An essay on the language and writing was published by Schott in 1855. (C. M.A.)

COCHINEAL, a dye-stuff used for the production of scarlet, crimson, orange, and other tints, and for the preparation of lake and carmine. It consists of the females of *Coccus cacti*, an insect of the order *Hemiptera*, which feeds upon various species of the *Cactaceæ*, more especially the nopal plant, *Opuntia coccinellifera*, a native of Mexico and Peru. The dye was introduced into Europe from Mexico, where it had been in use long before the entrance of the Spaniards in the year 1518, and where it formed one of the staple tributes to the Crown for certain districts. In 1523 Cortes received instructions from the Spanish court to procure it in as large quantities as possible. It appears not to have been known in Italy so late as the year 1548, though the art of dyeing then flourished there. Cornelius van Drebbel, at Alkmaar, first employed cochineal for the production of scarlet in 1650. Until about 1725 the belief was very prevalent that cochineal was the seed of a plant, but Dr. Lister in 1672 conjectured it to be a kind of kermes, and in 1703 Leeuwenhoeck ascertained its true nature by aid of the microscope. Since its introduction cochineal has supplanted kermes (*Coccus ilicis*) over the greater part of Europe. The male of the cochineal insect is half the size of the female, and, unlike it, is devoid of nutritive apparatus; it has long white wings, and a body of a deep red color, terminated by two diverging setæ. The female is apterous, and has a dark-brown plano-convex body; it is found in the proportion of 150 to 200 to one of the male insect. The dead body of the mother insect serves as a protection for the eggs until they are hatched. Cochineal is now furnished not only by Mexico and Peru, but also by Algiers and the S. of Spain. In Teneriffe it was successfully cultivated in 1858, on the failure of the vines there through disease, but the diminished value of cochineal of late years has much affected its production in the Canaries. Cochineal is collected thrice in the seven months of the season. The insects are carefully brushed from the branches of the cactus into bags, and are then killed by immersion in hot water, or by exposure to the sun, steam, or the heat of an oven—much of the variety of appearance in the commercial article being caused by the mode of treatment. The dried insect has the form of irregular, fluted, and concave grains, which weigh about  $\frac{1}{10}$  of a grain, as many as 70,000 insects being estimated to weigh 1 lb. Cochineal has a musty and bitterish taste. There are two principal varieties—silver cochineal, which has a greyish-red color, and the furrows of the body covered with a white bloom or fine down, and black cochineal, which is of a dark reddish-brown, and destitute of bloom. Granilla is an inferior kind, gathered from uncultivated plants. The best crop is the first of the season, which consists of the unimpregnated females; the later crops contain an admixture of young insects and skins, which contain proportionally little coloring matter.

Cochineal owes its tinctorial power to the presence of a substance termed *cochinealin*, or *carminic acid*, a compound of hydrogen, carbon, and oxygen, which may be prepared from the aqueous decoction of cochineal. The comparative value of different specimens of cochineal may be ascertained by a method based upon the bleaching action of ferricyanide of potassium upon a weak potash solution of the dye. The black variety of cochineal is sometimes sold for silver cochineal by shaking it with powdered talc, or heavy-spar; but these adulterations can be readily detected by means of a lens. The duty on cochineal was repealed in 1845. In 1869 the exports of cochineal from the Canaries reached 6,310,000 lb, value £842,921. Of this amount 4,232,600 lb, consisting of *grana*, *granilla*, and *patro*, were shipped to Great Britain, value £554,092. More than half of this quantity was supplied by the Island of Grand Canary. In three months ending 31st March, 1876, the imports were 10,094 cwts., value £112,534.

For a monograph of the *Coccidæ*, including the cochineal insect, see Signoret, *Ann. Soc. Ent. France*, 1868-74. For accounts of the cochineal insect consult also—Theis, *ibid.*, v. p. 1; Burmeister, *Handbuch der Entomologie*; Vincent, *Ann. Sci. Nat.*, vol. viii., 1st ser.; Westwood, *Modern Classification of Insects*, pp. 448, 449. For a description of the cultivation of cochineal in Java, see Veth's *Woordenboek van Nederlandsch Indië—Cochinilla*. See also "Observations on the Making of Cochineal in Jamaica," in *Phil. Trans.*, 1691, pp. 502-3; and Royle's *Essay on the Productive Resources of India*, pp. 47-65, 1840.

COCKATOO (*Cacatuidæ*), a family of Scansorial Birds, distinguished from other Old World parrots by their greater size, by a crest of feathers on the head, which can be raised or depressed at will, and by their enormously developed bills. They inhabit the Indian Archipelago, New Guinea, and Australia, and are gregarious, frequenting woods and feeding on seeds, fruits, and the larvæ of insects. Their note is generally harsh and unmusical, and although they are readily tamed when taken young, becoming familiar, and in some species showing remarkable intelligence, their powers of vocal imitation are exceedingly limited. Of the true cockatoos (*Cacatua*) the best known is the Crested Cockatoo (*Cacatua galerita*), of a pure white plumage with the exception of the crest, which is deep sulphur yellow, and of the ear and tail coverts, which are slightly tinged with yellow. The crest when erect stands 5 inches high. These birds are found in Australia in flocks varying from 100 to 1000 in number, and do great damage to newly sown grain, for which reason they are mercilessly destroyed by farmers. They deposit their eggs—two in number, and of a pure white color—in the hollows of decayed trees, or in the fissures of rocks, according to the nature of the locality in which they reside. This is the species usually kept in Europe as a cage bird. Leadbetter's Cockatoo (*Cacatua Leadbeateri*), an inhabitant of South Australia, excels all others in the beauty of its plumage, which consists in great part of white, tinged with rose color, becoming a deep salmon color under the wings, while the crest is bright crimson at the base, with a yellow spot in the centre and white at the tip. It is exceedingly shy and difficult of approach, and its note is more plaintive while less harsh than that of the preceding species. In the cockatoos belonging to the genus *Calyptorhynchus* the general plumage is black or dark brown, usually with a large spot or band of red or yellow on the tail, and in some species behind the ear also. The largest of these is known as the Funereal Cockatoo (*Calyptorhynchus funereus*), from the lugubrious note or call which it utters, resembling the two syllables *W-y-la*—the native name of the species. It deposits its eggs in the hollows of the large gum trees of Australia, and feeds largely on the larvæ of insects, in search of which it peels off the bark of trees, and when thus employed it may be approached closely. "When one is shot, the remainder of the company," says Gould, "fly round for a short distance, and perch on the neighboring trees until the whole are brought down."

COCKATRICE, a fabulous monster, the existence of which was firmly believed in throughout ancient and mediæval times,—descriptions and figures of it appearing in the natural history works of such writers as Pliny and Aldrovandus, those of the latter published so late as the beginning of the 17th century. Produced from a cock's egg hatched by a serpent, it was believed to possess the most deadly powers, plants withering at its touch, and men and animals dying poisoned by its look. It stood in awe,

however, of the cock, the sound of whose crowing killed it, and consequently travellers were wont to take this bird with them in travelling over regions supposed to abound in cockatrices. The weasel alone among mammals was unaffected by the glance of its evil eye, and attacked it at all times successfully; for when wounded by the monster's teeth it found a ready remedy in rue—the only plant which the cockatrice could not wither. This myth reminds one of the real contests between the weasel-like mungoos of India and the deadly cobra, in which the latter is generally killed. The term "cockatrice" is employed on four occasions in the English translation of the Bible, in all of which it denotes nothing more than an exceedingly venomous reptile; it seems also to be synonymous with "Basilisk," the mythical king of serpents.

COCKBURN, MRS. ALISON (1712-1794), justly celebrated for having written one of the most exquisite of Scottish ballads, the "Flowers of the Forest,"<sup>1</sup> was the daughter of a border laird, Robert Rutherford of Fairnalea, and was born in the heart of the Southern Highlands in the autumn of 1712. Her education was slight. She spent her youth in rambling and riding about the countryside, and in paying visits to an aged minister in the neighborhood, of whose "heavenly affection" for her she wrote enthusiastically in after years. She was a graceful dancer, spent two winter seasons in Edinburgh, and was one of the Edinburgh belles of her time. Different causes have been assigned for the composition of the "Flowers of the Forest." Mr. Chambers states that it was written on the occasion of a great commercial disaster which ruined the fortunes of some Selkirkshire lairds. Her later biographers, however, think it more probable that it was written on the departure to London of a certain John Aikman, between whom and Alison there appears to have been an early attachment. In 1731 Alison Rutherford was married to Patrick Cockburn of Ormiston, one of a family of staunch Whigs and Presbyterians, and an advocate at the Scottish bar. After her marriage she knew all the intellectual and aristocratic celebrities of her day. In the memorable year 1745 she vented her Whiggism in a squib upon Prince Charlie, and narrowly escaped being taken by the Highland guard as she was driving through Edinburgh in the family coach of the Keiths of Ravelston, with the parody in her pocket. Mrs. Cockburn was an indefatigable letter-writer and a composer of parodies, squibs, toasts, and "character-sketches"—then a favorite form of composition—like other wits of her day; but the "Flowers of the Forest" is the only thing she wrote that possesses great literary merit. She survived her husband forty-one years, living to the age of eighty-two, and to the last she maintained her social popularity. At her house on Castle-hill, and afterwards in Crighton Street, she received many illustrious friends, among whom were Mackenzie, Robertson, Hume, Home, Monboddo, the Keiths of Ravelston, the Balcarres family, and Lady Anne Barnard, the authoress of "Auld Robin Gray." She was in Edinburgh when Dr. Johnson visited that city, towed thither by the triumphant Boswell. She saw and commented upon Burns's short, bright Edinburgh career. As a Rutherford she was a connection of Sir Walter Scott's mother, and was her intimate friend. Lockhart quotes an interesting letter written by Mrs. Cockburn in 1777, describing the precocious conduct of little Walter Scott, then scarcely six years old, during a visit which she paid to his mother. It was Mrs. Cockburn also who wrote the character-sketch of Scott's father, which, when it was given as a toast, was so true as to be immediately recognized. Scott himself spent pleasant evenings at Mrs. Cockburn's house when she was a very old lady and he a young advocate. Mrs. Cockburn died in 1794, having survived her only child, Captain Adam Cockburn, fourteen years.

COCKBURN, SIR GEORGE (1772-1853), admiral, was of Scottish extraction, and was born in London. He entered the navy in his ninth year. After serving on the home station, and in the East Indies and the Mediterr-

<sup>1</sup> There are two versions of this song,—the one by Mrs. Cockburn, the other by Miss Jean Elliot of Minto. Both were founded on the remains of an ancient Border ballad. It is believed by the descendants of her family that Mrs. Cockburn composed her version—that beginning "I've seen the smiling of fortune beguiling"—before her marriage in 1731. Anyhow, it was composed many years before Jean Elliot's sister verses, beginning, "I've heard them liting at our ewmilkling." These were written in 1766, and printed soon afterwards. Mrs. Cockburn's song, however, was not published until 1785, when Jean Elliot's was already popular.

mean, he assisted, as Captain of the "Minerve," at the blockade of Leghorn in 1796, and a year afterwards he fought in the battle of Cape St. Vincent. In 1809, in command of the naval force on shore, he contributed greatly to the reduction of Martinique, and signed the capitulation by which that island was handed over to the English; for his services on this occasion he received the thanks of the House of Commons. After service in the Scheldt and at the defence of Cadiz he was sent in 1811 on an unsuccessful mission for the reconciliation of Spain and her American colonies. He was made rear-admiral in 1812, and in 1813-14 he took a prominent part in the American war, especially at the battle of Bladensburg and the capture of Washington. Early in 1815 he received the Order of the Bath, and in the autumn of the same year he carried out, in the "Northumberland" the sentence of deportation to St. Helena which had been passed upon Bonaparte. In 1818 he received the Grand Cross of his Order, and was made a Lord of the Admiralty; and the same year he was returned to parliament for Portsmouth. He was promoted to the rank of vice-admiral in 1819, and to that of admiral in 1837; he became senior naval lord in 1841, and held office in that capacity till 1846. From 1827 he was a privy councillor. In 1851 he was made Admiral of the Fleet, and in 1852, a year before his death, his brother's baronetcy fell to him by inheritance. See O'Byrne, *Naval Biography*; James, *Naval History*; *Gentleman's Magazine* for 1853.

COCKBURN, HENRY DUNDAS (1779-1854), known as Lord Cockburn, was born in Edinburgh, October 26, 1779. He was educated at the High School and at the university of Edinburgh; and he was a member of the famous Speculative Society, to which Scott, Brougham, and Jeffrey belonged. He entered the faculty of advocates in the year 1800, and attached himself, not to the party of his relatives, who could have afforded him most valuable patronage, but to the Whig or Liberal party, and that at a time when it held out few inducements to men ambitious of success in life. On the accession of Earl Grey's ministry in 1830, he became Solicitor-General for Scotland. In 1834 he was raised to the bench, and on taking his seat as a judge in the Court of Session he adopted the title of Lord Cockburn. Cockburn's forensic style was remarkable for its clearness, pathos and simplicity; and his conversational powers were unrivalled among his contemporaries. The extent of his literary ability only became known after he had passed his seventieth year, on the publication of his biography of Lord Jeffrey, in 1852, and from the *Memorials of his Time*, which appeared posthumously in 1856. He died on the 26th of April, 1854, at his mansion of Bonaly, near Edinburgh.

COCKER, EDWARD, the reputed author of the famous *Arithmetick*, the popularity of which has added a phrase to the list of English proverbialisms, was born about 1632, and died between 1671 and 1675. He was an engraver, and also taught writing and arithmetic. He is credited with the authorship and execution of some fourteen sets of copy slips, one of which, *Daniel's Copy-Book*, engraved by Edward Cocker, *Philomath*, is preserved in the British Museum. Pepys, in his *Diary*, makes very favorable mention of Cocker, who appears to have displayed great skill in his art. *Cocker's Arithmetick*, the fifty-second edition of which appeared in 1748, and which has passed through some sixty editions in all, was not published during the life time of its reputed author, the first impression bearing date of 1678. The late Professor De Morgan in his *Arithmetical Books* (1847) adduces proofs, which may be held to be conclusive, that the work was a forgery of the editor and publisher, John Hawkins; and there appears to be no doubt that the *Decimal Arithmetic* (1684), and the *English Dictionary* (second edition, 1715), issued by Hawkins under Cocker's name, are forgeries also. De Morgan condemns the *Arithmetick* as a diffuse compilation from older and better works, and dates "a very great deterioration in elementary works on arithmetic" from the appearance of the book, which owed its celebrity far more to persistent puffing than to its merits. He pertinently adds,—“This same Edward Cocker must have had great reputation, since a bad book under his name pushed out the good ones.”

COCKERELL, CHARLES ROBERT (1788-1863), architect, was born in London. After a severe preliminary training in his profession, he visited and studied the great

architectural remains of Greece, Italy, and Asia Minor. At Ægina, Phigalia, and other places of interest, he conducted excavations on a large scale, enriching the British Museum with many fine fragments, and adding several valuable monographs to the literature of archaeology, the best of which is said to be that on the mausoleum of Halicarnassus. Elected in 1829 an associate of the Royal Academy, he became a member in 1836, and in 1839 he was appointed professor of architecture, his lectures in which capacity were so greatly esteemed as to be attended by all the students of the several arts professed within the school. On the death in 1837 of Soane, the distinguished architect of the Bank of England, Cockerell was appointed his successor, and successfully carried out the alterations that have been needed in that building. In addition to branch banks at Liverpool and Manchester he erected in 1840 the New Library at Cambridge, and in 1845 the university galleries at Oxford, the last one of the architect's least happy efforts, as well as the Sun and the Westminster Fire Offices in Bartholomew Lane and in the Strand; and Tite and he were joint architects of the London and Westminster Bank. On the death of Henry Lonsdale Elmes in 1847, Cockerell was selected to finish the St. George's Hall, Liverpool, a task which he executed with great success. Cockerell's best conceptions were those inspired by classic models; his essays in the Gothic—the college at Lampeter, for instance, and the chapel at Harrow—are by no means so successful. Among his numerous publications, however, may be mentioned those *On the Iconography of Wells Cathedral*, and *On the Sculptures of Lincoln and Exeter Cathedrals*, which prove his thorough knowledge of Gothic art as well as of Greek. His *Tribute to the Memory of Sir Christopher Wren* (1838) is a collection of the whole of Wren's works drawn to the same scale.

COCKERMOUTH, a parliamentary borough and market-town of England, in the county of Cumberland, 25 miles by rail from Carlisle, at the confluence of the Derwent and the Cocker, both of which are crossed by bridges in the immediate vicinity. The town is irregularly built, but is clean and well paved. It has remains of an old castle, built soon after the Conquest, a town-hall, a free grammar school, and a house of correction; and its manufactures include linen and woollen goods, thread, hosiery, hats, and paper. In the neighborhood are extensive coal mines, which give employment to nearly 2000 workmen. In 1871 the township had a population of 5115; the borough (which returns one member to parliament), with an area of 8467 acres, had 6936. Of the early occupation of the site of CockeremOUTH conclusive evidence is afforded by the relics discovered from time to time; directly north of the town is a tumulus called Toot's Hill; and at Pap Castle, about half a mile to the north-west, are the remains of a Roman camp. The barony or honor of CockeremOUTH was held shortly after the Conquest by Waltheof, lord of Allerdale, and has since passed through a long series of possessors, including the Umfravilles, Multens, Lucies, Percies, and Nevilles, down to the present Lord Leconfield. The town was captured in 1387 by the Scotch under Douglas; and in 1648 the castle, garrisoned for king Charles, was taken and dismantled by the Parliamentarians. Wordsworth the poet was born at CockeremOUTH in 1770; and Tickell, the friend of Addison, at the village of Bridekirk, about two miles to the north.

COCKLE (*Cardium*), a genus of Acephalous Mollusks belonging to the family *Cardiadae*, and comprising about 200 species, nearly a third of which are said to occur in the Indian Ocean, while only a few, but these exceedingly abundant in individuals, and widely distributed, are found in northern and temperate latitudes. The shells of cockles are highly convex, and almost invariably show a ridge-and-furrow sculpture, the ridges or ribs being often spiny, and the valves locking closely together. The animal inhabiting the shell is provided with a large, fleshy, and highly elastic foot, by means of which it can rapidly bury itself in the soft muddy sand which it frequents, reappearing above the surface with equal facility. In performing these leaps, for which it is remarkable, "the long taper foot," says Gosse, "is thrust to its utmost, and feels about for some resisting surface, a stone, for instance, which it no sooner feels than the hooked point is pressed stiffly against it, the whole foot, by muscular contraction, is made suddenly rigid, and the entire creature—mantle, siphons, foot, shell, and all—is jerked away in an uncouth manner." Many of the species are of considerable value as articles

of food, especially the Common Cockle (*Cardium edule*), gregarious everywhere in the sandy bays and estuaries around the British coast, from low-water mark to a few fathoms deep, and extending from Iceland to the Canaries, and as far east as the Caspian and Aral Seas, where it occurs in one of its varieties. The shell of the cockle is liable to considerable variation, getting thinner and more elongated posteriorly in sheltered situations and in muddy ground, more convex and thicker when exposed to rougher conditions. They vary also in size from 1 inch to 2½ inches in breadth. They occur in great abundance on several parts of the British coast, and in many places cockle-gathering gives employment to large numbers of people; thus at Penclawdd in Glamorganshire, the women and children are regularly employed in gathering and preparing cockles, which they afterwards dispose of in the Swansea market. At Starcross they have "cockle-gardens," where these mollusks are reared, and these are said to possess a better flavor than the ordinary cockle. Some species or other of *Cardium* is used for food by the maritime populations of almost every country in the world, and the dietetic value of these mollusks appears to have been equally appreciated in prehistoric times, as the shell-mounds or *kjokkenmøddings* of many countries abundantly testify. As cockle shells contain about 90 per cent. of carbonate of lime, they are calcined and used instead of common lime where the latter cannot readily be obtained.

**COCKROACH** (*Blattide*), a family of Orthopterous Insects, distinguished by their flattened bodies, long thread-like antennæ, and shining leathery integuments. Cockroaches are nocturnal creatures, secreting themselves in chinks and crevices about houses, issuing from their retreats when the lights are extinguished, and moving about with extraordinary rapidity in search of food. They are voracious and omnivorous, devouring, or at least damaging, whatever comes in their way, for all the species emit a disagreeable odor, which they communicate to whatever article of food or clothing they may touch. The Common Cockroach (*Blatta orientalis*) is not indigenous to Europe, but is believed to have been introduced from the Levant in the cargoes of trading vessels. The wings in the male are shorter than the body; in the female they are rudimentary. The eggs, which are 16 in number, are deposited in a leathery capsule fixed by a gum-like substance to the abdomen of the female, and thus carried about till the young are ready to escape, when the capsule becomes softened by the emission of a fluid substance. The larvae are perfectly white at first, although in other respects not unlike their parents, but they are not mature insects until after the sixth casting of the skin. The American Cockroach (*Blatta americana*) is larger than the former, and is not uncommon in European seaports trading with America, being conveyed in cargoes of grain and other food produce. The largest known species is the Drummer of the West Indies (*Blatta gigantea*), so called from the tapping noise it makes on wood, sufficient, when joined in by several individuals, as usually happens, to break the slumbers of a household. It is about 2 inches long, with wings 3 inches in expanse, and forms one of the most noisome and injurious of insect pests. The best mode of destroying cockroaches is, when the fire and lights are extinguished at night, to lay some treacle on a piece of wood afloat on a broad basin of water. This proves a temptation to the vermin too great to be resisted. The chinks and holes from which they issue should also be filled up with unslaked lime, and some may be scattered on the ground.

**COGLES, HORATIUS**, a Roman hero, who, with Spurius Lartius and Titus Herminius as sole companions, defended the Sublician bridge against Lars Porsena and the whole army of the Etruscans. While the three heroes kept back the enemy the Romans cut down the bridge behind. When it was almost ready to fall his comrades retreated, but Horatius waited till the work was complete, and Rome was saved. Then, despite the arrows of the enemy, he swam in safety to the opposite shore. A statue was erected in his honor, and he received as much land as he could plough round in a single day. According to another story, Horatius was alone in his heroism, and gave his life for his country. The former version is adopted by Lord Macaulay in his *Lays of Ancient Rome*.

**COCOA**, or more properly **CACAO**, is a valuable dietary substance yielded by the seeds of several small trees belonging to the genus *Theobroma*, of the natural order *Ser-*

*culiaceæ*. The whole genus, which comprises nine or ten species, belongs to the tropical parts of the American continent; and although the cocoa of commerce is probably the produce of more than one species, by far the greatest and most valuable portion is obtained from the *Theobroma Cacao* of Linneus. The generic name is derived from *θεός* (god) and *βρῶμα* (food), and was bestowed by Linneus as an indication of the high appreciation in which he held the beverage prepared from the seeds, which he considered to be a food fit for the gods.

The common cocoa tree is of low stature, seldom exceeding 16 or 18 feet in height, but it is taller in its native forests than it is in cultivated plantations. The leaves are large, smooth, and glossy, elliptic-oblong and acuminate in form, growing principally at the ends of branches, but sometimes springing directly from the main trunk. The flowers are small, and occur in numerous clusters on the main branches and the trunk, a very marked peculiarity which gives the matured fruit the appearance of being artificially attached to the tree. Generally only a single fruit is matured from each cluster of flowers. When ripe the fruit or "pod" is elliptical-ovoid in form, from 7 to 10 inches in length, and from 3 to 4½ inches in diameter. It has a hard, thick, leathery rind of a rich purplish yellow color, externally rough and marked with ten very distinct longitudinal ribs or elevations. The interior of the fruit has five cells, in each of which is a row of from 5 to 10 seeds embedded in a soft delicately pink acid pulp. Each fruit thus contains from 20 to 40 or more seeds, which constitute the raw cocoa or "cocoa beans" of commerce. The tree appears to have been originally a native of Mexico; but it can be cultivated in suitable situations within the 25th parallels of latitude. It, however, flourishes best within the 15th parallels, at elevations ranging from near the sea-level up to about 2000 feet in height. It is now cultivated in Mexico, Honduras, Guatemala, Nicaragua, Brazil, Peru, Ecuador, New Granada, Venezuela, Guiana, and most of the West Indian Islands. Its cultivation has also been attempted in other tropical regions of the globe; but the industry has hitherto not been developed on any considerable scale away from the American continent and the West Indian Islands.

For the successful cultivation of the cocoa tree a rich well-watered soil and a humid atmosphere, with freedom from cold winds and protection from violent storms, are necessary. As the young plants are extremely delicate and tender, they are reared in nursery grounds till they attain a height of from 15 to 18 inches, and after planting out they still require protection from the wind and sun, which is provided by growing "provisions" (food-yielding plants), and the coral-bean tree, *Erythrina Corallodendron*, among the young trees. The trees begin to bear in the fourth or fifth year, but they do not attain their full productive vigor till about their eighth year, and they ought to continue prolific for from thirty to forty years thereafter. As the trees carry buds, flowers, and fruit in all stages at the same time, ripe pods may be collected at any period of the year, but there are periodical harvests dependent on the suitability of the weather for collecting the fruit and curing the seeds. In Venezuela, where the famous Caracas cocoa is grown, the gathering takes place in June and December, these being the crop of St. John and the Christmas crop respectively. In gathering the workman is careful to cut down only fully ripened pods, which he adroitly accomplishes with a long pole armed with two prongs or a knife at its extremity. The pods are left in heaps on the ground for about twenty-four hours; they are then cut open, and the seeds are taken out, and carried in baskets to the place where they undergo the operation of sweating or curing. There the acid juice which accompanies the seeds is first drained off, after which they are placed in a sweating box, in which they are enclosed and allowed to ferment for some time, great care being taken to keep the temperature from rising too high. The fermenting process is, in some cases, effected by throwing the seeds into holes or trenches in the ground, and covering them with earth or clay. The seeds in this process, which is called claying, are occasionally stirred to keep the fermentation from proceeding too violently. The sweating is a process which requires the very greatest attention and experience, as on it to a great extent depend the flavor of the seeds and their fitness for preservation. The operation varies in duration according to the state of the weather, but a period of about two

days yields the best results. Thereafter the seeds are exposed to the sun for drying, and those of a fine quality should then assume a warm reddish tint, which characterizes beans of a superior quality.

The cocoa tree was cultivated, and its produce held in the highest esteem in Mexico and Peru previous to the discovery of the American continent by Columbus. Prescott, in his *Conquest of Peru*, says of the followers of Pizarro, that as they sailed along the Pacific coast they saw "hill-sides covered with the yellow maize and the potato, or checkered in the lower levels with blooming plantations of cacao." The same writer, referring to the use of cocoa in Mexico, says of the Emperor Montezuma that "he was exceedingly fond of it, to judge from the quantity, no less than 50 jars or pitchers being prepared for his own daily consumption; 2000 more were allowed for that of his household." "Traffic," he adds again, "was carried on partly by barter and partly by means of a regulated currency of different values. This consisted of transparent quills of gold dust, of bits of tin cut in the form of a T, and bags of cacao containing a specified number of grains."

A knowledge of this valuable article of food was first brought to Europe by Columbus, but some time elapsed ere its virtues were appreciated in the Old World. Spain was the first nation in which its use became common; and to this day cocoa is much more extensively consumed among the Spaniards than by any other European community. The earliest intimation of the introduction of cocoa into England is found in an announcement in the *Public Advertiser* of Tuesday, 16th June, 1657, notifying that "In Bishopgate Street, in Queen's Head Alley, at a Frenchman's house, is an excellent West India drink, called chocolate, to be sold, where you may have it ready at any time, and also unmade, at reasonable rates." About the beginning of the 18th century chocolate had become an exceedingly fashionable beverage, and the cocoa tree was a favorite sign and name for places of public refreshment. Cocoa and chocolate are frequently mentioned in contemporary literature, and among others Pope, in his *Rape of the Lock*, alludes to it; the negligent spirit, fixed like Ixion—

"In fumes of burning chocolate shall glow  
And tremble at the sea that froths below."

The high price at which it was retailed kept chocolate among the luxuries of the wealthy; and coffee, which had been introduced two or three years before chocolate, and tea, which came a year later, both soon far outstripped their rival beverage in public estimation.

Raw cocoas are distinguished in commerce by the name of the localities of their growth; and it is found that the produce of particular regions maintains, pretty constantly, a distinctive character and appearance. The most esteemed of all varieties is that obtained from Venezuela, known in commerce as Caracas cocoa, next to which in value stand the red "nuts" of Trinidad. The finest qualities are in form and size not unlike thick round almonds; they have a husk of a clear brick-red color, and the cotyledons, which are of a deep chocolate brown, have a fine membrane permeating their entire substance, and dividing them into numerous irregular segments, into which the seeds are easily broken down. The kernels are astringent in taste, with a mild, not disagreeable flavor. In chemical composition, as well as in physical characteristics, they vary within certain limits; but the analysis by Payen may be taken as representing their average constitution. It is as follows:—

Fat (Cocoa Butter).....	52.00
Nitrogenous compounds.....	20.00
Starch.....	10.00
Cellulose.....	2.00
Theobromine.....	2.00
Saline substances.....	4.00
Water.....	10.00
Cocoa red.....	} traces
Essential oil.....	
	100.00

The constituent upon which the peculiar value of cocoa depends is the theobromine, an alkaloid substance which till recently was supposed to be distinct from, though closely allied to, the theine of tea and coffee. It is now, however, known that the alkaloid in these and in two or three other substances similarly used is identical, and their physiological value is consequently the same. The fat or

cocoa butter is a firm, solid, white substance at ordinary temperatures, having an agreeable taste and odor, and very remarkable for its freedom from any tendency to become rancid. It consists essentially of stearin with a little olein, and is used in surgical practice, and in France as a material for soap and pomade manufacture. The starch grains present in raw cocoa are small in size, and of a character so peculiar that there is no difficulty in distinguishing them under the microscope from any other starch granules. As an article of food cocoa differs essentially from both tea and coffee. While only an infusion of these substances is used, leaving a large proportion of their total weight unconsumed, the entire substance of the cocoa seeds is prepared as an emulsion for drinking, and the whole is thus utilized within the system. While the contents of a cup of tea or coffee can thus only be regarded as stimulant in its effect, and almost entirely destitute of essential nutritive properties, a cup of prepared cocoa is really a most nourishing article of diet, as, in addition to the value of the theobromine it contains, it introduces into the system no inconsiderable proportion of valuable nitrogenous and oleaginous elements.

The manufacturing processes through which raw cocoa passes have for their object the development of the aroma



Branch of Cocoa Tree, with Fruit in section.

peculiar to the substance, and its preparation in a soluble, palatable, and digestible form. The first operation consists in roasting the seeds, whereby the empyreumatic aromatic substance is formed, and the starch particles are changed into dextrin. The roasting is accomplished in large revolving cylinders, after the completion of which the roasted seeds are taken to the crushing and winnowing machine. Here the seeds are reduced to the form of nibs, which are separated from the shells or husks by the action of a powerful fan blast. The nibs are next subjected to a process of winnowing in small quantities in hand sieves, by which the hard cocoa "germs" are sifted out, and mouldy or discolored fragments are at the same time removed by hand. Nibs so prepared constitute the simplest and purest preparation in which manufactured cocoa is sold; but they require prolonged boiling to effect their complete disintegration. The nibs when ground to a fine meal can be cooked with much greater facility. Another form in which the pure seeds are prepared is in flaked cocoa, which consists of the nibs ground up into a rather coarse uniform paste. The grinding is effected in cylinder machines, having an outer fixed casing within which a drum revolves. The nibs are fed in by a hopper on the upper part of the apparatus, and are carried round its circumference by the revolution of the drum, and delivered as a thin uniform pasty mass, the heat developed by the friction within the cylinder being sufficient to liquefy the oil,

which again sets on cooling of the paste. Of late years a preparation called extract of cocoa has come into extensive use. It is made by removing a certain proportion of the fat from the seeds, whereby the remaining substance can be ground to an impalpable powder, which yields a beverage much more palatable and agreeable to many stomachs than either entire nibs or the so-called soluble cocoas. The removal of the fat is effected by placing nibs, after they have been reduced by grinding to a fine smooth paste, in bags, and subjecting them to powerful pressure in heated presses. The fat exudes slowly and quickly solidifies, and a solid compact cake is left in the press, which only requires to be broken up and finely powdered for use.

Most other preparations, whether sold as cocoa or chocolate, are mixtures of various substances with ground nibs, the object of the mixture being to mask the presence of the cocoa fat, and to render the whole readily miscible with boiling water. The ordinary distinction between these soluble cocoas and chocolate is that the cocoa is usually sold in the form of a powder, the chocolate being made up in cakes, which require to be scraped down, boiled, and "milled" or frothed before being ready for drinking. In making the soluble cocoa, which is sold under such names as homoeopathic, Iceland moss, pearl cocoa, &c., the nibs are first ground up in a heated stone mill, and, while in a soft pasty condition, thoroughly mixed with certain proportions of sugar and arrowroot, or other and inferior starches. The compound is afterwards ground to fine powder and sold under various names and at different prices, according to the quality of the cocoa and the nature and proportion of the ingredients which are combined with it. The finer chocolates are combinations of cocoa with sugar alone, flavored with some aromatic substance, generally vanilla; but into the composition of cheap qualities starchy substances enter. The nibs for chocolate are brought to a fine pasty state in a heated mill, and the sugar or sugar and starch with vanilla are then added and thoroughly incorporated in the mill. The paste is next passed several times between heavy horizontal rollers to produce a thoroughly homogeneous mixture. It is lastly cast into moulds while still in a thin pasty state, and after cooling it forms hard solid cakes, and is ready to wrap up for the market. Chocolates for eating are prepared with large proportions of sugar and various flavoring substances, and the elegant preparations of these and of chocolate creams by Ménier of Paris and Fry and Sons of Bristol undoubtedly form most wholesome, palatable, and nutritious confections. To the last-named firm we have to express our obligation for information courteously placed at our disposal.

Preparations of cocoa are still much more largely consumed in Spain than in any other European country. In Great Britain the consumption, partly stimulated by the improvements effected in its manufacture, is steadily increasing, although as compared with the consumption of tea and coffee its employment is yet on a very restricted scale. The following figures exhibit the ratio of increase of cocoa entered for home consumption since 1820:—

1820	267,321 lb	1860	4,583,124 lb
1830	425,382	1870	6,943,102
1840	2,645,470	1874	8,863,646
1850	3,080,641	1875	9,973,926

In addition to these quantities of raw cocoa, a considerable quantity of prepared cocoa and chocolate is now imported from France. In 1820 the imports of manufactured cocoa only amounted to 14 lb, but in 1874, 91,466 lb were imported. An import duty of 1d. per lb on raw and 2d. per lb on manufactured cocoa is levied in Great Britain.

**COCOA-NUT PALM** (*Cocos nucifera*), sometimes, and perhaps more correctly, called the coco-nut palm, is a very beautiful and lofty palm-tree, growing to a height of from 60 to 100 feet, with a cylindrical stem which attains a thickness of 2 feet. The tree terminates in a crown of graceful waving pinnate leaves. The leaf, which may attain to 20 feet in length, consists of a strong mid-rib, whence numerous long acute leaflets spring, giving the whole the appearance of a gigantic feather. The flowers are arranged in branching spikes 5 or 6 feet long, enclosed in a tough spathe, and the fruits mature in bunches of from 10 to 20. The fruits when mature are oblong, and triangular in cross section, measuring from 12 to 18 inches in length and 6 to 8 inches in diameter. The fruit consists of a thick external husk or rind of a fibrous structure, within which is the

ordinary cocoa-nut of commerce. The nut has a very hard, woody shell, enclosing the nucleus or kernel, within which again is a milky liquid called cocoa-nut milk. The palm is so widely disseminated throughout tropical countries that it is impossible to distinguish its original habitat. It flourishes with equal vigor on the coast of the East Indies, throughout the tropical islands of the Pacific, and in the West Indies and tropical America. It, however, attains its greatest luxuriance and vigor on the sea shore, and it is most at home in the innumerable small islands of the Pacific seas, of the vegetation of which it is eminently characteristic. Its wide distribution, and its existence in even the smallest coral islets of the Pacific, have been favored by the peculiar triangular shape of the fruit, which dropping into the sea from trees growing on any shores would be carried by tides and currents to be cast up and to vegetate on distant coasts.

The cocoa-nut palm, being the most useful of its entire tribe to the natives of the regions in which it grows, and furnishing many valuable and important commercial products, is the subject of careful cultivation in many countries. On the Malabar and Coromandel coasts of India the trees grow in vast numbers; and in Ceylon, which is peculiarly well suited for their cultivation, it is estimated that twenty millions of the trees flourish. The wealth of a native in Ceylon is estimated by his property in cocoa-nut trees, and Sir J. Emerson Tennent notes a law case in a district court in which the subject in dispute was a claim to the 2520th part of ten of the precious palms. The cultivation of cocoa-nut plantations in Ceylon is thus described by Sir J. E. Tennent. "The first operation in cocoa-nut planting is the formation of a nursery, for which purpose the ripe nuts are placed in squares containing about 400 each; these are covered an inch deep with sand and sea-weed or soft mud from the beach, and watered daily till they germinate. The nuts put down in April are sufficiently grown to be planted out before the rains of September, and they are then set out in holes 3 feet deep and 20 to 30 feet apart. . . . Before putting in the young plant it is customary to bed the roots with soft mud and sea-weed, and for the first two years they must be watered and protected from the glare of the sun under shades made of the plaited fronds of the cocoa-nut palm, or the fan-like leaves of the palmyra." The palm begins to bear fruit from the fifth to the seventh year of its age, each stock carrying from 5 to 30 nuts, the tree maturing on an average 60 years yearly.

The uses to which the various parts of the cocoa-nut palm are applied in the regions of their growth are almost endless. The nuts supply no inconsiderable proportion of the food of the natives, and the milky juice enclosed within them forms a pleasant and refreshing drink. The juice drawn from the unexpanded flower spathes forms "toddy," which may be boiled down to sugar, or it is allowed to ferment and is distilled, when it yields a spirit which, in common with a like product from other sources, is known as "arrack." The trunk yields a timber (known in European commerce as porcupine wood) which is used for building, furniture, firewood, &c.; the leaves are plaited into cajan fans and baskets, and used for thatching the roofs of houses; the shell of the nut is employed as a water vessel; and the external husk or rind yields the coir fibre, with which are fabricated ropes, cordage, brushes, &c. The cocoa-nut palm also furnishes very important articles of external commerce, of which the principal is cocoa-nut oil. It is obtained by pressure or boiling from the kernels, which are first broken up into small pieces and dried in the sun, when they are known as copperah or copra. It is estimated that 1000 full-sized nuts will yield upwards of 500 lb of copra, from which 25 gallons of oil should be obtained. The oil is a white solid substance at ordinary temperatures, with a peculiar, rather disagreeable odor, from the volatile fatty acids it contains, and a mild taste. Under pressure it separates into a liquid and a solid portion, the latter, cocoa-stearin, being extensively used in the manufacture of candles. Cocoa-nut oil is also used in the manufacture of marine soap, which forms a lather with sea water. Coir is also an important article of commerce, being in large demand for the manufacture of coarse brushes, door mats, and woven coir matting for lobbies and passages. A considerable quantity of fresh nuts is imported, chiefly from the West Indies, and sold as a dainty among the poorer classes, or used in the preparation of a kind of confection.



**COCYTUS**, a tributary of the Acheron, a river of Thesprotia, which flows into the Ionian Sea. Its modern name is the Vuvo. The name is also applied, in classical mythology, to a tributary of the Acheron, a river in Hades. The etymology suggested is from *κωκυθες*, to wail.

**COD** (*Morhua vulgaris*), a well-known species of *Gadidae*, a family of Anacanthine Fishes, possessing, in common with the other members of the genus, three dorsal and two anal fins, and a single barbel at the chin. It is a widely distributed species, being found throughout the northern and temperate seas of Europe, Asia, and America, extending as far south as Gibraltar, but not entering the Mediterranean, and inhabits water from 25 to 50 fathoms deep, where it always feeds close to the bottom. It is exceedingly voracious, feeding on the smaller denizens of the ocean—fish, crustaceans, worms, and mollusks, and greedily taking almost any bait the fisherman chooses to employ. The cod spawns in February, and is exceedingly prolific, the roe of a single female having been known to contain upwards of eight millions of ova, and to form more than half the weight of the entire fish. Only a small proportion of these get fertilized, and still fewer ever emerge from the egg. The number of cod is still further reduced by the trade carried on in roe, large quantities of which are used in France as ground-bait in the sardine fishery, while it also forms an article of human food. The young are about an inch in length by the end of spring, but are not fit for the market till the second year, and it has been stated that they do not reach maturity, as shown by the power of reproduction, till the end of the third year. They usually measure about 3 feet in length, and weigh from 12 to 20 lb, but specimens have been taken from 50 to 70 lb in weight. As an article of food the cod-fish is in greatest perfection during the three months preceding Christmas. It is caught on all parts of the British and Irish coasts, but the Dogger Bank, and Rockall, off the Outer Hebrides, have been specially noted for their cod-fisheries. Until recently, the London market was in great part supplied from the former of these; but now the fishery is chiefly carried on along the coast of Norfolk and Suffolk, where great quantities of the fish are caught with hook and line, and conveyed to market alive in "well-boats" specially built for this traffic. Such boats have been in use since the beginning of the 18th century. The most important cod-fishery in the world is that which has been prosecuted for centuries on the Newfoundland banks, where it is not uncommon for a single fisherman to take over 500 of these fish in 10 or 11 hours. The fish have lately been decreasing in that well-worn locality, but that the yield is still enormous is seen from recently published returns, from which it appears that the quantity of cod obtained by the Canadian fishery alone in 1875 weighed over 51,000 tons, while in 1874 it reached 34,500 tons. These, salted and dried, are exported to all parts of the world, and form, when taken in connection with the enormous quantity of fresh cod consumed, a valuable addition to the food resources of the human race. The swimming bladder of this fish furnishes isinglass, little, if at all, inferior to that obtained from the sturgeon, while from the liver is obtained cod-liver oil, now largely used in medicine as a remedy in scrofulous complaints and pulmonary consumption. "The Norwegians," says Cuvier, "give cod heads with marine plants to their cows for the purpose of producing a greater proportion of milk. The vertebrae, the ribs, and the bones in general are given to their cattle by the Icelanders, and by the Kamtchatdales to their dogs. These same parts, properly dried, are also employed as fuel in the desolate steppes of the Icy Sea." At Port Logan in Wigtonshire cod-fish are kept in a large reservoir, scooped out of the solid rock by the action of the sea, egress from which is prevented by a barrier of stones, which does not prevent the free access of water. These cod are fed chiefly on mussels, and when the keeper approaches to feed them they may be seen rising to the surface in hundreds and eagerly seeking the edge. They have become comparatively tame and familiar. Frank Buckland, who some years ago visited the place, states that after a little while they allowed him to take hold of them, scratch them on the back, and play with them in various ways. Their flavor is considered superior to that of the cod taken in the open sea.

**COD-LIVER OIL** is an oil of great medicinal value, obtained from the liver of the common cod (*Morhua vul-*

*garis*), and also to some extent from the ling (*Lota mola*), the whiting (*Merlangus vulgaris*), the pollack (*Merlangus pollachius*), as well as other members of the *Gadidae*. The oil obtained from the livers differs in quality from a very pure pale-colored liquid to a dark evil-smelling product, according to the care exercised and the processes adopted for its extraction. The very dark-colored rank oils are used only for burning and lubricating, and in commerce are known as cod oil. The purer qualities, up to an oil having a brown sherry color, are alone used medicinally as cod-liver oil. Various methods of extracting the oil are adopted in the different countries where its preparation is prosecuted. Generally it may be stated that the medicinal oil is obtained from selected livers, which are carefully examined, cleaned, split up, and thrown together into a large vessel. From these a very small proportion of a pure and almost colorless oil exudes spontaneously, and exposure to the heat of the sun causes a further exudation. By the application of heat in a steam or water bath to a temperature not exceeding 180° Fahr., a proportion of still pale or straw-colored oil is obtained. The oil which results from the application of a higher heat and pressure, and that obtained from unhealthy and from putrid livers, are only used industrially as cod-oil. The extraction of the oil is most extensively prosecuted in Newfoundland and in Norway, but a considerable quantity is also prepared in the Shetland Islands and along the east coast of Scotland.

Three varieties of medicinal oil are recognized in commerce—pale, light-brown, and brown; but these insensibly merge into each other, and are only the result of different processes or periods of preparation, as mentioned above. The pale oil possesses a fishy odor and a slightly acid taste, while the darker oil there is a distinctly disagreeable empyreumatic odor and taste. In composition the oil contains olein and margarin, with small proportions of free butyric and acetic acids, a peculiar principle termed gaduin, certain bile acids, free phosphorus, phosphatic salts, and traces of iodine and bromine. Cod-liver oil is valuable in medicine on account of its great nutrient properties; it adds rapidly to the store of fat within the human frame, and it enriches the blood in red corpuscles. It is much more digestible than other animal oils, a fact which may account for its superior therapeutic value. At one time it was supposed that its virtues resided in the iodine and bromine which the oil generally contains; but these are present only in exceedingly minute proportions, and sometimes they cannot be traced at all. The oil has long been favorably known in medicine as a remedy for rheumatic complaints, but its great value in pulmonary consumption has been demonstrated only in comparatively recent times. It is administered internally in chronic rheumatism, scrofula, phthisis, chronic skin diseases, and general debility; and it is sometimes externally applied in affections of the skin. The oil is taken with facility by young children, but the repugnance of adults to its taste and its eructations is not easily overcome, and many methods have been suggested for masking its taste. With that view the oil is enclosed in gelatinous capsules, or prepared in the form of aromatized emulsions, of equal parts of mucilage, of gum tragacanth, and the oil. There are numerous other forms of emulsions recommended, as well as combinations with medicinal syrups, and cod-liver oil creams, jellies, and bread; and various devices are familiarly employed as in the administration of unpleasant medicines. Failing all these, cod-liver oil has been introduced into the system by injection.

**CODE.** A code is a complete and systematic body of law, or a complete and exclusive statement of some portion of the law. Such at least is the sense in which the word is used when it is proposed to recast the laws of a country like England in the form of a code. Many collections of laws, however, which are commonly known as codes, would not correspond to this definition. The Code of Justinian, the most celebrated of all, is not in itself a complete and exclusive system of law. It is a collection of imperial constitutions, just as the Pandects are a collection of the opinions of juriconsults. The Code and the Pandects together being, as Austin says, "digests of Roman law in force at the time of their conception," would, if properly arranged, constitute a code. Codification in this sense is merely a question of the *form* of the laws, and has nothing to do with their goodness or bad-

ness from an ethical or political point of view. Sometimes codification only means the changing of unwritten into written law; in the stricter sense it means the changing of unwritten or badly written law into law well written.

*Roman Codes.*—Under the empire the *constitutiones* or *edicta* of the chief of the state had the force of law. The practice of collecting the constitutions of the emperors seems to have been begun by private lawyers—such at all events is the character of the oldest collection, known as the *Codex Gregorianus et Hermogenianus*, which formed the model for the imperial codes of Theodosius and Justinian. The Theodosian code was the work of a commission of sixteen, to whom, in 435 A.D., the emperor intrusted the task of collecting the edicts and constitutions from the time of Constantine. It was finished in 438, and promulgated as the law of the empire.

In 528 the Emperor Justinian ordered a new collection to be made, and appointed a commission of ten for that purpose, including the celebrated Tribonian. The commissioners were to compile one code out of the "three codes—Gregorian, Hermogenian, and Theodosian," and the constitutions which had been ordained since the last of these were confirmed. The commissioners had full power to make such changes as might be necessary in the language of the constitutions, and to omit all that was unnecessary, obsolete, or inconsistent. The collection was to include rescripts as well as constitutions, and was to supersede (as the Theodosian code also did) the sources from which it had been compiled. The code was finished within fourteen months, but a revised edition was rendered necessary by some new decisions and constitutions of the emperor. In 534 the new code was published and the first edition superseded. The second is the Code we now possess; the first has been lost. The Code is divided into twelve books, and each book into titles, under which the constitutions are arranged in chronological order, and with the names of the emperors by whom they were enacted. There is a general correspondence between the order of the Digest and the Code of Justinian, but neither the Digest nor any of the codes pretended to scientific classification. The arrangement was dictated by the order of writers on the Pretorian Edict.

The same causes which made these collections necessary in the time of Justinian have led to similar undertakings among modern peoples. The actual condition of laws until the period when they are consciously remodelled is one of confusion, contradiction, repetition, and disorder; and to these evils the progress of society adds the burden of perpetually increasing legislation. Some attempt must be made to simplify the task of learning the laws by improving their expression and arrangement. This is by no means an easy task in any country, but in our own it is surrounded with peculiar difficulties. The independent character of English law has prevented us from attempting what has already been done for other systems which have the basis of the Roman law to fall back upon.

The most celebrated modern code is the *Code Napoléon*. The necessity of a code in France was mainly caused by the immense number of separate systems of jurisprudence existing in that country before 1789, justifying Voltaire's sarcasm that a traveller in France had to change laws about as often as he changed horses. The conception of a general code for the whole country had occurred to jurists and statesmen before Napoleon, and the Convention, in fact, discussed two projects presented by Cambacérès, one of which had been found too complicated and the other too condensed. Napoleon, on becoming consul, appointed a commission headed by M. Tronchet to review previous efforts and present a new project. In four months the project was presented to the Government, submitted to the judges, and discussed by the Council of State—Napoleon himself taking part in the deliberations. At first published under the title of *Code Civil des Français*, it was afterwards entitled the *Code Napoléon*,—the emperor wishing to attach his name to a work which he regarded as the greatest glory of his reign. The Code Napoléon consists of 2281 articles, arranged under titles and divided into three books, preceded by a preliminary title. The subjects of the different books are—1st, "Des personnes;" 2d, "Des biens et des différents modifications de la propriété;" 3d, "Des différents manières d'acquérir la propriété." The code, it has been said, is the product of Roman and customary law,

together with the ordinances of the kings and the laws of the Revolution. In form it has passed through several changes caused by the political vicissitudes of the country, and it has of course suffered from time to time important alterations in substance, but it still remains virtually the same in principle as it left the hands of its framers. The code has produced a vast number of commentaries, among which may be named those of Duranton, Troplong, and Demolombe. The remaining French codes are the *Code de procédure civile*, the *Code de commerce*, the *Code d'instruction criminelle*, and the *Code pénal*. The merits of the French code have entered into the discussion on the general question of codification. Austin agrees with Savigny in condemning the ignorance and haste with which it was compiled. "It contains," says Austin, "no definitions of technical terms (even the most leading), no exposition of the *rationale* of distinctions (even the most leading), no exposition of the broad principles and rules to which the narrower provisions expressed in the code are subordinate; hence its fallacious brevity." The French codes have, however, taken firm root in most of the countries of continental Europe. Introduced by French conquest they nevertheless were eagerly adopted by the people after the French arms had withdrawn. The Penal Code, for example, was thus established in Italy, Sicily, Holland, Belgium, the Rhine Provinces, Poland, and Switzerland. The principles of the French code prevail in most of the Latin races.

The Prussian code (*Code Frédéric*) was published by Frederick the Great in 1751. It was intended to take the place of "Roman, common Saxon, and other foreign subsidiary laws and statutes," the provincial laws remaining in force as before. One of the objects of the king was to destroy the power of the advocates, whom he hoped to render useless. The Italian civil code, published in 1866, on the establishment of Italian unity, is founded mainly on the French code. The object of all these codes was to frame a common system to take the place of several systems of law, rather than to restate in an exact and exhaustive form the whole laws of a nation, which is the problem of English codification. The French and Prussian codes, although they have been of great service in simplifying the law, have failed to prevent outside themselves that accumulation of judiciary and statute law which in England has been the chief motive for codification. A more exact parallel to the English problem may be found in the *Code of the State of New York*. The revised constitution of the State, as adopted in 1846, "ordered the appointment of two commissions, one to reduce into a written and a systematic code the whole body of the law of the State, and the other to revise, reform, simplify, and abridge the rules and practice, pleadings, &c., of the courts of record." By an Act of 1847, the State Legislature declared that the body of substantive law should be contained in three codes—the Political, the Civil, and the Penal. The works of both commissions, completed in 1866, now fill six volumes, containing the Code of Civil Procedure (including the law of evidence), the Book of Forms, the Code of Criminal Procedure, the Political Code, the Penal Code, and the Civil Code. In the introduction to the Civil Code it is claimed that in many departments of the law the codes have "provided for every possible case, so that when a new case arises it is better that it should be provided for by new legislation." The New York code is defective in the important points of definition and arrangement. Much interest has attached to the Penal Code drawn up by Edward Livingston for the State of Louisiana, about 50 years ago. The system consists of a Code of Crime and Punishment, a Code of Procedure, a Code of Evidence, a Code of Reform and Prison Discipline, and a Book of Definitions. "Though the State for which the codes were prepared," says Chief-Justice Chase, "neglected to avail itself of the labors assigned and solicited by itself, they have proved, together with their introductions, a treasure of suggestions to which many States are indebted for useful legislation." A complete edition of Livingston's works has recently been published by the National Prison Association of the United States.

Since the time of Bentham, the codification of the law of England has been the dream of our most enlightened jurists and statesmen. In the interval between Bentham and our own time there has been an immense advance in the scientific study of law, but it may be doubted whether

the problem of codification is at all nearer solution. Interest has mainly been directed of late to the historical side of legal science, to the phenomena of the evolution of laws as part of the development of society, and from this point of view the question of remodelling the law is one of minor interest. To Bentham the problem presented itself in the simplest and most direct form possible. What he proposed to do was to set forth a body of laws, clearly expressed, arranged in the order of their logical connection, exhibiting their own *rationalis*, and excluding all other law. On the other hand the problem has in some respects become easier since the time of Bentham. With the Benthamite codification the conception of reform in the substantive law is more or less mixed up. If codification had been possible in his day, it would, unless it had been accompanied by the searching reforms which have been effected since, and mainly through his influence, perhaps have been more of an evil than a good. The mere dread that, under the guise of codification or improvement in form, some change in substance may secretly be effected has long been a practical obstacle in the way of legal reform. But the law has now been brought into a state of which it may be said that, if it is not the best in all respects that might be desired, it is, at least in most respects, as good as the conditions of legislation will permit it to be. Codification, in fact, may now be treated purely as a question of form. What is proposed is that the law, being, as we assume, in substance what the nation wishes it to be, should be made as accessible as possible, and as intelligible as possible. These two essential conditions of a sound system of law are, we need hardly say, far from being fulfilled in England. The law of the land is embodied in thousands of statutes and tens of thousands of reports. It is expressed in language which has never been fixed by a controlling authority, and which has swayed about with every change of time, place, and circumstance. It has no definitions, no rational distinctions, no connection of parts. Until the passing of the Judicature Act it was pervaded throughout its entire sphere by the flagrant antinomy of law and equity, and that Act has only ordered, not executed, its consolidation. No lawyer pretends to know more than a fragment of it. Few practical questions can be answered by a lawyer without a search into numberless Acts of Parliament and reported cases. To laymen, of course, the whole law is a sealed book. As there are no authoritative general principles, it happens that the few legal maxims known to the public, being apprehended out of relation to their authorities, are as often likely to be wrong as to be right. It is hopeless to think of making it possible for every man to be his own lawyer, but we can at least try to make it possible for a lawyer to know the whole law. The earlier advocates of codification founded their case mainly on the evils of judiciary law, i.e., the law contained in the reported decisions of the judges. Bentham's bitter antipathy to judicial legislation is well known. Austin's thirty-ninth lecture (*Lectures*, ed. 1869) contains an exhaustive criticism of the tenable objections to judiciary law. All such law is embedded in decisions on particular cases, from which it must be extracted by a tedious and difficult process of induction. Being created for particular cases it is necessarily uncomprehensive, imperfect, uncertain, and bulky. These are evils which are incident to the nature of judiciary laws. Of late years the defective form of our existing statute law has also given rise to loud complaints. Year by year the mass of legislation grows larger, and as long as the basis of a system is judiciary law, it is impossible that the new statutes can be completely integrated therewith. The prevailing mode of framing Acts of Parliament, and especially the practice of legislating by reference to previous Acts, likewise produce much uncertainty and disorder.

Whether any attempt will ever be made to supersede this vast and unarranged mass by a complete code seems very doubtful. Writers on codification have for the most part insisted that the work should be undertaken as a whole, and that the parts should have relation to some general scheme of the law which should be settled first. The practical difficulties in the way of an undertaking so stupendous as the codification *in toto* of the whole mass of the law hardly require to be stated. The probability is that attempts will be made from time to time to cast the leading portions of the law into the form of a code. Some years ago it was believed that the proper preliminary to a

code would be a digest of the law, and a commission was appointed in 1866, under which draughtsmen were set to work to prepare specimen digests of three selected portions of law. The attempt was abandoned in 1872, the commissioners being of opinion that it could not be properly proceeded with in detail, and they recommended that a general digest should be undertaken.

In discussions on codification two difficulties are insisted on by its opponents, which have some practical interest—(1) What is to be done in those cases for which the code has not provided? and (2) How is new law to be incorporated with the code? The objection that a code will hamper the opinions of the court, destroy the flexibility and elasticity of the common law, etc., disappears when it is stated in the form of a proposition, that law codified will cover a smaller number of cases, or will be less easily adapted to new cases, than law uncoded. The *Code Napoléon* orders the judges, under a penalty, to give a decision on all cases, whether contemplated or not by the code, and refer them generally to the following sources:—(1) *Equité naturelle, loi naturelle*; (2) Roman law; (3) ancient customs; (4) usages, examples, decisions, jurisprudence; (5) *droit commun*; (6) *principes généraux, maximes, doctrine, science*. The Prussian code, on the other hand, requires the judges to report new cases to the head of the judicial department, and they are decided by the legislative commission. No provision was made in either case for incorporating the new law with the code, an omission which Austin justly considers fatal to the usefulness of codification. It is absurd to suppose that any code can remain long without requiring substantial arbitration. Cases will arise when its meaning must be extended and modified by judges, and every year will produce its quota of new legislation by the state. The courts should be left to interpret a code as they now interpret statutes, and provision should be made for the continual revision of the code, so that the new law created by judges or directly by the state may from time to time be worked into the code. The process of gradual codification adopted in India has been recommended for imitation in England by those who have had some experience of its working. The first of the Indian codes was the Penal Code drawn up by Macaulay, and presented to the Governor-general in 1837. It did not become law, however, till 1860. It has been highly praised, and its merit is the more remarkable as Macaulay had only a slight professional acquaintance with the law before he went to India. A code of Civil Procedure became law in 1759, and was followed by a code of Penal Procedure in 1861. The substantial law was then undertaken which published its first instalment in 1865. The use of illustrations is a peculiar feature of the Indian code.

(E. R.)

CODOGNO, a town of Italy, in the province of Milan, and district of Lodi, with a station at the junction of the railway from Milan to Piacenza with that between Cremona and Pavia, about 20 miles from the last-named city. In the parish church is an Ascension of the Virgin, the best painting of Callista Piazza, an artist of the 16th century. The town is chiefly important as the centre of a large trade in Parmesan cheese; and it also carries on the manufacture of silk. Population upwards of 11,000.

CODRINGTON, SIR EDWARD (1770-1851), admiral, belonged to an old Gloucestershire family. He entered the navy in 1783. In 1794 he served as lieutenant on board Howe's flagship in the actions off Brest, and was sent home with despatches announcing the result. In 1805 he received the command of the "Orion," a seventy-four, in which he fought at Trafalgar, receiving a gold medal for his conduct in the action. In 1808 he was gazetted to the "Blake," another seventy-four, in command of which he shared in the Walcheren expedition, assisting in the forcing of the Scheldt in 1809. During the next three years he was on active service off the Spanish coast. In 1813 he sailed for North America, where he was made rear-admiral and captain of the fleet. Returning to England at the close of the war, he received a Knight Commandership of the Bath in 1815; and six years afterwards (1821) he was gazetted vice-admiral. In 1826 he was appointed to the command-in-chief of the Mediterranean squadron of eleven sail sent to restrain Ibrahim Pasha from operating against the Greeks, and sailed in the "Asia" for the Morea. Here he was joined by the French and Russian contingents, of five and eight sail respectively, under Admirals de Rigny

and Heiden, who were put under his orders. A literal interpretation of instructions led to the battle of Navarino, in which the Turkish and Egyptian fleets, of 36 sail, with a cloud of gunboats, schooners, and craft of all sorts, were almost entirely destroyed. For his share in this action Codrington received a Grand Cross of the Bath; but the steps which led to it occasioned considerable dissatisfaction in England, and he was recalled in 1828. He was returned to Parliament for Devonport in 1832 in the Liberal interest, and was re-elected in 1835 and 1837. In the latter year he was gazetted admiral. He accepted the Chiltern Hundreds in 1839, on his appointment as commander-in-chief at Portsmouth, and his three years' tenure of that office concluded his public life. He died in London, April 23, 1851. A memoir of Codrington, by his daughter, Lady Bouchier, appeared in 1873, and an abridgment of the larger work in 1875.

CODRUS, the hero of an early Athenian legend, was the last king of Athens, and belongs to the 11th century B.C. According to the story, it was prophesied that the Dorians would conquer Attica if they spared the life of the Attic king. Devoting himself to his country, Codrus, in disguise, provoked a quarrel with some Dorian soldiers. He fell, and the Dorians retreated homeward. To so noble a patriot no one was thought worthy to succeed; and the title of king was thenceforth abolished, that of archon taking its place.

COEHORN, MENEBO, BARON VAN (1641-1704), "the Dutch Vauban," was of Swedish extraction, and was born at Leeuwarden, in Friesland. He served in the campaign of 1667 against Turenne, and later distinguished himself at the sieges of Maastricht (1673) and Graave (1674), and at the battles of Senef (1674), Cassel (1677), and St. Denis (1678). The genius of Vauban had made a fine art of the attack and defence of fortified places, and Coehorn, who had already invented the mortar, had imposed on himself the task of meeting and beating that fine engineer on his own ground. But William of Orange did not recognize the abilities of his young captain, and in despair of success Coehorn had determined to transfer his services to France. William, hearing of this, seized the person of the engineer, and by a mixture of force and persuasion obliged him to renounce his design, and to accept a colonelcy in the Dutch service, with the command of two of the Nassau-Friesland battalions. The peace secured by the Treaty of Nimeguen (1678) gave Coehorn his first great opportunity. He repaired and perfected the defences of many strong places, and he rushed into polemics with a rival engineer, a certain Paen. His criticism and rejoinder appeared at Leeuwarden in 1682 and 1683, and in 1685 he gave to the world, in Dutch, his first great work, *The New System of Fortification* (Leeuwarden, folio), two French editions of which appeared in 1706, while three others were issued from the Hague in 1711, 1714, and 1741 respectively. From 1688 to 1691 Coehorn's genius and activity answered the innumerable demands that were made upon them. In 1692 Vauban himself laid siege to Namur, and Coehorn waited within the city. The town was reduced in a week; but the castle in its quintuple enceinte, manned by Coehorn and his own regiment, seemed impregnable. The Dutch chief, however, was severely wounded, and the castle capitulated, with the honors of war, eight days after the city. The campaign of 1695 brought his revenge. He reduced the city, on which Vauban in the meanwhile had expended all the resources of his art, and the castle fell a month afterwards. The Peace of Ryswick (1697) sent Coehorn back to his task of repairing and improving. He laid out the entrenchments round Zwoil and Groningen, and built the fortifications round Nimeguen, Breda, Namur, and Bergen-op-Zoom. In 1701, however, the war of the Spanish succession broke out, and Coehorn went at once to the front. By the siege and capture in succession of Venloo, Stevensworth, Buremond, and Liège, he rendered the allies masters in a single campaign of the line of the Meuse from Holland to Huy. He followed up these exploits by the investment and reduction of Bonn (1703), and passing thence into Flanders, with Sparr, he forced the French lines in the Waes, between the sea and the left bank of the Scheldt. Returning to the centre of operations on the Meuse, he besieged and took Huy in the same year, under the very eyes of Villeroi. Thence he went to the Hague to confer with Marlborough concerning the next campaign, and was there cut off by apoplexy, March 17, 1704. A

monument to him was raised by his children at Wykel, and an historical eulogy of him was published at Frankfurt in 1771. For a description and critical estimate of the engineering theories of Coehorn, see Marini, *Biblioteca di Fortificazione* (1810), and Bonomer, *Essai général de Fortification* (1814).

COELENTERA, or less correctly, COELENTERATA, the name of a group of animals, including the classes Hydrozoa, Anthozoa, and Ctenophora. (The two last-mentioned classes are by Huxley and a few others placed in a single class, Actinozoa.) The reader will consult the articles on ACTINOZOA, CORALS, and HYDROZOA, with that on the ANIMAL KINGDOM, for the more important details touching the structure, classification, and affinities of coelenterate animals.

According to Van Beneden, R. Leuckart, and some others, the sponges also have their place among Coelentera, — a view which has of late years received much support in consequence of the profounder study of the calcareous<sup>1</sup> sponges begun by Miklucho-Maclay and diligently followed up by Haeckel. There is much to be said in favor of regarding the sponges as an aberrant (and, at the same time, degraded) coelenterate class, but, for the present, it will be well to treat them as a group apart.

It is usual to consider the Coelentera (with or without the sponges) as a primary group, or sub-kingdom, of animals; and a high authority has stated that the institution of this group has been the greatest improvement in the arrangement of the animal kingdom effected since the time of Cuvier. But, should we so interpret the results of certain recent embryological inquiries as to throw the Coelentera into one great division along with all the higher invertebrates, such a mode of treatment would reduce Coelentera to the rank of a province.

Name.—The word Coelentera (or rather its German equivalent) first occurs on page 38 of *Beiträge zur Kenntnis wirbelloser Thiere*, von Frey und Leuckart, Braunschweig (Vieweg), 1847.<sup>2</sup>

Here it should be mentioned that Burmeister (*Zoologische Briefe*, Zweiter Theil, p. 279) has given the same name to a very different group of animals. He denotes by it the majority of the nematoid worms, placing in a separate section (Amorphocœla) Gordius and its allies, whose alimentary canal is more or less atrophied. In this sense Coelentera is nearly equivalent to Coelomintbes of Cuvier.

Coelentera is derived from *κοίλος* (hollow) and *έντερον* (intestine or viscus).

Definition.—Allowing for the difficulty of expressing modern scientific concepts by compounds formed from words in common use, the meaning of which needs to be somewhat stretched, this etymology guides us to the definition of the Coelentera as animals having a conspicuous alimentary canal, which, with its prolongations, occupies the whole interior of the body,<sup>3</sup> and does the work of a vascular as well as of a digestive system. It is not true to add, however, that the Coelentera are invariably destitute of cavities comparable (morphologically) to the blood vessels, perivisceral spaces, and other serous passages of the higher animals. Such cavities, hitherto usually overlooked, undoubtedly exist in some cases, as appears from the investigations of Metschnikoff,<sup>4</sup> Eilhard Schulze,<sup>5</sup> and others.

The wall of the body in the Coelentera has the same fundamental composition as among the higher animals, and exhibits various degrees of differentiation.<sup>6</sup> Inner and outer layers of epithelial tissue, splinted by connective tissue (in close relation with which we usually find muscular fibres), are always developed.

<sup>1</sup> See *Die Kalkschwämme*, von Ernst Haeckel, Berlin (Reimer), 1872.  
<sup>2</sup> See further another work by Leuckart, *Ueber die Morphologie und die Verwandtschaftsverhältnisse der wirbellosten Thiere*, *ibid.*, 1848; and the valuable "Bericht" contributed by the same writer to the *Archiv für Naturgeschichte* from that date to the present; also his university programme, entitled *De Zoophytorum et historia et dignitate systematica*, Lipsiæ, 1878.

<sup>3</sup> The doubts suggested on this point by R. Leuckart (*Bericht f. 1868-9*, p. 183), in opposition to the views of Noëchin, Semper, and Kowalewsky, may now at length be regarded as set at rest by the appearance of the last-named writer's recent *Memoir on the Development of the Coelentera*. This indispensable work has unfortunately been printed in the Russian language, but the reader may consult its figures, in conjunction with the excellent German abstract, by Hoyer, in the second vol. of the *Jahresberichte* of Hofmann and Schwalbe.

<sup>4</sup> "Studien über die Entwicklung der Medusen und Siphonophoren," in *Zeitschr. f. Wiss. Zool.*, xxiv, Band, p. 78.

<sup>5</sup> *Über den Bau von Siphonophore Sarsii*, Leipzig (Engelmann), 1878.  
<sup>6</sup> Almost the only comprehensive details on this subject which we possess are contained in the Russian memoir by Kowalewsky, already referred to.

Neither the absence of nervous tissues nor the presence of those curious microscopic organs known as thread-cells can henceforth be enumerated among the characters common to and distinctive of Coelentera. Though a nervous system remains to be discovered in many, it certainly exists in some; and in yet other cases, where anatomical evidence is wanting, its presence may reasonably be conjectured from purely physiological data.

Most, if not all, Coelentera have thread-cells; but these exist likewise in other organisms, notably in certain mollusks which were formerly supposed to derive them from the coelenterate animals on which they preyed.

The plant-like aspect of many Coelentera arises in two ways. In the simple (not compound) coelenterates, such as most sea-anemones, the tentacles or prehensile appendages are so arranged as to simulate, when not too closely inspected, the petals of ordinary flowers (particularly flowers with numerous narrow petals, e.g., *Mesembryanthemum*) or the strap-shaped corollas of composite plants, like dahlias. In the compound species buds and branches are formed, marking changes in direction of growth; and hence those wonderful phytoid aggregates which for so many centuries puzzled naturalists.

*Affinities.*—The nearest relations of Coelentera are undoubtedly the Echinoderms, whose remarkable vascular system is developed from one or more rudiments primarily formed as diverticula of the alimentary canal. The Coelentera exhibit, even more perfectly than the echinoderms, a radiated arrangement of their parts, and, to a lesser degree, have this primitive disposition controlled by a superinduced bilateral symmetry. On the other hand the affinities of coelenterates to worms, save through the echinoderms, are very obscure.<sup>1</sup>

Of animals inferior to the Coelentera in complexity of structure their nearest reputed allies are the Infusoria. We are not yet able, however, to demonstrate the existence of any relationship of this kind, in spite of all that has been urged in its favor by Claparède, Greef, and other eminent anatomists. (J. E. G.)

COELLO, ALONSO SANCHEZ (1515-1590), painter, according to some authorities a native of Portugal, was born, according to others, at Benifacio, near the city of Valencia. He studied many years in Italy; and returning to Spain in 1541 he settled at Madrid, and worked on religious themes for most of the palaces and larger churches. He was a follower of Titian, and, like him, excelled in portraits and single figures, elaborating the textures of his armor, draperies, and such accessories in a manner so masterly as strongly to influence Velasquez in his treatment of like objects. Many of his pictures were destroyed in the fires that consumed the Madrid and Prado palaces, but many good examples are yet extant, among which may be noted the portraits of the Infantes Carlos and Isabella, now in the Madrid gallery, and the St. Sebastian painted in the church of San Gerónimo, also in Madrid. Coello left a daughter, Isabella Sanchez, who studied under him, and painted excellent portraits.

COEN, JAN PIETERSZON (1587-1630), the founder of Batavia, was born at Hoorn, and was sent when a youth to Rome to be instructed in the principles of commerce. In 1607 he went to India, but returned some four years afterwards, and in 1612 was sent out a second time, with the command of two ships. He acquitted himself so well of his commission, and made himself so remarkable by the brilliance and success of his practice of commerce, that in 1613 he was named director-general of the Indian trade. In 1617 he was made president at Bantam; and in 1619, having taken and destroyed Jacatra, he founded on its ruins the city of Batavia, which he forthwith proclaimed the capital of the Dutch East Indies. In 1622 Coen revisited Europe, but five years afterwards he returned to Java. In 1629 the Javanese emperor attempted to dislodge the interlopers, and laid siege to Batavia; but Coen beat off all his attacks. He died the following year.

CENOBITES (from *κοινός*, common, and *βίος*, life), a religious order living in a convent, or in community,—in opposition to the anchorites or hermits who live in solitude. See MONASTICISM.

CŒUR, JACQUES, founder of the trade between France

and the Levant, was born at Bourges, near the close of the 14th century. His father, Pierre Cœur, was one of the richest peltry merchants of the flourishing city of Bourges; and we hear first of Jacques in 1418, when he married Macée de Léodepart, daughter of an influential citizen, afterwards provost, a quondam valet of John of Berry. About 1429 he formed a commercial partnership with two brothers named Godard; and in 1432 he is heard of at Damascus, buying and bartering, and transporting Levantine ware (gall-nuts, wools and silks, goats' hair, brocades, and carpets) to the interior of France by way of Narbonne. In the same year he established himself at Montpellier, and there commenced those gigantic operations which have made him illustrious among financiers of all time. Details are absolutely wanting; but it is certain that in a few years he placed his country in a position to contend not unsuccessfully with the great trading republics of Italy and Catalonia, and acquired such reputation as to be able, mere trader as he was, to render material assistance to the Order of Rhodes and to Venice herself.

In 1436 Cœur was summoned to Paris by Charles VII., and made master of the mint that had been established in that city. The post was of vast importance, and the duties were onerous in proportion. The country was deluged with the base moneys of three reigns, charged with superscriptions both French and English; and Charles had determined on a sweeping reform. In this design he was ably seconded by the great merchant, who, in fact, inspired or prepared all the ordinances concerning the coinage of France issued between 1435 and 1451. In 1438 he was made steward of the royal expenditure; and in 1440 he and his family were ennobled by letters patent. In 1444 he was sent as one of the royal commissioners to preside over the new parliament of Languedoc—a dignity he bore through successive years till the day of his disgrace. In 1445 his agents in the East negotiated a treaty between the Sultan of Egypt and the Knights of Rhodes; and in 1447, at his instance, Jean de Village, his nephew by marriage, was charged with a mission to Egypt. The results of this communication were most important; concessions were obtained which greatly improved the position of the French consuls in the Levant, and that influence in the East was thereby founded which, though often interrupted, was for several centuries a chief commercial glory of France. In the same year Cœur assisted in an embassy to the counts of Savoy; and in 1448 he represented the French king at the court of Nicholas V., who treated him with utmost distinction, lodged him in the Papal palace, and gave him a special license to traffic with the Infidels. From about this time he made large advances to Charles for carrying on his wars; and in 1449, after fighting at the king's side through the campaign, he entered Rouen in his train.

At this moment the great trader's glory was at its height. He had represented France in three embassies, and had supplied the sinews of that war which had ousted the English from Normandy. He was invested with various offices of dignity, and possessed the most colossal fortune that had ever been amassed by a private Frenchman. The sea was covered with his ships; he had 300 factors in his employ, and houses of business in all chief cities of France. He had built hotels and chapels and had founded colleges in Paris, at Montpellier, at Bourges. Dealing in all things—money and arms, peltry and jewels, brocades and woollens, broking, banking, farming—he had absorbed the trade of the country, and merchants complained they could make no gains on account of "that Jacquet." Soon, however, he was a broken man and a fugitive. Charles was surrounded with the enemies of the merchant; he was "unstable as water," and he was always needy. Jacques Cœur had to go the way of others who had been the friends and favorites of the king.

In February, 1449, Agnes Sorel, the mistress of Charles, died of puerperal fever. It was maintained, however, that the Dauphin Louis had procured her death; and some considerable time after her death, Jacques Cœur, who had been named one of her executors, was accused formally of having poisoned her. There was not even a pretext for such a charge, but for these and other alleged crimes, the king, on the 31st of July, 1451, gave orders for the arrest of Jacques Cœur and for the seizure of his goods, reserving to himself a large sum for the war in Guienne. Commissioners extraordinary, the merchant's declared enemies, were chosen to conduct the trial, and an inquiry commenced, the judges

<sup>1</sup> On the mutual relations of these groups, consult the concluding part of an essay by A. Goette—"Vergleichende Entwickelungsgeschichte der Comatula mediterranea," in *Archiv für Mikroskopische Anatomie*, xii. Band, 1876.

in which were either the prisoner's debtors or the holders of his forfeited estates. He was accused of having paid French gold and ingots to the Infidels, of coining light money, of kidnapping oarsmen for his galleys, of sending back a Christian slave who had taken sanctuary on board one of his ships, and of committing frauds and exactions in Languedoc to the king's prejudice. He defended himself with all the energy of his nature. His innocence was manifest, but a conviction was necessary, and in spite of strenuous efforts on the part of his friends, after twenty-two months of confinement in five prisons, he was condemned to do public penance for his fault, to pay the king a sum equal to about £1,000,000 of modern money, and to remain a prisoner till full satisfaction had been obtained; his sentence also embraced confiscation of all his property, and exile during royal pleasure. On June 5, 1453, the sentence took effect; at Poitou the shameful form of making honorable amends was gone through; and for nearly three years nothing is known of him. It is probable that he remained in prison; it is certain that his vast possessions were distributed among the intimates of Charles.

In 1455, Jacques Cœur, wherever confined, contrived to escape into Provence. He was pursued; but a party headed by Jean de Village and two of his old factors, carried him off to Tarascon, whence, by way of Marseilles, Nice, and Pisa, he managed to reach Rome. He was honorably and joyfully received by Nicholas V., who was fitting out an expedition against the Turks. On the death of Nicholas, Calixtus III. continued his work, and named his guest captain of a fleet of sixteen galleys sent to the relief of Rhodes and the Archipelago. He set out on this expedition, but was taken ill at Chios, and died there November 25, 1456. He was buried on the island, but his place of sepulchre is not known. The stain was not removed from his honor till the reign of Louis XI., when, at the instance of Geoffroy Cœur, the great merchant's name was finally rehabilitated.

See the admirable monograph of Pierre Clément—*Jacques Cœur et Charles Sept*, 1858; Michelet and Martin's histories: Vallet de Vireville, *Charles Sept et son Epoque*, 3 vols. 1862-1865; Bonamy, *Mémoires sur les Dernières années de la vie de Jacques Cœur*; Trouvé, *Jacques Cœur*, 1840; Louis Raynal, *Histoire du Berry*, vol. iii.; Louisa Costello, *Jacques Cœur, the French Argonaut*, London, 1847.

**COFFEE** (French *Café*; German *Kaffee*). This important and valuable article of food is the produce chiefly



FIG. 1.—Branch of *Coffea arabica*.

of *Coffea arabica*, a Rubiaceous plant indigenous to Abyssinia, which, however, as cultivated originally, spread out-

wards from the southern parts of Arabia. The name is probably derived from the Arabic K'hawah, although by some it has been traced to Caffa, a province in Abyssinia, in which the tree grows wild. In the genus *Coffea*, to which the common coffee tree belongs, from 50 to 60 species were formerly enumerated, scattered throughout the tropical parts of both hemispheres; but by referring the American plants to a different genus, the list is now restricted to about 22 species. Of these 7 belong geographically to Asia; and of the 15 African species 11 are found on the west coast, 2 in Central and East Africa, and 2 are natives of Mauritius. Besides being found wild in Abyssinia, the common coffee plant appears to be widely disseminated in Africa, having been seen on the shores of the Victoria Nyanza and in Angola on the west coast. Within the last year or two considerable attention has been devoted to a West African species, *C. liberica*, belonging to the Liberian coast, with a view to its extensive introduction and cultivation. Its produce, obtained from native plants, has been several years in the English market.

The common coffee shrub or tree is an evergreen plant, which under natural conditions grows to a height of from 18 to 20 feet, with oblong-ovate, acuminate, smooth, and shining leaves, measuring about 6 inches in length by 2½ wide. Its flowers, which are produced in dense clusters in the axils of the leaves, have a five-toothed calyx, a tubular five-parted corolla, five stamens, and a single bifid style. The flowers are pure white in color, with a rich fragrant odor, and the plants in blossom have a lovely and attractive appearance, but the bloom is very evanescent. The fruit is a fleshy berry, having the appearance and size of a small cherry, and as it ripens it assumes a dark red color. Each fruit contains two seeds embedded in a yellowish pulp, and the seeds are enclosed in a thin membranous endocarp (the parchment). The seeds which constitute the raw coffee of commerce are plano-convex in form, the flat surfaces which are laid against each other within the berry having a longitudinal furrow or groove. They are of a soft, semi-translucent, bluish or greenish color, hard and tough in texture. The regions found to be best adapted for the cultivation of coffee are well-watered mountain slopes at an elevation ranging from 1000 to 4000 feet above sea-level, in latitudes lying between 15° N. and 15° S., although it is successfully cultivated from 25° N. to 30° S. of the equator in situations where the temperature does not fall beneath 55° Fahr. The Liberian coffee plant, *C. liberica*, which has been brought forward as a rival to the ordinarily-cultivated species, is described as a large-leaved and large-fruited plant of a robust and hardy constitution. The seeds yield a highly aromatic and fine-flavored coffee; and so prolific is the plant that a single tree is said to have yielded the enormous quantity of 16 lb weight at one gathering. It is a tree, moreover, which grows at low altitudes, and it probably would flourish in many situations which have been proved to be unsuitable for the Arabian coffee. Should it come up to the sanguine expectations of Ceylon planters and others to whom it has been submitted, there is no doubt that it will prove a formidable rival to the species which has hitherto received the exclusive attention of planters. It grows wild in great abundance along the whole of the Guinea coast.

The early history of coffee as an economic product is involved in considerable obscurity, the absence of historical fact being compensated for by an unusual profusion of conjectural statements and by purely mythical stories. According to a statement contained in a manuscript belonging to the Bibliothèque Nationale in Paris, the use of coffee was known at a period so remote as 875 A.D., or exactly 1000 years ago. In a treatise published in 1566 by an Arab sheikh it is stated that a knowledge of coffee was first brought from Abyssinia into Arabia about the beginning of the 15th century by a learned and pious Sheikh Djemal-eddin-Ebn-Abou-Elfagger. According to the treatise alluded to the use of coffee as a beverage was prevalent among the Abyssinians from the most remote period, and in Arabia the beverage when first introduced only supplanted a preparation from the leaves of the *Celastrus edulis*. Its peculiar property of dissipating drowsiness and preventing sleep was taken advantage of in connection with the prolonged religious services of the Mahometans, and its use as a devotional antisoporific stirred up a fierce opposition on the part of the strictly orthodox and conservative section of the priests. Coffee was by them held to

be an intoxicant beverage, and therefore prohibited by the Koran; and the dreadful penalties of an outraged sacred law were held over the heads of all who became addicted to its use. Notwithstanding the threats of divine retribution, and though all manner of devices were adopted to check its growth, the coffee-drinking habit spread rapidly among the Arabian Mahometans, and the growth of coffee as well as its use as a national beverage became as inseparably associated with Arabia as tea is with China. For about two centuries the entire supply of the world, which, however, was then limited, was obtained from the province of Yemen in South Arabia, where the celebrated Mocha or Mokha is still cultivated.

The knowledge of and taste for coffee spread but slowly outwards from Arabia Felix, and it was not till the middle of the 16th century that coffee-houses were established in Constantinople. Here also the new habit excited considerable commotion among the ecclesiastical public. The popularity of the coffee-houses had a depressing influence on the attendance at the mosques, and on that account a fierce hostility was excited among the religious orders against the new beverage. They laid their grievances before the sultan, who imposed a heavy tax upon the coffee-houses, notwithstanding which they flourished and extended. After the lapse of another hundred years coffee reached Great Britain, a coffee-house having been opened in 1652 in London by a Greek, Pasqua Rossie. Rossie came from Smyrna with Mr. D. Edwards, a Turkey merchant, and in the capacity of servant he prepared coffee daily for Mr. Edwards and his visitors. So popular did the new drink become with Mr. Edwards's friends that their visits occasioned him great inconvenience, to obviate which he directed Rossie to establish a public coffee-house, which he accordingly did. The original establishment was in St. Michael's Alley, Cornhill, over the door of which Rossie erected a sign with his portrait, subsequently announcing himself to be "the first who made and publicly sold coffee drink in England." It is remarkable that the introduction of coffee into England encountered the same hostility that it was fated to meet in other countries. Charles II., in 1675, attempted to suppress coffee-houses by a royal proclamation, in which it was stated that they were the resort of disaffected persons "who devised and spread abroad divers false, malicious, and scandalous reports, to the defamation of His Majesty's Government, and to the disturbance of the peace and quiet of the nation." On the opinion of legal officials being taken as to the legality of this step, an oracular deliverance was given to the effect "that the retailing of coffee might be an innocent trade, but as it was used to nourish sedition, spread lies, and scandalize great men, it might also be a common nuisance." In England as well as in other countries the most effective check on the consumption of coffee was found to be a heavy tax, which, while restricting honest trade, opened a channel for extensive smuggling operations. Coffee is spoken of as being in use in France between 1640 and 1660, and thereafter it may be said that the use of coffee was an established custom in Europe. It is noteworthy that the three principal dietetic beverages of the world were introduced into Great Britain within a few years of each other. Cocoa was the first of the three which actually appeared in Europe, having been brought to Spain from South America; coffee followed, coming from Arabia by way of Constantinople; and tea, the latest of the series, came from China by the hands of the Dutch.

Down to 1690 the only source of coffee supply was Arabia, but in that year Governor-General Van Hoorne of the Dutch East Indies received a few coffee seeds by traders who plied between the Arabian Gulf and Java. These seeds he planted in a garden at Batavia, where they grew and flourished so abundantly that the culture, on an extended scale, was immediately commenced in Java. One of the first plants grown in that island was sent to Holland as a present to the governor of the Dutch East India Company. It was planted in the Botanic Garden at Amsterdam, and young plants grown from its seeds were sent to Surinam, where the cultivation was established in 1718. Ten years later the plant was introduced in the West Indian Islands, and gradually the culture extended throughout the New World, till now the progeny of the single plant sent from Java to Holland produces more coffee than is grown by all the other plants in the world. The cultivation is now general throughout all civilized regions of the tropical world.

In point of quantity Brazil heads the list of coffee-growing countries, its annual produce probably exceeding that of all other localities combined. It is calculated that no less than 530,000,000 coffee trees are at present flourishing throughout that empire. During the Brazilian financial year ending 1872, more than 2,000,000 bags, each containing 160 lb, were exported from Brazil; and the United States alone absorb upwards of 200,000,000 lb of Brazilian coffee annually. The other principal American localities for coffee-growing are Costa Rica, Guatemala, Venezuela, Guiana, Peru, and Bolivia, with Jamaica, Cuba, Porto Rico, and the West Indian Islands generally. In the East the principal coffee regions, following Brazil in amount, but much superior in the quality of their produce, are Java and Ceylon. The annual produce of Java reaches to about 130,000,000 lb; and from Ceylon about 100,000,000 lb is annually exported. The culture of coffee is an important and rapidly growing feature in Southern India, and it is also prosecuted in Sumatra, Réunion, Mauritius, and Southern Arabia, and on the west coast of Africa. The present total annual production of the world has been estimated to amount to not less than 1,000,000,000 lb. At the beginning of the 18th century, while Arabia was still the only source of supply, probably not more than 7,500,000 lb was yearly exported from that country; the consumption of Europe in 1820 was stated by A. Von Humboldt at about 140,000,000 lb, while 300,000,000 lb probably represented the quantity used throughout the world. The yearly consumption in Great Britain has for about 30 years been drooping in the face of a rapidly increasing population and consuming capacity, while the quantity absorbed by other countries has increased with extraordinary rapidity. The whole amount entered for home consumption in 1790 was 973,110 lb; and an increase in the duty charged caused the consumption to drop in 1796 to 396,953 lb. A reduction in the duty caused the consumption in 1808 to shoot up suddenly from 1,069,691 lb in that year to 9,251,837 lb in 1809. The quantity consumed never again mounted so high till in 1825 it was affected by another reduction of duty, and 10,760,112 lb was retained for the home market. Thereafter the consumption rapidly and steadily increased, reaching 22,669,253 lb in 1830, 28,664,341 lb in 1840, and in 1847 coming to its maximum of 37,441,373 lb, from which point it again declined. In 1857 the consumption had fallen to 34,352,123 lb; in 1867 it was 31,567,760; and in 1869 it fell so low as 29,109,113 lb. The total imports for the year 1874 amounted to 157,351,376 lb, but of this only 31,859,408 lb were retained for home consumption. The chief cause of the declining popularity of coffee in Great Britain is doubtless to be found in the extraordinary hold which its rival beverage—tea—has taken on the community; but something of the falling off is also attributable to the extent to which coffee was for a long period made the subject of adulteration and sophistication. Indeed for some years, between 1840 and 1852, much of what was sold under the name of coffee was actually chicory, a root which at that period was cultivated and manufactured duty free, while coffee was subject to a heavy import duty.

The different estimation in which coffee is held in various countries is well brought out in the following estimate of the consumption per head calculated from the official returns for 1873:—

	Total imports of Coffee for consumption.	Average per head.
France.....	98,635,000 lb	2-73 lb
Belgium.....	49,771,000	13-48
Switzerland.....	18,779,500	7-03
Russia, European.....	14,740,920	0-19
Sweden.....	26,555,213	6-11
Norway.....	17,636,080	9-80
Denmark.....	26,035,652	13-89
Holland.....	72,395,800	21-00
Hamburg (Germany).....	178,715,936	
Austria (1871).....	76,876,576	2-18
Greece.....	2,131,367	1-42
Italy (1871).....	28,511,560	1-00
United Kingdom.....	32,330,928	1-00
United States.....	293,293,833	7-61

The commercial distinctions as established in the British market relate—first, to qualities, as "fine," "middling," "ordinary," "low" and "triage," the last being broken and damaged seeds; and secondly, to localities of production.

Shape, size, and color of seeds are the principal elements

which determine the commercial value of coffee. Shape, according to Mr. W. P. Hiern (in a communication to the Linnean Society, April 20, 1876), is related to the particular part of the plant upon which the seed grows; size and succulence correspond with the nature of the locality of growth; and color has reference to the degree of maturity attained by the fruit at the time of gathering. The highly prized variety known as peaberry is the result of the coalescence of the two seeds within the fruit, thus producing the appearance of a single rounded seed, usually of small size, whence the name. Regarding the famous Mocha or "Mokha" coffee of Arabia, Mr. W. G. Palgrave has the following remarks:—

"The best coffee, let cavillers say what they will, is that of Yemen, commonly entitled 'Mokha,' from the main port of exportation. Now, I should be sorry to incur a lawsuit for libel or defamation from our wholesale or retail tradesmen; but were the particle *not* prefixed to the countless labels in London shop windows, that bear the name of the Red Sea haven, they would have a more truly import than what at present they convey. Very little, so little indeed as to be quite unappreciable, of the Mokha or Yemen berry ever finds its way westward of Constantinople. Arabia itself, Syria, and Egypt consume fully two-thirds, and the remainder is almost exclusively absorbed by Turkish and Armenian esophagi. Nor do these last get for their share the best or the purest. Before reaching the harbors of Alexandria, Jaffa, Beyrout, etc., for further exportation, the northern bales have been, while yet on their way, sifted and resifted, grain by grain, and whatever they may have contained of the hard, rounded, half-transparent, greenish-brown berry, the only one really worth roasting and pounding, has been carefully picked out by experienced fingers; and it is the less generous residue of flattened, opaque, and whitish grains which alone, or almost alone, goes on board the shipping. So constant is this selecting process that a gradation, regular as the degrees in a map, may be observed in the quality of Mokha, that is, Yemen coffee, even within the limits of Arabia itself, in proportion as one approaches to or recedes from Wadi Nejrân and the neighborhood of Mecca, the first stages of the radiating mart."

The "Mocha" of the English market is principally the produce of India, but a good deal of American coffee is also passed into consumption under that abused name.

The conditions most favorable for coffee planting are found in hilly situations, where the ground is at once friable, well drained, and enriched by the washing down of new soil from above by the frequent rains. The seeds are first sown in a nursery, and the young plants when they are a few inches high are planted out in the permanent plantation at distances from each other of from 6 to 8 feet. The operation of planting is one which requires great



FIG. 2.—Microscopic structure of Coffee.

care, and much labor must be expended on drainage, weeding, and cleaning the plantation, and in pruning or "handling" the plants. Chiefly for convenience of securing the crop, the trees are rarely allowed to exceed from 4 to 6 feet in height, and being so pruned down they extend their branches laterally in a vigorous manner. The plants begin bearing in their second year, and by the third year they should yield a fairly remunerative crop. The berries are ready for picking when they have assumed a dark-red color and the skin shrivels up. Immediately after the berries are gathered they are conveyed to the storehouse, where they undergo the operation of pulping; and on some

hill estates in Ceylon, having suitable situation and water supply, the gathered berries are carried by a water run through galvanized pipes to the store. The pulping is performed in an apparatus having two roughened cylinders which move in opposite directions. Between these the berries are carried forward with a flow of water, and the seeds are deprived of their surrounding pulp, being left invested in the skin or parchment. In this condition they are spread out to dry, and as soon as practicable they are freed from the husk or parchment by passing them between heavy wooden rollers and winnowing away the broken husks. The shelled coffee is then sized by passing it down a tube perforated throughout its length with holes of regularly increasing diameter, and the various sizes are next hand-picked to free them from defective or malformed seeds; the coffee is then ready to pack for export. A tree in good bearing will yield from 1½ to 2 lb of berries in a year; but its fertility depends largely upon conditions of climate, situation, and soil. Generally trees planted in lofty dry situations and in light soils yield small berries, which give a rich aromatic coffee, while in low, flat, moist climates a more abundant yield of a large-sized berry is obtained. The greater weight of the coarser qualities of coffee more than makes up for the smaller price obtained for them as against the higher cost of the finer growths; and therefore quality is too often sacrificed to quantity.

The cultivation of coffee is attended with many risks and much anxiety. In Ceylon, where British capital and enterprise have hitherto found their principal scope, the estates are exposed to the attacks of a most mischievous and destructive rodent, the coffee or Golunda rat. A species of insect called the coffee bug, *Lecanium coffea*, is a still more formidable and alarming pest with which planters have to contend. Of recent years prominent attention has been drawn to two diseased conditions arising in Singapore and Indian plantations by fungus growths. The first, called the coffee-leaf disease, appeared in Ceylon in 1869, and in Mysore a year later. The fungus in this case, *Hemileia vastatrix*, is endophytous, growing within the substance of the leaf, and while no effective cure has been discovered for it, it is not yet clear that it seriously affects the quality or amount of coffee yielded by the plants. The second, known as the coffee-rot, on the other hand, works great havoc in the Mysore plantations, in which it has been observed, being especially hurtful in wet seasons. This fungus has been examined by Mr. M. C. Cooke, who names it *Pellicularia kolerota*, and describes the affected leaves as being covered with a slimy gelatinous film, under which the leaves become black and quickly drop off, as do also the clusters of coffee berries.

Raw coffee seeds are tough and horny in structure, and are devoid of the peculiar aroma and taste which are so characteristic of the roasted seeds. In minute structure coffee is so distinct from all other vegetable substances that it is readily recognized by means of the microscope, and as roasting does not destroy its distinguishing peculiarities, microscopic examination forms the readiest means of determining the genuineness of any sample. The substance of the seed, according to Dr. Hassall, consists "of an assemblage of vesicles or cells of an angular form, which adhere so firmly together that they break up into pieces rather than separate into distinct and perfect cells. The cavities of the cells include, in the form of little drops, a considerable quantity of aromatic volatile oil, on the presence of which the fragrance and many of the active principles of the berry depend" (see fig. 2). The testa or investing membrane of the seeds has a layer of long cells with a peculiar pitted structure. In chemical composition the seeds are complex, and they contain variable proportions of proximate principles. The following represents the average constitution of raw coffee according to the analysis of M. Payen:—

Cellulose .....	34
Water .....	12
Fat .....	10 to 13
Glucose, dextrin, and organic acid.....	15-5
Legumin and casein.....	10
Other nitrogenous substances.....	3
Caffeine.....	0-8
Caffetannate of caffeine and potassium..	3-5 to 5-0
Viscid essential oil (insoluble in water)..	0-001
Aromatic oils (some lighter, some heavier, than water).....	0-002
Ash.....	0-7



The physiological and dietetic value of coffee depends principally upon the alkaloid caffeine which it contains, in common with tea, cocoa, maté or Paraguay tea, guarana, and the African kola nut. Its commercial value is, however, determined by the amount of the aromatic oil, caffeine, which develops in it by the process of roasting. By prolonged keeping it is found that the richness of any seeds in this peculiar oil is increased, and with increased aroma the coffee also yields a blander and more mellow beverage. Stored coffee loses weight at first with great rapidity, as much as 8 per cent. having been found to dissipate in the first year of keeping, 5 per cent. in the second, and 2 per cent. in the third; but such loss of weight is more than compensated by improvement in quality and consequent enhancement of value.

In the process of roasting, coffee-seeds swell up by the liberation of gases within their substance,—their weight decreasing in proportion to the extent to which the operation is carried. Roasting also develops with the aromatic caffeine above alluded to a bitter soluble principle, and it liberates a portion of the caffeine from its combination with caffeotannic acid. Roasting is an operation of the greatest nicety, and one, moreover, of a crucial nature, for equally by insufficient and by excessive roasting much of the aroma of the coffee is lost, and its infusion is neither agreeable to the palate nor exhilarating in its influence. The roaster must judge of the amount of heat required for the adequate roasting of different qualities, and while that is variable, the range of roasting temperature proper for individual kinds is only narrow. In Continental countries it is the practice to roast in small quantities, and thus the whole charge is well under the control of the roaster; but in Britain large roasts are the rule, in dealing with which much difficulty is experienced in producing uniform torrefaction, and in stopping the process at the proper moment. The coffee-roasting apparatus is usually a malleable iron cylinder mounted to revolve over the fire on a hollow axle which allows the escape of gases generated during torrefaction. Messrs. W. and G. Law of Edinburgh have introduced a very ingenious adaptation of the cylinder whereby a compound simultaneous horizontal and vertical motion is secured, causing the seeds to be tossed about in all directions and communicating a uniform heat to every portion of the cylinder. The roasting of coffee should be done as short a time as practicable before the grinding for use, and as ground coffee especially parts rapidly with its aroma, the grinding should only be done when coffee is about to be prepared. Any ground coffee which may be kept should be rigidly excluded from the air.

While Arabia produces the choicest variety of coffee, the roasting of the seeds and the preparation of the beverage are also here conducted with unequalled skill. Mr. W. G. Palgrave gives the following account of these operations in his *Central and Eastern Arabia* :—

“Without delay Sowelylim begins his preparations for coffee. These open by about five minutes' blowing with the bellows, and arranging the charcoal till a sufficient heat has been produced. Next he places the largest of the coffee-pots, a huge machine, and about two-thirds full of clear water, close by the edge of the glowing coal-pit, that its contents may become gradually warm while other operations are in progress. He then takes a dirty knotted rag out of a niche in the wall close by, and having untied it, empties out of it three or four handfuls of unroasted coffee, the which he places on a little trencher of platted grass, and picks carefully out any blackened grains, or other non-homologous substances commonly to be found intermixed with the berries when purchased in gross; then, after much cleansing and shaking, he pours the grains so cleaned into a large open iron ladle, and places it over the mouth of the funnel, at the same time blowing the bellows and stirring the grains gently round and round till they crackle, redden, and smoke a little, but carefully withdrawing them from the heat long before they turn black or charred, after the erroneous fashion of Turkey and Europe; after which he puts them a moment to cool on the grass platter. He then sets the warm water in the large coffee-pot over the fire aperture, that it may be ready boiling at the right moment, and draws in close between his own trouserless legs a large stone mortar with a narrow pit in the middle, just enough to admit the black stone pestle of a foot long and an inch and a half thick, which he now takes in hand. Next pouring the half-roasted berries into the mortar he proceeds to pound them, striking right into the narrow hollow with wonderful dexterity, not ever missing his blow till the beans are smashed, but not reduced into powder. He then scoops them out, now reduced to a sort of coarse reddish

grit, very unlike the fine charcoal powder which passes in some countries for coffee, and out of which every particle of real aroma has long since been burned or ground. After all these operations . . . he takes a smaller coffee-pot in hand, fills it more than half with hot water from the larger vessel, and then, shaking the pounded coffee into it, sets it on the fire to boil, occasionally stirring it with a small stick as the water rises, to check the ebullition and prevent overflowing. Nor is the boiling stage to be long or vehement; on the contrary, it is and should be as slight as possible. In the interim he takes out of another rag-knot a few aromatic seeds called hey!, an Indian product, but of whose scientific name I regret to be wholly ignorant, or a little saffron, and after slightly pounding these ingredients, throws them into the simmering coffee to improve its flavor,—for such an additional spicing is held indispensable in Arabia, though often omitted elsewhere in the East. Sugar, I may say, would be a totally unheard-of profanation. Last of all, he strains off the liquor through some fibres of the inner palm-bark, placed for that purpose in the jug-spout, and gets ready the tray of delicate parti-colored grass and the small coffee-cups ready for pouring out.”

There is no doubt that were proper attention bestowed upon the preparation of coffee it would become a much more popular beverage in Great Britain than it now is; but to obtain it in perfection much greater care is requisite than is necessary in the case of tea. To obtain coffee with a full aroma it must be prepared as an infusion with boiling water, or the water may simply be allowed to reach the boiling point after infusion and nothing more. Dr. Parkes has, however, pointed out that by infusion alone much of

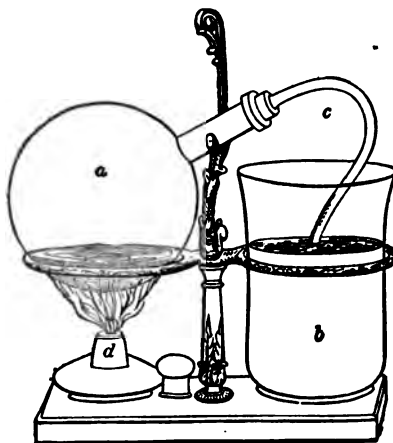

FIG. 3.—Napier's Coffee Apparatus.

the valuable soluble matter in ground coffee remains unextracted; and he recommends that the coffee which has already been used for infusion should be preserved and boiled, and that the liquor therefrom should be used for infusing a fresh supply. By this means the substance of the previously infused coffee and the aroma of the new are obtained together. Among the numerous devices which have been proposed for preparing coffee, none is more elegant and efficient than an apparatus constructed by Mr. James R. Napier, F.R.S., for which a patent was obtained by Mr. David Thomson of Glasgow. It consists of a glass globe *a* (fig. 3), an infusing jar *b*, of glass or porcelain, and a bent tube *c*, of block tin or German silver fitted by a cork stopper into the neck of the globe and passing to the bottom of the jar, where it ends in a finely perforated disc. The apparatus also requires a spirit lamp *d* or other means of communicating a certain amount of heat to the globe. The coffee is infused with boiling water in the jar, and a small quantity of boiling water is also placed in the globe. The tube is then fitted in, and the spirit lamp is lighted under the globe. The steam generated expels the air from the globe, and it bubbles up through the jar. When the bubbles of air cease to appear almost the whole of the air will have been ejected, and on withdrawing the lamp the steam in the globe condenses, creating a vacuum, to fill up which the infused coffee rushes up through the metal tube, being at the same time filtered by the accumulated coffee grounds around the perforated disc. An error of very frequent occurrence in the preparation of coffee, which results

probably from the habit of tea-making, consists in using too little coffee. For a pint of the infusion from an ounce to an ounce and a half of coffee ought to be used. According to the experiments of Aubert a cup of coffee made from a Prussian loth (.587 oz.) contains from 1.5 to 1.9 grains of caffeine.

Coffee belongs to the medicinal or auxiliary class of food substances, being solely valuable for its stimulant effect upon the nervous and vascular system. It produces a feeling of buoyancy and exhilaration comparable to a certain stage of alcoholic intoxication, but which does not end in depression or collapse. It increases the frequency of the pulse lightens the sensation of fatigue, and it sustains the strength under prolonged and severe muscular exertion. The value of its hot infusion under the rigors of Arctic cold has been demonstrated in the experience of all Arctic explorers, and it is scarcely less useful in tropical regions, where it beneficially stimulates the action of the skin. It has been affirmed that coffee and other substances containing the alkaloid caffeine have an influence in retarding the waste of tissue in the human frame, but careful and extended observation has demonstrated that they have no such effect.

Although by microscopic, physical, and chemical tests the purity of coffee can be determined with perfect certainty, yet ground coffee is subjected to many and extensive adulterations. Chief among the adulterant substances, if it can be so called, is chicory root; but it occupies a peculiar position, since very many people on the Continent as well as in Great Britain deliberately prefer a mixture of chicory with coffee to pure coffee. Chicory is indeed destitute of the stimulant alkaloid and essential oil for which coffee is valued; but the facts that it has stood the test of prolonged and extended use, and that its infusion is, in some localities, used alone, indicate that it performs some useful function in connection with coffee, as used at least by Western communities. For one thing, it yields a copious amount of soluble matter in infusion with hot water, and thus gives a specious appearance of strength and substance to what may be really only a very weak preparation of coffee. The mixture of chicory with coffee is easily detected by the microscope, the structure of both, which they retain after torrefaction, being very characteristic and distinct. The granules of coffee, moreover, remain hard and angular when mixed with water, to which they communicate but little color; chicory, on the other hand, swelling up and softening, yields a deep brown color to water in which it is thrown. The specific gravity of an infusion of chicory is also much higher than that of coffee. Among the numerous other substances used to adulterate coffee are roasted and ground roots of the dandelion, carrot, parsnip, and beet; beans, lupins, and other leguminous seeds; wheat, rice, and various cereal grains; the seeds of the broom, fenugreek, and iris; acorns; and "negro coffee," the seeds of *Cassia occidentalis*. These with many more similar substances have not only been used as adulterants, but under various high-sounding names several of them have been introduced as substitutes for coffee; but they have neither merited nor obtained any success, and their sole effect has been to bring coffee into undeserved disrepute with the public.

The leaves of the coffee-tree contain caffeine in larger proportion than the seeds themselves, and their use as a substitute for tea has frequently been suggested. The leaves are actually so used in Sumatra, but being destitute of any attractive aroma such as is possessed by both tea and coffee the infusion is not palatable. It is, moreover, not practicable to obtain both seeds and leaves from the same plant, and as the commercial demand is for the seed alone, no consideration either of profit or of any dietetic or economic advantage is likely to lead to the growth of coffee trees on account of their leaves. (J. P. A.)

COFFER-DAMS have from very early times been employed as useful, and in some cases indispensable structures in executing works of marine and river engineering. By excluding the water from the area they enclose, the work can be carried on within them with nearly the same ease as on dry land. Whether used on a small or a large scale—whether as low-tide dams of clay or concrete of only a few feet in height, or as high-water dams of timber and puddle formed to resist the waves of the sea, they are in every sense structures of great importance in the practice of hydraulic engineering.

Tide-dams are chiefly used in laying the foundations of

piers or other works that must be founded under low-water level. They are generally made of clay and planking, and are only carried to the height of about 3 feet above low-water. The water being pumped out during the last of the ebb tide affords one or two hours' work at low-

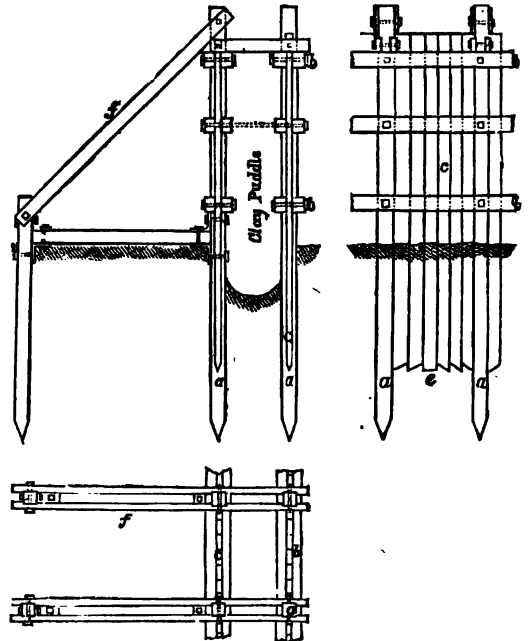

Fig. 1.—Coffer-dam for Soft Bottom.

water, the dam being submerged on the rise of the tide. In such dams a sluice should be introduced, which when open may allow the water to escape with the falling tide and so save pumping. Such tide-dams when exposed to a considerable wash of sea may advantageously be made of cement rubble masonry, of the application of which to coffer-dams the earliest account we know is that stated in Stevenson's *Account of the Bell-Rock Lighthouse* (p. 230), where he successfully employed that method of construction in excavating the foundation of that work.

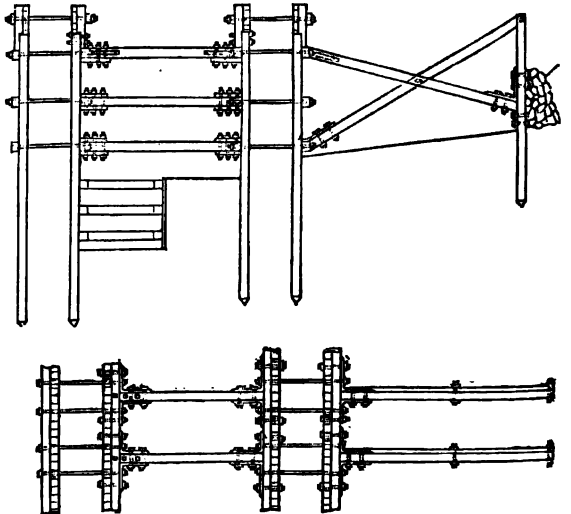

Fig. 2.—Coffer-dam used at Thames Embankment.

When it is required to sink the foundation some feet into sand and gravel, a convenient expedient is the portable dam proposed by Mr. Thomas Stevenson, described in the *Trans. of the Roy. Scot. Society of Arts*, 1848, to which reference is made. The feature in this tide-dam is the use of double framed walings to support and direct the driv

ing of the sheet piles, and its advantages are its cheapness, its portability, and its ready adaptation to a sloping or even very irregular bottom.

But when it is necessary entirely to exclude the water from large areas, as, for example, in dock-works, it is necessary to adopt coffer-dams of varied construction suited to the circumstances of each case, and as these protecting coffer-dam works, notwithstanding their temporary nature, demand much of the engineer's skill in their design and construction, we propose to notice some of the different modes of construction that have been adopted in such cases to suit the varying sub-soil and other features of different works.

It may here be mentioned that, particularly in bridge building, caissons were employed in early times instead of coffer-dams, but they are now entirely out of use. The caisson was a flatbottomed barge constructed of strongly framed timber-work, in which the under courses forming the foundation of the piers of a bridge, for example, were built at any convenient spot near the banks of the river. The caisson was then floated to the site of the pier, the bed of the river having previously been dredged so as to present a comparatively level and smooth surface. On the bed so prepared the caisson was sunk by admitting the water gradually by means of a valve provided for that purpose. The sides were so constructed as to admit of their easy removal from the bottom of the caisson when it had been sunk to its bed. Rankine mentions a caisson described by Becker which measured 63 feet long, 21 feet broad, and 15 feet deep over all. The bottom beams used in constructing this large caisson were 10 inches square and 2 feet 10 inches apart from centre to centre, and the uprights forming the sides were 10 inches square and 5 feet 8 inches apart from centre to centre.

But to return to the subject of this article. The dams used in soft bottoms, where piles can be driven, are constructed of timber, and vary in strength according to the head of water they have to sustain. But the general style of construction is in all cases the same. The dams are formed of parallel rows of piles driven into the bottom, the space between the rows being filled by a mass of clay puddle of sufficient thickness to exclude the water which percolates between the joints of the piles. In cases where the head of water is not great, the coffer-dam is generally constructed as shown in fig. 1, where the gauge piles *a* are driven at distances varying from 4 to 8 feet apart, to which walings *b* are fixed, and between the walings sheet piles *c* are driven. The sheet piles are shod with iron, having a sloping edge to cause the piles to cling while being driven, and in the centre of each bay there is a key pile *e*, having a slight taper which on being driven down compresses the sheet piles on either side of it closely together. In cases where the water pressure is great the sheeting piles are dispensed with, and the dam is formed of two or sometimes three rows of whole timbers having the clay puddle between them. Fig. 2 is a dam on this principle, used in the construction of the Thames embankment, and described in the *Transactions of the Institution of Civil Engineers* by Mr. Thomas Ridley, and after the explanations that have been given, its construction will be easily understood as an outer and inner dam formed of two rows of close-driven whole logs with intervening spaces of 6 feet filled with clay puddle. In all cases the dams must be supported by sufficient stays or struts, abutting on firm ground, or, when this cannot be got, on dwarf piles driven deep enough to afford sufficient resistance. It is also important to remove the soft matter between the rows of piles to as great a depth as possible, and to fill in the excavated space with clay puddle, for although the timber-work of the dam must be constructed so as to resist pressures, it will generally be found that the greatest risk of failure arises from the filtration of water under the bottom of the sheeting piles and puddle.

The coffer-dams described illustrate the general construction of such works, but various arrangements of the timber-work have been adopted to suit particular situations, such as Mr. James Walker's coffer-dam for constructing the foundations of the river terrace of the Houses of Parliament (vide *Min. of Proc. of Inst. of C. E.* vol. i.), and Sir John Hawkshaw's dam for the middle level drainage of Lincoln (*Min. of Proc. of Inst. of Civil Engineers*, vol. xii.).

All the examples that have been given are applicable to

situations where the bottom is sufficiently soft to admit of piles being driven. But cases occur where this is impossible. Such, for example, as the removal of obstructions from the beds of rivers where it may be necessary to lay dry a large area of solid rock, and in that case it is necessary to adopt a totally different construction of dam. The accompanying cut (fig. 3) shows a coffer-dam designed by Mr. D. Stevenson, which is specially adapted to a hard

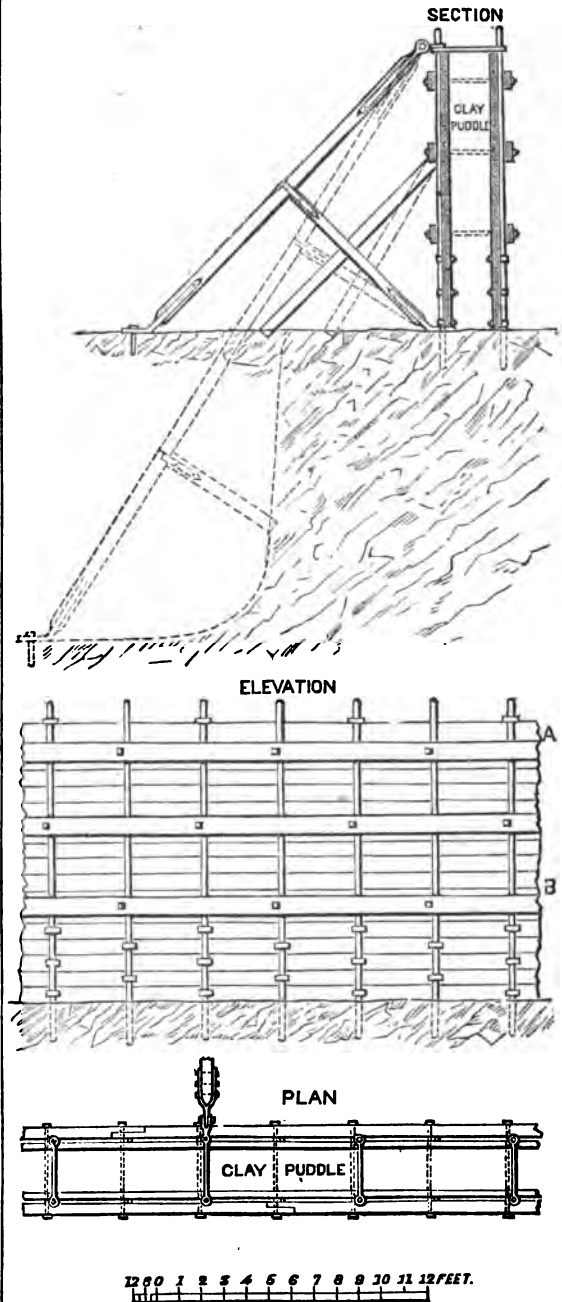

Fig. 3. Coffier-dam for Hard Bottom.

A, High Water; B, Low Water.

bottom where piles cannot be driven.<sup>1</sup> It is formed of two rows of iron piles placed 3 feet apart and jumped into the rock, which supports two linings of planking, the intermediate space being filled with puddle, and the whole structure properly stayed. This dam has been successfully employed on many works, and on the Ribble navigation, where it was first introduced, it was used to excavate a bed of rock 300 yards in length and of a maximum depth of 13 feet 6

<sup>1</sup> *Transactions of Institution of Civil Engineers*, vol. III., p. 387.

inches. The maximum depth at high water against the dam was 18 feet, but in high river floods the whole dam was completely submerged, and on the water subsiding it was found that the iron rods, although jumped only 15 inches into the rock, were not drawn from their fixtures.

Dams must be designed with a special regard to their sufficiency to resist the water pressures they have to bear, and Professor Rankine gives the following formulæ, in his *Manual of Civil Engineering*, p. 612, for calculating the pressure which the struts may have to bear.

Let  $b$  = breadth in feet of the division of the dam sustained by one strut,

$\alpha$  = the depth of water in feet,

$w$  = the weight of a cubic foot of water in lbs.

$P$  = the pressure of water against that division of dam;

Then—

$$P = wbx^2 + 2,$$

and the moment of that pressure relative to a horizontal axis at the level of the ground is

$$M = wbx^3 + 6.$$

Let  $h$  be the height above the ground at which the strut abuts against the dam, and  $i$  its inclination to the horizon; the thrust along the strut is

$$T = M \sec. i + h,$$

from which the scantling required, depending on the sort of timber employed, can be calculated.

In conclusion it may be noticed that the introduction of iron cylinders and compressed air for founding the piers of bridges has not only superseded the use of timber cofferdams for piers in soft bottoms, but has enabled bridges to be securely placed in situations where no timber dams could have answered the purpose. On the other hand, there are many engineering works connected with river, harbor, and dock improvement, to which the cylinder system is quite inapplicable, and for which extensive and costly cofferdams of the kind we have described must continue to be employed. The method of founding by iron cylinders has been described in the article BRIDGE, to which the reader is referred.

(D. S.)

COGNAC, a town of France, at the head of an arrondissement in the department of Charente, on the left bank of the River Charente, about 32 miles by rail west of Angoulême. It has a tribunal of commerce, a communal college, a prison, a hospital, a church of the 12th century dedicated to St. Leger, and an old castle, now used as a wine-store, in the park of which is a bronze statue of Francis I., marking the spot where, according to tradition, he was born in 1494. The most important industry of Cognac is the distillation and exportation of the celebrated brandy to which the town gives its name (see BRANDY). Iron is also manufactured, and a considerable trade is maintained in grain and cattle. Cognac is probably to be identified with one of the many places that bore the name of Condac; it was known as Coniacum in the Middle Ages. At an early period it was governed by lords of its own, but in the 12th century it became subject to the counts of Angoumois. In 1238 it was the seat of an ecclesiastical council summoned by Gerard of Bordeaux; and in 1526 it gave its name to a treaty concluded against Charles V. by Francis I., Henry VIII. of England, the Pope, Venice, and Milan. In 1562 the town was captured by the Huguenots, and in 1651 it defied the prince of Condé. Before the Revolution it possessed a fine Benedictine monastery and two other convents. The population, which was only 4000 about the middle of the 18th century, had increased by 1872 to 12,950.

COHESION. See ATTRACTION, CAPILLARY ACTION, and CONSTITUTION OF BODIES.

COHOES, one of the most important manufacturing centres in the United States, is situated in Albany County, in the State of New York, at the confluence of the Mohawk with the Hudson, just below the famous Cohoes fall on the former river, to which it is indebted for its prosperity. It contains seven churches and twenty-two public schools, the most remarkable of the churches being the Roman Catholic St. Bernard's and the Episcopal St. John's. The manufacturing establishments comprise six cotton mills with 4000 looms, eighteen knitting mills, a rolling mill, a pin factory, a knitting-needle factory, two foundries, three machine shops, a paper-mill, and a bedstead factory. In 1870 there were produced 54,342,000 yards of cloth, 33,600,000 knitting-needles, and 350,000 packages of pins; while the turn-out of hosiery formed a third of the whole

amount manufactured in the United States. The whole water-power of the river for some distance both above and below the falls is the property of the Cohoes Company instituted in 1826; and the various manufactories obtain their share at a fixed annual charge for each horse-power. The supply is regulated by a dam erected above the falls in 1865, and by a system of five canals. Cohoes owes its rise to the incorporation of the Cohoes Manufacturing Company in 1811. It obtained the rank of a village in 1848 and that of a city in 1869. Its population in 1850 was 4229; in 1860, 8800; and in 1870, 15,357. A large number of French Canadians are to be found among the operatives.

COIMBATORE, a district of British India, in the Presidency of Fort St. George or Madras, situated between 10° 45' and 11° 48' N. lat. and between 76° 50' and 78° 10' E. long. It is bounded on the N. by Mysore, on the E. by the district of Salem, the Cauveri River marking the entire boundary line, on the S. by Madura and Travancore State, and on the W. by Cochin State, Malabar District, and the Nilgiri Hills. Coimbatore may be described as a flat, open country, hemmed in by mountains on the north, west, and south, but opening eastwards on to the great plain of the Carnatic; the average height of the plain above sea-level is about 900 feet. The principal mountains are the Anamál Hills, in the south of the district, rising at places to a height of between 8000 and 9000 feet. In the west, the Palghát and Vallagíri Hills form a connecting link between the Anamál range and the Nilgiris, with the exception of a remarkable gap known as the Palghát Pass. This gap, which completely intersects the Gháta, is about twenty miles wide. In the north is a range of primitive trap-hills known as the Cauveri (Kaverí) chain, extending eastwards from the Nilgiris, and rising in places to a height of 4000 feet. The principal rivers are the Cauveri, Bháwaní, Noyal, and Amráwatí. Numerous canals are cut from the rivers for the purpose of affording artificial irrigation, which has proved of immense benefit to the country. Well and tank water is also largely used for irrigation purposes. The total area of Coimbatore is 7432 square miles, of which 3877½ square miles or 2,488,000 acres were returned as under cultivation in 1874-75, viz., 2,089,000 acres under food grains or corn crops, 80,000 acres oilseeds, 61,000 acres green and garden crops, 5000 acres orchards, and 253,000 acres under special crops. Excellent cotton and tobacco of a superior quality are produced. Extensive teak forests exist in the neighborhood. Coimbatore is subdivided into 10 taluks or sub-districts, and contains 1515 villages. The census report of 1872 returns the population of the districts as follows:—Hindus, 1,715,081; Muhammadans, 36,026; Native Christians, 11,443; Europeans and Eurasians, 595; Buddhists, or Jains, 56; others, 73; total, 1,763,274. The principal town is Coimbatore, situated in 10° 59' 41" N. lat. and 76° 59' 46" E. long.; it forms a station on the line of railway between Beypur and Madras. Population in 1872—Hindus, 30,801; Muhammadans, 2599; Christians, 1892; Buddhists, 18; total, 35,310. The municipal revenue of the town amounted in 1874-75 to £3720, and the expenditure to £3367. Two other small towns—Karur and Erode—are also constituted municipalities. The total district revenue in 1874-75 amounted to £304,818, of which £253,536 was derived from land. Coimbatore district was acquired by the British in 1799 at the close of the war which ended with the death of Tippu.

COIMBRA, a city of Portugal, capital of the province of Beira, on the north bank of the Mondego, 115 miles N.N.E. of Lisbon, in 40° 14' N. lat. and 8° 24' W. long. It is built for the most part on rising ground, and presents from the other side of the river a picturesque and imposing appearance; though in reality its houses have individually but little pretension, and its streets are, almost without exception, narrow and mean. It derives its present importance from being the seat of the only university in the kingdom,—an institution which was originally established at Lisbon in 1291, was transferred to Coimbra in 1308, was again removed to Lisbon, and was finally fixed at Coimbra in 1527. There are five faculties,—theology, law, medicine, mathematics, and philosophy, with fifty-two professors and twenty-one substitutes; and in 1874-75 the number of students was 667, of whom 15 came from the Azores and 11 from Brazil. The library contains 80,000 volumes, and the museums and laboratories are on an ex-

ensive scale. In connection with the medical faculty there are regular hospitals; the mathematical faculty maintains an observatory from which an excellent view can be obtained of the whole valley of the Mondego; and outside of the town there is a botanic garden (especially rich in the flora of Brazil), which also serves as a public promenade. Among the other educational establishments are a military college, a royal college of arts, and an episcopal seminary. The city is the seat of a bishop, suffragan to the archbishop of Braga; and it possesses two cathedrals, eight parish churches, and several conventual buildings. The new cathedral is of little interest; but the old is a fine specimen of the Romanesque style, and retains portions of the mosque which it replaced. The principal churches are Santa Cruz, of the 16th century, and San Salvador, founded by Esterão Martinez in 1169. On the bank of the Mondego stand the ruins of the once splendid monastery of Santa Clara, established by Don Mor Dias in 1236; and on the other side of the river, crossed by a fine bridge of several arches, is the celebrated *Quinta das lagrimas*, or Villa of Tears, where Inez de Castro is believed to have been murdered. The town is supplied with water by means of an aqueduct of 20 arches. The trade is purely local, as the river is navigable only in flood, and the port of Figueira is 20 miles distant; but there are manufactures of pottery, linen, cloth, and articles of horn; and a three days' market is held yearly in front of the Clara monastery. The country to the south is the most fertile and salubrious in Portugal, and the neighborhood is accordingly thickly studded with farm-houses and villas. The population of the city in 1864 was 18,147.

Coimbra is identified with the ancient *Conembrica*, the site of which, however, seems to have been a little to the south. The city was for a long time a Moorish stronghold, but in 1064 it was captured by Ferdinand the Great and the Cid. Previous to the 16th century it was the capital of the country, and no fewer than seven kings—Sancho I. and II., Alphonso I., II., and III., Pedro, and Ferdinand—were born within its walls. In 1755 it suffered considerably from the earthquake. In 1810 a division of the French army, under Massena, were made prisoners by the English in the neighborhood. In 1834 Don Miguel made the city his headquarters; and in 1846 it was the scene of a Miguelist insurrection.

COIN, a town of Spain, in the province of Malaga, and 20 miles west of the city of that name. It is well built, and has two large churches, an episcopal palace, and a town hall. Population, 8000.

COINAGE AND COINS. See BULLION, MINT, MONEY, and NUMISMATICS.

COIR, a rough, strong fibrous substance obtained from the outer husk of the cocoa-nut. See COCOA-NUT PALM.

COIRE (the German *Chur*, Italian *Chira*, and *Quera* of the Romance language spoken in the district), the capital of the Swiss canton of the Grisons or Graubünden, at the foot of the valley of the Plessur, a short distance above the confluence of that river with the Rhone, in 46° 50' 54" N. lat. and 9° 31' 26" E. long. It lies 1830 feet above the level of the sea, and is overshadowed by the Mittenberg and Pizokelberg. The streets are narrow, and the general appearance of the place bespeaks its antiquity. The upper part of the town, or Bishop's Quarter, was once surrounded with walls, and it is still distinguished from the lower portion as the almost exclusive residence of the Roman Catholic population. The cathedral church of St. Lucius is its most remarkable building, ascribed in part to Bishop Tello of the 8th century, and deriving its name from a legendary British king, who is reputed to have suffered martyrdom in the town. Of antiquarian interest are the statues of the Four Evangelists, the ancient wood carvings, and several monuments by Holbein and Dürer. The episcopal palace on the other side of the court is believed to occupy the site of a Roman castle; and two ancient towers, probably dating from the 10th century, are popularly regarded as of Roman construction, the opinion being supported by deriving their names, *Marsoel* and *Spinuel*, from the Latin *Mars in Oculis* and *Spina in Oculis*. The episcopal school is now administered by the canton, and contains a rich collection of native literature. In the lower town are situated the great town-house, with a public library and three stained-glass windows of the 16th century; the churches of St. Martin and St. Regula; the administrative buildings; and the hospital founded by Theodosius,

a superior of the Capuchins. The prosperity of Coire is chiefly maintained by its transit trade between Germany and Italy; but it also engages in the manufacture of cotton, wool, leather, and pewter wares, has dye-works and breweries, and deals in cattle and grain. The population, which is mainly Protestant, numbered 7552 in 1870.

Coire is identified with *Curia Rhetorum*, a late Roman city, first mentioned about the 4th century. Its bishopric, which held sway over an extensive district, seems to have been founded in 470 by Asimo. In the 16th century the town made itself free from episcopal control, and in 1460 obtained from the emperor, Frederick IV., the rank of an imperial city; but before the beginning of the next century it split with the empire and joined the confederacy of the Grisons. In 1526 the Reformation was introduced; and a conspiracy for the restoration of the former ecclesiastical regime was vigorously suppressed. In the 17th century the city was frequently the centre of the great struggle between the Cantons and the Austrian empire which raged with such fury and so many alternations of success. In 1802 the French general Massena occupied the town, and from that date the bishops have had no territorial possessions.

COJUTEPEC, a town of Central America, in the republic of San Salvador and the department of Cuscatlan, about 15 miles east of the capital. It has a population of about 15,000, and from 1854 to 1858 it served as the seat of government instead of San Salvador, which had been ruined by an earthquake. In 1872 it took part in a revolutionary outbreak against the existing Government, and the Indian population unsuccessfully attacked the garrison. The town gives its name to a neighboring volcano, which rises to a height of 6700 feet, and also to the extensive lake, otherwise known as the Lake of Ilopango, which lies a few miles to the south and gives rise to the Rio Jiboa.

COKE, the carbonaceous residue produced when coal is subjected to a strong red heat, out of contact with the air, until the volatile constituents are driven off. It consists essentially of carbon, the so-called fixed carbon, together with the incombustible matters or ash contained in the coal from which it is derived. In addition to these it almost invariably contains small quantities of hydrogen, oxygen, and nitrogen, the whole, however, not exceeding 2 or 3 per cent. It also contains water, the amount of which may vary considerably according to the method of manufacture. When produced rapidly and at a low heat, as in gas-making, it is of a dull black color, and a loose spongy or pumice-like texture, and ignites with comparative ease, though less readily than bituminous coal, so that it may be burnt in open fire-places; but when a long-continued heat is used, as in the preparation of coke for iron and steel melting, the product is hard and dense, is often prismatic in structure, has a brilliant semi-metallic lustre and silvery-grey color, is a good conductor of heat and electricity, and can only be burnt in furnaces provided with a strong chimney draught or an artificial blast. The strength and cohesive properties are also intimately related to the nature and composition of the coals employed, which are said to be caking or non-caking according to the compact or fragmentary character of the coke produced.

The simplest method of coking, that in open heaps or piles, is conducted in a very similar manner to charcoal burning. The coal is piled in a domed heap about 30 feet in diameter and 5 feet high, with a chimney of bricks arranged in open chequer work in the centre, around which the largest lumps of coal are placed so as to allow a free draft through the mass. The outside of the heap is covered with a coating of wet coke dust, except a ring about a foot high at the bottom. Fire is communicated by putting a few live coals near the top of the chimney, or from the interior by throwing them down the chimney, and the combustion proceeds downwards and outwards by the draught through the uncovered portion at the bottom. Whenever the fire takes too strong a hold and burns out to the surface it is damped by plastering over the spot with wet coke dust and earth, this being a point requiring considerable skill on the part of the coke burner. When flame and smoke are no longer given off, which usually happens in from five to six days, the whole surface is smothered with coke dust, and the chimney is stopped for three or four days longer, when the heap is sufficiently cooled to allow of the coke being broken up and removed, or, as it is called, drawn. The cooling is usually expedited by throwing water upon the heap before drawing.

The principle of coking in rectangular piles is generally similar to the foregoing, but chimneys are not used. The dimensions generally adopted are a height of from  $3\frac{1}{2}$  to 5 feet, and a breadth of 12 feet at the base.

In coking by clamps or kilns a rectangular pile of coal is enclosed between upright walls, having a system of vertical and horizontal passages traversing them at intervals, which serve as chimneys to conduct the combustion through the pile. This system has been used at different times in South Wales, Germany, and other places, but is now generally abandoned, as the draught holes have a tendency to consume the coal unnecessarily unless very carefully watched.

The largest proportion of the coke used for industrial purposes is made in close kilns or ovens. These vary very considerably in form and details of construction, but the same general principles are observed in all, the object being to effect the coking as much as possible by the consumption of the volatile inflammable gases given off above the surface of the coal, and to protect the latter from the direct access of currents of air. A further object is the utilization of the heat given off by the waste gases, which may be employed to heat the oven by circulating them in flues round the outside, and further by employing them for the accessory objects of raising steam, heating air, &c., in collieries and iron-works.

In its oldest and simplest form, the coke oven consists of a round chamber from 7 to 10 feet in diameter, with a low cylindrical wall, and a domed roof rising about 20 inches in height above the floor. A hole about 1 foot in diameter in the crown of the roof serves for charging, and the finished coke is drawn through a door in the wall, about 2½ feet square. When cleared for a fresh charge, the oven being red-hot, small coal is introduced through the hole in the roof, and spread uniformly over

range of ovens, so that the charging can be effected directly from the colliery trucks. The yield of coke by this method may be from 55 to 65 per cent., according to the nature of the coal. With charges varying from 3 to 10 tons, the operation, including the period of cooling, lasts from four to seven days. The coke obtained is of the highest quality, being dense and well burned. In some cases the cooling of the coke is effected by watering it before drawing. There is a certain amount of sulphur removed by this method, as the steam generated being brought into contact with the sulphide of iron in the heated mass, formed from pyrites in the coal, produces sulphuretted hydrogen and magnetic oxide of iron. The amount of desulphurization by this method is, however, practically insignificant, as the operation does not last a sufficient time to allow the mass of the fuel to be affected. The proportion of sulphur in finished coke, as compared with that of the original coal, may be roughly stated at about one-half. It has been sought to reduce the amount by decomposing the residual ferrous sulphide in various ways, as by the addition of salt, carbonate of soda, lime, etc., to the coal before coking, but none of these methods is found to be practically useful.

In the South Wales coal-field the ordinary form of coke oven is nearly rectangular, being about 14 feet long, 5 feet wide at the back, and 6 feet at the front or drawing ends; the height to the crown of the cylindrical roof is 5 feet 6 inches, with usually two charging holes. Two charges are worked weekly, the first, of 4½ tons, is finished in three days, while the second, of 5 tons, is allowed four days, so as to remain in the oven over Sunday. The yield in both cases is about the same.

The addition of heating flues exterior to the wall of the oven allows the time of coking to be very much shortened. Of the numerous contrivances proposed for this purpose, that of a Belgian engineer, Mr. Coppée, has latterly come into favor in many places, as very well adapted for use with comparatively dry coal. The coking chamber is a long narrow retort of fire brick, measuring about 30 feet in length, 17 inches in width at the front, and about 2 inches more at the back, where the charge is pushed out, with vertical walls about  $3\frac{1}{2}$  feet high, covered by a low arched roof. One of these walls is solid, but the other contains twenty-eight vertical descending flues (f) which communicate with the interior at the springing of the roof, and below with the large flue of the same width as the oven, and running along its entire length. As usually built, a series or battery includes about thirty ovens, which are arranged in pairs as in the figure, from which it will be seen that the left hand oven (A) is heated by the joint current of gases on both sides, while B is heated on one side by its own gas, and on the other by that of the next oven to the right. The current then passes along the bottom flue of A, and back through that of B, whence it escapes by a flue to the chimney, or may be led to a steam boiler if the waste heat is used, as is generally the case, for raising steam. The working of the adjacent pair of ovens is so arranged that they are drawn alternately at exactly intermediate periods; thus supposing the time of coking to be forty-eight hours, A is drawn twenty-four hours after the charging of B, while the latter is in full activity, and keeps up the heat of the empty oven during charging, while necessarily the burning hydrocarbon gases given off during the first heating of the coal tend to keep up the heat in the adjoining oven. At Ebbw

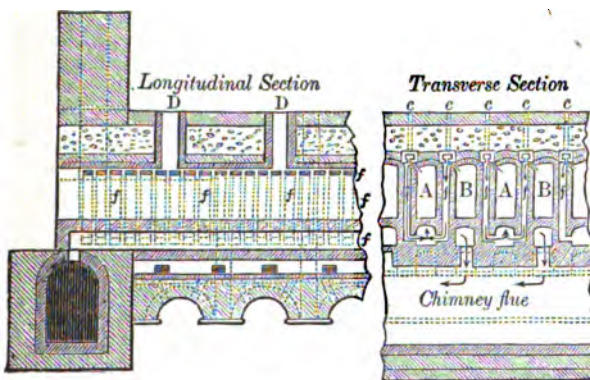

Coppée's Coke Oven.

the floor, until it is filled up to the level of the springing of the roof, when the doorway is filled up with loose bricks, which give a sufficient passage between them for the admission of air to ignite the gases given off by the distillation of the heated coal. After a few hours these air-ways must be closed by plastering up the brickwork, except the top layer, which is left open for twenty-four hours. The heat developed by the burning gases causes the coking to proceed downwards until the entire charge is converted, this taking from three to four days, according to the quantity of coal. When the escape of flame from the hole in the roof ceases, all apertures are stopped whereby air can enter to the incandescent mass, which being no longer protected by an atmosphere of combustible gases, would burn to waste if brought in contact with the atmosphere. At this point, therefore, all holes in the oven and chimney are completely closed for about twelve hours, when the door is opened, and the coke, which forms a coherent mass, somewhat less in size than the original charge, and divided by a system of columnar joints, is removed by an iron drag, or cross-bar, inserted at the far end of the floor, and moved by a chain and windlass, a stream of water from a hose being used to quench the glowing coke as it is brought out. This class of oven, which is now not much used, was adopted by most of the railway companies, when coke was burnt exclusively in locomotives, and is also common in the Durham coal-field. They are generally known as beehive ovens, also as bakers' ovens. Usually from six to ten, or twelve, or more ovens are placed side by side in one block of brickwork, which is supplied with a tall chimney, the individual ovens being connected by pillars, with well-regulated dampers. A railway is generally laid along the top of the

Vale, in Monmouthshire, where the coking requires only twenty-four hours, the ovens are numbered consecutively, the odd numbers being drawn and recharged in the morning, and the even ones twelve hours later. The combustion of the gases is effected by air which is brought in through special channels (c) in the brickwork communicating with the gas flues at the top, and becomes heated in the passage. The object sought to be obtained is the combustion of the gases as much as possible in the flues, and not in the oven itself. The oven is closed at both ends by cast-iron doors in two parts, which can be opened together or separately during the drawing and recharging. The charging is effected through three holes (D D) in the roof, the coal, in the form of slack, being contained in hopper-shaped trams, running upon rails, which are run over the holes and emptied by drawing a slide. The charge is about 3 tons, and the yield from 36 to 44 cwt., according to the nature of the coal operated upon. The finished coke forms a prismatic mass, 30 feet long, 3 feet high, and 16 inches broad; it is pushed out by a ram, shaped like the cross section of the oven, which is moved by steam power acting upon a long raked rod. This apparatus, together with the engine and boiler for moving it, is mounted on a carriage moving on a railway in front of the range of ovens, so that it can be brought up to any one of them as required. The mass of coke is pushed out on to a floor running along the back, where it is immediately broken, and quenched by heavily watering the fragments. The whole operation, including the drawing and recharging of the empty oven, is effected in about eight minutes. The yield of coke very closely approximates to that obtained by experiments in crucibles. A similar kind of oven with outside heating flues, that

of the Brothers Appolt, has been in use for several years on the Continent, more particularly in France. It differs from Coppée's in the position of the cooking chambers, which are vertical instead of horizontal, the coal being charged from the top, and the finished coke dropped into a truck placed below. Various schemes have been proposed at different times for the purpose of utilizing the condensable products, such as tar, ammoniacal water, etc., given off during the earlier stages of the process of coking, but they are not generally found to be applicable to the manufacture of metallurgical coke, being only suited for gas-works, where the quality of the coke is only a secondary consideration.

The slack of dry or non-caking coal, or anthracite, which cannot be coked alone, may be converted into a useful coke by mixing it with a proportion of bituminous coal, or gas-pitch, or a mixture of both. At Swansen, a mixture of 60 to 70 per cent. of anthracite with from 30 to 35 per cent. of bituminous coal, and 5 or 6 of gas-pitch, made by grinding the ingredients in one of Carr's disintegrator mills, is coked in the ordinary South Wales ovens, a thin layer of bituminous coal being placed above the charge before it is lighted, to prevent the pitch from burning to waste. The yield of coke is about 80 per cent. of the weight of the charge. It is exceedingly hard, and about 23 per cent. heavier than that made from bituminous coal, with a correspondingly higher calorific value.

Coke is used for all purposes where a smokeless fire is required, as, for instance, in drying malt on hops, or in raising steam in locomotives within the limits of towns, also for producing strong local heat, as in melting metals (gold, silver, brass, or steel) in crucibles in air furnaces. In blast furnaces its value depends upon the difficulty of combustion, so that the particles keep their form until they reach the proper place of combustion at the point of entry of the blast in the lower part of the furnace. The great economy of fuel that has been effected in the process of iron smelting in the Cleveland district by increasing the height of the furnaces, is in great part due to the strength of the coke used, which is made in the south part of the Durham coal-field, and has sufficient cohesive power to bear the pressure of a column of iron-making materials from 80 to 100 feet in height without crushing, a result which cannot be obtained with the coke of other districts. Finely ground coke is used mixed with clay for making crucibles for steel melting, and also for filling the hearths of blast-furnaces in many German smelting works.

Apart from its convenience for special purposes, coke is not an economical fuel, the useful heating effect being about the same as that of an equal weight of coal. This circumstance has led to the nearly general abandonment of coke and the substitution of raw coal as fuel in locomotive engines on railways.

For full accounts of the different systems of coke ovens and details of their construction, see Percy's *Metallurgy*, introductory volume on fuel, &c., 2d edition, London, 1875, and Jordan's *Album du Cours de Metallurgie*, Paris, 1874.

(H. B.)

COKE, SIR EDWARD (1552-1633), one of the most erudite of English lawyers, was born at Mileham, in Norfolk, on February 1, 1552. When only ten years old he lost his father, who was a bencher of Lincoln's Inn. From the grammar-school of Norwich he passed to Trinity College, Cambridge; and after a course of three years, in 1572 he entered the Inn to which his father had belonged. To the study of law he devoted himself from the first with the intensest application; he slept only six hours, and from three in the morning till nine at night he read or took notes of the cases tried in Westminster Hall with as little interruption as possible. In 1578 he was called to the bar, and in the next year he was chosen reader at Lyon's Inn. His extensive and exact legal erudition, and the skill with which he argued the intricate cases of Lord Cromwell and Edward Shelley, soon brought him a practice never before equalled, and caused him to be universally recognized as the greatest lawyer of his day. In 1586 he was made recorder of Norwich, and in 1592 recorder of London, solicitor-general, and reader in the Inner Temple. In 1593 he was returned as member of parliament for his native county, and also chosen speaker of the house of Commons. In 1594 he was promoted to the office of attorney-general, despite the claims of Bacon, who was warmly supported by the Earl of Essex. As crown lawyer his treatment of the accused was marked by more than the harshness and violence common in his time; and the fame of the victim has caused his behavior in the

trial of Raleigh to be lastingly remembered against him. While the prisoner defended himself with the calmest dignity and self-possession, Coke burst into the bitterest invective, brutally addressing the great courtier as if he had been a servant, in the phrase, long remembered for its insolence and its utter injustice,—“Thou hast an English face, but a Spanish heart!”

In 1582 Coke married the daughter of John Paston, a Suffolkshire gentleman, receiving with her a fortune of £30,000; but in six months he was left a widower. Shortly after he sought the hand of Lady Elizabeth Hatton, daughter of Thomas, second Lord Burghley, and granddaughter of the great Cecil. Bacon was again his rival, and again unsuccessfully; the wealthy young widow became—not, it is said, to his future comfort—Coke's second wife.

In 1606 Coke was made chief-justice of the Common Pleas, but in 1613 he was removed to the office of chief-justice of the King's Bench, which gave him less opportunity of interfering with the court. The change, though it brought promotion in dignity, caused a diminution of income as well as of power; but Coke received some compensation in being appointed a member of the Privy Council. The independence of his conduct as a judge, though not unmixed with the baser elements of prejudice and vulgar love of authority, has partly earned forgiveness for the harshness which was so prominent in his sturdy character. Full of an extreme reverence for the common law which he knew so well, he defended it alike against the Court of Chancery, the ecclesiastical courts, and the royal prerogative. In a narrow spirit, and strongly influenced, no doubt, by his enmity to the chancellor, Egerton, he sought to prevent the interference of the Court of Chancery with even the unjust decisions of the other courts. In the case of an appeal from a sentence given in the King's Bench, he advised the victorious, but guilty, party to bring an action of *premunire* against all those who had been concerned in the appeal, and his authority was stretched to the utmost to obtain the verdict he desired. On the other hand, Coke has the credit of having repeatedly braved the anger of the king. He freely gave his opinion that the royal proclamation cannot make that an offence which was not an offence before. An equally famous but less satisfactory instance occurred during the trial of Peacham, a divine in whose study a sermon had been found containing libellous accusations against the king and the Government. There was nothing to give color to the charge of high treason with which he was charged, and the sermon had never been preached or published; yet Peacham was put to the torture, and Bacon was ordered to confer with the judges individually concerning the matter. Coke declared such conference to be illegal, and refused to give an opinion, except in writing, and even then he seems to have said nothing decided. But the most remarkable case of all occurred in the next year (1616). A trial was held before Coke in which one of the counsel denied the validity of a grant made by the king to the bishop of Lichfield of a benefice to be held *in commendam*. James, through Bacon, who was then attorney-general, commanded the chief-justice to delay judgment till he himself should discuss the question with the judges. At Coke's request Bacon sent a letter containing the same command to each of the judges, and Coke then obtained their signatures to a paper declaring that the attorney-general's instructions were illegal, and that they were bound to proceed with the case. His Majesty expressed his displeasure, and summoned them before him in the council-chamber, where he insisted on his supreme prerogative, which, he said, ought not to be discussed in ordinary argument. Upon this all the judges fell on their knees, seeking pardon for the form of their letter; but Coke ventured to declare his continued belief in the loyalty of its substance, and when asked if he would in the future delay a case at the king's order, the only reply he would vouchsafe was that he would do what became him as a judge. Soon after he was dismissed from all his offices on the following charges,—the concealment, as attorney-general, of a bond belonging to the king, a charge which could not be proved, illegal interference with the Court of Chancery, and disrespect to the king in the case of *commendams*. He was also ordered by the council to revise his book of reports, which was said to contain many extravagant opinions (June, 1616).

Coke did not suffer these losses with patience. He offered his daughter Frances, then little more than a child, in marriage to Sir John Villiers, brother of the favorite Buckingham. Her mother, supported at first by her husband's great rival and her own former suitor, Bacon, objected to the match, and placed her in concealment. But Coke discovered her hiding-place; and she was forced to wed the man whom she declared that of all others she abhorred. The result was the desertion of the husband and the fall of the wife. It is said, however, that after his daughter's public penance in the Savoy Church, Coke had heart enough to receive her back to the home which he had forced her to leave. Almost all that he gained by his heartless diplomacy was a seat in the council and in the Star-Chamber.

In 1620 a new and more honorable career opened for him. He was elected member of parliament for Liskeard; and henceforth he was one of the most prominent of the constitutional party. It was he who proposed a remonstrance against the growth of Popery and the marriage of Prince Charles to the infanta of Spain, and who led the Commons in the decisive step of entering on the journal of the House the famous petition of the 18th December, 1621, insisting on the freedom of parliamentary discussion, and the liberty of speech of every individual member. In consequence, together with Fym and Sir Robert Phillips, he was thrown into confinement; and, when in the August of the next year he was released, he was commanded to remain in his house at Stoke-Poges during his Majesty's pleasure. Of the first and second parliaments of Charles I. Coke was again a member. From the second he was excluded by being appointed sheriff of Buckinghamshire. In 1628 he was at once returned for both Buckinghamshire and Suffolk, and he took his seat for the former county. After rendering other valuable support to the popular cause, he took a most important part in drawing up the great Petition of Right. The last act of his public career was to bewail with tears the ruin which he declared the duke of Buckingham was bringing upon the country. At the close of the session he retired into private life; and the six years that remained to him were spent in revising and improving the works upon which, at least as much as upon his public career, his fame now rests. He died on the 3d September, 1633.

Coke published *Institutes*, of which the first is also known as "Coke upon Littleton," *Reports*, *A Treatise of Bail and Mainprize*, *The Complete Copyholder*, *A Reading on Fines and Recoveries*.

COLBERG, or KOLBERG, a fortified seaport town of Prussia, in the former province of Pomerania, and the government of Köslin, on the right bank of the Persante, which falls into the Baltic about a mile below the town. It has a handsome market-place, adorned since 1864 with a statue of Frederick William IV.; and there are several pretty extensive suburbs, of which the most important is the Munde, in great measure the growth of the present century. The principal buildings are the cathedral of St. Mary's, one of the most remarkable churches in Pomerania, dating from 1316, the council-house erected after the plans of Zwirner, the citadel, and the aqueduct by which the town is supplied with water. Colberg also possesses several hospitals, a workhouse, a house of correction, an orphan asylum, a gymnasium, a preparatory school of navigation, and an exchange. Its bathing establishments are largely frequented and attract a considerable number of summer visitors. Woollen cloth and spirits are manufactured; there is an extensive salt-mine in the neighboring Zilenberg; the salmon and lamprey fisheries are important; and a fair amount of commercial activity is maintained. Population in 1872, 13,106.

Colberg was the seat of a bishop as early as the 10th century, though it not long after lost this distinction. Till 1277 it was the chief town of the Cassubian Wends, and after that date it ranked as the most important place in the episcopal principality of Kamin, with which it passed in 1648 to Brandenburg. In the Thirty Years' War it was captured by the Swedes, after a protracted siege in 1631; and in the Seven Years' War it was one of the centres of the conflict. In 1758 it withstood the attacks of General Palmbach and his army of 10,000 men, and in 1760 it held out against the Russian and Swedish forces, both by sea and land, till it was relieved by the advance of Werner; but in 1761 it was compelled by famine to yield to Romanoff after a four months' investment and violent bom-

bardment. In 1807 it was surrounded by 18,000 men under the command of Feullic, Loison, and Mortier; but the burgher Nettelbeck within and the free-fighter Schill without succeeded in defending it till the peace of Tilsit brought the war to a close.

COLBERT, JEAN BAPTISTE (1619-1683), one of the greatest among the great statesmen of France, was born on the 29th of August, 1619, at Rheims, where his father and grandfather were merchants. He claimed to be the descendant of a noble Scottish family, but those who have investigated the matter have almost without exception decided against the pretension. His youth is said to have been spent in a Jesuit college, in the office of a Parisian banker, and in that of a Parisian notary, Chapelain, the father of the poet. But the first fact on which we can rely with confidence is that, when not twenty yet, he obtained a post in the war-office, by means of the influence that he possessed through the marriage of one of his uncles to the sister of Michel Le Tellier, the secretary of state for war. During some years he was employed in the inspection of troops and other work of the kind, but at length his ability, his extraordinary energy, and his untiring laboriousness induced Le Tellier to make him his private secretary. These qualities, combined, it must be confessed, with a not over-delicate readiness to seize every opportunity of advancement, soon brought Colbert both wealth and influence. In 1647 we find him receiving the confiscated goods of his uncle Pussort, in 1648 obtaining 40,000 crowns with his wife Marie Charron, in 1649 appointed councillor of state.

It was the period of the wars of the Fronde; and in 1651 the triumph of the Condé family drove Cardinal Mazarin from Paris. Colbert, now aged thirty-two, was engaged to keep him acquainted with what should happen in the capital during his absence. At first Colbert's position was far from satisfactory; for the close wary Italian treated him merely as an ordinary agent. On one occasion, for example, he offered him 1000 crowns. The gift was refused somewhat indignantly; and by giving proof of the immense value of his services, Colbert gained all that he desired. His demands were not small; for, with an ambition mingled, as his letters show, with strong family affection, he aimed at placing all his relatives in positions of affluence and dignity; and many a rich benefice and important public office was appropriated by him to that purpose. For these favors, conferred upon him by his patron with no stinted hand, his thanks were expressed in a most remarkable manner; he published a letter defending the cardinal from the charge of ingratitude which was often brought against him, by enumerating the benefits that he and his family had received from him (April, 1655). Colbert obtained, besides, the higher object of his ambition; the confidence of Mazarin, so far as it was granted to any one, became his, and he was intrusted with matters of the gravest importance. In 1659 he was giving directions as to the suppression of the revolt of the gentry which threatened in Normandy, Anjou, and Poitou, with characteristic decision arresting those whom he suspected and arranging every detail of their trial, the immediate and arbitrary destruction of their castles and woods, and the execution of their chief, Bonnesson. In the same year we have evidence that he was already planning his great attempt at financial reform. His earliest tentative was the drawing up of a *mémoire* to Mazarin, showing that of the taxes paid by the people not one-half reached the king. The paper also contained an attack upon the superintendent, Fouquet, who, first recommended to Le Tellier by Colbert himself, had since developed into the most shameless of extortioners; and being opened by the postmaster of Paris, who happened to be a spy of Fouquet's, it gave rise to a bitter quarrel, which, however, Mazarin repressed during his lifetime.

In 1661 the death of Mazarin allowed Colbert to take the first place in the administration. It was some time before he assumed official dignities; but in January, 1664, he obtained the post of superintendent of buildings; in 1665 he was made controller-general; in 1669 he became minister of the marine; and he was also appointed minister of commerce, the colonies, and the king's palace. In short, he soon acquired power in every department except that of war.

A great financial and fiscal reform at once claimed all his energies. This he saw was the first step toward raising France to the lofty position he intended her to occupy.



The country was in economic chaos. Those who had the fiscal administration in their hands, from the superintendent to the meanest of the tax-farmers, robbed and misappropriated almost as they pleased. The Government loans were arranged, not so as to be most advantageous to the state, but so as most to aggrandize the individuals who were interested in them. Not only the nobility, but many others who had no legal claim to exemption, paid no taxes; the weight of the burden fell on the wretched country-folk. Colbert sternly and fearlessly set about his task. Supported by the young king, Louis XIV., he aimed the first blow at the greatest of the extortioners—the bold and powerful superintendent, Fouquet. He was accused of high treason, not without sufficient grounds, for it was known that he had prepared to meet an arrest formerly contemplated by an appeal to force. The most minutely careful precautions were taken by Colbert for his seizure, and he was tried before a specially prepared chamber of justice. Nevertheless the trial was protracted during three years, and the sentence passed was not death but banishment. The Government, however, carried out its plans. The superintendent was safely disposed of in the state prison of Pignerol; just disgrace fell upon Councillor d'Ormesson and the other judges who had averted the punishment Fouquet richly deserved; and many minor officials, convicted of peculation, were treated with great severity, some being banished, some sent to the galleys, some even hanged.

The office of superintendent and many others dependent upon it being abolished the supreme control of the finances was vested in a royal council. The sovereign was its president; but Colbert, though for four years he only possessed the title of intendant, was its ruling spirit, great personal authority being conferred upon him by the king. The career on which Colbert now entered must not be judged without constant remembrance of the utter rottenness of the previous financial administration. His ruthlessness in this case, dangerous precedent as it was, was perhaps necessary; individual interests could not be respected. Guilty officials having been severely punished, the fraudulent creditors of the Government remained to be dealt with. Colbert's method was simple. Some of the public loans were totally repudiated, and from others a percentage was cut off, which varied, at first according to his own decision, and afterwards according to that of the council which he established to examine all claims against the state.

Much more serious difficulties met his attempts to introduce equality in the pressure of the taxes on the various classes. To diminish the number of the privileged was impossible, but false claims to exemption were firmly resisted, and the unjust direct taxation was lightened by an increase of the indirect taxes, from which the privileged could not escape. The mode of collection was at the same time immensely improved.

Order and economy being thus introduced into the working of the government, the country, according to Colbert's vast yet detailed plan, was to be enriched by commerce. Manufactures were fostered in every way he could devise. New industries were established, inventors protected, workmen invited from foreign countries, French workmen absolutely prohibited to emigrate. To maintain the character of French goods in foreign markets, as well as to afford a guarantee to the home consumer, the quality and measure of each article were fixed by law, breach of the regulations being punished by public exposure of the delinquent and destruction of the goods, and, on the third offence, by the pillory. But whatever advantage resulted from this rule was more than compensated by the disadvantages it entailed. The production of qualities which would have suited many purposes of consumption was prohibited, and the odious supervision which became necessary involved great waste of time and a stereotyped regularity which resisted all improvements. And other parts of Colbert's scheme deserve still less equivocal condemnation. By his firm maintenance of the corporation system, each industry remained in the hands of certain privileged bourgeois; in this way, too, improvement was greatly discouraged; while to the lower classes opportunities of advancement were closed. With regard to international commerce Colbert was equally unfortunate in not being in advance of his age; the tariffs he published were protective to an extreme. The interests of internal commerce were, however, wisely consulted. Unable to abolish the duties on the passage of goods from province to province, he did what he

could to induce the provinces to equalize them. The roads and canals were improved. The great canal of Languedoc was planned and constructed by Riquet under his patronage. To encourage trade with the Levant, Senegal, Guinea, and other places, privileges were granted to companies; but, like the more important East India Company, all were unsuccessful. The chief cause of this failure, as well as of the failure of the colonies, on which he bestowed so much watchful care, was the narrowness and rigidity of the Government regulations.

The greatest and most lasting of Colbert's achievements was the establishment of the French marine. The royal navy owed all to him; for the king thought only of military exploits. For its use, Colbert reconstructed the works and arsenal of Toulon, founded the port and arsenal of Rochefort, and the naval schools of Rochefort, Dieppe, and Saint-Malo, and fortified, with some assistance from Vauban (who, however, belonged to the party of his rival Luvois), among other ports those of Calais, Dunkirk, Brest, and Havre. To supply it with recruits he invented his famous system of classes, by which each seaman, according to the class in which he was placed, gave six months' service every three or four or five years. For three months after his term of service he was to receive half-pay; pensions were promised; and, in short, everything was done to make the navy popular. There was one department, however, that was supplied with men on a very different principle. Letters exist written by Colbert to the judges requiring them to sentence to the oar as many criminals as possible, including all those who had been condemned to death; and the convict once chained to the bench, the expiration of his sentence was seldom allowed to bring him release. Mendicants also, against whom no crime had been proved, contraband dealers, those who had been engaged in insurrections, and others immeasurably superior to the criminal class, nay, innocent men—Turkish, Russian, and negro slaves, and poor Iroquois Indians, whom the Canadians were ordered to entrap—were pressed into that terrible service. By these means the benches of the galleys were filled, and Colbert took no thought of the long unrelieved agony borne by those who filled them.

Nor was the mercantile marine forgotten. Encouragement was given to the building of ships in France by allowing a premium on those built at home, and imposing a duty on those brought from abroad; and as French workmen were forbidden to emigrate, so French seamen were forbidden to serve foreigners on pain of death.

Even ecclesiastical affairs, though with these he had no official concern, did not altogether escape Colbert's attention. He took a subordinate part in the struggle between the king and Rome as to the royal rights over vacant bishoprics; and he seems to have sympathized with the proposal that was made to seize part of the wealth of the clergy. In his hatred of idleness, he ventured to suppress no less than seventeen fêtes, and he had a project for lessening the number of those devoted to clerical and monastic life, by fixing the age for taking the vows some years later than was then customary. With heresy he was at first unwilling to interfere, for he was aware of the commercial value of the Huguenots; but when the king, under the influence of Mme. de Maintenon, resolved to make all France Catholic, he followed his Majesty, and urged his subordinates to do all that they could to promote conversions.

In art and literature Colbert took much interest. He possessed a remarkably fine private library, which he delighted to fill with valuable manuscripts from every part of Europe where France had placed a consul. He has the honor of having founded the Academy of Sciences (now called the Institut de France), the Observatory, which he employed Perrault to build and brought Cassini from Italy to superintend, the Academies of Inscriptions and Medals, of Architecture, and of Music, the French Academy at Rome, and Academies at Arles, Soissons, Nîmes, and many other towns, and he reorganized the Academy of Painting and Sculpture which Richelieu had established. He was a member of the French Academy; and one very characteristic rule, recorded to have been proposed by him with the intention of expediting the great Dictionary, in which he was much interested, was that no one should be accounted present at any meeting unless he arrived before the hour of commencement and remained till the hour for leaving. In 1673 he presided over the first exhibition of the works

of living painters; and he enriched the Louvre with hundreds of pictures and statues. He gave many pensions to men of letters, among whom we find Molière, Corneille, Racine, Boileau, Huet, and Varillas, and even foreigners, as Huyghens, Vossius the geographer, Carlo Dati the Dellacruscan, and Heinsius the great Dutch scholar. There is evidence to show that by this munificence he hoped to draw out praises of his sovereign and himself; but this motive certainly is far from accounting for all the splendid, if in some cases specious, services that he rendered to literature, science, and art.

Indeed to everything that concerned the interests of France Colbert devoted unsparing thought and toil. Besides all that has been mentioned, he found time to do something for the better administration of justice (the codification of ordinances, the diminishing of the number of judges, the reduction of the expense and length of trials), for the establishment of a superior system of police, and even for the improvement of the breed of horses and the increase of cattle. As superintendent of public buildings he enriched Paris with boulevards, quays, and triumphal arches; he relaid the foundation-stone of the Louvre, and brought Bernin from Rome to be its architect; and he erected its splendid colonnade upon the plan of Claude Perrault, by whom Bernin had been replaced. He was not permitted, however, to complete the work, being compelled to yield to the king's preference for residences outside Paris, and to devote himself to Marly and Versailles.

Amid all these public labors his private fortune was never neglected. While he was reforming the finances of the nation, and organizing its navy, he always found time to direct the management of his smallest farm. He died a millionaire, and left fine estates all over France. For his eldest son, who was created Marquis de Seignelay, he obtained the reversion of the office of minister of marine; his second son became archbishop of Rouen; and a third son, the Marquis d'Ormoï, became superintendent of buildings.

In estimating the value of Colbert's ministry, two distinct questions must be considered—What its results would have been in the absence of counteracting influences, over which he had no control, and what they actually were. To the first it may be answered that France, peaceful, enriched by a wide-spread commerce, and freed from the weight of taxes, alike heavy and intrinsically mischievous, would probably have developed powers that would have enabled her to throw aside what was harmful in his policy, and possibly to attain liberty without the frenzied struggle of the Revolution. To the second question a very different reply must be given. What the great "ministère de la paix" built up was torn down, even as he built it, to erect the unholy fabric of his master's military glory. The war department was in the hands of Colbert's great rival Luvois; and to every appeal for peace Louis was deaf. He was deaf also to all the appeals against the other forms of his boundless extravagance which Colbert, with all his deference towards his sovereign, bravely ventured to make.<sup>1</sup>

Thus it came about that, only a few years after he had commenced to free the country from the weight of the loans and taxes which crushed her to the dust, Colbert was forced to heap upon her a new load of loans and taxes more heavy than the last. Henceforth his life was a hopeless struggle, and the financial and fiscal reform which, with the great exception of the establishment of the navy, was the most valuable service to France contemplated by him, came to naught.

Depressed by his failure, deeply wounded by the king's favor for Luvois, and worn out by overwork, Colbert's strength gave way at a comparatively early age. In 1680 he was the constant victim of severe fevers, from which he recovered for a time through the use of quinine prescribed by an English physician. But in 1683, at the age of sixty-four, he was seized with a fatal illness, and on the 6th of September he expired. It was said that he died of a broken heart, and a conversation with the king is reported in which Louis disparagingly compared the buildings of Versailles, which Colbert was superintending, with the works constructed by Luvois in Flanders. He took to bed, it is true, immediately afterwards, refusing to receive all messages from the king; but his constitution was utterly broken be-

fore, and a post-mortem examination proved that he had been suffering from stone. His body was interred in the secrecy of night, for fear of outrage from the Parisians, by whom his name was cordially detested.

Colbert was a great statesman, who did much for France, and would have done vastly more had it been possible. Yet his insight into political science was not deeper than that of his age; nor did he possess that superiority in moral qualities which would have inspired him to bring in a reign of purity and righteousness. His rule was a very bad example of over-government. In popular liberty he did not believe; the parliaments and the States-General received no support from him. The technicalities of justice he never allowed to interfere with his plans; justice herself he sometimes commanded to stay her course, and beware of crushing any friend of his who happened to lie in her way. He trafficked in public offices for the profit of Mazarin and in his own behalf. He caused the suffering of thousands in the galleys; he had no ear, it is said, for the cry of the suppliant. There was indeed a more human side to his character, as is shown in his letters, full of wise advice and affectionate care, to his children, his brothers, his cousins even. Yet to all outside he was "the man of marble." To diplomacy he never pretended; persuasion and deceit were not the weapons he employed; all his work was carried out by the iron hand of authority. He was a great statesman in that he conceived a magnificent yet practicable scheme for making France first among nations, and in that he possessed a matchless faculty for work, neither shrinking from the vastest undertakings nor scorning the most trivial details.

Numerous *vies* and *éloges* of Colbert have been published; but the most thorough student of his life and administration was Pierre Clément, member of the Institute, who in 1846 published his *Vie de Colbert*, and in 1861 the first of the 9 vols. of the *Lettres, instructions, et mémoires de Colbert*. The historical introductions prefixed to each of these volumes have been published by Mme. Clément under the title of the *Histoire de Colbert et de son administration* (1874). Among Colbert's papers are *Mémoires sur les affaires de finance de France* (written about 1663), a fragment entitled *Particularités secrètes de la vie du Roy*, and other accounts of the earlier part of the reign of Louis XIV. (T. M. W.)

COLCHESTER, a market-town, municipal and parliamentary borough, and river-port of England, in the county of Essex, 51 miles from London by the Great Eastern Railway, on the Colne, which is there crossed by three bridges. The town within the walls forms an oblong of about 108 acres; but new streets stretch far beyond these limits. Large alterations have taken place since the accession of Queen Victoria: the Middle Row and various other districts have been abolished or rebuilt; the streets have been repaved, and a new supply of water obtained for the town. Of the buildings in Colchester of interest for their antiquity the first is the castle or keep, which occupies an area of 21,168 square feet (or nearly twice that of the White Tower of London), and thus forms the largest specimen extant of this department of Norman architecture. It was founded in the 12th century by Eudo, the steward of Henry I., to whom the city was also indebted for the Benedictine abbey of St. John's, now almost totally demolished. Of the churches the oldest is St. Peter's, which, like several others, has been restored within recent years; the remains of the church of St. Botolph's priory, founded in the early part of the 12th century, present fine examples of Norman workmanship; and St. James's, St. Giles's, and St. Leonard's at the Hythe are all of antiquarian interest. The last preserves some early frescoes. The present century has added largely to the number of the churches and chapels, and many of the newer buildings are not unworthy of the city in which they stand. Of secular structures the most important are the town hall, the county police station (formerly the county jail), the borough jail, the theatre, two corn exchanges, the Eastern Counties asylum for idiots and imbeciles, the Essex and Colchester hospital, the assembly rooms, and the public baths. The town also possesses a free grammar-school, with a scholarship at St. John's College, Cambridge; a literary institute with a library attached, botanic gardens, a literary, a medical, and other societies. Colchester is the centre of a large agricultural district, and has very extensive corn and cattle markets. Baize was formerly the principal manufacture; but this has been superseded by silk, more especially the kind employed for umbrellas. The

<sup>1</sup> See especially a *mémoire* presented to the king in 1666, published in the *Lettres etc., de Colbert*, vol. II.

minor industrial establishments include flour-mills, vinegar-works, foundries, engineering works, rope-yards, printing-offices, and lime-works. The import and export trade is conducted at the suburb of Hythe, to which vessels of 150 tons can come up the river. In 1874 the value of the imports was £48,377, and of the exports £9173. The oyster fishery, for which the town has been famous for centuries, is not so extensive as it once was; but it is still carried on under the control of the Colchester town council, and mea-



Arms of Colchester.

ures are taken for its maintenance and development. The borough, which returns two members to parliament, has an area of 11,314 acres; the population was in 1871, 26,343, an increase since 1861 of 2534, and since 1801 of 14,823. Colchester is the head-quarters of the Eastern Military District.

That Colchester occupied the site of some important Roman city was all along abundantly evident; but it is only within the present century that it has been definitively identified with Camulodunum. This Roman settlement was established by Claudius, to assist in the reduction of the fierce Silurians; but its existence was jeopardized by the sudden rise of the Iceni to avenge the wrongs of Boadicea. The colonists were massacred, their houses burned, and the site left a mass of ruins. The Roman general, Suetonius Paullinus, however, soon after recovered possession of the place; strong fortifications were erected, and the colony soon attained a high degree of prosperity. To the present day the walls then erected remain almost intact, and form one of the noblest specimens of Roman architecture in the island. Minor antiquities—such as Samian pottery, coins, articles of ornament—occur in the greatest profusion; and, both within the city and in the neighborhood, numerous villas have been discovered, with tessellated pavements, hypocausts, and baths. The coins belong to all periods, down to the secession of the Romans from the island. On the arrival of the Saxons the old name of Camulodunum gave place to that of Colnecestor, or the Castrum on the Colne, which is still preserved in the present modification. In 921 the town was recovered from the Danes by Edward the Elder, and its fortifications were strengthened. At the time of the *Domesday Book* it was a place of decided importance, and in the reign of Edward III. it sent five ships and 140 seamen to the siege of Calais. In 1348 and 1360 it was ravaged by the plague, which again visited it in the dreadful year of 1665. Meanwhile it was the scene of a memorable siege; having in 1648 declared for the Royalists, it was captured by Fairfax, after an investment of eleven weeks, its gallant defenders, Sir C. Lucas and Sir C. Lisle, were put to death, and the castle was dismantled. See Morant's *Essex*; Rev. Henry Jenkins's "Observations on the Site of Camulodunum" in vol. xxix. of the *Archæologia*, 1842, and the same author's *Colchester Castle built as a Temple of Claudius Cæsar*, 1852; Rev. Edward A. Cutts's *Colchester Castle not a Roman Temple*, 1853.

COLCHESTER, CHARLES ABBOT, LORD (1757-1829), born at Abingdon, was the son of Dr. John Abbot, rector of All Saints, Colchester, and, by his mother's second marriage, half-brother of the famous Jeremy Bentham. From Westminster School, Charles Abbot passed to Christ Church College, Oxford, where he gained the chancellor's medal for Latin verse and the Vinerian Scholarship. In 1795, after having practised twelve years as a barrister, and published a treatise proposing the incorporation of the judicial system of Wales with that of England, he was appointed to the office previously held by his brother of clerk of the rules in the King's Bench; and in June of the same year he was elected member of parliament for Helston, through the influence of the duke of Leeds. In 1796 Abbot commenced his career as a reformer in parliament, by obtaining the appointment of two committees,—the one to report on the arrangements which then existed as to temporary laws or laws about to expire, the other to devise methods for the better publication of new statutes. To the latter

committee, and a second committee which he proposed some years later, it is owing that copies of new statutes were thenceforth sent to all magistrates and municipal bodies. To Abbot's efforts were also due the establishment of the Royal Record Commission, the reform of the system which allowed the public money to lie for some time at long interest in the hands of the public accountants, and, most important of all, the Act for taking the first census, that of 1801. On the formation of the Addington ministry in March, 1801, Abbot became chief secretary and privy seal for Ireland; and in the February of the following year he was chosen speaker of the House of Commons—a position which he held with universal satisfaction till 1817, when an attack of erysipelas compelled him to retire. In response to an address to the Commons, he was raised to the peerage as Baron Colchester, with a pension of £4000, of which £3000 was to be continued to his heir. On the 8th May, 1829, he died of erysipelas. His speeches against the Roman Catholic claims were published in 1828.

COLCHICUM, the Meadow Saffron, or Autumn Crocus (*Colchicum autumnale*), is a perennial plant of the natural order *Melanthaceæ* or *Colchicaceæ*, found wild in rich moist meadow-land in England and Ireland, in Middle and Southern Europe, and in the Swiss Alps. It has pale-purple flowers, rarely more than three in number; the perianth is funnel-shaped, and produced inferiorly into a long slender tube, in the upper part of which the six stamens are inserted. The ovary is three-celled, and lies at the bottom of this tube. The leaves are three or four in number, flat, lanceolate, erect, and sheathing; and there is no stem. Propagation is by the formation of corms from the parent bulb, and by seeds. The latter are numerous, round, reddish-brown, and of the size of black mustard-seeds. The bulb of the meadow-saffron attains its full size in June or early in July. A smaller bulb is then formed from the old one, close to its root; and this in September and October produces the crocus-like flowers. In the succeeding January or February it sends up its leaves, together with the ovary, which perfects its seeds during the summer. The young corm, at first about the diameter of the flower-stalk, grows continuously, till in the following July it attains the size of a small apricot. The parent bulb remains attached to the new one, and keeps its form and size till April in the third year of its existence, after which it decays. In some cases a single corm produces several new plants during its second spring by giving rise to immature corms.

Colchicum owes its medicinal properties to an alkaloid, named *colchicine*, which is present in all parts of the plant. It was discovered by Pelletier and Caventon, and was identified as distinct from veratrine by Geiger and Hesse in 1833. According to Oberlin, colchicine is a complex body, containing a crystallizable neutral substance, colchicine. Hübler assigns to colchicine the formula  $C_{17}H_{19}NO_7$ , and considers it to be isomeric with colchicineine (*Arch. der Pharm.*, tom. cxi. 194; *Journ. de Pharm. et de Chim.*, tom. ii. 490, 4th ser.). It is an intensely bitter body, soluble in alcohol and water, but insoluble in ether, and is a powerful poison, small quantities causing violent vomiting and purging; tannin, which precipitates it from solution, has been recommended as an antidote for it. Colchicine is present in smaller quantity in the seeds than in the bulbs; and in the latter, according to Stolze, it is more abundant in spring than in autumn; Shroff, however, states the corms for medicinal use should be collected after or during the time of flowering. The preparations of colchicum employed as medicine are the extract, made by macerating dried shreds of the bulbs in sherry or acetic acid, the expressed juice of the bulbs, purified and concentrated by heating, straining, and evaporation at a temperature below 160° Fahr., and an alcoholic tincture of the seeds. Whether swallowed or injected into the veins colchicum acts as an irritant of the stomach and intestines and a nervine sedative; small doses stimulate the secreting and excreting functions, but when continued they impair the appetite, and much disturb the stomach. Large quantities produce vomiting, profuse perspiration, heat in the abdomen, considerable reduction of the rate of the pulse, and dysenteric symptoms, and may cause death from exhaustion.

Colchicum was known to the Greeks under the name of  $\kappa\omicron\lambda\chi\iota\sigma\omicron\varsigma$ , from  $\kappa\omicron\lambda\chi\iota\varsigma$ , or Colchis, a country in which the plant grew; and it is described by Dioscorides as a poison. In the 17th century the corms were worn by some of the German peasantry as a charm against the plague. The drug was little used

1763, when Baron Störck of Vienna introduced it for the treatment of dropsy. In febrile diseases it was first extensively employed by Mr. Haden. As a specific for gout, colchicum was early employed by the Arabs; and the preparation known as *ess. médicinale*, much resorted to in the last century for the cure of gout, owes its therapeutic virtues to colchicum; but general attention was first directed by Sir Everard Home to the use of the drug in gout. Full doses are apt to provoke sickness and diarrhoea, but give immediate relief from the sufferings caused by arthritic disease; whereas small quantities are not effectual for several days. According to Dr. A. B. Garrod, the beneficial effects of colchicum are not explicable either by its purgative properties, or by its sedative influence on the vascular system; nor is there evidence that it produces any of its effects by causing an increase in the elimination of urea and uric acid by the kidneys. Dr. Graves considers that colchicum operates in gout by lessening the formation of uric acid in the system.

Colchicum may often be employed in acute rheumatism, in the treatment of bronchitis, asthma, eruptions of the skin, and of dyspepsia in gouty patients; also as a cholagogue instead of mercurials. The "hermodactyl" of ancient writers is supposed to be the same as the modern drug of that name, which consists of the oozes of a species of colchicum.

See Christison, *Treatise on Poisons*, 4th ed., pp. 891-6 (1845); Flücker and Hanbury, *Pharmacographia*, p. 686 (1874); Garrod, *Gout and Rheumatic Gout*, 3d ed., chap. xi. (1878); *English Botany*, ed. J. T. Bowell Syme, 3d ed., vol. ix., p. 225 (1869); Balfour, *Class Book of Botany*, 3d ed., p. 931 (1871). On Colchicine, see Watts's *Chemical Dictionary*, vol. i.; Wurtz, *Dictionnaire de Chimie*, t. ii.

COLCHIS, in ancient geography, a nearly triangular district of Asia Minor, at the eastern extremity of the Black Sea, was bounded on the N. by the Caucasus, which separated it from Asiatic Sarmatia, E. by Iberia and the Montes Moschici, S. by Armenia and part of Pontus, and W. by the Euxine. The ancient district is represented by the modern province of Mingrelia, and part of Abasia. The name of Colchis is first found applied to this country by the Greek poets Æschylus and Pindar. It was celebrated in Greek mythology as the destination of the Argonauts, the residence of Medea, and the special domain of sorcery. At a remote period it seems to have been incorporated with the Persian empire, though the inhabitants ultimately erected their territory into an independent state; and in this condition it was found by Alexander the Great, when he invaded Persia. From this time till the era of the Mithridatic wars nothing is known of the history of Colchis. At the time of the Roman invasion it seems to have paid a nominal homage to Mithridates, and to have been ruled over by Machares, the second son of that monarch. On the defeat of Mithridates by Pompey, it became a Roman province. After the death of Pompey, Pharnaces, the son of Mithridates, rose in rebellion against the Roman yoke, subdued Colchis and Armenia, and made head, though but for a short time, against the Roman arms. After this Colchis was incorporated with Pontus, and the Colchians are not again alluded to in ancient history till the 6th century, when, along with the Abasci they joined Cosroes I., king of Persia, in his war against Justinian. Colchis was inhabited by a number of tribes whose settlements lay chiefly along the shore of the Black Sea. The chief of these were the Lazi, Moschi, Absideæ, Abasci, Sagadæ, Suani, and Coraxi. These tribes differed so completely in language and appearance from the surrounding nations, that the ancients themselves originated various theories to account for the phenomenon. Herodotus, for example, believed them to have sprung from the relics of the army of Sesostris, and thus identified them with the Egyptians. Though this theory was not generally adopted by the ancients, it has been defended, but not with complete success, by some modern writers. From the first-named of these tribes, the Lazi, the country was latterly known as Terra Lazica.

COLDSTREAM, a town of Scotland, in Berwickshire, 15 miles west of Berwick, on the north bank of the Tweed, there crossed by a bridge of five arches. It is situated on the principal thoroughfare between England and Scotland, and in the neighborhood of the ford by which the Scotch and English armies were wont to cross the river in olden times. In the period before the Reformation it was the seat of a priory famous in history as the place where the Papal legate, in the reign of Henry VIII., published a bull against the printing of the Scriptures; and in the present century, by a curious irony of fate, the very site of the building was occupied by an establishment under Dr. Adam Thomson for the production of Bibles at a low rate. Coldstream, like Gretna Green, was formerly celebrated for

its irregular marriages. The regiment of Foot Guards known as the "Coldstream Guards" was so named from General Monk having set out with it from the town on his march into England in 1659. Population in 1871, 2619.

COLEBROOKE, HENRY THOMAS (1765-1837), an eminent Oriental scholar, the third son of Sir George, the second baronet of that name, was born in London. He was educated at home, and when only fifteen he had made considerable attainments in classical and mathematical studies. From the age of twelve to sixteen he resided in France, and in 1782 was appointed to a writership in India. About a year after his arrival there he was placed in the Board of Accounts in Calcutta; and three years later he was removed to a situation in the revenue department of Tirhoot, where he pursued his studies in Eastern science and literature. In 1789 he was removed to Purneah, where he investigated the resources of that part of the country, and published his *Remarks on the Husbandry and Commerce of Bengal*, in which he advocated free trade between Great Britain and India. After eleven years' residence in India, Colebrooke began the study of Sanskrit, and to him was confided the translation of the great digest of Hindu law, which had been left unfinished by Sir William Jones. After filling a number of important offices, and publishing some works on Oriental literature, including a Sanskrit grammar and dictionary, he returned to London, where he died, March 18, 1837. He was a director of the Asiatic Society, and many of the most valuable papers in the Society's *Transactions* were communicated by him.

COLEOPTERA, or BEETLES, a vast and remarkably homogeneous order of insects, characterized, as the name implies (*κόλερα*, a sheath, and *πτερά*, wings), by the structure of the upper wings, or *elytra*, as they are called, which are so modified as to form shields for the protection of the under wings—the true organs of flight in those insects. The name was given, and the principal characters of the order defined, by Aristotle; and owing doubtless to their singular and varied forms and habits, the brilliant coloring and great size of numerous species, and that solid consistence which renders their collection and preservation comparatively easy, Coleopterous insects have since the days of the Stagirite received the special attention of entomologists.

The body in Coleoptera is enclosed in a chitinous integument of a more or less rigid consistence, and is somewhat oval in form, although in most cases greatly longer than broad. In this respect, however, the utmost diversity prevails even among the members of the same family, the form being modified to suit the habits of the insect. Thus, according to Bates, among the South American forms of *Dermestidae*, the species of one group are cubical in shape, and live in dung; those of another, inhabiting the stems of palm trees, are much flatter; those of a third, only found under the bark of trees, are excessively depressed, some species being literally "as thin as a wafer;" while the members of a fourth group of the same family are cylindrical in shape, and are woodborers, "looking," says Bates, "like animated gimlets, their pointed heads being fixed in the wood, while their glossy bodies work rapidly round so as to create little streams of sawdust from the holes" (*Naturalist on the Amazons*). The body, in common with that of all other insects, is divided into three parts, head, thorax, and abdomen. The head, which is usually rounded or somewhat triangular in shape (except in the Weevil tribe, where it is produced into an elongated rostrum or snout), bears the organs of the senses. The eyes of beetles are two in number and compound, and in predaceous species are somewhat protuberant, thus affording greater range of vision. The simple eyes, or *ocelli*, common among butterflies and moths, are almost unknown among beetles, although present in the larvæ. In many species, especially of Lamellicorn Beetles, these organs are more or less completely divided by a process known as the *canthus*; and in the *Gyrinidae*, or Whirligigs, the intersection is so complete as to give the appearance of a pair of eyes on each side. In burrowing and cave-dwelling species, whose lives are spent in almost total darkness, the eyes, although distinctly visible in the young, become more or less atrophied in the adult forms. The two antennæ, supposed by some to be organs of hearing, and by others of smell, are placed between or in front of the eyes, and usually consist of 11 joints. These differ greatly in

form and size, not only in different species, but in the two sexes of the same species, the most prevalent forms being the setaceous, moniliform, serrate, pectinate, clavate, and lamellate. In many groups the antennæ are exceedingly short, while in such forms as the Longicorn Beetles they, in a few cases, measure four times the length of the body.

The parts which go to form the mouth are typically developed in beetles, and for this among other reasons the order Coleoptera has generally been placed at the head of the class of insects. It is known as the masticatory mouth, and consists of the four parts (Plate VI., fig. 1). (1) The *labrum*, or upper lip, is usually a continuation of the upper surface of the head. (2) The *mandibles*, or true masticatory organs, consist of two powerful arched jaws generally dentated, moving horizontally and opposed to each other, the teeth in some cases interlocking, in others, as in the Tiger Beetles, crossing like the blades in a pair of scissors. In many species they are so small as to be almost concealed within the cavity of the mouth, while in such forms as the Stag Beetles they measure half the length of the entire body. The form and texture of the mandibles are largely dependent on the nature of the insect's food, being acute and sharply dentated in predaceous species, and thick and blunt in vegetable feeders. Their margins are soft and flexible in those which feed on decaying animal and vegetable matters, while the entire mandibles are soft and flattened in those which live on fluids. (3) The *maxillæ*, or lesser jaws, placed beneath the mandibles, and like them moving horizontally, serve to hold the food and guide it to the mouth. Their extremities are in many cases furnished with a movable claw, and their inner surfaces with a series of bristles, which are probably of use in straining the juices from their food. The *maxillæ* are provided with a pair of appendages called *maxillary palps*—delicate organs that vibrate intensely, and are supposed to be principal organs of touch. (4) The *labium*, or lower lip, also provided with palps.

The thorax bears the organs of locomotion, consisting of three pairs of legs and two pairs of wings (Plate VI., fig. 2). The legs vary in their structure and development according to the habits of the species; thus in running and walking beetles these organs are usually of equal length, and generally similar in other respects, the anterior pair, however, being often stronger in the male than in the female; and in a few species, as the Harlequin Beetle, the anterior legs are enormously elongated and proportionately thickened. In burrowing beetles the anterior legs are developed into fossorial organs with broad and strongly dentated tarsi, and in arboreal forms the under side of the tarsi is usually covered with hair, forming a cushion-like sole terminating in toothed claws, by which they are enabled to keep their footing on the leaves and branches of trees. Water beetles generally have the posterior pair of legs elongated, flattened, and ciliated, so as to form swimming organs; those known as Whirligigs using the middle and posterior pairs for this purpose, while the anterior limbs are employed as rudders; and jumping beetles, as *Halticidae*, have the thighs of the posterior pair of legs greatly thickened for saltatory purposes (Plate VIII., fig. 10). The two anterior wings become solidified in beetles, and are thus rendered useless as organs of flight. They are termed *elytra* (*ἐλύτρον*, a shield), and serve to protect the delicate wings beneath, as well as the *stigmata*, or breathing pores, placed along the sides of the abdomen. The *elytra* are always present except in the females of a few species, as the Glow-worm, and are generally large enough to cover the upper surface of the abdomen and to conceal the under wings when at rest. In Brachelytrous Beetles, however, they are exceedingly short, and the wings in these are only shielded by being folded more than once beneath them. The *elytra* when at rest meet on the middle of the back, their internal margins forming a straight longitudinal line or suture highly characteristic of the Coleoptera; but even this character is not universal, as in the Oil Beetles (*Meloidæ*) and a few others the one elytron partly folds over the other. The posterior wings are large, veined, and membranaceous and form the true organs of flight, but they are much more frequently absent than the *elytra*, and where this occurs, as in many Carabideous Beetles, the latter are more or less soldered together. During flight the *elytra* are either extended horizontally or merely raised without being separated, as in the Rose-Chafers (*Cetonia*);

and, as might be expected from their general stoutness of body and comparative deficiency of wings, the flight of beetles is heavy and seldom long sustained. Their weakness in this respect is further shown in the apparent inability of many species suddenly to alter their course so as to avoid collision with any object that may unexpectedly come in their way, a defect popularly but erroneously attributed, in the phrase "as blind as a beetle," to weakness of sight rather than of wing. In certain water beetles (*Dytiscidæ*) a pair of *ahula*, or winglets, are developed at the inner angle of the *elytra*.

The coloring of the chitinous integument of beetles is often exceedingly brilliant, and the *elytra* and other parts of many species are largely used in the manufacture of personal ornaments. This coloring can in many instances be shown to bear a close resemblance to that of surrounding nature; thus burrowing beetles, and those which dwell in subterranean caves, are generally black or brown; Weevils, found on the ground, are earth-colored; while arboreal species of this and other groups are of various shades of green. Bates found a species of beetle, on a particular tree in South America, which so resembled the bark on which it spent its existence as to be, when motionless, no longer visible. This assimilation in color to surrounding nature is probably useful in assisting them to elude their enemies; and when the markings are such as to render the beetle conspicuous it is often provided with, and no doubt protected by, an offensive odor or nauseous juices; thus the naturalist already mentioned found on a sandy beach two species of Tiger Beetles, the one of a pallid hue like the sand it ran upon, the other of a brilliant and conspicuous copper color, but having a "strong, offensive, putrid, and musky odor," from which the other was entirely free. Fireflies, a group of Coleopterous insects, are also exceedingly conspicuous, but are similarly protected. The phenomena of mimicry, or the imitation of one animal by another for protective purposes, have been observed in several instances among beetles. Mr. Belt, in his interesting work, *The Naturalist in Nicaragua*, states that he captured what he supposed was a hairy caterpillar, but on closer inspection he found it to be a Longicorn Beetle, the antennæ being concealed among the hair. Hairy caterpillars are almost universally rejected by insect-eating animals, and thus probably this beetle shared in the immunity from attack accorded to its model. A species of beetle found in South America closely resembles a bee found in the same locality, its body being covered with hair and its legs similarly tufted; another with yellow banded abdomen, sufficiently resembled a wasp as to make its captor both cautious and timid in handling it at first. One of the *Chrysomelidæ* (*Oriocoris meridigera*) is said to disguise itself by covering its upper surface with its own dung; while many species to be afterwards noticed, when in danger, simulate death. Brilliant coloring in beetles is not as in some orders of animals a characteristic mainly of the male sex, both sexes being usually similar in this respect, while in those cases in which they differ, the female is generally the more gaudy insect. The chief external difference, however, between the sexes in many beetles is to be found in the presence of horns on the head and thorax of the males. These vary exceedingly in their development even in individuals of the same species, while in their form they resemble the horns of the rhinoceros and the antlers of the stag; and as among mammals the reindeer is exceptional in the possession of antlers by both sexes, so among beetles there is at least one species, *Phanoxis lancifer*, in which both male and female are similarly equipped. The male beetle has not been observed to use its horns either for purposes of offence or defence, some of the most pugnacious species being entirely destitute of them; and in Darwin's opinion these appendages have been acquired merely as ornaments.

The abdomen of Coleopterous insects is sessile—that is, attached to the thorax by its largest transverse diameter. On the under side it is always of a firm horny consistence, while the upper surface is generally soft, being protected by the *elytra* and wings; when these, however, are absent or abbreviated, it is as hard above as below. It bears the organs of generation as well as the respiratory openings, or *stigmata*, which form the apertures of the tracheæ by means of which air is disseminated through all parts of the insect system. Beetles belonging to several distinct families possess stridulating organs, and these are generally

found in both sexes. The apparatus by which the sound, loud enough to be heard in many cases at some yards distance, is produced, consists of a couple of delicate rasps placed on the upper surface of the abdomen, on the elytra, or on the prothorax, and a scraper formed by the margins of the elytra, the edges of the abdominal segments, or the mesothorax, the rapid motion of the latter over the rasps producing the sound. In many cases, according to Darwin, the males only stridulate, the females being destitute of those organs, and in such cases the sound is employed as a call to the female; with most beetles, however, the stridulation proceeds from both sexes and serves as a mutual call. Beetles are entirely destitute of stinging organs, but a few are furnished with a retractile tube, or *ovipositor*, at the extremity of the abdomen, by means of which they deposit their eggs in the cracks of wood and other suitable localities.

The eggs of beetles are deposited in a great variety of situations, and in the case of a certain group of *Staphylinidae*, found in the nests of white ants in South America, it was recently discovered by Schödté that the eggs are not deposited at all, but remain in the abdomen until they are hatched. These ovo-viviparous beetles are only one-tenth of an inch in length, and have the abdominal region enormously distended and turned over so as to rest on the back. Dung beetles deposit their eggs in the midst of the manure on which the future larvæ feed; the Sacred Beetle of Egypt rolling each of hers about until a globular pellet is formed, when the whole is buried in the ground; while the Sexton Beetle finds an appropriate *nidus* for her eggs in the dead bodies of animals. One species of *Clerida* selects the nest of the solitary bee, another (Plate VII. fig. 31) that of the hive bee, while several species of Rose Beetles choose the nest of the ant for this purpose. The water beetles belonging to the genus *Hydrophilus* deposit their eggs in a single mass, which they surround with a cocoon, formed of a silky substance secreted by certain glands in the abdomen, and then either fix this to the leaf of an aquatic plant or leave it to float on the surface of the water. Certain species of the Weevil tribe deposit their eggs on the leaves of trees, splitting the median nervures in several places, and afterwards rolling them up. In its progress from the egg to the perfect insect the beetle undergoes complete metamorphosis, passing from the larval to the pupa stage, and remaining totally quiescent during the latter. Coleopterous larvæ generally consist of 13 segments, of which those forming the head and thorax are usually of a hard horny texture,—the mouth, as in the perfect insect, being masticatory, and the eyes, when present, simple, or *ocelli*. They have usually six legs, and prolegs, as in caterpillars, are occasionally present; but the larvæ of many species are legless grubs, while in others the limbs are but feebly developed. In those groups in which the elytra are abbreviated, the larvæ are exceedingly active and closely resemble the perfect insect. Like their parents the larvæ of beetles feed on living animals, on plants, or on decaying animal and vegetable substances, but greatly exceed the perfect insect in the quantity of food which they consume, and it is in this condition that beetles do most injury to field crops and forest trees. The larvæ of burrowing beetles, known as "White Worms," spend their existence in the earth, and are destitute of eyes; those of the Stag Beetles and other wood-boring groups live in the trunks of decaying trees; mealworms—the larvæ of *Tenebrio molitor*—live enveloped in flour, and those of the Corn Weevil in the heart of the wheat grain; while those of another species of Weevil make their homes in the fleshy parts of the receptacles of composite flowers. The larvæ of Oil Beetles (*Meloidæ*), or at least certain species of them whose life-history has been observed, after leaving the egg, which the perfect insect has deposited just beneath the surface of the ground, climb upon the stems of plants, and take the first opportunity of attaching themselves to any insect that may happen to alight near them, and in this way they are occasionally conveyed into the hives of bees, in which alone they meet with their appropriate food. Only a few of them are thus fortunate, the majority of the larvæ getting attached to the wrong insect, and so perishing of hunger. The species probably owes its preservation to the great number of eggs, amounting to upwards of 4000, deposited by a single female. The larvæ of one group of water beetles, *Hydrophilus*, swim readily by means of their ciliated legs those of another group, *Dytiscus*, make use

also of their flexible abdomen provided at its extremity with a pair of leaf-like appendages (Plate VII. fig. 6); while the Whirligig larvæ (*Gyrinus*), in addition to ciliated swimming organs, are provided with four movable hooks on the posterior segment, by which they are enabled to take extensive leaps (Plate VII. fig. 17). The duration of the larval state varies in different groups of beetles, being comparatively short in leaf-eating species, but lasting for three or four years in those which burrow in the earth or in wood. The larvæ in the latter case pass the winter in a torpid state, abstaining almost entirely from food, until awakened from their temporary trance by the return of genial weather, when they greedily attack their favorite food, and grow rapidly. In passing from the condition of a larva, the beetle does not, like the butterfly, assume a form altogether different from that of the perfect insect, but in the pupa or nymph state shows all the parts of the future insect, only in a condition of almost complete immobility. In preparing for this quiescent period, the larvæ of many species surround themselves with a cocoon, consisting, in the case of the *Scarabidae*, of earth and small pieces of wood glued together with saliva, and in that of the Goliath Beetles, of mud. Others resemble the larvæ of moths in constructing tubes in which to undergo their transformations, while the larvæ of Lady-Birds—*Coccinella*—suspend themselves by the tail and make use of their larval covering as a protection to the nymph within. When the condition of nymph is assumed in autumn, no further change takes place till the ensuing spring, but under suitable conditions of heat this stage does not last usually for more than three or four weeks, after which it emerges a full-blown beetle.

The number of known species of beetles is estimated at 70,000, and these are probably not more than one-half of the total number in existence—Great Britain alone possessing 3614 indigenous species. They occur in greatest abundance in the wooded parts of tropical regions. "A large proportion of the beetles of the tropics," says Wallace, "are more or less dependent on vegetation and particularly on timber, bark, and leaves in various stages of decay. In the untouched virgin forest the beetles are found at spots where trees have fallen through decay and old age." The number gradually decreases towards the poles, only a few species occurring as far north as Greenland. The six zoological provinces proposed by Mr. Sclater in 1859 as applicable to the existing distribution of birds, have lately been shown by Mr. A. K. Wallace, in his admirable work on the *Geographical Distribution of Animals* (1876), to mark off equally characteristic groups of Coleopterous insects, a conclusion arrived at from a study of the distribution of the following six important families:—

Cicindelidæ or Tiger Beetles,	containing 85 genera and 808 species.
Carabidæ or Ground Beetles,	" 620 " 8500 "
Cetonidæ or Rose-Chafers,	" 120 " 970 "
Lucanidæ or Stag Beetles,	" 45 " 529 "
Buprestidæ or Metallic Beetles,	" 109 " 2686 "
Longicornia or Long-horned Beetles,	" 1488 " 7576 "

The Palearctic Region, which comprises Europe, Africa north of the Sahara, and Northern Asia, possesses about 20,000 species of beetles, and is specially characterized by abundance of *Carabidæ*, nearly two-fifths of the entire number belonging to this region; Longicorns are also well represented by 196 genera, of which 51 are peculiar to it. The Coleoptera of the Canary Islands, Madeira, and the Azores are Palearctic, but are peculiar in the total absence of such forms as the Tiger Beetles, the Chafers, and the Rose-Chafers, also in the great number of wingless species. The latter are specially numerous in groups of beetles peculiar to those islands, but they also occur in other cases, 22 genera which either usually or at least sometimes are winged in Southern Europe having only wingless species in Madeira, while at least three species winged in Europe occur in those islands in an apterous condition. On the other hand, those species in Madeira which possess wings have them more largely developed than they are among allied continental forms; the strong-winged and the wingless thus appearing best suited to live in islands exposed, as these Atlantic groups are, to frequent storms. The Ethiopian Region, which includes Africa south of the Sahara and Madagascar, is specially rich in *Cetonidæ*, possessing 76, or more than half of the known genera, with 64 of these peculiar to it, of which no less than 21 are found exclusively in Madagascar. It has also 262 genera of Longicorns, 216 of which are peculiar. The Ori-

ental Region, comprising Southern Asia and the islands adjacent, contains some of the most remarkable forms of *Carabida*, as *Mormolyce phyllodes*, and is rich in gorgeous metallic beetles (*Buprestidae*) and in Longicorns, having 360 genera of the latter, with 70 per cent. peculiar to it. The Australian Region shows affinity with the Oriental in its Coleoptera; it is equally rich in peculiar forms of Longicorns, and is the richest of all the regions in *Buprestidae*, having 47, or more than one-half of the known genera, and 20 of these confined to it. Several genera belonging to this and other families have their species divided between the Australian and Neotropical or South American Regions, and this resemblance has given rise to the supposition that at some distant period a land connection existed between the two continents; it is more probable, however, as Wallace holds, "that it may have arisen from intercommunication during the warm southern period when floating timber would occasionally transmit a few larvae from island to island across the Antarctic seas." The Neotropical Region comprehends southern and Central America and the West Indies, and is enormously rich in Longicorn Beetles, having no fewer than 516 genera, of which 487 are found nowhere else. The most remarkable fact in the distribution of the Stag Beetles (*Lucanidae*) is their almost total absence from the tropical parts of this region, and their presence in North America, while in the Old World they are specially characteristic of the hottest parts of the Oriental and Australian Regions. The Nearctic Region comprises the northern and temperate parts of America, and is comparatively poor in Coleoptera, showing greater affinity, however, with the Palearctic than with the contiguous Neotropical Region.

The insects belonging to this extensive Order comprise numerous well-defined and generally recognized families, but great diversity of opinion exists as to the best mode of grouping these together so as to exhibit their natural affinities. Geoffroy, a French naturalist, was the first to make use of the number of joints in the tarsi for this purpose, a method adopted and extended by Olivier, and brought into general use by Latreille. According to the tarsal system the Coleoptera are divided into the following four sections:—(1) **PENTAMERA**, in which all the tarsi are five-jointed; (2) **HETEROMERA**, with five articulations to the first four tarsi and four to the posterior pair; (3) **TETRAMERA**, with four articulations to all the tarsi; and (4) **TRIMERA**, with all the tarsi three-jointed. Macleay, an English naturalist, altogether rejected the tarsal system of Geoffroy, and founded his five primary divisions on characters derived from the larvae of those insects—a system adopted by Stephens in his *Classification of British Insects*, and by several other English writers on this subject. The tarsal system is to a large extent artificial, and when slavishly followed brings together forms which in other respects differ very widely, while separating many that are as obviously related. Its simplicity and consequent easiness of application have, in the absence of a more natural system, led to its very general adoption by both British and foreign naturalists, who do not, however, apply it where obviously unnatural.

**PENTAMERA**.—The majority of the beetles in this section have the tarsi of the feet five-jointed, and they comprise fully one-half of all the known species of Coleoptera. It is subdivided into the following 8 groups:—

I. *Geodephaga*, or Predaceous Land Beetles, resemble the succeeding group and differ from other Coleoptera in having the outer lobe of the maxillæ distinct and articulated, thus appearing to possess six palpi. They are extremely active, their legs being admirably adapted for running; the majority are nocturnal in their habits, secreting themselves under stones and clods of earth; and all are carnivorous, feeding on other insects and occasionally devouring individuals of their own species, while their larvae are equally predaceous. They are exceedingly numerous in temperate regions, and are eminently serviceable in checking the increase of insects which feed on fruit and grain. The mandibles, by which they seize and tear their living prey, are long horny organs, hooked and sharp at the points, and toothed on the inner edges. This group includes the Tiger Beetles, *Cicindelidae* (Plate VI. figs. 4, 9-12), so called from the fierceness of their disposition, and probably also from the spots and stripes with which the elytra are generally adorned. Most of the species are diurnal, frequenting hot sandy districts, enjoying the bright sunshine, and flying for

short distances with great velocity. They are elegant in form and adorned with brilliant metallic colors, the prevalent hue being a golden green. The habits of the larvae of these insects are very remarkable. Unfit, from the softness of their bodies and the slowness of their motions, effectually to protect themselves from the attacks of their enemies, or to capture their prey on the surface of the ground, the larvae of the Tiger Beetles have recourse to stratagem, in order to effect these purposes. By means of their short thick legs, assisted by their powerful sickle-shaped jaws, they dig burrows in the sandy banks which they frequent, vertical for some distance, and afterwards curving so as to become horizontal. These are about a foot in depth, and within them the Tiger Beetle remains during its larval and pupa stages. In seeking its food the creature makes its way from the bottom of its den until the head segment, which is broad and flat, reaches the level of the ground, and thus blocks up the aperture of its tunnel. It remains fixed in this position by means of two bent hooks placed on the upper surface of the eighth segment, which is considerably thicker than the others, until an unsuspecting ant or other insect passing over or close to it is seized by its formidable jaws and speedily conveyed to the bottom of the pit-fall, where it is greedily devoured. Should the tunnels of different individuals happen to come in contact, the more powerful larva is said to devour its weaker neighbor. When full grown it closes the mouth of its burrow and there undergoes metamorphosis. The best known and most beautiful of British species is the Tiger Beetle, *Cicindela campestris*, of a sea-green color with six whitish spots on the elytra. When handled it exhales, according to Westwood, a pleasant odor like that of roses. Ground beetles (*Carabida*) are generally less brilliant in color than the Tiger forms, being more nocturnal in their habits, and with the jaws less formidably toothed. Many of the species are entirely apterous, with the elytra more or less soldered together, and the majority of them secrete an acrid juice which they expel when menaced or attacked. Of the latter the most remarkable are the Bombardier Beetles, *Brachinus* (Plate VI. fig. 8). These congregate together under stones, and when disturbed discharge a caustic fluid of an extremely penetrating odor, and so volatile that no sooner does it come in contact with the atmosphere than it passes into a vapor, accompanied by a considerable explosion, during which they seek to escape. When placed on the tongue this fluid causes a sharp pain and leaves a yellow spot somewhat similar to that produced by a drop of nitric acid. The Bombardiers are said to be capable of giving off as many as 18 of such discharges at a time. One of the most beautiful of European beetles is the *Calosoma sycophanta* (Plate VII. fig. 2), belonging to this group. Its body is of a deep violet color, and the elytra, which are striated and punctured, are of a rich green and gold tint. Both in the larva and perfect states these beetles frequent the trunks and branches of the oak, where they find their favorite food—the large caterpillars of the Processionary Moth (*Bombus processionea*), of which they devour enormous numbers, apparently undeterred by the hairs which clothe the body of the caterpillar, and which when seized by the human hand cause considerable pain. One of the most curious of Carabideous Beetles, *Mormolyce phyllodes* (Plate VI. fig. 5), is a native of Java. Its body is about 3 inches long and 1½ inches across the elytra. The latter are flat, thin, and greatly dilated, while the other parts of the body are remarkably depressed, the beetle thus somewhat resembling the Orthopterous leaf-insects, and hence the specific name *phyllodes*, or leaf-like. Many of the ground beetles, such as the typical *Carabi* (Plate VI. figs. 6, 7) and the *Calosoma*, live in the sunshine and are generally brilliant in coloring; others spend their existence in subterranean caves, and are both colorless and blind; while such forms as *Blennius areolatus*, found on the coast of Normandy, live for the most part under water, being only found when the tide is low.

II. *Hydradephaga*, or Carnivorous Water Beetles, are oval and somewhat depressed in form, with the two posterior pairs of legs flattened and otherwise fitted for swimming. They include the Diving Beetles (*Dytiscus*) and the Whirligigs (*Gyrinus*). The former (Plate VII. figs. 3-7) occur in all quarters of the globe, and are truly amphibious, for although water is their favorite element, they survive for a long time on moist land, and most of them fly about in the evening and morning twilight with

great power and speed. When needing to breathe they allow themselves to float on the surface of the water, raise their elytra, and expose their stigmata to the atmosphere, thus getting quit of exhausted air and obtaining a fresh supply, which is stored up by closing the elytra. They are exceedingly voracious, devouring aquatic insects, as *Hydrophilus piceus*, much larger than themselves, and doing considerable damage in fish ponds by devouring the young fish. They are readily kept in confinement, having been known to live thus for 3½ years, feeding on raw beef and insects. The larvæ are even more voracious than the perfect insects, sucking the juices of their prey through perforated mandibles, and protected from attack by their horny integuments. Whirligigs (*Gyrinus*) (Plate VII. figs. 10, 11) differ from the Diving Beetles in the antennæ, which are short and stout, and are so placed as somewhat to resemble ears. They are sociable creatures, and may be seen in ponds and ditches, congregated in groups varying from 2 to 100, swimming upon the surface with their backs above the water, and chasing each other in circles or darting about in more irregular gyrations. Unlike other water beetles, their backs show a brilliant metallic lustre, and when darting about in the sunshine they look like pearls dancing on the surface. Their eyes are so divided as to appear to consist of two turned upwards and another pair looking downwards. The larvæ (Plate VII. fig. 17) are long, slender creatures somewhat resembling small centipedes, having each of the abdominal segments provided with a pair of slender ciliated appendages employed as organs of respiration as well as of locomotion, while the last segment is provided with four hooked organs by means of which they leap about.

III. *Philhyridæ*, or Water-loving Beetles, are aquatic or subaquatic in their habits, being found in the water or on the moist margins of ponds and marshes. Along with the two following groups they feed on decaying animal and vegetable substances, and for this reason these insects have been classed together as *Rhyphoga*, or Cleansers. The antennæ are short and clavate, and they are specially distinguished from other aquatic forms by the great length of the maxillary palps, a feature which has procured for them the name *Pulpicornes*, often applied to them. The best known forms belong to the family *Hydrophilidæ*, of which one species, and that the largest, *Hydrophilus piceus* (Plate VII. fig. 32), is an inhabitant of Europe. This beetle is oval in form and of a dark olive color, and measures 1½ inches in length. It uses its hind legs for swimming, or rather paddling, moving them not together, as the true water beetles do, but alternately. Its movements in the water are thus slower than those of the former, but speed in this case is less necessary, their principal food consisting of aquatic leaves. In the larval stage, however, *H. piceus* makes an approach to the true water beetles in its food, and is so ferocious as to have earned the name *ver assassin* on the Continent. The mode of respiration in the perfect insect is curious; unable to raise its upper surface above the water, it merely protrudes its head, and folding its club-shaped antennæ, the ends of which are slightly hollow, it thus conveys little bubbles of air beneath the surface of the water, where it brings them into contact with the tracheal openings. The larvæ swim with facility, and are provided at the posterior extremity with two appendages which serve to maintain them at the surface when they ascend to breathe.

IV. *Necrophaga* are the beetles of most service in removing decaying animal matter, although a few species live on putrescent fungi, and others resemble the carnivorous groups in attacking and devouring the larvæ of other insects. They are chiefly marked by the form of the antennæ, which are not much longer than the head, and get thickened or club-shaped at the extremity. This group comprises the Sexton Beetles (*Necrophorus*), of which *Necrophorus vespillo* (Plate VII. fig. 27) may be taken as the type. These insects have thick bodies and powerful limbs, and owe their popular name to the peculiar manner in which they provide a *nidus* for their eggs. Their sense of smell is exceedingly acute, and no sooner does one of the smaller quadrupeds, as mice or moles, die, than several of these burying beetles, gathering about, begin to remove the earth from beneath the dead animal, and in a few hours succeed in sinking the carcase beneath the level of the ground, which they then cover over with earth. Having thus prevented the body from being de-

voured by other carrion-eating animals, or from having its juices dried up by exposure to the sun, they make their way into the carcase and there deposit their eggs. Several individuals generally work together in this grave-digging operation, although *Necrophorus germanicus* is said to labor alone, and they have been known to show considerable intelligence in performing this operation; thus Gleiditsch states that in order to get possession of the body of a mole, fixed on the end of a stick, they undermined the latter, and thus brought the dead body to the ground. The larvæ on leaving the egg thus find themselves surrounded by an abundance of food; and when full-grown they bury themselves fully a foot beneath the surface of the ground, where they form an oval chamber, the walls of which are strengthened by a coating of a gluey liquid, and in which they undergo metamorphosis. Shield Beetles (*Silpha*) (Plate VII. fig. 22)—so called from the flattened form of their bodies—feed chiefly on carrion; some, however, climb upon plants, particularly the stems of wheat and other grain, where they find small *helices* on which they prey; while others, as *Silpha punctata*, dwell on trees and devour caterpillars. They exhale a disagreeable odor, probably arising from the nature of their food, and when they are seized a thick, dark-colored liquid exudes from their bodies. The *Dermestidæ* are a family of small but widely-distributed beetles, which work great havoc among skins, furs, leather, and the dried or stuffed animals in museums. The perfect insects are timid creatures, which when disturbed fold their short contractile feet under their bodies, and remaining perfectly motionless, admirably counterfeited death. The mischief is mainly wrought by the larvæ. These shed their skins several times, and take nearly a year in attaining their full growth. One of the most common and injurious species of this family is the Bacon Beetle (*Dermestes lardarius*) (Plate VII. fig. 14), so called from its fondness for lard, but equally ready to attack the furrier's wares. Their tastes are exceedingly general, as they have been known to destroy a whole cargo of cork, and even to perforate asbestos. The larvæ of *Anthrenus muscorum*, a species not exceeding one-tenth of an inch in length, is exceedingly injurious to collections of insects, among which it eludes observation by its minuteness and by working in the interior of the specimens, which are thus ruined before the damage is observed.

V. *Brachelytra* (Plate VII. figs. 12, 15, 20) are readily distinguished from the other groups of beetles by having the elytra much shorter than the abdomen, although they still suffice to cover the long membranous wings, which when not in use are completely folded beneath. The abdomen is long and exceedingly mobile, and is employed in folding and unfolding the wings. It is furnished at its extremity with two vesicles which can be protruded or withdrawn at pleasure, and from which, when irritated, many species emit a most disagreeable odor, although in a few the scent is more pleasing; "one species," says Kirby, "which I once took, smelt precisely like a fine high-scented pear, another like the water-lily, a third like water-cresses, and a fourth like saffron." They are very voracious both in the larval and perfect states, feeding chiefly upon decaying animal and vegetable matters, although a few species devour living prey. Many of the smaller forms reside in and feed on mushrooms, some are found abundantly under putrescent plants, others in manure heaps, where they feed upon the maggots of flies, while there are a few forms which make their homes in the nests of the hornet and the ant. The larvæ bear a considerable resemblance to their parents in form and habits, and have the terminal segment of the abdomen prolonged into a tube with two conical and hairy appendages attached. The Brachelytrous beetles form an extensive group, almost entirely confined to the temperate regions of the northern hemisphere, Great Britain alone possessing nearly 800 species. They are familiarly known in this country as Cock-tails, one of the largest and most familiar species being that known as the Devil's Coach-horse (*Colexus oleus*). It is about an inch in length, of a black color, and its eggs are larger than those of any other British insect. It may often be seen crossing garden walks; and when approached or otherwise threatened, it immediately assumes a most ferocious aspect and attitude, elevating its head and opening wide its formidable jaws, raising and throwing back its tail after the manner of the scorpion, protruding its anal vesicles, and emitting a disagreeable odor. It is carnivorous.



VII. *Clavicornes* have the antennæ terminating in a solid or perforated club, and include the Pill Beetles (*Byrrhida*) and the Mimic Beetles (*Histerida*). The former are small insects, generally short, oval, and highly convex, although a few species found under the bark of trees are flattened. They most frequently occur in sandpits and on pathways, and when in danger withdraw their highly contractile legs into cavities prepared for them on the under side of the body, at the same time folding up their antennæ and remaining motionless. In this condition they may readily be mistaken for oval seeds or pills, hence the common name. The Mimic Beetles (Plate VII. fig. 13) seldom exceed one-third of an inch in length, and are of very solid consistence, their elytra being so hard that the pin of the entomologist is with difficulty made to enter. They are somewhat square in form, with the upper surface highly polished, feeding chiefly on putrid substances and found in great abundance in spring on the dung of oxen and horses. Like Pill Beetles they roll themselves up on the approach of danger and feign death with great perseverance, and to this they owe their generic name *Hister*, from *histrio*, a stage mimic.

VII. *Lamellicornes* comprise a vast assemblage of beetles, many of which, especially such as feed on flowers and living plants, are remarkable alike for beauty of form and splendor of color. They are distinguished by the form of their antennæ, which always terminate in a club composed of several leaf-like joints, disposed like the spokes of a fan, the leaves of a book, or the teeth of a comb, or in a series of funnels placed above and within each other. The males often differ from the females in having horn-like projections on the head and thorax, and in the greater size of their mandibles. They are all winged insects, although somewhat dull and heavy in their flight, and alike in the larval and perfect states they are herbivorous, feeding either on living vegetation and flowers or on putrescent plants and excrementitious substances. The following species may be regarded as illustrative of the most important subdivisions of the Lamellicorn Beetles:—Stag Beetles (*Lucanida*) (Plate VIII. fig. 14), with the club of the antennæ composed of leaflets disposed perpendicularly to its axis like the teeth of a comb, owe their most striking feature to the immense development of the mandibles in the males, the purpose served by these formidable looking organs being by no means fully understood. The males appear to be more numerous than the females, and fierce contests take place among the former for possession of the latter. The Stag Beetle (*Lucanus cervus*), of a uniform brown color, measures 2 inches in length including the mandibles, and is the largest of British beetles. It inhabits woods, passing its immature stages in the interior of the oak and beech, and may be seen flying in the evening in search of the female. It has a patch of golden-colored hair towards the base of the foreleg with which it cleans its antennæ after these have been in contact with any sticky substance. After coupling and depositing their eggs both sexes soon die. The Dor Beetle (*Geotrupes stercorarius*) is the type of a large tribe of dung-eating beetles (Plate VII. figs. 21, 25, 26). It is a black insect, with brilliant metallic blue or purple reflections on the under side, and well known as "wheeling its drowsy flight" during fine evenings. This it does in search of a patch of cow-dung, through which it makes its way until reaching the ground, where it bores a perpendicular tunnel about 8 inches deep, and as wide as a man's finger; then ascending to the surface it conveys a quantity of dung to the bottom, and on this it proceeds to deposit an egg; another layer of the same material and another egg follow until the entire shaft is filled. The larvæ on leaving the egg thus find themselves surrounded with their appropriate food. The Sacred Beetle of Egypt, *Ateuchus sacer* (Plate VII. fig. 29), somewhat resembles the Dor in form and habits. After depositing her egg on a piece of dung the female rolls the mass about in the sunshine with her forelegs until it forms a rounded ball. The process of hatching is thus accelerated, and a thin hardened crust is formed around the softer material inclosing the egg. A hole is then dug in the earth by means of its powerful forelegs, into which the ball is rolled and then covered over with earth, where it remains until fully developed. These beetles show great perseverance in conveying the egg-laden pellets to their destination, frequently carrying them over rough ground on the broad flat surface of their heads, and seeking, when unable singly to complete

the work, the assistance of their fellows. Two species of Sacred Beetles were worshipped by the ancient Egyptians, who regarded them as emblems of fertility, and as representing the resurrection of the soul, owing to their sudden appearance in great numbers on the banks of the Nile after the annual subsidence of that river. They form a conspicuous feature in the hieroglyphics of that nation, and are found sculptured on their monuments, sometimes of gigantic size. They were also formed into separate figures, as seals and amulets, made of gold and other precious materials, and hung around the necks of the living, or buried along with their mummies. The insect itself is sometimes found in their coffins. The male Hercules Beetle (*Scarabæus hercules*) of Guiana has the head produced into an enormous horn, bent downwards at the extremity, and clothed on the under surface with a reddish brown pile, and measures 6 inches in length. The Cockchafer, *Melolonthida* (Plate VII. fig. 23), have a short labrum and strong mandibles suited for feeding on leaves. The club of the antennæ consists of a variable number of plates, those in the male being considerably elongated and resembling a folded fan (Plate VII. fig. 23). The common Cockchafer (*Melolontha vulgaris*) is of a pitchy black color clothed with a white pubescence or layer of minute scales. It is one of the commonest and most destructive of beetles, feeding in the perfect state on the leaves of the oak, beech, poplar, and elm, and sometimes appearing in such numbers as to utterly destroy the foliage over large districts; thus in the year 1688 they are said to have covered the hedges and trees in a district of Galway in such infinite numbers as to have hung in clusters like bees when they swarm. When on the wing they almost darkened the light of day, and when feeding the noise of their jaws might have been mistaken for the sawing of timber. In a short time the foliage of the trees for miles round was so totally consumed that at midsummer the country wore the aspect of leafless winter. Destructive as they are in the perfect state they are still more injurious as larvæ. The female buries herself beneath the surface of the ground and there deposits about 40 eggs. The larvæ produced from these feed on the roots of grass and grain, thus "undermining," according to Kirby and Spence, "the richest meadows, and so loosening the turf that it will roll up as if cut with a turfing spade." These grubs continue their ravages for three years before undergoing metamorphosis, and thus do incalculable damage to the agriculturist. They are believed to have spread with the progress of agriculture, for it is only on soil rendered light and porous by tillage that they thrive. Enormous numbers of the grub are consumed by birds of the crow tribe, and it is principally in search of these that rooks so industriously follow the plough in England and France. The species is rare in Scotland. "Spinning" the cockchafer is a favorite but barbarous sport, practised by the boys of most countries in which this beetle commonly occurs, and seems to be at least as ancient as the time of Aristophanes, who refers to it in his *Clouds* as practised by the youth of Greece. Rose Beetles, *Cetoniida* (Plate VIII. fig. 7), a beautiful tribe of insects, are distinguished from other Lamellicorn Beetles by the membranaceous character of their mandibles and maxilla. The Rose-Chafer (*Cetonia aurata*) is common in the south of England, where it feeds on the juices and petals of the rose, honeysuckle, and privet. It is about an inch long, of a brilliant-golden green above with coppery reflections beneath, and with whitish markings on the elytra. Its eggs are deposited among decayed wood, but certain species make use for this purpose of the nests of ants. The Goliath Beetles (Plate VIII. fig. 11) of tropical Africa are the largest of known Coleoptera, and their larvæ form enormous cocoons of mud in which they undergo metamorphosis. One of these, *Goliathus cacicus*, is said to be roasted and eaten by the natives.

VIII. *Serricornes* form a group of beetles chiefly distinguished from the others by their elongate filiform antennæ of equal thickness throughout, or tapering towards the extremity, but generally serrated or pectinated. They are subdivided into the *Sternosi*, characterized by the solid consistence of their bodies, and by having the middle portion of the thorax elongated and advanced as far as beneath the mouth, and usually marked by a groove on each side, in which the short antennæ are lodged, while the opposite extremity is prolonged into a point which is received into a cavity on the hinder part of the breast; and the *Mala-*

*odermata*, characterized by their bodies being generally, in whole or in part, of a soft or flexible texture, and by the absence of the prolongation just referred to. The *Sternorzi* include the Metallic Beetles, *Buprestidae* (Plate VII. figs. 18, 19), the most gorgeous of the Coleopterous families. "Nothing can exceed," says Westwood, "the splendor of color in many of the species, being decorated with the most brilliant metallic tints; some have a general coppery hue, whilst some present the beautiful contrast of fine yellow spots, and marks upon a highly polished blue or green ground, and others exhibit the appearance of burnished gold or of rubies, inlaid on emerald or ebony." The elytra of the Metallic Beetles are those usually employed in the embroidery of ladies' dresses and for other purposes of personal ornament. They are most plentiful in the thick forests of tropical countries, and seem partial to the various species of fir-trees. They pass their larval stage in the heart of timber, and there is an instance recorded of the escape of *Buprestis splendens* from the wood of a desk which had stood in one of the Guildhall offices for over twenty years. Springing Beetles, *Elateridae* (Plate VII. fig. 30), are narrower and more elongate than the former, and their legs are so short that when they fall on their backs they are as unable to right themselves as a capsize turtle, but by bending the head and thorax backwards, and making use of the prolongation already described, they are enabled to spring to a height fully ten times their own length, and this operation they repeat until they fall on their feet. The noise which accompanies the springing process has earned for them the name of Click Beetles. Some species of *Elateridae* are luminous in the dark, and are known as Fireflies. A South American form diffuses during the night from its thoracic spots a strong and beautiful light sufficient to enable a person to read ordinary type, particularly if several are placed together in a glass vessel. By means of this natural illumination the women of the country can pursue their ordinary work, and ladies use this fire-fly as an ornament, placing it among their tresses during their evening promenades. The larva of *Elater lineatus* is known as the Wire-worm, a grub which often does great damage to the turnip crop. The *Malacodermata* include the Glow-worms, *Lampyridae* (Plate VII. fig. 1), of which the best known is the common Glow-worm (*Lampyris noctiluca*) (Plate VII. figs. 8, 9, 16), found in meadows and under hedges in England, but rare in Scotland. The male of this beetle has large wings and elytra, and flies swiftly, but the female is wingless and is a sluggish nocturnal creature; the latter, however, emits a beautiful phosphorescent light, by means of which the male, who is generally concealed by day in the trunks of trees, is directed to his mate. In the perfect insect the luminous matter chiefly occupies the under part of the three last segments of the abdomen, which differ from the rest in color, being usually of a yellow hue, and the luminous property is apparently under the control of the Glow-worm, for when approached it may frequently be observed to diminish or extinguish its light. In form the larvæ somewhat resemble the female, and possess in common with the pupæ and eggs a slight degree of luminosity. The larvæ are predaceous, attacking and devouring the smaller snails and slugs, but in the perfect state they become entirely herbivorous, only eating the tender leaves of plants. Many of the *Malacodermata* are wood-borers; these include the Death-watch Beetles (*Anobium*), which as larvæ perforate chairs, tables, and other wood-work in such numbers as usually to render the wood completely rotten. During the pairing season they make a noise like the ticking of a watch, by striking with their jaws against the object on which they rest. This is intended as a mutual call of the sexes, but it has long been regarded by the ignorant as of evil omen, hence the name, and the import of Gay's words—

"The solemn death-watch clicked the hour she died."

Another species, *Lymexylon navale*, abundant in the forests of Northern Europe, does great damage by boring into the timber of the oak tree.

**HETEROMERA.**—The beetles comprising this section have five joints to the first four tarsi, and four to the posterior pair, and form two groups, *Trachelia* and *Atrachelia*.

I. *Trachelia* have the head triangular or heart-shaped, and connected with the thorax by a kind of neck or abrupt

pedicle. Most of the species in the perfect state live on various plants, of which they devour the foliage or suck the juices, and many when seized bend their heads, contract their limbs, and simulate death. This group includes the Oil Beetles (*Meloe*) (Plate VIII. fig. 2), large black insects, destitute of wings, and with short elytra. They secrete an oily fluid possessing slightly blistering properties, which when alarmed they emit from the joints of their legs, and when eaten by cattle, as they sometimes are when feeding on the wild buttercups of pasture-lands, they produce sores in the mouth. In some parts of Spain they are used instead of the Blistering Fly, or are mixed with it. The young larvæ of several species of Oil Beetles, it has been ascertained, get conveyed to the nests of bees, where alone they can find their appropriate food, and where also they undergo metamorphosis. The most important insect of this group is the Spanish Fly, or Blistering Beetle (*Lytta vesicatoria*) (Plate VIII. fig. 19), found abundantly in South-Western Europe, but of rare occurrence in England. It is a handsome insect of a golden green color, and measures about three-fourths of an inch in length. In Spain, where this species is most abundant, they are collected for commercial purposes in the month of June. A sheet is placed beneath the trees frequented by the blister-flies, and the branches are shaken, so as to cause the insects to fall off. They are then killed by exposure to the vapor of vinegar, and completely-dried after they are dead. The blistering principle, known to chemists as cantharidin, is contained in their integuments. See **CANTHARIDES**.

II. The *Atrachelia* have no distinct neck, the part of the head behind the eyes being immersed in the thorax. They are in most cases nocturnal insects, obscure in color, and slow in motion. The Church-yard Beetle (*Blaps mortuaria*) (Plate VIII. fig. 1) is one of the commonest species. It is of a shining black color, avoids the light, and emits an offensive odor. It is found in cellars, store-rooms, and the neglected parts of houses, feeding on rubbish of all kinds, and regarded as of evil omen by the superstitious. It is very tenacious of life, having been known to survive several hours immersion in spirits of wine, and cases are on record in which the larvæ have been discharged from the human stomach. The Meal-worm is the larva of *Tenebrio molitor* (Plate VIII. figs. 4, 5), a well-known insect belonging to this group, which appears in the evening in the least frequented parts of houses. It is found abundantly in flour-mills and bake-houses, greatly relishing the heat of the latter. The larvæ, which are long, cylindrical, and of an ochry yellow color, pass their lives enveloped in the flour which forms their favorite food, and in the midst of which they become pupæ. While injurious to flour and bran, and destroying great quantities of ship biscuits, the Meal-worm is used as bait by fishermen, and as food for the nightingale and other pet insectivorous birds.

**TETRAMERA.**—The beetles composing this section have four apparent joints to all the tarsi, but in most cases the tarsi are in reality five-jointed, the fourth being so minute as to have been overlooked by the founders of the tarsal system. For this reason Westwood proposed the term *Pseudo-tetramera* in place of *Tetramera*, a change which has been adopted by several systematic writers. This section includes a vast number of small or moderate sized beetles, all vegetable feeders, found in the perfect state on flowers and plants. It is subdivided into the three following groups:—

I. *Rhynchophora*, the species of which are readily recognized by having the front of the head produced into a rostrum or snout, which bears the organs of the mouth at its extremity. The larvæ are either entirely destitute of legs, or have them in the form of small fleshy tubercles, and are in most cases equally destitute of eyes. The most numerous and best-known tribe of *Rhynchophorous* beetles are the Weevils (Plate VIII. figs. 8, 9, 15, 16, 20, 22), of which several thousand species have been described, and whose larvæ, dwelling in the interior of fruits and seeds, do immense damage to the produce of the farmer, the grain dealer, and the horticulturist. They are generally minute in size and exceedingly varied in color, the South American forms, known as Diamond Beetles, being among the most gorgeous of insects. These owe their color, which in the finest of them is a light-green tinged with golden yellow, to the presence of minute scales on the elytra. The Weevil *par excellence* (*Calandra granaria*) measures about one-eighth of an inch in length, is of a pitchy red color,

1. Organs of the mouth.

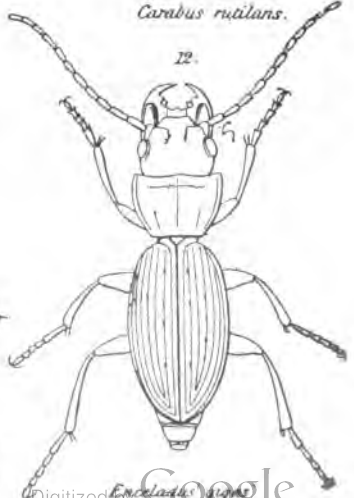
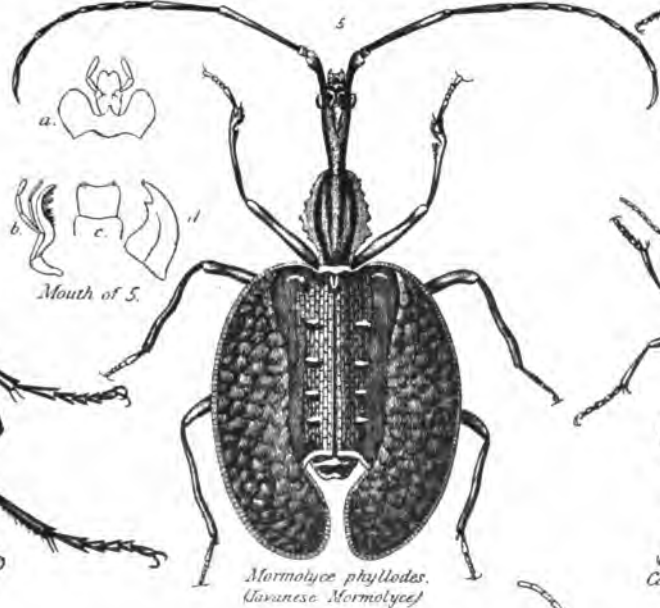
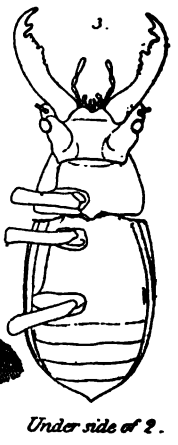
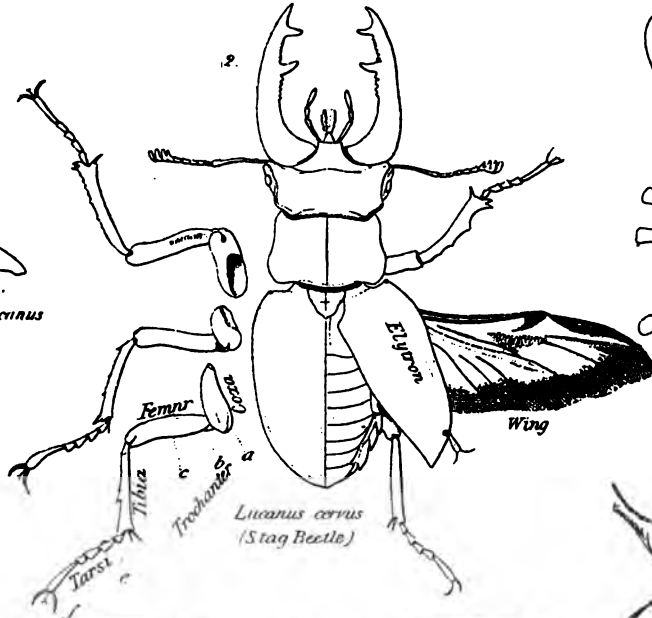
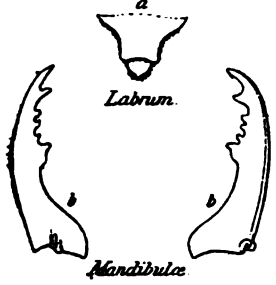





*Lampyrus Surignii.*



*Calosoma sycophanta*



*Dytiscus Herminieri*



*Dytiscus Rosellii*

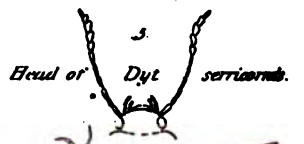

Head of *Dyt. serricornis*.



Larva of *Dytiscus*.  
(Water Beetle.)



Pupa of *Dytiscus*



Female of 16



Larva of 16.



*Hister reniformis*  
(Mimic Beetle.)



*Gyrrinus sulcatus*.  
(Grooved Whirligig.)



Antenna of *Gyrrinus*



*Dermestes lardarius*.  
(Bacon Beetle)

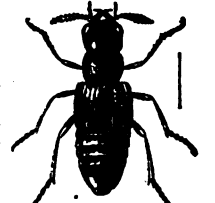

*Oxyporus rufus*.



*Mytilus erythropterus*  
(Turkey Dove Beetle)



(Glow-worm),  
*Lampyrus noctiluca*  
Male



Larva of *Gyrrinus marginatus*

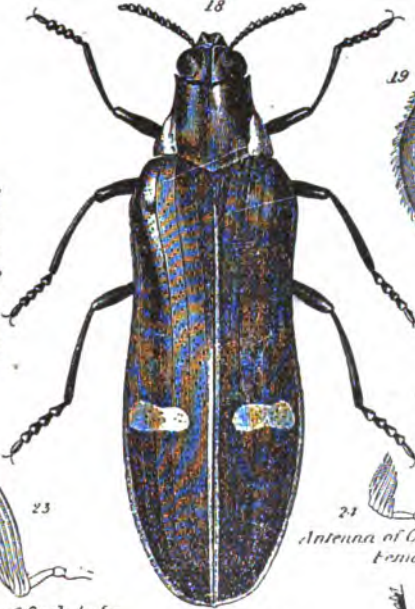

*Hesperus havior*  
(Metallic Beetle)



Larva of *Hesperus gigas*



*Stenus bisulcatus*



*Ateuchus foveiporus*.



*Silpha quadripunctata*.

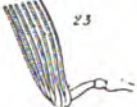

Antenna of *Cockchafer*  
Male



Antenna of *Cockchafer*  
Female



*Geolupes-Blickburni*.



*Necrophorus vespillo*  
(Saxton Beetle)



*Melolontha fulva*  
(Cockchafer)



(Saxton Beetle)  
*Nicrophorus vespillo*



*Phanus Imperator*



*Elater plagiatus*



*Clorus apivorus*  
(Wive Beetle)

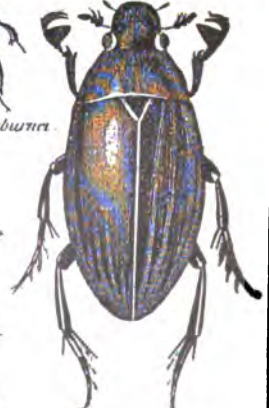

*Hydrophilus piceus*  
(Black Water Beetle)



(Churchyard Beetle) *Blaps mortisago.*



*Meloe provarvaricus*  
(Oil Beetle)



*Lophoceros barbicornis*



*Tenebrio molitor*  
(Flour Beetle)



Meal Worm  
Larva of ?



*Anthrenus latimotus.*



*Orchestes albi*



*Sagra cyanea.*



*Scolytus ulmi*



*Cetonia Baxii.*



*Bruchus pisi.*  
(Pea Weevil)

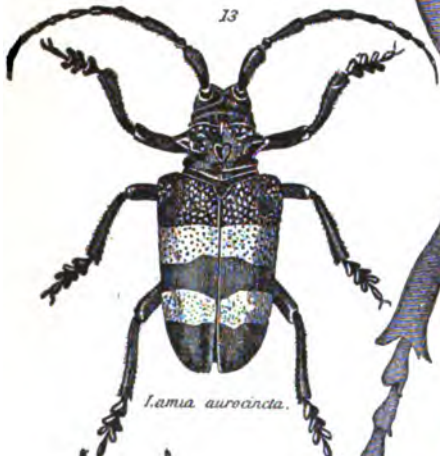

*Lamia aurocincta.*

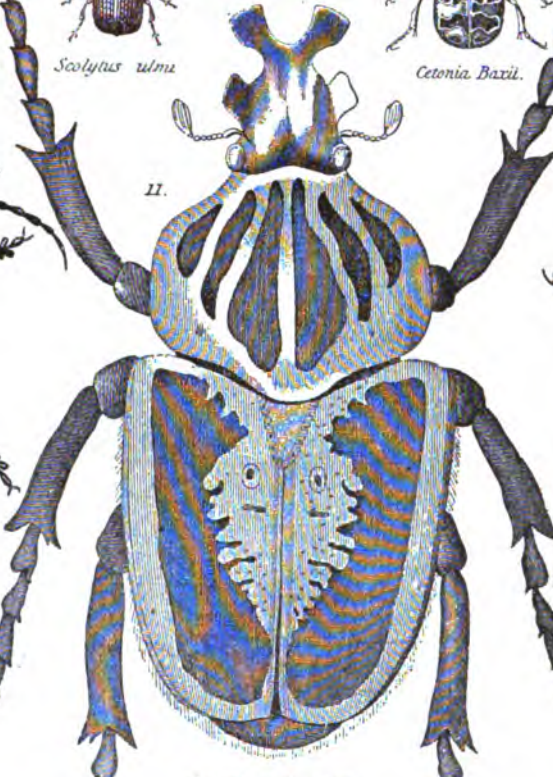

*Goliathus giganteus*  
(Goliath Beetle)



*Lurinus cinnamomeus.*



*Curculio ligustici.*



*Brennus anchorago*



*Hispa Fabricii.*



*Leius parviflorus*



*Eumorphus Sumatrensis.*



*Eindomychus cocineus.*



*Lytta vesicatoria.*  
(Blister Beetle)



*Chrysomela humeralis*



*Coccinella ocellata.*  
(Eyed Lady-bird)



*Cassida longicornis.*  
(Longhorned Tortoise Beetle)

and does great damage in granaries. The female buries herself among the grains of wheat, in each of which she bores a small hole, where she deposits a single egg, thereafter closing the aperture with a glutinous secretion. The egg is soon hatched, and the larva, furnished with two strong mandibles, eats out the interior of the grain, becomes a nymph, and in the course of eight or ten days is transformed into the perfect insect, ready to raise another brood. The whole time occupied with their reproduction, from the union of the sexes to the appearance of the perfect Weevil, is not more than 50 days, and it has been calculated that from a single pair 23,600 individuals may thus take origin in a single season. Grain injured by these insects is readily detected, from the fact that it floats when immersed in water. Kiln-drying the grain is the mode most generally adopted for arresting the evil. Filberts, acorns, rice, the sugar-cane, and the palm tree have each its own species of Weevil. The Palm Tree Weevil (*Calandra palmorum*) is the largest of the tribe, measuring 2 inches in length, and its larvæ, as well as those of the sugar-cane species, are, when cooked, considered delicacies by the natives of Guiana and the West Indies. *Bruchus pini* (Plate VIII. fig. 12), belonging to another family of this group, deposits its eggs in peas, the interior of which is devoured by the larva. It has probably been introduced into Britain from America, where its ravages are occasionally such as totally to destroy the pea crop over large districts. The larvæ of many species burrow beneath the bark of trees and thus destroy immense quantities of timber. Of these the most familiar are *Scolytus destructor*, whose curiously designed burrows in the bark of the elm are well known, and the Typographic Beetle (*Tomicus typographicus*), so called from the resemblance which its burrows, made in the soft wood immediately beneath the bark, bear to printed characters.

II. *Longicornes* (Plate VIII. fig. 13) form an extensive group of beetles characteristic of tropical forests, and readily distinguished by the great length of their antennæ, which in some cases are several times longer than the body. These are usually setaceous or filiform, and are occasionally adorned with tufts of hair at the joints (Plate VIII. fig. 3). The larvæ of almost all the Longicorns live in the interior, or beneath the bark, of trees, perforating the timber of the largest forest trees, and thus hastening in these the natural process of decay. They are either apodal, or furnished with inconspicuous feet, but progress chiefly by the aid of small tubercles on the upper and under surfaces of the segments. The female is provided with an ovipositor of horny consistence, issuing from the posterior segment, by means of which the eggs are deposited in cracks and fissures of wood. The larvæ remain for several years buried in the heart of timber, and in this way many exotic species are conveyed to this country, and are occasionally taken alive in the London and Liverpool docks. Several of the Longicorn Beetles are among the largest of Coleopterous insects, *Prionus giganteus* measuring five inches in length, while its eggs are nearly as large as those of the smaller birds. The Harlequin Beetle (*Acrocinus longimanus*), so called from the variety of its coloring, the grotesqueness of its markings, and the enormous elongation of its front pair of legs, is a South American species of this group, as is also the Musk Beetle (*Callichroma moschata*), one of the handsomest of our native species, and remarkable for the musky odor of its body.

III. *Phytophaga* comprise the tetramerous beetles which have neither the rostrum of the first group nor the lengthened antennæ of the second. They are small insects of an oval or quadrate shape, and include the Golden Beetles, *Chrysomelidae* (Plate VIII. fig. 21), ornamented with metallic colors, among which blue, green, gold, and copper are conspicuous. The Turnip-fly (*Haltica nemorum*), a small species belonging to a family in which the posterior thighs are enlarged for leaping, devours the young leaves of the turnip as soon as they appear above ground, and occasionally does immense injury to the turnip crop. Helmet or Tortoise Beetles, *Cassidae* (Plate VIII. figs. 20, 24), so called from the thorax and elytra overlapping so as to shield the limbs and abdomen on all sides, are oval, and in some cases almost square, flat insects, and often beautifully marked with combinations of green and golden hues. They are herbivorous, and are specially fond of artichoke and thistles. The larvæ are provided at the posterior extremity with a two-branched fork, curved over the back, and usually bearing a pile of excrementitious matter, under

which they lie partly concealed. It can elevate or depress this stercoraceous parasol at pleasure, according as it needs shade or shelter. The Colorado Potato Beetle (*Doryphora decemlineata*) belongs to the phytophagous family *Chrysomelidae*. It measures nearly half an inch in length; its body is of a tawny or yellow cream color, darkly spotted; and the elytra are marked with ten black longitudinal stripes. It is a native of the eastern slopes of the Rocky Mountains, where it fed on a wild solanaceous plant, *Solanum rostratum*, until the introduction of the potato plant, consequent on the settlement and cultivation of the "Far West," provided it with what appears to have been a more appropriate food. Since 1859 it has travelled eastward, towards the more highly cultivated lands, at the rate of nearly 100 miles per annum, until it has reached the Atlantic Coast. It is now found over all the central and northern parts of the United States east of the Rocky Mountains, and throughout Canada, and has already done incalculable mischief to the potato crops of those regions. The damage is chiefly wrought by the larvæ, which are hatched on, and greedily devour, the leaves and stalk of the potato plant. They are said to produce three broods annually.

TRIMERERA.—The majority of the beetles composing this section have only three apparent joints to the tarsi of all the feet, but a small articulation has been found to lie between the second and third joints, so that they are in reality four-jointed, and for this reason Westwood has changed the name of the section to Pseudotrimerera.

Trimerous beetles form a single group, the species of which are partly herbivorous, feeding on fungi (Plate VIII. figs. 17, 18), and partly carnivorous, devouring aphides or plant lice. The most familiar examples of this group are Lady-birds, *Coccinellidae* (Plate VIII. fig. 23), small convex insects of a black color, spotted with red or yellow, or of a reddish color, spotted with black. The larvæ do great service by devouring the plant lice, which usually infest garden bushes. When alarmed the Lady-birds retract their limbs and emit a yellow juice from their joints, which has a very disagreeable odor. They occasionally occur in great numbers, extending for miles, in the south-eastern districts of England, where they are invaluable for freeing the hops of aphides. They walk slowly but fly well. The Seven-Spotted Lady-bird (*Coccinella 7-punctata*), the common species of Britain, is found in all quarters of the globe.

ON COLLECTING AND PRESERVING COLEOPTEROUS INSECTS.—The collector of beetles, in order to obtain perfect specimens, need not have recourse to the plan adopted by the lepidopterist of rearing the insect from the egg. The successful rearing of these is much more difficult than in the case of butterflies and moths, and the specimens so procured are generally inferior to those collected in the ordinary way. The complete life history, however, of comparatively few even of our native species has yet been fully traced; and although the collector thus might not greatly enrich his cabinet with specimens of his own rearing, yet by adopting this method he would almost certainly add to the general stock of knowledge regarding the transformations of these insects. Beetles may often be obtained in what may be termed accidental situations,—sand-pits into which they have fallen, or artificial traps set for them, as a white sheet spread on the grass; but "sweeping" and "beating" are the means mainly relied on by the coleopterist for filling his cabinet, and for these all the apparatus necessary consists of an umbrella-net and a stick for beating. The net is swept over the grass, and among the foliage of trees, and when the branches are shaken with the hand, or beaten with the stick, the net is held beneath to catch the falling insects. An umbrella inverted, or a sheet placed beneath the tree, serves the same purpose. A knowledge of the habits of the various tribes of beetles will give the collector a clue to the localities in which, and the time when, he may expect to find the species he is in search of. In this way the bark and timber of trees, decaying branches and leaves, putrescent fungi, the droppings and the dead bodies of mammals, fresh water ponds, and even the nests of wasps, bees, and ants, will all be found to yield their own harvest of Coleoptera. Beetles when caught may either be dropped into a phial containing spirits of any kind, or into what is known as the "killing bottle," the bottom of which contains cyanide of potassium covered over with a layer of gypsum. In either case, with few exceptions, the beetles

die almost instantaneously. If kept too long in spirits, however, the limbs get loosened through maceration and fall off. The "setting" of a beetle, or of any other insect, consists in placing its limbs and antennæ in a natural position and fixing them there by means of pins until they stiffen on a board on which there is a layer of cork. If not set when either moist or recent, they may be softened by being placed for a night in any small vessel containing a layer of wet sand, and covered with a damp cloth to prevent evaporation. The smaller beetles are usually mounted on card, each insect being stuck on a small dab of gum with its legs and antennæ properly set; all others are pinned through the centre of the upper part of the right elytron. In the case of large beetles as much of the contents of the body as possible should be removed by making an opening in the abdomen; and with the Oil Beetles it is necessary to stuff the abdomen. This can be best effected by separating the latter from the body, emptying it, and refilling with wadding; it can then be readily gummed to the body. Mould may be got rid of by exposing the specimens to a strong heat for some hours, and mites and grease by washing the beetles with a small brush dipped in benzine. (J. GI.)

COLERAINE, a municipal and parliamentary borough and market-town of Ireland, in the county of Londonderry, on the Bann, four miles from its mouth, and 145 miles north of Dublin. The town stands upon both sides of the river, which is there crossed by a handsome stone bridge of three arches, 288 feet in length by 32 in breadth. The principal part is on the east bank, and consists of a central square called the "Diamond," and several diverging streets; the portion on the west side is called the Water-side, or Killowen. Coleraine has two parish churches, two Roman Catholic churches, a town-hall, a market-house, a work-house, an endowed school, a national model school, and free schools founded by the Irish Society of London. The linen trade has long been extensively carried on in the town, from which, indeed, a fine description of cloth is known as "Coleraines." Pork-curing and the salmon and eel fisheries are prosecuted. The mouth of the river, which was formerly obstructed by a bar, now admits vessels of 200 tons. The principal trade is carried on through Port Rush, where a harbor is formed by two moles, with an entrance of 200 feet wide, an area of 8 acres, and a depth of from 15 to 20 feet at the wharves. In 1873, 422 vessels entered with a tonnage of 46,589. The parliamentary borough has a population of 6552, and returns one member. Coleraine is reputed to have been the seat of a Christian bishop previous to the arrival of the great apostle of Ireland. It owes its modern importance mainly to the Company for the New Plantation of Ulster, on which it was bestowed in 1613. Though fortified only by an earthen wall, it managed to hold out against the rebels in 1641.

COLERIDGE, HARTLEY (1796-1849), the elder son of Samuel Taylor Coleridge, was born on the 19th of September, 1796, at Clevedon, a small village near Bristol. His early years were passed at Keswick, where his education was conducted in a somewhat desultory manner. He gave promise of great mental power, but derived less advantage from systematic studies than from intercourse with S. T. Coleridge, Wordsworth, Southey, De Quincey, and Professor Wilson. In 1815 he went to Oxford, as scholar of Merton College, the means for his support being principally provided by Southey. His university career, however, was very unfortunate. He had inherited the weakness of purpose, as well as the splendid conversational powers, of his father, and, having never enjoyed the benefit of a regular discipline, lost all self-restraint amidst the gayeties of Oxford, and finally lapsed into habits of intemperance. He was successful in gaining an Oriel fellowship, but at the close of the probationary year was judged to have forfeited it. The authorities could not be prevailed on to reverse their decision; but they awarded to him a free gift of £300. With this, Hartley Coleridge came to London in 1821, and remained there for two years, during which he wrote short poems for the *London Magazine*. His next step was to set up school at Ambleside, but this scheme failed, after five years of struggle in a position for which he was wholly unfit. Coleridge then removed to Grasmere, where he lived in great seclusion,—writing between 1826 and 1831 *Essays for Blackwood*, and in 1832 his *Biographia Borealis, or Lives of Northern Worthies*. In 1839 appeared his last work, the *Life of Massinger*, an

elaborate and artistic production. The closing decade of Coleridge's life was wasted in what he himself calls "the woeful impotence of weak resolve." In 1848 his health became sensibly affected, and he expired on the 6th of January, 1849. The prose style of Hartley Coleridge is marked by much finish and vivacity; but his literary reputation must chiefly rest on his poetical remains. Of these the *Sonnets*, and *Prometheus*, an unfinished lyric drama, are the finest. The influence of Wordsworth is discernible in his poetry, but it does not on that account want originality. (See *Memoir of Hartley Coleridge* by Derwent Coleridge.)

COLERIDGE, SIR JOHN TAYLOR (1790-1876), nephew of S. T. Coleridge, was born at Tiverton, and was educated with Arnold and Keble, at Corpus Christi College, Oxford. In 1810 he won the Latin verse prize; in 1812 he obtained a first class in classics; and in 1813 both the English and Latin essay prizes were awarded him. He was soon after made a fellow of Exeter; in 1819 he was called to the bar, and practised for some years on the Western Circuit. In 1824, on Gifford's retirement, he assumed the editorship of the *Quarterly Review*, resigning it a year afterwards in favor of Lockhart. In 1825 he published his excellent edition of *Blackstone's Commentaries*, and in 1832 he was made a serjeant-at-law. In 1835 he was appointed one of the judges of the King's Bench. In 1852 his university created him a D.C.L., and in 1858 he resigned his judgeship, and was made a member of the Privy Council. In 1869, although in extreme old age, he produced his pleasant *Memoir of the Rev. John Keble, M.A.*, a third edition of which was issued within a year.

COLERIDGE, SAMUEL TAYLOR (1772-1834), one of the most remarkable of English poets and thinkers, was born on the 21st of October, 1772, at his father's vicarage of Ottery St. Mary's, Devonshire. His father was a man of some mark. He was known for his great scholarship, simplicity of character, and affectionate interest in the pupils of the grammar school, where he reigned until his promotion to the vicarage of the parish. He had married twice. The poet was the youngest child of his second wife, Anne Bowden, a woman of great good sense, and anxiously ambitious for the success of her sons. On the death of his father, a presentation to Christ's Hospital—acceptable in a family of ten—was procured for Coleridge by Judge Buller, an old pupil of his father's. He had already begun to give evidence of a powerful imagination, and he has described in a letter to his valued friend, Mr. Poole, the pernicious effect which the admiration of an uncle and his circle of friends had upon him at this period. For eight years he continued at Christ's Hospital. Of these school-days Charles Lamb has given delightful glimpses in the *Essays of Elia*. The head master, Bowyer, though a severe disciplinarian, was on the whole respected by his pupils. Middleton, afterwards known as a Greek scholar, and bishop of Calcutta, reported Coleridge to Bowyer as a boy who read Virgil for amusement, and from that time Bowyer began to notice him, and encouraged his reading. Some compositions in English poetry, written at sixteen, and not without a touch of genius, give evidence of the influence which Bowles, whose poems, now forgotten, were then in vogue, had over his mind at this time. Before he left school his constitutional delicacy of frame, increased by imprudent bathing in the New River, began to give him serious discomfort.

In February, 1791, he was entered at Jesus College, Cambridge. A school-fellow who followed him to the university has described in glowing terms evenings in his rooms, "when Æschylus, and Plato, and Thucydides were pushed aside, with a pile of lexicons and the like, to discuss the pamphlets of the day. Ever and anon a pamphlet issued from the pen of Burke. There was no need of having the book before us;—Coleridge had read it in the morning, and in the evening he would repeat whole pages verbatim."

Friend, a fellow of Jesus, accused of sedition and Unitarianism, was at this time tried and expelled from Cambridge. Coleridge had imbibed his sentiments, and joined the ranks of his partisans. He grew discontented with university life, and, pressed by debt, in a moment of spleen enlisted as a soldier. One of the officers of the dragoon regiment, finding a Latin sentence inscribed on a wall, discovered the condition of the very awkward recruit. Shortly afterwards a Cambridge friend recognized him, and



informed some members of his family, who with difficulty procured his discharge. He returned for a short time to Cambridge, but quitted the university without a degree in 1794. In the same year he visited Oxford, and made the acquaintance of Southey, who continued through life, in spite of Coleridge's many misunderstandings, his firm friend and most devoted admirer. The French Revolution had stirred the mind of Southey to its depths. He received with rapture his new friend's scheme of Pantisocracy. On the banks of Susquehanna was to be founded a brotherly community, where selfishness was to be extinguished, and the virtues were to reign supreme. No funds were forthcoming, and in 1795, to the chagrin of Coleridge, the scheme was dropped. In October of the same year, Coleridge was married to Sarah Fricker, and took up his residence at Clevedon on the Bristol Channel. A few weeks afterwards Southey married a sister of Mrs. Coleridge, and on the same day quitted England for Portugal.

The cares of matrimony induced Coleridge to commence lectures. The Bristol public did not encourage his efforts on politics and religion. Coleridge embodied these in his first prose publication, *Oceanoes ad Populum*. The book contained much invective against Pitt, and in after life he declared that with this exception, and a few pages involving philosophical tenets which he afterwards rejected, there was little or nothing he desired to retract. In the course of a summer excursion at this period, he met for the first time the brother poet with whose name his own will be forever associated. Wordsworth and his sister had established themselves at Racedown in Dorsetshire,—a retired spot,—and it was here the friends first met. There are few things in literary history more remarkable than this meeting. The gifted Dorothy Wordsworth described Coleridge as "thin and pale, the lower part of the face not good, wide mouth, thick lips, not very good teeth, longish, loose, half-curling, rough, black hair,"—but all was forgotten in the magic charm of his utterance. Wordsworth, who declared, "The only wonderful man I ever knew was Coleridge," seems at once to have desired to see more of his new friend. He and his sister soon removed to Coleridge's neighborhood, and in the most delightful and unrestrained intercourse the friends spent many happy days. It was the delight of each one to communicate to the other the productions of their minds, and the creative faculty of both poets was now at its best. One evening, on the Quantock Hills, *The Ancient Mariner* first took shape. Coleridge was anxious to embody a dream of a friend, and the suggestion of the shooting of the albatross came from Wordsworth. A joint volume was planned. The poetry of common life was to be the work of Wordsworth, while Coleridge was to indulge in romance. From this sprang the *Lyrical Ballads*, and after much cogitation the book was published by the amiable but gossiping bookseller at Bristol, Cottle, to whose reminiscences often indulging too much in detail, we owe the account of this remarkable time. Coleridge projected a periodical called *The Watchman*, and undertook a journey, well described in the *Biographia Literaria*, to enlist subscribers. *The Watchman* had a brief life of two months, and at this time, in the year 1796, the *Juvenile Poems*, for which Cottle, always ready to help his literary friends, gave thirty guineas, appeared. The volume met with success, but at this time Coleridge began to think of becoming a Unitarian preacher, and abandoning literature for ever. Hazlitt has recorded his very favorable impression of a remarkable sermon delivered at Birmingham; but there are other accounts of Coleridge's preaching not so enthusiastic. In 1798 an annuity, granted him by the brothers Wedgwood, led him to abandon his scheme of life. For many years he had desired to see the Continent, and in September of the same year—the year in which the *Lyrical Ballads* appeared—in company with Wordsworth and his sister, he left England for Hamburg.

A new period in Coleridge's life now began. He soon left the Wordsworths to attend lectures at Göttingen. A great intellectual movement had begun in Germany. Coleridge was soon in the full whirl of excitement. He learnt much from Blumenbach and Eichhorn, and took interest in all that was going on around him. During his stay of fourteen months in Germany, he made himself master of the language to such purpose that the translation of *Waldenstein*—his first piece of literary work after his return to England—was actually accomplished in six weeks. It was published in 1800, and, although it failed to make any im-

pression on the general public, it became at once prized by Scott and others as it deserved. In several passages Coleridge has expanded and paraphrased the thought and expression of the original, but few, even amongst the greatest sticklers for accuracy, will be inclined to quarrel with the departure of the translator. It is matter for regret that a request to Coleridge that he should undertake to translate *Faust* never received serious attention from him. During the first two years of this century Coleridge wrote many papers for the *Morning Post*. He had vehemently opposed Pitt's policy, but a change came over the spirit of his mind, and he found himself separated from Fox on the question of a struggle with Napoleon. Much has been written of this political attitude, but there is no real reason to doubt his own account of the matter. Like the first Lord Minto, Mr. Windham, and many other Whigs, he felt that all questions of domestic policy must at a time of European peril be postponed. From this time, however, his value for the ordered liberty of constitutional government increased; and though never exactly to be found among the ranks of old-fashioned Constitutionals, during the remainder of his life he kept steadily in view the principles which received their full exposition in his well-known work on *Church and State*. In the year 1801 Coleridge left London for the Lakes. His home was for a time with Southey. A temporary estrangement had entirely been forgotten, and Southey, it should be said, for many years extended to Coleridge's wife and family the shelter and care of true friendship.

For fifteen years the record of Coleridge's life is a miserable history. He sank under the dominion of opium. The *Ode to Dejection* and the poem of *Youth and Age* are sad evidences of the utter prostration of spirit, which was his terrible penalty for many a year. Few things are so sad to read as the letters in which he details the consequences of his transgression. He was occasionally seen in London during the first years of this century, and wherever he appeared he was the delight of admiring circles. A visit to Malta in 1804, when for a short time he acted as secretary to the governor, and a brief stay at Rome in the following year, were the chief events of what may be called the opium period. In 1809 he published *The Friend*, and during that and the two following years he lectured on Shakespeare and education. The tragedy of *Remorse* was produced in 1813, and met with considerable success. Three years after this the evil habit against which he had struggled bravely, but ineffectually, determined him to enter the family of Mr. Gillman, who lived at Highgate. The letter in which he discloses his misery to this kind and thoughtful man gives a real insight into his character. Under kind and judicious treatment the hour of mastery at last arrived. The shore was reached, but the vessel had been miserably shattered in its passage through the rocks. He hardly, for the rest of his life, ever left his home at Highgate. During his residence there, *Christabel*, written many years before, and known to a favored few, was first published. He read widely and wisely, in poetry, philosophy, and divinity. In 1816 and the following year, he gave his *Lay Sermons* to the world. The *Biographia Literaria* and a revised edition of *The Friend* soon followed. Seven years afterwards his maturest and best prose work—*The Aids to Reflection*—first appeared. His last publication, in 1830, was the work on *Church and State*. In 1833 he appeared at the meeting of the British Association at Cambridge, and in the following year he passed away, and was buried in the churchyard close to the house of Mr. Gillman, where he had enjoyed every consolation which friendship and love could render. Coleridge died in the communion of the Church of England, of whose polity and teaching he had been for many years a loving admirer. An interesting letter to his god-child, written twelve days before his death, sums up his spiritual experience in a most touching form.

Of the extraordinary influence which he exercised in conversation it is impossible to speak fully here. Many of the most remarkable among the younger men of that period resorted to Highgate as to the shrine of an oracle, and although one or two disparaging judgments, such as that of Mr. Carlyle, have been recorded, there can be no doubt that since Samuel Johnson there had been no such power in England. His nephew, Henry Nelson Coleridge, gathered together some specimens of the *Table Talk* of the few last years. But remarkable as these are for the breadth

of sympathy and extent of reading disclosed, they will hardly convey the impressions furnished in a dramatic form, as in Boswell's great work. Four volumes of *Literary Remains*—lately reprinted and rearranged—were published after his death, and these, along with the chapters on the poetry of Wordsworth in the *Biographia Literaria*, may be said to exhibit the full range of Coleridge's power as a critic of poetry. In this region he stands supreme. With regard to the preface, which contains Wordsworth's theory, Coleridge has honestly expressed his dissent:—"With many parts of this preface, in the sense attributed to them, and which the words undoubtedly seem to authorize, I never concurred; but, on the contrary, objected to them as erroneous in principle, and contradictory (in appearance at least) both to other parts of the same preface, and to the author's own practice in the greater number of the poems themselves." This disclaimer of perfect agreement renders the remaining portion of what he says more valuable. Whoever desires to trace the real essential characteristics of poetry must turn to these pages, where the provinces of imagination and fancy are rightly discriminated. "Here," as Principal Shairp has well said, "are canons of judgment, not mechanical but living." Coleridge was in England the creator of that higher criticism which had already in Germany accomplished so much in the hands of Lessing and Goethe. It is enough to refer here to the fragmentary series of his Shakespearian criticisms, containing evidence of the truest insight, and a marvellous appreciation of the judicial "sanity" which raises the greatest name in literature far above even the highest of the poets who approached him.

As a poet Coleridge's own place is safe. His niche in the great gallery of English poets is secure. Of no one can it be more emphatically said that he was "of imagination all compact." His peculiar touch of melancholy tenderness may prevent his attaining a high place in popular estimation. He does not possess the fiery pulse and humaneness of Burns, but the exquisite perfection of his metre and the subtle alliance of his thought and expression must always secure for him the warmest admiration of true lovers of poetic art. In his early poems may be found traces of the fierce struggle of his youth. The most remarkable is the *Monody on the Death of Chatterton* and the *Religious Musings*. In what may be called his second period, the ode entitled *France*, considered by Shelley the finest in the language, is most memorable. The whole soul of the poet is reflected in the *Ode to Dejection*. The well-known lines—

"O Lady! we receive but what we give,  
And in our life alone does nature live;  
Ours is her wedding garment, ours her shroud,"

with the passage which follows, contain more vividly, perhaps, than anything which Coleridge has written, the expression of the shaping and coloring function which he assigns, in the *Biographia Literaria*, to imagination. *Christabel* and the *Ancient Mariner* have so completely taken possession of the highest place, that it is needless to do more than allude to them. The supernatural has never received such treatment as in these two wonderful productions of his genius, and though the first of them remains a torso, it is the noblest torso in the gallery of English literature. Although Coleridge had, for many years before his death, almost entirely forsaken poetry, the few fragments of work which remain, written in later years, show little trace of weakness, although they are wanting in the unearthly melody which imparts such a charm to *Kubla Khan*, *Love*, and *Youth and Age*.

In one of the most remarkable of his republished essays, Mr. Mill has contrasted Coleridge with Bentham, and called especial attention to his position as a political theorist. Few will be tempted to dispute the justice of Mr. Mill's exposition of Coleridge's views. He regards him as having in his *Lay Sermons* done his best to establish principles involved in English opinions and institutions. He admits, moreover, that in bringing into prominence the trust inherent in landed property Coleridge has done service to those who desire to conserve much of the existing system.

The fifth chapter of the work on *Church and State* contains the exposition of Coleridge's idea of a church establishment. The clergy of the nation is with him the body of true leaders in all that concerns national life. Theology is only a part of the great province within national con-

trol—"it is no essential part of the being of the national church, however conducive, or even indispensable, it may be to its well-being." This doctrine, however novel it may have been on its first appearance, has long been adopted by those who desire to preserve the endowments of establishments. In all his political writings Coleridge is at war with what has been called the *laissez-faire* doctrine, and no one has more emphatically declared what the real objects of a state are.

In everything which Coleridge wrote, there are traces of the philosophy which had become to him a second nature. After having abandoned the teaching of Hartley, he directed his attention for a time to Leibnitz and Spinoza. But the systems of these two great men never really captivated him. It was to Kant that he owed his initiation into the higher sphere of philosophy, and it is to Kant that he repeatedly refers as to a master who had moulded his thought. It is impossible to enter here upon the question as to whether Coleridge has represented Kant's system completely. De Quincey, in one of his *Letters to a Young Man*, has referred to the modification and alteration which all things received in passing through Coleridge's thoughts, and has declared that this "indocility of mind" has led Coleridge to make various misrepresentations of Kant. A similar accusation has been preferred by Dean Mansel; but to these charges it may be answered that Coleridge nowhere professes to interpret or describe Kant's teaching. He was content to adopt the distinction between the understanding and the reason, but it was to the doctrine of the practical reason dominating and controlling speculation that he was irresistibly attracted. The immediate contemplation of truth enjoyed by the reason was the sum and substance of his speculations in this province. This doctrine constituted in Coleridge's mind the bridge of passage from metaphysics to theology. "There," to use the words of Mr. Hort, in an able essay on Coleridge, "he found an assurance that man's reasoning powers are not man himself, and that he may rise above their impotence, and have direct faith in unseen realities." At a time when low and grovelling ideas had obtained great predominance, Coleridge recalled men's thoughts to the reality of spiritual truth, and attempted again to enlist interest for a reconciliation between metaphysics and ordinary modes of thought. *The Friend* contains an interesting application of the Platonic idea to induction. Coleridge declares that there is no real opposition between the method of Plato and that pursued by Bacon. It must, however, be acknowledged that the ground of his defence of Bacon hardly satisfies; and the observation of Dr. Whewell, "that Bacon does not give due weight to the ideal element of our knowledge," will occur to the reader of the *Essays on Method*, however he may admire the skill and finish of Coleridge's treatment. Scattered throughout the fragmentary writings of Coleridge may be found remarkable protests against the school of moral philosophy of which Paley was the chief. The governing nature of the moral principle with him determined the quality of moral action. Morality and religion are in his system twin stars, never to be divided. The real code, imperatively demanding the subjugation of man, issues from the divine will, resident, in a measure, in each man. He eagerly disclaims, however, all theories which would claim an inherent power in reason to determine questions of civil government. His contention against Rousseau is most effective, and even at the present time must possess an interest for all engaged in political deliberation. Since the able defence of Sara Coleridge, contained in her edition of her father's *Biographia Literaria*, discussions regarding the plagiarisms of Coleridge may be said to have been forgotten. The infirmity of his character, and the mental confusion caused by the unhappy habit which so long had dominion over him, indisposed him for the exactitude rightly demanded from all who undertake philosophical discussion. An interesting communication from Schelling to Dean Stanley declares that that great thinker vindicated Coleridge from the charge of plagiarism. In the latter part of his life, more than one of those admitted to his confidence have given curious instances of his confusion between the words of an author and the *marginalia* which he had written in that author's pages. A letter to Mr. Cottle, written in the year 1807, describes in an interesting way Coleridge's abandonment of Unitarianism and his final acquiescence in the creed of the church. As a theologian he contended

earnestly for the self-evidencing nature of revealed religion. To historical and miraculous proof he may be said to have assigned a secondary place. Grasping the idea of the incarnation, he held that miracles were the needful outcome of the great fact, and he taught that the adaptation of truth to the moral nature constituted its strongest evidence. For the teaching of Luther he had a profound admiration, and with the works of the great English divines he was thoroughly familiar. In the *Aids to Reflections*—a work which has been the especial favorite of some of the most remarkable of recent divines—after discussing the difficulties of thought and speculation, he grapples with the moral impediments which surround the doctrines of original sin and atonement. His earnest, passionate yearning after truth is manifested in every page of this remarkable book. Whatever may be thought of the conclusions at which he arrives, the convictions of the writer, and his intense sympathy with all inquiring spirits, lift the book into a place in the affections of its readers. It is impossible almost to convey any adequate idea of the richness and variety of Coleridge's speculations on theology and religion, scattered throughout his too fragmentary works. *The Confessions of an Enquiring Spirit*, published since his death, intended not to lessen but to increase the reverence with which Christians regard the Bible, has been more misunderstood than any portion of his writings. That the real object of Coleridge was to conserve and not to destroy, now that the mists of controversy are dispelled, must be apparent to every one who peruses this little volume. Much, indeed, that seemed startling in it on its first appearance has now been accepted as matter of familiar truth.

The fame of Coleridge as a philosophic thinker is undoubtedly, at present, not so great as it was during the twenty years immediately after his death. The generation of those who "owed" to his teaching "even their own selves" has nearly passed away. But the influence which he exerted as a stimulating force, and the intellectual activity of many of his disciples, remain to testify to the greatness of the services which he rendered to philosophy and religion. He was a true lover of light, and desired that all philosophical investigation should be conducted in the independent spirit which is reflected in the noble aphorism of his *Aids to Reflection*—"he who begins by loving Christianity better than truth will proceed by loving his own sect and church better than Christianity, and end in loving himself better than all."

After Coleridge's death several of his works were edited by his nephew, Henry Nelson Coleridge, the husband of Sara, the poet's only daughter. In 1847 Sara Coleridge published the *Biographia Literaria*, enriched with annotations and biographical supplement from her own pen. Three volumes of political writings, entitled *Essays on his own Times*, were also published by Sara Coleridge in 1850. Besides the essay on Coleridge contained in the first volume of J. S. Mill's *Dissertations*, there is a very complete study of Coleridge in Principal Shairp's *Studies in Poetry and Philosophy*. Mr. Hort's *Essay, in the Cambridge Essays of 1856*, is full of interest. In Archdeacon Hare's *Mission of the Comforter* will be found valuable reflections on the theological position of Coleridge. (G. D. B.)

COLERIDGE, SARA (1802-1852), was the fourth child and only daughter of Samuel Taylor Coleridge and his wife Sarah Fricker of Bristol. She was born December 22, 1802, at Greta Hall, Keswick, the residence of her parents, where they were shortly afterwards joined by Southey and his wife, who was Mrs. Coleridge's sister, and by Mrs. Lovell, a third sister, and widow of the young Quaker poet, Robert Lovell. Here, after 1803, they all lived together; but Coleridge was often away from home; and "Uncle Southey" was a *pater familias*. The Wordsworths at Grasmere were their neighbors, and the children of the three families grew up together. Wordsworth, in his poem the *Triad*, has left us a description, or "poetical glorification," as Sara Coleridge calls it, of the three girls—his own daughter Dora, Edith Southey, and Sara Coleridge, the "last of the three, though eldest born." Greta Hall was Sara Coleridge's home until her marriage, and the little Lake colony of poetical and speculative genius seems to have been her only school. Guided by Southey, and with his ample library at her command, she read by herself the chief Greek and Latin classics, and before she was five-and-twenty had learnt French, German, Italian, and Spanish.

In 1822 Sara Coleridge published a translation in three large volumes of Dobrizhoffer's *Account of the Abipones*, undertaken in connection with Southey's *Tale of Paraguay*, which had been suggested to him by Dobrizhoffer's volumes; and Southey alludes to his niece, the translator (canto iii., stanza 16), where he speaks of the pleasure the old missionary would have felt if

"... he could in Merlin's glass have seen  
By whom his tomes to speak our tongue were taught."

In less grandiloquent terms, Charles Lamb, writing about the *Tale of Paraguay* to Southey in 1825, says, "How she Dobrizhoffer'd it all out, puzzles my slender Latinity to conjecture." In 1825 her second work appeared, a translation from the mediæval French, in 2 volumes, called *The Right Joyous and Pleasant History of the Feats, Jests, and Processes of the Chevalier Bayard, the Good Knight without Fear and without Reproach: By the Loyal Servant*.

In September, 1829, at Crosthwaite Church, Keswick, after an engagement of seven years' duration, Sara Coleridge was married to her cousin, Henry Nelson Coleridge, then a Chancery barrister in London. The first eight years of her married life were spent in a little cottage on Downshire Hill, in the town of Hampstead. There four of her children were born, of whom two survived. In 1834 Mrs. Coleridge published her *Pretty Lessons in Verse for Good Children; with some Lessons in Latin in Easy Rhyme*. These were originally written for the instruction of her own children. On their publication they became very popular; and a new edition has been lately published by Henry S. King & Co. In 1837 the Coleridges removed to Chester Place, Regent's Park; and in the same year appeared *Phantasmion, a Fairy Tale*, Sara Coleridge's longest original work. An edition of this also was published in 1874 by Henry S. King & Co., with a preface by Lord-Chief-Justice Coleridge. The *Songs of Phantasmion* were much admired at the time by Leigh Hunt and other critics; and Mr. Justice Coleridge is not afraid to say of them in his preface that they are "surely worthy of any great lyrical writer." Without meriting such praise as this, however, some of these songs, such as "Sylvan Stay" and "One Face Alone," are extremely graceful and musical, and the whole fairy tale is noticeable for the beauty of the story and the richness of its language.

In 1843 Mr. Henry Coleridge died, leaving to his widow the unfinished task of editing her father's works. To these she added some compositions of her own, among which are the *Essay on Rationalism, with a special application to the Doctrine of Baptismal Regeneration*, appended to Coleridge's *Aids to Reflection*, a Preface to the *Essays on his Own Times*, by S. T. Coleridge, and the Introduction to the *Biographia Literaria*. During the last few years of her life Sara Coleridge was a confirmed invalid. Shortly before she died she amused herself by writing a little autobiography for her daughter. This, which reaches only to her ninth year, was completed by her daughter, and published in 1873, together with some of her letters, under the title *Memoirs and Letters of Sara Coleridge*. These letters show a cultured and highly speculative mind. They contain many apt criticisms of known people and books, and are specially interesting for their allusions to Wordsworth and the Lake Poets. Sara Coleridge died at Chester Place, May 3, 1852, and was buried by the side of her father, mother, and husband, in Highgate churchyard.

COLET, JOHN (1466-1519), dean of St. Paul's, the eldest son of Sir Henry Colet, was born at London in 1466. His education commenced in St. Anthony's school in that city, from which, in 1483, he was sent to Magdalen College, Oxford. After seven years' study of logic and philosophy, he took his degree in arts. About the year 1493 he went to Paris, and thence to Italy, in order to improve himself in the Greek and Latin languages, which at that time were imperfectly taught in our universities. During his residence abroad he became acquainted with Budæus and Erasmus. On his return to England in 1497 he took orders, and settled at Oxford, where he read lectures, without fee, on the Epistles of St. Paul. At this period he held the rectory of St. Dennington in Suffolk, to which he had been instituted at the early age of nineteen; and he was also prebendary of York, and canon of St. Martin's le Grand, London. In 1502 he became prebendary of Sarum, in 1505 prebendary of St. Paul's, and immediately afterwards dean of that cathedral, having previously taken the

degree of doctor of divinity. He was no sooner raised to this dignity than he introduced the practice of preaching and expounding the Scriptures; and he soon afterwards established a perpetual divinity lecture, on three days in each week, in St. Paul's Church,—an institution which helped to pave the way for the Reformation. About the year 1508 Dean Colet formed his plan for the foundation of St Paul's school, which he completed in 1512, and endowed with estates of an annual value of £122 and upwards. The celebrated grammarian William Lilly was the first master, and the company of mercers were appointed trustees. The dean's religious opinions were so much more liberal than those of the contemporary clergy, that they deemed him little better than a heretic; and on this account he was so frequently molested that he at last determined to spend the rest of his days in peaceful retirement. To carry this resolution into effect he built a house near the palace of Richmond; but being seized with the sweating sickness, he died in 1519, in the fifty-third year of his age. He was buried on the south side of the choir of St. Paul's, where a stone was laid over his grave, with no other inscription than his name. Besides the preferences above mentioned, he was rector of the guild of Jesus at St. Paul's, and chaplain to Henry VIII. Dean Colet, though in communion with the Church of Rome, disapproved of auricular confession, of the celibacy of priests, and other tenets and ceremonies which have since been rejected by all Protestants. He wrote—*Absolutissimus de octo orationis partium constructione Libellus* (Antwerp, 1530), *Rudimenta Grammatices* (London, 1539), *Daily Devotions, Monition to a Godly Life, Epistolæ ad Erasmus*, and commentaries on different parts of the sacred books, together with a number of smaller theological works.

COLET, LOUISE REVOIL (1808-1876), French poetess and novelist, belonged to a Provençal family, and was born at Aix. In 1834 she came to Paris; and in 1836 appeared her *Fleurs du Midi*, a volume of verse, of liberal tendency, which made some noise, and gained her the friendship of Teste and Cousin. It was followed in 1839 by *Penserosa*, a second volume of verse; by *Le Musée de Versailles*, a poem crowned by the Institute; by *La Jeunesse de Goethe*, a one-act comedy; and by *Les Œuvres Brietas*, a novel. In 1840 she published *Les Funerailles de Napoléon*, a poem, and *La Jeunesse de Mirabeau*, a reckless novel. The criticisms on her books, however, on her academical successes, and on her connection with several celebrated men about this time, exasperated her to an incredible degree; and in 1841 Paris was diverted by her attempted reprisals on Alphonse Karr for certain notices in *Les Gaietés*. In 1849 she had to defend an action brought against her by the heirs of Madame Récamier, whose correspondence with Benjamin Constant she had taken it upon herself to publish in the columns of the *Press*. She was crowned five or six times by the Institute, a distinction which she owed, however, to the influence of Cousin rather than to the quality of her work. She produced a host of writings in prose and verse—novels, plays, anacronistics, didactic poems, travels, copy for a milliner's journal, translations from Shakespeare—singularly unequal in matter and style. Only one of her books has survived—*Lui: Roman Contemporain*, the novel in which she told the story of her life; and that, whatever value it may possess as an historical document, is worthless as a work of art. Madame Colet seems to have been a woman of some literary talent, wanting altogether in the quality of self-respect and the power of self-control.

COLIC (from *κόλον*, the large intestine). By this term is generally understood an attack of pain in the abdomen, usually seated in the neighborhood of the navel, of spasmodic character, and attended for the most part with constipation of the bowels. Various forms of this complaint are described by medical writers. The most important are simple or flatulent colic and lead colic. The former of these commonly arises from the presence in the alimentary canal of some indigestible matter, which not only excites spasmodic contraction of the muscular coats of the intestines, but also, by beginning to undergo decomposition, gives rise to the presence of gases, which painfully distend the bowels and increase the patient's suffering. The pain of colic is relieved by pressure over the abdomen, and there is no attendant fever—points which are of importance in distinguishing it from inflammation.

Attacks of this form of colic may occur in connection

with a variety of causes other than that above mentioned, e.g., from accumulations of feculent matter in the intestines in the case of those who suffer from habitual constipation; also as an accompaniment of nervous and hysterical ailments, and not unfrequently as the result of exposure to cold and damp, particularly where the feet become chilled as in walking through snow. Similar attacks of colic are apt to occur in young infants, especially those who are fed artificially; and in such cases it will generally be found that the food is passing through them almost wholly undigested, and that a temporary change of diet will be necessary. The duration of an attack of simple colic is seldom long, and in general no ill consequences follow from it. It is, however, not free from risk, especially that of sudden obstruction of the bowel from twisting, or invagination of one part within another (intussusception) during the spasmodic seizure, giving rise to the terrible disease known as ileus.

Of greater importance and interest in a medical point of view is the disease known as lead colic (*Syn. painters' colic, colica Pictorum*, Devonshire colic, dry belly-ache), from its having been clearly ascertained to be due to the absorption of lead into the system. This disease had been observed and described long before its cause was discovered. Its occurrence in epidemic form among the inhabitants of Poitou was recorded by Francis Citois, in 1617, under the title of *Novus et popularis apud Pictones dolor colicus bilious*. The disease was thereafter termed *colica Pictorum*. It was supposed to be due to the acidity of the native wines, but it was afterwards found to depend on lead contained in them. A similar epidemic broke out in certain parts of Germany in the end of the 17th century, and was at the time believed by various physicians to be caused by the admixture of acid wines with litharge to sweeten them.

About the middle of last century this disease, which had long been known to prevail in Devonshire, was carefully investigated by Sir George Baker, who succeeded in tracing it unmistakably to the contamination of the native beverage, cider, with lead, either accidentally from the lead-work of the vats and other apparatus for preparing the liquor, or from its being sweetened with litharge.

It has subsequently been made out that this complaint is apt to affect all persons who work among lead or its preparations, especially lead-miners, manufacturers of white lead, color-grinders, and painters, also to a less extent plumbers, potters, type-founders, &c. It is said to have occurred in persons who have slept for only a few nights in a newly-painted room. It has frequently arisen from the use of drinking water containing salts of lead in solution, as also from food and condiments adulterated with preparations of this metal, and it has even been known to follow the habitual use of cosmetics composed in part of white lead.

The colic due to lead poisoning, which in its general characteristics is essentially the same as ordinary colic, is only one of a train of symptoms produced by the absorption of lead into the body. From prolonged exposure to the action of this poison, the general nutrition of the body becomes deteriorated, and serious nervous phenomena present themselves, sometimes in the form of epilepsy and coma, but more usually as a variety of palsy. This palsy is of local character, affecting in the first instance the muscles composing the ball of the thumb, and also those muscles of the fore-arm which extend the wrist, and giving rise to the condition known as "wrist-drop," from the circumstance that when the arm is extended the hand hangs down and cannot be raised by voluntary effort. The affected muscles undergo atrophy while the paralysis continues. If the patient is removed from further exposure to the influence of the lead poison, and suitable treatment employed, complete recovery from all the ill effects may take place; but otherwise all the symptoms become aggravated, the health becomes completely ruined, and death may result.

One of the phenomena which accompany lead poisoning is the existence of a blue line along the margins of the gums where they meet the teeth. This is almost never absent, and is an important aid to the diagnosis of the disease.

The absorption of copper into the system produces a series of symptoms similar to those of lead poisoning, including a form of colic. It is of comparatively rare occurrence, being chiefly observed among workers in copper.

The treatment of colic consists in means to relieve the spasmodic pain, and in the removal, where possible, of the cause upon which it depends. The former of these indications is fulfilled by the administration of opiates (except in the case of children) and the application of warm fomentations to the abdomen. Where the attack appears to depend on accumulations of irritating matter in the alimentary canal, a brisk purgative will, in addition, be called for.

In the case of lead colic it is imperatively necessary that the patient be removed from the source of the lead poisoning. Here, too, the free evacuation of the bowels by castor oil or saline purgatives is an important part of the treatment. As an antidote to the lead absorbed into the system, the administration of iodide of potassium is recommended, while for the paralysis nerve tonics, such as quinine and strychnia, and the use of galvanism, will in general yield good results. Where the patient's occupation necessitates his exposure to the constant influence of the lead poison, as in the case of color-grinders or manufacturers of white lead, the evil consequences can in great measure be averted by scrupulous attention to cleansing the body, particularly before eating, by abstinence from eating in the work places, and by the habitual use of a drink slightly acidulated with sulphuric acid.

The terms *hepatic colic* and *renal colic* are applied to that violent pain which is produced, in the one case, where a biliary calculus or gall stone passes down from the gall bladder into the intestine, and in the other where a renal calculus descends from the kidney along the ureter into the bladder. These affections are, however, entirely different from true colic.

(J. O. A.)

**COLIGNI, GASPARD DE (1517-1572)**, admiral of France, was son of the Marshal Gaspard de Coligni and Louise de Montmorency, and was born at Chatillon-sur-Loing, the hereditary domain of his house. At twenty-two he came to court, and there contracted a friendship with Francis of Guise. In the campaign of 1543 Coligni distinguished himself greatly, and was wounded at the sieges of Montmédy and Bains. In 1544 he served in the Italian campaign under the Duc d'Enghien, and was knighted on the field of Cerisoles. Returning to France, he took part in different military operations; and having been made colonel-general of the infantry, exhibited great capacity and intelligence as a military reformer. He was soon afterwards made admiral in room of D'Annebaut. At the battle of Renty (1554) began the quarrel between him and Francis of Guise, which was to bring such evil on both their houses, and on their native land; and the enmity was increased tenfold in 1556 by the rupture, at the instance of Guise, of the Treaty of Vauxcelles. In 1557 he was intrusted with the defence of Saint Quentin. In the siege he displayed great courage, resolution, and strength of character; but the place was taken, and he was imprisoned in the stronghold of L'Ecluse. On payment of a ransom of 50,000 crowns he recovered his liberty. But he had by this time become a Huguenot, through the influence of his brother Dandelot; and he busied himself secretly with protecting his co-religionists, a colony of whom he sent to Brazil, whence they were afterwards expelled by the Portuguese. On the death of Henry II. he placed himself, with Louis, prince of Condé, in the front of his sect, and demanded religious toleration and certain other reforms. In 1560, at the Assembly of Notables at Fontainebleau, the hostility between Coligni and Francis of Guise broke violently forth; the death of Francis II. and the policy of Catharine precipitated matters to an issue; the civil war began; and the battle of Dreux (1562), clearing the ground of the Constable Montmorency and the prince of Condé, set the two great rivals at the head of their respective parties. In 1563, however, the Pacification of Amboise was effected; Francis of Guise was assassinated; and peace was maintained for some years. The Huguenot attempt to seize on the person of Charles IX. at Monceaux brought about a resumption of hostilities. At St. Denis (1567) Coligni defeated Montmorency; in 1569 he was defeated at Jarnac by the duke of Anjou, and repaired with the remains of his army to Cognac. There he was joined by the prince of Navarre, who was forthwith placed at the head of the Protestant party; the two laid siege to Poitiers, which was defended by Henry of Guise; but the siege was raised, and the Huguenots were routed at Moncontour (1569) with terrible slaughter. A price of 50,000 crowns was set upon the admiral's head; but the

peace of St. Germain was concluded in 1570, and he returned to court. He grew rapidly in favor with Charles IX. As a means of emancipating the king from the tutelage of his mother and the faction of the Guises, the admiral proposed to him a descent on Spanish Flanders, with an army drawn from both sects, and commanded by Charles in person. The king's regard for the admiral, and the bold front of the Huguenots, alarmed the queen mother; and the massacre of St. Bartholomew was the consequence. On 22d August, 1572, Coligni was shot in the street by Maurevert, a bravo in the pay of Henry of Guise; the bullets, however, only tore a finger from his right hand and shattered his left elbow. The king visited him, but the queen mother prevented all private intercourse between them. On the 24th August, the night of the massacre, he was attacked in his house by the minions of Guise, led by a German named Behme, who slew him and cast him from a window into the courtyard at their master's feet. His body was gibbeted at Montfaucon; it was, however, carried off by his retainers, and buried at Chatillon, where it remained till 1786, when Montesquieu had it reinterred at his own estate of Mauvertuis. His papers were seized and burned by the queen mother; among them, according to Brantôme, was a history of the civil war "très-beau et très-bien fait, et digne d'estre imprimé."

**COLIMA**, the capital of the state of Colima, Mexico, in 19° N. lat. and 103° 7' W. long. The town is situated in a fertile and well-watered plain. It has regular streets, mostly paved, a Government house, a college, several schools and churches, and two squares, and is a place of considerable trade in linens, woollens, cotton goods, and hardware. The population exceeds 31,000. Colima was founded by Gonzalo de Sandoval in 1522, received incorporation from Philip II., and attained the rank of a city in 1824. Thirty miles to the N.E. is the volcano of Colima, the most westerly in Mexico, and 12,000 feet in height. For some days previous to the earthquake which visited the Pacific coast of Mexico on the 20th December, 1868, the volcano emitted smoke and steam; and in 1869, after 40 years' inactivity, there was another eruption. Manzanilla, the port of Colima, about 60 miles west of that town, has a good anchorage, and is sheltered from the south winds prevalent during the rainy season; but, on account of the proximity of a stagnant marsh, it is an unhealthy place; and it abounds, moreover, with mosquitoes and sandflies.

**COLIN, ALEXANDER (1528-1612)**, a Flemish sculptor, was born at Mechlin. In 1563 he went, at the invitation of the emperor Ferdinand I., to Innsbruck, to work on the magnificent monument which was being erected to Maximilian I. in the nave of the Franciscan church. Of the twenty-four marble alti-rilievi, representing the emperor's principal acts and victories, which adorn the sides of this tomb, twenty were executed by Colin, apparently in three years. The work displays a remarkable combination of liveliness and spirit with extreme care and finish, its delicacy rivalling that of a fine cameo. Thorwaldsen is said to have pronounced it the finest work of its kind. Colin, who was sculptor in ordinary both to the emperor and to his son, the archduke Ferdinand, did a great deal of work for his patrons at Innsbruck, and in its neighborhood; particular mention may be made of the sepulchres of the archduke and his first wife Philippa, both in the same church as the Maximilian monument. His tomb in the cemetery at Innsbruck bears a fine bas relief executed by himself.

**COLLAERT, HANS**, a Flemish engraver, was the son of Adrian Collaert, a draughtsman and engraver of repute, and was born at Antwerp about 1545. After working some years in his father's studio, he went to Rome to perfect himself in his art. His engravings after Rubens are very highly esteemed. He left many works; among the best may be mentioned a Life of Saint Francis, 16 prints; a Last Judgment, folio; Monilium, Bullarum, Inauriumque Artificiosissimæ Icones, 10 prints, 1581; The Dead Christ in his Mother's Lap; Marcus Curtius; Moses Striking the Rock, and The Resurrection of Lazarus, after Lambert Lombard; the Fathers of the Desert; and Biblia Sacra and the History of the Church, after Rubens.

**COLLE, CHARLES (1709-1783)**, dramatist and song-writer, was the son of a notary, and was born at Paris. At a very early age he began to study the writings of Marot and La Fontaine, of Chapelle and Molière, to take delight

in the theatre, and to be specially interested in the rhymes of Jean Héganier, then the most famous maker of couplets in Paris. From a notary's office Collé, who seems to have had little taste for legal studies, was transferred to that of M. de Meulan, the receiver-general of finance. When about seventeen, however, he made the acquaintance of Piron, and afterwards, through Gallet, of Panard. The example of these three masters of the vaudeville, while determining his vocation, made him diffident; and for some time he composed nothing but *amphigouris*—verses whose merit was measured by their unintelligibility. The friendship of the younger Crébillon, however, diverted him from this byway of art, and the establishment in 1729 of the famous "Caveau" gave him a field for the display of his fine talent for popular song. In 1739 the Society of the Caveau, which numbered among its members Helvetius, Duclos, Gentil-Bernard, Boucher, Rameau, Piron, and the two Crébillons, was dissolved, and was not reconstituted till twenty years afterwards. Meanwhile, the Regent Orleans, who was an excellent comic actor, particularly in representations of low life, and who had been looking out for an author to write suitable parts for him, made Collé his secretary. It was for the duke and his associates that Collé composed the greater part of his *Théâtre de Société*. Based on the stories of the younger Crébillon and La Fontaine, all the pieces in this collection, while remarkable for ease and gayety, in point of delicacy are such as might be expected from their source and their avowed object. In 1763, however, Collé, whose jestings the duke had rewarded with a place under Government, produced at the *Théâtre Français Dupuis et Desronais*, a sentimental comedy, which met with a decided success, and which was followed in 1771 by *La Veuve*, an attempt in the same direction, and a complete failure. In 1774 appeared *La Partie de chasse de Henri Quatre* (partly taken from Dodsley's *King and the Miller of Mansfield*), Collé's last and best play. From 1758 to 1782, besides these and a multitude of songs, Collé was writing his *Journal Historique*, a curious collection of literary and personal strictures and animadversions on his boon companions as well as on their enemies, on Piron as on Voltaire, on La Harpe as on Corneille. In 1783, having outlived the greater part of his old friends, and grieving for the loss of his wife, to whom he was greatly attached, Collé died. He is best remembered by his lyrics, which form an important link in the chain of style through which the *chanson*, that peculiarly French form of the song, has passed. They are frank and jovial, though often licentious, and are remarkable for wit and amiability no less than for the artistic management of the refrain and for their popular attractions. The subjects are love and wine; occasionally, however, as in the famous lyric (1756) on the capture of Port Mahon, for which the author received a pension of 600 livres, the note of patriotism is struck with no unskilful hand, while in many others Collé shows himself possessed of considerable epigrammatic force. See Grimm's *Correspondance*, and Tallefer's *Tableau Historique de l'Esprit et du Caractère des Littératures Françaises*.

COLLE, RAFAELLE DEL, painter, was born at Colle, near Borgo San Sepolcro, in Tuscany, about 1490. A pupil of Raphael, whom he is held to have assisted in the Farnesina and the Vatican, Colle, after his master's death, was the assistant of his chief scholar, Giulio Romano, at Rome and afterwards at Mantua. In 1536, on the occasion of the entry of Charles V. into Florence, he took service in that city under Vasari, whose written works are many degrees superior to his paintings. In his later years Colle resided at Borgo San Sepolcro, where he kept a school of design; among his many pupils of note may be mentioned Gherardi and Vecchi. His works, which are yet to be found at Urbino, at Perugia, at Pesaro, and at Gubbio, are fine examples of the Roman school of Raphael. The best are a painting of the Almighty supported by angels, a Resurrection, and an Assumption, all preserved in churches at Borgo San Sepolcro.

COLLEGE (*Collegium*), in Roman law signified a number of persons associated together by the possession of common functions,—a body of colleagues. Its later meaning applied to any union of persons, and *Collegium* was the equivalent of *trapezia*. In many respects, e.g., in the distinction between the responsibilities and rights of the society and those of individual members thereof, the colle-

gium was what we should now call a corporation (see CORPORATION). *Collegia* might exist for purposes of trade like our guilds, or for religious purposes (e.g., the colleges of augurs, of pontifices, &c.), or for political purposes, e.g., *tribunorum plebis collegia*. By the Roman law a *collegium* must have at least three members. The name is now usually applied to educational corporations, the most important of which are the colleges of Oxford and Cambridge. In the numerous statutes relating to colleges the colleges of Winchester and Eton are usually associated with those of Oxford and Cambridge.

These colleges are in the eye of the law eleemosynary corporations. In some of the earlier statutes of Queen Elizabeth they are spoken of as having an ecclesiastical character, but the doctrine of the common law since the Reformation has been that they are purely lay corporations, notwithstanding that most or all of their members may be persons in priest's orders. This is said to have been settled by Patrick's case (see Raymond's *Reports*).

Colleges appear to have grown out of the voluntary association of students and teachers at the university. According to some accounts these must at one time have been numerous and flourishing beyond anything we are now acquainted with. We are told, for example, of 300 halls or societies at Oxford, and 30,000 students. Into the truth of these statements, or into the causes which led to the reduction in the number of scholars, we need not now enter. In early times there seems to have been a strong desire to confine the scholars to certain licensed houses, beyond the influence of the townspeople. Men of wealth and culture, and notably the political bishops and chancellors of England, obtained charters from the Crown for the incorporation of societies of scholars, and these in time became exclusively the places of abode for students attending the university. At the same time the corporations thus founded were not necessarily attached to the locality of the university. The early statutes of Merton College, for example, allow the residence of the college to be shifted as occasion required; and the foundations of Wolsey at Oxford and Ipswich seem to have been the same in intention. In later times the university and the colleges became coextensive; every member of the university had to attach himself to some college or hall, and every person admitted to a college or hall was obliged to matriculate himself in the university.

In Ayliffe's *Ancient and Present State of the University of Oxford* it is stated that a college must be "made up of three persons (at least) joined in community. And the reason of this almost seems to speak its own necessity, without the help of any express law to countenance it: because among two persons only there cannot be, in fact, a major part; and then if any disagreement should happen to arise between them it cannot be, in fact, brought to a conclusion by such a number alone in case both the parties should firmly adhere to their dissenting opinions; and thus it is declared by the civil law. But by the canon law it is known to be otherwise; for by that law two persons in number may make and constitute a college, forasmuch as according to this law two persons make and constitute an assembly or congregation. The common law of England, or rather the constant usage of our princes in erecting aggregate bodies, which has established this rule among us as a law, has been herein agreeable to the method and doctrine of the civil law, for that in all their grants and charters of incorporation of colleges they have not framed any aggregate body consisting of less than three in number." Another principle, apparently derived from the civil law, is that a man cannot be a fellow in two colleges at the same time. The law of England steadily resisted any attempt to introduce the principle of inequality into colleges. An Act of Henry VIII. (33, c. 27), reciting that divers founders of colleges have given in their statutes a power of veto to individual members, enacts that every statute made by any such founder, whereby the grant or election of the governor or ruler with the assent of the most part of such corporation should be in any wise hindered by any one or more being the lesser number (contrary to the common law), shall be void.

The corporation consists of a head or master, fellows, and scholars. Students, not being on the foundation, residing in the college, are not considered to be members of the corporation. The governing body in all cases is the head and fellows.

It is considered essential to corporations of an ecclesiastical or educational character that they should have a visitor whose duty it is to see that the statutes of the founder are obeyed. The duties of this officer have been ascertained by the courts of law in a great variety of decided cases. Subject to such restrictions as may be imposed on him by the statutes of the college, his duties are generally to interpret the statutes of the college in disputed cases, and to enforce them where they have been violated. For this purpose he is empowered to "visit" the society—usually at certain stated intervals. In questions within his jurisdiction his judgment is conclusive, but his jurisdiction does not extend to any cases under the common laws of the country, or to trusts attached to the college. Generally the visitorship resides in the founder and his heirs unless he has otherwise appointed, and in default of him in the Crown.

The fellowships, scholarships, &c., of colleges were until a comparatively recent date subject to various restrictions. Birth in a particular county, education at a particular school, relationship to the founder, and holy orders, are amongst the most usual of the conditions giving a preferential or conclusive claim to the emoluments. Most of these restrictions have been or are being swept away. See UNIVERSITIES.

The colleges of the English universities are large landowners. A royal commission in 1874 reported the external income of the colleges of Oxford to be £307,369, 17s. 2d., and of Cambridge £264,256, 17s. 10½d. These sums are mainly derived from landed property, and are exclusive of the revenues of the universities. By several Acts of Parliament colleges are allowed to sell their real property with the consent of the copyhold commissioners, who take care that the purchase-money is laid out in other real property. In college and other corporation property a system of letting land under beneficial leases—i.e., at less than the full yearly rent, and recoverable every seven years on payment of a fine—has long prevailed, and is believed to be responsible for the alleged inferior condition of land belonging to corporations. The system is now being superseded by leases at rack-rent.

At Oxford, in addition to the colleges, there are four or five halls, which differ from colleges mainly in not being corporate bodies. Their property is held in trust for them by the university.

In England the colleges have through their tutors and lecturers supplied nearly all the teaching of the universities—the lectures of the professors being either superfluous or merely ornamental. Of late years colleges have combined their forces for the purpose of establishing common systems of lectures, and there has been a strong desire to reconstitute the teaching power of the universities. Commissions are now being proposed for Oxford and Cambridge, which will have to settle these and other problems of the higher education.

Most of the colleges of Oxford and Cambridge are old foundations—only a few dating from times posterior to the Reformation. Among recent foundations are Downing College at Cambridge, Keble College at Oxford (which is governed by a board or council of trustees), and the restoration of Magdalen Hall at Oxford, now endowed and incorporated under the name of Hertford College.

Among educational corporations under the same title elsewhere, Phillimore (*Ecclesiastical Law*) mentions King's College and University College, London, Sion College, St. Bees, St. David's Lampeter, &c. The distinction between college and university is found also at St. Andrews, and in the more recently founded university of Durham and the Queen's University in Ireland.

COLLIER, ARTHUR (1680-1732), metaphysician and divine, was born at the rectory of Langford Magna, near Farum, on 12th October, 1680. There is no account of his childhood and early youth; but it is probable that, after receiving some rudimentary instruction at home, he went to one of the grammar schools at Salisbury. He entered at Pembroke College, Oxford, in July, 1697, and remained there till October in the following year, when he and his brother William became members of Balliol together. His father died in 1697, and as the family owned the advowson of Langford Magna, it was arranged, after some difficulties raised by Burnet, then bishop of Salisbury, that the benefice should be held by a clergyman until Arthur was old enough to be inducted. He was accordingly presented to the benefice in 1704, and continued in it till his

death in 1732. Although a bold speculator in theology, his sermons intended for his parish show no traces of his peculiar notions, and he seems to have been faithful in the discharge of his duty. He was often in pecuniary difficulties, from which at last he was obliged to free himself by selling the reversion of Langford rectory to Corpus Christi College, Oxford, a misfortune which his biographer attributes to his "habits of abstruse speculation, which seem to have unfitted him for all considerations of worldly prudence." Collier's philosophical opinions took shape early in his mind. They grew out of a diligent study of the writings of Descartes and Malebranche. Norris of Bemer-ton, a neighboring clergyman, also strongly influenced him by his *Essay on the Ideal World*. It is remarkable that Collier makes no reference to Locke, nor shows the least sign of having any knowledge of his works. As early as 1703 Collier seems to have become convinced of the non-existence of an external world. There is among his MSS., under date January, 1708, an outline of an essay in three chapters on the question whether the visible world is external or not. In 1712 he wrote two essays, which are still in manuscript, one on substance and accident, and the other termed *Clavis Philosophica*. The work on which his philosophical reputation depends appeared in 1718, under the title *Clavis Universalis, or a New Inquiry after Truth, being a Demonstration of the Non-Existence or Impossibility of an External World*. It has been favorably mentioned by Reid, Stewart, and others, was frequently referred to by the Leibnitzians, and was translated into German by Professor Eschenbach in 1756. Berkeley's *Principles of Knowledge* and his *Theory of Vision* preceded it by three and four years respectively. Although there is no evidence that they were known to Collier before the publication of his book, a passage in a letter written by him in March, 1713-14, proves that he was acquainted in some measure with Berkeley's opinions at that date. In this letter and other four, which are given in Benson's *Memoirs of Collier* (1837), there are some further remarks in defence of his philosophical views; but they are merely a repetition of the arguments in the *Clavis*. These are grounded on two presuppositions—first, the utter aversion of common sense to any theory of representative perception; and second, the opinion which Collier held in common with Berkeley, and Hume afterwards, that the difference between imagination and sense perception is only one of degree. The former is the basis of the negative part of his argument; the latter supplies him with all the positive account he has to give, and that is meagre enough. The *Clavis* consists of two parts. After some introductory remarks, in which he explains that he will use the term "external world" in the sense of absolute, self-existent, independent matter, and fences the position he is to occupy against sundry possible misinterpretations, he attempts in the first part to prove that the visible world is not external, by showing—first, that the seeming externity of a visible object is no proof of real externity, and second, that a visible object, as such, is not external. The image of a centaur seems as much external to the mind as any object of sense; and since the difference between imagination and perception is only one of degree, God could so act upon the mind of a person imagining a centaur, that he would perceive it as vividly as any object can be seen. Descartes and his school affirm that certain objects of sense, as sounds, smells, etc., exist only in their respective faculties, although no one can doubt that they seem to exist altogether without them. The same philosophers agree that light and colors, which are allowed to be objects properly visible, are not external. Still they seem to be so. The delusions of the insane and the visions of inspired men are further instances of seeming externality which is not real. So is the familiar case of objects seen in a looking-glass. A number of similar illustrations are used to prove the second proposition, that a visible object, as such, is not external. If we assume, for instance, that there is an external moon, it cannot be the same as the visible moon, for this is ever changing and is never bigger than a trencher; but the real moon is some thousands of miles in diameter. Berkeley uses the same argument in his *Alciphron* (1732). Then, too, the Aristotelian and the Cartesian forms of representative perception agree in holding that the true object of vision is not the external reality. The author concludes his first part by replying to objections based on the universal consent of men, on the assurance given by touch of the extra ex-

istence of the visible world, and on the truth and goodness of God (Descartes), which would be impugned if our senses deceived us. Collier argues naively that if universal consent means the consent of those who have considered the subject, it may be claimed for his view. He thinks with Berkeley that objects of sight are quite distinct from those of touch, and that the one therefore cannot give any assurance of the other; and he asks the Cartesians to consider how far God's truth and goodness are called in question by their denial of the externality of the secondary qualities. The second part of the book is taken up with a number of metaphysical arguments to prove the impossibility of an external world. The pivot of this part is the logical principle of contradiction. From the hypothesis of an external world a series of antinomies are deduced, such as that the world is both finite and infinite, is movable and immovable, etc.; and finally, Aristotle and various other philosophers are quoted, to show that the external matter they dealt with, as mere potentiality, is just nothing at all. Among other uses and consequences of his treatise, Collier thinks it furnishes an easy refutation of the Romish doctrine of transubstantiation. If there is no external world, the distinction between substance and accidents vanishes, and these become the sole essence of material objects, so that there is no room for any change whilst they remain as before. Sir William Hamilton thinks that the logically necessary advance from the old theory of representative perception to idealism was stayed by anxiety to save this miracle of the church; and he gives Collier credit for being the first to make the discovery.<sup>1</sup> Professor Ueberweg, on the other hand, is of opinion that idealism and the miracle of the eucharist may be reconciled by regarding substance not as substrate supporting the accidents, but as intelligible essence; so that when in the religious act the body and blood of Christ are conjoined with the bread and wine, these cease to be essential and become accidents, and a different substance is present.<sup>2</sup> But in that form of idealism which recognizes an intelligible essence there must be such a necessary connection between essence and phenomenon as would require the presence of new phenomena along with the new essence. Still it must have been some deeper cause than concern for the church dogma that retarded idealism. Until philosophers could be brought to reflect on the meaning of such notions as externality, cause, etc., it was inevitable that they should continue striving to justify the belief in an external material world. Collier's blank denial would not have turned the stream. It needed a more subtle thinker to divert it into the course which it afterwards followed.

Collier's book possesses an interest for the student of philosophy on account of the resemblance between his views and those of his contemporary Berkeley. Both were impelled to philosophize by their dissatisfaction with the theory of representative perception. Both have the feeling that it is inconsistent with the common sense of mankind, which will insist that the very object perceived is the sole reality, and both claim to substitute for the theory held in favor, and vainly sought to be demonstrated by their predecessors, another that will meet the demands of common sense. They equally affirm that the so-called representative image is the sole reality, and discard the unperceiving material cause of the philosophers as an unthinkable monstrosity. Of objects of sense, they say, their *esse* is *percipi*. But Collier never got beyond a bald assertion of the fact, while Berkeley addressed himself to an explanation of it, which gave him ever profounder matter for philosophical reflection all his days. The thought of a distinction between direct and indirect perception never dawned upon Collier's mind. He could only meet the doctrine of the representationists, therefore, with a flat negation. To the question how all matter exists in dependence on percipient mind he could only reply, "Just how my reader pleases, provided it be somehow." As cause of our sensations and ground of our belief in externality, he substituted for an unintelligible material substance an equally unintelligible operation of divine power. But his illustrious contemporary gave a fresh start to philosophy by his exposition of the association between visual and tactual sensations; and his glimpses, faint at first, gradually grew more distinct of an intelligible order in the universe. Collier's book exhibits no traces of a scientific development. In the first part, which may be compared with Berkeley's *Theory of Vision*, he merely brings together a few instances of visual experience, which throw discredit upon the popular opinion. The most that can be said about him is that

he was an intelligent student of Descartes and Malebranche, and had the ability to apply the results of his reading to the facts of his experience. He starts no original conception, contributes nothing to the development of philosophy. The latter half of his book reads like the ingenious quibbling of the schoolmen. In philosophy he is a curiosity, and nothing more. His biographer tries to make out that the *Clavis* fell flat on the English public in comparison with the reception accorded to Berkeley's writings, on account of its inferiority in point of style. No doubt it is immensely inferior in that respect; but the crudeness of Collier's thought had quite as much to do with his failure to gain a hearing. Hamilton<sup>3</sup> allows greater sagacity to Collier than to Berkeley, for not vainly attempting to enlist men's natural belief against the hypothetical realism of the philosophers. But Collier did so as far as his light enabled him. He appealed to the popular conviction that the proper object of sense is the sole reality, although he despaired of getting men to give up their belief in its externality. He moreover distinctly asserted that nothing but prejudice prevented them from doing so; and there is little doubt that if it had ever occurred to him, as it did to Berkeley, to explain the genesis of the notion of externality, he would have been more hopeful of commending his theory to the popular mind. What Collier simply denied Berkeley tried to explain, and therein lies that real difference between the two writers which accounts for the comparative oblivion that has been the fate of the one, and justifies the place assigned to the other in the history of philosophy.

In a curious discourse on Genesis I. 1, which Collier published in 1730, under the modest title, *A Specimen of a True Philosophy*, we have a jumble of his theological views and his philosophical opinions. Inasmuch as we are often told in Scripture that God created all things in and by the Son, the *ἀρχή* of the passage commented on must refer to the only begotten Son of God. If then we exist in God, because we are made by Him, as St. Paul says, "in him we live, and move, and have our being," we must believe that we exist more immediately in the Son, being told, as in the text, that God made us and all things by and in His Son. Christ, the *ἀρχή* of the whole creation, must needs be in some sense the subject or object of all that is called science. Things, however, do not exist immediately in Christ, but at various distances and projections from Him. Everything is particular in its own proper or immediate *ἀρχή* or substance; but all these terminate in one, the Son of God, the substance of the whole creation. This interpretation of the passage is corroborated by the conclusion reached in the *Clavis Universalis*; for it is there proved that the visible or material world exists immediately in the mind of the percipient, and hence the meaning of the text must be that mind or spirit is the *ἀρχή* in which God created the heaven and the earth. As the objects of sense exist immediately in the mind, so the mind exists immediately in the Son of God; and thus the ladder of being is completed in this *Specimen of a True Philosophy*.

The *Logology*, or a *Treatise on the Logos*, in *Seven Sermons on John i. 1, 2, 3, and 14*, was published in 1732, the year of Collier's death. It further applies his theory of inexistence to the Son, who is said to be in the Father, as men are in Him, and material objects are in them. The Son is the "mean proportional" between God and us. Collier was heterodox in regard to the incarnation, as well as the Trinity, maintaining "that the pre-existent Word, or Son of God, was not united to a created human soul or spirit, but was himself the man called Jesus and the Christ."

See Benson's *Memoirs of the Life and Writings of Arthur Collier*, 1837; Parr's *Metaphysical Tracts by English Philosophers of the Eighteenth Century*, 1837; Tennemann's *History of Philosophy*; Hamilton's *Discussions*; Professor Fraser's edition of *Berkeley's Works*.

COLLIER, JEREMY (1650-1726), a learned English nonjuring divine, born at Stow-cum-Quy, Cambridgeshire, in 1650, and was educated at Caius College, Cambridge. His first appointment was to the small rectory of Ampton, near Bury St. Edmunds, which, after six years, he resigned in order to proceed to London, where in 1685 he was made lecturer of Gray's Inn. The change of Government at the Revolution, however, soon rendered the public exercise of his function impracticable. He was committed to Newgate for writing in favor of the dethroned monarch, and again on a charge of carrying on a treasonable correspondence with the enemies of the popular movement; but he was released on both occasions without trial, by the intervention of his friends. So far did he carry his scruples at this period, that he submitted to confinement rather than make a tacit acknowledgment of the jurisdiction of the court by accepting his liberty upon bail. In the two following years he continued to harass the Government by his publications; but for his boldness in granting absolution at their

<sup>1</sup> Hamilton's *Discussions*, pp. 196-202.

<sup>2</sup> *Annotations on Berkeley's Principles*, p. 128.

<sup>3</sup> *Discussions*, p. 127.



execution to Sir John Friend and Sir William Perkins, who had attempted the assassination of William, he was obliged to flee, and for the rest of his life continued under sentence of outlawry. When the storm had blown over he returned to London, and employed his leisure in literary works, which were less political in their tone. In 1697 appeared the first volume of his *Essays on Several Moral Subjects*, to which a second was added in 1705, and a third in 1709. All three series enjoyed great popularity at the time of their appearance. It was in 1698, however, that Collier produced the book by which he is best known, and for which he has been most justly praised, the famous *Short View of the Immorality and Profaneness of the English Stage*. Its publication involved him in a lengthened controversy with Congreve, Vanbrugh, and the other wits of the day. The book abounds in hypercriticism and in useless display of learning, neither intrinsically valuable nor conducive to the argument. Yet, in the words of Macaulay, who gives an admirable account of the discussion in his essay on the Comic Dramatists of the Restoration, "when all deductions have been made, great merit must be allowed to the work. There is hardly any book of that time from which it would be possible to select specimens of writing so excellent and so various." The *Short View* was followed by a *Defence*, a *Second Defence*, and a *Farther Vindication*, and in 1703 by *Mr. Collier's Dismuasive from the Playhouse, in a Letter to a Person of Quality*. The fight lasted in all some ten years; but Collier had right on his side, and triumphed; and the reformation of the English stage, so greatly needed, may be said to date from the publication of the *Short View*. From 1701 to 1721 Collier was employed in the translation and publication (in six volumes folio) of Moreri's *Dictionnaire Historique*, and in the compilation and issue of the two volumes folio of his own *Ecclesiastical History of Great Britain*. The latter work was attacked by Burnet and others, but the author showed himself as keen a controversialist as ever. Many attempts were made to shake his fidelity to the lost cause of the Stuarts, but he continued indomitable to the end. His last work was a volume of *Practical Discourses*, published in 1725. He died April 26, 1726.

COLLINGWOOD, CUTHBERT (1750-1810), the first Baron Collingwood, a celebrated naval commander, was born at Newcastle-upon-Tyne, on the 26th of September, 1750. He was early sent to school; and when only eleven years of age he was put on board the "Shannon," then under the command of Captain (afterwards Admiral) Brathwaite, a relative of his own, to whose care and attention he was in a great measure indebted for that nautical knowledge which shone forth so conspicuously in his subsequent career. After serving under Captain Brathwaite for some years, and also under Admiral Roddam, he went in 1774 to Boston with Admiral Graves, who in the year following presented him with a lieutenantancy. In 1779 he was made commander of the "Badger," and shortly afterwards post-captain of the "Hinchinbrooke," a small frigate. In the spring of 1780 that vessel, under the command of Nelson, was employed upon an expedition to the Spanish Main, where it was proposed to pass into the Pacific by navigating boats along the River San Juan and the Lakes Nicaragua and Leon. The attempt failed, and most of those engaged in it became victims to the deadly influence of the climate. Nelson was promoted to a larger vessel, and Collingwood succeeded him in the command. It is a fact worthy of record that the latter succeeded the former very frequently from the time when they first became acquainted, until the star of Nelson set at Trafalgar—giving place to that of Collingwood, less brilliant certainly, but not less steady in its lustre.

After commanding in another small frigate, Collingwood was promoted to the "Sampson" of sixty-four guns; and in 1783 he was appointed to the "Mediator," destined for the West Indies, where, with Nelson, who had a command on that station, he remained till the end of 1786. With Nelson he warmly co-operated in carrying into execution the provisions of the navigation laws, which had been infringed by the United States, whose ships, notwithstanding the separation of the countries, continued to trade to the West Indies, although that privilege was by law exclusively confined to British vessels. In 1786 Collingwood returned to England, where, with the exception of a voyage to the West Indies, he remained until 1793, in which year he was appointed captain of the "Prince," the flag-ship

of Rear-Admiral Bowyer. About two years previous to this event he had married Miss Sarah Roddam—a fortunate alliance, which continued to be a solace to him amidst the privations to which the life of a seaman must ever be subject.

As captain of the "Barfleur," Collingwood was present at the celebrated naval engagement which was fought on the 1st of June, 1794; and on that occasion he displayed equal judgment and courage. On board the "Excellent" he shared in the victory of the 14th of February, 1797, when Sir John Jarvis humbled the Spanish fleet off Cape St. Vincent. His conduct in this engagement was the theme of universal admiration throughout the fleet, and greatly advanced his fame as a naval officer. After blockading Cadiz for some time, he returned for a few weeks to Portsmouth to repair. In the beginning of 1799 Collingwood was raised to the rank of vice-admiral, and hoisting his flag in the "Triumph," he joined the Channel Fleet, with which he proceeded to the Mediterranean, where the principal naval forces of France and Spain were assembled. Collingwood continued actively employed in watching the enemy, until the peace of Amiens restored him once more to the bosom of his family.

The domestic repose, however, which he so highly relished, was cut short by the recommencement of hostilities with France, and in the spring of 1803 he quitted the home to which he was never again to return. The duty upon which he was employed was that of watching the French fleet off Brest, and in the discharge of it he displayed the most unwearied vigilance. Nearly two years were spent in this employment; but Napoleon had at length matured his plans and equipped his armament, and the grand struggle which was to decide the fate of Europe and the dominion of the sea was close at hand. The enemy's fleet having sailed from Toulon, Admiral Collingwood was appointed to the command of a squadron, with orders to pursue them. The combined fleets of France and Spain, after spreading terror throughout the West Indies, returned to Cadiz. On their way thither they bore down upon Admiral Collingwood, who had only three vessels with him; but he succeeded in eluding the pursuit, although chased by sixteen ships of the line. Ere one-half of the enemy had entered the harbor he drew up before it and resumed the blockade, at the same time employing an ingenious artifice to conceal the inferiority of his force. But the combined fleet was at last compelled to quit Cadiz; and the battle of Trafalgar immediately followed. The brilliant conduct of Admiral Collingwood upon this occasion has been much and justly applauded. The French admiral drew up his fleet in the form of a crescent, and in a double line, every alternate ship being about a cable's length to windward of her second, both ahead and astern. The British fleet bore down upon this formidable and skillfully arranged armament in two separate lines, the one led by Nelson in the "Victory," and the other by Collingwood in the "Royal Sovereign." The latter vessel was the swifter sailer, and having shot considerably ahead of the rest of the fleet, was the first engaged. "See," said Nelson, pointing to the "Royal Sovereign" as she penetrated the centre of the enemy's line, "see how that noble fellow Collingwood carries his ship into action!" Probably it was at the same instant that Collingwood, as if in response to the observation of his great commander, remarked to his captain, "What would Nelson give to be here?" The consummate valor and skill evinced by Collingwood had a powerful moral influence upon both fleets. It was with the Spanish admiral's ship that the "Royal Sovereign" closed; and with such rapidity and precision did she pour in her broadsides upon the "Santa Anna" that the latter was on the eve of striking in the midst of thirty-three sail of the line, and almost before another British ship had fired a gun. Several other vessels, however, seeing the imminent peril of the Spanish flag-ship, came to her assistance, and hemmed in the "Royal Sovereign" on all sides; but the latter, after suffering severely, was relieved by the arrival of the rest of the British squadron; and not long afterwards the "Santa Anna" struck her colors. The result of the battle of Trafalgar, and the expense at which it was purchased, are well known. On the death of Nelson, Collingwood assumed the supreme command; and by his skill and judgment greatly contributed to the preservation of the British ships, as well as of those which were captured from the enemy. He was raised to the peerage, as Baron Colling-

wood of Coldburne and Heathpool, and received the thanks of both Houses of Parliament, with a pension of £2000 per annum.

From this period until the death of Lord Collingwood no great naval action was fought; but he was much occupied in important political transactions, in which he displayed remarkable tact and judgment. Being appointed to the command of the Mediterranean fleet, he continued to cruise about, keeping a watchful eye upon the movements of the enemy. His health, however, which had begun to decline previously to the action of Trafalgar in 1805, seemed entirely to give way, and he repeatedly requested Government to be relieved of his command, that he might return home; but he was urgently requested to remain, on the ground that his country could not dispense with his services. This conduct has been regarded as harsh; but the good sense and political sagacity which he displayed afford some palliation of the conduct of the Government; and the high estimation in which he was held is proved by the circumstance that among the many able admirals, equal in rank and duration of service, none stood so prominently forward as to command the confidence of ministers and of the country to the same extent as he did. After many fruitless attempts to induce the enemy to put to sea, as well as to fall in with them when they had done so (which circumstance materially contributed to hasten his death), he expired on board the "Ville de Paris," then lying off Port Mahon, on the 7th of March, 1810.

Lord Collingwood's merits as a naval officer were in every respect of the first order. In original genius and romantic daring he was inferior to Nelson, who indeed had no equal in an age fertile in great commanders. In seamanship, in general talent, and in reasoning upon the probability of events from a number of conflicting and ambiguous statements, Collingwood was equal to the hero of the Nile; indeed, many who were familiar with both give him the palm of superiority. His political penetration was remarkable; and so high was the opinion generally entertained of his judgment, that he was consulted in all quarters, and on all occasions, upon questions of general policy, of regulation, and even of trade. He was distinguished for benevolence and generosity; his acts of charity were frequent and bountiful, and the petition of real distress was never rejected by him. He was an enemy to impressment and to flogging; and so kind was he to his crew, that he obtained amongst them the honorable name of father. Between Nelson and Collingwood a close intimacy subsisted, from their first acquaintance in early life till the fall of the former at Trafalgar; and they lie side by side in the cathedral of St. Paul's. The selections from the public and private correspondence of Lord Collingwood, published in 2 vols., 8vo, in 1828, contain some of the best specimens of letter-writing in our language. See also *A Fine Old English Gentleman exemplified in the Life and Character of Lord Collingwood, a Biographical Study*, by William Davies, London, 1875.

COLLINS, ANTHONY (1676-1729), an English writer on theology and philosophy, born at Heston, near Hounslow in Middlesex, on the 21st June, 1676, was the son of a country gentleman of good fortune. After being educated at Eton, and at King's College, Cambridge, he was entered at the Middle Temple, but he did not pursue the profession of the law. The most interesting episode of his life was his intimacy with Locke, who in his letters speaks of him with the most affectionate regard. During a visit to Holland, made, it is said, in order to escape the storm raised by the *Discourse of Freethinking*, he also made the acquaintance of Leclerc and several other Dutch scholars. In 1715 he settled in Essex; and he was in that county appointed to the offices of justice of the peace and deputy-lieutenant, which he had before held in Middlesex. His open expression of his opinions, with all its freedom, was, as he owns, carefully kept "within the bounds of doing himself no harm;" he always published anonymously, though the authorship of his books never appears to have been long a secret; and the independence of his position, together with his pure and genial character, saved him from all personal annoyance. The only attack reported to have been made upon him, otherwise than by means of the press, was the fruitless petition presented by Whiston, while smarting under his criticism, praying that he might be removed from the commission of the peace. Collins

died at his house in Harley Street, London, on December 13, 1729, at the age of fifty-three.

The first work of note published by Collins was his *Essay concerning the Use of Reason in Propositions the Evidence whereof depends on Human Testimony* (1707). He demands that the revelation of God should be conformable to man's natural ideas of God, but draws a distinction between what is contrary to reason and what is merely contrary to our experience.

Six years later appeared his most famous work, *A Discourse of Freethinking, occasioned by the Rise and Growth of a Sect called Freethinkers* (1713). Notwithstanding the ambiguity of its title, and though it attacks the priests of all churches without moderation, it contends for the most part, at least explicitly, for no more than must be admitted by every Protestant, or than is maintained in such works as Taylor's *Liberty of Prophesying*; and it points out forcibly that the first introduction of Christianity, and the success of all missionary enterprise, involve freethinking (in its etymological sense) on the part of those converted. In England this essay, which was regarded and treated as a plea for deism, made a great sensation, calling forth several replies, among others from Whiston, Bishop Hare, Bishop Hoadly, and Richard Bentley, who, under the signature of *Phileleutherus Lipsiensis*, roughly handles certain arguments carelessly expressed by Collins, but triumphs chiefly by an attack on his scholarship. Swift also, being satirically referred to in the book, made it the subject of a caricature. In France, where it was answered by Crousaz, it produced a still deeper impression.

In 1724 Collins published his extraordinary *Discourse on the Grounds and Reasons of the Christian Religion*, with *An Apology for Free Debate and Liberty of Writing* prefixed. Ostensibly it is written in opposition to Whiston's attempt to show that the passages of the Old Testament prophecies quoted in the New had since the time of Christ been corrupted by the Jews, and with the object of proving that the fulfilment of prophecy by the events of Christ's life is all "secondary, secret, allegorical, and mystical," since the original and literal reference is always to some other fact. To explain this "allegorical" reading, he quotes from the Dutch Hebraist Surenhusius ten methods according to which the authors of the *Gemara* and other allegorical writers among the Jews interpret difficult parts of the Scriptures, and which are asserted to have been used in the New Testament. Of these methods the gentlest is altering the points, and the most severe is "changing the order of words, adding words, and retrenching words, which is a method often used by Paul;" and the true purpose of the book would appear to have been to show, in a veiled satire, that the fulfilment of prophecy in the New Testament is of the same kind as that contrived by the rabbis. And further, as he strives to prove that the fulfilment of prophecy is the only valid proof of Christianity, he thus secretly aims a blow at Christianity as a revelation. The canonicity of the New Testament he ventures openly to deny, on the ground that the canon could only be fixed by men who were inspired. No less than thirty-five answers were directed against this book, the most noteworthy of which were those of Bishop Edward Chandler, Arthur Sykes, Clarke, and Sherlock. To these, but with special reference to the work of Chandler, which maintained that a number of prophecies were literally fulfilled in Christ, Collins replied by his *Scheme of Literal Prophecy Considered*, 1727. An appendix contends against Whiston that the book of Daniel was forged in the time of Antiochus Epiphanes.

In philosophy, Collins takes a foremost place as a defender of Necessitarianism. His brief *Inquiry Concerning Human Liberty* (1715) gives, in a remarkably clear and concise form, all the important arguments in favor of his theory, with able and suggestive replies to the chief objections that have been urged against it. Little, in fact, of moment has been added by modern determinists. One of his arguments, however, calls for special criticism,—his assertion that it is self-evident that nothing that has a beginning can be without a cause is an unwarranted assumption of the very point at issue. Collins's position was attacked in an elaborate treatise by Samuel Clarke, in whose system the freedom of the will is made essential to religion and morality. During Clarke's lifetime, fearing perhaps

(as has been suggested) to be branded as an enemy of religion and morality, Collins gave no reply, but in 1729 he published an answer, entitled *Liberty and Necessity*.

The other of Collins's two purely philosophical treatises is *A Letter to Mr. Dodwell*. A controversy was then being carried on between Clarke, who asserted the natural immortality of the soul, and Dodwell, who held that the soul is mortal till baptism confers immortality upon it; and Collins entered the lists to suggest other possibilities. Adopting Locke's suggestion, he maintained that it is conceivable that the soul may be material; and, secondly, that if the soul be immaterial it does not follow, as Clarke had contended, that it is immortal; indeed in no way, he argues, can philosophy prove its immortality.

Two of Collins's early works yet remain to be mentioned—his *Vindication of the Divine Attributes*, in which he attacks a sermon of King, archbishop of Dublin, and maintains that from our knowledge of human qualities we can attain to a true, if limited, knowledge of the divine attributes; and his *Priestcraft in Perfection, or a Detection of the Fraud of inserting and continuing the Clause, "The Church hath power to decree Rites and Ceremonies and Authority in Controversies of Faith," in the Twentieth Article of the Church of England (1709)*, to which—as the question excited a very active controversy—he added, early in the next year, a second pamphlet on the same subject.

(T. M. W.)

COLLINS, MORTIMER (1827–1876), novelist and writer of lyrics, was born at Plymouth, and was educated at a private school. After some years spent in tuition and some contributions in verse to the Bristol newspapers, he repaired to London, and devoted himself to journalism in the Conservative interest. In 1855 he published a volume of verse; and in 1865 appeared his first story, *Who is the Hair?* A second volume of lyrics, *The Inn of Strange Meetings*, was issued in 1871; and in 1872 he produced his longest and best sustained poem, *The British Birds, a communication from the Ghost of Aristophanes*. He wrote profusely for journals and magazines—the *Owl*, the *Globe*, *Punch*, *Temple Bar*, *Belgravia*, the *World*, &c.—and produced, besides, several novels, the most readable of which, perhaps, is *Sweet Anne Page* (1868). As novels merely, these works are not greatly to be commended; as the work of a clever man of pronounced opinions, they are often interesting enough. Their author's great claim to remembrance, however, is based upon his lyrics; some of these, in their light grace, their sparkling wit, their airy philosophy, are equal to anything of their kind in modern English.

COLLINS, WILLIAM (1721–1759), who divides with Gray the glory of being the greatest English lyricist of the 18th century, was born on the 25th of December, 1721, at Chichester, of which city his father, a rich hatter, was the mayor. After some childish studies in his native town, he was sent, in January, 1733, to Winchester College, where Whitehead and Joseph Warton were his schoolfellows. When he had been nine months at the school, Pope paid Winchester a visit and proposed a subject for a prize poem; it is legitimate matter of fancy to suppose that the lofty forehead, the brisk dark eyes, and gracious oval of the childish face, as we know it in the only portrait existing of Collins, did not escape the great man's notice, then not a little occupied with the composition of the *Essay on Criticism*. In 1734 it is supposed that the young poet published his first verses, on *The Royal Nuptials*, of which, however, no copy has come down to us; another poem, probably satiric, called *The Battle of the Schoolbooks*, was written about this time, and has also been lost. Fired by his poetic fellows to further feats in verse, Collins produced, in his seventeenth year, those *Persian Eclogues* which were the only writings of his that were valued by the world during his own lifetime. They were not printed for some years, and meanwhile Collins sent, in January and October, 1739, some verses to the *Gentleman's Magazine*, which attracted the notice and admiration of Johnson, then still young and uninfluential. In March, 1740, he was admitted a commoner of Queen's College, Oxford, but did not go up to Oxford until July, 1741, when he entered Magdalen College. At Oxford he continued his affectionate intimacy with the Wartons, and gained the friendship of Gilbert White. Early in 1742 the *Persian Eclogues* appeared in London. They were four in number, and formed a modest pamphlet of not more than 300 lines in all. These pieces may be compared with Victor Hugo's *Les Orientales*, to

which, of course, they are greatly inferior. Considered with regard to the time at which they were produced, they are more than meritorious, even brilliant, and one at least—the second—can be read with enjoyment at the present day. The rest, perhaps, will be found somewhat artificial and effete. In November, 1743, Collins was made bachelor of arts, and a few days after taking his degree published his second work, an *Epistle to Sir Thomas Hanmer*. This poem, written in heroic couplets, shows a great advance in individuality, and resembles, in its habit of impersonifying qualities of the mind, the riper lyrics of its author. For the rest, it is an enthusiastic review of poetry, culminating in a laudation of Shakespeare. It is supposed that he left Oxford abruptly in the summer of 1744 to attend his mother's death-bed, and did not return. His indolence, which had been no less marked at the university than his genius, combined with a fatal irresolution to make it extremely difficult to choose for him a path in life. The army and the church were successively suggested and rejected; and he finally arrived in London, bent on enjoying a small property as an independent man about town. He made the acquaintance of Johnson and others, and was urged by those friends to undertake various important writings—a *History of the Revival of Learning*, several tragedies, and a version of Aristotle's *Poetics*, among others—all of which he commenced and lacked force of will to continue. He soon squandered his means, plunged, with most disastrous effects, into profligate excesses, and sowed the seed of his untimely misfortune. It was at this time, however, that he composed his matchless odes, which appeared on the 20th of December, 1746, dated 1747. The original project was to have combined them with the odes of Joseph Warton, but the latter, now forgotten, proved at that time to be the more marketable article. Collins's little volume fell dead from the press, but it won him the admiration and friendship of Thomson, with whom, until the death of the latter in 1748, he lived on terms of affectionate intimacy. The *Odes*, in the volume of that name, were twelve in number; to their contents we shall presently return. In 1749 Collins was raised beyond the fear of poverty by the death of his uncle; and he left London to settle in his native city. He had hardly begun to taste the sweets of a life devoted to literature and quiet before the weakness of his will began to develop in the direction of insanity, and he hurried abroad to attempt to dispel the gathering gloom by travel. In the interval he had published two short pieces of consummate grace and beauty—the *Elegy on Thomson*, in 1749, and the *Dirge in Cymbeline*, later in the same year. In the beginning of 1750 he composed the *Ode on the Popular Superstitions of the Highlands*, which was dedicated to the author of *Douglas*, and not printed till long after the death of Collins, and an *Ode on the Music of the Grecian Theatre*, which no longer exists, and in which our literature probably has sustained a severe loss. With this poem his literary career closes, although he lingered in great misery for nearly nine years. From Gilbert White we learn that his madness was occasionally violent, and that he was confined for a time in an asylum at Oxford. But for the most part he resided at Chichester, suffering from extreme debility of body when the mind was clear, and incapable of any regular occupation. Music affected him in a singular manner, and it is recorded that he was wont to slip into the cathedral cloisters during the services, and moan and howl in horrible accordance with the choir. In this miserable condition he passed out of sight of all his friends, and in 1756 it was supposed, even by Johnson, that he was dead; in point of fact, however, his sufferings did not cease until the 12th of June, 1759. No journal or magazine recorded the death of the forgotten poet, though Goldsmith, only two months before, had commenced the laudation which was soon to become universal.

No English poet so great as Collins has left behind him so small a bulk of writings. Not more than 1500 lines of his have been handed down to us, but among these not one is slovenly, and few are poor. His odes are the most sculpturesque and faultless in the language. They lack fire, but in charm and precision of diction, exquisite propriety of form, and lofty poetic suggestion they stand unrivalled. That one named *The Passions* is the most popular; that *To Evening* is the greatest favorite with imaginative persons. In reading this, and the *Ode to Simplicity*, one seems to be handling an antique vase of matchless delicacy

and elegance. Distinction may be said to be the crowning grace of the style of Collins; its leading peculiarity is the incessant impersonification of some quality of the character. In the *Ode on Popular Superstitions* he produced a still nobler work; this poem, the most considerable in size which has been preserved, contains passages which are beyond question unrivalled for rich melancholy fulness in our literature between Milton and Keats. The life of Collins was written by Dr. Johnson; he found an enthusiastic admirer in Dr. Langhorne, and more recently a kindly biographer in Mr. Moy Thomas. (x. w. c.)

COLLINS, WILLIAM (1787-1847), painter, was the son of an Irish picture dealer and man of letters, the author of a *Life of George Morland*, and was born in London. He studied under Etty in 1807, and in 1809 exhibited his first pictures of repute—*Boys at Breakfast*, and *Boys with a Bird's Nest*. In 1815 he was made associate of the Royal Academy, and was elected R.A. in 1820. For the next sixteen years he was a constant exhibitor; his fishermen, shrimp-catchers, boats and nets, stretches of coast and sand, and, above all, his rustic children were universally popular. Then, however, he went abroad on the advice of Wilkie, and for two years (1837-1838) studied the life, manners, and scenery of Italy. In 1839 he exhibited the first fruits of this journey; and in 1840, in which year he was appointed librarian to the Academy, he made his first appearance as a painter of history. In 1842 he returned to his early manner and choice of subject, and during the last years of life enjoyed greater popularity than ever. As a painter Collins is entitled to high praise. He was a good colorist and an excellent draughtsman; he was also conscientious exceedingly, and an ardent lover and student of nature. His earlier pictures are deficient in breadth and force,—are feeble, in fact, from excess of care and finish; but his later work, though also carefully executed, is rich in effects of tone and in broadly painted masses. His biography, *Life of William Collins, R. A.*, 2 vols., by his son Wilkie Collins, the well-known novelist, appeared in 1848.

COLLODION (from *κόλλα*, glue), a colorless, viscid fluid, made by dissolving gun-cotton and the other varieties of pyroxylin, or cellulotritrin,  $C_6H_7O_2(NO_2)_3$ , in a mixture of alcohol and ether. It was discovered in 1848 by Maynard in Boston. The quality of collodion differs according to the proportions of alcohol and ether and the nature of the pyroxylin it contains. Collodion in which there is a great excess of ether gives by its evaporation a very tough film; the film left by collodion containing a large quantity of alcohol is soft and easily torn, but in hot climates the presence of an excess of alcohol is an advantage, as it prevents the rapid evaporation of the ether. Pyroxylin for the making of collodion for photographic purposes is prepared by immersing cotton-wool ten minutes in a mixture of nitric and sulphuric acids at a temperature of 140° Fahr. When tolerably strong acids at a low temperature are employed, the nitric acid being in by far the larger quantity, the pyroxylin made requires an amount of alcohol equal to only about  $\frac{1}{4}$ th or  $\frac{1}{2}$ th that of the ether in bulk. According to M. Miallie, the most explosive kinds of gun-cotton are not the best adapted for the preparation of collodion; a pyroxylin very soluble in ether is in his process made from 2 parts by weight of carded cotton to 40 parts of nitre and 60 of concentrated sulphuric acid. Under the microscope, the film produced by collodion of good quality appears translucent and colorless, the cotton being perfectly dissolved; old collodion that does not give good photographic impressions sufficiently quickly exhibits liquid globules of modified ether. The film from collodion which is too alcoholic has the microscopic appearance of cellular tissue; and when water has been present the fibrillæ of the cotton become apparent as amorphous flocks. To preserve collodion it should be kept cool, and out of the action of the light; iodized collodion that has been discolored by the development of free iodine may be purified by the immersion in it of a strip of silver foil. For the iodizing of collodion, ammonium bromide and iodine and the iodides of calcium and cadmium are the agents employed. The first to suggest the use of collodion in photography was M. le Grey, in Paris; Mr. F. S. Archer, in February, 1851, recommended iodized collodion instead of paper for the taking of photographs (*The Chemist*, New Ser., vol. ii., No. xix., p. 257, March, 1851). In surgery collodion is used in its usual condition,

or combined with elastic and other substances, for the protection of inflamed surfaces, as in erysipelas and smallpox. When poured upon the skin, it forms a thin film which contracts as it dries. *Flexible collodion*, which, as it does not crack in drying, is preferable for surgical purposes to the ordinary preparation, is made from collodion 6 oz., Canada balsam 120 gra., castor oil one fluid drachm. *Vesicating or Blistering Collodion* contains cantharidin as one of its constituents. The styptic colloid of Richardson is a strong solution of tannin in gun-cotton collodion. Small balloons are manufactured from collodion by coating the interior of glass globes with the liquid; the film when dry is removed from the glass by applying suction to the mouth of the vessel. M. E. Gripon has found (*Compt. Rend.*, April 5, 1875) that collodion membranes, like glass, reflect light and polarize it both by transmission and reflection; they also transmit a very much larger proportion of radiant heat, for the study of which they are preferable to mica. See PHOTOGRAPHY.

COLLOT D'HERBOIS, JEAN MARIE (1750-1796), a prominent actor in the French Revolution, was a Parisian actor. After figuring for some years at the principal provincial theatres of France and Holland, he became director of the playhouse at Geneva. He had from the first a share in the revolutionary tumult, but it was not until 1791 that he became a figure of importance. Then, however, by the publication of *L'Almanach du Père Gérard*, a tract designed to set forth, in homely style, the advantages of a constitutional government, he suddenly acquired great popularity. His renown was soon increased by his active interference on behalf of the Swiss of the Château-Vieux Regiment, condemned to the galleys for mutiny at Nancy. His efforts resulted in their liberation. He went himself to Brest in search of them, and a civic feast was decreed on his behalf and theirs, which gave occasion for one of the few poems published during his life by André Chénier. He next endeavored to obtain the office of minister of justice, but was disappointed. The Tenth of August, however, placed him in the municipality of Paris. There he attached himself to Billaud-Varenne, and had with him a large share in bringing about the September Massacres. Having been elected a deputy for Paris to the Convention, he was among the first to demand the abolition of royalty; and from Nice, whither he had gone on an embassy, he voted the death of Louis XVI.—"*sans sursis*." In the struggle between the Mountain and the Girondists he displayed great energy; and after the *coup d'état* of May 31 (1793) he made himself conspicuous by his pitiless pursuit of the defeated party. In June he was made president of the Convention, and in September, with Billaud-Varenne, he was admitted to the Committee of Public Safety. He voted loudly and persistently for all the bloodiest and sternest measures. In November, after the Lyonese insurrection, he was sent with Fouché to punish the rebellious city, where, it is said, he had once been hissed as an actor. This he effected by putting about 1500 persons to death in one day. In May, 1794, an attempt was made to assassinate Collot, but it only increased his popularity. In the struggle for mastery between Robespierre and Tallien, Collot took the part of the latter. In spite, however, of his fierce attack on Robespierre he was expelled from the Committee of Public Safety, and was denounced in form by Lecointre. He defended himself, and was acquitted, but only to be denounced anew by Merlin, and to be condemned, with Billaud-Varenne, to transportation to Cayenne, where he died of fever a few months after his arrival.

Collot d'Herbois wrote and adapted from the English and Spanish many plays, one of which, *Le Paysan Magistral*, kept the stage for several years. *L'Almanach du Père Gérard* was reprinted (1792) under the title of *Étrennes aux Amis de la Constitution Française, ou Entretiens du Père Gérard avec ses Concitoyens*, Paris, 12mo.

COLMAN, GEORGE (1733-1794), essayist and dramatist, usually called the Elder, and sometimes George the First, to distinguish him from his son, was born at Florence, where his father was stationed as resident at the court of the grand duke of Tuscany. After a preliminary course of study at a private academy in Marylebone, he was sent to Westminster School, which he left in due course for Christ Church, Oxford. Here he made the acquaintance of Bonnell Thornton, the parodist, and to

gather they founded *The Connoisseur* (1754–1756), a periodical which reached its 140th number, and which, Johnson said, "wanted weight." In 1758 he took the degree of Master of Arts, came to London soon afterwards, was entered at Lincoln's Inn, and was duly called to the bar; and in 1760 he produced his first play, *Polly Honeycomb*, which met with great success. In 1761 he brought out *The Jealous Wife*, a comedy rich in borrowed excellences; in 1764 the death of Lord Bath placed him in possession of an annuity; in 1765 appeared his brilliant metrical translation of the plays of Terence; and in 1766 he produced *The Clandestine Marriage*, jointly with Garrick, whose Lord Ogleby was one of his finest impersonations. In 1767 he succeeded to a second annuity, on the death of General Pulteney, purchased a fourth share in Covent Garden Theatre, and was appointed acting manager. In 1768 he was elected into the famous Literary Club, then nominally consisting of twelve members; in 1774, after seven years of managership, he sold his share in the great playhouse to Leake; and in 1777 he purchased of Foote, then broken in health and spirits, and near his end, the Little Theatre in the Haymarket. In 1778 he published an edition of Beaumont and Fletcher; and in 1783 appeared his translation of Horace's *Epistle De Arte Poetica*, with notes and a commentary. He was attacked with palsy in 1785; in 1789 his brain became affected, and he lapsed gradually into idiocy. Besides the works already cited, Colman was author of some 35 plays, of an excellent translation from the *Mercator* of Plautus for Bonnell Thornton's edition (1769–1772), and of many parodies and occasional pieces. An incomplete edition of his dramatic works was published in 1777, in four volumes. See also *Prose on Several Occasions, with some Pieces in Verse*, by George Colman, London, 1787, 3 vols.; and *Some Particulars of the Life of the Late George Colman, Written by Himself*, London, 1795.

COLMAN, GEORGE (1762–1836), the Younger, son of the preceding, passed from Westminster School to Christ Church, Oxford, and King's College, Aberdeen, and was finally entered as a student of law at the Temple, London. While at Aberdeen he published a poem in honor of Charles James Fox, called *The Man of the People*; and in 1782 he produced, at his father's playhouse in the Haymarket, his first play, *The Female Dramatists*, for which *Rederick Random* supplied the materials. It was unanimously condemned, but his next attempt, *Two to One*, was entirely successful, and the young Templar's vocation was decided on. The failing health of the elder Colman obliging him to relinquish the management of the Haymarket theatre, the younger George succeeded him, at a yearly salary of £600. On the death of the father the patent was continued to the son; but difficulties arose in his way, lawsuits and pamphlets accumulated round him, and he was forced to take sanctuary within the Rules of the King's Bench. Here he resided for many years. Released at last through the kindness of George IV., who had appointed him exon of the Yeomen of the Guard, a dignity disposed of by Colman to the highest bidder, he was made examiner of plays by the duke of Montrose, then lord chamberlain. This office, to the disgust of all contemporary dramatists, to whose MSS. he was as illiberal as severe, he held till his death. Colman's comedies, which have never been collected, are a curious mixture of genuine comic force and platitudinous sentimentality. Several of them are yet acted; but their popularity is rather to be attributed to the humor of the actors who adopt them as vehicles for display than to any intrinsic vitality. The best of them are *John Bull* (1806), for which the author received the largest sum of money that had till then been paid for any single play, *The Poor Gentleman*, and *The Heir-at-Law*. Colman, whose conversational powers were remarkable, as Byron has recorded, was also the author of a great deal of so-called humorous poetry (mostly coarse, though much of it was popular)—*My Night Gown and Slippers* (1797), *Broad Grins* (1802), and *Poetical Vagaries* (1812). Some of his writings were published under the assumed name of Arthur Griffinhood of Turnham Green. See *Random Records*, London, 1830, 2 vols.; and R. B. Peake, *Memoirs of the Colman Family*, London, 1842, 2 vols.

COLMAR, or KOLMAR, till 1870 the chief town of the department of Haut Rhin in France, but now of the district of Upper Alsace, in the German empire, is situated on the Lauch and the Fecht, tributaries of the Ill. It

communicates by a canal with the Rhine, and has a station on the railway from Basel to Strasburg, being about 40 miles S.S.W. of the latter city. It is the seat of the administrative offices for Upper Alsace, an imperial court of appeal for Alsace-Lorraine, a commercial court, an imperial lyceum, a Protestant normal college, a literary, an agricultural, and a natural history society. The last, founded in 1861, maintains a valuable museum in the old convent of Unterlinden, and publishes valuable contributions to local science. There is another museum, named after the old painter, Schongau, for the preservation of works of art; the town library contains 50,000 volumes, and the archives of Upper Alsace reach back to the 7th century. The most remarkable edifices in the town are the so-called cathedral, or St. Martin's church, a Gothic structure built in 1363, the prefecture or administrative buildings, and the town-house; and there are also civil and military hospitals, barracks, a theatre, and a deaf-mute institution. The manufactures of the town comprise cotton goods of various sorts, packing-cloth, hosiery, starch, silk thread, iron and copper wares, engines, sewing-machines, bricks, matches, and leather; and there are eight breweries, a dye-work, and several printing and lithographic establishments. The domestic trade of the country is centred in the city, and large transactions are effected in wine and hops. Colmar grew up round a royal residence called Columbaria, which is first mentioned in the 8th century. It obtained a charter of incorporation in 1226, and was afterwards made a free imperial city by the Emperor Frederick II. It was taken after a six weeks' siege by Adolphus of Nassau in 1293, invested by Duke Otto of Austria in 1330, occupied by Duke Rudolf in 1358, seized by the Swedes in 1632, and finally dismantled by the French after the siege of 1673.

COLNE, a market town of England, in the county of Lancaster, 26 miles north of Manchester, on a small affluent of the Calder, near the Liverpool and Leeds Canal, with a station on a branch of the Midland line. It is a place of great antiquity, and many Roman coins have been found on the site. As early as the 14th century it was the seat of a woollen manufacture; but its principal manufactures now are printed calicoes and mousselines-de-laine. The chief buildings are the parish church of St. Bartholomew, an ancient edifice which has been frequently restored, and the cloth or piece-hall, in the Elizabethan style. The grammar school is interesting as the place where Archbishop Tillotson received his early education. In the neighborhood are several limestone and slate quarries. Population in 1851, 6644; in 1871, 7335.

COLOCYNTHE, COLOQUINTIDA, or BITTER APPLE, *Cucurbitus* or *Cucumis Colocynthis*, a plant of the natural order *Cucurbitaceae* or Gourds. The flowers are unisexual; the male blossoms have five stamens and sinuous anthers, the female have reniform stigmas, and a 3 to 6 celled ovary. The fruit is round, and about the size of an orange; it has a thick yellowish rind, and a light, spongy, and very bitter pulp, which furnishes the colocynth of druggists. The seeds, which number from 200 to 300, and are disposed in vertical rows on the three parietal placentæ of the fruit, are flat and ovoid, and dark-brown; they are used as food by some of the tribes of the Sahara, and a coarse oil may be expressed from them. The foliage resembles that of the cucumber, and the root is perennial. The plant has a wide range, being found in Ceylon, India, Persia, Arabia, Syria, North Africa, the Grecian Archipelago, the Cape Verd Islands, and the south-east of Spain. The term *pakkuoth*, translated "wild gourds" in 2 Kings iv. 39, is thought to refer to the fruit of the colocynth; but, according to Celsius, it signifies a plant known as the squirting cucumber, *Ecballium purgans*. The commercial colocynth consists of the peeled and dried fruits, which are imported from Aleppo, Smyrna, Mogador, Spain, and other localities. In the preparation of the drug, the seeds are always removed from the pulp. Its active principle is an intensely bitter glucoside, *colocynthin*,  $C_{26}H_{54}O_{22}$ , soluble in water, ether, and alcohol, and decomposable by acids into glucose and a resin, *colocynthein*,  $C_{26}H_{54}O_{22}$ . Colocynth is a drastic purgative, and in large doses the powdered drug or its decoction has an inflammatory action on the intestines, and may produce fatal effects. It is administered in combination with aloes, scammony, cardamoms, and potassium sulphate, also with henbane. Colocynth was known to the ancient Greek, Roman, and Arabic physicians; and in a

herbal of the 11th century, written in Saxon (Cockayne, *Leechdoms, &c.*, vol. i. p. 325, Lond., 1864), the following directions are given as to its use:—"For stirring of the inwards, take the inward neshness of the fruit, without the kernels, by weight of two pennies; give it, pounded in lithe beer, to be drunk; it stirreth the inwards."

COLOGNA, a town of Italy, in the province of Verona, 20 miles south-east of the city of that name on the Frasanà Canal. It has a cathedral, and carries on an extensive trade in hemp, silk, wine, grain, and almonds. Population, 7000.

COLOGNE, German KÖLN or CÖLN, the chief city of Rhenish Prussia, and a fortress of the first rank. capital of a government of the same name, is situated in the form of a half circle on the left bank of the Rhine, 45 miles

chief object of interest in Cologne, is one of the finest and purest monuments of Gothic architecture in Europe. It stands on the site of a cathedral commenced about the beginning of the 9th century by Hildebold, metropolitan of Cologne, and finished under Willibert in 873. This structure was ruined by the Normans, was rebuilt, but in 1248 was almost wholly destroyed by fire. The foundation of the present cathedral was then laid by Conrad of Hochstaden. The original plan of the building has been attributed to Gerhard von Rile. In 1322 the new choir was consecrated, and the bones of the three kings were removed to it from the place they had occupied in the former cathedral. After Conrad's death the work of building advanced but slowly, and at the time of the Reformation it ceased entirely. In the early part of the 19th century the repairing of the

cathedral was taken in hand, and in 1842 the building of fresh portions necessary for the completion of the whole structure was commenced. The cathedral, which is in the form of a cross, has a length of 480, a breadth of 282 feet; the height of the central aisle is 154 feet; that of each of the towers, when completed, will be upwards of 500 feet. The heaviest of the six bells weighs 11 tons. In the choir the heart of Mary de' Medici is buried; and in the adjoining side-chapels are monuments of the founder and other archbishops of Cologne, and the shrine of the three kings, which is adorned with gold and precious stones. The very numerous and richly-colored windows, presented at various times to the cathedral, add greatly to the imposing effect of the interior. (See ARCHITECTURE, vol. ii. p. 377.) Many of the churches of Cologne are of interest both for their age and for the monuments and works of art they contain. In St. Peter's are the famous altar-piece by Rubens, representing the Crucifixion of St. Peter, several other works by Lucas of Leyden, and some old German glass-paintings. St. Martin's, built between the 10th and 12th centuries, has a fine baptistery, and paintings by Du Bois and Honthorst; St. Gereon's, built in the 11th century on the site of a Roman rotunda, is noted for its mosaics and glass and oil paintings; the Minorite church, commenced in the same year as the cathedral, contains the tomb of Duns Scotus. Besides these may be mentioned the Pantaleon church, a 12th century structure, with a monument to Theophania, wife of Otto II.; St. Cunibert, in the Byzantine-Moorish style, completed in 1248; St. Maria im Capitol, the oldest church in Cologne, dedicated in 1049 by Pope Leo IX., noted for its crypt, organ, and paintings; St. Cecilia, St. Ursula, and St. George. Other public buildings are the Gürzenich, the former meeting-place of the diets of the German empire, built between 1441 and 1474, the great hall of which is capable of accommodating 3000 persons; the Rathhaus, which dates from the 13th century; the Tempelhaus, built partly in the 12th century; the Museum Wallraf-Richartz, in which is a collection of paintings by old Italian and Dutch masters, together with some works by modern artists; the Zeughaus or arsenal, situated on Roman foundations; the Government buildings, erected by Bircher in 1830; the archbishop's palace, three gymnasia, several normal and commercial schools and literary and scientific institutions, and three theatres. The university, founded in 1388, was suppressed by the French during their occupation of the country. The walls which surround the city are about seven miles in circuit. Outside the walls, to the north side, are the Zoological and the Botanical Gardens. Cologne has a considerable trade in corn, wines, hides, and rape-seed with Holland, Belgium, and other countries; and steamers ply regularly between the city and the ports on the Rhine. The



Plan of Cologne.

- |                              |                                  |
|------------------------------|----------------------------------|
| 1. St. Cunibert's Church.    | 16. St. Martin's Church.         |
| 2. Civil Jail.               | 17. Synagogue.                   |
| 3. St. Ursula's Church.      | 18. Church of the Apostles.      |
| 4. St. Gereon's Church.      | 19. Bank.                        |
| 5. Archbishop's Palace.      | 20. Civil Hospital.              |
| 6. Government Palace.        | 21. Casino.                      |
| 7. Palace of Justice.        | 22. St. Maria's Church.          |
| 8. St. Andrea's Church.      | 23. Gürzenich (Merchant's Hall). |
| 9. Jesuits' Church.          | 24. St. Mauritius's Church.      |
| 10. Cathedral.               | 25. St. Peter's Church.          |
| 11. Diorama.                 | 26. Tempelhaus (Exchange).       |
| 12. Post Office.             | 27. Gymnasium.                   |
| 13. Church of the Minorites. | 28. St. Pantaleon Church.        |
| 14. Museum of Paintings.     | 29. Garrison Lazaretto.          |
| 15. Rathhaus (Town Hall).    | 30. St. Severin Church.          |

N.N.W. of Coblenz, in 50° 56' 29" N. lat., 6° 57' 52" E. long. It is connected with the suburb of Deutz, on the opposite side of the Rhine, by a bridge of boats nearly 1400 feet long, and by a handsome iron bridge which serves both for railway and street traffic. Although when viewed from a distance the city has a picturesque aspect, it is very irregularly built, and the older streets are narrow, crooked, and dirty. The most important squares are the Heumarkt, Neumarkt, Altmarkt, and Waidmarkt. There are two railway stations, the Central, near the cathedral, and the Pantaleon. There are also two stations in Deutz. The cathedral or Dom, the principal edifice and

principal manufactures are cotton yarn and stuff, hosiery, woollens, silks, tobacco, sugar, soap, wax-lights, starch, malt, dyes, white-lead, porcelain, carpets, brandy and spirits, eau-de-cologne, and leathern and metal wares. In 1815 the population of Cologne was 47,000; in 1871 it amounted to 129,233, or, if that of Deutz be included, about 141,000.

Cologne occupies the site of *Oppidum Ubiorum*, the chief town of the Ubii, and there in 51 A.D. a Roman colony was planted by the Emperor Claudius, at the request of his wife Agrippina, who was born in the place. After her it was named *Colonia Agrippina* or *Agrippinensis*. Cologne rose to be the chief town of *Germania Secunda*, and had the privilege of the *Jus Italicum*.

mm. Both Vitellius and Trajan were at Cologne when they became emperors. Statues, sarcophagi, and other Roman remains, and portions of the old Roman walls have been found at Cologne. About 330 the city was taken by the Franks, and in 475 it became the residence of the French king Childeric. In 570 it was annexed to the empire. The bishopric was founded in 314, the archbishopric about the end of the 8th century; in the 14th century the archbishops were made electors of the German empire. The last elector, Maximilian, died in 1801. Cologne was besieged by Emperor Henry V. in 1160, and by Philip of Swabia in 1201. From 1452 to 1474, having taken part with England, it was excluded from the Hanseatic League, of which it was one of the most important and wealthy cities. The intolerance of its magistrates in expelling Jews and Protestants, and the closing of the Rhine navigation in the 16th century by the Dutch, contributed to its decline. This last restriction having been removed in 1837, the trade of Cologne has greatly improved. In 1794 Cologne was taken by the French; it was ceded to them by the Treaty of Lunéville in 1801, and from that time till 1814, when it was restored to the Prussians, it was the capital of the department of the Roer.

COLOMBIA, or, according to the official title, the Republic of the United States of Colombia, is a modern confederation in South America, consisting of the nine states of Antioquia, Bolivar, Boyacá, Cauca, Cundinamarca, Magdalena, Panamá, Santander, and Tolima, and comprising a considerable portion of the territory of the old Spanish vice-royalty of New Granada. It is bounded on the N. by the Caribbean Sea, on the E. by Venezuela, on the S. by Ecuador and Brazil, and on the W. by the Pacific. It thus extends from 12° 20' N. to 2° 30' S. lat., and from 65° 50' to 83° 5' W. long.,—its total area being roundly estimated at 500,000 square miles, or more than double that of Spain and Portugal. About four-fifths lies to the north of the equator.

On the Atlantic it possesses a coast line of upwards of 1000 miles, richly furnished with bays and natural harbors. Proceeding westward from Calabozo Creek, in the Gulf of Maracaibo, the first inlet of real importance which we discover is the Bahia Honda, which is well protected from the strong winds of the east and north, but is rendered unsuitable for the establishment of a port by its lack of drinkable water. Passing by the Bay of El Porteta, we next reach the ports of Riohacha and Dibulla, of which the former is of considerable commercial importance as a centre of exportation, though it is greatly surpassed by that of Santa Marta, which is the next to break the coast-line. Santa Marta is situated at the side of the Ciénega Lagoon, which stretches 25 miles from south to north, with a breadth of 11 from east to west, has communication with the lakes of Pajaral and Cuatro Pocas, and, though rather shallow, can be navigated by flat-bottomed steamboats. At the mouth of the Magdalena lies the port of Barranquilla, and a short distance to the west that of Sabanilla, one of the most active along the whole coast. After these comes the splendid Bay of Cartagena, known for centuries to all navigators of the Caribbean; and still further to the west the coast is broken by the port of Zapote, the Bay of Zispata, the Gulf of Morrosquillo, and finally by the noble Gulf of Darien, with the estuary of the Atrato and the ports of Turbo, Guacuba, Candelaria, &c. Along the isthmus are the Mandinga Creek; the Bay of Portobello, so famous in the history of Spanish America; the modern port of Colon, or Aspinwall, at the entrance of Navy Bay; and the now decadent port of Chagres. The coast-line of the Pacific is hardly so important as that of the Atlantic, except along the isthmus, where it forms the great bay of Panama, with the subordinate inlets of Parita Bay on the west and the Gulf of San Miguel on the east. Along the remainder of the line are Cupica, San Francisco, Solano, Palmar, and Charambira (the last obstructed by a bar), the large Bay of Malaga, protected by the Isla de Palma, with the harbors of Guapi and Izenandé, the Bay of Pasa Caballos, the harbor of Tumaco, and in the Island of Gorgona the fine harbor of Trinidad.

The western part of Colombia is one of the most mountainous districts in the world; its eastern extension belongs to the great plains of the Orinoco and the Amazon. The mountains are all more or less directly portions of the system of the Andes. Entering at the south from the territory of Ecuador, they form an extensive plateau from which a large number of rivers take their rise. The portion known as the *paramo* of Cruz Verde was, according to Steinheil, an elevation of 10,975 old Paris

[This is higher than Aconcagua, which is believed to be the highest peak in America. (See Vol. II. p. 17.) The probable height is about 20,500 feet.—A.M. Ed.]

feet, or about 11,695 English feet. From this table-land the system breaks up into three ranges, which stretch north through nearly the whole length of the country, with a general parallelism of direction least maintained by the eastern portion. Of these ranges the loftiest at first is the Central, or the Cordillera of Quindiu, which contains the snowpeaks of Huila, Ruiz, and Tolima, the culminating peak of the Andes north of the equator; but in 5° 5' N. lat., where this range sinks down, the eastern rises to the snow limit, and is the most elevated of the three Cordilleras. The Eastern Cordillera, or the Cordillera de la Suma Paz, runs north-east to the *paramos* of Pamplona, from which it sends out a branch to meet the *massif* of the Sierra Nevada of Santa Marta. In its passage through the state of Santander it attains in the Alto de el Viejo an altitude of 12,965 feet, in Alto de el Trio of 9965, and in the Boca del Monte of 12,735. The Sierra Nevada is said to reach a height of 23,779 feet, and it is certainly covered with perpetual snow over a large part of its summit. The Western Cordillera, or Cordillera de Choco, is the least remarkable of the three, and has been worn down in many places into what are comparatively mere rounded hills with easy passages between; it continues northward, however, much further than the central chain, and in fact extends right through the Isthmus of Panamá.

The *llanos* or plains of the Orinoco extend eastward from the slopes of the Cordillera de la Suma Paz. As far south as the Vichada they form an almost complete level destitute of trees, and affording abundant pasturage; while further south they are covered with forests, display considerable irregularity of surface, and are not unfrequently broken by steep rocks rising to a height of from 300 to 600 feet.

The fundamental formations throughout Colombia are igneous and metamorphic, the great masses of the Cordilleras consisting of gneiss, granite, porphyry, and basalt. In many places the Carboniferous strata have attained considerable development, though they have been thrown into strange confusion by some unknown disturbance. Volcanic forces are still at work, as is shown by occasional earthquakes, and also by such phenomena as those at Batán near Sogamoso, where the subterranean heat is great enough to affect the local climate. Glaciers are still extant in the Paramo del Ruiz, and possibly in some of the other snow-capped heights. The slopes of the various Cordilleras are frequently covered with deep beds of gravel; and the valleys are full of alluvial deposits of very various periods. The rivers have in many instances cut remarkable passages for themselves through the mountains; and, according to Codazzi, the Sogamoso has at one time been the outlet of a vast series of lakes which he believed to have occupied the highlands of Bogotá, Tunja, and Vélez.

The rivers of Colombia belong almost entirely to the great Atlantic versant; but they are distributed by the principal watershed in very various directions. The two most important are the Magdalena or Rio Grande and the Cauca, which both flow from south to north through nearly the entire length of the country,—the former occupying the valley between the Eastern and the Central Cordilleras, and the latter that between the Central and the Western. They unite about 130 miles before reaching the sea, but they so long maintain an independent course that neither can fairly be regarded as a mere tributary of the other. The Magdalena takes its rise in a small lake called the Laguna del Buey or Ox Lake, situated in the plateau of Las Papas. It receives from the right hand the Suaza, the Rio Neiva, the Cabrera, the Prado, the Fuzaguasanga, famous for the falls of Tequendama, the Bogotá, the Carare, the Opon, the Sogamoso, itself a considerable stream, and the Rio Cesar, a fine river from the Sierra Nevada; and from the left the La Plata, the Paz, the Saldaña, the Cuello, the Guali, the Samana, or Miel the Nare or Rio Negro, and various minor tributaries. The Magdalena is one of the most important water highways of the country, in spite of the fact that its current is so rapid as to make the upward voyage both difficult and tedious. From Honda, where the progress is interrupted by rapids, a native boat takes only about three days to reach the sea, while no fewer than six weeks are spent, even when the water is low, in returning against the stream. Steamers of from 50 to 200 tons burden, however, have plied regularly since 1833 between Honda and Barranquilla. The Honda rapids can be surmounted by haulage, and steamers descend them in safety, though there is a fall of

20 feet in two miles, and of 16 feet in the first. Above this point the channel is clear about half-way to the source; and though the traffic is still mainly carried on by native boats and rafts, a German named Alexander Weckbecker succeeded, in 1875, in taking a large steambot—the "Moltke"—three times to the town of Neiva. The Cauca rises to the west of the source of the Magdalena, in the Lake of Santiago, in the paranao of Guanacas. In the upper part of its course it flows through a volcanic region, and its waters are so impregnated with sulphuric and other acids that they are destructive of fish. These acids are mainly contributed by the headstream of the Rio Vinagre or Vinagar River, which rises in the Purace volcano. The principal tributaries are the Piendamó, the Ovejas, the Palo, the Amaime, and the La Vieja, from the Central Cordillera; and the Jamundi and a large number of minor streams from the Western. After the junction of the Cauca and the Magdalena the united stream attains an imposing breadth; but it breaks up into several channels before it falls into the sea. The River Atrato, which disembogues in the Gulf of Darien and separates the main branch of the Eastern Cordillera from the isthmian ranges, is of high importance, not only in itself as an actual means of communication, but as affording, in the opinion of many engineers, one of the most feasible means of forming an interoceanic canal. So important was it regarded by Philip II. that its navigation was forbidden in 1730 on pain of death; and the prohibition was not removed for a considerable period. The account, however, so frequently repeated, of the possibility of passing from the Atlantic to the Pacific versant by means of a canal, excavated about 1788 in the Rapaadura ravine by some enterprising monk, seems to have little or no foundation. The Atrato rises in the slopes of the Western Cordillera, has a course of about 300 miles, and a breadth, during the last 96 miles, of from 750 to 1000 feet. Its depth in this lower part of its passage varies from 40 to 70 feet or even more. At Quibdó, 220 miles from the embouchure, it is still 850 feet wide and 8 to 20 feet deep; and as the fall of the river is only about 3 inches to a mile, steamboats can pass as far as the confluence of the San Pablo and Certigui, 32 miles above Quibdó.

Of those rivers that belong to the Orinoco system the most important are the Guaviare, the Meta, and the Vichada. The first is formed of the Guayavero and the Iriwida, which flows from the mountains of Tunahí; and the principal tributaries of the second are the Chire, the Casanare, and the Lipa. Of those that belong to the Amazon are several tributaries of the Rio Negro branch, and the Caquita, or Japura. The last rises in the eastern slopes of the same table-land which gives birth to the Magdalena and the Cauca; and its principal affluents are the Pescado, the Caguan, and the Apoponi. Though belonging to Colombia only by its head waters, there is another tributary of the Amazon which bids fair to be of great importance to the country as a means of communication with Brazil. This river, the Rio Iça or Potumayo, rises in the Andes in the province of Pasto, under 2° N. lat., has a total length from its source to its confluence of 932 miles, receives in its course 36 affluents, of which several would afford passage for steamboats, and waters a region that abounds in gum elastic, sarsaparilla, cocoa, nut-wood, Pasto resin, gold, and other means of wealth. Its depth is from 7 to 34 feet during low water, and twice as great during flood; at some places it has a breadth of 1300 feet, and its current is from 3 to 4 nautical miles an hour. A steamer only takes 10 days to pass from the confluence with the Amazon to the mouth of the Guamnés; and this place is only 80 or 90 miles from the province of Pasto. The opening up of this route is due to Raphael Reyes, a full account of whose exploration will be found in Petermann's *Mittheilungen* for 1876. The only rivers that remain to be noted are those of the isthmus; and these are chiefly of importance for their bearing on the question of interoceanic communication. The principal are the Chagres, disemboguing in the Atlantic, and the Tuyra, the Chepa or Bayanos, and the Chiriqui, which find their way to the Pacific.

**Lakes.** Many of the Colombian rivers take their rise in mountain lakes, and several of them fill considerable basins in their course; but throughout the country there are very few of those extensive sheets of water that form so usual a feature in most mountainous regions. The River Cesar flows through the lakes of Zipa-

tosa and Adentro; between the Cauca and the Nechi lies Lake Caceres, as well as several others of less importance; the district of Tunja still preserves the Lake of Tota; and in Bogotá is the famous Guatavita, where the Muiscas are reputed to have sunk their treasures.

Colombia is distinctively a mineral country, Minerals and the list of its productions in this department includes gold, silver, platinum, copper, lead, iron, mercury, and antimony, limestone, potash, soda, magnesia, alum, and salt, coal and asphalt, emeralds, amethysts, and amber. Many of the most important deposits are as yet untouched, owing mainly to the defective state of internal communication, and even those that have been worked have proved much less remunerative from the same cause. Gold especially is very widely diffused; it was freely used by the natives before the arrival of Europeans, and formed a valuable source of revenue to the Spanish Government, who employed thousands of negroes and Indians in the task of collection. It is principally obtained from alluvial deposits; and in some districts there is hardly a stream that would not furnish its quota. Hydraulic appliances were introduced about 1870 in some of the workings; and a more systematic treatment is being gradually adopted. Antioquia is the most important gold-producing state in the confederation; the total value of gold and silver exported from the capital in 1875 was 2,403,241 dollars; there were upwards of eighty lode mines at work in 1875; and 15,000 men and women are employed in the mining. The silver frequently occurs in very rich lodes; but, owing it would seem to various economical causes, many of the mining operations have been unsuccessful. The "Santa Anna" mines in Tolima, which were worked from 1826 to 1873 (for some years under the direction of Mr. Robert Stephenson, the railway engineer), yielded during that period about £700,000 worth of ore, but ultimately proved a failure. The "Frias" silver mine, belonging to the Tolima Mining Company of London, yielded in 1875 300 tons of ore valued at £100 per ton. The emerald mines are remarkable as being the only known source of the genuine stone. They are situated at Muso, in the state of Boyacá, in the Central Cordillera, to the north of Bogotá. Soon after the Spanish Conquest they were worked on a large scale by the Government; but towards the close of the 18th century it was found that it cost 6500 pesos to extract 1000 pesos worth of emerald, and they were consequently abandoned (see Ezpeleto's report in *Relac. de los Virreyes*, p. 347). After the war of independence the mines were appropriated by the republic, from which a French company obtained a monopoly from 1864 to 1874. During this period the stones found a ready market in Paris, where green was the imperial color. Since the expiry of the contract the mines have been demonopolized. The emeralds are found in two distinct layers of calcareous bitumen, the upper of which is black and friable, and the under compact. In the upper the emeralds occur in "nests," in the lower in veins, and usually in the neighborhood of bands of fluor-spar. The finest stones may be worked up to a value of £20 a carat; the worst sorts are only worth about 5s. Coal is pretty generally distributed throughout the republic, and the great bed of Cali probably extends to the Pacific. Rock-salt is obtained in the table-lands of Bogotá, Tunja, and Pamplona, and forms an important Government monopoly.

Though Colombia is situated within the tropics, and, in fact, as we have seen, is crossed by the equator in its southern limits, its great irregularity of surface and its extensive coast-lines develop a great variety of climatic conditions. A comparatively short journey transports the traveller from the sultry valley of the Magdalena, where the water grows tepid and the stones burning hot in the sun's rays, to the summits of a mountain where the snow lies cold from year to year. In the table-lands and valleys of the Eastern and Western Cordilleras, at a height of 800 to 9500 feet above the level of the sea, there are two dry seasons and two rainy, the former commencing at the solstices and the latter at the equinoxes, while in the lowlands both of the Pacific and the Atlantic seaboard there is only one dry and one rainy of six months each. In the Gulf of Darien and the Isthmus of Panama there is no such distinction, and rain occurs in any part of the year. The greatest mean temperature in the country is about 86° Fahr., and the lowest in the inhabited parts of the Cordilleras is about 44°. At Honda, which is about



1000 feet above sea-level, the daily range of the thermometer is only from 8° to 12°, and the annual not more than 20°. "The hottest place," says Mesquera, to whom we are largely indebted, "which I have found in New Granada, is the port of Ocaña, where I have on several occasions seen the thermometer in the shade at 104° Fahr." In the *llanos* of the Orinoco the mean annual temperature is about 80° Fahr., while in the forest district to the south the average is about 8° higher. In the latter the rain is distributed throughout the year, while in the former the seasons are distinctly marked, and from November till April the rains fall in torrents accompanied with dreadful thunderstorms.

**Flora.** In keeping with this variety of climate the Colombian flora ranges from purely tropical forms in the lowlands up to purely Alpine or boreal types in the mountains. The tree limit on Tolima, in the Central chain, is 10,360 feet. The country abounds with extensive forests, in which timber of gigantic proportions waits for the settler's axe. Besides several of the common species of palm trees which are found as high as 2500 feet above the sea, there are two remarkable species, the *Ceroxylon andicola*, Palma de Cera, or Wax-palm, and the *Oreococca regia*, or Palmita del Azufral, which in company with the oak, frequently clothes the Cordilleras to a height of 6000 or 8000 feet. They are both of extreme beauty, and the former shoots up to about 180 or 200 feet. From the Sierra Nevada and other districts are obtained logwood, Brazil-wood, and fustic; and the *Myroxylon toluifera*, from which the balsam of Tolu is collected, grows luxuriantly on the banks of the Rio Negro. Excellent India-rubber is obtained from the *Castilloa elastica*, a lofty and luxuriant tree, which occurs in considerable abundance in Panamá, Cauca, and other states. The quantity and quality of the material might be greatly increased and improved, as the collection is still in the hands of a very rude and careless class of men. Under the superintendence of Mr. Cross the tree is being introduced into British India. Cinchona of six or seven different varieties is common throughout the country,—the elevation most favorable for its growth being between 7800 and 9000 feet above the sea. Of other medicinal plants there may be mentioned the aloe, the salsaparilla, the albatague, and the vine of the cross. The cotton plant grows wild in many parts and yields an excellent fibre; indigo is indigenous; and an almost endless variety of fruits are found throughout the country.

**Animals.** The fauna is perhaps hardly so rich as the flora, but it does not fall far behind. Of monkeys there are at least seventeen distinct species; the feline race is represented by seven or eight, including the puma and the jaguar; there are two species of bears; the alligator swarms in the Magdalena and some of the other rivers; deer are common at various elevations; the sloth, the armadillo, the guagua (*Celogenus subniger*), the opossum, and the cavy prevail in the forests; and the tapir or danta wanders in the higher regions. Among the birds may be mentioned the condor and ten other birds of prey, several species of swallows, numerous varieties of parrots, parquets, lorics, and cockatoos, cranes and storks, the pleasant-singing tropical, and the strangely-colored sol-y-lune, which takes its name from the figure of the sun and moon on its wings. The boa-constrictor, the yaruma, the cascabel, and various other serpents are frequent enough in the warmer regions, but are not met with at a greater height than 5400 feet above the sea. Insects are abundantly represented, the most important practically being the ants, which in some districts, as for instance the isthmus, are almost a plague. Turtle abounds on the coasts; and pearl-oysters are the object of a very considerable fishery.

**Agriculture.** Agriculture holds the first place among the industries of Colombia; but the methods employed are still of a very rude description. Maize, wheat, and other cereals are cultivated on the elevated plains; rice, cotton, tobacco, sugar, coffee, cocoa, yams, arracacha, and bananas in the coast region. Tobacco is especially successful in Ambalema, Carmen, Palmira, Jiron, and Morales, and it forms an important export. In the plains of the Orinoco and the undulating savannahs of Panamá the breeding of cattle and horses is largely carried on by the creole inhabitants, and several of the Indian tribes are also in possession of valuable herds. Beyond such common (almost domestic) trades as hand-weaving, dyeing, tanning, and basket-making, there

is almost no manufacturing industry in the country, though the basis for future development has been laid by the establishment in Bogotá of glass-works, distilleries, a cigar-factory, and a sulphuric acid factory. One product of the domestic industry alone finds its place in the list of exports—namely, straw hats, usually known as jipijapa or Panamá hats. The raw produce, however, is largely exported; the principal articles being cinchona bark, indigo, coffee, cotton, tobacco, silver ore, hides, and the minor items—ivory-nuts, ipecacuanha, and balsam of Tolu. The relation between the exports and imports and the variations of amount from year to year will be seen by the following table:—

	Imports.	Exports.
1869.....	7,255,092 dollars.	8,137,000 dollars.
1870.....	5,843,451	8,077,153
1871.....	5,862,711	8,247,817
1872.....	8,427,175	8,253,806
1873.....	12,500,000	10,500,000

The national government of Colombia is republican,—the main basis of the constitution being a Constitution scheme drawn up in 1863 after the model of the United States of North America. The executive power is exercised by the president and four ministers or *secretarios*. The presidential elections recur every two years; the choice is determined by a majority of the states; and the new president enters on office on the 1st of April. The secretaries have charge respectively of the four departments of Home and Foreign Affairs, Finance and Public Works, Treasury and Credit, and War and Marine. The legislative power of the federation is divided between a house of representatives elected by universal suffrage, and a senate of 27 members, or three from each state. The number of the representatives depends on the size of the state-population,—one being allowed for every 50,000 inhabitants, and one for the remainder if it reaches 20,000. In 1875 there were in all 61 representatives. There is a supreme court at Bogotá, conducted by a president, four judges, and a procurator-general; the judges are elected by the legislative houses of the nine states. There is no state church, and full religious liberty prevails. The predominant profession, however, is the Roman Catholic, and an archbishop is established at Bogotá.

The national income is very small; but it has been steadily increasing for a number of years. In 1869-70 it was 2,883,758 pesos (about 4s. value); in 1870-71, 3,573,570; in 1871-72, 3,173,448; in 1872-73, 4,000,000. The taxes are very light,—by far the greater part of the revenue accruing from the custom-houses established at Buenaventura, Carlosama, Cartagena, Cucuta, Rio Hacha, Sabanilla, Santa Marta, Jamaica, and Turbo. In 1872-73 the various receipts were—customs, 2,775,456 pesos; salt monopoly, 799,213; Panamá railway, 250,000; postal service, 67,609; telegraphs, 10,627; mint, 18,000; national property, 72,395; ecclesiastical property, 6506. The customs would yield a still greater return were it not for smuggling, which prevails largely, especially at Cartagena. The tariff hitherto in use divides articles into classes, which pay so much per kilogramme; and thus the burden of the duty falls most on inferior goods. The salt-works yielded, in 1869-70, 136,568 cwt., of which 81 per cent. was obtained from Cundinamarca, 18 per cent. from Boyacá, and 1 per cent. from the territory of San Martin. The postal service is still in a very backward state, and the charges are very high; but this cannot be otherwise till the road system of the country has been developed. Rapid progress, however, is being made by several of the states in this preliminary undertaking. In April, 1875, there were upwards of 1000 miles of telegraph, the principal lines stretching from Honda to Bogotá, and from Ambalema to Manizales. In 1873 the total number of telegraphic messages amounted to 560,000.

In the less populous districts the maintenance of the lines is very costly, as not only are the wires stolen by thieves, but they are frequently damaged by the monkeys, who use them for gymnastic purposes. The only two railways actually in operation are the Panamá line (46 miles), and the line between Sabanilla and Barranquilla (17 miles); but great efforts are being made, both by the central Government and by the separate states, to construct lines throughout the country, and contracts have already been made for some of the most important. The national property consists mainly of waste lands, which are allotted to applicants on very liberal terms. A great deal of the church property confiscated by the republic has been sold; some of it is rented out; and many of the convents are used for public offices. The public debt amounted, in 1875, to 10,105,500 dollars, of which 10,000,000 are the old debts of the war of independence, which pay an interest of 4½ per cent. The English debt of 1863 has been cleared off. There is no national navy, and the armed force in time of peace only amounts to 1420 men; in time of war the states have to furnish 1 per cent. of their population. The separate states have their own constitutions and governors, and they differ considerably in their political tendencies.

**Educa-  
tion.**

The educational condition of Colombia has hitherto been very low; but, by a law published in 1870, the management of public instruction was taken from the hands of the clergy and intrusted to the state, a complete reform of the school system was effected, teachers were introduced from Europe, and compulsory education was adopted. In this last point Colombia has taken the lead in the New World. In Antioquia 486 schools were in operation in 1873, with an attendance of about 21,500; in Bolivar, 44; in Boyacá, 208 (public schools), with 9000 pupils; in Cauca, 229, with 9925; in Cundinamarca, 338, with 16,489; in Magdalena, 100, with 2968; in Santander, 300, with 11,974; in Tolima, 100 schools and 3640 scholars. In Panamá the state of education is not so good, but public schools are being established there also. The expense is borne partly by the special states and partly by the national treasury, which devotes \$17,120 dollars annually to this purpose, assigning 200,000 to subsidize the states, and 117,120 to the institutions for the higher education. These include the national university, the Vasquez academy, and schools of engineering, natural science, &c., established in the federal capital, state colleges, and normal schools.

It can hardly be said that Colombia possesses a national literature, the writing and printing hitherto effected serving mainly the immediate purposes of the day. Its inheritance of the Spanish language, however, leaves it in vital contact with one of the older literatures of Europe, and frees it from the painful, though, it might be, fruitful necessity of working its way through confusion of dialects to a recognized national speech. Such intellect as the country has spared from war and political activity has mainly been directed to the natural sciences, which found their first footing on Colombian soil through the labors of the celebrated Don José Celestino Mutis. Of those who have attained a greater or less degree of fame in this department, it is sufficient to mention Zea, Cabal, Caldas, Pombo, Cespedes, Camacho, Lozano, and Codazzi; Restrepo and Mosquera have contributed to the history of their country. In several of the more important cities journalism is pretty well represented, and the Government is about to establish a magazine for the purpose of diffusing a knowledge of Colombian affairs.

**Native  
tribes.**

The population of the territory of the present republic at the time of the Spanish Conquest consisted of a large number of independent tribes of very various degrees of civilization. Of these several have totally disappeared as separate unities; others have been in large measure Hispanized both in language and in habits; many still retain their separate dialects, organization, and customs, and some are even now as opposed to the European movement as they were when the first white foot left its print on their shores. According to Uricoechea there are at least twenty-seven native languages spoken in the western part of Colombia, fourteen in Tolima, thirteen in the region of the Caquitá, twelve in Panamá, Bolivar, and Magdalena, ten in Bogotá and Cundinamarca, and thirty-four in the region of the Meta, while twelve have died out in the course of the last century. The tribes of the Atlantic seaboard, from Chiriquí to Goahira, attach themselves to the great Carib stock; those of the Eastern portion of the country show affinities with the contiguous Brazilian race; those of the Tuquerus district are of the Peruvian type; while the tribes of Antioquia, Cauca, Popayan, and Neiva preserve characteristics more akin to those of the Asteas than to any other race.

At the time of the Spanish Conquest the most important of all the tribes was the Muisca or Chibcha, who had attained a considerable degree of civilization, and established their authority over the table-lands of Bogotá and Tunja. They are now represented by some bands that wander about the Meta; their ancient language is partly preserved by the labors of Gonzalo Bermudes, José Dadel, and Bernardo de Lugo; and they have been the subject of a special study by Uricoechea in his *Grammatica, Vocabulario, etc., de la Lengua Chibcha*, Paris, 1871. The Chibcha, says this author, were divided into three independent nations and several caciqueships; three chiefs exercised supreme power—the *Zipa*, who resided in Muequetá (the present Funza), the *Zaque*, resident at Hunza (now Tunja), and the *Jeque*, or chief of Iraca, who held the office of pontiff, was regarded as the successor of the god Nemtereqoteba, and had his residence at the city of Suamos or Sogamoso.

Another remarkable tribe, which has now totally disappeared, was the Tayronas, of the Sierra Nevada of Santamarta. They likewise were well advanced in civilization, as is proved not only by the reports of their conquerors, but also by such remains of their skill as the gold ornaments which are found from time to time in their territory, and the well-made roads by which it is still traversed. The most important of the tribes that still retain their savage state are the Mesayas, the Caquetas, the Mocoas, the Amarizanos, the Guipnabias, and the Andaquies in the eastern part of the republic; the Goahiros, the Motilonos, the Guainetas, and the Cocinas, in the districts of Rio Hacha, Upar, and Santamarta; and the Dariens, the Cunaounas, and the Chocos, on the banks of the Atrato and its affluents. These tribes have

all along been a thorn in the side of the country. In the 18th century we have in the vice-regal reports continued complaints of the raids of the Chimilas, the Goahiros, the Andaquies, and the Motilonos, who defied equally the military and the ecclesiastical method of reduction. The missionaries who were scattered through the country had a hard time of it with their converts, who even after they were baptized and instructed, "take advantage of their knowledge to elude and assail us." To the present day the settlement and Christianization of this part of the population is one of the political problems of Colombia, and as recently as 1874 a bill was brought in for the purpose. The exact number of the uncivilized Indians is hardly ascertained; it was roughly calculated by Mosquera as ranging from 108,000 to 120,000. The rest of the population is composed mainly of Spanish Creoles, Negroes, and mixed races. According to Samper it was divided in 1858 as follows:—1,527,000 whites and white crossbreeds, 447,000 crossbreeds in which the Indian blood is more distinctly present, 90,000 Africans and 446,000 crossbreeds in which the Negro or Indian blood is plainly predominant. According to a communication supplied to Behm and Wagner's *Bevölkerung der Erde*, 1874, the distribution of the population, exclusive of the uncivilized Indians, was in 1871 as it appears in the following table:—

	Area in sq. miles.	Males.	Females.	Capitals.	Pop. of Capitals.
Antioquia.....	22,790	181,492	184,482	Medellin.....	80,000
Bolivar.....	27,027	114,806	125,042	Cartagena.....	7,800
Boyacá.....	83,349	232,727	250,147	Tunja.....	8,800
Cauca.....	257,451	210,368	224,715	Popayan.....	18,000
Cundinamarca.....	79,845	196,843	212,789	Bogotá.....	60,000
Magdalena.....	26,950	40,682	44,578	Santamarta.....	3,500
Panamá.....	31,921	113,009	107,538	Panamá.....	18,378
Santander.....	16,298	204,551	220,876	Socorro.....	20,000
Tolima.....	18,476	110,791	120,100	Guamo.....	7,000

Owing to the discordant claims of Colombia, Venezuela, and Brazil, the area of the frontier states is very variously given according to the limits selected, and the calculation of the population is open to the same irregularity.

**History.**—The coast of Colombia was one of the first parts of the American continent visited by the Spanish navigators. Alonso de Ojeda touched at several points in 1499 and 1501; and Columbus himself visited Veragua, Portobello, and other places in his last voyage in 1502. In 1508 Ojeda obtained from the Spanish crown a grant of the district from Cape Vela westward to the Gulf of Darien, while the rest of the country from the Gulf of Darien to Cape Gracias-a-Dios was bestowed on his fellow-adventurer Nicuesa. The two territories designated respectively Nueva Andalucia and Castella de Oro were united in 1514 into the province of Tierra-firme, and entrusted to Pedro Arias de Avila. By the middle of the century the Spanish power was fairly established, and flourishing communities arose along the coasts, and in the table-lands of Cundinamarca formerly occupied by the Muisca. For the better government of the colony the Spanish monarch erected a presidency of New Granada, which continued till 1718, when it was raised to the rank of a viceroyalty. In the following year, however, the second viceroy, D. Jorge Villalonga, Count de la Cueva, expressing his opinion that the maintenance of this dignity was too great a burden on the settlers, the viceroyalty gave place to a simple presidency. In 1740 it was restored, and it continued as long as the Spanish authority, including within its limits not only the present Colombia, but also Venezuela and Ecuador. An insurrection against the home government was formally commenced in 1811, and an incessant war against the Spanish forces was waged till 1824. In 1819 the great national hero, Bolivar (see BOLIVAR), effected a union between the three divisions of the country, to which was given the title of the Republic of Colombia; but in 1829 Venezuela withdrew, and in 1830 Quito or Ecuador followed her example. The Republic of New Granada was founded November 21, 1831; and in 1832 a constitution was promulgated, and the territory divided into eighteen provinces, each of which was to have control of its local affairs. The president was to hold office for four years; and the first on whom the dignity was bestowed was General Santander. His position, however, was far from enviable; for the country was full of all the elements of unrest and contention. One of his measures, by which New Granada became responsible for the half of the debts of the defunct republic of Colombia, gave serious offence to a large party, and he was consequently succeeded, not as he desired, by José María Obando, but by a member of the opposition, José Ignacio de Márquez. This gave rise to a civil war, which lasted till 1841, and not only left the country weak and miserable, but afforded an evil precedent which has since been too frequently followed. The contest terminated in favor of Márquez, and he was succeeded in May, 1841, by Pedro Aleantara Herrán, who had assisted to obtain the victory. In 1840 the province of Cartagena had seceded, and the new president had hardly taken office before Panamá and Veragua also

declared themselves independent, under the title of the State of the Isthmus of Panamá. Their restoration was, however, soon effected; the constitution was reformed in 1843; education was fostered, and a treaty concluded with the English creditors of the republic. Further progress was made under General Mosquera from 1846 to 1848; a large part of the domestic debt was cleared off, immigration was encouraged, and free trade permitted in gold and tobacco. The petty war with Ecuador, concluded by the peace of Santa Rosa de Carehi, is hardly worthy of mention. From 1849 to 1852 the reins were in the hands of General Lopez, a member of the democratic party, and under him various changes were effected of a liberal tendency. In January, 1852, slavery was entirely abolished. The next president was José María Obando, but his term of office had to be completed by vice-presidents Obaldia and Mallarino. In 1853 an important alteration of the constitution took place, by which the right was granted to every province to declare itself independent, and to enter into merely federal connection with the central republic. In 1856 and 1857, Antioquia and Panamá took advantage of the permission. The Conservative party carried their candidate in 1857, Mariano Ospino, a lawyer by profession; but an insurrection broke out in 1859, which was fostered by the ex-president Mosquera, and finally took the form of a regular civil war. Bogotá was captured by the democrats in July, 1861, and Mosquera assumed the chief power. A congress at Bogotá established a republic, with the name of the United States of Colombia, adopted a new federal constitution, and made Mosquera dictator. Meanwhile the opposite party was victorious in the west; and their leader, Arboleda, formed an alliance with Don García Moreno, the president of Ecuador. He was assassinated, however, in 1862; and his successor, Canal, came to terms with Mosquera at Cali. The dictatorship was resigned into the hands of a convention at Rio Negro, in Antioquia; a provisional government was appointed, a constitution was drawn up, and Mosquera elected president till 1864. An unsuccessful attempt was also made to restore the union between the three republics of the former federation. The presidency of Manuel Murillo Toro (1864-66) was disturbed by various rebellions, and even Mosquera, who next came to the helm, found matters in such a disorganised condition that he offered to retire. On the refusal of his resignation, he entered into a struggle with the majority in the congress, and ultimately resorted to an adjournment and the unconstitutional arrest of 68 of the senators and representatives. To the decree of impeachment published by the congress he replied by a notice of dissolution and a declaration of war; but he soon found that the real power was with his opponents, who effected his arrest, and condemned him first to two years' imprisonment, but afterwards by commutation to two years' exile. The presidency of Santos Gutiérrez (1868-70) was disturbed by insurrections in different parts of the republic, the most important of which was that in Panamá, where the most absolute disorganization prevailed. Under his successor, General E. Salgar, a Liberal candidate, elected in opposition to General Herrán, a treaty was finally concluded with the United States in connection with an interoceanic canal, a bank was established at Bogotá, and educational reforms instituted. Manuel Murillo Toro (1872-74) and Santiago Peres (1874-76) have seen the country apparently acquiring constitutional equilibrium, and turning its energies to the development of its matchless resources. There has been no war with foreign states for several years; and though the question of the boundary lines frequently causes dispute between Colombia and her eastern neighbors, Venezuela and Brazil, it is to be hoped it will be peaceably settled. The election for the presidential term 1876-78, resulted in favor of Aquileo Parra.<sup>1</sup>

Literature.—Bern. de Lugo, *Grammatica en la lengua del nuevo reyno llamada Mosca*, Madrid, 1619; Fr. de Tauste, *Arte y vocabulario de la lengua de los Indios de la provincia de Cumana o nueva Andalucia*, Madrid, 1680; Piedrahita, *Historia general de la conquista del nuevo reyno de Granada*, Madrid, 1688; Fr. Ant. Cautin, *Hist. corografica de la nueva Andalucia*, etc., Madrid, 1779; Restrepo, *Historia de la revolucion de Colombia*, Paris, 1827; Acosta, *Compendio del descubrimiento y colonizacion de la Nueva Granada*, Paris, 1848, and "Sur la Sierra Nevada de Sainte Marthe," in *Bulletin de la Soc. Géol. de France*, 1851-2; Karsten, *Ueber die geognostischen Verhältnisse der West. Colombia*, Vienna, 1856; Albert Berg, *Physiognomie der Trop. Vegetation Süd Amerikas*, 1856 (the views in this fine folio are almost exclusively Colombian); Samper, *Ensayo sobre las revoluciones pol. y la condicion de las republicas Colombianas*, Paris, 1861; E. Reclus, *Voyage à la Sierra Nevada de Sainte Marthe*, Paris, 1861; Wagner in Petermann's *Mittheilungen*, 1861 and 1862; Powles, *New Granada: its Internal Resources*, London, 1863; Mosquera, *Memoria sobre la géografia de la Nueva Granada*, New York, 1852, and his *Compendio de geografía de los estados unidos de Colombia*, London, 1866; Garcia y Garcia, *Relaciones de los Virreyes del Nuevo Reino de Granada*, New York, 1869; Codazzi, *Atlas de los estados unidos de Colombia*; Reiss and Stübel, *Alturas tomadas en la republ. de Colombia*, Quito, 1872 (reproduced in *XII. Jahresbericht des Vereins für Erdk. zu Dresden, Wissenschaft. Theil*); Steinheil, "Barometrische

Höhenbestimmungen in Colombia," and "Reisen in Colombia," in Petermann's *Mittheil.*, 1876. The literature of the various canal projects is itself very extensive; it is sufficient to mention the works of Kelly, Puydt, and Selfridge. (H. A. W.)

COLOMBO, the capital and principal seaport town of Ceylon, on the west coast of the island, in 6° 55' N. lat. and 79° 45' E. long. The municipal limits include an area of 6415 acres, which is divided into the nine wards of The Fort and Galle Face, Pettah, St. Sebastian's, St. Paul's, Cottanchina, New Bazaar, Marandana, Slave Island, and Colpetty. The fortified part of the town is about a mile and a half in circuit, and occupies a rocky promontory of but slight elevation, surrounded on three sides by the sea, and protected on the land side by a lake, a moat, and draw-bridges. The Galle Face affords a favorite promenade for the European population; Pettah is mainly inhabited by natives and half castes; and Colpetty is a beautiful suburb. Most of the streets are finely shaded with a species of *Hibiscus* planted by the Dutch; and the most of the older European houses bear the marks of Dutch occupation. Colombo contains the Government offices and courts, and is the residence of the civil and military authorities, the seat of a Church of England bishop, and a centre for Roman Catholic, Wesleyan, Baptist, and other missionary organizations. The principal buildings are the Government or Queen's House, the court-house, the town-hall, the lunatic asylum, the lazaretto, the military barracks and hospitals of Galle Face, Wellicadde jail, and Wolfendahl church; among the public institutions may be mentioned St. Thomas's college and collegiate school, founded by Bishop Chapman in 1821; Wesley college; the industrial school; the medical school, established in 1870, with six scholarships attached; a branch of the Royal Asiatic Society, with a museum; the United Service Library; the military-medical and the colonial-medical libraries and museums; the Pettah library, established in 1829; the agri-horticultural society; and the model farm inaugurated by Prince Alfred. The cinnamon gardens and the circular walk are pleasant places of resort; the former date from the Dutch occupation, and were long celebrated for their beauty and luxuriance. The town is supplied with gas and water by a company incorporated under Acts passed in 1862 and 1867. The principal articles of manufacture in Colombo are coffee, oil, and coir; the first of these especially keeps a large number of mills in operation. There are also a good many saw-mills in the town and neighborhood, and the Government maintains a foundry and ironworks. The supply of ice is in the hands of a company. The harbor is small, and the roadstead is safe only during the south-east monsoon, but various improvements now in progress promise to make Colombo one of the chief ports of Southern India. The first stone of a great breakwater was laid by the Prince of Wales in 1875. The population of Colombo is of very various origin:—Sinhalese, Parsees, Chinese, Malabars, Arabs, Persians, Kaffirs, Afghans, descendants of Portuguese and Dutch, and half castes of all colors. In 1874 the total number of inhabitants was given as 97,129, of whom 42,160 were Sinhalese, 25,389 Moors, 20,638 Tamils and Chatties, and 1765 Europeans. Colombo was originally known as the Kalantotta or Kalany ferry. By the Arabs the name was changed to Kalambu, and the town is mentioned by Iba Batuta about 1340 as the largest and finest in Serendib. In 1517 the Portuguese effected a settlement, and in 1520 they fortified their port and bade defiance to the native besiegers. In 1586 the town was again invested by Raja Singh, but without success. On its capture by the Dutch in 1666 it was a flourishing colony with convents of five religious orders, churches, and public offices, inhabited by no fewer than 900 noble families and 1500 families dependent on mercantile or political occupations. In 1796 it was surrendered to the British.

COLON. See ASPINWALL, vol. ii. p. 626.

COLONNA, GIOVANNI PAOLO, chapel-master of St. Petronio at Bologna, and president of the Philharmonic Academy there, was born at Brescia about the middle of the 17th century. The music-school which he established at Bologna produced many good musicians, among them Clari. Most of Colonna's works are for the church, and are among the most remarkable compositions of the 17th century. They included settings of the psalms for three, four, five, and eight voices, and several masses and motetts

<sup>1</sup> A revolution in 1885 forced on the Constitution of August 4, 1886, by which the nine states became departments, with their gov- ernors appointed by the President of the Republic. Rafael Núñez on June 4, 1887, entered on that office.—AM. Ed.]

He also composed an opera, under the title *Amilcare*, and an oratorio, *La Profesia d'Eliseo*. Boyce considered Colonna as Handel's model for choruses accompanied with instrumental parts different from the vocal. The same practice, however, was adopted by several of Colonna's contemporaries.

COLONNA, VITTORIA (1490-1547), the daughter of Fabrizio Colonna, grand constable of the kingdom of Naples, and of Anna da Montefeltre, daughter of the "Good Duke" Frederick of Urbino, was born at Marino, a Roman fief of her father's house. Betrothed when four years old, at the instance of Ferdinand of Aragon, to Francisco D'Avalos, son of the marquis of Pescara, she received the highest education, and gave early proof of a love of letters. Her hand was sought, among other suitors, by the dukes of Savoy and Bragança, but at seventeen, as she ardently desired, her marriage with D'Avalos took place. The couple resided on the islet of Ischia till 1511, when the husband offered his sword to the Holy League, in whose service he was taken at Ravenna (1512), and carried to France. During the months of exile and the long years of campaigning that followed this mishap, they corresponded in most passionate terms, in prose and verse. They saw each other but seldom, for Pescara was one of Charles V.'s most brilliant and active captains; but Vittoria's influence over him was sufficient to keep him, after Pavia (1525), from joining the projected league against the emperor, and to make him refuse the crown of Naples that was offered him as the price of his treason. The same year he died of wounds at Milan. Vittoria, who was hastening to tend him, received the news of his death at Viterbo. She halted, and turned off to Rome, whence, after a brief stay, she departed for Naples. There she remained for about ten years. She refused several suitors, and began to produce those *Rime Spirituali* that form so distinct a feature in her works. In 1536 she left Naples for Ferrara, calling at Rome, where she was visited by Charles V., and whither in 1538 she came to take up her abode. In Rome, besides winning the esteem of Reginald Pole and Cardinal Contarini, she became the object of a passionate friendship on the part of Michelangelo, then in his sixty-fourth year. The great artist wrote for her some of his finest sonnets, made drawings for her, and spent long hours in her society. Her removal from Rome to Orvieto (1541), on the occasion of her brother Ascanio Colonna's revolt against Paul III., and her subsequent residence in Viterbo (1541-45), where Reginald Pole was governor and legate, produced no change in their relations; they visited and corresponded as before. She returned to Rome in 1546, and died there about the end of February, 1547.

The amatory and elegiac poems of Vittoria Colonna, which are the production of a delicate and sympathetic imitativeness rather than of a vigorous and original talent, were printed at Parma in 1538; a second edition appeared in the following year; a third, containing sixteen of the *Rime Spirituali*, was published at Florence soon afterwards; and a fourth, including a still larger proportion of the religious element, was issued at Venice in 1544.

COLONY. The term colony, often loosely applied, is most commonly used to denote a settlement of the subjects of a sovereign state in lands beyond its boundaries, owning no allegiance to any foreign power, and retaining a greater or less degree of dependence on the mother country. The founding and the growth of such communities furnish matter for an interesting chapter in the history as well of ancient as of modern civilization; and the regulation of the relations between the parent state and its dependencies abroad gives rise to important problems alike in national policy and in international economics.

It was mainly the spirit of commercial enterprise that led the Phœnicians to plant their colonies upon the islands and along the southern coast of the Mediterranean; and even beyond the Pillars of Hercules the earliest great colonizing race left enduring traces of its maritime supremacy. Carthage, indeed, chief of the Phœnician settlements, sent forth colonies to defend her conquests and strengthen her military power; and these sub-colonies naturally remained in strict subjection to her power, whereas the other young Phœnician states assumed and asserted entire independence.

In this latter respect the Greek colonies resembled those of the Phœnicians. From a very early period the little civic communities of Greece had sent forth numerous col-

onizing streams. At points so far asunder as the Tauric Chersonese, Cyrene, and Massilia were found prosperous centres of Greek commercial energy; but the regions most thickly peopled by settlers of Greek descent were the western seaboard of Asia Minor, Sicily, and the southern parts of the Italian peninsula. Nor were the least prosperous communities those which were sprung from earlier colonies. The causes that led to the foundation of the Greek colonies were very various. As in Phœnicia, pressure created by the narrow limits of the home country coincided with an adventurous desire to seek new sources of wealth beyond seas; but very many Greek emigrations were caused by the expulsion of the inhabitants of conquered cities, or by the intolerable domination of a hated but triumphant faction within the native state. The polity of the new community, often founded in defiance of the home authorities, might either be a copy of that just left behind or be its direct political antithesis. But wherever they went, and whether, as apparently in Asia Minor, Greek blood was kept free from barbaric mixture, or whether, as in Magna Græcia and Sicily, it was mingled with that of the aboriginal races, the Greek emigrants carried with them the Hellenic spirit and the Hellenic tongue; and the colonies fostered, not infrequently more rapidly and more brilliantly than at home, Greek literature, Greek art, and Greek speculation. The relation to be preserved towards the mother states was seldom or never definitely arranged. But filial feeling and established custom secured a measure of kindly sympathy, shown by precedences yielded at public games, and by the almost invariable abstinence of the colony from a hostile share in wars in which the mother city was engaged.

The relation of Rome to her colonies was altogether different. No Roman colony started without the sanction and direction of the public authority; and while the *Colonia Romana* differed from the *Colonia Latina* in that the former permitted its members to retain their political rights intact, the colony, whether planted within the bounds of Italy or in provinces such as Gaul or Britain, remained an integral part of the Roman state. In the earlier colonies, the state allotted to proposing emigrants from amongst the needy or discontented class of citizens portions of such lands as, on the subjection of a hostile people, the state took into its possession as public property. At a later time, especially after the days of Sulla, the distribution of the territories of a vanquished Roman party was employed by the victorious generals as an easy means of satisfying the claims of the soldiery by whose help they had triumphed. The Roman colonies were thus not merely valuable as *propugnacula* of the state, as permanent supports to Roman garrisons and armies, but they proved a most effective means of extending over wide bounds the language and the laws of Rome, and of inoculating the inhabitants of the provinces with more than the rudiments of Roman civilization.

The occupation of the fairest provinces of the Roman empire by the northern barbarians had little in common with colonization. The Germanic invaders came from no settled state; they maintained loosely, and but for a short while, any form of brotherhood with the allied tribes. A nearer parallel to Greek colonization may be found in Iceland, whither the adherents of the old Norse polity fled from the usurpation of Harold Haarfager; and the early history of the English pale in Ireland shows, though not in orderliness and prosperity, several points of resemblance to the Roman colonial system.

Though both Genoese and Venetians in their day of power planted numerous trading posts on various portions of the Mediterranean shores, of which some almost deserve the name of colonies, the history of modern colonization on a great scale opens with the Spanish conquests in America. The first Spanish adventurers came, not to colonize, but to satisfy as rapidly as possible and by the labor of the enslaved aborigines, their thirst for silver and gold. Their conquests were rapid, but the extension of their permanent settlements was gradual and slow. The terrible cruelty at first exercised on the natives was restrained, not merely by the zeal of the missionaries, but by effective official measures; and ultimately home-born Spaniards and Creoles lived on terms of comparative fairness with the Indians and with the half-breed population. Till the general and successful revolt of her American colonies, Spain maintained and employed the latter directly and solely for what she conceived to be her own advantage. Her commercial

policy was one of most irrational and intolerable restriction and repression; and till the end of Spanish rule on the American continent, the whole political power was retained by the court at Madrid, and administered in the colonies by an oligarchy of home-bred Spaniards.

The Portuguese colonization in America, in most respects resembling that of Spain, is remarkable for the development there given to an institution sadly prominent in the history of the European colonies. The nearness of Brazil to the coast of Africa made it easy for the Portuguese to supply the growing lack of native labor by the wholesale importation of purchased or kidnapped Africans.

Of the French it is admitted that in their colonial possessions they displayed an unusual faculty for conciliating the prejudices of native races, and even for assimilating themselves to the latter. But neither this nor the genius of successive governors and commanders succeeded in preserving for France her once extensive colonies in Canada or her great influence in India. In Algeria the French Government has not merely found a practical training-school for her own soldiers, but by opening a recruiting field amongst the native tribes it has added an available contingent to the French army.

The Dutch took early a leading share in the carrying-trade of the various European colonies. They have still extensive plantations in the East Indian Archipelago; and though their settlement at the Cape passed into British hands, a republic of Dutch-speaking boers maintains a precarious existence northward from the British possessions. The Danish and Swedish dependencies in the Antilles are but trifling in extent or importance.

It is the English-speaking race that has shown an unexampled energy and capacity for colonization. The English settlements in Virginia, New England, Maryland, and Pennsylvania had, between the second decade of the 17th and the seventh decade of the 18th century, developed into a new nation that was soon able to take rank with the most powerful of European states. Promoted in great measure by the desire to escape from the political or religious oppression of the English court, the transatlantic settlements were, though remaining under governors appointed by England, permitted to arrange their civil polity—necessarily assuming a democratic shape—very much as they chose; and, at first, troubles at home, and later, their distance, saved the colonies from much political interference on the part of successive English Governments. Though by the "Navigation Laws" and other enactments, England had always undertaken to regulate, in her own interest, the commercial relations between herself and her American colonists, encroachment, in the matter of taxation, on the immunity till then enjoyed provoked the spirit that in 1776 "solemnly published and declared that these United Colonies are, and of right ought to be, free and independent States." The vast unoccupied territories of the United States relieve her citizens and the immigrants who join them from seeking scope for their enterprise beyond the recognized limits of the Republic; but the method according to which the United States Government provides for the continuous westward advance of new settlements is essentially a system of colonization. The newly-occupied lands are governed as a "territory" by the Federal Government, till the population reaches a fixed limit high enough to justify a demand to be admitted to the Union on an equal footing with the other States. The "American Colonization Society" has made an interesting philanthropic experiment for the establishment of negro freedmen in Africa; the result is the existing independent Republic of Liberia.

It is estimated that the existing colonies and dependencies of Great Britain cover about one-sixth of the land-surface of the globe, and nearly the same proportion of its population. The various origin of these colonial possessions, and their different relations to the Crown of Great Britain, suggest the question, How the foreign dependencies of a sovereign state may best be classified?

It is clear that the ultimate constitution of a colony depends but little on the manner in which the territory for settling was originally acquired. Whether it was by conquest or by formal cession from a foreign power, the new population, even if, as in the case of Canada, it at first consisted largely of people alien in blood and language to the colonizing country, may soon obtain a constitution and relations to the ruling state identical with those of lands

originally acquired from thinly-scattered and wandering savages merely by the occupancy of citizen emigrants. Of almost equal unimportance for the future organization of the colony are the motives which led the earliest settlers to emigrate. The caprice of mere adventurers, the desperate desire of broken men to repair their fortunes, and the stern determination of public-spirited men to escape for ever some unendurable civil or religious grievance at home, have in their turn given rise to colonies now hardly distinguishable in their general features. Whether the emigration be purely voluntary and undertaken with or without official sanction, or systematically promoted by a Government for the furtherance of national commerce or in order to relieve itself of over-population; whether the new lands be handed over under a royal charter to a company, or granted, as proprietary, to an individual, the traces of the initiatory conditions may speedily disappear. And around a military outpost, a mere trading factory, or the prison walls of a penal settlement, a numerous and enterprising population may soon be tending increasing herds or engaged in the steady and profitable tillage of the soil.

The circumstances whereon the characteristic development and permanent constitution of the colony depend are the physical conditions of the territory—its climate and its products. A colony in the fullest sense of our usage of the term can arise only where the European colonist may look on his adopted habitation as his permanent home, where he can found a family and rear his children in robust health, where his and their growing patriotism may come to regard their interests as bound up with the well-being of the community of which they form a part. Here alone can "daughter-lands" hope to establish a polity that, without wholly severing the bond that unites them to the parent-country, shall secure for them the self-government which the British emigrant regards as his birthright. New nations of the European stock can arise only where the cereals thrive, where the settler can without physical harm undergo the fatigue of rearing and tending his flocks, and where the line that divides master from servant is narrow and easily passed—that is, in a temperate climate. On these conditions it depends whether a foreign settlement shall be, on the one hand, an *agricultural* or *pastoral* colony, or, on the other, a *plantation* colony merely. In the plantation the European is a cultivator too, and may from year to year superintend his crops of sugar, coffee, or tobacco; but his relation to the soil on which he lives is comparatively a loose and transitory one. The difficulty of maintaining health undeteriorated by the tropical climate for more than a few years, and the impossibility of rearing a family in physical vigor, compel the planter to regard Europe as his home, even though his interests in the plantation pass to sons bred in a northern climate. They in their turn go abroad only to hasten home as soon as their views of what constitutes a competency admit. The number of European residents remains small; and the necessity of employing negro or coolie labor must divide the population into two castes,—one of masters and one of servants. And thus results the impossibility of that equal distribution of privileges and of responsibilities wherein lies the advantage of local self-government. Into one or other of the two classes of colonies thus distinguished those sometimes technically termed *mining* and *trading* colonies are, according to circumstances, likely to pass. The trading colony, so long as it is a mere factory or emporium of commodities, differs but little from the settlements of Europeans within the bounds of foreign states such as China, sometimes loosely spoken of as colonies of Europeans. The term *internal colonization* is occasionally used of schemes for promoting the prosperity of thinly-peopled and unfertile areas in some European states. The *military colonies* planted by Austria along her southern frontier serve a useful and very obvious purpose.

The *Colonial Office List* arranges British dependencies under three heads, according to their governmental relations with the English Crown. Officially, British "colonial possessions" are either:—1. "Crown colonies, in which the Crown has the entire control of legislation, while the administration is carried on by public officers under the control of the Home Government; 2. Colonies possessing representative institutions but not responsible government, in which the Crown has no more than a veto on legislation, but the Home Government retains the control

of public officers; 3. Colonies possessing representative institutions and responsible government, in which the Crown has only a veto on legislation, and the Home Government has no control over any officer except the governor. . . . Under responsible government the executive councillors are appointed by the governor alone with reference to the exigencies of representative government, the other public officers by the governor on the advice of the Executive Council. In no appointment is the concurrence of the Home Government requisite." Some of the dependencies ranked here as Crown colonies can be called colonies only in a very loose sense. Military stations, such as Gibraltar, Malta, Aden, are convenient both to the navy and the commercial marine as coaling stations or ports for repair and for provisioning. The distinction between classes 2 and 3 is manifestly temporary, in most cases, at least; there being, for example, no reason why an agricultural colony like that at the Cape, at present without "responsible government," should not ere long possess that privilege. India, a "Crown colony" in the list, is rarely spoken of under that name; the enormous numerical disparity between the handful of resident Europeans and the millions of civilized natives makes it seem incongruous to put India under the same category as Canada or Victoria, and to some extent justifies the recent adoption of the title "Empress of India" by the Queen.

It is rather the force of circumstances than the consistent maintenance of any definite policy that has shaped the relation of England to her various dependencies. But the colonial policy of the future has of late been largely debated, and with widely divergent issues. The "colonial system" so long maintained by England, as well as by all other powers, has been finally abandoned. No one now claims that the mother country has the right, still less that in self-defence she is bound, to restrict and hamper the trade of the colony for her own benefit; nor are there now found many to advocate the differential duties in favor of colonial produce, which that ancient system rendered all but necessary. Many, indeed, go to an opposite extreme, and argue that for both sides it would be better that the interdependent relation should be totally sundered, and each colony, as soon as possible, left to shift for itself. The trade of neither party, it is alleged, gains anything by the maintenance of the connection; the European state is exposed to needless risk in time of war by her responsibility to her scattered dependencies, and to additional expense in providing against that risk, while the colonies are liable to be dragged into wars with which they have no concern. The good-will arising from the sense of common origin would, it is said, amply maintain all the mutual advantages enjoyed under the present system, and would secure a virtual confederacy. The democratic experiments some of our colonies have been freely permitted to carry out, and their trade legislation, divergent from that of England, the incorporative federation of contiguous colonies, and the withdrawal of royal troops from the most developed colonial communities, are by many regarded as actual steps taken in the direction of an eventual separation. To another class of theorizers it appears that a "personal union," the entire legislative independence of the colonies with allegiance to the sovereign of the old country, would better secure the well-being of the several parts of the empire thus constituted; while again others contend that the interests of England and of her possessions abroad, and the cause of freedom and civilization throughout the world, would gain if the bonds of relation were yet more closely drawn together, and if provision could be made for the representation of the colonies in the imperial parliament. Meanwhile, that parliament is supreme over the whole British empire; all the proceedings in the colonial legislatures are liable to be annulled by the Crown. The Crown appoints all governors, is the supreme fountain of justice, and has the sole right of declaring peace and war save in so far as that power is, under certain conditions, delegated to the Governor-general of India; while the admitted aim of colonial policy is to develop the colonies socially, politically, and commercially quite as much as if their ultimate independence were the end contemplated.

Whether European Governments systematically encourage or repress emigration, it is clear that the overgrowth of population in the more densely-peopled centres of the old civilization must continue to send forth emigrants and to increase the already rapid growth of the existing colo-

nies. It is significant for the future of European civilization that, of available territory in the temperate zone of America and Australasia (the temperate parts of Central Asia being, as inaccessible, ill adapted for pean settlements), eighty per cent. is calculated to belong to the Anglo-Saxon race; and while the colonies of English-speaking race have welcomed industrious men of all nationalities, tongues, and religious and political positions, the colonial institutions, even where they most widely in their administration from those of England, bear an unmistakable English stamp, and have been instinctively moulded by an English spirit.

See Heeren, *Geschichte d. Europ. Staatensysteme u. Colonien*, 1809; H. Merivale, *Lectures on Colonization of Colonies*, 1839-41, new edition, 1861; Arthur Mills, *Constitutions*, 1856; Sir E. Creasy, *Imperial and Colonial Constitution of the Britannic Empire*, 1872; W. E. Forster, *Colonial Empire*, 1875.

The following table, which is based on the latest returns, estimates, indicates the extent and population of the colonies and possessions of the various European countries, but does not include any colony that was settled before the 15th century.

## GREAT BRITAIN.

	Area. Eng. sq. miles.	Population
<i>Europe</i> —		
Heligoland (German coast).....	5	2,000
Gibraltar (Spain).....	2	15,000
Malta, &c. (Mediterranean)....	115	150,000
<i>N. America</i> —		
Dominion of Canada.....	3,500,000	4,000,000
Newfoundland.....	40,000	161,000
Bermudas.....	24	12,000
West India Islands, various.....	14,000	1,250,000
Honduras (Central America)...	13,500	25,000
<i>S. America</i> —		
Guiana.....	76,000	194,000
Falkland Islands.....	6,500	800
<i>Africa</i> —		
Ascension and St. Helena.....	80	6,300
West Coast Settlements.....	17,000	578,000
Cape Colony.....	230,000	1,110,000
Natal.....	11,200	290,000
Mauritius, &c.....	708	316,000
<i>Asia</i> —		
Aden and Perim.....	12	26,000
India.....	938,360	191,300,000
Ceylon.....	25,740	2,406,000
Straits Settlements.....	1,210	308,000
Labuan (Borneo).....	45	4,900
Hong Kong (China).....	52	120,000
<i>Australasia</i> —		
Australia.....	3,000,000	1,725,000
Tasmania.....	26,215	105,000
New Zealand.....	106,250	345,000
<i>Oceania</i> —		
Fiji.....	8,030	85,000
	<u>8,015,028</u>	<u>204,535,000</u>

## FRANCE.

<i>America</i> —		
St. Pierre and Miquelon (Newfoundland).....	81	5,000
Martinique, Guadeloupe, &c. (West Indies).....	1,093	315,000
Guiana (South America).....	47,000	25,000
<i>Africa</i> —		
Algeria.....	150,500	2,150,000
Coast of Senegambia.....	10,000	200,000
Coast of Guinea.....	7,750	180,000
Mayotte Island and Madagascar Settlements.....	270	28,500
Réunion (Indian Ocean).....	970	194,000
<i>Asia</i> —		
Pondicherry, &c. (India).....	200	266,000
Cochin China.....	21,700	1,486,000
<i>Oceania</i> —		
New Caledonia and Loyalty Islands.....	7,600	60,000
Marquesas.....	478	10,000
	<u>247,642</u>	<u>4,919,500</u>

## SPAIN.

<i>America</i> —		
Cuba and Porto Rico (West Indies).....	49,500	2,250,000
Carry forward.....	49,500	2,250,000







	Area. Sq. miles.	Population.
Brought forward....	49,500	2,250,000
<b>Africa—</b>		
Coats, Tetuan, &c. (Morocco).....	3	33,000
Canary Islands.....	3,250	237,000
Coast of Guinea.....	850	30,000
<b>Asia—</b>		
Philippines (Eastern Archipelago).....	65,800	6,000,000
<b>Oceania—</b>		
Caroline, Pelew, and Marion Islands.....	1,300	34,000
	<u>120,703</u>	<u>8,584,000</u>
<b>PORTUGAL.</b>		
<b>Europe—</b>		
Azores.....	1,000	250,000
<b>Africa—</b>		
Madeira.....	320	115,000
Cape Verd Islands.....	1,500	70,000
Coasts of Senegambia and Guinea.....	500	33,000
Angola.....	300,000	2,000,000
Mozambique, &c. (East Coast)	380,000	300,000
<b>Asia—</b>		
Goa, &c. (India).....	1,610	528,000
Timor, &c. (Eastern Archipelago).....	9,520	200,000
Macao (China).....	1	72,000
	<u>690,451</u>	<u>3,618,000</u>
<b>HOLLAND.</b>		
<b>America—</b>		
Curacao, &c. (West Indies).....	436	40,000
Guiana (S. America).....	66,000	70,000
<b>Asia—</b>		
Java and other islands (Eastern Archipelago).....	615,000	24,000,000
	<u>681,436</u>	<u>24,110,000</u>
<b>DENMARK.</b>		
<b>Greenland—</b>		
Coast Settlements.....	34,000	9,800
<b>America—</b>		
St. Thomas, &c. (West Indies)	140	37,700
	<u>34,140</u>	<u>47,500</u>
<b>SWEDEN.</b>		
<b>America—</b>		
St. Bartholomew (West Indies) <sup>1</sup> (Ceded to France 1873.)	8	2,900

may be divided into a mountain district, a hill district, and a plain district. The principal range of these mountains bears the name of the Sawatch Range. It consists of a solid mass of granite, has an average elevation of 13,500 feet, presents a broad and massive outline, and has a mean breadth of from fifteen to twenty miles. It is really a prolongation of the Sierra Madre of Mexico, and up to about 40° N. lat. it forms the dividing line between the Atlantic and the Pacific versants. Beginning at the south we have the following peaks:—Mount Bowles, 14,106 feet; twelve miles northward, Mount Howard, 14,208; eleven miles to the north-east, La Plata Mount, 14,126; seven miles from La Plata, Grizzly Peak, 13,786, and Mount Elbert, 14,150; and six miles from Mount Elbert, Massive Mountain, 14,192. For about eighteen miles north of this last elevation the range is comparatively low, but it rises again in the great terminal peak of the Holy Cross, which attains a height of 13,478 feet, and owes its name to the figure emblazoned on its summit by the white lines of its snow-filled ravines. Second only in importance to the Sawatch range are the Elk Mountains, which strike off from it in a south-west direction, and extend for a distance of upwards of thirty miles. They are geologically interesting for the almost unexampled displacement of the strata of which they are composed, and the apparent confusion which has thence arisen. Among the most remarkable of its separate summits are Italian Mountain, 13,431 feet in height, so called because it displays the red, white, and green of the Italian national colors; Whiterock Mountain, 13,847 feet; Teocalli Mountain, 13,274; Crested Butte, 12,014; Gothic Mountain, 12,491; Snow Mass, 13,961; Maroon Mountain, 14,000; Castlepeak, 14,106; Capitol, 13,992, and Sopris Peak, 12,972. Of less importance, but still distinct and well defined, are the Wet Mountains in the south-east, the Raton Mountains in the south, and the Uncompahgre Mountains in the south-west. The eastern series of elevations which abut on the region of the plains are known as the Front Range, and present a fine bold outline, broken by several peaks of about 14,000 feet or upwards in height. One of the most remarkable features of the orography of Colorado is the unusual development of its upland valleys, or "parks," to use the term that has become distinctively their own. The four most extensive are known respectively as the North, the Middle, the South, and the San Luis; the last is by far the finest of the four. They stretch almost in a line from the southern to the northern boundary of the State, just on the western side of the Front Range, and occupy an average breadth of 50 miles. The San Luis Park is, as it were, an "immense elliptical bowl" with an area of 9400 square miles, bounded on the E. by the Wet Mountains and the Sangre de Cristo range, and on the W. by the Sierra de San Juan, which is part of the great Sierra Miembres. Its surface is nearly as flat as a lake, and it almost certainly was at one time the bed of a great inland sea. The centre of the northern part, which bears the distinctive title of the Rincon, is still occupied by a considerable sheet of water, fed by nineteen mountain streams, and accustomed in the winter to overflow a large stretch of the neighboring savannah. The southern part, which continues onwards into New Mexico, is traversed by the Rio del Norte and several of its tributaries.

*Rivers.*—Of the rivers of the Atlantic versant, the most important are the South Platte, the Arkansas, and the Rio Grande del Norte; those of the Pacific are all members of the great Colorado River. The South Platte has its head waters in Buckskin Mountain, and its earlier tributaries flow from the slopes of the northern part of the Front Range. At its source at Montgomery it has a height above the sea of 11,176 feet; at its exit from the upper cañon it is still 7623, but by the time it reaches Denver it is only 5176. The Arkansas rises in the same district, at a height of 10,176 above the sea, in Tennessee Pass, but as it leaves Chalk Creek has come down to 7877. In the upper part of its course it passes through a cañon from 1000 to 1500 feet in depth. The Rio Grande del Norte has its head waters in the Sawatch range and the Sangre de Cristo range, and flows south through the valley San Luis Park. The river which gives its name to the State belongs to the territory only by some of its most important tributaries, of which it is sufficient to mention the Bear River, and the Gunnison and Grand River, which unite before they pass into the territory of Utah. The numerous

COLOPHON, an ancient city of Asia Minor, situated a short distance from the coast, and about eight miles north of Ephesus. It was founded by the Ionians, but did not take part in the great political festival of the Apaturia. The principal facts in its history are its capture by the Persians and its depopulation by Lysimachus. At a later date the name was not unfrequently applied to the contiguous city of Notium, which continued to flourish till the time of Cicero at least. The site of Colophon is easily determined, but there are hardly any traces of its buildings. It claimed to be the birthplace of Homer, and, besides various lesser names, it numbered among its celebrities Mimnermus the elegiac poet, and Nicander the author of the *Theriaca*. Its name was given to a resin obtained from the pines on the neighboring Mount Galleus, and is still recognizable in "colophony," and in the French *colophane*. The ancient proverb, *τὸν Κολοφῶνα ἐπέθηκεν* (he has put the Colophon to the matter), has likewise left its trace in the modern languages, and more particularly in the vocabulary of bibliography, where the word "colophon" is employed to designate the concluding lines of early printed works, containing the title, date, &c. The adage is said to have arisen either from the decisive influence of the Colophonian cavalry in a contest, or from the fact that the citizens had the casting vote in the great Ionian assembly.

**COLOR.** See **LIGHT** and **OPTICS**.  
**COLORADO**, one of the United States of North America. Boundaries: N., Wyoming and Nebraska; E., Nebraska and Kansas; S., the Indian Territory and New Mexico; and W., Utah. Latitude, between 37° and 41° N.; longitude, from 102° to 109° W. Breadth N. to S. about 280 miles, length E. to W. about 380. Area estimated at 106,500 square miles, or 68,160,000 acres. Population, 120,000.  
*Mountains.*—This territory is traversed from north to south by the great continental chain of the Rocky Mountains, and according to its orographical configuration

minor "creeks" which feed the main streams must not be forgotten in forming an idea of the main features of the country.

**Minerals.**—Colorado is pre-eminently a mineral district, and to this fact it owes its colonization. It possesses extensive deposits of gold and silver ore, and between the years 1859 and 1872 it furnished to the United States mint upwards of \$20,000,000 worth of the former metal and \$1,114,542 of the latter. Iron is pretty widely diffused, and zinc and copper occur in many of the mines. Coal is also found extensively on both sides of the main range of mountains; the area occupied by the Tertiary deposits being no less than 7200 square miles, and the annual yield about 200,000 tons. The mining districts are five in number, and are distinguished as the district of the northern mines, the mines of the eastern base, the Conejos county mines, the southern mines, and the mines of Summit County. At Murphy's mine, about twelve miles from Denver, the stratum is about 16 feet thick, and the percentage of fixed carbon is found to be 65.31.

The *climate* of Colorado is remarkable for its regularity and salubrity. During the day the thermometer not unfrequently rises to 90° in summer, but the nights are always cool and dewless. In winter the weather is generally mild,—the lowest thermometric marking being only 7° below zero, in Middle Park 15°, and in Denver 13°. Snow often lies deep in the higher inhabited districts, but in the lowlands it is never more than 10 or 12 inches, and it disappears again almost immediately. All through the year the atmosphere is so dry and light that butcher meat can be preserved by the simplest process of desiccation. Between July and October there is very little rain, day after day bringing a bright and cloudless sky. "An air more delicious to breathe," says Bayard Taylor, "cannot anywhere be found; it is neither too sedative nor too exciting, but has that pure, sweet, flexible quality which seems to support all one's happiest and healthiest moods." For asthmatic and consumptive patients it exercises a restorative influence which cannot be disputed; and the State consequently promises to become an extensive sanatorium for the eastern districts of the continent. The only flaw in the climate of Colorado is its violent storms of wind, and in some parts of the country heavy falls of hail. It would seem, however, that the humidity is on the increase; and whatever be its cause, the change is quite perceptible since the colonization of the territory. The Cache à la Poudre, for instance, is said to be yearly increasing in volume, and streams which formerly dried up in the summer now maintain a continuous flow. Among the secondary hygienic advantages of which Colorado can boast, the mineral wells hold an important place. They occur in various parts of the country, and belong to different classes. Chalybeate waters are found at Manitou, Carlisle, and Red Creek; soda springs at Manitou, Trinidad, and Cañon City; sulphur springs at Fairplay, on the Navajo River, and at Idaho springs; and thermal springs, partly sulphur and partly soda, exist at Pagosa, in the Middle Park, in Segunche County, at Wagon Wheel Gap, and at Del Norte. Manitou is already becoming a fashionable watering-place; the fountains and the surrounding land were purchased by a company in 1870; and in 1873 there were already six large hotels and numerous private residences erected round the spot. In the lowland districts water for drinking is very scarce; but supplies can frequently be obtained by the sinking of Artesian wells.

**Vegetation.**—The mountains of Colorado were, till a comparatively recent date, richly clothed with forest; but owing partly to natural causes, and still more to the lavish consumption and reckless destruction of the early settlers, the quantity of growing timber in the State is exceedingly small, and before long, if restorative measures are not adopted, the Colorado demand for wood will require to be supplied from without. Whole mountain sides often present the appearance of monstrous chevaux-de-frise, the dead trunks of the wind-thrown pines being tossed about in all directions. The principal trees, after the pine, are the so-called hemlock and cedar, the cotton wood, and the aspen (or *Populus tremuloides*). The minor flora of the country is exceedingly rich; and especially in the plain region the abundance of flowers is amazing. "The color of the landscape," says Dilke, "is in summer green and flowers; in fall time yellow and flowers; but flowers over."

**Agriculture.**—Wherever irrigation can be obtained the soil of eastern Colorado is well fitted for agriculture. Wheat, oats, and barley afford heavy crops; potatoes succeed except in the extreme south, and owing to the dryness of the atmosphere are easily kept; onions vie in size and flavor with any in the continent; beans might be grown more extensively, but they suffer from the attacks of a small insect, possibly a species of *Haltica*; and almost all the garden products of the same latitude in Europe can be satisfactorily cultivated. The wheat affords a very white dry flour, and competes with the finest in the markets of the world. The yield often reaches forty or fifty bushels per acre, and in exceptional cases considerably exceeds this amount. In the higher districts—the parks and the mountain-valleys—a greater proportion of ground is devoted to pasture either of sheep or cattle. The native grasses are of excellent quality as fodder; and during the winter the natural hay that has withered where it grew is preferred by the cattle to the best that can be furnished by the labors of the husbandman. In certain districts the pastoral departments of husbandry have had to be abandoned, owing to the presence of poisonous plants, the most important of which seems to be *Oxytropis Lambertii*; but these districts are of very limited extent. The cost of pasturing is merely nominal, as the cattle can be driven over extensive districts, under the charge of Mexican or Indian herdsmen. Wool can be produced for ten cents per lb., and a four-year-old steer for ten dollars. The chief plague of the agriculturist is the locust, or grasshopper as it is called in America. This insect is usually hatched in the month of June, when the cereals are well advanced; but occasionally in dryer and warmer seasons it appears as early as April and does great damage to the young crops. Another insect, the *Doryphora decemlineata*, popularly known as the Colorado Beetle (see p. 121 of the present volume), has recently become famous for its attacks on the potato, not only in this State but as far east as the Atlantic States. It appears formerly to have fed on the *Solanum rostratum*, but to have found the new tuber a better habitat.

**History.**—Recent explorations have shown that the western parts, at least, of the Colorado territory were at one time inhabited by a native American race of considerable civilization, who were perhaps connected or even identical with the Moquis of the regions further south. The first important European mission was that of Vasquez Coronado, despatched from Mexico in 1540. In 1821 the Rocky Mountains were visited by S. H. Long, the American engineer; and part of the northern district was pretty fully explored by Captain J. C. Fremont during the great expedition of 1843. It was not till 1858 that the Indian tribes were disturbed in their sparsely-peopled hunting grounds; but in that year the discovery of gold by W. G. Russell, a Georgian, on the banks of the River Platte, near the present city of Denver, attracted general attention, and bands of pioneers poured in from Kansas, Nebraska, and Missouri. During 1860, 1861, and 1862, there was a continuous stream of immigration; Denver, Black Hawk, Golden City, Central City, Mount Vernon, and Nevada City were all founded in 1859; next year saw the rise of Breckenridge, Empire, and Gold Hill; George Town and Mill City were added in 1861, and Ward District was settled in 1862. In 1861 the region was organized as a territory in accordance with the wish of the inhabitants, who had held a convention at Denver in 1859; its area was declared to include 47,657,000 acres previously assigned to the territories of Utah and Kansas, 10,262,400 from that of Nebraska, and 8,960,000 from New Mexico, making a total of 66,880,000. The first governor was William Gilpin, a Pennsylvanian by birth and a Quaker in religion, who has done a great deal for the development of the territory, and was the originator of the scheme by which it was made to include part of both slopes of the Sierra. From 1862 to 1865 the natural progress of immigrational movement was checked, partly by the great national struggle, and partly by the local Indian war which broke out in 1864, and for a time rendered the routes extremely unsafe, and even threatened the existence of the new settlements. Many of the sites, indeed, were deserted, and large numbers of the miners left the country. In this way Empire greatly decayed, and Gold Dirt and Baker-ville absolutely disappeared. Happily it was only the Indians of the plains who took part in the attacks, and though they numbered from 10,000 to 15,000, they were quickly quelled. In 1865 the immigration again flowed on;

and it was found that at the census of 1870 the population was 39,864 citizens, distributed into 9358 families, and inhabiting 10,009 houses. The proportion of males to females was 24,820 to 15,044. Since that date the population has very rapidly increased, and it was estimated at 120,000 in 1874. Colorado was received into the Union as a State in 1876.

See Fremont, *Narrative of Exploring Expedition*, 1846; Capt. Stansbury, *Expedition to the Valley of the Great Salt Lake*, 1852; Edward Bliss, *The Gold Mines of Colorado*; Hollister, *Flying Trip to the Silver Mines of Colorado*; Bayard Taylor, *A Summer Trip to Colorado*, 1867; Bowles, *Summer Vacations in the Parks and Mountains of Colorado*, 1869; W. Blackmore, *Colorado: its Resources and Prospects*, 1869; Greatorex, *Summer Etchings in Colorado*, 1874; Porter and Coulter, *Synopsis of the Flora of Colorado*, 1874; and as the main source of all topographical, geological, and botanical details regarding the State, the *Reports of the United States Geological and Geographical Survey*, which have been published from time to time by the Government.

**COLORADO RIVER**, or **RIO COLORADO**, a large river of North America, which rises in the Rocky Mountains and falls into the Gulf of California. The main stream, known as the Green River, has its source in Fremont's Peak on the western borders of Wyoming, so that the whole extent of its course must be upwards of 2000 miles. After receiving the waters of the Yampuh and the White River it flows south for about 150 miles without any important augmentation till it meets with the great rival stream of the Grand River, which by means of its numerous confluent drains so large a portion of the western versant in the State of Colorado. The united stream continues to force its way south, till at its junction with the Colorado Chiquito, or Little Colorado, which takes its rise in the Sierra Madre of New Mexico, it turns almost due west, and cuts right athwart the line of the mountain ranges. Its southern direction is resumed after the confluence of the Virgen from the Wahsatch Mountains, and it only receives one other tributary of real magnitude, the River Gila, before it reaches the sea. The enormous cañons or ravines through which the Colorado and several of its confluent force their way, render this one of the most remarkable river systems of the world. The Grand Cañon alone extends for a distance of about 200 miles westward from the junction of the Colorado Chiquito, and its walls rise almost sheer from the water's edge to a height of from 4000 to as much as 7000 feet. Further down is Black Cañon which, with a length of 25 miles and a height of 1000 or 1500 feet, would be considered a magnificent phenomenon, were it not so completely thrown into insignificance by its more stupendous neighbor. These very features which give the river its uniqueness prevent it from being of much use as a means of navigation; but steamers can proceed upwards as far as Callville, about 612 miles from the mouth.

The discovery of the Colorado is due to Fernando Alascon in 1540; but it was not till Lieutenant Ives's expedition in 1857 that even the lower part of its course was properly explored. The mysteries of the Great Cañon were first invaded by an unlucky "prospector" James White, who along with a companion thought it safer to trust himself to the river than to the Indians. In 1869 the whole course from the head-waters in Wyoming to the town of Callville was traversed by a party of explorers, commissioned by the United States Government and commanded by Professor J. W. Powell. Since that date the river and its basin have been the object of systematic survey under the same auspices, and the results of the gigantic undertaking have been published by Professor Powell in his *Exploration of the Colorado River of the West and its Tributaries, explored in 1869, 1870, 1871, and 1872* (Washington, 1875).

**COLOSSÆ**, a once large and important city of Asia Minor, in Phrygia Major, on the Lycus, a branch of the Mæander. The notices of Colossæ in ancient history are few and brief. Xerxes passed through it on his way to Greece, 481 B.C., and at the close of the same century it was visited by Cyrus the younger. It is described by Xenophon in the *Anabasis* as being at that period a large and flourishing city. Like Laodicea, and other cities in that part of Phrygia, Colossæ carried on an extensive trade in wool, and derived a large revenue from the skill of its inhabitants in dyeing that article. After the time of Cyrus the city seems to have gradually decayed, till in the Middle Ages it disappeared altogether. Near its ruins

there sprang up another town called Chonse, the birthplace of the Byzantine historian, Nicetas Choniates, now represented by the town of Khonas. Excavations made in the neighborhood of this place have brought to light the ruins of a large city, which is believed, with good reason, to be Colossæ. The Epistle to the Colossians (see below) is addressed to the inhabitants of this city, in which one of the earliest of the Christian churches in Asia was planted.

**COLOSSEUM**. See **AMPHITHEATRE**, vol. i. p. 679; **ARCHITECTURE**, vol. ii. p. 367; and **ROME**.

**COLOSSIANS**, THE **EPISTLE TO THE**, belongs to the third of the four groups under which the Pauline epistles may be chronologically arranged,—a group which occupies a midway position between the letters sent to Corinth, Galatia, and Rome, in the apostle's third missionary journey, and the letters known as the Pastoral Epistles. By similarity of language and matter the epistle to the Colossians is intimately connected with that to the Ephesians; and the notices of St. Paul's companions, and of Onesimus and Archippus, which occur in the epistle to Philemon, show that this last epistle was also written and sent at the same time as the other two. The epistle to the Philippians belongs to the same group, and the most probable view is that it was from Rome that all four were written by Paul, "the prisoner of Jesus Christ" (comp. Philem. 1; Col. iv. 10, 18; Eph. iii. 1, iv. 1, vi. 20; Phil. i. 13, 14, iv. 22). Some critics—among whom may be mentioned Schulz, Böttger, Thiersch, Meyer, and Reuss, whose opinion is strongly advocated by De Pressensé in his *Histoire des Trois Premiers Siècles*—contend that at least three of the epistles were written from Cæsarea; but the traditional view that all four were written from Rome is supported by most modern writers, and is free from difficulties. The date of the epistle to the Colossians may be placed about 62 or 63 A.D. Assuming for the present its genuineness, we may gather from the contents of the epistle itself its occasion and object. Epaphras, who is spoken of in high terms by the apostle, and may with some probability be considered the founder of the church at Colossæ (i. 7), has brought tidings to St. Paul which make him anxious concerning the Christians in Colossæ and its neighborhood (ii. 1, iv. 13). False teachers are there endeavoring to beguile them with plausible talk (ii. 4), and Paul, as a minister of the gospel earnestly laboring in the cause of proclaiming Christ to the nations (i. 24–29), feels his heart called out towards those whose faith is being insidiously assailed, although he is absent from them, and has never personally visited Colossæ or Laodicea (ii. 1). He accordingly writes an epistle the polemical purport of which is patent. Paul's polemic, however, is no mere negative protest. He sets up, as against the "false philosophy" which he so strenuously repudiates (ii. 8), a "theological conception of the person of Christ," which strikes at the root of all vain speculations concerning the unseen world, and shows that the work of reconciliation effected by Christ is complete, so that in Him Christians are to see the one Mediator through whom God is to be known, approached, served. The latter part of the epistle consists of various practical exhortations, both general and specific; and it closes with several notices of a personal character. Tychicus was the bearer of this letter (iv. 7), as he was also of that known as the epistle to the Ephesians, which by some critics is identified with "the letter from Laodicea" (iv. 16).

But are these letters genuine? There is no historical ground for doubting the Pauline authorship, or for the theory which has been advanced that the two epistles are inventions of a later age, or for the supposition that, whilst one of them is genuine, the other is made up of materials derived from that one which was really written by St. Paul. The fact that opponents of the genuineness of the letters do not agree as to which was the original is significant. Mayerhoff thinks, indeed, both epistles to be spurious, but considers that the epistle to the Colossians was compiled from that to the Ephesians; while De Wette holds the epistle to the Ephesians to be a "verbose enlargement" of that to the Colossians, and advocates the genuineness of the latter. The opponents of the Pauline authorship rest mainly on three lines of argument, *viz.*, the similarity of the two epistles, the peculiarity of their contents, and peculiarities of style.

The objection founded on the similarity of the language and matter of the two epistles is one that cannot be sub-

stantiated. For whilst there are striking resemblances, there are no less striking differences; and whilst the resemblances can be very naturally accounted for by the contemporaneousness of the letters, the differences are so markedly in accordance with the apparent designs of the separate letters,—that to the Colossians being primarily polemic, and that to the Ephesians being of a mystic and devotional character,—that we may fairly use of each epistle the words applied by Meyer to the epistle to the Colossians,—“The supposed forgery of such an epistle would be far more marvellous and inexplicable than its genuineness.”

Another objection brought forward is that in these epistles we have sentiments that savor of heresies later than the apostolic age. This objection seems to be based upon very superficial grounds, and to spring from prejudice rather than from research. What definite ground is there for asserting that “Gnostic and Montanist” sentiments are to be found in these epistles? While certain false teachings and tendencies are alluded to, which evidently go beyond the more naked Pharisaic Judaism controverted in the epistle to the Galatians, nothing can be produced to show that the heretical teaching animadverted upon in the epistle to the Colossians, or even in the later epistles of Paul to Timothy and Titus, is *Gnosticism* in the sense in which that term is applied to later systematic theosophies and cosmologies, such as those of Basilides and Valentinus. And would it not be natural, as Neander points out, to postulate, even if we had no records to testify to the fact, the existence of certain transitional links between the *gnosis* of the 2d century and the earlier stages of the apostolic preaching? Such links are found in the *incipient* Gnosticism, if so it is to be called, of which we have traces in the epistles of the imprisonment and the subsequent Pastoral Epistles.

A third objection has been made to the genuineness of the epistle to the Colossians, as well as to the Ephesian epistle, on the ground of the peculiarity of their style and of certain terms used in them, some of which are asserted to be technical terms, as *aeon*, *pleroma*, &c., and others are words not elsewhere used in the Pauline writings. The answer to this objection is that the peculiar terms are not used in the sense which they acquired in heretical writings of a later period, and that the unusual words are to be attributed partly to the nature of the subject and partly to the disposition of the writer's mind at the time. If, indeed, we are to condemn any writing of an author for containing peculiarities not exhibited in other writings of the same author, the questions arise, whence are we to take our standard of judgment, or how are we to know in what cases we should apply so vague a critical canon? Bleek says, sensibly enough, in view of this line of objection, “We do not for a moment deny that the epistle to the Colossians contains much which is peculiar to itself; but its contents, such as they are, do not tell against its coming from the same author as the other epistles of St. Paul, for even those which Baur allows to be genuine contain much that is distinctive and peculiar, e.g., the Galatians as compared with the Corinthians, and 2 Corinthians as compared with 1 Corinthians.” The fact is that in the Tübingen school “subjective criticism” has run to riot. The phenomena to be investigated are interpreted according to a preconceived theory, rather than fairly looked at, examined, and explained. The testimony of the early church to the Colossian and Ephesian letters is unexceptionable. In the case of the epistle to the Colossians, there are indications of its recognition in allusions by Justin Martyr and Theophilus of Antioch; it occurs in the Muratorian canon (circ. 170 A.D.); it is cited by Irenæus, Clement of Alexandria, Tertullian, and Origen; Eusebius places it among the “acknowledged” books of the apostolical writings; and it occurs in Marcion's list, as given by Epiphanius. Nor is there anything in the epistle itself that is out of accordance with the circumstances of the apostle Paul, or the condition of the Asiatic churches in the seventh decade of the 1st century.

We must now briefly notice the character of the teaching against which St. Paul directed the controversial portion of the epistle to the Colossians (ii. 4-23). His warnings are against a philosophy which is vain and fallacious; against a system of multiplied religious observances and distinctions of meats; against an arbitrary system of angel-worship; and against certain rigorous rules of asceticism.

The basis of this alien teaching was unmistakably Jewish, but the Judaizing effort was of a mystic and ascetic type; and it is not unreasonable to see in the theosophical speculations and ascetic ordinances, indicated in St. Paul's picture of the dangers which beset the Colossian Christians, an admixture of Jewish and Oriental elements. Professor Lightfoot has shown that Oriental notions concerning the evil of matter and the need of rigid abstinence, together with “an esoteric doctrine relating to angelic beings,” and a tendency to sun worship, appear in Essenism, which he suggests might be called Gnostic Judaism. The Essene side of Judaism was doubtless represented among the Jews who were settled in, or journeyed to or from, various places in Asia Minor; and all mystic and ascetic ideas would find a congenial soil in Phrygia. The teaching and tendencies alluded to in the epistle to the Colossians, and subsequently in the Pastoral Epistles, form the intermediate link between the “Gnostic Judaism” of the Essenes and teachers allied to them and the “Judaizing Gnosticism” of the 2d century.

The question whether Paul himself planted the church at Colossæ is one of minor importance, which has been much discussed by commentators. Lardner argues elaborately in favor of a visit by Paul to Colossæ and Laodicea. He bases his views upon a passage cited from Theodoret, in which ch. ii. 1 is interpreted so as to distinguish between the Colossians and Laodiceans on the one side and the “as many as had not seen Paul's face” on the other. This view has been controverted in detail by Davidson, but is advocated by Wordsworth. Bleek mentions Schulz, Wiggers, and others as following Theodoret, but he takes the contrary view himself, as do also Alford, Conybeare and Howson, and Lightfoot. The last-named commentator says that Theodoret's interpretation is “opposed alike to grammatical and logical considerations.”

Another disputable though not very important point is whether the Ephesian or the Colossian letter was written first. Critics are divided, and it is somewhat difficult to gather from a comparison of the epistles which view is most probable. We are inclined to favor the view that the briefer, more controversial, and in some respects more vigorous letter was written first, and was followed by the fuller and more mystic one. It has been said that this epistle is characterized by a “ruggedness of expression and want of finish that borders on obscurity” (Lightfoot), and it has been suggested that the absence of personal connection on St. Paul's part with the Colossian church might partially account for “the diminished fluency of this letter,” as compared with other and earlier ones. We do not think this explanation a satisfactory one. The “ruggedness” should rather be attributed to the intensity of feeling wherewith the apostle, confined as he was in his far-off place of imprisonment, threw himself into the controversy with the false teachers,—persons whom he must have regarded as among the “grievous wolves,” of whom he had forewarned the elders at Miletus some few years previously (Acts xx. 29, 30), men who should “arise out of the Christian community itself, and speak perverse things to draw men after them.” This explanation is somewhat corroborated by what Alford points out, viz., that the majority of peculiar expressions in the epistle occur in the second chapter. And Professor Lightfoot himself adds—“No epistle of St. Paul is more vigorous in conception or more instinct with meaning. It is the very compression of thought which creates the difficulty. If there is a want of fluency there is no want of force. Feebleness is the last charge which can be brought against this epistle.”

The value of this epistle to the church historian, to the Christian theologian, and to any one who wishes fairly to estimate the “philosophic” bearings of Christian dogma is very great. A commentator of the 17th century, H. Suicer, mentioned by Walch in his *Bibliotheca Theologica*, calls the epistle to the Colossians *theologic Christianum compendium*.

Authorities for what has been said, and references to further literature upon the subject, may be found in “Introductions,” such as those by Davidson and Bleek, and in “Prolegomena” of commentators, e.g., Alford, Wordsworth, and Braune in Lange's *Bibelwerk*, a treasury of information made accessible to English readers in Dr Schaff's edition, published by T. & T. Clark. Frequent reference has been made in the course of this article to the

recent very valuable commentary of Professor Lightfoot. In addition to the exegetical notes, he gives us thorough dissertations on "the churches of the Lycus," the "Colossian heresy," and "the Essenes." There is also a digest of the principal various readings, containing an ingenious conjecture as to the original reading in chap. ii. 18. Attention is drawn to the fact that the epistles to the Ephesians and the Colossians, alone among the Pauline epistles, are exposed to those "harmonizing tendencies" in transcribers which have had such an influence on the text of the gospels. Professor Lightfoot deals, also, in a most exhaustive manner, with the subject of the apocryphal letter to the Laodiceans (connected with Col. iv. 16), which appears in a considerable number of MSS. of the New Testament, and shows it to be "a cento of Pauline phrases strung together without any definite connection or any clear object." Paley, in his *Horæ Paulinæ*, has a very satisfactory section on the similarity of the epistles to the Ephesians and the Colossians. On the character of the heretical tendencies in Asia Minor the general reader will find all requisite information in Neander, *History of the Planting, &c., of Christianity*, and Pressensé, *Histoire des Trois Premières Siècles de l'Église Chrétienne*. Mansel, in his *Gnostic Heresies*, has a chapter devoted to Notices of Gnosticism in the New Testament. Both Neander and Pressensé draw attention to the arbitrary and unsound theorizing of the Tübingen School in respect to the group to which the epistle to the Colossians belongs.

(w. s. s.)

COLOSSUS, in antiquity, a term applied generally to statues of great size, and in particular to the bronze statue of Helios, in Rhodes, which for its size came to be reckoned among the wonders of the world. It was made from the spoils left by Demetrius Poliorcetes when he raised the prolonged siege of Rhodes. The sculptor was Chares, a native of Lindus, and of the school of Lysippus, under whose influence the art of sculpture was led to the production of colossal figures by preference. The work occupied him twelve years, it is said, and the finished statue stood 70 cubits high. It stood near the harbor (*ἐπὶ λιμένι*), but at what point is not certain. When, and from what grounds, the belief arose that it had stood across the entrance to the harbor, with a beacon light in its hand and ships passing between its legs, is not known, but the belief was current as early as the 16th century. M. Bendorff has recently endeavored to trace it to a mistaken reading of a Greek epigram on the Colossus, and his conjecture seems probable (*Mittheilungen des deutschen Instituts in Athen*, part 1, page 45). The statue was thrown down by an earthquake about the year 224 B. C., that is, about 56 years after its erection. Then, after lying broken for nearly 1000 years, it is said, the pieces were bought by a Jew, and probably reconverted into instruments of war.

COLSTON, EDWARD (1639–1721), was the son of William Colston, a Bristol merchant of good position. He is generally understood to have spent some years of his youth and manhood as a factor in Spain, with which country his family was long connected commercially, and whence, by means of a trade in wines and oil, great part of his own vast fortune was to come. On his return he seems to have settled in London, and to have bent himself resolutely to the task of making money. In 1681, the date of his father's decease, he appears as a governor of Christ's Hospital, to which noble foundation he afterwards gave frequently and largely. In the same year he probably began to take an active interest in the affairs of Bristol, where he is found about this time embarked in a sugar-refinery; and during the remainder of his life he seems to have divided his attention pretty equally between the city of his birth and that of his adoption. In 1682 he appears in the records of the great western port as advancing a sum of £1800 to its needy corporation; in 1683 as "a free burgess and *meire* (St. Kitts) merchant" he was made a member of the Merchant's Hall; and in 1684 he was appointed one of a committee for managing the affairs of Clifton. In 1685 he again appears as the city's creditor for about £2000, repayment of which he is found insisting on in 1686. In 1689 he was chosen auditor by the Vestry at Mortlake, where he was residing in an old house once the abode of Ireton and Cromwell. In 1691, on St. Michael's Hill, Bristol, at a cost of £8000, he founded an almshouse for the reception of 24 poor men and women, and endowed

with accommodation for "Six Saylor's," at a cost of £600, the Merchant's Almshouses in King street. In 1696, at a cost of £8000, he endowed a foundation for clothing and teaching 40 boys (the books employed were to have in them "no tincture of Whiggism"); and six years afterwards he expended a further sum of £1500 in rebuilding the school-house. In 1703, at a cost of £41,200, he built and endowed his great foundation on Saint Augustine's Back, for the instruction, clothing, maintaining, and apprenticing of 100 boys; and in time of scarcity, during this and next year, he transmitted "by a private hand" some £20,000 to the London committee. In 1710, after a poll of four days, he was sent to Parliament, to represent, on strictest Tory principles, his native city of Bristol; and in 1713, after three years of silent political life, he resigned this charge. He died in 1721, having nearly completed his eighty-fifth year; his remains were conveyed, with all the funereal magnificence his own solemn fastidiousness could suggest, from his house at Mortlake to Bristol, where he was buried in All Saints' Church. Colston, who was in the habit of bestowing large sums yearly for the release of poor debtors and the relief of indigent age and sickness, and who gave (1711) no less than £6000 to increase Queen Anne's Bounty Fund for the augmentation of small livings, was always keenly interested in the organization and management of his foundations; the rules and regulations were all drawn up by his hand, and the minutest details of their constitution and economy were dictated by him. A high churchman and Tory, with a genuine intolerance of dissent and dissenters, his name and example have served as excuses for the formation of several politic benevolent societies—the "Anchor," the "Dolphin," the "Grateful,"—whose rivalry has been perhaps as instrumental in keeping their patron's memory green as have the splendid charities with which he enriched his native city. See Garrard, *Edward Colston, the Philanthropist*, 4to, Bristol, 1852; and Pryce, *A Popular History of Bristol*, 1861.

COLT, SAMUEL (1814–1862), the inventor of the revolver, was born at Hartford, Connecticut, where his father possessed a manufactory of silks and woollens. At ten years old he left school for the factory, and at fourteen he made a runaway voyage to India, during which he made a wooden model, yet existing, of what was afterwards to be the revolver. On his return he learned chemistry from his father's bleaching and dyeing manager, and travelled over the United States and Canada, lecturing on that science. The profits of two years of this work enabled him to continue his researches and experiments. In 1835 he visited Europe, and patented his inventions in London and Paris, securing the American right on his return; and the same year he founded the Patent Arms Company, for the manufacture of his revolvers only. The scheme did not succeed; some use was indeed made of the arms, but they were not generally appreciated, and in 1842 the company became insolvent. No revolvers were made for five years, and none were to be had when Taylor sent from Mexico for a supply. The Government ordered 1000 from the inventor, but before these could be produced he had to construct a new model, for a pistol of the company's make could nowhere be found. This commission was the beginning of an immense success. The little armory at Whitneyville (New Haven, Connecticut), where the order for Mexico was executed, was soon exchanged for larger workshops at Hartford, the inventor's birthplace. These in their turn gave place (1852) to the enormous factory, doubled in 1861, on the banks of the Connecticut River, whence so many millions of revolvers, with all their appendages, have issued, and whence was sent, for the Russian and English Governments, to Tula and Enfield, the whole of the elaborate machinery devised by Colt for the manufacture of his pistols.

COLUMBA, St., was born on the 7th of December, 521, and the place of his birth is supposed to have been Gartan, in the county of Donegal. Both on the father's and on the mother's side he was descended from princely families in Ireland, and Conal, king of the Scots in Northern Britain, was his kinsman. Some writers are of opinion that his original name was Crinthan, and that he received the surname of Columba from the dove-like simplicity of his character, but it is more probable that the latter was his baptismal name. He was afterwards known as Columbkille, or Columba of the Churches, to distinguish him from

others of the same name. Ireland was already famous for the learned man who taught in its numerous monasteries; and Columba studied for some time under one of the most distinguished of these, St. Finian of Moville. Almost as a matter of course, under such circumstances, he embraced the monastic life. He was ordained deacon while at Moville, and afterwards, when about thirty years of age, was raised to the priesthood. During his residence in Ireland he founded two famous monasteries, one named Dair Calgach, on the banks of Lough Foyle, the other Dair-magh in Leinster, better known by their modern names of Derry and Durrow.

When upwards of forty years of age he left his native island, accompanied by twelve disciples, and went on a mission to Northern Britain. Argyll and the neighboring islands were at this time portions of the Christian kingdom of the Scots, and from its sovereign Conal he received the Island of Hy, or Iona, where he fixed his residence. His first task was to erect a church and monastery—humble structures of timber and reeds, according to the fashion of the country and the age. Having spent some years in preparation, he began the great work of his life,—the conversion of the heathen kingdom of the Northern Picts. Crossing over to the mainland he proceeded to the residence, on the banks of the Ness, of Brude, king of the Picts. By his preaching, his holy life, and, as his earliest biographers assert, by the performance of miracles, he converted the king and many of his subjects. The precise details, except in a few cases, are unknown, or obscured by exaggeration and fiction; but it is certain that the whole of northern Scotland was converted by the labors of Columba and his disciples, and the religious instruction of the people provided for by the erection of numerous monasteries.

The monastery of Iona was revered as the mother house of all these foundations, and its abbots were obeyed as the chief ecclesiastical rulers of the whole nation of the Northern Picts. There were then neither dioceses nor parishes in Ireland and Celtic Scotland; and by the Columbite rule the bishops themselves, although they ordained the clergy, were subject to the jurisdiction of the abbots of Iona, who, like the founder of the order, were only presbyters. The controversies connected with this subject are well known to the students of ecclesiastical history, and need not here be farther adverted to. Similar disputes have existed regarding the doctrines of Columba and his followers. This point also is beyond the range of the present article. It may be sufficient to mention that there is no real difficulty as to their belief in its general features. It was the same as that of the Western Church on the Continent, with which also their ritual agreed except in a few unimportant particulars, such as the precise time of keeping Easter. The confusion in these matters has been chiefly owing to the careless and incorrect identification of the Columbites with the clergy afterwards known by the name of Culdees.

Columba was honored by his countrymen, the Scots of Britain and Ireland, as much as by his Pictish converts, and in his character of chief ecclesiastical ruler or primate he gave formal benediction and inauguration to Aidan, the successor of Conal, as king of the Scots. He accompanied that prince to Ireland in 590, and took a leading part in a council held at Drumceat in Ulster, where a controversy was settled which had existed between the king of Ireland and the sovereign of the British Scots. The last years of Columba's life appear to have been spent at Iona. There he was already revered as a saint, and whatever credit may be given to some portions of the narratives of his biographers, there can be no doubt as to the wonderful influence which he exercised, as to the holiness of his life, and as to the love which he uniformly manifested to God and to his neighbor.

In the summer of 597 he knew that his end was approaching. On Saturday, the 8th of June, he was able, with the help of one of his monks, to ascend a little hill above the monastery and to give it his farewell blessing. Returning to his cell he continued a labor in which he had been engaged, the transcription of the Psalter. Having finished the verse of the 34th Psalm where it is written, "They who seek the Lord shall want no manner of thing that is good," he said, "Here I must stop:—what follows let Baithen write;" indicating, as was believed, his wish that Baithen should succeed him as abbot. He was present

<sup>1</sup>[He (1662-1744) taught at the Sorbonne, Paris, and wrote *Critical Essay*, attacking Fordun and other chroniclers of Scotch antiquities.—AM. ED.]

at evening in the church, and when the midnight bell sounded for the nocturnal office early on Sunday morning he again went thither unsupported, but sank down before the altar and passed away as in a gentle sleep.

The original materials for a life of St. Columba are unusually full. The earliest biography was written by one of his successors, Cuminius, who became abbot of Iona in 657. Much more important is the enlargement of that work by Adamnan, who became abbot of Iona in 679. These narratives are supplemented by the brief but most valuable notices given by the Venerable Bede. The first modern writers who discussed the life and actions of Columba with any approach to critical accuracy, were two learned clergymen of the Roman communion,—Thomas Innes,<sup>1</sup> the Scottish antiquary, and Dr. John Lanigan, the ecclesiastical historian of Ireland. In 1857 Dr. Reeves, now dean of Armagh, published his edition of Adamnan's *Life*, enriched with notes and dissertations which throw light on all the events of the saint's personal history and on everything connected with the state of Celtic Britain at the time. Later still we have an account of Columba by Count Montalembert, who, in his third volume of the *Monks of the West*, gives us, to use Gibbon's well-known words about Pope's Homer, "a portrait endowed with every merit excepting that of likeness to the original." (g. o.)

COLUMBANUS (c. 550-615), an Irish monk, was born in Leinster about the year 550, and was educated in the monastery of Bangor. He left the monastery in 590, together with twelve youths whom he was training, and established himself in the Vosges, among the ruins of an ancient town called Anagratia. Crowds quickly flocked round them, and the monasteries of Luxeuil and Fontenay were erected. But the enemies of Columbanus accused him before a synod of French bishops (602) for keeping Easter according to the old British and now unorthodox way, while a more powerful conspiracy was organized against him at the court, for boldly and haughtily rebuking for their crimes both the king of Burgundy, Thierry II., and the queen-mother Brunehaut. In consequence of this he was banished, but he proudly refused to stir. He was at length removed from his monastery by force, and, with St. Gall and others of the monks, he withdrew into Switzerland, where he preached with no great success to the Suedi and Alemanni. Being again compelled to flee, he retired to Italy, and founded the monastery of Bobbio, in which he remained till his death. His writings, which include some Latin poems, prove him a man of learning, and he appears to have been acquainted not only with the Latin classics, but also with Greek, and even Hebrew. His works were published at Louvain in 1687. His *Regula Cenobialis cum Penitentiali* is to be found in the *Codes Regularum* (Paris, 1638). The order of the Columbanus merged in that of the Benedictines in the beginning of the 8th century.

COLUMBIA, the capital of South Carolina, United States of North America, is a city of nearly 10,000 inhabitants. It lies on the east bank of the Congaree River, just below its junction with the Broad and Saluda, and is 124 miles N.N.W. of Charleston, the principal seaport of the State. It is noted for its salubrity and the natural beauty of its site and surroundings. As the capital and political centre of the State, it has held a position second only in importance to Charleston, and has been the home of many distinguished men. Several public institutions enhance its dignity. Among these are the South Carolina College, founded in 1804, with which the late Professor Francis Lieber was long officially connected, the asylum for the insane, a theological school, the State-house, courthouse, &c. It is the terminus of three railroads which connect it with Charleston and the sea-coast, and with points west and north, and is also the head of steamboat navigation on the River Congaree. A fertile agricultural region surrounds it, and it enjoys a fair degree of commercial prosperity. Near the close of the civil war (1865), the Union army of General Sherman entered the city, being feebly opposed by the Confederates. During the Federal occupation, fires were set—whether by invaders or defenders has never been determined beyond doubt—by which many buildings and a large amount of property were destroyed.

COLUMBIA, DISTRICT OF, a territory of the United States of America, originally erected under a law of Congress of July, 1790, for the establishment of a permanent

seat of government. This law authorized the acquisition by the United States of a territory not exceeding ten miles square, at the confluence of the Potomac and its eastern branch. A part of the territory thus designated was ceded to the United States by Virginia, and included the city of Alexandria, and a part by Maryland including the city of Georgetown. Outside of these cities the territory was occupied by planters and farmers, as it had been from the latter part of the 17th century. By a law of Congress of July, 1846, that portion of the district which had been ceded to the United States by Virginia was ceded back to that State. The present area of the district is 64 square miles. Under the law of 1790, three commissioners were appointed to receive the cession of the district, and to lay out the city of Washington and erect the public buildings for the reception of the Federal Government. The corner-stone of the Capitol was laid by Washington, September 18, 1793. On the first Monday of December, 1800, the removal of the Government from Philadelphia was effected.

The surface of the district is diversified by hill and dale, is well wooded with oak, maple, chestnut, hickory, and other trees, is productive when well cultivated, and affords at several points extended and beautiful views of the valley of the Potomac. The scenery of Rock Creek, an affluent of the Potomac, is also celebrated for its romantic beauty. The climate is temperate and healthy. In the autumn bilious fevers are sometimes prevalent on the low grounds. The staple product before 1800 was tobacco, the culture of which has of late years been abandoned for grain, Indian corn, hay, fruit, and vegetables, all of which are produced in great abundance, and sold at remunerative prices in the markets of Washington and Georgetown. The shad and herring fisheries of the Potomac yield a large revenue.

The population of the district at each census since its organization is thus stated:—

	White.	Colored.	Total.
1800	5,672	2,472	8,144
1810	10,345	5,126	15,471
1820	16,058	7,278	23,336
1830	21,152	9,109	30,261
1840	23,926	9,819	33,745
1850	37,941	13,746	51,687
1860	60,763	14,316	75,080
1870	88,278	43,404	131,700

The native-born population in 1870 was 115,446; the foreign-born, 16,254. The number of dwellings was 23,308; persons to a dwelling, 5.65; valuation of real and personal estate, \$126,873,618; value of farms, \$3,800,000; of farm productions, \$319,000. The number of manufacturing establishments was 952; steam-engines, 54; water-wheels, 15; hands employed, 4685; capital, \$5,021,925; products, \$9,292,173,—consisting mainly of flour, building materials, furniture, clothing, and iron. The debt of the district, mainly incurred since 1872 in the construction of sewers and the paving of streets in Washington and Georgetown, is about \$25,000,000.

The district is under the control of Congress, and its municipal affairs are regulated by three commissioners appointed by the president and Senate, by virtue of a law of 1874. The courts are constituted by Act of Congress, and the judges appointed by the president and Senate. By the law of 1874, the municipalities of Georgetown and Washington were abolished, and the elective franchise throughout the district suppressed. It has no representation in Congress.

The Chesapeake and Ohio Canal connects Georgetown, the head of tide-water on the Potomac, with Cumberland, the centre of the bituminous coal region of the State of Maryland. It is 180 miles in length, and transports 1,000,000 tons of coal per annum. The district is intersected by the Washington and Metropolitan branches of the Baltimore and Ohio Railway, and by the Baltimore and Potomac Railway, and is connected with the south by rail to Alexandria, the northern terminus of the Virginia railway system. There are well-managed lines of steamboats running to Norfolk, Baltimore, and New York, the last freighted mainly with flour from the district mills. The coal tonnage of the Potomac exceeds 600,000 tons

annually from the port of Georgetown, which is the port of entry for the district of Columbia.

Since 1793 the United States Government has expended \$60,000,000 in the erection of public buildings and improvement of public grounds in the district. For each of the years 1873, 1874, and 1875, Congress appropriated over \$2,000,000 as its share of the expenses of the district government. The free schools of the district are maintained at an annual cost of \$400,000. The Columbian university, established by the Baptists in 1821, is a well-endowed and flourishing institution. The Howard university, established for the education of the freedmen, is also well patronized. There are 120 church edifices in the district, of which the Baptists have 25, the Methodists 42, the Roman Catholics 14, the Episcopalians 20, the Presbyterians 14, and the Lutherans 8. The United States navy yard in Washington is one of the most complete in its appointments of all the dock-yards in the country.

COLUMBIA, BRITISH, the first of the Canadian provinces organized on the Pacific, was admitted into the Dominion in 1871. Including Vancouver's Island, it embraces an area of 233,000 squares miles, of bold sea-coast, lofty mountain ranges, and rugged picturesque river courses, as well as rich fertile valleys. Unlike the great river system to the east of the Rocky Mountains, the rivers of British Columbia make their way by abrupt rapids and falls, in the comparatively brief courses from the Rocky Mountains to the sea.

British Columbia owes its rise to the status of a province of Canada to the sudden influx of gold-diggers in 1856 and following years. The bed of the Fraser River had been discovered to be a rich auriferous deposit; and all who preferred the lottery-like chances of the diggings to the more laborious but certain fruits of patient industry hastened to this new Eldorado. In a semi-official publication of 1864, it is stated that, in 1860, "Antler, the most important creek, yielded at one time, at the lowest estimate, gold to the value of \$10,000 per day. On one claim \$1000 worth was taken out of the sluice-boxes as the result of a single day's work." But it was not till 1862 that the unsystematic process of mere surface diggings and washings of nomad adventurers was superseded by sinking shafts and carrying on a regulated system of mining under the direction of experienced engineers. Companies were formed; large capital was invested; and an official report of 1870 states the yield of gold for that year from the mines of Cariboo, Silionet, Lilloet, Columbia, Yale, and Lytton at \$1,333,745, in addition to the large quantities of the precious metal carried out of the province by private adventurers. It appears from authentic returns that from 1862 to 1871 gold to the value of \$16,650,036 was shipped from British Columbia by the banks, and so registered and put on record; while the estimated value of that which was carried out of the country by miners themselves during the same period is probably not over-estimated at \$6,000,000. Nor is this a mere temporary supply derived from surface-washings. Extensive tracts of gold-bearing quartz rocks constitute an important element in the permanent mineral resources of the country. According to the *Tables of the Trade and Navigation of the Dominion of Canada*, printed at Ottawa in 1875, the export of gold in dust and bars from the province of British Columbia during the previous year is valued at \$1,072,422.

As explorations and surveys are carried further into the interior the auriferous regions prove to be widely extended, and rich in their promised yield. Gold has been found over an area of not less than 200 miles, and is readily obtained by the simple processes of the adventurous gold-washer, in the beds of the Fraser, the Thompson, the Peace, and Omnicca Rivers, or the creeks and tributaries flowing into them. Stickeen River, towards the Alaska frontier, the most recent gold-field, has been successfully worked since 1875, and continues to yield an abundant return. But though the rumor of river-beds of golden sand is the readiest of all stimulants to emigration, a rush of gold-diggers is not the most satisfactory addition to the population of a young colony; nor is wealth thus easily acquired generally turned to good account. The immigrant population included bands of lawless adventurers, Texans, Mexicans, Spaniards, Californian, Australian, American, and Chinese gold-diggers, with a heterogeneous gathering of reckless fortune-hunters from all parts of the world.

The necessity for some regularly-organized form of government to control such a population made the organization of the territory beyond the Rocky Mountains into a province of the Dominion all the more welcome to the industrious settlers who were there seeking a permanent home.

Under the new orderly rule the crowd of gold-seekers was speedily followed by emigrants in pursuit of more settled industry. Agricultural laborers soon found that the golden harvest could be secured to themselves by providing for the miners the fruits of the soil. It is probably no exaggeration to estimate the worth of the gold carried out of the province from 1856 to 1875 as not less than \$36,000,000. Much of this might be considered as productive of no direct benefit to the country. Indirectly, however, it has largely contributed to the opening up of the new province, and making its many attractions known. It led to the construction of roads, developed the mining districts, encouraged agricultural and general trade, and stimulated the growth of permanent settlements. In 1841 the "Vincennes" ship of the American exploring expedition entered the Straits of De Fuca; and Dr. Pickering has preserved a vivid picture of the forbidding aspect of rudest savage life which then met his eye. Contrasting the then strange uncultivated scenes of that wild coast with the familiar centres of American civilization on the opposite shores of the same continent, he says, "Scarcely two centuries ago our New England shores presented only scenes like that before me: and what is to be the lapse of the third?" Within less than twenty years thereafter the town of Victoria was rising on Vancouver's Island, and that of New Westminster on the neighboring mainland. The printing press was in full operation. The *British Colonist*, the *New Westminster Times*, and other newspapers were in circulation, where so recently the Indian trail and wigwam were the sole evidence of the presence of man. The produce and manufactures of the province exported during the year ending June, 1874, are valued in *The Trade and Navigation Returns* for the year at \$2,120,624; the customs receipts are being chiefly expended on public works, and the varied resources of the country have been rapidly developed and turned to the best account.

**Minerals.**—The mineral products of British Columbia still occupy the foremost place in its exports. They are valued in 1874 at \$1,351,145. But it is important for the future progress of the young province on the Pacific that its minerals include coal. Mr. Horetsky, in his *Canada on the Pacific*, describes the shipping of coal at Vancouver Island for the San Francisco market, where it sells at \$12 per ton; and Mr. Grant, in his *Ocean to Ocean*, reports his visit to Nanaimo, with a population of seven or eight hundred, all depending on the neighboring Douglas mine. "The manager," he says, "informed us that they would probably ship 50,000 tons this season, and that next year they would be in a position to ship 100,000 or more. The coal measures which the few seams now worked represent extend over the whole eastern coast of Vancouver Island." Fine anthracite coal is also found near the coast, and in vast quantities, of superior quality, on Queen Charlotte's Island; and about 160 miles in the interior, on the River Nicholas, 50,871 tons of coal were exported in 1874 to the United States and Mexico, the value of which was \$278,213.

When the census was taken in 1870, the population of the little capital of Victoria amounted only to 3270, including 211 Chinese, but exclusive of Indians. Already it exceeds 5000 souls of very diverse character and nationality, but with abundant energy, and an assurance of progress. The Government of the Dominion is extending its aid to the young province with a liberal hand. In the fiscal year 1872-3, the total receipts to the Dominion from all sources in British Columbia amounted to \$417,409; while the expenditure,—apart from railway surveys,—was \$639,037. The same spirit still prevails. Buildings are in progress in Victoria for a post-office, savings bank, Government and Indian department; plans have also been prepared for a custom house and revenue office; and the efficient organization of courts of law and a system of police is being followed up by the erection of a penitentiary.

**Fisheries.**—Attention is now being energetically directed to the treasures of the ocean, the value of which has long been familiar to the native tribes. Mr. J. W. Powell, Indian commissioner, in a report to the minister of the interior, dated at Victoria, February 4, 1875, after a general survey of the condition of the Indians of the province of British Columbia, and the results of efforts to encourage their attention to agriculture, thus proceeds:—

"Fish is the great staple product of all the coast Indians, and owing to the numerous lakes and rivers with which British Columbia is most bountifully supplied, affords the chief means of

subsistence to almost all of the interior tribes. All kinds of fish are found in great abundance in the Northern Pacific waters; but the salmon, of which there are some six varieties, is the most constant and appreciated article of diet. The fish is now forming one of the most important exports of this province. The dog-fish is caught in large quantities for the oil contained in the liver, which not only forms a common article of barter between Indians themselves, but is sold to and exported as one of the chief products of the country by the Whites.

"The exports of fish, fish-oil, and furs (the two latter being almost solely obtained by Indians) for the fiscal year ended June, 1874, were:—

	1874.	July 20, 1870, to June 30, 1871.
Fish .....	\$69,665 00	
Fish-oil.....	44,453 00	27,638 00
Furs .....	307,625 00	200,407 00
Total.....	\$421,743 00	\$228,045 00"

All this, it has to be borne in remembrance, is the produce of native Indian enterprise, under the stimulus supplied by the White traders. The co-operation indeed extends to other industries besides those of the hunter and the fisher. The fur-bearing animals of the province include the bear, beaver, land and sea otters, fur and hair seals, martens, minks, racoons, fishers, wolverines, wolves, foxes, lynx, ermines, skunks, and pumas. Besides the produce resulting from the hunting and trapping of these fur-bearing animals, and the fruits of native industry in the fisheries of the rivers and the coasts, the Indian commissioner also notes the collection of cranberries as another productive resource of native industry. The export of cranberries from British Columbia varies according to favorable or less productive seasons. In the year 1874, which was regarded as a poor season, cranberries, gathered by the Indians, were exported to the value of \$2011.

With such results from the unregulated labors of rude Indian tribes, it is manifest how great must be the resources of the country, not only in the furs, which have long been an object of trade, but in the unheeded fisheries of the ocean and rivers. The whale still frequents the coast, and is pursued with success by the Clallams, Macaws, and other coast tribes. Now regular companies are being formed for its capture. In 1871 the "British Columbia Whaling Company" had produced 20,000 gallons of oil; and the results continue on a progressive scale. The dog-fish also, which has long been an object of special favor among the Indians, is now taken in large quantities by the Whites for its oil. In 1870 the produce of this fishery alone yielded 50,000 gallons of oil; and the price which it commanded in California has since proved a sufficient stimulus to increased zeal in prosecuting the fisheries. Cod, halibut, haddock, salmon, sturgeon, smelt, and sardines, all abound along the coasts, or in the straits and estuaries, and with the growing population and wealth, both in the provinces and in the neighboring States of the Pacific, the value of this branch of industry must rapidly increase. The riches of the sea must indeed, in the end, far out- rival all the produce of the gold mines, and may yet rival the fisheries of Nova Scotia and Newfoundland. Even now, with a sparse population, and trade in its infancy, the exports of the fisheries for 1874 are valued at \$114,118.

The province of British Columbia has the same advantage over the neighboring States of the Pacific, owing to climate and favorable geographical position, which the eastern provinces enjoy in comparison with the States on the Atlantic. This is specially manifest in the value of its timber; and this must go on increasing with the wealth of the surrounding States. Already the value of the produce of the forest has amounted in the year 1874 to \$260,116; and in its various forms of planks, spars, laths, and shingles, it is being exported, not only to the neighboring States and to South America, but to Australia and China, as well as to Great Britain. The white and yellow pine and the valuable Douglas pine abound. Cedar and hemlock attain to a great size; fine oak and maple are also abundant; and the rivers and the natural harbors afford every facility for a lumber trade for which the countries on both sides of the Pacific will supply as ready a market as the Eastern States and the ports of Europe afford to the lumberers of the provinces of Eastern Canada.

Already railway enterprise is abundantly stimulated by the development of the resources of this young province; and now the great question of the future is the route of the projected Pacific Railway, and its terminus on the Pacific coast. The disputes between the Provincial Government and that of the Dominion relative to its immediate construction have been the cause of much local irritation. In the summer of 1874, the Earl of Dufferin, as Governor-General of the Dominion, made a tour through British Columbia, and greatly contributed to a more reasonable feeling by his conciliatory mediation. The construction of a railway through the province is attended with more than the usual difficulties. In contrast to the vast level ranges of prairie to the east of the Rocky Mountains, its surface is extremely irregular; and the selection of a railway route is controlled by the necessity of finding both a pass through







**COLUMBUS**

the Rocky Mountains and a suitable access to the seaboard. Yellow Head Pass affords what appears to be the most advantageous route, at an elevation of about 3700 feet above the level of the sea. Immediately to the west of this an irregular plateau extends to within less than 100 miles of the coast, where the Cascade Range is reached. From this the descent to the coast is abrupt; the rivers have furrowed deep channels, or directed their courses into the natural cañons of this rugged coast-line, and much difficulty has been experienced in selecting an available route. From the mouth of the Columbia River, for 700 miles northward, the coast is indented with numerous inlets which cut deep into the land, and are comparable to the rugged fjords of Norway. Butte Inlet, which was first selected as the terminus of a proposed route through the Homathcoo Valley, is of this character. It is an exposed sound, walled by lofty cliffs, and with its waters of great depth, so that no suitable roadstead or anchorage is available. The latest surveys (1876) indicate that the line must pass by the Fraser River to New Westminster, where suitable natural harborage can be found. The chief objection to this route is its vicinity to the frontier, so that it very partially opens up the interior of the country. But Dean Inlet, which has been advocated as a preferable terminus, lies too far to the north. The project of an interoceanic railway through British American territory is, under any circumstances, a bold one; and the way in which it is being pressed onward to practical realisation abundantly illustrates the enterprise of this young country, which only requires the increased population which such facilities would supply to develop its inexhaustible resources.

Altogether, evidence enough has already been disclosed to show the great future which is in store for the Canadian provinces on the Pacific. The next decennial census will embrace British Columbia, and furnish more definite statistics as to its industrial progress and natural resources. A steady influx of emigration of the best quality is its first great need. The present population, apart from the native Indian and half-breed, is of a very miscellaneous character, including British, Canadian, American, French, German, and Chinese settlers, with as yet a large preponderance of the male sex.

In the *Tables of the Trade and Navigation of the Dominion for 1874*, the province of British Columbia not only exceeds in the value of its exports both the provinces of Prince Edward Island and Manitoba, but it exhibits the exceptionally favorable contrast of an excess in value of exports over imports. The total value of all goods imported for the year 1874 amounted to \$2,048,336, while the value of its exports during the same period was \$2,120,624.

Under the principles of confederation, the full rights of self-government and representative institutions, both in its own local parliament and in that of the Dominion, have been accorded to this young province. It has its own lieutenant-governor and Legislative Assembly, and is represented at Ottawa by three senators and six members of the House of Commons in the Dominion Parliament. (p. w.)

**COLUMBUS**, a city of the United States of America, capital of the State of Ohio, in Franklin county, is situated on the Scioto, a tributary of the Ohio, about 100 miles northwest of Cincinnati. It is well laid out on a level site in the midst of an extensive plain, and possesses very broad and handsome streets, pleasantly shaded with elm-trees. High Street is its principal thoroughfare, and Capitol Square one of the most spacious of its open areas; while Broad Street, 120 feet wide, is laid out for a stretch of two miles. As the capital of the State, it contains the usual public buildings, which are of a higher character than are to be found in other cities of the Union. The Capitol is an imposing edifice built of grey limestone, with a rotunda 150 feet high. It covers an area of 55,936 square feet, and its internal accommodation is most complete. There are also in and around the city the penitentiary, extending over more than 10 acres of ground, and accommodating upwards of 1000 prisoners; the new lunatic asylum, capable of containing 600 patients; the blind asylum, the idiot asylum, the deaf and dumb asylum, the United States arsenal, various hospitals and charitable institutions, a city hall, a county courthouse, a county infirmary, the Starling medical college, the Lutheran university, an agricultural and mechanical college, the odd-fellows' hall, and the opera-house. The city possesses a fine park of about 40 acres, named in honor of its donor, Dr. Lincoln Goodale, and another of equal extent called the City Park. The grounds of the Franklin County Agricultural Society occupy 83 acres, and the gardens of the Columbus Horticultural Society 10. The manufactures of the city are rather miscellaneous, and none of them have as yet developed to any great proportions; flour-mills, engineering works, and factories for agricultural implements, brushes, carriages, harness, files, and furniture are

among the chief establishments. Railways radiate from Columbus in all directions; and it has water-communication by means of a branch of the Ohio Canal. The first settlement of Columbus dates from 1812; its borough charter was bestowed in 1816, when it also became the seat of the State Government; it was made the capital of the county in 1824, and ten years after was raised to the rank of a city. The population in 1830 was 2437; in 1850, 17,882; and in 1870, 31,274.

**COLUMBUS**, a city of the United States, capital of Muscogee county, in Georgia, is situated on the east bank of the Chattahoochee, opposite the town of Girard, 84 miles south-west of Macon. The river which here separates the States of Georgia and Alabama, is navigable from Columbus to the Gulf of Mexico during the greater part of the year, and affords ready communication with extensive cotton-growing districts. A change in the level of the river at this place furnishes a strong head of water, which has been turned to practical use by the construction of a dam and other hydraulic contrivances. The town, which occupies a pretty extensive area, is regularly laid out, and its streets are of a good breadth. It contains a courthouse, a temperance hall, and several churches. Its chief industry is connected with the cotton trade, but there are also some flour-mills and other works. The town dates from 1828, when it was laid out on the Coweta Reserve. Population in 1850, 5042, and in 1870, 7401, of whom 3204 were colored.

**COLUMBUS, CHRISTOPHER** (c. 1436-1506), was the eldest son of Dominico Colombo and Suzanna Fontanarossa, and was born at Genoa in 1435 or 1436, the exact date being uncertain. His father was a wool-comber, of some small means, who was yet living two years after the discovery of the West Indies, and who removed his business from Genoa to Savona in 1469. His eldest boy was sent to the university of Pavia, where he devoted himself to the mathematical and natural sciences, and where he probably received instruction in nautical astronomy from Antonio da Terzago and Stefano di Faenza. On his removal from the university it appears that he worked for some months at his father's trade; but on reaching his fifteenth year he made his choice of life, and became a sailor.

Of his apprenticeship, and the first years of his career, no records exist. The whole of his earlier life, indeed, is dubious and conjectural, founded as it is on the half dozen dark and evasive chapters devoted by Fernando, his son and biographer, to the first half century of his father's times. It seems certain, however, that these unknown years were stormy, laborious, and eventful; "wherever ship has sailed," he writes, "there have I journeyed." He is known, among other places, to have visited England, "Ultima Thule" (Iceland), the Guinea coast, and the Greek Isles; and he appears to have been some time in the service of René of Provence, for whom he is recorded to have intercepted and seized a Venetian galley with great bravery and audacity. According to his son, too, he sailed with Colombo el Mozo, a bold sea captain and privateer; and a sea fight under this commander was the means of bringing him ashore in Portugal. Meanwhile, however, he was preparing himself for greater achievements by reading and meditating on the works of Ptolemy and Marinus, of Nearchus and Pliny, the *Cosmographia* of Cardinal Aliaco, the travels of Marco Polo and Mandeville. He mastered all the sciences essential to his calling, learned to draw charts and construct spheres, and thus fitted himself to become a consummate practical seaman and navigator.

In 1470 he arrived at Lisbon, after being wrecked in a sea fight that began off Cape St. Vincent, and escaping to land on a plank. In Portugal he married Felipa Munnis Perestrello, daughter of a captain in the service of Prince Henry, called the Navigator, one of the early colonists and the first governor of Porto Santo, an island off Madeira. Columbus visited the island, and employed his time in making maps and charts for a livelihood, while he pored over the logs and papers of his deceased father-in-law, and talked with old seamen of their voyages, and of the mystery of the western seas. About this time, too, he seems to have arrived at the conclusion that much of the world remained undiscovered, and step by step to have conceived that design of reaching Asia by sailing west which was to result in the discovery of America. In 1474 we

find him expounding his views to Paolo Toscanelli, the Florentine physician and cosmographer, and receiving the heartiest encouragement.

These views he supported with three different arguments, derived from natural reasons, from the theories of geographers, and from the reports and traditions of mariners. "He believed the world to be a sphere," says Helps; "he under-estimated its size; he over-estimated the size of the Asiatic continent. The farther that continent extended to the east, the nearer it came round towards Spain." And he had but to turn from the marvellous propositions of Mandeville and Aliaco to become the recipient of confidences more marvellous still. The air was full of rumors, and the weird imaginings of many generations of mediæval navigators had taken shape and substance, and appeared bodily to men's eyes. Martin Vicente, a Portuguese pilot, had found, 400 leagues to the westward of Cape St. Vincent, and after a westerly gale of many days' duration, a piece of strange wood, wrought, but not with iron; Pedro Correa, his own brother-in-law, had seen another such waif at Porto Santo, with great canes capable of holding four quarts of wine between joint and joint, and had heard of two men being washed up at Flores, "very broad-faced, and differing in aspect from Christians." West of the Azores now and then there hove in sight the mysterious islands of St. Brandan; and 200 leagues west of the Canaries lay somewhere the lost Island of the Seven Cities, that two valiant Genoese had vainly endeavored to discover. In his northern journey, too, some vague and formless traditions may have reached his ear, of the voyages of Biorn and Lief, and of the pleasant coasts of Helleland and Vinland that lay towards the setting sun. All were hints and rumors to bid the bold mariner sail westward, and this he at length determined to do.

The concurrence of some state or sovereign, however, was necessary for the success of this design. The Senate of Genoa had the honor to receive the first offer, and the responsibility of refusing it. Rejected by his native city, the projector turned next to John II. of Portugal. This king had already an open field for discovery and enterprise along the African coast; but he listened to the Genoese, and referred him to a Committee of Council for Geographical Affairs. The council's report was altogether adverse; but the king, who was yet inclined to favor the theory of Columbus, assented to the suggestion of the bishop of Ceuta that the plan should be carried out in secret and without Columbus's knowledge by means of a caravel or light frigate. The caravel was despatched, but it returned after a brief absence, the sailors having lost heart, and having refused to venture farther. Upon discovering this dishonorable transaction Columbus felt so outraged and indignant that he sent off his brother Bartholomew to England with letters for Henry VII., to whom he had communicated his ideas. He himself left Lisbon for Spain (1484), taking with him his son Diego, the only issue of his marriage with Felipa Munnis, who was by this time dead. He departed secretly,—according to some writers, to give the slip to King John, according to others, to escape his creditors. Three years after (20th March, 1488) a letter was sent by the king to "Christopher Colon, our especial friend," inviting him to return, and assuring him against arrest and proceedings of any kind; but it was then too late.

Columbus next betook himself to the south of Spain, and seems to have proposed his plan first to the duke of Medina Sidonia (who was at first attracted by it, but finally threw it up as visionary and impracticable), and next to the duke of Medina Celi. The latter gave him great encouragement, entertained him for two years, and even determined to furnish him with the three or four caravels. Finally, however, being deterred by the consideration that the enterprise was too vast for a subject, he turned his guest from the determination he had come to of making instant application at the court of France, by writing on his behalf to Queen Isabella; and Columbus repaired to the court at Cordova at her bidding.

It was an ill moment for the navigator's fortune. Castile and Leon were in the thick of that struggle which resulted in the final defeat of the Moors; and neither Ferdinand nor Isabella had time to listen. The adventurer was indeed kindly received; he was handed over to the care of Alonso de Quintanilla, whom he speedily converted into an enthusiastic supporter of his theory. He made many other friends,

and here met with Beatriz Enriquez, the mother of his second son, Fernando.

From Cordova Columbus followed the court to Salamanca, where he was introduced to the notice of the grand cardinal, Pedro Gonzales de Mendoza, "the third king of Spain." The cardinal, while approving the project, thought that it savored strongly of heterodoxy; but an interview with the projector brought him over, and through his influence Columbus at last got audience of the king. The matter was finally referred, however, to Fernando de Talavera, who in 1487 summoned a junta of astronomers and cosmographers to confer with Columbus, and examine his design and the arguments by which he supported it. The Dominicans of San Estebán in Salamanca entertained Columbus during the conference. The jurors, who were most of them ecclesiastics, were by no means unprejudiced, nor were they disposed to abandon their pretensions to knowledge without a struggle. Columbus argued his point, but was overwhelmed with Biblical texts, with quotations from the great divines, with theological objections; and in a short time the junta was adjourned. In 1489 Columbus, who had been following the court from place to place (billed in towns as an officer of the king's, and gratified from time to time with sums of money toward his expenses), was present at the siege of Malaga. In 1490 the junta decided that his project was vain and impracticable, and that it did not become their highnesses to have anything to do with it; and this was confirmed, with some reservation, by their highnesses themselves, at Seville.

Columbus was now in despair. He at once betook himself to Huelva, where his brother-in-law resided, with the intention of taking ship for France. He halted, however, at Palos, a little maritime town in Andalusia. At the monastery of La Rabida he knocked and asked for bread and water for his boy Diego, and presently got into conversation with Juan Perez de Marchena, the guardian, who invited him to take up his quarters in the monastery, and introduced him to Garci Fernandez, a physician and an ardent student of geography. To these good men did Columbus propound his theory and explain his plan. Juan Perez had been the queen's confessor; he wrote to her, and was summoned to her presence; and money was sent to Columbus, to bring him once more to court. He reached Granada in time to witness the surrender of the city; and negotiations were resumed. Columbus believed in his mission, and stood out for high terms; he asked the rank of Admiral at once, the vice-royalty of all he should discover, and a tenth of all the gain, by conquest or by trade. These conditions were rejected, and the negotiations were again interrupted. An interview with Mendoza appears to have followed; but nothing came of it, and in January, 1492, Columbus actually set out for France. At length, however, on the entreaty of Luis de Santangel, receiver of the ecclesiastical revenues of the crown of Aragon, Isabella was induced to determine on the expedition. A messenger was sent after Columbus, and overtook him at the Bridge of Pines, about two leagues from Granada. He returned to the camp at Santa Fé; and on 17th April, 1492, the agreement between him and their Catholic majesties was signed and sealed.

His aims were nothing less than the discovery of the marvellous province of Cipango and the <sup>First</sup> conversion to Christianity of the Grand Khan, <sup>voyage.</sup> to whom he received a royal letter of introduction. The town of Palos was ordered to find him two ships, and these were soon placed at his disposal. But no crews could be got together, in spite of the indemnity offered to all criminals and broken men who would serve on the expedition; and had not Juan Perez succeeded in interesting Martin Alonso Pinzon and Vicente Yañez Pinzon in the cause, Columbus's departure had been long delayed. At last, however, men, ships, and stores were ready. The expedition consisted of the "Santa Maria," a decked ship, with a crew of 50 men, commanded by the Admiral in person; and of two caravels, the "Pinta, with 30 men, under Martin Pinzon, and the "Niña," with 24 men, under his brother Vicente Yañez, afterwards (1499) the first to cross the line in the American Atlantic. The adventurers numbered 120 souls; and on Friday, 3d August, 1492, at eight in the morning, the little fleet weighed anchor, and stood out for the Canary Islands.

An abstract of the Admiral's diary made by the Bishop Las Casas is yet extant; and from it many particulars may

be gleaned concerning this first voyage. Three days after the ships had set sail the "Pinta" lost her rudder; the Admiral was in some alarm, but comforted himself with the reflection that Martin Pinzon was energetic and ready-witted; they had, however, to put in (August 9) at Teneriffe, to refit the caravel. On 6th September they weighed anchor once more with all haste, Columbus having been informed that three Portuguese caravels were on the look-out for him. On 13th September the variations of the magnetic needle were for the first time observed; on the 15th a wonderful meteor fell into the sea at four or five leagues distance. On the 16th they arrived at those vast plains of seaweed called the Sargasso Sea; and thenceforward, writes the Admiral, they had most temperate breezes, the sweetness of the mornings being most delightful, the weather like an Andalusian April, and only the song of the nightingale wanting. On the 17th the men began to murmur; they were frightened by the strange phenomena of the variations of the compass, but the explanation Columbus gave restored their tranquillity. On the 18th they saw many birds, and a great ridge of low-lying cloud; and they expected to see land. On the 20th they saw two pelicans, and were sure the land must be near. In this, however, they were disappointed, and the men began to be afraid and discontented; and thenceforth Columbus, who was keeping all the while a double reckoning—one for the crew and one for himself—had great difficulty in restraining the men from the excesses which they meditated. On the 25th Alonso Pinzon raised the cry of land, but it proved a false alarm; as did the rumor to the same effect on the 7th October, when the "Niña" hoisted a flag and fired a gun. On the 11th the "Pinta" fished up a cane, a log of wood, a stick wrought with iron, and a board, and the "Niña" sighted a stake covered with dog-roses; "and with these signs all of them breathed, and were glad." At ten o'clock on that night

America discovered. Columbus perceived and pointed out a light ahead; and at two in the morning of Friday, the 12th October, 1492, Rodrigo de Triana, a sailor aboard the "Niña," announced the appearance of what proved to be the New World. The land sighted was an island, called by the Indians Guanahani, and named by Columbus San Salvador.<sup>1</sup>

The same morning Columbus landed, richly clad, and bearing the royal banner of Spain. He was accompanied by the brothers Pinzon, bearing banners of the Green Cross, a device of his own, and by great part of the crew. When they all had "given thanks to God, kneeling upon the shore, and kissed the ground with tears of joy, for the great mercy received," the Admiral named the island, and took solemn possession of it for their Catholic majesties of Castile and Leon. At the same time such of the crews as had shown themselves doubtful and mutinous sought his pardon weeping, and prostrated themselves at his feet.

Into the details of this voyage, of highest interest as it is, it is impossible to go farther. It will be enough to say that it resulted in the discovery of the islands of Santa Maria del Concepcion, Exuma, Isabella, Juanna or Cuba, Bohio, the Cuban Archipelago (named by its finder the Jardin del Rey), the island of Santa Catalina, and that of Hispaniola, now called Haiti, or San Domingo. Off the last of these the "Santa Maria" went aground, owing to the carelessness of the steersman. No lives were lost, but the ship had to be unloaded and abandoned; and Columbus, who was anxious to return to Europe with the news of his achievement, resolved to plant a colony on the island, to build a fort out of the material of the stranded hulk, and to leave the crew. The fort was called La Navidad; 43 Europeans were placed in charge; and on 16th January, 1493, Columbus, who had lost sight of Martin Pinzon, set sail alone in the "Niña" for the east; and four days afterwards the "Pinta" joined her sister ship off Monte Christo. A storm, however, separated the vessels, and a long battle with the trade winds caused great delay; and it was not until the 18th February that Columbus reached the island of Santa Maria in the Azores. Here he was threatened with capture by the Portuguese governor, who could not for some time be

brought to recognise his commission. On 24th February, however, he was allowed to proceed, and on 4th March the "Niña" dropped anchor off Lisbon. The king of Portugal received the Admiral with the highest honors; and on 13th March the "Niña" put out from the Tagus, and two days afterwards, Friday, <sup>Return to Spain.</sup> 15th March, dropped anchor off Palos.

The court was at Barcelona; and thither, after despatching a letter announcing his arrival, Columbus proceeded in person. He entered the city in a sort of triumphal procession, was received by their majesties in full court, and, seated in their presence, related the story of his wanderings, exhibiting the "rich and strange" spoils of the new-found lands,—the gold, the cotton, the parrots, the curious arms, the mysterious plants, the unknown birds and beasts, and the nine Indians he had brought with him for baptism. All his honors and privileges were confirmed to him; the title of Don was conferred on himself and his brothers; he rode at the king's bridle; he was served and saluted as a grandee of Spain. And, greatest honor of all, a new and magnificent scutcheon was blazoned for him (4th May, 1493), whereon the royal castle and lion of Castile and Leon were combined with the four anchors of his own old coat of arms. Nor were their Catholic highnesses less busy on their own account than on that of their servant. On 3d and 4th May Alexander VI. granted bulls confirming to the crowns of Castile and Leon all the lands discovered,<sup>2</sup> or to be discovered, beyond a certain line of demarcation, on the same terms as those on which the Portuguese held their colonies along the African coast. A new expedition was got in readiness with all possible despatch to secure and extend the discoveries already made.

After several delays the fleet weighed anchor on 25th September and steered westwards. It <sup>Second voyage.</sup> consisted of three great carracks (galleons), and fourteen caravels (light frigates), having on board about 1600 men, besides the animals and material necessary for colonization. Twelve missionaries accompanied the expedition under the orders of Bernardo Buil, a Benedictine friar; and Columbus had been directed (29th May, 1493) to endeavor by all means in his power to Christianize the inhabitants of the islands, to make them presents, and to "honor them much," while all under him were commanded to treat them "well and lovingly," under pain of severe punishment. On 13th October the ships, which had put in at the Canaries, left Ferro; and so early as Sunday, 3d November, after a single storm, "by the goodness of God and the wise management of the Admiral" land was sighted to the west, which was named Dominica. Northwards from this new-found island the isles of Maria Galante and Guadaloupe were discovered and named; and on the north-western course to La Navidad those of Montserrat, Antigua, San Martin, and Santa Cruz were sighted, and the island now called Porto Rico was touched at, hurriedly explored, and named San Juan. On 22d November Columbus came in sight of Hispaniola, and sailing eastward to La Navidad, found the fort burned and the colony dispersed. He decided on building a second fort; and coasting on forty miles east of Cape Haytien, he pitched on a spot where he founded the city and settlement of Isabella.

The character in which Columbus had appeared had till now been that of the greatest of mariners; but from this point forward his claims to supremacy are embarrassed and complicated with the long series of failures, vexations, miseries, insults, that have rendered his career as a planter of colonies and as a ruler of men most pitiful and remarkable.

The climate of Navidad proved unhealthy; the colonists were greedy of gold, impatient of control, and as proud, ignorant, and mutinous as Spaniards could be; and Columbus, whose inclinations drew him westward, was doubtless glad to escape the worry and anxiety of his post, and to avail himself of the instructions of his sovereigns as to further discoveries. In January, 1494, he sent home, by Antonio de Torres, that despatch to their Catholic highnesses by which he may be said to have founded the West Indian slave trade. He founded the mining

<sup>1</sup> Helps refers to the island as "one of the Bahamas." It has been variously identified—with Turk's Island, by Navarrete (1825); with Cat Island, by Irving (1828) and Humboldt (1836); with Mayaguara, by Varnhagen (1864); and finally, with greatest show of probability, with Watling Island, by Munoz (1798), supported by Becher (1856), Pachel (1857), and Major (1871).

<sup>2</sup> "The countries which he had discovered were considered as a part of India. In consequence of this notion, the name of Indies is given to them by Ferdinand and Isabella in a ratification of their former agreement which was granted to Columbus after his return."—Robertson's *History of America*.

camp of San Tomaso in the gold country; and on 24th April, 1494, having nominated a council of regency under his brother Diego, and appointed Pedro de Margarite his captain-general, he put again to sea. After following the southern shore of Cuba for some days, he steered southwards, and discovered the island of Jamaica, which he named Santiago. He then resumed his exploration of the Cuban coast, threading his way through a labyrinth of islets supposed to be the Morant Keys, which he named the Garden of the Queen; and after coasting westwards for many days, he became convinced that he had discovered continuous land, and caused Perez de Luna, the notary, to draw up a document attesting his discovery (12th June, 1494), which was afterwards taken round and signed, in presence of four witnesses, by the masters, mariners, and seamen of his three caravels, the "Niña," the "Cardera," and the "San Juan." He then stood to the south-east, and sighted the island of Evangelita; and after many days of difficulties and anxieties, he touched at and named the island La Mona. Thence he had intended to sail eastwards, and complete the survey of the Caribbean Archipelago. But he was exhausted by the terrible tear and wear of mind and body he had undergone (he says himself that on this expedition he was three and thirty days almost without any sleep), and on the day following his departure from La Mona, he fell into a lethargy, that deprived him of sense and memory, and had well nigh proved fatal to life. At last, on 29th September, the little fleet dropped anchor off Isabella, and in his new city the great Admiral lay sick for five months.

The colony was in a sad plight. Every one was discontented, and many were sick, for the climate was unhealthy and there was nothing to eat. Margarite and Buil had quitted Hispaniola for Spain; but ere his departure, the former, in his capacity of captain-general, had done much to outrage and alienate the Indians. The strongest measures were necessary to undo this mischief; and backed by his brother Bartholomew, a bold and skilful mariner, and a soldier of courage and resource, who had been with Diaz in his voyage round the Cape of Good Hope, Columbus proceeded to reduce the natives under Spanish sway. Alonso de Ojeda succeeded by a brilliant *coup de main* in capturing the cacique Caonabo, and the rest submitted. Five ship-loads of Indians were sent off to Seville (24th June, 1495) to be sold as slaves; and a tribute was imposed upon their fellows, which must be looked upon as the origin of that system of *repartimientos* or *encomiendas* which was afterwards to work such cruel mischief among the conquered. But the tide of court favor seemed to have turned against Columbus. In October, 1495, Juan Aguado arrived at Isabella, with an open commission from their Catholic majesties, to inquire into the circumstances of his rule; and much contest and recrimination followed. Columbus found that there was no time to be lost in returning home; he appointed his brother Bartholomew "adelantado" of the island; and on 10th March, 1496, he quitted Hispaniola in the "Niña." The vessel, after a protracted and perilous voyage, reached Cadiz on 11th June, 1496. The Admiral landed in great dejection, wearing the costume of a Franciscan. Reassured, however, by the reception of his sovereigns, he asked at once for eight ships more, two to be sent to the colony with supplies, and six to be put under his orders for new discoveries. The request was not immediately granted, as the Spanish exchequer was not then well supplied. But principally owing to the interest of the queen, an agreement was come to similar to that of 1492, which was now confirmed. By this royal patent, moreover, a tract of land in Hispaniola, of 50 leagues by 20, was made over to him. He was offered a dukedom or a marquisate at his pleasure; for three years he was to receive an eighth of the gross and a tenth of the net profits on each voyage; the right of creating a mayorazgo or perpetual entail of titles and estates was granted him; and on 24th June his two sons were received into Isabella's service as pages. Meanwhile, however, the preparing of the fleet proceeded slowly; and it was not till the 30th May, 1498, that he and his six ships set sail.

From San Lucar he steered for Gomera, in the Canaries, and thence despatched three of his ships to San Domingo. He next proceeded to the Cape Verd Islands, which he quitted on 4th July. On the 31st of the same month, being greatly in

need of water, and fearing that no land lay westwards as they had hoped, Columbus had turned his ship's head north, when Alonso Perez, a mariner of Huelva, saw land about 15 leagues to the south-west. It was crowned with three hill-tops, and so when the sailors had sung the *Salm Regina*, the Admiral named it Trinidad, which name it yet bears. On Wednesday, 1st August, he beheld for the first time in the mainland of South America the continent he had sought so long. It seemed to him but an insignificant island, and he called it Zeta. Sailing westwards, next day he saw the Gulf of Paria, which was named by him the Golfo de la Belena, and was borne into it at immense risk on the ridge of waters formed by the meeting with the sea of the great rivers that empty themselves, all swollen with rain, into the ocean. For many days he coasted the continent, esteeming as islands the several projections he saw, and naming them accordingly; nor was it until he had looked on and considered the immense volume of fresh water poured out through the embouchure of the river now called the Orinoco, that he concluded that the so-called archipelago must be in very deed a great continent.

Unfortunately at this time he was suffering intolerably from gout and ophthalmia; his ships were crazy; and he was anxious to inspect the infant colony whence he had been absent so long. And so, after touching at and naming the island of Margarita, he bore away to the north-east, and on 30th August the fleet dropped anchor off Isabella.

He found that affairs had not prospered well in his absence. By the vigor and activity of the adelantado, the whole island had been reduced under Spanish sway, but at the expense of the colonists. Under the leadership of a certain Roldan, a bold and unprincipled adventurer, they had risen in revolt, and Columbus had to compromise matters in order to restore peace. Roldan retained his office; such of his followers as chose to remain in the island were gratified with *repartimientos* of land and labor; and some fifteen, choosing to return to Spain, were enriched with a number of slaves, and sent home in two ships which sailed in the early part of October, 1499.

Five ship-loads of Indians had been deported to Spain some little time before. On the arrival of these living cargoes at Seville, the queen, the staunch and steady friend of Columbus, was moved with compassion and indignation. No one, she declared, had authorized him to dispose of her vassals in any such manner; and proclamations at Seville, Granada, and other chief places ordered (20th June, 1499), the instant liberation and return of all the last gang of Indians. In addition to this the ex-colonists had become incensed against Columbus and his brothers. They were wont to parade their grievances in the very court-yards of the Alhambra, to surround the king when he came forth with complaints and reclamations, to insult the discoverer's young sons with shouts and jeers. There was no doubt that the colony itself, whatever the cause, had not prospered so well as might have been desired. And, on the whole, it is not surprising that Ferdinand, whose support to Columbus had never been very hearty, should about this time have determined to suspend him. Accordingly on March 21, 1499, Francisco de Bobadilla was ordered "to ascertain what persons had raised themselves against justice in the island of Hispaniola, and to proceed against them according to law." On May 21st the government of the island was conferred on him, and he was accredited with an order that all arms and fortresses should be handed over to him; and on May 26 he received a letter for delivery to Columbus, stating that the bearer would "speak certain things to him" on the part of their highnesses, and praying him "to give faith and credence, and to act accordingly." Bobadilla left Spain in July, 1500, and landed in Hispaniola in October.

Columbus, meanwhile, had restored such tranquillity as was possible in his government. With Roldan's help he had beaten off an attempt on the island of the adventurer Ojeda, his old lieutenant; the Indians were being collected into villages and Christianized. Gold-mining was actively and profitably pursued; in three years, he calculated, the royal revenues might be raised to an average of 60,000,000 reals. The arrival of Bobadilla, however, speedily changed this state of affairs into a greater and more pitiable confusion than the island had ever before witnessed. On landing, he took possession of the Admiral's house and summoned him and his brothers before him. Accusations

of severity, of injustice, of venality even, were poured down on their heads, and Columbus anticipated nothing less than a shameful death. Bobadilla put all three in irons, and shipped them off to Spain.

Alonso de Villejo, captain of the caravel in which the illustrious prisoners sailed, still retained a proper sense of the honor and respect due to Columbus, and would have removed the fetters; but to this Columbus would not consent. He would wear them, he said, until their highnesses, by whose order they had been affixed, should order their removal; and he would keep them afterwards "as relics and as memorials of the reward of his services." He did so. His son Fernando "saw them always hanging in his cabinet, and he requested that when he died they might be buried with him." Whether this last wish was complied with is not known.

A heart-broken and indignant letter from Columbus to Doña Juana de la Torre, the governess of the infante Don Juan, arrived at court before the despatch of Bobadilla. It was read to the queen, and its tidings were confirmed by communications from Alonso de Villejo, and the alcaide of Cadix. There was a great movement of indignation; the tide of popular and royal feeling turned once more in the Admiral's favor. He received a large sum to defray his expenses; and when he appeared at court, on 17th December, he was no longer in irons and disgrace, but richly apparelled and surrounded with friends. He was received with all honor and distinction. The queen is said to have been moved to tears by the narration of his story. Their majesties not only repudiated Bobadilla's proceedings, but declined to inquire into the charges that he at the same time brought against his prisoners, and promised Columbus compensation for his losses and satisfaction for his wrongs. A new governor, Nicolas de Ovando, was appointed in Bobadilla's room, and left San Lucar on 18th February, 1502, with a fleet of 30 ships. The latter was to be impeached and sent home; the Admiral's property was to be restored, and a fresh start was to be made in the conduct of colonial affairs. Thus ended Columbus's history as viceroy and governor of the new Indies which he had presented to the country of his adoption.

His hour of rest, however, was not yet come. <sup>Fourth</sup> Ever anxious to serve their Catholic highnesses, "and particularly the queen," he had determined to find a strait through which he might penetrate westwards into Portuguese Asia. After the usual inevitable delays his prayers were granted, and on 9th May, 1502, with four caravels and 150 men, he weighed anchor from Cadix, and sailed on his fourth and last great voyage. He first betook himself to the relief of the Portuguese fort of Arzilla, which had been besieged by the Moors, but the siege had been raised voluntarily before he arrived. He put to sea westwards once more, and on 13th June discovered the island of Martinique. He had received positive instructions from his sovereigns on no account to touch at Hispaniola; but his largest caravel was greatly in need of repairs, and he had no choice but to abandon her or disobey orders. He preferred the latter alternative, and sent a boat ashore to Ovando, asking for a new ship and for permission to enter the harbor to weather a hurricane which he saw was coming on. But his requests were refused, and he coasted the island, casting anchor under lee of the land. Here he weathered the storm, which drove the other caravels out to sea, and annihilated the homeward-bound fleet, the richest that had till then been sent from Hispaniola. Roldan and Bobadilla perished with others of the Admiral's enemies; and Fernando Colon, who accompanied his father on this voyage, wrote long years afterwards, "I am satisfied it was the hand of God, for had they arrived in Spain they had never been punished as their crimes deserved, but rather been favored and preferred."

After recruiting his flotilla at Azna, Columbus put in at Jaquimo and refitted his four vessels; and on 14th July, 1502, he steered for Jamaica. For nine weeks the ships wandered painfully among the keys and shoals he had named the Garden of the Queen, and only an opportune easterly wind prevented the crews from open mutiny. The first land sighted was the islet of Guanaja, about forty miles east of the coast of Honduras. Here he got news from an old Indian of a rich and vast country lying to the eastward, which he at once concluded must be the long sought for empire of the Grand Khan. Steering

along the coast of Honduras, great hardships were endured, but nothing approaching his ideal was discovered. On 12th September Cape Gracias-à-Dios was sighted. The men had become clamorous and insubordinate; not until the 5th December, however, would he tack about, and retrace his course. It now became his intention to plant a colony on the river Veragua, which was afterwards to give his descendants a title of nobility; but he had hardly put about when he was caught in a storm, which lasted eight days, wrenched and strained his crazy, worm-eaten ships severely, and finally, on the Epiphany, blew him into an embouchure which he named Bethlehem. Gold was very plentiful in this place, and here he determined to found his settlement. By the end of March, 1503, a number of huts had been run up, and in these the adelantado with 80 men was to remain, while Columbus returned to Spain for men and supplies. Quarrels, however, arose with the natives; the adelantado made an attempt to seize on the person of the cacique, and failed; and before Columbus could leave the coast he had to abandon a caravel, to take the settlers on board, and to relinquish the enterprise. Steering eastwards, he left a second caravel at Porto Bello; and on May 31st he bore northwards for Cuba, where he obtained supplies from the natives. From Cuba he bore up for Jamaica, and there, in the harbor of Santa Gloria, now St. Anne's Bay, he ran his ships aground in a small inlet still called Don Christopher's Cove.

The expedition was received with the greatest kindness by the natives, and here Columbus remained upwards of a year awaiting the return of his lieutenant Diego Mendez, whom he had despatched to Ovando for assistance. During his critical sojourn here, the admiral suffered much from disease and from the lawlessness of his followers, whose misconduct had alienated the natives, and provoked them to withhold their accustomed supplies, until he dextrously worked upon their superstitions by prognosticating an eclipse. Two vessels having at last arrived for their relief from Mendez and Ovando, Columbus set sail for Spain, and after a tempestuous voyage he landed once more at Seville on 7th September, 1504.

As he was too ill to go to court, his son Diego was sent thither in his place, to look after his <sup>Closing</sup> interests and transact his business. Letter after <sup>years.</sup> letter followed the young man from Seville,—one by the hands of Amerigo Vespucci. A license to ride on muleback was granted him on 23d February, 1505; and in the following May he was removed to the court at Segovia, and thence again to Valladolid. On the landing of Philip and Juana at Coruña (25th April, 1506), although "much oppressed with the gout and troubled to see himself put by his rights," he is known to have sent off the adelantado to pay them his duty and to assure them that he was yet able to do them extraordinary service. The last documentary note of him is contained in a final codicil to the will of 1498, made at Valladolid on 19th May, 1506. By this the old will is confirmed; the mayorazgo is bequeathed to his son, Diego, and his heirs male, failing these to Fernando, his second son, and failing these to the heirs male of Bartholomew; only in case of the extinction of the male line, direct or collateral, is it to descend to the females of the family; and those into whose hands it may fall are never to diminish it, but always to increase and ennoble it by all means possible. The head of the house is to sign himself "The Admiral." A tenth of the annual income is to be set aside yearly for distribution among the poor relations of the house. A chapel is founded and endowed for the saying of masses. Beatriz Enriquez is left to the care of the young admiral in most grateful terms. Among other legacies is one of "half a mark of silver to a Jew who used to live at the gate of the Jewry, in Lisbon." The codicil was written and signed with the Admiral's own hand. Next day (20th May, 1506) he died.

He was buried at Valladolid; but his remains were soon after transferred thence to the Carthusian monastery of Las Cuevas, Seville, where the bones of Diego, the second Admiral, were also laid. Exhumed in 1536, the bodies of both father and son were taken over sea to Hispaniola (San Domingo) and interred in the cathedral. In 1795-96, on the cession of that island to the French, the august relics were re-exhumed, and were transferred with great state and solemnity to the cathedral of the Havana, where they yet remain.<sup>1</sup> The male issue of the Admiral became extinct with the third generation, and the estates and

<sup>1</sup>[In 1877, Señor Boque Cocchia, archbishop of San Domingo, certified the discovery of the first Admiral's remains in the cathedral of that city; the adjoining empty crypt he supposed to have contained the remains of Don Diego, the son, and that these were by mistake removed to Havana.—AM. Ed.]

titles passed by marriage to a scion of the house of Bragança.

In person Columbus was tall and shapely, long-faced and aquiline, white-eyed and auburn-haired, and beautifully complexioned. At thirty his hair was quite grey. He was temperate in eating, drinking, and dress; and "so strict in religious matters, that for fasting and saying all the divine office, he might be thought professed in some religious order." His piety, as his son has noted, was earnest and unwavering; it entered into and colored alike

Columbus's Cipher.

The interpretation of the seven-lettered cipher, accepting the smaller letters of the second line as the final ones of the words, seems to be—*Scruto-me, Aristia, Maria, Josephus*. The name *Christopher* appears in the last line.

his action and his speech; he tries his pen in a Latin distich of prayer; his signature is a mystical pietistic device. He was pre-eminently fitted for the task he created for himself. Through deceit and opprobrium and disdain he pushed on towards the consummation of his desire; and when the hour for action came the man was not found wanting.

See Washington Irving, *Life and Voyages of Columbus*, London, 1831; Humboldt, *Examen Critique de l'Histoire de la Géographie du Nouveau Continent*, Paris, 1836; Spotorno, *Cadice Diplomatico Colombo-Americano*, Genoa, 1823; Hernan Colon, *Vita dell' Ammiraglio*, 1571 (English translation in vol. II. of Churchill's *Voyages and Travels*, third edition, London, 1744; Spanish, 1745); Prescott, *History of Ferdinand and Isabella*, London, 1870; Major, *Select Letters of Columbus*, Hakluyt Society, London, 1847, and "On the Landfall of Columbus," in *Journal of the Royal Geographical Society* for 1871; Sir Arthur Helps, *Life of Columbus*, London, 1868; Navarrete, *Coleccion de Viajes y Descubrimientos desde Fines del Siglo XV*, Madrid, 1825; Tioknor, *History of Spanish Literature*, London, 1863. See also Pietro Martiro d'Anghiera, *Opus Epistolaram*, 1530, and *De Rebus Occidentis et de Orbe Novo*, 1511; Gomara, in *Historiadores Primitivos de Indias*, vol. xxii. of Rivadaneira's collection; Oviedo y Valdes, *Cronica de las Indias*, Salamanca, 1547; Ramusio, *Raccolta delle Navigations et Viaggi*, III, Venetia, 1575; Herrera de Tordesillas, *Historia de las Indias Occidentales*, 1601; Antonio Leon Pinelo, *Epitome de la Biblioteca Oriental y Occidental*, Madrid, 1623; Muñoz, *Historia del Nuevo Mundo*, Madrid, 1793; Cancellieri, *Notizia di Cristoforo Colombo*, 1809; Bossi, *Vita di Cristoforo Colombo*, 1819; Charlevoix, *Histoire de San Domingo*; Lamartine, *Christoph Colomb*, Paris, 1862 (Spanish translation, 1865); Crompton, *Life of Columbus*, London, 1859; *Voyages and Discoveries of Columbus*, sixth edition, London, 1857; H. R. St. John, *Life of Columbus*, London, 1850.

COLUMELLA, LUCIUS JUNIUS MODERATUS, the author of the most complete classical treatise on agricultural affairs, was born at Gades (Cadiz), and belongs to the 1st century A.D., being contemporary with Seneca. He possessed an estate called Ceretanum, perhaps near the Pyrenees, perhaps in Sardinia, and he also travelled extensively, but he principally resided at Rome. His extant works treat with great fullness, and in a diffuse but not inelegant style which well represents the silver age, of the cultivation of all kinds of corn and garden vegetables, trees, flowers, the vine, the olive, and other fruits, and of the rearing of all the domestic animals. They consist of the 12 books of the *De Re Rustica*, that which treats of gardening being in dactylic hexameters, and of a book *De Arboribus*, which is the only part we possess of a work treating of the same subjects as *De Re Rustica*, but earlier and less elaborate. The *editio princeps* was published by Jenson at Venice in 1472, in the *Rei Rusticæ Scriptores Varii*. A good edition is contained in the *Rei Rusticæ*

*Scriptores Veteres Latini* of Gesner (Leipsic, 1735, again edited and collated with a newly-discovered MS. by Ernesti, 1773); and the best is that given in the *Scriptores Rei Rusticæ* by Schneider (Leipsic, 1794). There are translations in English (1745), French (1651), Italian (1554-57-59 and 1808), and German (1769).

COLZA OIL is a non-drying oil obtained from the seeds of *Brassica Napus*, var. *oleifera*, a variety of the plant which produces Swedish turnips. Colza is extensively cultivated in France, Belgium, Holland, and Germany; and especially in the first-named country, the expression of the oil is an important industry. In commerce colza is classed with rape oil, to which both in source and properties it is very closely allied. It is a comparatively inodorous oil of a yellow color, having a specific gravity at 60° Fahr. of 0.9128; and it solidifies at 22° Fahr. The cake left after expression of the oil is a valuable feeding substance for cattle. Colza oil is extensively used as a lubricant for machinery, and for burning in lamps. It was for many years employed in British light-houses, having been favorably reported on for that purpose in 1845 by Professor Faraday, but mineral oils are now more generally used.

COMACCHIO, a town of Italy, in the province of Ferrara, at the head of a circondario, is situated on a long island near the seaward side of an extensive lagoon in the Adriatic, known as the Valli di Comacchio, in 44° 41' 36" N. lat. and 29° 51' 23" E. long. It is the seat of a bishop, and possesses a Capuchin convent and several fine churches. It was at one time strongly fortified, and still has remains of the citadel, which in accordance with the treaty of Vienna was held by the Austrians till 1859. The inhabitants are mainly engaged in the manufacture of salt and the prosecution of the fisheries in the lagoon, which, with its shallow area of 41,600 acres, affords a rich feeding ground for eels and gray mullets. The seaward entrance is carefully guarded by a system of nets, so that the fish, once within the lagoon, cannot find their way out again. The eels are exported to all parts of Italy, sometimes alive, but more usually in a pickle; and they are greatly esteemed for their delicate flavor. The average annual production is 1,800,000 lb, and the value about £40,000. Population, 8900.

COMANA (frequently called CHRYSE, or AUREA, i.e., the golden, to distinguish it from Comana in Pontus), a city of Cappadocia, in a deep valley of the Anti-Taurus range, through which the river Sarus (Sihun) flows. This city was celebrated in ancient times as the place where the rites of the goddess Mā, the Greek *Enyo*, were celebrated with much solemnity. The service was carried on in a sumptuous temple and with great magnificence. To defray expenses, large estates had been set apart, which yielded a more than royal revenue. The city of Comana, which was a mere appanage of the temple, was governed immediately by the chief priest, who was always a member of the reigning family, and took rank next to the king. The number of persons engaged in the service of the temple, even in Strabo's time, was upwards of 6000. Under Caracalla, Comana became a Roman colony. Its site has not been identified.

COMANA, an ancient city of Pontus in Asia Minor, said to have been colonized from Comana in Cappadocia. It stood on the River Iris (or Tocat-su) not far from its source, and from its central position was a favorite emporium of the Armenian and other merchants. The moon-goddess was worshipped in the city with a pomp and ceremony in all respects analogous to those employed in the Cappadocian city. Large multitudes were attracted to the place by the great annual processions, and the permanent population was increased by the influx of devotees. The slaves attached to the temple alone numbered not less than 6000. Remains of Comana are still to be seen near a village called Gumenek on the Tocat-su, seven miles from the city of Tocat. "They consist," says Van Lennep, "of a low hill upon which are scattered fragments of brick and hewn stone, with here and there the remains of a wall or a partly fallen vault." The bridge that crosses the river at the spot is largely composed of fragments of ancient structures, and several sepulchral inscriptions can be deciphered on the blocks beneath the arches. Still nearer the modern village of Gumenek than these ruins lies a large boulder of marble in which tombs or cells have been excavated. One of these is reputed to have been the abode of Chrysostom during his first exile from Constantinople.



**COMANCHES**, a tribe of North American Indians, so called by the Spaniards, but known to the French as *Padouques*, and among themselves as *Naiini*. They belong to the Shoshone family, and when first met by Europeans occupied the regions between the upper waters of the *Brasos* and *Colorado* on the one hand and the *Arkansas* and *Missouri* on the other. They were brought to nominal submission in 1733 by the Spanish general *Anza*, who killed thirty of their chiefs; but they again became troublesome, and continued to harass the district of *Texas* till they were settled in a reservation in the *Indian Territory*. In 1872 a portion of the tribe, called the *Quanhada* or *Staked Plain Comanches*, had to be reduced by military measures. Their total numbers, estimated by *President Burnet* in 1847 as 10,000 or 12,000, are now reduced to little more than 3000 or 4000.

**COMAYAGUA**, a city of Central America, capital of the republic of *Honduras* and of the department of *Comayagua*, is situated in 14° 28' N. lat. and 87° 39' W. long., about half way between the *Pacific* and the *Atlantic*, on the right bank of the *Humuya* or *Uluva River*, and near the southern edge of a wide and fertile valley to which it gives its name. It lies 2060 feet above the level of the sea, and the valley is shut in by mountains varying in height from 5000 to 6000 feet, so that it enjoys a comparatively temperate and equable climate. It is the residence of the president and the seat of the only bishop in *Honduras*; but the political disturbances of the country have reduced it to a very poor condition. The houses are mainly of one story and built of sun-dried bricks; and the fine fountains, monuments, and public buildings, of which it once could boast, have for the most part fallen into ruins or decay. Of those still left the principal is the cathedral, a rather imposing building, with cupolas and towers, dating from the beginning of the 18th century. The university, founded in 1673, and more than once nominally restored in the present century, does not practically exist. The trade of the city is very small, in spite of the fertility of the neighboring district; but a railway is in course of construction, which will put it in direct communication with both sides of the continent. In the neighborhood, *Mr. Squier* informs us, "hardly a step can be taken without encountering evidences of aboriginal occupation; but the only relic mentioned in the city itself is a dog-shaped figure built into the walls of the church of *Our Lady of Dolores*." The present city, originally designated *Valladolid la Nueva*, was founded in 1540 by *Alonso Caceres*, who had been instructed to find out an eligible site for a town midway between the oceans. In 1557 it received the rights of a city, and in 1561 was made a bishop's see. Its prosperity is shown by the fact that at the great revolution of 1827 it had about 18,000 inhabitants. Burned in that year by the monarchical party of *Guatemala*, it has since suffered during successive contests, more especially in 1872, when it witnessed the defeat of *General Medina's* army by the allied forces of *San Salvador* and *Guatemala*, and in 1873, when it was besieged for about two months. In 1854 *Scherzer* estimated the population at only 2000, but it is believed now to number between 7000 and 8000.

**COMB**, a toothed implement for arranging and dressing hair and other fibrous substances. Worsted wools, waste silk, and other long fibres are dressed and prepared for spinning by a process called *combing*, performed formerly by hand-combs, but now by an elaborate combing machine. This process of combing will be described in connection with the manufactures to which it belongs. Here we have only to do with the implement so well known in domestic economy. Comb-making is necessarily a prominent and extensive industry, in which a considerable variety of materials are employed, the most common being the horns and hoofs of cattle, tortoise-shell, ivory, boxwood, vulcanite or hardened Indian-rubber, and to a small extent German silver and other metals. Of these materials horn is by far the most extensively employed, and the working of that substance illustrates all the peculiarities of the craft. The industry is one still extensively prosecuted on a small scale, with all the disadvantages of manual labor and wasteful and tedious processes; but in several large factories very ingenious labor and material-saving machinery is brought into operation, as in the extensive and complete works of *Messrs. Stewart & Co. of Aberdeen*. In *Messrs. Stewart's* factory the raw material annually consumed averages

3,500,000 horns, about 1,000,000 hoofs, nearly 600 lb of tortoise shell, and 20 tons of vulcanite, out of which more than 10,000,000 combs are manufactured. The British supply of horn is very limited, and altogether inadequate to the demand. The sources whence this raw material is drawn are chiefly *South America* and *Australia*, whence ox and cow horns are procured, and *India, China, and Siam*, which supply buffalo horns. When the horn is brought into the factory it is first assorted into sizes, preparatory to being cut up into pieces. From an ordinary horn two cross sections are taken for comb-making, called, first, the head or root cut, and, second, the screw or tip cut. The solid tips remaining are disposed of either for button-making or for being formed into knife and other handles. Other scraps and cuttings are of great value to makers of prussiate of potash and for artificial manure. The sections to be used for combs are taken to the opening department, where they are wetted in water and heated over an open fire till the horny substance becomes quite soft. The head cut is slit longitudinally once, or if it is a large horn it may be slit into two. The screw cut is so termed on account of the peculiar spiral direction in which it is slit, the cut being so directed that the piece when opened out may form an oblong rectangular plate with as little waste of horn as practicable. After slitting, the cuts are opened out between tongs, and inserted between screw plates where they are pressed quite flat. Plates which are intended for staining in imitation of tortoise-shell are at this stage inserted in strong iron frames between heated and oiled iron plates, in which they are submitted for some time to enormous pressure. After this pressure the plates are found to have a translucent appearance and a uniform greenish hue. The pressure, however, operates injuriously on the fibre or grain of the horn, rendering it liable to split. When, therefore, the horn is of good natural color, it is preferred to finish it in that condition. The prepared plates of horn are laid aside to dry in a room where a high temperature is maintained by steam-pipes. Subsequently they are squared and trimmed on circular saw benches, and assorted into sizes suitable for the various kinds of combs manufactured.

In the manufacture of ordinary dressing-combs two distinct processes of tooth-cutting are followed. The first method, which is applied to all fine combs, consists in cutting out the teeth by means of circular saws; and this is the only process applicable to the preparation of small toothed combs and all combs made of ivory and boxwood. Saw-cutting is, moreover, the only process formerly adopted, but instead of a circular saw, the comb-maker used a gauged hand-saw called a *stadda* or *steady*. The saws now employed are of small diameter; and, according to the work they have to perform, they are fine-toothed and thin, some of them being constructed to cut from 70 to 80 teeth per lineal inch. The saws are mounted on a spindle which revolves with great rapidity, and the plate or plates of horn to be toothed are clamped up in a holder, which by a cam motion is alternately raised and depressed, bringing the horn each time against the saw, which cuts out one tooth to its full depth. After each cut an automatic arrangement moves the horn forward the breadth of a tooth, the gearing being so mounted that the teeth may be cut fine or coarse at pleasure. The second method of cutting the teeth is known as *twinning*, from the fact that a pair of combs are cut out of a single plate. The process of *twinning* consists in so cutting a plate of horn that the whole material is utilized, what is removed to form the teeth of one comb being exactly sufficient for the teeth of a corresponding opposite comb. When the cutting of *twinned* combs is complete the plate presents the appearance of a pair of combs with their teeth exactly *inoculating* or dovetailing into each other. The *twinning* machine, by which this is accomplished, is a complex and beautiful piece of mechanism. The plates of horn to be *twinned* are softened by heat, and secured in a bed-plate which travels under a pair of cutting chisels, fast or slow, as the teeth are to be cut coarse or fine. The chisels, having cutting edges equal to the length of the teeth to be formed, descend alternately and cut through the plate, but as their cutting edges are at a small angle in relation to each other, the cuts are wedge-formed or tapering, and thus the pointed ends of one comb are taken out of the roots or head of another. With the aid of this apparatus a man and boy can cut more than 2000 combs per day, while an old-fashioned comb-maker working with his hand-saw can only cut from two to three dozen combs daily, and that

with almost double the material required in the twinning process.

After the combs are formed either by circle saw or by twinning, they are next thinned or tapered to their outer edges on grindstones. They then pass to the "grailing" department, where by means of special forms of files or rasps, known as grails and toppers, the individual teeth are rounded or bevelled, tapered, and smoothed. If the combs are to be finished in their natural colors, they are then smoothed with sand-paper, buffed on leather wheels, and polished on wheels built up of discs of soft calico. If, as is frequently the case, the combs are to be finished as imitation tortoise-shell, they are, in the translucent state before alluded to, treated with dilute nitric acid, which communicates a light yellow tinge like the ground color of tortoise-shell. The deep semi-opaque orange spotting is next produced by dropping over the surface spots of a composition containing caustic soda, litharge, and dragon's blood. After some time this composition is washed off, and the parts to which it was applied are found to be a little swollen up and stained a deep orange tinge. The combs are then polished as above stated.

The elaborate pierced patterns of ornamental back combs are cut out by small ribbon saws; and the work is generally finished by hand-carving with proper tools. Plainer and less artistic work is done by embossing in heated dies, and ordinary pierced work is also produced by cutting dies. Formerly the wide set teeth of back combs were frequently stamped out.

In order to economize tortoise-shell, and to obtain large and thick combs out of the comparatively small and thin plates in which that substance usually occurs, a process of cementing or soldering is resorted to. The joining of two plates of tortoise-shell is very perfectly accomplished by first carefully scraping and cleaning the surfaces to be united. They are then applied to each other, heated, and strongly pressed between pincers,—this being sufficient to cause a perfect amalgamation of the two surfaces. After cementation tortoise-shell is treated in every respect as a piece of fine white or buffalo horn.

(J. PA.)

**COMBACONUM**, a town of Southern India in the district of Tanjore, 20 miles from the city of that name and 30 miles from the sea, in 10° 58' N. lat. and 79° 26' E. long. It is a large town with wide and airy streets, and is adorned with pagodas, gateways, and other buildings of considerable pretension. The great gopura, or gate-pyramid, is one of the most imposing buildings of the kind,—rising in twelve stories to a height of upwards of 100 feet, and ornamented with a bewildering profusion of figures of men and animals formed in stucco. One of the water-tanks in the town is popularly reputed to be filled with water admitted from the Ganges every twelve years by a subterranean passage 1200 miles long; and it consequently forms a centre of attraction for large numbers of devotees. A considerable trade is carried on in the town, and weaving is one of its chief industries. The bazaar occupies a long and wide street, and is well supplied with provisions. The city is historically interesting as the capital of the Chola race, one of the oldest Hindu dynasties of which any traces remain, and from which the whole coast of Coromandel, or more properly Cholanundel, derives its name. Population about 40,000.

**COMBE, ANDREW, M.D. (1797-1847)**, was born in Edinburgh, 27th October, 1797. His name holds an honored place in the roll of sanitary reformers. Instead of waiting till disease was developed, he sought its prevention by the adoption of a careful system of hygiene. He served an apprenticeship in a surgery, and in 1817 passed at Surgeons' Hall. He proceeded to Paris to complete his medical studies, and whilst there he investigated phrenology on anatomical principles. He became convinced of the truth of the new science, and as he acquired much skill in the dissection of the brain, he subsequently gave additional interest to the lectures of his brother George, by his practical demonstrations of the convolutions. He returned to Edinburgh in 1819 with the intention of beginning practice; but being attacked by the first symptoms of pulmonary disease, he was obliged to seek health in the south of France and in Italy during the two following winters. He began to practice in 1823, and by careful adherence to the laws of health he was enabled to fulfil the duties of his profession for nine years. During that period he assisted in

editing the *Phrenological Journal* and contributed a number of articles to it, defended phrenology before the Royal Medical Society of Edinburgh, published his *Observations on Mental Derangement* (1831), and prepared the greater portion of his *Principles of Physiology Applied to Health*. The latter work was issued in 1834, and immediately obtained extensive public favor. In 1836 he was appointed physician to Leopold I., king of the Belgians, and removed to Brussels. He had only been there a few months, however, when another severe attack of hæmoptysis warned him that the climate was unsuitable, and would speedily render him unequal to the duties of his position. Scrupulously conscientious in everything, he at once resigned. The king and Baron Stockmar persuaded him to remain a few weeks longer in the hope that he might recover; but they were disappointed. He continued, however, to hold the position of consulting physician to his majesty. In Edinburgh he proceeded to work with renewed energy; he published his *Physiology of Digestion*, and resumed practice as a consulting physician, his advice being eagerly sought by old and new patients and by his professional brethren. In 1838 he was appointed one of the physicians extraordinary to the queen in Scotland. Two years later he completed his *Physiological and Moral Management of Infancy*, which he believed to be his best work, and it was his last. He suffered at intervals from extreme weakness, and in 1842 the symptoms became alarming. His latter years were mostly occupied in seeking at various health resorts some alleviation of his disease; he spent two winters in Madeira, and tried a voyage to the United States, but was compelled to return within a few weeks of the date of his landing at New York. He went on a visit to a nephew at Gorgie, near Edinburgh, and there he died on the 9th August, 1847. His last literary effort was a paper on ship-fever, which was published in the *Times* after his death; its principal suggestions have been carried out by the Act 12 and 13 Vict. c. 23. His biography, written by George Combe, was published in 1850.

**COMBE, GEORGE (1788-1858)**, was born in Edinburgh, 21st October, 1788. As the first advocate in this country of the phrenological doctrines of Gall and Spurzheim, and as the author of *The Constitution of Man Considered in Relation to External Objects*, he attracted much attention in Britain, on the Continent, and in America. His father was a brewer,—a man of shrewd business qualities and of a benevolent disposition, and a strict observer of Calvinistic practices; and his children—nine daughters and eight sons—were placed under a rigid system of religious instruction. In a fragment of autobiography written by Combe shortly before his death, he complains of the irksomeness of the Sunday observances and tasks imposed on his father's household. His frame was feeble; the Sunday tasks followed weeks of severe mental labor at school, and, so far from cultivating in him a religious spirit, they rendered the church, Sunday, and the Catechisms sources of weariness and terror to him. His character was earnest and thoughtful even as a child; and feelings of despondency thus engendered were intensified by the weakness of his constitution. His mind became largely occupied with the current theological theories, and, in time, with doubts of their truth. He attended the High School for five years, and then proceeded to the university. In 1804 he entered a lawyer's office as an apprentice, and applied himself diligently to the acquirement of the details of his profession. At the same time he assisted his younger brothers and sisters in their studies, and read philosophy, history, and general literature; philosophical works, however, had most attraction for him; in 1812 he obtained his commission as writer to the signet, and soon after, that of notary public. His shrewdness and conscientiousness in dealing with clients speedily obtained for him a degree of practice which exceeded his expectations. Meanwhile, in private, he had vague yearnings to accomplish something which might benefit mankind. In 1815 the *Edinburgh Review* contained an article on Gall and Spurzheim's system of "craniology," which the reviewer denounced as "a piece of thorough quackery from beginning to end." Combe laughed like others at the absurdities of this so-called new theory of the brain, and thought that it must be finally exploded after such an exposure; and when Dr. Spurzheim delivered lectures in Edinburgh, in refutation of the statements of his critic, Combe considered the subject unworthy

of serious attention. He was, however, invited to a friend's house, where he saw Spurzheim dissect the brain, and he was so far impressed by the demonstration that he attended the second course of lectures. - Proceeding to investigate the subject for himself, he became satisfied, after two years of study and observation, that the fundamental principles of phrenology were true—namely “that the brain is the organ of mind; that the brain is an aggregate of several parts, each subserving a distinct mental faculty; and that the size of the cerebral organ is, *ceteris paribus*, an index of power or energy of function.” He had moved slowly at first; he now pursued his investigations with enthusiasm. He compared the known characteristics of friends with their phrenological developments; he studied anatomy; he visited schools, prisons, and large manufactories; and he became more and more satisfied that he was approaching a truth which would be of great value to humanity. He requested his brother Dr. Andrew Combe—who was at that time a medical student in Paris—to give particular attention to the dissection of the brain, in order to be prepared to support or to condemn the new theories on anatomical principles. In 1817 his first essay on phrenology was published in the *Scots Magazine*; and a series of papers on the same subject appeared soon afterwards in the *Literary and Statistical Magazine*; these were collected and published in 1819 in book form as *Essays on Phrenology*. His friends became alarmed by his public advocacy of a cause which was the laughing-stock of all men of reputation, and warned him that it would be the ruin of his professional prospects. He was not diverted from his course, and he had the satisfaction of finding his business increase; for the many who laughed at his hobby or regretted it still recognized his assiduity in attending to the affairs of his clients. The *Essays* gave an extraordinary impetus to the new science; friends and foes became numerous; a phrenological society was founded; the *Phrenological Journal* was established, and was published quarterly for twenty years; a volume of *Phrenological Transactions* was issued; and Combe's first work developed into *A System of Phrenology* in two large volumes, of which five editions have been published. By his lectures and writings he attracted public attention to the subject on the Continent and in America, as well as at home; and a long discussion with Sir William Hamilton in 1827-28 excited general interest.

The publication of his most popular work, *The Constitution of Man*, was determined upon after serious deliberation. He had circulated private copies amongst his friends, several of whom regarded the principles of the essay as dangerous to society and urged him to suppress it. The principle on which he based his argument was that all the laws of nature were in harmony with each other, and that man would best fulfil God's will, and attain the greatest happiness of himself, by discovering those laws and obeying them. He saw nothing irreligious in this principle; he believed that on the contrary it supplied a philosophical basis to religion. When the book was published in 1828, he was charged by the church party with being a materialist and an atheist; but, on the other hand, he received from near and distant quarters grateful thanks for the new light his work had shed upon religion, and for the satisfaction it afforded to doubting minds. As one indication of the estimation which the work obtained, it is notable that amongst many editions in America there was one for the blind. From this date the current of Combe's public life broadened; he became strong in his own convictions of the truth, and consequently more resolute in carrying them to practical issues. He might hesitate at first, doubting himself; but once satisfied that he was right, he never faltered. He saw everything by the light of phrenology, and the light rendered him patient of the opposition of others, and guided him to the most earnest efforts to benefit his fellow-creatures, morally and socially. He gave time, labor, and money to help forward the education of the poorer classes; he established the first infant school in Edinburgh under the direction of Mr. Wilderspin; and he originated a series of evening lectures on chemistry, physiology, history, and moral philosophy—the lectures on the latter subject being delivered by himself. He studied the criminal classes, and tried to solve the problem how to reform as well as to punish them; and he strove to introduce into lunatic asylums a humane system of treatment. In 1838 he offered himself as a candidate for the chair of logic in the Edinburgh Univer-

sity, and the testimonials submitted on his behalf on that occasion show that he was held in high esteem by men of very opposite opinions. As he had expected, he was rejected by the town council in favor of Sir William Hamilton.

Having received numerous invitations to visit America, he proceeded thither in 1838, and about two years were occupied in lecturing in the principal States on phrenology, education, and the treatment of the criminal classes. On his return in 1840 he published his *Moral Philosophy*, and in the following year his *Notes on the United States of North America*. In 1842 he delivered, in German, a course of twenty-two lectures in the university of Heidelberg—being the first Englishman who had ventured to lecture there in the national language. But the effort resulted in an illness which prostrated him for some time. He continued to travel much on the Continent—inquiring into the management of schools, prisons, and asylums. The commercial crisis of 1855 elicited his remarkable pamphlet on *The Currency Question*. The culmination of the religious thought and experience of his life is contained in his work *On the Relation between Science and Religion*, first publicly issued in 1857, and now in its fifth edition. Writing pamphlets, contributing to periodicals, lecturing, and correcting the new editions of his work rendered his days busy to the last. He was engaged in revising the ninth edition of the *Constitution of Man* when he died at Moor Park, Farnham, 14th August, 1858. He had married in 1833 Cecilia Siddons, a daughter of the great actress. She had been the companion of all his travels, and she was with him at the end. Apart from his position as a phrenologist he earned distinction by his efforts on behalf of education, and by his courage in promulgating certain philosophic truths, which at the time were regarded as subversive of everything good, but are now accepted so entirely as matters of course that his share in obtaining recognition for them is apt to be forgotten. (C. G.)

COMBE, WILLIAM (1741-1823), an anonymous hack writer of great fertility and of some merit, was born at Bristol in 1741. The circumstances of his birth and parentage are somewhat doubtful, and it is questioned whether his father was a rich Bristol merchant, or a certain William Alexander, a London alderman, who died in 1763. Be this as it may, it is certain that Combe was educated at Eton, with Fox, Lyttelton, and William Beckford; that Alexander bequeathed him some £2000—a little fortune that soon disappeared in a course of splendid extravagance, which gained him the nickname of Count Combe; and that he finally fixed his residence in London (about 1771), as a law student and bookseller's hack. In 1775 he published *The Philosopher in Bristol*, a series of essays of merely local interest; and in 1776 he made his first success in London with *The Diaboliad*, a satire full of bitter personalities. Four years afterwards (1780) he became an inmate of the King's Bench; and much of his subsequent life was spent in prison. He appears to have written a correspondence between Sterne and Eliza Draper, and also the *Letters of the Late Lord Lyttelton* (1780). Periodical literature of all sorts—pamphlets, satires, burlesques, “two thousand columns for the papers,” “two hundred biographies,” *The Origin of Commerce*—filled up the next years, and about 1789 Combe was receiving £200 yearly from Pitt. Six volumes of a *Devil on Two Sticks in England* caused him to be saluted as “the English Le Sage;” in 1794-96 he wrote the text for Boydell's *History of the River Thames*; in 1803, he was placed on *The Times*. In 1807 *All the Talents*, a satire, appeared; it ran through twenty editions and is generally attributed to Combe. In 1809-11 he wrote for Ackerman's *Political Magazine* the famous *Three Tours of Dr. Syntax*, which, owing greatly to Rowlandson's designs, had an immense success. Then came poems in illustration of drawings by Princess Elizabeth, *The Military Adventures of Johnny Newcombe* (1815), *The English Dance of Death* (1815-16), *The Dance of Life* (1816-17), *The Adventures of Johnny Quas Genus* (1822)—all written for Rowlandson's caricatures; together with *Histories of Oxford and Cambridge*, *Pictureque Tours* along the Rhine and other rivers, *Histories of Madeira*, *Antiquities of York*, texts for *Turner's Southern Coast Views*, and contributions innumerable to the *Literary Repository*. In his later years, notwithstanding a by no means unsullied character, Combe was courted for the sake of his charming conversation and inexhaustible stock of anecdote. He is said to have writ-

ten and burned his autobiography; but it does not appear that the loss of this memorial is to be regretted. He died in London in 1823.

Brief obituary memoirs of Combe appeared in Aekermann's *Literary Repository* and in the *Gentleman's Magazine* for August, 1823; and in May, 1859, a list of his works, drawn up by his own hand, was printed in the latter periodical. See also *Diary of H. Crabb Robinson, Notes and Queries* for 1869, and a paper in the *Churchman's Shilling Magazine* for the same year.

COMBERMERE, STAPLETON COTTON, FIRST VISCOUNT (1773-1865), was the second son of Sir Robert Salusbury Cotton of Combermere Abbey, Cheshire, and was born, 14th November, 1773, at one of the family estates in Denbighshire. As a boy he was distinguished for his vivacity, courage, and fondness of field sports. He was educated at Westminster School, and when only sixteen, obtained through his father a second lieutenancy in the 23d Regiment, or Royal Welsh Fusiliers. A few years afterwards (1793) he became by purchase captain of the 6th Dragoon Guards, accompanying them during the disastrous expedition to Flanders against the French. Subsequently, and while yet in his twentieth year, he joined the 25th Light Dragoons as lieutenant-colonel, and, while in attendance with his regiment on George III. at Weymouth, he became a great favorite of the king's. In 1796 he went with his regiment to India, and in 1799, under Lord Harris and along with Colonel Wellesley, he distinguished himself in the war with Tippoo Saib, and at the storming of Seringapatam. In 1808, being now major-general, he was sent to the seat of war in Portugal, where he shortly rose to the position of commander-in-chief of cavalry under Wellington, and it was here that he most displayed that personal courage, swiftness of action, and judgment which won for him his fame as a cavalry officer. His share in the battle of Salamanca (July 22, 1812), was especially marked, and received the personal thanks of Wellington. The day after, he was accidentally wounded in the left arm by a shot from one of the Portuguese allies. On the conclusion of peace in 1814, General Cotton was raised to the peerage under the style of Baron Combermere. He was not present at Waterloo, the command which he expected, and bitterly regretted not receiving, having been given to Lord Uxbridge. In 1817 he was appointed governor of Barbados and commander of the West Indian forces. His active military life was concluded in India (1826), where he besieged and took Bhartpur—a fort which twenty-two years previously had defied the genius of Lake, and was deemed impregnable. For this service he was created Viscount Combermere. A long period of peace and honor still remained to him at home. In 1834 he was sworn a privy councillor, and in 1852 he succeeded his old chief as constable of the Tower and lord lieutenant of the Tower Hamlets. In 1855 he received a marshal's baton, and was made G.C.B. He discharged his duties to the last, and died at Clifton in his ninety-second year. An equestrian statue in bronze, the work of Baron Marochetti, has been raised in his honor by the inhabitants of Chester. In private life Lord Combermere was most exemplary, and the means by which he attained health and longevity (as detailed in the memoir by Viscountess Combermere and Captain Knollys, 2 vols., 1866,) afford an interesting illustration of what can be done by the exercise of a strict control over appetite and by a regular regimen:—

"On the 14th November, 1863, Lord Combermere had reached his ninetieth year, still in the full possession of his mental faculties, and with his usual activity very little impaired; indeed, the only infirmities which afflicted him were deafness and occasional weakness of the limbs, arising as much from slight rheumatism as a failure of general strength. He still rode three hours daily, and walked short distances with his usual alert step and upright carriage. His voice was as strong, his hand as steady as ever, and he wrote clearly and rapidly without spectacles, which he never used except by candle-light. The wonderful memory for which he had always been remarkable never failed, and while it recalled long past events with surprising accuracy, registered and reproduced those of more recent date with equal exactness. No one could detect any failure in his quick perception or ready conclusions, nor did he betray even the most trifling of those mental deficiencies often attendant on a lesser age than his. When eighty-seven, he had danced a quadrille at a rural fête as lightly as his grandchildren, and at eighty could climb over a hurdle with ease. All these immunities from disease and decrepitude were secured by the

invariable moderation which, in spite of service in various climates, left his naturally vigorous constitution unimpaired up to the very end. He rose very early in summer, and the last few years of his life rode an hour before breakfast. This meal was always very simple, and without meat of any kind. At half-past one a small luncheon and half a glass of wine satisfied him until dinner. This last was his largest meal, at which he partook plentifully of meat, and drank, for the last fifteen years, one pint of light sherry. Tea or coffee he never touched in early life, afterwards seldom indulging at breakfast in the former, usually drinking instead cocoa, as the most wholesome beverage. Plain meat, bread, and potatoes constituted his dinner, and he never for twenty-six years once transgressed the rule which he had determined to observe, of eating only what was wholesome, and avoiding fruit, vegetables, beer, champagne, salt meat, condiments, and every other article proscribed by the most rigid dietetics. Besides carefully rejecting all unwholesome food, he made it a practice to eat so slowly that he was always longer than any one else at meals. Few could resist as he did the temptation of a well-supplied table, which he wished to be luxurious for others, while he contented himself with simple fare, enjoying only the sight of the fine fruits furnished from his productive houses and well-cultivated gardens.

"Such abstinence would to many be impracticable; but Lord Combermere possessed a power of self-control which few can compass. As an instance of this, after having long indulged in the habit of taking snuff incessantly, he relinquished it suddenly and entirely. Continual smoking had equally been a practice of his earlier life, until, becoming aware of its evil effects on his health, he restricted himself to two small cigars nightly."

COMBINATIONS among workmen for the purpose of raising their wages, or otherwise altering the terms of their service, were for a long time expressly prohibited by statute. While the state attempted to interfere in the regulation of wages, any combination to defeat the statutory rate would naturally be looked upon with disfavor; and we need hardly be surprised to find that in 1425 a statute was actually passed, making it felony for masons to confederate together to raise their wages above the amount fixed for them by the law. The spirit of such legislation survived to the times in which economical principles might be supposed to have been better understood. The Act of 39 and 40 Geo. III. c. 106 (repealing an Act of the previous session on the same subject) made illegal all contracts for obtaining advance of wages or for altering the hours of work, except contracts made between masters and men; and every workman entering into any such contract was liable to be committed to the common jail for three months on conviction before two justices of the peace. The same punishment was reserved for workmen entering into any combination for the same purpose. For the more effectual suppression of combinations among workmen, it was enacted that persons attending any meeting for the furtherance of such contracts and combinations, or persuading or intimidating persons into attending such meetings, or collecting subscriptions for such purposes, should also be liable to be sent to jail for three months by two justices. A law so severe and so one-sided had its natural effect in promoting secret combinations and provoking acts of violence. In 1825, after an inquiry by a committee of the House of Commons, the 6 Geo. IV. c. 129 (repealing an Act on the same subject in the previous session) was passed, whereby a vast number of recited statutes relating to masters and workmen, and generally all enactments relative to combinations of workmen, were repealed. Combinations among workmen were thus relieved from the oppressive statutes specially directed against them. The Trade Unions Act, 1871, further enacted that the purposes of any trade union shall, not by reason merely that they are in restraint of trade, be unlawful so as to render a member liable to prosecution for conspiracy or otherwise, or to render void or voidable any agreement or trust. The Act specifies certain agreements which may not be enforced in the courts, but which are still not to be regarded as unlawful. It also provides for the registration of trade unions. Their legal position under the criminal law, and the results of recent legislation on the subject, will be discussed under the heading CONSPIRACY. For an account of their history and economical relations see the article on TRADE UNIONS.

COMEDY. See DRAMA.

COMENIUS, or KOMENSKY, JOHANN AMOS (1592-1671), a famous writer on education, and the last bishop of the old church of the Moravian and Bohemian Brethren, was born at Comna, or, according to another account, at Niwnitz, in

Moravia, of poor parents belonging to the sect of the Moravian Brethren. Having studied at Herborn and Heidelberg, and travelled in Holland and England, he became rector of a school at Prerau, and after that pastor and rector of a school at Fulnek. In 1621 the Spanish invasion and persecution of the Protestants robbed him of all he possessed, and drove him into Poland. Soon after he was made bishop of the church of the Brethren. He supported himself by teaching Latin at Lissa, and it was here that he published his *Pansophia Prodomus* (1630), a work on education, and his *Janua Linguarum Reserata* (1631), the latter of which gained for him a great and wide-spread reputation, being produced in twelve European languages, and also in Arabic, Persian, and Turkish. He subsequently published several other works of a similar kind, as the *Eruditionis Scholasticae Janua* and the *Janua Linguarum Trilinguis*. His method of teaching languages, which he seems to have been the first to adopt, consisted in giving, in parallel columns, sentences conveying useful information, in the vernacular and the languages intended to be taught (i. e., in Comenius's works, Latin and sometimes Greek). In some of his books, as the *Orbis Sensualium Pictus* (1658), pictures are added; this work is, indeed, the first children's picture-book. In 1638 Comenius was requested by the Government of Sweden to draw up a scheme for the management of the schools of that country; and a few years after he was invited to join the commission that the English Parliament then intended to appoint, in order to reform the system of education. He visited England in 1641, but the disturbed state of politics prevented the appointment of the commission, and Comenius passed over to Sweden in August, 1642. The great Swedish minister, Oxenstiern, obtained for him a pension, and a commission to furnish a plan for regulating the Swedish schools according to his own method. Devoting himself to the elaboration of his scheme, Comenius settled first at Elbing, and then at Lissa; but, at the burning of the latter city by the Poles, he lost nearly all his manuscripts, and he finally removed to Amsterdam, where he died in 1671.

As a theologian, Comenius was greatly influenced by Boehme. In his *Synopsis Physicae ad Lumen Divinum Reformatae* he gives a physical theory of his own, said to be taken from the book of Genesis. He was also famous for his prophecies, and the support he gave to visionaries. In his *Lux in Tenebris* he published the visions of Kotterus, Dabricius, and Christina Poniatovia. Attempting to interpret the book of Revelation, he promised the millennium in 1672, and guaranteed miraculous assistance to those who would undertake the destruction of the Pope and the house of Austria, even venturing to prophesy that Cromwell, Gustavus Adolphus, and Ragotski, prince of Transylvania, would perform the task. He also wrote to Louis XIV., informing him that the empire of the world should be his reward if he would overthrow the enemies of God.

Comenius also wrote against the Socinians, and published three historical works—*Ratio Disciplinæ Ordiniq; in Unitate Fratrum Bohemorum*, which was republished with remarks by Budeus, *Historia Persecutionum Ecclesiae Bohemicae* (1648), and *Martyrologium Bohemicum*. See Raumer's *Geschichte der Pädagogik*, and Carpoz's *Religionsunterreuchung der Böhmischen und Mährischen Brüder*.

COMET. In the present article it is proposed to exhibit formulæ by means of which the orbital elements of a comet may be determined from three observations, assuming the comet to move in a parabola, an hypothesis upon which the apparent paths of the great majority of these bodies may be closely represented, appending thereto a fully-worked example of the practical application of the formulæ; also to put the reader in possession of methods now employed for calculating ephemerides of the apparent positions of a comet, and to assist in observation. The limits within which we are confined will necessitate reference to other works for demonstration of our formulæ, but care will be taken to name those authorities which are not only most accessible, but by which the subject has been most clearly treated.

A list of comets of short or moderate period, so far as known at present, a class which offers particular interest to the student of this branch of astronomy, will likewise be included.

The method of calculating a parabolic orbit from three observations which we shall follow is the comparatively expeditious one proposed by Olbers, and demonstrated in his *Abhandlung über die leichteste und bequemste Methode die Bahn eines Cometen zu berechnen*, first published at Weimar in 1797, and since twice reprinted with considerable modifications and additions. The method is founded upon the principle that, if  $a c$  be the chord between the extreme positions of the comet in its orbit, and  $A C$  the similar chord of the earth's path, the radii-vectors at the middle position cut  $a c$  and  $A C$  proportionally to the times occupied in describing the arcs, a supposition which, though not mathematically exact, is but little in error if the intervals between the observations are pretty nearly equal, and the arcs described small.

It may be convenient if the notation employed in the subsequent formulæ be given here, at least as regards the principal quantities entering into our calculations.

- t.....Time of observation (in decimals of a day).
- R. A.....Right Ascension.
- δ.....Declination; + N, - S.
- α.....Geocentric longitude.
- β....." " latitude.
- Δ.....True distance of comet from the earth.
- ρ = Δ cos. β.....Curtate distance of comet from the earth.
- θ.....Comet's heliocentric longitude, on the ecliptic.
- λ....." " latitude.
- r....." " radius-vector.
- A.....Sun's true longitude.
- R.....Earth's radius-vector.
- u.....The argument of latitude or distance of the comet from the ascending node.
- T.....The epoch of perihelion passage, expressed in the same manner as t.
- ω.....The longitude of the perihelion, reckoned on the ecliptic to the node and thence on the orbit.
- Ω.....The longitude of the ascending node.
- i.....The inclination of the comet's orbit to the ecliptic.
- q.....The perihelion distance, expressed, like other distances in astronomical calculations, in parts of the earth's mean distance from the sun.
- v.....The comet's true anomaly.

We suppose that the observations furnish three complete positions of the comet referred as usual to the equator, or expressed in right ascension and declination, with the mean times of observation at the respective places.

The first step will be to convert the observed right ascensions and declinations into longitudes ( $a$ ) and latitudes ( $\beta$ ), thus:—

$$\text{Put } \tan. N = \frac{\tan. \delta}{\sin. R.A.} \text{ Then, } \tan. a = \frac{\cos. (N - \epsilon)}{\cos. N} \tan. R.A.$$

$$\text{And } \tan. \beta = \tan. (N - \epsilon) \sin. a \dots \left\{ \begin{array}{l} \text{the obliquity of the ecliptic at date, from the} \\ \text{Nautical Almanac.} \end{array} \right.$$

Thus we find  $a'$ ,  $a''$ ,  $a'''$ , and  $\beta'$ ,  $\beta''$ ,  $\beta'''$ , where the quantities with one accent apply to the first observation, those with two accents to the second place, and with three accents, to the last observation. This is to be understood throughout our formulæ for the calculation of the orbit.

Now reduce the times of observation to the meridian of Greenwich by applying the longitude of the place of observation with its proper sign, and convert the times so reduced into decimals of a day; thus we have  $t'$ ,  $t''$ ,  $t'''$ .

For each of these times interpolate from monthly page iii., in the *Nautical Almanac*, the sun's longitude ( $A$ ) and the logarithm of the earth's radius-vector ( $R$ ); the sun's longitude in the Almanac being *apparent*, the amount of aberration ( $20'' \cdot 42 + R$ ), which is given in another part of the ephemeris, must be added to the *apparent* longitude, to obtain the *true* longitude required in the calculation. We have then  $A'$ ,  $A''$ ,  $A'''$  and the logarithms of  $R'$ ,  $R''$ ,  $R'''$ , and are ready to proceed with the application of Olbers's method.

We commence by calculating  $M$  or  $\frac{\rho'''}{\rho'}$ , the ratio of the comet's curtate distances from the earth at the first and third observations from

$$M = \frac{\tan. \beta'' \sin. (a' - A'') - \tan. \beta' \sin. (a'' - A''')}{\tan. \beta''' \sin. (a'' - A''') - \tan. \beta'' \sin. (a''' - A''')} \frac{t''' - t''}{t'' - t'} \quad \{ (L) \}$$

$$\text{or rather more conveniently, by putting } m = \frac{\tan. \beta''}{\sin. (a'' - A''')}$$

from

$$M = \frac{m \cdot \sin. (\alpha' - A') - \tan. \beta'}{\tan. \beta''' - m \cdot \sin. (\alpha''' - A')} \left\{ \frac{t''' - t'}{t'' - t'} \right\} \dots (II.)$$

The following equations must then be formed ( $k$  is the chord of the comet-orbit between the extreme observations):

$$\left. \begin{aligned} r'^2 &= R'^2 - 2R' \cdot \cos. (\alpha' - A') \cdot \rho' + \sec. \beta'^2 \cdot \rho'^2 \\ r''^2 &= R''^2 - 2R'' \cdot M \cdot \cos. (\alpha''' - A''') \rho'' + \sec. \beta''^2 \cdot M^2 \cdot \rho''^2 \\ k^2 &= (r'^2 + r''^2) - 2R' \cdot R'' \cdot \cos. (A''' - A') \\ &\quad + 2R'' \cdot \cos. (\alpha' - A') \rho' + 2R' \cdot M \cdot \cos. (\alpha''' - A''') \cdot \rho'' \\ &\quad - 2M \cdot \cos. (\alpha''' - \alpha') \rho'^2 - 2M \cdot \tan. \beta' \cdot \tan. \beta''' \cdot \rho'^2 \end{aligned} \right\} (III.)$$

If  $(t'' - t')$  be the interval of time between the first and third observations we have, by Lambert's theorem,

$$\left( \frac{r' + r'' + k}{2} \right)^{\frac{3}{2}} - \left( \frac{r' + r''' - k}{2} \right)^{\frac{3}{2}} = 3m \cdot \sqrt{2}$$

With an assumed value for  $\rho'$  we calculate  $r'$ ,  $r'''$ , and  $k$ , and then  $t'''$  for comparison with the observed interval between the first and third observations, and vary  $\rho'$  in successive trials until the observed and calculated values agree. In this solution of the above equations by the method of trial and error, a first approximate value of  $\rho'$  may be inferred as follows:—

Writing the equation for  $k^2$

$$k^2 = F + G \cdot \rho' + H \rho'^2, \text{ assume } \tan. \psi = \frac{2H}{G} \sqrt{\frac{F}{H}}; \text{ then } \rho = \tan. \frac{1}{2} \psi \cdot \sqrt{\frac{F}{H}} (IV.)$$

The amount and direction of the error of interval between the extreme times of observation, resulting from this first value of  $\rho'$ , will, after a little experience, guide the computer to another value nearer to the true one; and the error of the second assumption, compared with that of the first, again leads to a much closer value for the third approximation, and so on till the assumed value of  $\rho'$  produces an agreement between the calculated and observed intervals. In practice we have not found any great advantage on adopting one or other of the devices suggested for obtaining successive values of  $\rho'$  by use of tables or otherwise—the simple method of continued approximation, by deducing a new value of the curvate distance proportional to the errors in the two preceding assumptions, will be found in the great majority of cases sufficiently expeditious and as little troublesome as any other.

In working Lambert's equation, proceed as follows:—

$$\text{Put } B = \frac{r' + r''' + k}{2} \quad D = \frac{r' + r'' - k}{2} \dots (V.)$$

$\log. s' = \log. B + \frac{1}{2} \log. B + 1.4378117$   
 $\log. s'' = \log. D + \frac{1}{2} \log. D + 1.4378117$   
 $s' - s'' =$  the time of describing the chord, expressed in days and decimals.

The approximations to  $\rho'$  may be continued until  $s' - s''$  agrees with  $(t''' - t')$ , within 2 or 3 in the fifth place of decimals, though if the computer has only rough observations at command, a larger error may be tolerated.

The comet's curvate distance from the earth at the third observation is given by

$$\rho''' = M \rho'$$

With the final values of  $r'$ ,  $r'''$ ,  $\rho'$  and  $\rho'''$ , the direct calculation of the elements of the orbit commences.

The heliocentric longitudes  $\theta'$ ,  $\theta'''$ , and latitudes  $\lambda'$ ,  $\lambda'''$ , are obtained from

$$\left. \begin{aligned} r' \cdot \cos. \lambda' \cdot \sin. (\theta' - A') &= \rho' \cdot \sin. (\alpha' - A') \\ r' \cdot \cos. \lambda' \cdot \cos. (\theta' - A') &= \rho' \cdot \cos. (\alpha' - A') - R' \\ r' \cdot \sin. \lambda' &= -\rho' \cdot \tan. \beta' \end{aligned} \right\} (VI.)$$

$$\left. \begin{aligned} r''' \cdot \cos. \lambda''' \cdot \sin. (\theta''' - A''') &= \rho''' \cdot \sin. (\alpha''' - A''') \\ r''' \cdot \cos. \lambda''' \cdot \cos. (\theta''' - A''') &= \rho''' \cdot \cos. (\alpha''' - A''') - R''' \\ r''' \cdot \sin. \lambda''' &= -\rho''' \cdot \tan. \beta''' \end{aligned} \right\}$$

in which equations the right-hand quantities are known.

The values of  $r'$  and  $r'''$ , resulting from these equations, should agree with the preceding ones if the calculations have been correctly performed. This agreement forms the first verification of the work.

If  $\theta'''$  is in advance of  $\theta'$ , the motion in the orbit is direct; if the contrary be the case, the motion is retrograde.

Then, if the motion be direct, the longitude of the ascending node ( $\Omega$ ) and inclination of the orbit to the ecliptic ( $i$ ) will be found from

$$\left. \begin{aligned} \tan. i \cdot \sin. (\theta' - \Omega) &= \tan. \lambda' \\ \tan. i \cdot \cos. (\theta' - \Omega) &= \frac{\tan. \lambda''' - \tan. \lambda' \cdot \cos. (\theta''' - \theta')}{\sin. (\theta''' - \theta')} \end{aligned} \right\} (VII.);$$

and if the motion be retrograde from

$$\left. \begin{aligned} \tan. i \cdot \sin. (\Omega - \theta') &= \tan. \lambda' \\ \tan. i \cdot \sin. (\Omega - \theta') &= \frac{\tan. \lambda''' - \tan. \lambda' \cdot \cos. (\theta' - \theta''')}{\sin. (\theta' - \theta''')} \end{aligned} \right\}$$

The distances of the comet from the ascending node reckoned upon the orbit, at the first and third observations ( $u'$ ,  $u'''$ ), are given in the case of direct motion by

$$\tan. u' = \frac{\tan. (\theta' - \Omega)}{\cos. i} \quad \tan. u''' = \frac{\tan. (\theta''' - \Omega)}{\cos. i} \quad (VIII.);$$

or, if the motion be retrograde, by

$$\tan. u' = \frac{\tan. (\Omega - \theta')}{\cos. i} \quad \tan. u''' = \frac{\tan. (\Omega - \theta''')}{\cos. i}.$$

The arc  $u''' - u'$  is equal to the difference of true anomalies, and the true anomaly at the first observation ( $v'$ ) will be obtained from

$$\tan. \frac{1}{2} v' = \cotan. \frac{1}{2} (u''' - u') - \frac{\sqrt{r'''}}{\sin. \frac{1}{2} (u''' - u')} \dots (IX.)$$

or from

$$\tan. \frac{1}{2} v' = \frac{\sqrt{r'''} \cdot \cos. \frac{1}{2} (u''' - u') - \sqrt{r'}}{\sqrt{r'''} \cdot \sin. \frac{1}{2} (u''' - u')} \quad v'' = v' + u''' - u'$$

The perihelion distance ( $q$ ) =  $r' \cdot \cos. \frac{1}{2} v' - r''' \cdot \cos. \frac{1}{2} v''$ . The longitude of the perihelion, reckoned on the ecliptic to the node and thence on the orbit, is given by

$$\left. \begin{aligned} \pi &= \Omega + u' - v' \dots \text{for direct motion} \\ \pi &= \Omega + v' - u' \dots \text{for retrograde motion} \end{aligned} \right\} (X.)$$

As a further verification of the calculations, we have—

$$k^2 = r'^2 + r''^2 - 2r' \cdot r'' \cdot \cos. (u''' - u'), \dots (XI.)$$

which should give the former value of  $k$ .

We have now only to determine the time of perihelion passage ( $T$ ), by finding the interval between the first observation and the perihelion ( $\tau$ ) from  $v'$  and  $q$ , by means of the equation—

$$\tau = \frac{(2q)^{\frac{3}{2}}}{2k} \left( \tan. \frac{1}{2} v' + \frac{1}{2} \tan. \frac{3}{2} v' \right) k \text{ being the Gaussian constant } [8.2355814] \quad (XII.)$$

$$= \frac{(2q)^{\frac{3}{2}}}{[8.5366114]} (\tan. \frac{1}{2} v' + [9.5228787] \tan. \frac{3}{2} v').$$

Similarly we may find the interval from the third observation to perihelion by substituting  $v''$  for  $v'$ ; the times thus separately determined should agree, and this agreement will afford a third check upon the accuracy of our work.

Thus the whole of the elements of the parabolic orbit are found, and it is always desirable to ascertain how the geocentric place calculated from these elements for the time of the second observation agrees with the position observed; the first and third places are necessarily represented.

In the computation of a geocentric position from parabolic elements we may proceed thus:

Find the interval from perihelion passage to the time for which we require to compute  $(t - T)$ , in days and decimals.

$$\left. \begin{aligned} \text{Put } \cotan. 2v &= 3k(2q) - \frac{1}{2}(t - T) \\ \cotan. \xi &= \sqrt{\cotan. v} \\ \text{then } \tan. \frac{1}{2} v - 2 &= \cotan. 2\xi \quad \tau = \frac{q}{\cos. \frac{1}{2} v} \end{aligned} \right\} \dots (XIII.)$$

We have thus the true anomaly and radius-vector. Then, if the motion be direct,—

$$\left. \begin{aligned} \cos. \lambda \cdot \cos. (\theta - \Omega) &= \cos. (v + \pi - \Omega) \\ \cos. \lambda \cdot \sin. (\theta - \Omega) &= \sin. (v + \pi - \Omega) \cdot \cos. i \\ \sin. \lambda &= \sin. (v + \pi - \Omega) \cdot \sin. i \end{aligned} \right\} \dots (XIV.)$$

or, if the motion be retrograde,—

$$\left. \begin{aligned} \cos. \lambda \cdot \cos. (\Omega - \theta) &= \cos. (v - \pi + \Omega) \\ \cos. \lambda \cdot \sin. (\Omega - \theta) &= \sin. (v - \pi + \Omega) \cdot \cos. i \\ \sin. \lambda &= \sin. (v - \pi + \Omega) \cdot \sin. i \end{aligned} \right\} \dots (XV.)$$

—equations which give the heliocentric longitude and latitude ( $\theta, \lambda$ ). The geocentric longitude and latitude ( $\alpha, \beta$ ) and the true distance from the earth ( $\Delta$ ) are then obtained from—

$$\left. \begin{aligned} \Delta \cos. \beta \sin. (a-A) &= r \cos. \lambda \sin. (\theta - A) \\ \Delta \cos. \beta \cos. (a-A) &= r \cos. \lambda \cos. (\theta - A) + R \\ \Delta \sin. \beta &= r \sin. \lambda \end{aligned} \right\} \text{ (XVI.)}$$

If the position of the comet as referred to the equator is required,—

$$\text{Put } \tan. N = \frac{\tan. \beta}{\sin. a} \text{ } \dots \dots \dots \text{ (XVII.)}$$

Then

$$\tan. R.A. - \frac{\cos. (N+e)}{\cos. N} \tan. a \tan. \dots \text{Decl.} = \tan. (N+e) \sin. R.A.$$

As an example of the calculation of the orbit of a comet by Olbers's method, we will compute the elements of the comet discovered at the Observatory of Marseilles by M. Borrelly on the 6th of December, 1874, employing three observations taken at that Observatory on December, 7, 16, and 26, viz. :—

1874.	Mean Time at Marseilles.			Comet's Right Ascension.			Comet's Declination.		
	H.	M.	S.	H.	M.	S.	H.	M.	S.
Dec. 7.....	6	40	52	16	0	24-52	+ 36	38	50
" 16.....	16	43	31	16	11	5-82	+ 45	37	37
" 26.....	6	18	0	16	24	58-97	+ 55	34	12

Converting the right ascensions into arc, and the times into decimals of a day, after subtracting 21<sup>m</sup> 35<sup>s</sup> from them, for reduction to the meridian of Greenwich, we have—

Dec.	Greenwich Mean Times.	Right Ascension (arc).	Declination.
.....	7-26339	240 6 8	+ 36 38 50
"	16-68190	242 46 27	+ 45 37 37
"	26-24751	246 14 45	+ 55 34 12

The obliquity of the ecliptic, from the *Nautical Almanac*, was 23° 27' 28", and hence by the formulæ p. 164, we find the following positions referred to the plane of the ecliptic, and interpolating for the above times from the same ephemeris the corresponding longitudes of the sun and log. radii-vectors of the earth, correcting the sun's longitudes for aberration, and reducing all to mean equinox of 1875-0.

a' .....	225 2 50	β' .....	+ 53 31 52
a'' .....	221 47 16	β'' .....	+ 64 35 27
a''' .....	212 44 3	β''' .....	+ 74 17 30
A' .....	255 32 49	Log. R' .....	9-9933590
A'' .....	265 7 46	" R'' .....	9-9929263
A''' .....	274 52 15	" R''' .....	9-9926916

The right ascension and declination are thus converted into longitude and latitude for the first observation:—

R.A. ....	240 6 8	Log. sin. a. ....	9-8497775
δ. ....	+ 36 38 50	Log. tan. (N-e) ..	0-3135946
Log. tan. δ. ....	+ 9-8715409	Log. tan. β. ....	+ 0-1633721
Log. sin. R.A. ....	+ 9-9379771	β. ....	53 31 52
Log. tan. N. ....	+ 9-9335638		
N. ....	139 21 56		
e. ....	23 27 28		
N-e. ....	115 54 28	Precession to 1875-0 .....	+ 3-3
Log. cos. (N-e) .....	9-6404058	Nutation in longi- tude with contrary sign to <i>Nautical</i> <i>Almanac</i> .....	+ 7-5
Log. tan. R.A. ....	+ 0-2403519	Correction to longitude .....	+ 10-8
	- 9-8807577		
Log. cos. N. ....	+ 9-8801731		
Log. tan. e. ....	+ 0-0005846		
	225 2 19		
Correction. ....	+ 11		
Long. M. Eq. 1875-0.225	2 30		

And so for the second and third positions.

The interpolation of the sun's longitudes and the log. radii-vectors of the earth from monthly page iii. of the *Nautical Almanac* requires no illustration.

We now form the angles a' - A', a'' - A'', a''' - A''', &c., and take out the sines and cosines required; and it is always convenient to have these functions and other of the principal quantities copied in plain figures on a paper separate from the calculations. Thus we have,—

	Sine.	Cosine.
a' - A' .....	319 64 44	- 9-8088592
a'' - A'' .....	316 39 30	- 9-8365440
a''' - A''' .....	307 36 17	- 9-8988564
a' - A' .....	829 29 41	- 9-7055368
a'' - A'' .....	297 51 48	- 9-9464841
a' - A' .....	310 10 15	.....
a'' - A'' .....	317 11 14	.....
A''' - A' .....	19 19 26	.....
a''' - a' .....	347 41 33	.....

We have—

$$t'' - t' = 9-41851 \text{ days; } t''' - t'' = 9-56561 \text{ days,} \\ t''' - t' = 18-98413 \text{ days.}$$

The calculation of  $M = \frac{\rho'''}{\rho'}$ , is as follows, by (II.) :—

Log. tan. β' .....	+ 0-3232781	Log. tan. β'' .....	+ 0-5509163
Log. sin. (a' - A') ..	- 9-8365440	No. 3. ....	+ 3-556279
Log. m. ....	- 0-4867341	Log. m. ....	- 0-4867341
Log. sin. (a'' - A'') ..	- 9-8088562	Log. sin. (a''' - A''') ..	- 9-8988564
	+ 0-2955933		+ 0-3855905
No. 1. ....	+ 1-975119	No. 4. ....	+ 2-4299117
Log. tan. β' .....	+ 0-1633710	No. 3 - No. 4. ....	+ 1-1257162
No. 2. ....	+ 1-456703		
No. 1 - No. 2. ....	+ 0-518416		
Log. ....	+ 9-7146784	Log. (t'' - t') .....	0-9807127
Log. (No. 3 - No. 4) ..	+ 0-0514289	Log. (t' - t) .....	0-9739822
	9-6632495	Log. (t''' - t') .....	0-0067305
Log. (t'' - t') .....	0-0067305		
M. ....	9-6699800		
M². ....	9-3399600		

Next, we form the equations (III.) for the determination of  $r^2$ ,  $r'^2$ , and  $k^2$  by successive assumptions for the value of  $\rho'$  ;—

Log. R' .....	9-9933590	Log. R''' .....	9-9926916
Log. R'' .....	9-9867180	Log. R''² .....	9-9833832
R². ....	0-9699880	R''². ....	0-966903
Log. 2 .....	0-3010300	Log. 2 .....	0-3010300
Log. R' .....	9-9933590	Log. R'' .....	9-9926916
Log. cos. (a' - A') ..	9-9352968	Log. M. ....	9-6699800
	0-2296858	Log. cos. (a''' - A''') ..	9-6606554
No. ....	1-697015		9-6333570
Log. sec. β' .....	0-2472153	No. ....	0-429890
Log. sec. β². ....	0-4944306	Log. sec. β''' .....	0-5674468
No. ....	+ 3-121983	Log. sec. β''² .....	1-1348936
		M². ....	9-3399600
			0-4748536
		No. ....	+ 2-984376

Therefore the equations for  $r^2$  and  $r'^2$  are—

$$r^2 = 0-969880 - 1-697015 \cdot \rho' + 3-121983 \cdot \rho'^2 \\ r'^2 = 0-966903 - 0-429890 \cdot \rho' + 2-984376 \cdot \rho'^2$$

r² + r'² = 1-936783 - 2-126905 · ρ' + 6-106359 · ρ'²	Log. 2 .....	0-3010300	Log. 2 .....	0-3010300
	Log. R' .....	9-9933590	Log. M .....	9-6699800
	Log. R'' .....	9-9926916	Log. cos. (a''' - a') ..	+ 9-9899024
Log. cos. (A''' - A') ..	+ 9-9748170			
	+ 0-2618976	No. 8. ....	+ 0-913929	
No. 5. ....	+ 1-827669	Log. 2 .....	0-3010300	
Log. 2 .....	0-3010300	Log. M .....	9-6699800	
Log. R' .....	9-9933590	Log. tan. β' .....	+ 0-1633710	
Log. cos. (a' - A'') ..	+ 9-8096060	Log. tan. β''' .....	+ 0-5509163	
	+ 0-1033276		+ 0-6852973	
No. 6. ....	+ 1-268608	No. 9. ....	+ 4-845039	
Log. 2 .....	0-3010300	No. 8 + No. 9. ....	+ 5-758968	
Log. M .....	9-6699800			
Log. R' .....	9-9933590			
Log. cos. (a''' - A') ..	+ 9-8654465			
	+ 9-8298155			
No. 7. ....	+ 0-675796			
No. 6 + No. 7. ....	+ 1-944404			

So that the equation for  $k^2$  is thus formed,—

$$r^2 + r'^2 = 1-936783 - 2-126905 \cdot \rho' + 6-106359 \cdot \rho'^2 \\ - 1-827669 + 1-944404 \cdot \rho' - 5-758968 \cdot \rho'^2 \\ k^2 = 0-109114 - 0-182501 \cdot \rho' + 0-347391 \cdot \rho'^2$$

And thus substituting logarithms in the factors for  $\rho'$  and  $\rho'^2$ , our equations stand thus, in the form for proceeding with the work—

$$r^2 = 0-969880 - [0-2296858] \cdot \rho' + [0-4944306] \cdot \rho'^2 \\ r'^2 = 0-966903 - [9-6333570] \cdot \rho' + [0-4748536] \cdot \rho'^2 \\ k^2 = 0-109114 - [9-2612663] \cdot \rho' + [9-5408186] \cdot \rho'^2$$

We have now to find the value of  $\rho'$  by trial and error. Here, if  $k^2 = F + G\rho' + H\rho'^2$ , we have—

$F = 0.10911$ ,  $\log. G = -9.26127$ ,  $\log. H = +9.54082$ .

And for a first approximate value of  $\rho'$ , by (IV.),—

Log. F... = 9.03788	Log. 2 .... = 0.30103
Log. H... = 9.54082	Log. H... = + 9.54082
9.49706	Log. 2H... = + 9.84185
Log. $\sqrt{\frac{F}{H}}$ ... = 9.74856	Log. G.... = -9.26127
Log. tan. $\frac{1}{2}\psi$ ... = 0.06370	- 0.58058
Log. $\rho'$ ... = 9.81226	Log. $\sqrt{\frac{F}{H}}$ ... + 9.74856
$\rho'$ ... = 0.649	tan. $\psi$ ... = 0.83202
	$\psi$ ... = 98° 22', 5
	$\frac{1}{2}\psi$ ... = 49° 11', 25

In the earlier approximations we may use five-figure logarithms. With  $\rho' = 0.649$ , the work proceeds thus—

Log. $\rho'$ .....9.81224	Log. $\rho'^2$ ...9.62448	Log. $\rho'^3$ ...9.49443	R <sup>2</sup> ... 0.96988
- 0.22969	+ 0.49443	R <sup>2</sup> ... 0.96988	No. (2.)... + 1.31494
Log. $\rho'$ .... 9.81224	Log. $\rho'^2$ 9.62448	No. (2.)... + 1.31494	
(1.)... - 0.04193	(2.)... + 0.11891	No. (1.)... - 1.10135	
- 9.63336	+ 0.47485	No. (1.)... - 1.10135	
Log. $\rho'$ .... 9.81224	Log. $\rho'^2$ 9.62448	$\rho'^2$ ... 1.18347	
(3.)... - 9.44560	(4.)... + 0.09933	Log. $\rho'^2$ ... 0.07316	
- 9.26127	+ 9.54082	Log. $\rho'$ ... 0.03658	
Log. $\rho'$ .... 9.81224	Log. $\rho'^2$ 9.62448		
(5.)... - 9.07351	(6.)... + 9.16530	R <sup>1/2</sup> ... 0.96690	
	No. (6.) + 0.14632	No. (4.)... + 1.25697	
	Constant... + 0.10911	+ 2.22387	
	+ 0.25543	No. (3.)... - 0.27900	
	No. (5.) + 0.11844	$\rho'^{1/2}$ ... 1.94487	
	$k^2$ ... + 0.13699	Log. $\rho'^{1/2}$ ... 0.28890	
	Log. $k^2$ ... + 9.13669	Log. $\rho'^{1/2}$ ... 0.14445	
	Log. $k$ ... + 9.56835		
	$k$ ... 0.37012	$\rho'$ ... 1.08788	
	$\frac{1}{2}k$ ... 0.18506	$\rho'^{1/2}$ ... 1.39460	
	= $\frac{1}{2}(\rho' + \rho'^{1/2})$	$\frac{1}{2}k$ ... 1.24124	
		$\frac{1}{2}k$ ... 0.18506	
	B = $\frac{1}{2}(\rho' + \rho'^{1/2}) + \frac{1}{2}k$ .....	1.42630	
	D = $\frac{1}{2}(\rho' + \rho'^{1/2}) - \frac{1}{2}k$ .....	1.05618	
Constant..... 1.43781	Constant..... 1.43781		
Log. B..... 0.15421	Log. D..... 0.02373		
$\frac{1}{2}$ Log. B..... 0.07711	$\frac{1}{2}$ Log. D..... 0.01187		
Log. $\rho'$ ..... 1.66913	Log. $\rho'^{1/2}$ ..... 1.47341		
$\rho'$ ..... 46.6800			
$\rho'^{1/2}$ ..... 29.7447			
$\rho' - \rho'^{1/2}$ ..... 16.9353			
( $\rho'' - \rho'$ )..... 18.9841			
Error..... -2.0488			

If for a second approximation we take  $\rho' = 0.7789$ , and calculate  $\rho'' - \rho'$  precisely as before, the error in the interval from the first to the third observation, or ( $\rho''' - \rho'$ ), is found to be  $-0^{\circ} 3606$ , which, compared with the error of the first assumption ( $-2^{\circ} 0488$ ), shows a change of  $+1^{\circ} 6882$  for an increase of  $0.0649$  in  $\rho'$ , or of  $\frac{1}{15}$ th part, and by mere proportion we have  $\rho' = 0.72776$ , for a third approximation, giving the error in interval =  $+0^{\circ} 0222$ , so that we are now approaching the true value, and with  $\rho' = 0.7289562$ , obtained from the errors of the second and third trial in the same way that the third value of  $\rho'$  was inferred, we may substitute seven-figure logarithms and work more closely; it will thus be found that the error in interval corresponding to the fourth assumption for  $\rho'$  is reduced to  $+0^{\circ} 00167$ , or less than  $2\frac{1}{2}$  minutes, and if we are only seeking an approximate knowledge of the orbit, the direct calculation of the elements might proceed with this fourth value of  $\rho'$ . However, to make the computation in this example a little more complete, we work out two further hypotheses, and finally adopt for the correct value of  $\rho'$ ...  $0.728994$ , with which the calculation is as follows:—

- 0.2296858	+ 0.4944306	R <sup>2</sup> ... 0.969880
Log. $\rho'$ ... 9.8614743	Log. $\rho'^2$ 9.7229486	No. (2.) + 1.649602
(1.)... - 0.0911601	(2.)... + 0.2173792	2.619482
- 9.6333570	+ 0.4748536	No. (1.) - 1.233560
Log. $\rho'$ ... 9.8614743	Log. $\rho'^2$ 9.7229486	$\rho'^2$ 1.385922
(3.)... - 9.4948313	(4.)... + 0.1978022	Log. $\rho'$ 0.1417388
- 9.2612653	+ 9.5408186	Log. $\rho'$ 0.0708694
Log. $\rho'$ ... 9.8614743	Log. $\rho'^2$ 9.7229486	
(5.)... - 9.1227396	(6.)... + 9.2637672	
	No. (6.)... + 0.183555	R <sup>1/2</sup> ... 0.966903
	Constant... + 0.109114	No. (4.)... 1.576893
	+ 0.292669	2.543796
	No. (5.)... - 0.132660	No. (3.)... - 0.312487
	$k^2$ ... + 0.160009	$\rho'^{1/2}$ ... 2.231309
	Log. $k^2$ ... 9.2041444	Log. $\rho'^{1/2}$ ... 0.3485598
	Log. $k$ ... 9.6020722	Log. $\rho'$ ... 0.1742799
	$k$ ... 0.400011	$\rho'$ ... 1.177251
	$\frac{1}{2}k$ ... 0.200006	$\rho'^{1/2}$ ... 1.493757
		$\frac{1}{2}(\rho' + \rho'^{1/2})$ ... 1.335504
		$\frac{1}{2}k$ ... 0.200006
	B = $\frac{1}{2}(\rho' + \rho'^{1/2}) + \frac{1}{2}k$ .....	1.535510
	D = $\frac{1}{2}(\rho' + \rho'^{1/2}) - \frac{1}{2}k$ .....	1.135498
Constant 1.4378117	Constant 1.4378117	$\rho'$ 52.14235
Log. B 0.1862526	Log. D 0.0551863	$\rho'^{1/2}$ 33.15822
$\frac{1}{2}$ Log. B 0.0931263	$\frac{1}{2}$ Log. D 0.0275932	$\rho' - \rho'^{1/2}$ 18.98413
Log. $\rho'$ 1.7171906	Log. $\rho'$ 1.5205912	$\rho'' - \rho'$ 18.98413

which may be considered a perfect agreement. We have thus for the direct calculation of the orbit Log.  $\rho'$ ... 9.8614743, and since  $\rho''' = M\rho'$ , we find Log.  $\rho'''$ ... 9.5314543. Log.  $\rho''$ ... 0.0708694, and Log.  $\rho''$ ... 0.1742799, as given by our final approximation.

With the aid of the formula (VI.) the heliocentric longitudes and latitudes of the comet at the first and third observations are found as follows:—

Log. $\rho'$ ..... 9.8614743	Log. $\rho'''$ ..... 9.5314543
Log. sin. ( $\rho' - A'$ )..... - 9.7055368	Log. sin. ( $\rho''' - A'''$ )..... - 9.9464841
(1.)..... - 9.5670111	(4.)..... - 9.4779384
Log. $\rho'$ ..... 9.8614743	Log. $\rho'''$ ..... 9.5314543
Log. cos. ( $\rho' - A'$ )..... + 9.9352968	Log. cos. ( $\rho''' - A'''$ )..... + 9.6696554
(2.)..... + 9.7967711	(5.)..... + 9.2011097
No. to (2.)..... + 0.6262837	No. to (5.)..... + 0.1588948
Subtract R'..... 0.9848248	Subtract R''..... 0.9833124
(3.) No. .... - 0.3585411	(6.) No. .... - 0.8244176
Log. (3.)..... - 9.5545389	Log. (6.)..... - 9.9161473
(1.) — Log. tan. ( $\rho' - A'$ )..... + 0.0124722	(4.) — Log. tan. ( $\rho''' - A'''$ )..... + 9.5617911
$\theta' - A'$ ..... 225° 49' 21''.4	$\theta''' - A'''$ ..... 200° 1' 50''.8
Add A'..... 255° 32' 49''.0	Add A'''..... 274° 52' 15''.0
$\theta'$ ..... 121° 22' 10''.4	$\theta'''$ ..... 114° 54' 5''.8
Log. sin. ( $\theta' - A'$ )..... - 9.8556316	Log. sin. ( $\theta''' - A'''$ )..... - 9.5346921



<u>(1.)</u>	
Log. sin. ( $\theta' - \lambda'$ )	= Log. ( $r'$ cos. $\lambda'$ ) ..... + 9.7113795
Log. ( $r'$ tan. $\beta'$ )	= Log. ( $r'$ sin. $\lambda'$ ) ..... + 0.0248453
∴ Log. tan. $\lambda'$ ..... + 0.3134658	
$\lambda'$ ..... + 64° 5' 7''·9	
Log. sin. $\lambda'$ ..... + 9.9539758	
Log. ( $r'$ sin. $\lambda'$ )	= Log. $r'$ ..... 0.0708695
Log. sin. $\lambda'$	.....
The equations gave Log. $r'$ ..... <u>0.0708694</u>	

<u>(4.)</u>	
Log. sin. ( $\theta''' - \lambda'''$ )	= Log. ( $r'''$ cos. $\lambda'''$ ) ..... + 9.9432468
Log. ( $r'''$ tan. $\beta'''$ )	= Log. ( $r'''$ sin. $\lambda'''$ ) ..... + 0.0823706
∴ Log. tan. $\lambda'''$ ..... + 0.1391243	
$\lambda'''$ ..... + 64° 1' 27''·0	
Log. sin. $\lambda'''$ ..... 9.9080907	
(Log. $r'''$ sin. $\lambda'''$ )	= Log. $r'''$ ..... 0.1742799
Log. sin. $\lambda'''$	.....
..... Log. $r'''$ ..... <u>0.1742799</u>	

so that our first verification is complete.

The comet's heliocentric longitude at the third observation ( $\theta'''$ ) being less than that at the first observation ( $\theta'$ ), the motion in the orbit is *retrograde* or contrary to the order of the signs, and we therefore proceed to determine the longitude of the ascending node ( $\Omega$ ) and the inclination ( $i$ ) by the second set of equations in (VII.); thus—

$\theta'$ ...	121° 22' 10''·4
$\theta'''$ ...	114° 54' 5''·8
$\theta' - \theta'''$ ...	6° 28' 4''·6
Log. cos. ( $\theta' - \theta'''$ ) ...	+ 9.9972269
Log. tan. $\lambda'$ ...	+ 0.3134658
(1.)	+ 0.3106927
No. to (1.) ...	+ 2.0449972
Nat. tan. $\lambda'''$ ...	+ 1.3776038
Nat. tan. $\lambda'''$ - No. (1.) ...	- 0.6673934

Log. sin. ( $\theta' + \theta'''$ ) ...	+ 9.8243819	$\Omega$ ...	282° 12' 48''·1
Log. tan. $\lambda' ...$	+ 0.3134658	$\theta'''$ ...	114 54 5 · 8
Log. tan. ( $\Omega - \theta'$ ) ...	- 9.5408048	$\Omega - \theta'''$ ...	167° 18' 42''·3
$\Omega - \theta' ...$	160° 50' 37''·7		
Add $\theta' ...$	121° 22' 10''·4		
$\Omega ...$	282° 12' 48''·1		

Then for the arguments of latitude at first and third observations ( $u', u'''$ )—

Log. tan. ( $u' - \theta'$ ) ...	- 9.5408048	Log. tan. ( $\Omega - \theta'''$ ) ...	- 9.3524609
Log. cos. $i ...$	- 9.1971480	Log. cos. $i ...$	- 9.1971480
Log. tan. $u' ...$	- 0.3436568	Log. tan. $u''' ...$	- 0.1553129
$u' ...$	114° 22' 57''·6	$u''' ...$	124° 57' 59''·6
∴ $u''' - u' = 10° 35' 2''·0$ , and $\frac{1}{2}(u''' - u') = 5° 17' 31''·0$ .			

We have now to calculate the true anomaly at the first observation from the radii-vectores  $r', r'''$  and the included angle  $u''' - u'$ , which is  $= u''' - u'$ , and for this purpose will employ both expressions for tan.  $\frac{1}{2}v$  in (IX.)—

By the first formula.

Log. cotan. $\frac{1}{2}(u''' - u')$ ...	+ 1.0332699
No (1.) = (Nat. cotan. $\frac{1}{2}(u''' - u')$ ) ...	+ 10.796174
Log. $r'$ ...	0.0708694
Log. $r'''$ ...	0.1742799
Log. ( $\frac{r'}{r''}$ ) ...	9.8965895
$\sqrt{\frac{r'}{r''}}$ ...	9.9482948
Log. sin. $\frac{1}{2}(u''' - u')$ ...	+ 8.9648750
	+ 0.9834198
No. 2 ...	+ 9.625432
No. (1.) - No. (2) = Nat. tan. $\frac{1}{2}v$ ...	+ 1.170752
Log. tan. $\frac{1}{2}v$ ...	+ 0.0684649
$\frac{1}{2}v$ ...	+ 49° 29' 51''·5
∴ $v'$ ...	98° 59' 43''·0

By the second formula.

Log. $\sqrt{r''}$ ...	0.0871400
Log. cos. $\frac{1}{2}(u''' - u')$ ...	+ 9.9681449
	0.0852849
No. 1 ...	+ 1.2169840
Log. $\sqrt{r''}$ ...	0.0354347
No. 2 ...	+ 1.0850125
No. 1 - No. 2 ...	+ 0.1319715
Log. ...	+ 9.1204801
Log. sin. $\frac{1}{2}(u''' - u'(\sqrt{r''}))$ ...	+ 9.0520150
Log. tan. $\frac{1}{2}v'$ ...	+ 0.0684651
$\frac{1}{2}v'$ ...	+ 49° 29' 51''·5

The perihelion distance ( $q$ ) =  $r' \cos. \frac{1}{2}v'$ , or

Log. cos. $\frac{1}{2}v'$ ...	9.8125654
Log. cos. $\frac{1}{2}v'$ ...	9.8251308
Log. $r'$ ...	0.0708694
Log. $q$ ...	9.6960002
$q$ ...	0.4969525

The longitude of the perihelion ( $\pi$ )—

$= \Omega - v' - u'$	
$= 282° 12' 48''·1 + 98° 59' 43''·0 - 114° 22' 57''·6$	
$= 266° 49' 33''·5$	

It remains only to determine the time of perihelion from (XII.), computing both from  $v'$  and  $v''' = v' + (u''' - u') = 109° 34' 45''·0$ , so as to have the final verification of the work—

$\frac{1}{2}v' = 49° 29' 51''·4$	$\frac{1}{2}v''' = 54° 47' 22''·5$
Log. tan. $\frac{1}{2}v' = + 0.0684649$	Log. tan. $\frac{1}{2}v''' ... + 0.1513832$
Log. tan. $\frac{1}{2}v' = + 0.2053947$	Log. tan. $\frac{1}{2}v''' ... + 0.4541496$
Log. ( $\frac{1}{2}$ ) ...	9.5228787
+ 9.7282734	+ 9.9770283
No. ... + 0.584901	No. ... + 0.948480
Nat. tan. $\frac{1}{2}v' ...$	1.170752
Nat. tan. $\frac{1}{2}v''' ...$	1.417043
$x ...$	1.706653
$x ...$	2.365523

Log. $q ...$	9.6960002	Log. $x ...$	0.3739273
Log. 2 ...	0.3010300	Log. ( $\frac{2q}{2k}$ ) ...	1.4589339
Log. ( $2q$ ) ...	9.9970302		
$\frac{1}{2}$ Log. ( $2q$ ) ...	9.9985151	No. = days from 3d	} 684.05617
Log. ( $2q$ ) ...	9.9955453	obs. to perihelion	
Log. $2k ...$	8.5366114	Date of 3d obser-	} 26.24751
	1.4589339	vation, December	
Add Log. $x ...$	0.2318907	Perihelion passage,	
	1.6908246	October 19.19224	
No. = days from 1st	} 494.07097		
obs. to perihelion			
Date of 1st obser-			
vation, December	7.26339		
Perihelion passage,			
October 19.19242			

We have now the whole of the elements of the parabolic orbit, viz., as usually written and entered in catalogues,—

*Perihelion Passage, 1874, October 19.1924, Greenwich Mean Time.*

$\pi$ ...	266° 49' 33''·5	} Mean equinox
$\Omega$ ...	282° 12' 48''·1	
$i$ ...	80° 56' 27''·5	
Log. $q$ ...	9.696002	
Motion retrograde.		

As already remarked, it is always desirable to ascertain

how the comet's geocentric position, calculated from the elements thus obtained, agrees with the observed position. A close agreement where good observations have been employed, of course, indicates that the real path of the comet in space does not much differ from a parabola, while a considerable difference, i. e., one exceeding the probable error of the observation, may be due to the ellipticity of the orbit, and the comet may prove to be one of no long period. We will, therefore, proceed to compute the longitude and latitude from the above elements for the time of the second observation.

Perihelion passage (T), October 19-19240  
 Date of second observation ( $t''$ ), December 16-68190  
 $t'' - T \dots \dots \dots + 58 \cdot 48950$

Instead of using Barker's table, we will compute the true anomaly directly by the formulæ (XIII.); thus,

Log. (3k)....	8.7127027	Log. cotan. $v \dots$	0.7964958
Log. ( $t'' - T$ )....	+ 1.7670779	Log. cotan. $\xi =$	} 0.2654986
	+ 0.4797806	Log. $v' / \cotan. v$	
Log. (2q)½....	9.9955453	$\xi \dots 28^\circ 29' 7'' \cdot 6$	
Log. cotan. $2v \dots$	+ 0.4842353	$2\xi \dots 56^\circ 58' 15'' \cdot 2$	
$2v \dots 18^\circ 9' 18'' \cdot 8$		Log. cotan. $2\xi \dots$	9.8130004
$v \dots 9^\circ 4' 39'' \cdot 4$		Log. 2....	0.3010004

$\theta'' - \Delta'' =$	.....	212° 11' 10''·7
Log. $r'' \dots \dots$		0.1258616
Log. cos. $\lambda'' \dots \dots$		9.7176467
Log. sin. ( $\theta'' - \Delta''$ ).....		- 9.7264615
Log. (1).....		- 9.5699698
Log. ( $r''$ , cos. $\lambda''$ ).....		9.8435083
Log. cos. ( $\theta'' - \Delta''$ ).....		- 9.9275349
		- 9.7710432

No.....	- 0.5902597
Add $R'' \dots \dots$	+ 0.9838441
	+ 0.3935844
Log. (2).....	+ 9.5950379

Log. (1) - log. (2) = log. tan. ( $a'' - A''$ ).....	- 9.9749319
$a'' - A'' \dots \dots 316^\circ 39' 9'' \cdot 6$	
$\Delta'' \dots \dots 265^\circ 7' 46'' \cdot 0$	
$a'' \dots \dots 221^\circ 48' 55'' \cdot 6$	
$a''$ (observed).....	221° 47' 16''·0
Geoc. Long. (comp. - obs.).....	- 20''·4

Log. cos. $\frac{1}{2}v'' \dots$	= 9.7850693	tan. $\frac{1}{2}v'' \dots$	0.1140304
Log. cos. $\frac{1}{2}v'' \dots$	9.5701386	$\frac{1}{2}v'' \dots + 52^\circ 26' 13'' \cdot 0$	
Log. $q \dots$	9.6960002	$v'' \dots + 104^\circ 52' 26'' \cdot 0$	
Log. $r'' \dots$	0.1258616		

We then obtain the comet's heliocentric longitude on the ecliptic ( $\theta''$ ) and heliocentric latitude ( $\lambda''$ ), the motion in the orbit being retrograde, from equations (XV.):—

$\Omega \dots 282^\circ 12' 48'' \cdot 1$	
$\theta'' \dots 104^\circ 52' 26'' \cdot 0$	
$\pi \dots 27^\circ 5' 14'' \cdot 1$	
$\pi \dots 266^\circ 49' 53'' \cdot 5$	
$v'' + \Omega - \pi \dots 120^\circ 15' 40'' \cdot 6$	
Log. sin. ( $v'' + \Omega - \pi$ ).....	+ 9.9363812
Log. cos. $i \dots + 9.1971480$	.....
	+ 9.9363812
Log. cos. ( $v'' + \Omega - \pi$ ).....	+ 9.7023292
Log. tan. ( $\Omega - \theta''$ ).....	- 9.7023292
	+ 9.1335292
	- 9.7023292
$\Omega - \theta'' \dots 164^\circ 53' 51'' \cdot 4$	
$\Omega \dots 282^\circ 12' 48'' \cdot 1$	
$\theta'' \dots 117^\circ 18' 56'' \cdot 7$	

Log. $r'' \dots \dots$	0.1258616
Log. sin. $\lambda'' \dots \dots$	+ 9.9309301
Log. ( $r''$ , sin. $\lambda''$ ).....	+ 0.0567917 = Log. ( $\Delta''$ , sin. $\beta''$ )
	- 9.5699698
Log. sin. ( $a'' - A''$ ).....	- 9.8365895
	+ 9.7333803 = Log. ( $\Delta''$ , cos. $\beta''$ )
Log. tan. $\beta'' \dots \dots$	+ 0.3234114
$\beta'' + \dots + 64^\circ 35' 51'' \cdot 5$	
$\beta''$ (observed) .. + 64° 35' 27''·0	
Geo. Lat. (comp. - obs.)..	+ 24''·5
Log. ( $\Delta''$ , sin. $\beta''$ ).....	+ 0.0567917
sin. $\beta'' \dots \dots$	+ 9.9558405
Log. $\Delta'' \dots \dots$	0.1009512
$\Delta'' \dots \dots$	1.26169
cos. $\beta'' \dots \dots$	9.6324
Log.....	- 1.3096
	- 0.9420

Diff. Long. in arc } ..... - 8''·7  
 of great circle }

So that the errors of elements for the second observation may be expressed in transcription thus:—

$$da'' \cdot \cos. \beta'' = - 8'' \cdot 7$$

$$d\beta'' = + 24'' \cdot 5$$

These errors are not greater than may be looked for, in a computation upon the method we have adopted.

We have computed the true distance of the comet from the earth at the second observation  $\Delta''$ . If the true distances at the first and third observations are desired, we have  $\Delta' = \frac{\rho'}{\cos. \beta'}$ ,  $\Delta''' = \frac{\rho'''}{\cos. \beta'''}$ , or, in the present case,  $\Delta' = 1.28437$ ,  $\Delta''' = 1.24574$ , so that the comet was slowly approaching the earth during the interval over which the observations extend.

If it be preferred to compare with the observed right ascension and declination, the formulæ (XVII.) have yet to be applied, the calculation, as will be seen, being very similar to that in the conversion of right ascension and declination into longitude and latitude.

[The formation of the equations for the determination of  $\rho'$ ,  $\rho''$ , and  $k$  will perhaps be found the most slippery part of the computation by the beginner, and we add therefore two or three sets of data from observation and the ephemeris, with the resulting equations, which may be verified for the sake of obtaining a better acquaintance with this part of the work.

Comet 1870. (Coggia, August 28.)

	t	a	$\beta$	A	Log. R
Aug.	28-5356	46 7·0	- 11 22·1	155 27·4	0.00411
Sept.	5-4551	41 45·7	- 5 19·2	163 7·8	0.00325
	19-4167	29 30·0	+ 9 22·3	176 43·8	0.00165

The equations are

$$r'^2 = 1.01911 + [9.82521] \rho' + [0.01721] \rho'^2$$

$$r''^2 = 1.00762 + [0.10261] \rho' + [9.76209] \rho'^2$$

$$k^2 = 0.13813 - [9.41687] \rho' + [9.36281] \rho'^2$$

Comet 1874. (Winnecke, April 11.)

	t	a	$\beta$	A	Log. R
April	12-60769	320 30·8	+ 8 56·0	22 59·9	0.00144
	23-58796	312 57·1	+ 23 40·7	33 43·2	0.00373
May	6-47931	281 42·8	+ 53 59·2	46 18·2	0.00412

The equations are

$$r'^2 = 1.00666 - [9.96708] \rho' + [0.01060] \rho'^2$$

$$r''^2 = 1.01916 + [9.57247] \rho' + [9.48948] \rho'^2$$

$$k^2 = 0.16416 - [9.72470] \rho' + [9.83437] \rho'^2$$

Comet 1874. The Great Comet of Coggia.

	t	a	$\beta$	A	Log. R
April	17-38074	93 30 " 1	+ 46 35 " 3	27 40 " 3	0.0026291
	28-37122	92 42 7	+ 45 52 0	38 22 7	0.0032554
May	9-39543	92 55 24	+ 45 28 23	49 3 16	0.0044190

The equations are

$$\begin{aligned} r'^2 &= 1.009347 - [9.9151992] \rho' + [0.3257222] \rho'^2 \\ r''^2 &= 1.020559 - [0.1391891] \rho' + [0.2602010] \rho'^2 \\ k^2 &= 0.139596 + [8.5723285] \rho' + [8.0795842] \rho'^2 \end{aligned}$$

It will be remarked that the apparent motion of this comet was very slow during the interval we have taken; it afforded a case where the orbit could only be improved by increased length of observation.]

We may correct the elements thus obtained for the main effect of the error due to the assumption made on commencing our calculation, by the following process, also suggested by Olbers, and applicable to the same observations.

There are already found  $r'$ ,  $r''$ ,  $\rho'$ ,  $\rho''$ , and  $\rho'$ .

$$\text{Put } p = \frac{r'' \cdot \sin. (\vartheta'' - \vartheta')}{r' \cdot \sin. (\vartheta'' - \vartheta')} - \frac{(r'' - r')}{(r'' - r')} \\ \text{and } q = \frac{R'' \cdot \sin. (A'' - A')}{R' \cdot \sin. (A'' - A')} - \frac{(r'' - r')}{(r'' - r')} \quad m = \frac{\tan. \beta''}{\sin. (a'' - A'')}$$

as in the calculation of the ratio of the curtate distances  $\frac{\rho''}{\rho'}$  or M.

Then compute N from

$$N = \frac{R' \cdot \sin. (A'' - A')(q - p) \cdot m}{\rho' (m \cdot \sin. A'' - a' - \tan. \beta') \cdot (r'' - r')} \\ H = 1 + \frac{(r'' - r')}{(r'' - r')} \cdot p + N$$

Multiply these terms in the equations for  $\rho''^2$  and  $k^2$  which contain M by H, and the term in the equation for  $\rho''^2$  which contains M<sup>2</sup> by H<sup>2</sup>; the equation for  $\rho''^2$  not containing M or M<sup>2</sup> remains unchanged. With this new system of equations we find corrected values of  $\rho'$  and of  $r'$  and  $r''$ , and the elements of the orbit therefrom as before.  $\rho''$  is now M · H ·  $\rho'$ .

To apply the above formulæ to our preceding example we have

$\vartheta'$ ... 98 59 43	$\vartheta'' - \vartheta'$ ... 5 52 43
$\vartheta''$ ... 104 52 26	$\vartheta''' - \vartheta''$ ... 4 42 19
$\vartheta'''$ ... 109 34 45	$A'' - A'$ ... 9 34 57
	$A''' - A''$ ... 9 44 29
Log. $r''$ ..... 0.1742799	Log. $R''$ ..... 9.9926916
Log. sin. ( $\vartheta'' - \vartheta'$ ) ..... 8.9139744	Log. sin. ( $A'' - A'$ ) ..... 9.2284039
A ..... 9.0832543	$\rho$ ..... 9.2210955
Log. $r'$ ..... 0.0708694	Log. $R'$ ..... 9.9933590
Log. sin. ( $\vartheta'' - \vartheta'$ ) .. 9.0103899	Log. sin. ( $A'' - A'$ ) ..... 9.2213297
B ..... 9.0812593	D ..... 9.2146887
$\frac{A}{B}$ ..... 0.0069950	$\frac{C}{D}$ ..... 0.0064068
No ..... 1.0162368	No ..... 1.0148614
$\frac{r'' - r'}{r'' - r'}$ ..... 1.0156182	..... 1.0156182
p ..... + 0.0006186	q ..... - 0.0007568
$\therefore q - p = - 0.0012570$	
Log. ( $R' \cdot \sin. (A'' - A')$ ) ..... + 9.2146887	Log. p ..... + 6.7914099
Log. ( $q - p$ ) ..... - 7.1384290	Log. ( $\frac{r'' - r'}{r'' - r'}$ ) ..... 9.9932695
Log. m ..... - 0.4867341	+ 6.7846794
E ..... + 6.8398518	No. .... + 0.0006091
Log. ( $m \cdot \sin. (A'' - A')$ ) ..... - tan. $\beta'$ ..... + 9.7146784	
Log. $\rho'$ ..... 9.8614743	
F ..... + 9.5761527	
$\frac{E}{F}$ ..... + 7.2636991	
Log. ( $\frac{r'' - r'}{r'' - r'}$ ) ..... 9.9932695	
Log. N ..... + 7.2569686	
N ..... + 0.0018070	
$\rho \frac{(r'' - r')}{(r'' - r')}$ ..... + 0.0006091	
..... 1.0000000	
H ..... 1.0024161	
Log. H ..... 0.0010481	
Log. M ..... 9.6699800	
Corrected log. M ... 9.6710281	

With this corrected value of log. M, we might recalculate the co-efficients of  $\rho'$  and  $\rho'^2$  in the equations for  $r''^2$

and  $k^2$ , and complete the calculation of the orbit, but as the method of procedure is precisely that already illustrated by an example, it is unnecessary to occupy space here by so doing.

In the majority of cases in practice, the first elements of a comet's orbit are calculated from a much shorter interval of observation than has been taken in the preceding example,—not infrequently from observations on consecutive nights, and in such cases our elements may be open to considerable correction, though the natural desire of the astronomer to learn something of a new comet's position in the system, its track in the heavens, or possible identity with a comet already calculated, induces as speedy a determination of the orbit, however approximate, as practicable.

If the observations used in the first computations are near together, or the geocentric motion is slow, it will be preferable to wait for later positions, rather than occupy time in attempting a closer representation of the middle place. When later observations are available, the orbit may be recalculated, M or  $\frac{\rho''}{\rho'}$ , being determined by Olbers's formulæ of correction, employing  $r'$ ,  $r''$ ,  $\rho'$ , &c., as deduced from the first orbit. But the following general method of correcting approximate elements of a parabolic orbit, which has been widely used, will be found as satisfactory, though requiring great care in working. It is generally known as the method of variation of curtate distances.

We select three good observations at as wide intervals as practicable. These observations should be corrected for the effects of parallax and aberration by means of distances from the earth ( $\Delta$ ) calculated from approximate elements.

The aberration will be most conveniently taken into account by subtracting  $497 \cdot 8 \times \Delta$  from the time of observation, and interpolating the values of A and Log. R from the *Nautical Almanac* for the time thus reduced.

Then, introducing the observed longitude and latitude and the value of  $\rho$ , calculated from the approximate orbit, find  $\theta$ ,  $\lambda$ , and  $r$  at the first and third observations from—

$$\begin{aligned} r \cdot \cos. \lambda \cdot \sin. (\theta - a) &= R \cdot \sin. (A - a) \\ r \cdot \cos. \lambda \cdot \cos. (\theta - a) &= R \cdot \cos. (A - a) + \rho \\ r \cdot \sin. \lambda &= \rho \cdot \tan. \beta \end{aligned}$$

From  $\theta'$ ,  $\lambda'$ ,  $r'$ , and  $\theta'''$ ,  $\lambda'''$ ,  $r'''$ , we compute the elements in the same manner as before, and thence the geocentric longitude for the time of the second observation, which call  $a_2$ . (The geocentric latitude may be substituted for the longitude, if it be changing more rapidly.) Also find the time by these elements between the first and third observations, which call  $t_2$ . Now vary  $\rho'$  by a small quantity, as 0.01 or 0.005 ( $=m$ ), and find  $\theta'$ ,  $\lambda'$ ,  $r'$  again, and with these new values, combined with the previous ones for  $\theta'''$ ,  $\lambda'''$ ,  $r'''$ , compute the elements, and compare again with the second longitude, and call the difference from the longitude first computed  $r$ ; also find the interval between the first and third observations, and call the difference in this case  $p$ . Next, with the first values of  $\rho'$ ,  $\theta'$ ,  $\lambda'$ ,  $r'$ , combine  $\theta'''$ ,  $\lambda'''$ ,  $r'''$  calculated from a similar slightly changed value of  $\rho''$ , ( $\rho'' + n$ ), and, completing the elements, compare again with the longitude at the second observation obtained with the unvaried  $\rho'$ ,  $\rho''$ , and also with the corresponding interval between the extreme observations, and call the differences from the longitude and interval with unvaried curtate distances  $s$  and  $q$ . We have thus in the three calculations,—

$$\begin{aligned} a_1, a_1 + r, a_1 + s \\ t_1, t_1 + p, t_1 + q \end{aligned}$$

The three hypotheses and corrected values of  $\rho'$ ,  $\rho''$  are then—

Assumed $\rho'$ .....	Hyp. I.	Hyp. II.	Hyp. III.	True orbit.
$\rho''$ .....	$\rho'$	$\rho' + m$	$\rho' + n$	$\rho' + x$
$\rho''$ .....	$\rho''$	$\rho''$	$\rho'' + n$	$\rho'' + y$
Interval between extreme observations .....	$t$	$t + p$	$t + q$	( $t$ ) observed interval.
Second longitude .....	$a_1$	$a_1 + r$	$a_1 + s$	( $a$ ) do. longitude.

And we have—

$$(t) - t = \frac{p \cdot x}{m} + \frac{q \cdot y}{n}$$

$$(a) - a_1 = \frac{r \cdot x}{m} + \frac{s \cdot y}{n}$$

$$x = \frac{[(t) - t] s \cdot m - [(a) - a_1] q \cdot m}{s \cdot p - r \cdot q} \quad y = \frac{[(t) - t] r \cdot n - [(a) - a_1] p \cdot n}{r \cdot q - s \cdot p}$$

If the resulting corrections of the curtate distances are small, the true, or rather corrected, elements may be obtained by interpolation between the values obtained on the different hypotheses. When  $x$  and  $y$  are large, it is occasionally necessary to repeat the work, to have a close agreement between the middle longitude calculated from the corrected orbit and the longitude observed.

To make our article rather more complete, we may now refer to the calculation of ephemerides of the geocentric places of a comet from the parabolic elements, which are required during its visibility to facilitate observations. If a few places only are required, the right ascensions and declinations may be found in the manner already described; but if the comet is likely to continue visible any length of time, it is more convenient to work by rectangular equatorial co-ordinates, introducing the  $X, Y, Z$ , depending on the sun's position, which are now given with much detail in the *Nautical Almanac*. Before proceeding further, however, it will be desirable to explain the use of Barker's Table, to which reference has already been made, in the calculation of the true anomalies, as it dispenses with the longer computation introduced above, with the view to render our example independent of any other publication. The table had appeared from time to time, in one form or another, in various astronomical works; but in 1847 it was re-computed with extreme precision by Dr. Luther, and printed in Encke's edition of Olbers's *Abhandlung über die leichteste und bequemste Methode die Bahn eines Cometen zu berechnen*. It is much too extensive to be reproduced here.

The true anomaly in the parabola is related to the time from perihelion by the equation—

$$\frac{75 k (t - T)}{q^{\frac{3}{2}} \sqrt{2}} = 75 \tan. \frac{1}{2} v + 25 \tan.^3 \frac{1}{2} v$$

where  $k$  is the Gaussian constant [log. = 8.2355814], and  $q$  as before the perihelion distance. In the table—

$$M = 75 \tan. \frac{1}{2} v + 25 \tan.^3 \frac{1}{2} v$$

$$\text{or } M = \frac{75 k (t - T)}{q^{\frac{3}{2}} \sqrt{2}}$$

an equation, which, when  $q$  is known, allows either of  $(t - T)$  being found from  $M$ , and consequently from  $v$ , or when  $(t - T)$  is known, gives  $M$ , and then, by means of the table, the corresponding  $v$ .

Put  $C = \frac{75 k}{\sqrt{2}}$ ;  $C$  is therefore a constant and log.  $C = 9.9601277$ .

If, then, there be calculated for any comet the quantity—

$$m = \frac{C}{q^{\frac{3}{2}}}$$

we shall have—

$$M = m (t - T) = 75 \tan. \frac{1}{2} v + 25 \tan.^3 \frac{1}{2} v.$$

To afford the reader a clearer idea of the great assistance which a table of this kind renders in cometary calculations, we will apply Luther's table in the two cases where we have used direct formulae in our example,—

(1.) To obtain  $(t' - T)$  from  $v' = 98^\circ 59' 43'' \cdot 0$ .

Log. $q$ .....	9.6960002
$\frac{1}{2}$ Log. $q$ .....	9.8480001
Log. $q^{\frac{3}{2}}$ .....	9.5440003
Log. $C$ .....	9.9601277
Log. $m$ .....	0.4161274

The table, of which the argument is the true anomaly ( $v$ ), with interval  $100''$ , furnishes these values of log.  $M$ , near the above value of  $v$ —

$v$	Log. M.	Diff. for $1''$ .
98 58 20.....	2.1066640	34.69
99 0 0.....	2.1070109	

Wherefore, by simple interpolation, we find  $98^\circ 59' 43'' \cdot 0$  corresponds to log.  $M \dots 2.1069519$ ; from this value of log.  $M$  subtract log.  $m$ , as found above, and we have 1.6908245 for the logarithm of the time (in days and decimals) from perihelion, corresponding to  $49^d \cdot 07096$ , as before.

(2.) In the reverse process, the determination of  $v$ , when  $(t - T)$  is given, we have in our example, as referring to the second observation with which the elements were compared—

$(t' - T)$ .....	+ 58.48950
Log. $(t' - T)$ .....	1.7670779
Log. $m$ .....	0.4161274
Log. $M$ .....	2.1832053

Near this value of  $M$  the table gives us—

$v$	Log. M.	Diff. for $1''$ .
104 51 40.....	2.1830332	37.50
104 53 20.....	2.1834081	

Whence, again by simple proportion, we find log.  $M = 2.1832053$ , which corresponds to  $104^\circ 52' 25.9''$ , differing only  $0''.1$  from the value found in the example.

The student should procure the last edition of the work above-named for the sake of this table, and for the extensive catalogue of orbits of comets, coming down to 1864, and by far the most complete and reliable yet published.

It has been remarked that, where an ephemeris of geocentric positions (right ascension and declination) for any length of time is required, it is convenient to calculate with rectangular equatorial co-ordinates, instead of by the process we have followed in comparing the orbit with the middle observation.

For this purpose we compute what may be termed co-ordinate constants, from the elements  $\pi, \Omega$ , and  $\epsilon$ , and obliquity of ecliptic ( $e$ ), by the following formulæ:—

$$P = \cos. \Omega \quad P' = \sin. \Omega \cos. \epsilon \quad P'' = \sin. \Omega \sin. \epsilon$$

$$Q = -\sin. \Omega \cdot \cos. \epsilon \quad \tan. \psi = \frac{\tan. \epsilon}{\cos. \Omega} \quad Q'' = \epsilon \sin. (\psi + \epsilon)$$

$$\frac{P}{Q} = \tan. A \quad \epsilon = \frac{\sin. \epsilon}{\sin. \psi} \quad \frac{P''}{Q''} = \tan. C$$

$$\frac{P}{\sin. A} = \sin. \alpha \quad Q' = \epsilon \cdot \cos. (\psi + \epsilon) \quad \frac{P''}{\sin. C'} = \sin. \epsilon$$

$$A' = A + (\pi - \Omega) \quad \frac{P'}{Q} = \tan. B \quad C' = C + (\pi - \Omega)$$

$$\frac{P'}{\sin. B} = \sin. b$$

$$\sin. B + (\pi - \Omega)$$

As a partial check upon the calculation, we have—

$$\tan. \epsilon = \frac{\sin. b \cdot \sin. \epsilon \cdot \sin. (C' - B')}{\sin. \alpha \cdot \cos. A}$$

The angle  $\psi$  is to be taken in the first quadrant with its proper sign, and when the comet's motion is retrograde,  $\epsilon$  must be used with a negative sign. The heliocentric co-ordinates of the comet ( $x, y, z$ ) will then be obtained from—

$$x = r \cdot \sin. \alpha \cdot \sin. (A' + v)$$

$$y = r \cdot \sin. b \cdot \sin. (B' + v)$$

$$z = r \cdot \sin. \epsilon \cdot \sin. (C' + v),$$

$z$  being measured in the direction of the first point of Aries, from the sun as origin of co-ordinates,  $y$  towards  $90^\circ$  of Right Ascension, and  $x$  from the plane of the equator, positive to the north.

Similar co-ordinates of the sun,  $X, Y, Z$ , with the earth as origin, are found in the *Nautical Almanac* for Greenwich noon and midnight.

The Right Ascension and Declination are given by

$$\tan. R.A. = \frac{Y + y}{X + x} \quad \tan. \delta = \frac{Z + z}{X + x} \cos. R.A.$$

The true distance of the comet from the earth ( $\Delta$ ) =  $\frac{Z + z}{\sin. \delta}$

As an example of this calculation we will find the co-ordinate constants applying to the elements of Borrelly's comet in this article.

$$\text{Here } \Omega = 282^\circ 12' 43'' \cdot 1 \quad \pi - \Omega = 344^\circ 36' 45'' \cdot 4$$

$$\epsilon = 80^\circ 56' 27'' \cdot 5 \text{ (the motion being retrograde).}$$

The mean obliquity of ecliptic, 1875.0 = $23^\circ 27' 19'' \cdot 2$ .	
P = Log. cos. $\Omega$ ... + 9.3254186	Log. tan. $\epsilon$ ... - 0.7974906
- Log. sin. $\Omega$ ... + 9.9900575	Log. cos. $\Omega$ ... + 9.3254186
Log. cos. $\epsilon$ ... + 9.1971480	Log. tan. $\psi$ ... - 1.4719623
Q... + 9.1872055	$\psi$ ... - $88^\circ 45' 3''$
	$\epsilon + \psi$ ... $23^\circ 27' 19'' \cdot 2$

$\frac{P}{Q} = \log. \tan. A$ ... + 0.1382131	$\psi + \epsilon$ ... $64^\circ 36' 45'' \cdot 4$
A... $53^\circ 58' 1'' \cdot 2$	Log. sin. $\epsilon$ ... - 9.9945489
Log. sin. A... + 9.9077758	Log. sin. $\psi$ ... - 9.997531
P	Log. $\epsilon$ ... + 9.9947968

$$\log. \sin. A = \log. \sin. \alpha + 9.4176428$$

$$A' = A + (\pi - \Omega) \dots 38^\circ 34' 46'' \cdot 6$$

Log. sin. $\Omega$ .....-9.9900575	Log. sin. $\Omega$ .....-9.9900575
Log. cos. $\epsilon$ .....+9.9625442	Log. sin. $\epsilon$ .....+9.5999236
P'.....-9.9526017	P''.....-9.5899811
Log. $s$ .....+9.9947958	Log. $s$ .....+9.9947958
Log. cos. ( $\psi + \epsilon$ ).....+9.6321902	Log. sin. ( $\psi + \epsilon$ ).....-9.9558944
Q'.....+9.6269860	Q''.....-9.9506902
$\frac{P'}{Q}$ = log. tan. B.....-0.3256157	$\frac{P''}{Q''}$ = log. tan. C...+9.6392909
B...295° 17' 23''.4	C...203° 32' 51'''.9
Log. sin. B.....-9.9562445	Log. sin. C.....-9.6015311
$\frac{P'}{Q}$ = log. sin. $\delta$ .....9.9965472	$\frac{P''}{Q''}$ = log. sin. $\delta$ .....9.9884500
Log. sin. B.....-9.9562445	Log. sin. C.....-9.6015311
B' = B + ( $\epsilon - \Omega$ ).....279° 54' 8''.8	C = C + ( $\epsilon - \Omega$ ).....188° 9' 37'''.3

A'.....38° 34' 46''.6	B'.....279° 54' 8''.8	C'.....188° 9' 37'''.3
$\psi$ .....-104° 52' 26''.0	$\psi$ .....-104° 52' 26''.0	$\psi$ .....-104° 52' 26''.0
A' + $\psi$ .....293° 42' 20''.6	B' + $\psi$ .....175° 1' 42''.8	C' + $\psi$ .....83° 17' 11''.3
Log. sin.....-9.9617163	Log. sin.....+8.9378148	Log. sin.....+8.9970118
Log. r.....0.1258616	Log. r.....0.1258616	Log. r.....0.1258616
Constant.....9.4176428	Constant.....9.9963572	Constant.....9.9884500
Log. $x$ .....-9.5052233	Log. $y$ .....+9.0600362	Log. $z$ .....+0.1113260
$x$ .....-0.3200540	$y$ .....+0.1148249	$z$ .....+1.2921890
X.....-0.0835332	Y.....-0.8992894	Z.....-0.3901925
X + $x$ .....-0.4035872	Y + $y$ .....-0.7844645	Z + $z$ .....+0.9019965
Log. (Z + $z$ ).....+9.95520	Log. (Y + $y$ ).....-9.8945733	Log. Z + $z$ .....+9.9552048
Subt. log. sin. $\delta$ .....+9.85425	Log. (X + $x$ ).....-9.6059374	Log. cos. R. A.....-9.6603729
Log. $\Delta$ .....0.10095	Log. tan. R. A.....+0.2886359	-9.6156777
$\Delta$ .....1.2617	R. A.....242° 46' 31'''.2	Log. (X + $x$ ).....-9.6059374
		Log. tan. $\delta$ .....+0.0096403
		$\delta$ .....+45° 38' 9''.1

We thus have, as the expressions are usually written,

$$\begin{aligned} x &= r \cdot [9.4176428] \sin(38\ 34\ 46.6 + \psi) \\ y &= r \cdot [9.9963572] \sin(279\ 54\ 8.8 + \psi) \\ z &= r \cdot [9.9884500] \sin(188\ 9\ 37.3 + \psi) \end{aligned}$$

{ All quantities being of course logarithmic.

The true anomaly reckoned from 0° to 180°, in a direct orbit, is to be applied to A', B', and C', with a negative sign if the time for which we are calculating be before the perihelion passage, and with a positive sign if the time be subsequent thereto. In a retrograde orbit the contrary rule is to be observed.

In our comparison of the elements of Borrelly's comet with the second observation we found  $v = 104^\circ 52' 26''.0$ , and  $\log. r = 0.1258616$ ; the calculation of the heliocentric co-ordinates and geocentric place with these values stands thus:—

For the demonstration of the method of determining a parabolic orbit, which has been here adopted, the reader may consult Olbers's work, already mentioned, and for various modifications and refinements he is referred to Encke's treatise, *Ueber die Olbers'sche Methode zur Bestimmung der Cometenbahnen*, in the Appendix to the *Berliner Astronomisches Jahrbuch* for 1833; he will obtain much additional information from the treatise on *Theoretical Astronomy*, by Prof. Watson of Ann Arbor, U. S., and from Prof. Oppolzer's work, *Bahnbestimmung der Kometen und Planeten*, Leipzig, 1870.

On the solution of Lambert's equation, we may refer him to a paper by Mr. Marth in *Astronomische Nachrichten*, vol. lxx., Nos. 1557-60, which he will find accompanied by elaborately-constructed tables. To obviate extending this article to inconvenient length, the introduction of tables has been avoided throughout; and should it fall under the notice of any one practised in such calculations, we must beg him to attribute any deviation from general rules to the wish to make the article complete in itself, so that the student may compute parabolic elements of any new comet, and its apparent track in the heavens therefrom, without extraneous assistance.

For the method of calculating elliptical orbits, when decided deviation from the parabola is indicated, the reader is referred to Gauss's classical work, *Theoria Motus Corporum Caelestium*, originally published in 1809, a translation of which, by Commander Davis, U.S.N., was printed at Boston in 1857; in this volume he will also find the demonstration of the formulæ employed in calculating geocentric places from the elements of the orbit.

In presenting elements of comets of short period we shall include in Group A the comets for which periods of less than fifteen years are either established or have been assigned with greater or less degree of probability, and in Group B comets of longer periods, but not exceeding eighty years. We take the comets in order of length of period.

GROUP A.

I. Encke's Comet.

T.....1875, April 13-0682	$e$ .....0.849423 (the eccentricity).
$a$ .....158 21 81	$a$ .....2.21105 (the semi-axis major).
$\Omega$ .....334 40 48	Period 5.288 years.
$i$ .....13 7 22	Direct.

T is expressed in Greenwich mean time.

The revolution of this comet in about 3½ years was discovered by Encke on its appearance in 1818-19, when it was detected by Pons. Encke, having calculated the effect of perturbation by the planet Jupiter, showed that the comet had been previously observed in 1786, 1795, and 1805, though missed at the intervening returns. It has been observed, with more or less success, at every appearance since 1819. Encke's investigations soon led him to infer that the comet's period had slightly diminished since 1795, and that this diminution might be owing to the effect of a resisting medium. The late researches of Dr. von Asten of Pulkowa indicate that it is only in certain revolutions that an effect of this nature can be suspected, so that great doubt is thrown upon the validity of Encke's theory.

II. Blanpain's Comet. 1819, IV.

T.....1819, Nov. 20-2148	$e$ .....0.686746.
$a$ .....2.84981.	$a$ .....2.84981.
$\Omega$ .....67 18 48	Period...4.81 years.
$i$ .....77 13 57	Direct.
$i$ .....9 1 16	

These elements were calculated by Encke, who had ascertained that the motion of the comet could not be represented by a parabolic orbit. Clausen thought the comet was identical with one observed in 1743, which also exhibited a deviation from the parabola, and Olbers favored his view, but no elliptical elements have yet been deduced directly from the observations of 1743. Elements which appear in some of the catalogues of comet-orbits with Clausen's name attached, were merely inferred from an assumed semi-axis major of 3.10, founded upon the hypothesis of identity with Blanpain's comet of 1819. The latter has not been observed since that appearance.

III. Burckhardt's Comet. 1766, II.

T.....1766, April 26-9581	$e$ .....0.86400.
$a$ .....2.93368.	$a$ .....2.93368.
$\Omega$ .....251 13 0	Period...5.025 years.
$i$ .....74 11 0	Direct.
$i$ .....8 1 45	

Though there is great probability of the identity of this comet with Winnecke's comet (No. VII.), it is preferable at present to treat of these bodies separately. The comet of 1776 was undoubtedly moving in an elliptical orbit of no long period, as was established by Burckhardt after a great amount of computation, but the observations were not sufficiently precise to allow of the length of revolution being found with exactness.

IV. *Tempel's Comet.* 1873, II.

T.....	1873, June 25-3777	e.....	0.544156
		a.....	2.94954
$\omega$ .....	306 9 43	Period..	5.066 years.
$\Omega$ .....	120 54 9		Direct.
$i$ .....	12 43 20		

Discovered by Tempel at Milan, 1873, July 3. The marked deviation from a parabolic orbit was soon independently noticed in England and on the Continent. It does not appear that there is any record of this comet having been observed prior to the year 1873.

V. *De Vico's Comet.* 1844, I.

T.....	1844, September 2-4779	e.....	0.617372
		a.....	3.10045
$\omega$ .....	342 30 48	Period..	5.459 years.
$\Omega$ .....	63 49 38		Direct.
$i$ .....	2 54 46		

Discovered by De Vico at Rome, 1844, August 22. Notwithstanding the elaborate calculation of the orbit by Professor Brünow, the comet has not been detected since 1844. The researches of M. Leverrier make it highly probable that this body is identical with the comet observed by Lahire at Paris in 1673, though it was not detected at any one of the many returns to perihelion which must have taken place in the interim.

VI. *Brorsen's Comet.* 1846, III.

T.....	1873, October 10-2694	e.....	0.808560
		a.....	3.10556
$\omega$ .....	116 2 50	Period..	5.473 years.
$\Omega$ .....	101 12 38		Direct.
$i$ .....	29 24 13		

Discovered by Brorsen at Kiel, 1846, February 26, and since observed at several returns, including the last in 1873, to which year, it will be seen, the above elements apply. The comet appears to have been detected at its first passage of the perihelion in the present orbit, the form of which is evidently due to a very near approach to the planet Jupiter, in May, 1842. A first approximation to the elements previous to this encounter with Jupiter has been given by the late Professor D'Arrest.

VII. *Winnecke's Comet.* 1858, II. (= 1819, III. = 1766, II. ?)

T.....	1875, March 12-1765	e.....	0.741013
		a.....	3.20081
$\omega$ .....	276 37 51	Period..	5.727 years.
$\Omega$ .....	111 29 43		Direct.
$i$ .....	11 17 4		

A comet discovered by Professor Winnecke, 1858, March 8, was soon found to be moving in an elliptical orbit of short period, and to be identical with the third comet of 1819, to which Encke had assigned a revolution of 5.62 years. The two appearances of 1819 and 1858, have since been connected, from calculation of the perturbations produced by the planet Jupiter, by Clausen, so that there is no possible doubt of the identity of the comets of these years. According to Clausen's computation the intermediate perihelion passages took place, 1826, February 5; 1830, August 21; 1836, March 3; 1841, September 13; 1847, March 29; and 1852, October 11, the comet being missed at every return. Our elements are for the last appearance in 1875. (See No. III.)

VIII. *Pigott's Comet.* 1783.

T.....	1783, November 19-9304	e.....	0.552456
		a.....	3.26066
$\omega$ .....	50 17 25	Period..	5.888 years.
$\Omega$ .....	55 40 31		Direct.
$i$ .....	45 6 54		

Certainly a comet which at the time it was detected by Pigott (of variable-star celebrity) at York, 1783, November 19, was moving in an orbit with short period of revolution. This was first established by Burekhardt about the year 1819, but the most accurate orbit will be that of Professor Peters of Clinton Observatory, New York, who has used improved solar places. His orbit is given above. The comet has not been observed since 1783, but Peters has pointed out that with a major axis differing very little from that he had found, the comet might have encountered the planet Jupiter at some one of the aphelion passages subsequent to 1783, and thus have undergone an entire change of orbital elements.

IX. *Tempel's Comet.* 1867, II.

(1.) T.....	1867, May 23-9204	e.....	0.509706
		a.....	3.18903
$\omega$ .....	236 9 24	Period..	5.695 years.
$\Omega$ .....	101 10 10		Direct.
$i$ .....	6 24 36		
2.) T.....	1873, May 9-0134	e.....	0.461990
		a.....	3.28895
$\omega$ .....	237 38 42	Period..	5.965 years.
$\Omega$ .....	78 44 39		Direct.
$i$ .....	9 44 13		

Discovered by Tempel in April, 1867; the periodicity established at the same appearance. We have here given orbits both for that year and for the next return in 1873, on account of the heavy perturbations which the elements suffered from the attraction of Jupiter, near to which the comet passed about the aphelion passage. It will be seen that the node was thereby thrown back more than 22°, the inclination increased 3½°, and the revolution lengthened upwards of three months. The least distance between the planet and comet was about 0.32, the earth's mean distance being taken as unity.

X. *Biela's Comet.*

The periodicity of this comet was ascertained on its discovery in February, 1826, by Biela, at Josephstadt, Bohemia, and independently by Gambart at Marseilles about ten days later. Both discoverers remarked the similarity of elements to those of the comets of 1772, imperfectly observed by Montaigne at Limoges, and the first comet of 1806. Clausen's calculations showed that the period of revolution between 1772 and 1826 had been about 6½ years, the comet having escaped observation at the intermediate returns, excepting that of 1806, when it was detected by Pons. Professor Santini of Padua has principally occupied himself with the investigation of the motions of this comet, and more recently the late Professor Hubbard, of Washington. The comet was observed at its reappearance in 1832, but missed in 1839, from proximity to the sun's place. At the next return in 1845-6 it was again found, and at this appearance a remarkable separation into two distinct nebulosities took place under the eyes of astronomers. In 1852 both components were re-observed, and were found to have considerably widened their distance from one another. At the return to perihelion in 1859, there was no possibility of observations from unfavorable position in the heavens; but in 1866, according to calculation, which involved accurate determination of the planetary perturbations, its track seemed likely to favor observation, yet, notwithstanding long and minute search, the comet was not found, nor was anything seen of it as a comet in 1872. In this year, however, there occurred an extraordinary shower of meteors at the end of November, which beyond doubt were moving in the orbit almost identical with that of Biela when last observed. Subjoined are the elements of the two nebulosities forming the comet at the last appearance in 1852:

(A.) T.....	1852, September 23-0443	e.....	0.755838
		a.....	3.52479
$\omega$ .....	109 9 16	Period..	6.618 years.
$\Omega$ .....	245 53 13		Direct.
$i$ .....	12 33 11		
(B.) T.....	1852, September 23-7259	e.....	0.755872
		a.....	3.52587
$\omega$ .....	109 9 10	Period..	6.619 years
$\Omega$ .....	245 52 15		Direct.
$i$ .....	12 33 26		

XI. *D'Arrest's Comet.*

T.....	1877, May 10-3325	e.....	0.627805
		a.....	3.54139
$\omega$ .....	319 9 16	Period..	6.664 years.
$\Omega$ .....	146 9 29		Direct.
$i$ .....	15 43 9		

Discovered by D'Arrest at Leipsic, 1851, June 27; he suspected a marked deviation of the orbit from a parabola as early as July 8, and elliptical elements were very fairly determined at this first observed visit. M.M. Villarcseau and Leveau, of Paris, have principally occupied themselves with the motions of this body, which, like others of the group, approaches very near to the orbit of Jupiter, thereby at times undergoing considerable perturbation. This was the case in 1861, when the distance between the two bodies was only 0.36, so that the elements we have given above for 1877, are materially different from what they were in 1851; the period of revolution is now about 100 days longer than when the comet was discovered. It was observed in 1867-68, and in 1870, but missed at the intermediate return.

XII. *Faye's Comet.*

T.....	1873, July 18-4866	e.....	0.557383
		a.....	3.80138
$\omega$ .....	50 2 53	Period..	7.412 years.
$\Omega$ .....	209 38 57		Direct.
$i$ .....	11 21 50		

Discovered by M. Faye at Paris, 1843, Nov. 22, and period determined at this appearance. M. Leverrier has made very extensive researches respecting the previous motions of this comet, which he considers to have been revolving in an orbit of the above limited dimensions since the year 1747, when it may have passed so near to the planet Jupiter as to have its orbit completely changed. The calculations relating to this comet have for many years been in the hands of Dr. Axel Møller of Lund, the results of whose masterly computation of the perturbations will be found in various volumes of the *Astro-*

ometische Nachrichten. Observations have been made at every return to perihelion since 1843.

XIII. *Peters's Comet.* 1846 (V.)

T.....1846, June 1-2124	e..... 0-721339	
	e..... 5-48558	Period..12-85 years.
$\pi$ ..... $\overset{\circ}{240} \overset{\prime}{7} \overset{\prime\prime}{35}$		
$\Omega$ ..... $260 \ 28 \ 59$		1846-0
$i$ ..... $30 \ 24 \ 24$		

Discovered at Naples by Dr. Peters, now director of the Observatory of Clinton, U.S., 1846, June 28, and not observed elsewhere, except at Rome on July 2. The period of revolution is uncertain to  $\pm 1.6$  years, according to Peters's last discussion of the observations of 1846, since which year the comet has not been found, though there appears to be no doubt of the great deviation of the orbit from a parabola.

XIV. *Tuttle's Comet.*

T.....1871, December 1-7974	e..... 0-821054	
	e..... 5-75652	Period..13-81 years.
$\pi$ ..... $\overset{\circ}{116} \overset{\prime}{4} \overset{\prime\prime}{35}$		
$\Omega$ ..... $269 \ 17 \ 12$		1870
$i$ ..... $54 \ 17 \ 0$		

Periodicity discovered in 1858, when the comet was detected by Mr. Tuttle at Cambridge, U.S. (January 4). It was soon found to present a great similarity of elements to those of the second comet of 1790, which was found by Mechain at Paris on January 9, and further investigation established the identity of the comets, five revolutions having been performed between 1790 and 1858. The two appearances have been connected by the calculation of the perturbations in the interval by Clausen and Tischler.

GROUP B.

I. *Comet 1866, I.* (Tempel.)

T.....1866, January 11-1339	e..... 0-905420	
	e..... 10-32479	Period..33-18 years.
$\pi$ ..... $\overset{\circ}{60} \overset{\prime}{28} \overset{\prime\prime}{6}$		
$\Omega$ ..... $231 \ 26 \ 3$		1866-0
$i$ ..... $17 \ 18 \ 5$		

This body is widely known as the "comet of the November meteors," which have been found to move in an orbit that is almost identical. It was discovered by Tempel, 1866, Dec. 19; the best determination of the elliptical elements is due to Prof. Oppfänger. The ensuing return to perihelion will be looked for in 1899, in which year a repetition of the grand meteoric display of 1866 may also be expected.

II. *Stephan's Comet.* 1867, I.

T.....1867, January 19-8606	e..... 0-849055	
	e..... 10-41762	Period..33-62 years.
$\pi$ ..... $\overset{\circ}{75} \overset{\prime}{52} \overset{\prime\prime}{16}$		
$\Omega$ ..... $78 \ 35 \ 45$		1867-0
$i$ ..... $18 \ 12 \ 35$		

Discovered by Stephan at Marseilles, 1867, Jan. 27. The elliptical orbit which represents the whole course of observation very closely is due to Mr. Searle of Cambridge, U.S. This comet appears to make a very close approach to the orbits of Mars and Uranus, and it is likely the actual form of orbit may be owing to an encounter with the latter planet near the aphelion.

III. *Westphal's Comet.* 1852.

T.....1852, Oct. 12-7628	e..... 0-918463	
	e..... 15-3315	Period..60-03 years.
$\pi$ ..... $\overset{\circ}{43} \overset{\prime}{14} \overset{\prime\prime}{8}$		
$\Omega$ ..... $346 \ 9 \ 49$		1852-0
$i$ ..... $40 \ 54 \ 28$		

Discovered by Westphal at Göttingen, 1852, July 24. The elliptical character of the orbit was first established by Marth in the same year. Elements, in the calculation of which the effect of planetary attraction during the period of observation is included, have been published both by the discoverer and by Dr. Axel-Müller, whose elaborate investigations relating to Faye's comet have been already mentioned.

IV. *Pons's Comet.* 1812.

T.....1812, Sept. 15-3186	e..... 0-954541	
	e..... 17-0955	Period..70-69 years.
$\pi$ ..... $\overset{\circ}{92} \overset{\prime}{18} \overset{\prime\prime}{44}$		
$\Omega$ ..... $353 \ 1 \ 2$		1812
$i$ ..... $73 \ 57 \ 3$		

Detected by Pons at Marseilles, 1812, July 20, and independently at a later date by Wisniewsky at Novo-Toherkask. To Encke is due the discovery of the periodicity, but it is doubtful if the length of revolution can be inferred from the observations, within several months, so that although another perihelion passage is approaching, no reliable prediction of the track in the heavens is at present practicable.

V. *De Vico's Comet.* 1846, III.

T.....1846, March 5-5454	e..... 0-962089	
	e..... 17-5072	Period..73-25 years.
$\pi$ ..... $\overset{\circ}{90} \overset{\prime}{27} \overset{\prime\prime}{6}$		
$\Omega$ ..... $77 \ 33 \ 33$		1846-0
$i$ ..... $85 \ 5 \ 42$		

Discovered by De Vico at Rome, 1846, Feb. 20, and in a few weeks recognised as a periodical comet, ellipses having been calculated by Breen, Hind, and Pierce. The most reliable orbit, which is given above, is by Van Galen. This comet makes a near approach to the orbit of the planet Venus.

VI. *Olbers's Comet.* 1815.

T.....1815, April 26-9922	e..... 0-931220	
	e..... 17-6338	Period..74-05 years
$\pi$ ..... $\overset{\circ}{149} \overset{\prime}{1} \overset{\prime\prime}{56}$		
$\Omega$ ..... $83 \ 28 \ 54$		1815
$i$ ..... $44 \ 29 \ 55$		

Discovered by Olbers at Bremen, 1815, March 6. The elements transcribed were calculated by Bessel upon the whole course of observation; very similar ellipses were also found by Gauss, Nicolai, and Nicollet. Bessel computed the effect of planetary attraction upon the motion of the comet in the actual revolution, and assigned the next perihelion passage to 1887, Feb. 9; but unfortunately this date is not to be relied upon within anything like narrow limits.

VII. *Brorsen's Comet.* 1847, V.

T.....1847, Sept. 9-5427	e..... 0-972560	
	e..... 17-7795	Period..74-97 years.
$\pi$ ..... $\overset{\circ}{79} \overset{\prime}{12} \overset{\prime\prime}{6}$		
$\Omega$ ..... $309 \ 48 \ 49$		1847
$i$ ..... $19 \ 8 \ 25$		

Discovered by Brorsen at Altona, 1847, July 20. While there appears to be no doubt of the ellipticity, the period is yet open to considerable uncertainty, Dr. Gould (the present director of the Observatory of Cordova) having inferred a revolution of 81-05 years. It is one of those comets which yet require a more minute calculation.

VIII. *Halley's Comet.*

In the case of this celebrated body we shall content ourselves with reproducing the elements for the appearance of 1835-36, as elaborately worked out by Westphalen, and the elements assigned for the next return in the year 1910 by the late Count de Pontécoulant.

Elements of 1835-36.

T.....Nov. 15-9082	e..... 0-967871	
	e..... 17-9879	Period..76-30 years.
$\pi$ ..... $\overset{\circ}{304} \overset{\prime}{31} \overset{\prime\prime}{82}$		
$\Omega$ ..... $55 \ 9 \ 59$		1835-0
$i$ ..... $17 \ 45 \ 5$		

Elements of 1910.

T.....May 23-86	e..... 0-961733	
	e..... 17-9555	Period..76-08 years.
$\pi$ ..... $\overset{\circ}{305} \overset{\prime}{33} \overset{\prime\prime}{14}$		
$\Omega$ ..... $57 \ 10 \ 33$		1910
$i$ ..... $17 \ 46 \ 51$		

It would be useless to attempt to present a history of Halley's comet within the space to which this article must be limited. With regard to its history previous to the year 1456, the earliest visit known to Halley, the reader may refer to a paper on "The Past History of the Comet of Halley," Hind, in *Monthly Notices of the Royal Astronomical Society*, vol. x., in which the appearances of the comet are traced back with a greater or less degree of probability to the year a.c. 12, chiefly by aid of the details preserved to us in the Chinese annals; also to a remarkable memoir by the late Dr. Angström of Upsala, *Sur deux intégralités d'une grandeur remarquable dans les apparitions de la comète de Halley*, Upsala, 1862, which is corroborative of the conclusions in the first-mentioned paper.

(J. R. H.)

COMINES, a town of France, in the department of Nord and the arrondissement of Lille on the River Lys, which there divides Belgium from France. It is a thriving manufacturing town, with breweries, linen and tape factories, bleachfields, and oil-works. The principal building is the collegiate church of St. Peter's. It was in this place that Comines, the French chronicler, was born. Population in 1872, 4020 in the town, and 6353 in the commune.

COMINES, PHILIPPE DE (1445-1509), called the father of modern history, was born at the castle of Comines. He lost both father and mother in his earliest years. In 1468 his godfather, Philip of Burgundy, summoned him to court, and soon after transferred him to the household of his son.

afterwards known as Charles the Bold. He speedily acquired considerable influence over the mind of Charles, and in 1468 was appointed chamberlain and councillor; consequently when in the same year Louis XI. entrapped himself at Peronne, Comines was able both to soften the passion of the duke and to give useful advice to the king, whose life he did much to save. Three years later he was charged with an embassy to Louis, who gained him over to himself by many brilliant promises. In 1472 he left Burgundy for the court of France. He was at once made chamberlain and councillor; a pension of 6000 livres was bestowed on him; he received the principality of Talmont, the confiscated property of the family of La Tremville; and many other dignities and presents of land were conferred on him by the king. He was employed to carry out the intrigues of Louis in Burgundy, and spent several months as envoy in Italy. On his return he was received with the utmost favor, and in 1479 obtained a decree confirming him in possession of his principality.

On the death of Louis a suit was commenced against Comines by the family of La Tremville, and he was cast in heavy damages. He plotted against the regent, Anne de Beaujeu, and joined the party of Orleans. Having attempted to carry off the king, and so free him from the tutelage of his sister, he was arrested, and put in one of his old master's iron cages at Loches. In 1489 he was banished to one of his own estates for ten years, and made to give bail to the amount of 10,000 crowns of gold for his good behavior. Recalled to the council in 1492, he strenuously opposed the Italian expedition of Charles VIII., in which, however, he took part, notably as representing the king in the negotiations which resulted in the treaty of Vercelli. During the rest of his life, notwithstanding the accession of Louis XII., whom he had served as duke of Orleans, he held no position of importance; and his last days were disturbed by law-suits. He died at Argenton in 1509.

The *Memoirs*, to which Comines owes his reputation as a statesman and man of letters, were written during his latter years; the first six books are assigned to 1488-94, and the next two to 1497-1501. Hallam says of them that they "almost make an epoch in historical literature;" and Sainte-Beuve, after speaking of Comines as being in date the first truly modern writer, and comparing him with Montaigne, says that his history remains the definitive history of his time, and that from it all political history took its rise. None of this applause is undeserved, for the pages of Comines abound with excellences. He analyzes motives and pictures manners, he delineates men and describes events; his reflections are pregnant with suggestiveness, his conclusions strong with the logic of facts.

The *Memoirs* remained in MS. till 1524, when part of them were printed by Gallot du Pré, the remainder first seeing light in 1825. Subsequent editions were put forth by Denys Sauvage in 1552, by Denys Godefroy in 1649, and by Lenglet Dufresnoy in 1747. That of Mademoiselle Dupont (1841-48) is the best. Various translations of Comines into English have appeared, from that of T. Danett in 1596 to that based on the Dupont edition, which was printed in Bohn's series in 1855.

COMITAN, or COMITLAN, a town of Mexico in the state of Chiapas, on the River Grijalva, a tributary of the Tabasco, about forty miles south-east of San Cristobal, the capital of the state. It has a superb church, and a convent dedicated to St. Domingo, from which it takes the more precise designation of San Domingo Comitán. The inhabitants derive their subsistence in great measure from agriculture; but they also carry on a smuggling trade with Belize and Guatemala. Population about 10,000.

COMITIA, derived from *con* and *ira*, was employed by the Romans to denote an assembly of the people, called for the purpose of accepting or rejecting some proposition submitted to them by the heads of the state. It was a fundamental principle of the Roman constitution that the supreme power was inherent in the citizens, though it might be delegated by them to hereditary or to elected magistrates. All important matters, however, had to be brought before the sovereign people, who could either ratify or reject, but without discussion, the proposals made to them. Such, at least in theory, and during the best days of the republic in practice also, was the function of these popular assemblies.

As may be readily understood, different elements had the ascendancy among the Roman people at different periods

in their history. So far as it was possible for a state exposed to so many and such various influences to be conservative of its political traditions, Rome, whether monarchical, republican, or imperial, was essentially so. But under the force of circumstances innovations were introduced from time to time, which materially altered the position of the two political parties—the patricians and the plebeians—into which the state was early divided, and by whose dissensions it was long distracted. And in none of her institutions can the progress of the struggle between these rival factions be more clearly traced than in the nature and powers of those assemblies or comitia, by which the supreme authority at Rome was in succession wielded.

It is usual to describe the Roman comitia as of three kinds, named from the mode in which the people were organized and in which they voted—the comitia curiata, or assembly of the curiæ; the comitia centuriata, or assembly of the centuries; and the comitia tributa, or assembly of the tribes. To these some add a fourth,—the comitia calata (from *calare*, to call); but as this assembly had neither political functions nor a separate organization, it is unnecessary to do more than mention the name.

1. *Comitia Curiata*. The assembly of the curiæ is believed to have been coeval with the rise of Rome itself, and its origin is therefore rightly ascribed by tradition to the mythical founder of the city. The system seems to have been an essential part of the constitution of the early Latin communities, of which Rome was originally only one. Its primary object cannot now be satisfactorily determined; but the purpose for which it came to be employed is sufficiently clear. From a very early period the Roman curiæ, or "wardships," as they may be called, numbered thirty, being ten for each of the three once independent communities—the Ramnians, Tities, and Luceres—from whose amalgamation the Roman people sprang. At first these curiæ were probably made up exclusively of the freeholders, or patricians, as the latter were afterwards designated, on whom devolved exclusively the right and duty of bearing arms. It has been maintained by some that the class of dependants called by Roman writers clients as well as the burgesses or citizens had a right to vote in the assembly of the curiæ. No direct evidence, however, can be brought forward in support of this supposition, which in the nature of the case is highly improbable; and if allowed to be present at all, they were likely nothing more than spectators, or, as their name is said to imply, "listeners." In an assembly each curia had one vote, which was determined by the majority of the individual votes in the different curiæ. As the number of the latter was even, and no provision was made for deciding the matter in the case of their being equally divided on any question, it would seem as if this function had not been thought of in fixing the number of the curiæ, or had been subordinated to some other consideration.

2. *Comitia Centuriata*. By the operation of causes sufficiently obvious, a great increase soon took place in the numbers and influence of the dependent members of the Roman commonwealth. As a natural consequence, the way was paved for a reform of the constitution, though we may well conceive that the step was hastened by the gradual thinning of the ranks of the old freeholders in the incessant wars in which Rome found herself involved with her neighbors. Thus in the course of time a new class, the plebeians of history, arose out of the clients, preponderating in numbers and by no means destitute of wealth. If this class was allowed no rights as citizens, it was exempt from service in the field; and while their political inferiority must have been galling to its members their immunity from the chances of war can hardly have been looked upon with equanimity by the ruling faction. It was to redress this twofold grievance that the reform ascribed to King Servius Tullius is generally believed to have been effected. But the whole scheme was one skillfully devised, so as to assign to the plebeians duties rather than to bestow upon them rights, and it was evidently the work of a statesman who was in the interest of the patricians. Our chief authorities for the details of the arrangement are Livy and Dionysius, whose accounts, though they differ in some particulars, agree in the main. We must bear in mind, however, that both of them describe the assembly of the centuries rather as it existed in their own day than as it was at first constituted.

According to the authors just named, the whole body of



free Romans, burgesses and non-burgesses, was divided into a certain number of classes (i.e., "summonings," probably from *calare*), numbered according to the amount of fortune possessed by each citizen. The class of each man was ascertained by means of a register, drawn up every five years by officers appointed for the purpose, in which were set forth in detail the age of the citizen, the amount of his property, and other particulars. The first class comprised all whose fortune was estimated at not less than 100,000 asses or pounds of copper, sub-divided into 40 centuries of "juniors," who could be called upon for active service, and 40 centuries of "seniors," who in time of war were to do garrison duty at home. In the second class were enrolled those who had property valued at not less than 75,000 asses, with 10 centuries of juniors, 10 of seniors, and 2 of artificers. The third, fourth, and fifth classes included those who possessed not less than 50,000, 25,000, and 12,500 (according to Livy, 11,000) asses respectively, sub-divided into centuries in a similar manner. Those who had not a sufficient money qualification are included by Livy in the fifth class, and made to form a single century, but are reckoned by Dionysius as a sixth class. In addition, there were 18 centuries of equites, or cavalry, who always voted first, made up of the most wealthy members of the landholder class, the actual possession of land being apparently regarded as a necessary qualification for this, the favorite branch of the service. Livy gives the whole number of the centuries as 194; Dionysius makes them 193. The voting in the assembly was by centuries, each century possessing a collective vote exactly as in the case of the curiæ. It was so arranged that the 18 centuries of equites and the 80 centuries of the first class voted first. If they were agreed on the question at issue, the other classes were not called upon to vote at all. As the centuries, though nominally "hundreds," might and probably did contain fewer in the first class, and certainly many times more than that number in some of the other classes, it is plain that in the assembly by far the largest share of power was retained in the hands of the wealthy, of whom the original burgess element would long form the main portion. How far we have in this scheme merely a modification of an earlier arrangement there are no means of determining. As Mommsen remarks, it is more than probable that the assessments were originally laid on land. Be this as it may, the Servian reform was originally a new military rather than a new political organization, its author intending that the privileges of the patricians, assembled in their curiæ, should remain as before. But its results were different from what had been anticipated. By a process easily understood, the rights of the curiæ gradually passed to the centuries. The assembly of the former continued indeed to meet, but the assembly of the latter became thenceforth the chief guardian of the rights of the Roman people.

3. *Comitia Tributa*. The further growth and development of the democratic element in the Roman constitution, consequent on the change just described, soon led to a demand for greater changes in the same direction. The tribunes of the people, now the acknowledged leaders of the democracy, took advantage of an ancient division of the original territory of Rome into tribes to give greater prominence to this element than it had yet possessed. These tribes, 30 and afterwards 35 in number, which, as is supposed by some, had already supplied a basis for the arrangement into curiæ as well as classes, seem to have at first existed for purely local purposes. But the leaders of the people succeeded at length in forming them into a political union entitled to exercise certain functions, chief among which was the election of the inferior magistrates, and the approval or rejection of such legislative measures as affected the interests of the plebeians as a class. Whether the assembly of the tribes was composed of plebeians only, or of all, whether patrician or plebeian, living within certain limits, has not been ascertained, the balance of opinion inclining to the hypothesis that makes it to have consisted of plebeians alone. After the rise of this new power, it became a matter of great difficulty to determine what questions were to be submitted to the tribes and what to the centuries, each claiming to be the real representatives of the whole body of the people. A solution appears to have been sought for and found in some combination of the two rival assemblies. At what times this change took place, and what was its exact nature, are

matters that must ever remain involved in the greatest obscurity. All that can be said is this; either by means of their own assembly, or by their using it somehow for the purpose of counterbalancing the power of the patricians in the assembly of the centuries, the plebeians ultimately gained what they had so long aimed at—a position of supreme importance in the republic. When the wealthier classes found their influence thus neutralized, they ceased to attend the comitia altogether, and the popular will was represented by the lower classes alone. A period of moral and political corruption followed, ending in the military despotism of the Cæsars. Under the first emperors, the form of calling the assemblies together was still observed, but the people met no longer to control their chief ruler, but simply to receive information as to what he had done. Even this form was by and by discontinued, and in the last days of the empire the comitia was an institution known only as one of the traditions of the past greatness of Rome. (J. M'D.)

COMMERCE, in its general acceptance, is the international traffic in goods, or what constitutes the foreign trade of all countries as distinct from their domestic trade, and it will be convenient in this place to treat it chiefly under this aspect.

The same causes which give rise to exchange of commodities in a limited field call it into operation over more extended territories, and the same effects which flow from it in the smaller flow from it in the larger sphere. There are the same phenomena in either case, but in proportion as trade extends beyond the narrow boundaries of a tribe or a nation, the greater are the obstacles it has to encounter, not only in physical distance, and the practicable transit of commodities, but in computation, in gauging the capacity and course of markets; in the risk of making wrong adventures, in the rivalry and exclusiveness, the wars and revolutions of states; and consequently the more liable it becomes to complications, partly native and partly foreign to itself, by which its advantages have been obscured and its progress has been impeded in all ages.

Exchange of commodities implies not only a division of labor, but a development of natural resources where most abundant and accessible. As long as mankind live in scattered and isolated families, each supplying its own wants directly by its own labor, there can be little or no commerce; and as long as there is no commerce every local habitation of man must depend on its natural resources, however poor, unvaried, or difficult to utilize. Division of labor and exchange may be said to be of twin birth, since the existence of the one cannot be conceived without the other; and as they grow up from the simplest embryo, they act and react on each other, giving always wider scope to their mutual operation, and preparing a certain density of population in central places or markets, where the traffickers meet and artificers find it their interest to settle, whether in the desert where caravans converge in their various routes from one region to another, or at the confluence of navigable rivers, or in secure bays of inland seas, commanding an extensive coast-line, or some interoceanic passage, and thus laying the foundation of towns and cities, to become, it may be, as they have become in many instances, the seats of rule and empire. The direct result of these primitive human instincts, as they may be called, of division and exchange of the products of labor was to extend among mankind a material and social comity, apart from all tribal or political relations, from which sprung, as on a solid base or framework, the fair but often frail fabric of civilization, arts, sciences, letters, philosophy, religion—all that gives grace and dignity to humanity. The special office of commerce, in the material part of the economy, is to organize places, soils, climates, all local conveniences of land or sea, and superior natural resources of various countries, as that of the division of labor is to organize the talent, handiness, and aptitude of individuals.

The formative and developing power of this function of commerce is much more conspicuous in the phenomena of ancient history and in contemporary results than may at first sight appear. It was easy, judging from local qualities alone, to explain why the metropolis of the United Kingdom should be on the Thames where London now is; how rival ports arose along the western coast of Britain, on the Severn, the Mersey, and the Clyde; why Lancashire should have become the great centre of the cotton

manufacture; why Dundee, from a small beginning in flax from the adjacent Baltic, should have become a great emporium of flaxen and cognate fabrics; why there should be a Hull on the Humber, a Newcastle on the Tyne, and a rapidly-rising Middlesborough on the Tees; why the Thames should maintain, after many centuries of change and amidst many rivals, its pristine supremacy, and yet the western coast of our island be much more brilliant commercially than the eastern. But the same principle may be no less a guide to our understanding why the earliest records we have of great seats of population should be on the Euphrates, the Nile, the Ganges, and the Blue and Yellow Rivers of China; how Palmyra, the ancient grandeur of which has been discovered in its modern ruins, should have been built in the middle of a desert; how the cradle of navigation and maritime commerce should be so indelibly couched along the coasts and round the numerous islands of the Mediterranean Sea; how international trade, seeking an outlet from its dreary prison of overland desert, war, and rapine, should have found it for a time by the Mediterranean to the Red Sea and the Indian Ocean, only to be diverted by a bold navigation around the cape of Africa, and should now be returning, under more secure conditions, to the shorter route again. The tendency of commerce to connect one seat of population with another, to open roads, to seize on every physical advantage of transit between them, to create new centres of industry and traffic on the lines of communication, and by the union, not only of human labor and capacities, but of almost boundlessly diversified territorial resources thus effected, to increase the production and circulation of commodities, is too obvious to require illustration. This is what has been called by economists "the territorial division of labor," but the term scarcely reaches a full expression of the effect of commerce. There is not only a territorial extension of the division of labor in the sense of being spread over a larger area and a greatly more numerous population, but the physical resources, the natural agents of wealth themselves, as found in various countries and places, are brought into the general organization as they could be by no other means, and made to yield in due harmony with each other all their special and relative superiorities.

A consideration of this action of international traffic in commodities is sufficient to dispel many false views that have at various times been propounded with much authority—such as that commerce, being an exchange of value for value, can add nothing to the general wealth; or that the profit of one party to an exchange is the loss of the other party; or that the only profit of commerce consists of the balance accruing in the precious metals; and similar crudities of conception. The substratum of the whole system of international traffic is that commodities, after bearing the cost of transit, are of more value in one place than in another. Commodities are often so abundant, or capable of being produced so abundantly in some places, as to be superfluous, and absolutely valueless in such places, and yet are of much value in other places. As this relation is mutual, there is nothing inconsistent in an exchange of commodities of more value in one place than in another with a gain of value on both sides of the exchange; and this becomes all the more apparent when, in addition to the profit of the merchants or agents employed in the transaction, there is taken into account the gain arising to the communities in their industry, and in the profits of their industry.

Exchange of commodities must have been coeval with human society. However self-depending on their own labor men may have been in the social state, they must soon have had some commodities to exchange with each other, and as stock increased the process would rapidly extend. The liability to failure of crops and to famine must have led to storing of corn in seasons of plenty, and to occasional traffic in the first necessary of life.

The earliest records of commerce on an international scale are to be found in the Hebrew Scriptures. Such a transaction as that of Abraham, for example, weighing down "four hundred shekels of silver, current with the merchant," for the field of Ephron, is suggestive of a group of facts and ideas indicating an advanced condition of commercial intercourse,—property in land, sale of land, arts of mining and purifying metals, the use of silver of

recognized purity as a common medium of exchange, and merchandise an established profession, or division of labor. That other passage in which we read of Joseph being sold by his brethren for twenty pieces of silver to "a company of Ishmaelites, coming from Gilead, with their camels bearing spicery, balm, and myrrh to Egypt," extends our vision still farther, and shows us the populous and fertile Egypt in commercial relationship with Chaldeans and Arabians, foreign to both, as intermediaries in their traffic, generations before the Hebrew commonwealth was founded. The allusions in Homer and other ancient writings do not bespeak so advanced a state of trade as those in Genesis. There would seem to have been brass coins among the warriors engaged at the siege of Troy; and the shields of Homeric heroes cost, some nine oxen, some more splendid a hundred oxen, implying much rude magnificence in the form of barter; and yet probably not such barter, pure and simple, as is seen in the present day at Kiakhta and Maimatchin, on the Chinese borders of Russia, where chests of tea are exchanged in bulk for Muscovite manufactures of cotton or wool. One might fairly infer, from such archaic touches of the Greek bard, that he had in view an agricultural and pastoral state of society, in which oxen, from their more ready power of purchase than any other commodity, had become a rough standard of value; but oxen could not in any state of society be a general medium of exchange, and the history of circulating media, by which exchanges were effected in ancient times, is curiously illustrative of the transition of real into symbolic value. It may be doubted whether the hundred *kesitas* paid by Jacob for a field in Shalem were lambs or pieces of money having lambs as their insignia. The leather money of Carthage, which appears to have been symbolic, was probably much more valuable than the iron money of Sparta, which had an intrinsic worth. Any commodity of the first rank in a public mart might become in small circulations the symbol of so much of that commodity to be delivered to order, and from the constancy of that particular exchange, might be relied upon for the purchase of other commodities. But, generally speaking, the use of gold and silver as instruments of exchange betokens a much higher commercial development than where commodities are priced by a number of oxen, or by rings of brass or iron; and it is on record that the precious metals were thus employed in Arabia and Syria some 2000 years B.C., as they, no doubt, had been much anterior to that date both in Egypt on the one hand and in the rich and populous plains of the Tigris and Euphrates on the other.

The first foreign merchants of whom we read, <sup>Arabs</sup> carrying goods and bags of silver from one distant region to another, were the Southern Arabs, reputed descendants of Ishmael and Esau. Touching in their territory on the south the Red Sea and the right bank of the Nile, and on the north and east the most densely inhabited tracts of Asia, and accustomed in their own interior economy to a free and nomadic life, it may have occurred to the more intelligent and enterprising of these people to enter on this new and adventurous course. Their traffic could only have small beginnings, but they were pioneers of foreign trade, and showed to their richer neighbors that the desert could be pierced. On the other hand, the first navigators and maritime carriers of goods of whom we read were the Phoenicians, the <sup>Phoenicians</sup> *débris* of the Canaanites overthrown by the conquering Hebrews, who, intent on the plain of the Jordan, the hilly slopes of Judea, and the sacred Mount Moriah—the long "promised land,"—allowed the dispossessed to settle on a narrow strip of territory along the coast of the Mediterranean. As the clearance proceeded the number of refugees increased, and this outcast race, with one foot on the sea and the other barely on the land, soon outstripped the Edomites and the Ishmaelites in the career of commerce. They founded Tyre and Sidon, of whose opulence there are abundant proofs both in sacred and in profane history. Launching their oared barks on the wave, and steering close along the shore so as to be able to take shelter in the nearest harborage from a storm, they established a securer and cheaper passage between Egypt and Syria than had before been known. The corn and ivory of the Nile and the oil, silk, dyes, and spices of Western Asia flowed into their hands. From carriers they became merchants, and to merchandise they added manufactures. They enlarged their ships, grew bolder in navigation, and hoisted sails

In the days of Solomon their vessels had penetrated the Red Sea, and brought back to the great king the wealth of Ophir; but that this land of gold was in India, and that the Phœnician craft crossed the Indian Ocean are conclusions unsupported by evidence. It is certain that they traversed thoroughly the shores of the Mediterranean, both continental and insular, established settlements and colonies in many of the islands of the Greek Archipelago, and, greatest of all, founded Carthage, one of the most noted, and probably the most lamented in its fall, of the commercial cities and empires of the ancient world. The kings of Tyre and Sidon, though often involved in the wars and troubles of the Hebrew monarchy, remained for the most part in friendly alliance with Judah and Israel, to whom they were the most valuable of allies both in a commercial and defensive point of view; and it was their adhesion to the cause of Zedekiah, king of Judah, that brought upon the Tyrians the terrible and all but fatal revenge of Nebuchadnezzar, king of Babylon, 3416 A.M. But while their old city on the shore was being reduced to ashes by a thirteen years' siege, the portion of inhabitants who clung to the defence built a new city on an adjacent island, and thus took a new lease of life from the sea—a process which was destined to be almost identically repeated by Venice many centuries afterwards, when the Roman empire was falling under the blows of the barbarians. But Phœnicia never fully recovered her former power, and the *coup de grace* was given to this famous commercial republic in the capture of Tyre by Alexander the Great, 250 years after the struggle with Nebuchadnezzar. The whole inhabitants of the once proud city, who had not saved themselves by flight, were either put to the sword, crucified, or sold into slavery. After this event the name of the Phœnicians disappeared from history, or was soon absorbed in the rising splendor of the commercial cities of Greece—Athens, Corinth, Argos, and their colonies; of Carthage, still in full fame; and of the great seaport named after its founder Alexander, and built in a spot so well chosen that the city retains its importance to the present hour.

**Jews.** In the commerce of the ante-Christian ages the Jews do not appear to have performed any conspicuous part. Both the agricultural and the theocratic constitution of their society were unfavorable to a vigorous prosecution of foreign trade. In such traffic as they had with other nations they were served on their eastern borders by Arabian merchants, and on the west and south by the Phœnician shippers. The abundance of gold, silver, and other precious commodities gathered from distant parts, of which we read in the days of greatest Hebrew prosperity, has more the character of spoils of war and tributes of dependent states than the conquest by free exchange of their domestic produce and manufactures. The varied merchandise of Tyre and Sidon must have passed over the roads of Palestine, and helped to enrich the Jewish treasury. Tadmor, built by Solomon in the Syrian desert, where there were wells of water, can only be supposed to have been designed as a post for the service of this traffic; and it became not only a resting-place for traffickers and their camels, but a great centre of commerce and political power, under the later name of Palmyra. But it was not until the Jews were scattered by foreign invasions, and finally cast into the world by the destruction of Jerusalem, that they began to develop those commercial qualities for which they have since been so famous. A similar remark may be made of the more ancient nation of Egypt, of whom there is scarce a trace to be found as pioneers of foreign trade. When famine visited adjacent tracts of country corn was usually to be obtained on the Nile, but those in want had to go for it, and the Phœnicians at one period, and the Greeks at another, became the corn merchants of Egypt, while Rome for some centuries drew large supplies to order of her Government. One can readily believe the great wealth, industry, and resources of empires of which such cities as Nineveh and Babylon were the capitals; but the habit of Eastern potentates to drain to their central treasuries the riches of the most distant provinces, and the boundless power by which millions of people were doomed to servitude, are calculated to weaken the impression that such emblems of grandeur as may still remain in ruins are to be ascribed to anything which in the present age could be dignified with the name of commerce.

Such being the general spirit and economy of the ancient nations of the East of which we have historic records, it may be more easily conceived how dense populations might grow up on the great plain of Hindustan and the still greater plain of China; have their own wars, revolutions, and social changes; develop much wealth and varied riches, much art and science, much literary and philosophical refinement; have much internal traffic, with little or no commerce beyond their own widely extended and impassable frontiers; and yet be so unknown to the rest of the world that the Persians, even in the days of Xerxes, appear to have had scarce a conjecture that there was such an empire as China in existence; that Alexander, on conquering Persia and watering his horses in the Indus, should dream that he was master of all Asia—"weep," as the romantic version runs, "that there was no more world to conquer;" and that, in short, over the growth of these ancient civilizations of Eastern Asia, surviving to the present day and embracing about a half of the human race, the curtain of history should drop as blankly as if they belonged to another planet, or could be seen only through a haze of fable and mystical tradition.

There are three conditions as essential to extensive international traffic as diversity of natural resources, division of labor, accumulation of stock, or any other primal element—(1) means of transport, (2) freedom of labor and exchange, and (3) security; and in all these conditions the ancient world was signally deficient.

Defective conditions of commerce in the ancient world.

The great rivers, which became the first seats of population and empire, must have been of much utility as channels of transport, and hence the course of human power of which they are the geographical delineation, and probably the idolatry with which they were sometimes honored. Nor were the ancient rulers insensible of the importance of opening roads through their dominions, and establishing posts and lines of communication, which, though primarily for official and military purposes, must have been useful to traffickers and to the general population. But the free navigable area of great rivers is limited, and when diversion of traffic had to be made to roads and tracks through deserts, there remained the slow and costly carriage of beasts of burden, by which only articles of small bulk and the rarest value could be conveyed with any hope of profit. Corn, though of the first necessity, could only be thus transported in famines, when beyond price to those who were in want, and under this extreme pressure could only be drawn from within a narrow sphere, and in quantity sufficient to the sustenance of but a small number of people. The routes of ancient commerce were thus interrupted and cut asunder by barriers of transport, and the farther they were extended became the more impassable to any considerable quantity or weight of commodities. As long as navigation was confined to rivers and the shores of inland gulfs and seas, the oceans were a *terra incognita*, contributing nothing to the facility or security of transport from one part of the world to another, and leaving even one populous part of Asia as unapproachable from another as if they had been in different hemispheres. The various routes of trade between Europe and North-Western Asia to India, which have often been referred to, are to be regarded more as speculations of future development than as realities of ancient history. It is not improbable that the ancient traffic of the Red Sea may have been extended along the shores of the Arabian Sea to some parts of Hindustan, but that vessels braved the Indian Ocean and passed round Cape Comorin into the Bay of Bengal, 2000 or even 1000 years before mariners had learned to double the Cape of Good Hope, is scarcely to be believed. The route by the Euxine and the Caspian Sea has probably never in any age reached India. That by the Euphrates and the Persian Gulf is shorter, and was besides the more likely from passing through tracts of country which in the most remote times were seats of great population. There may have been merchants many who traded on all these various routes, but that commodities were passed in bulk over great distances is inconceivable. It may be doubted whether in the ante-Christian ages there was any heavy transport over even 500 miles, save for warlike or other purposes, which engaged the public resources of imperial states, and in which the idea of commerce, as now understood, is in a great measure lost.

The advantage which absolute power gave to ancient nations in their warlike enterprises, and in the execution of public works of more or less utility, or of mere ostentation and monumental magnificence, was dearly purchased by the sacrifice of individual freedom, the right to labor, produce, and exchange under the steady operation of natural economic principles, which more than any other cause vitalizes the individual and social energies, and multiplies the commercial resource of communities. Commerce in all periods and countries has obtained a certain freedom and hospitality from the fact that the foreign merchant has something desirable to offer; but the action of trading is reciprocal, and requires multitudes of producers and merchants, as free agents, on both sides, searching out by patient experiment wants more advantageously supplied by exchange than by direct production, before it can attain either permanence or magnitude, or can become a vital element of national life. The ancient polities offered much resistance to this development, and in their absolute power over the liberty, industry, and property of the masses of their subjects raised barriers to the extension of commerce scarcely less formidable than the want of means of communication itself. The conditions of security under which foreign trade can alone flourish equally exceeded the resources of ancient civilization. Such roads as exist must be protected from robbers, the rivers and seas from pirates; goods must have safe passage and safe storage, must be held in a manner sacred in the territories through which they pass, be insured against accidents, be respected even in the madness of hostilities; the laws of nations must give a guarantee on which traders can proceed in their operations with reasonable confidence; and the Governments, while protecting the commerce of their subjects with foreigners as if it were their own enterprise, must in their fiscal policy, and in all their acts, be endued with the highest spirit of commercial honor. Every great breach of this security stops the continuous circulation, which is the life of traffic and of the industries to which it ministers. But in the ancient records we see commerce exposed to great risks, subject to constant pillage, hunted down in peace, and utterly extinguished in war. Hence it became necessary that foreign trade should itself be an armed force in the world; and though the states of purely commercial origin soon fell into the same arts and wiles as the powers to which they were opposed, yet their history exhibits clearly enough the necessity out of which they arose. Once organized, it was inevitable that they should meet intrigue with intrigue and force with force. The political empires, while but imperfectly developing industry and traffic within their own territories, had little sympathy with any means of prosperity from without. Their sole policy was either to absorb under their own spirit and conditions of rule, or to destroy, whatever was rich or great beyond their borders.

Nothing is more marked in the past history of the world than this struggle of commerce to establish conditions of security and means of communication with distant parts. When almost driven from the land, it often found both on the sea; and often, when its success had become brilliant and renowned, it perished under the assault of stronger powers, only to rise again in new centres and to find new channels of intercourse.

While Rome was giving laws and order to the half-civilized tribes of Italy, Carthage, operating on a different base, and by other methods, was opening trade with less accessible parts of Europe. The strength of Rome was in her legions, that of Carthage in her ships; and her ships could cover ground where the legions were powerless. Her mariners had passed the mythical straits into the Atlantic, and established the port of Cadiz. Within the Mediterranean itself they founded Carthage and Barcelona on the same Iberian peninsula, and ahead of the Roman legions had depôts and traders on the shores of Gaul. After the destruction of Tyre, Carthage became the greatest power in the Mediterranean, and inherited the trade of her Phœnician ancestors with Egypt, Greece, and Asia Minor, as well as her own settlements in Sicily and on the European coasts. An antagonism between the great naval and the great military power, whose interests crossed each other at so many points, was sure to occur; and in the three Punic wars Carthage measured her strength with that of Rome both on sea and land with no unequal success. But a commercial state impelled into a series of great wars has departed from its own proper base; and in the year

146 B.C. Carthage was so totally destroyed by the Romans that of the great city, more than <sup>Roman conquests.</sup> 20 miles in circumference, and containing at one period near a million of inhabitants, only a few thousand were found within its ruined walls. In the same year Corinth, one of the greatest of the Greek capitals and seaports, was captured, plundered of vast wealth, and given to the flames by a Roman consul. Athens and her magnificent harbor of the Piræus fell into the same hands 60 years later. It may be presumed that trade went on under the Roman conquests in some degree as before; but these were grave events to occur within a brief period, and the spirit of the seat of trade in every case having been broken, and its means and resources more or less plundered, and dissipated—in some cases, as in that of Carthage, irreparably—the most necessary commerce could only proceed with feeble and languid interest under the military, consular, and proconsular license of Rome at that period. It may be remarked that Tyre, the great seaport of Palestine, having been destroyed by Alexander the Great, Palmyra, the great inland centre of Syrian trade, <sup>Palmyra.</sup> was visited with a still more complete annihilation by the Roman Emperor Aurelian within little more than half a century after the capture and spoliation of Athens. The walls were razed to their foundations; the population—men, women, children, and the rustics round the city—were all either massacred or dispersed; and the queen Zenobia was carried captive to Rome. Palmyra had for centuries, as a centre of commercial intercourse and transit, been of great service to her neighbors, east and west. In the wars of the Romans and Parthians she was respected by both as an asylum of common interests which it would have been simple barbarity to invade or injure; and when the Parthians were subdued, and Palmyra became a Roman ~~annex~~, she continued to flourish as before. Her relations with Rome were more than friendly; they became enthusiastic and heroic; and her citizens, in a most brave expedition, having inflicted signal chastisement on the king of Persia for the imprisonment of the emperor Valerian, the admiration of this conduct at Rome was so great that their spirited leader Odenathus, the husband of Zenobia, was proclaimed Augustus, and became co-emperor with Gallienus. But the Palmyrians, on receiving this exalted honor from the Roman senate and people, might have said, "Timeo Danaos dona ferentes," for it introduced into their secure, palm-covered, and lucrative groves of commerce the bane of imperial politics and ambition; and it was the passionate impulse of Palmyra and her widowed queen to erect an empire of their own that brought down upon them the terrible and enduring retribution of Aurelian. It is obvious that the destruction of Palmyra must not only have doomed Palestine, already bereft of her seaports, to greater poverty and commercial isolation than had been known in long preceding ages, but have also rendered it more difficult to Rome herself to hold or turn to any profitable account her conquests in Asia; and, being an example of the policy of Rome to the seats of trade over nearly the whole ancient world, it may be said to contain in graphic characters a presage of what came to be the actual event—the collapse and fall of the Roman empire itself.

The repeated invasions of Italy by the Goths and Huns gave rise to a seat of trade in the <sup>Venice.</sup> Adriatic, which was to sustain during more than a thousand years a history of unusual splendor. The Veneti cultivated fertile lands on the Po, and built several towns, of which Padua was the chief. They appear from the earliest note of them in history to have been both an agricultural and trading people; and they offered a rich prey to the barbarian hordes when these broke through every barrier into the plains of Italy. Thirty years before Attila razed the neighboring city of Aquileia, the consuls and senate of Padua, oppressed and terrified by the prior ravages of Alaric, passed a decree for erecting Rialto, the largest of the numerous islets at the mouth of the Po, into a chief town and port, not more as a convenience to the islanders than a security for themselves and their goods. But every fresh incursion, every new act of spoliation by the dreaded enemies, increased the flight of the rich and the industrious to the islands, and thus gradually arose the second Venice, whose glory was so greatly to exceed that of the first. Approachable from the mainland only by boats, through river passes easily defended by practised sailors against barbarians who had never plied

an oar, the Venetian refugees could look in peace on the desolation which swept over Italy; their warehouses, their markets, their treasures were safe from plunder; and stretching their hands over the sea, they found in it fish and salt, and in the rich possessions of trade and territory which it opened to them, more than compensation for the fat lands and inland towns which had long been their home. The Venetians traded with Constantinople, Greece, Syria, and Egypt. They became lords of the Morea, and of Candia, Cyprus, and other islands of the Levant. The trade of Venice with India, though spoken of, was probably never great. But the crusades of the 12th and 13th centuries against the Saracens in Palestine extended her repute more widely east and west, and increased both her naval and her commercial resources. It is enough, indeed, to account for the grandeur of Venice that in course of centuries, from the security of her position, the growth and energy of her population, and the regularity of her government at a period when these sources of prosperity were rare, she became the great emporium of the Mediterranean—all that Carthage, Corinth, and Athens had been in a former age on a scene the most remarkable in the world for its fertility and facilities of traffic,—and that as Italy and other parts of the Western empire became again more settled her commerce found always a wider range. The political history of the Venetian Republic is deeply interesting, were this the proper place to do more than glance at the fortune of commerce and the circumstances and conditions under which it attains its grandest success. The bridge built from the largest of the islands to the opposite bank became the "Rialto," or famous exchange of Venice, whose transactions reached farther, and assumed a more consolidated form, than had been known before. There it was where the first public bank was organized; that bills of exchange were first negotiated, and funded debt became transferable; that finance became a science, and book-keeping an art. Nor must the effect of the example of Venice on other cities of Italy be left out of account. Genoa, following her steps, rose into great prosperity and power at the foot of the Maritime Alps, and became her rival, and finally her enemy. Naples, Gaeta, Florence, many other towns of Italy, and Rome herself, long after her fall, were encouraged to struggle for the preservation of their municipal freedom, and to foster trade, arts, and navigation, by the brilliant success set before them on the Adriatic; but Venice, from the early start she had made, and her command of the sea, had the commercial pre-eminence.

#### The Middle Ages.

The state of things which arose on the collapse of the Roman empire presents two concurrent facts, deeply affecting the course of trade—(1) the ancient seats of industry and civilization were undergoing constant decay, while (2) the energetic races of Europe were rising into more civilized forms and manifold vigor and copiousness of life. The fall of the Eastern division of the empire prolonged the effect of the fall of the Western empire; and the advance of the Saracens over Asia Minor, Syria, Greece, Egypt, over Cyprus and other possessions of Venice in the Mediterranean, over the richest provinces of Spain, and finally across the Hellespont into the Danubian provinces of Europe, was a new irruption of barbarians from another point of the compass, and revived the calamities and disorders inflicted by the successive invasions of Goths, Huns, and other Northern tribes. For more than ten centuries the naked power of the sword was vivid and terrible as flashes of lightning over all the seats of commerce, whether of ancient or more modern origin. The feudal system of Europe, in organizing the open country under military leaders and defenders subordinated in possession and service under a legal system to each other and to the sovereign power, must have been well adapted to the necessity of the times in which it spread so rapidly; but it would be impossible to say that the feudal system was favorable to trade, or the extension of trade. The commercial spirit in the feudal, as in preceding ages, had to find for itself places of security, and it could only find them in towns, armed with powers of self-regulation and defence, and prepared, like the feudal barons themselves, to resist violence from whatever quarter it might come. Rome, in her best days, had founded the municipal system, and when this system was more than ever necessary as the bulwark of arts and manufactures, its extension became an essential element of the whole European civilization. Towns formed themselves into leagues for mutual protection, and

out of leagues not infrequently arose commercial republics. The Hanseatic League, founded as early as 1241, gave the first note of an increasing traffic between countries on the Baltic and in northern Germany, which a century or two before were sunk in isolated barbarism. From Lubeck and Hamburg, commanding the navigation of the Elbe, it gradually spread over 85 towns, including Amsterdam, Cologne, and Frankfort in the south, and Dantzic, Königsberg, and Riga in the north. The last trace of this league, long of much service in protecting trade, and as a means of political mediation, passed away the other year in the erection of the new German empire, but only from the same cause that had brought about its gradual dissolution—the formation of powerful and legal governments—which, while leaving to the free cities their municipal rights, were well capable of protecting their mercantile interests. The towns of Holland found lasting strength and security from other causes. Their foundations were laid as literally in the sea as those of Venice had been. They were not easily attacked whether by sea or land, and if attacked had formidable means of defence. The Zuyder Zee, which had been opened to the German Ocean in 1282, carried into the docks and canals of Amsterdam the traffic of the ports of the Baltic, of the English Channel, and of the south of Europe, and what the seas did for Amsterdam from without the Rhine and the Maese did for Dort and Rotterdam from the interior. By the Union of Utrecht in 1579, Holland became an independent republic, and for long after, as it had been for some time before, was the greatest centre of maritime traffic in Europe. The rise of the Dutch power in a low country, exposed to the most destructive inundations, difficult to cultivate or even to inhabit, affords a striking illustration of those conditions which in all times have been found specially favorable to commercial development, and which are not indistinctly reflected in the mercantile history of England, preserved by its insular position from hostile invasions, and capable by its fleets and arms to protect its goods on the seas and the rights of its subjects in foreign lands.

The progress of trade and productive arts in the Middle Ages, though not rising to much international exchange, was very considerable both in quality and extent. The republics of Italy, which had no claim to rival Venice or Genoa in maritime power or traffic, developed a degree of art, opulence, and refinement commanding the admiration of modern times; and if any historian of trans-Alpine Europe, when Venice had already attained some greatness, could have seen it 500 years afterwards, the many strong towns of France, Germany, and the Low Countries, the great number of their artisans, the products of their looms and anvils, and their various cunning workmanship might have added many a brilliant page to his annals. Two centuries before England had discovered any manufacturing quality, or knew even how to utilize her most valuable raw materials, and was importing goods from the Continent for the production of which she was soon to be found to have special resources, the Flemings were selling their woollen and linen fabrics, and the French their wines, silks, and laces, in all the richer parts of the British Islands. It is more commonly, indeed, when commerce is somewhat still, and men, finding their means resting within limited bounds, learn to delight in labor and invention for their own sake apart from their immediate profits, that the quality of work is improved, and a vantage ground is established for more extended operations, than when commerce is in full career, everything buoyant, salable, and rising in value, and the lust of gain has taken possession of the human spirit. The Middle Ages may be said to have had this result on a large scale. They placed the barbarous populations of Europe under a severe discipline, trained them in the most varied branches of industry, and developed an amount of handicraft and ingenuity which became an always more solid basis for the future. But trade was too walled in, too much clad in armor, and too incessantly disturbed by wars and tumults, and violations of common right and interest, to exert its full influence over the general society, or even to realize its most direct advantages. It wanted especially the freedom and mobility essential to much international increase, and these it was now to receive from a series of the most pregnant events.

The mariner's compass had become familiar in the European ports about the beginning of the 14th century, and

the seamen of Italy, Portugal, France, Holland, and England entered upon a more enlightened and adventurous course of navigation. The Canary Islands were sighted by a French vessel in 1330, and colonized in 1418 by the Portuguese, who two years later landed on Madeira. In 1431 the Azores were discovered by a shipmaster of Bruges. The Atlantic was being gradually explored. In 1486, Diaz, a Portuguese, steering his course almost unwittingly along the coast of Africa, came upon the land's-end of that continent; and nine years afterwards Vasco de Gama, of the same nation, not only doubled the Cape of Good Hope, but reached Zanzibar. About the same period, a Portuguese traveller penetrated to India by the old time-honored way of Suez; and a land, which tradition and imagination had invested with almost fabulous wealth and splendor, was becoming more real to the European world at the moment when the expedition of Vasco de Gama had made an oceanic route to its shores distinctly visible. One can hardly now realize the impression made by these discoveries in an age when the minds of men were awakening out of a long sleep, when the printing press was disseminating the ancient classical and sacred literature, and when geography and astronomy were subjects of eager study in the seats both of traffic and of learning. But their practical effect was seen in swiftly-succeeding events. Before the end of the century Columbus had thrice crossed the Atlantic, touched at San Salvador, discovered Jamaica, Porto Rico, and the Isthmus of Darien, and had seen the waters of the Orinoco in South America. Meanwhile Cabot, sent out by England, had discovered Newfoundland, planted the English flag on Labrador, Nova Scotia, and Virginia, and made known the existence of an expanse of land now known as Canada. This tide of discovery by navigators flowed on without intermission. But the opening of a maritime route to India and the discovery of America, surprising as these events must have been at the time, were slow in producing the results of which they were a sure prognostic. The Portuguese established at Goa the first European factory in India a few years after Vasco de Gama's expedition, and other maritime nations of Europe traced a similar course. But it was not till 1600 the English East India Company was established, and the opening of the first factory of the Company in India must be dated some ten or eleven years later. So also it was one thing to discover the two Americas, and another, in any real sense, to possess or colonize them, or to bring their productions into the general traffic and use of the world. Spain, following the stroke of the valiant oar of Columbus, found in Mexico and Peru remarkable remains of an ancient though feeble civilization, and a wealth of gold and silver mines, which to Europeans of that period was fascinating from the rarity of the precious metals in their own realms, and consequently gave to the Spanish colonizations and conquests in South America an extraordinary but unsolid prosperity. The value of the precious metals in Europe was found to fall as soon as they began to be more widely distributed, a process in itself at that period of no small tediousness; and it was discovered further, after a century or two, that the production of gold and silver is much like the production of other commodities for which they exchange, viz., limited, and only increased in quantity at a heavier cost, that is, only reduced again by greater art and science in the process of production. Many difficulties, in short, had to be overcome, many wars to be waged, and many deplorable errors to be committed, in turning the new advantages to account. But given a maritime route to India and the discovery of a new world of continents and islands in the richest tropical and subtropical latitudes, it could not be difficult to foresee that the course of trade was to be wholly changed as well as vastly extended.

Maritime route to India.

The substantial advantage of the oceanic passage to India by the Cape of Good Hope, as seen at the time, was to enable European trade with the East to escape from the Moors, Algerines, and Turks who now swarmed around the shores of the Mediterranean, and waged a predatory war on ships and cargoes which would have been a formidable obstacle even if traffic, after running this danger, had not to be further lost, or filtered into the smallest proportions, in the sands of the Isthmus, and among the Arabs who commanded the navigation of the Red and Arabian Seas. Venice had already begun to decline in her wars with the

Turks, and could inadequately protect her own trade in the Mediterranean. Armed vessels sent out in strength from the Western ports often fared badly at the hands of the pirates. European trade with India can scarcely be said, indeed, to have yet come into existence. The maritime route was roundabout, and it lay on the hitherto almost untroubled ocean, but the ocean was a safer element than inland seas and deserts infested by the lawlessness and ferocity of hostile tribes of men. In short, the maritime route enabled European traders to see India for themselves, to examine what were its products and its wants, and by what means a profitable exchange on both sides could be established; and on this basis of knowledge, ships could leave the ports of their owners in Europe with a reasonable hope, via the Cape, of reaching the places to which they were destined without transshipment or other intermediary obstacle. This is the explanation to be given of the joy with which the Cape of Good Hope route was received in one age, as well as the immense influence it exerted on the future course and extension of trade, and of the no less apparent satisfaction with which it has been to some extent discarded in favor of the ancient line, via the Mediterranean, Isthmus of Suez, and the Red Sea in our own time.

The maritime route to India was the discovery to the European nations of a "new world" quite as much as the discovery of North and South America and their central isthmus and islands. The one was the far, populous Eastern world, heard of from time immemorial, but with which there had been no patent lines of communication. The other was a vast and comparatively unpeopled solitude, yet full of material resources, and capable in a high degree of European colonization. America offered less resistance to the action of Europe than India, China, and Japan; but on the other hand this new populous Eastern world held out much attraction to trade. These two great terrestrial discoveries were contemporaneous; and it would be difficult to name any conjuncture of material events bearing so importantly on the history of the world. The Atlantic Ocean was the medium of both; and the waves of the Atlantic beat into all the bays and tidal rivers of Western Europe. The centre of commercial activity was thus physically changed, and the formative power of trade over human affairs was seen in the subsequent phenomena,—the rise of great seaports on the Atlantic seaboard, and the ceaseless activity of geographical exploration, manufactures, shipping, and emigration, of which they became the outlets.

The Portuguese are entitled to the first place in utilizing the new sources of wealth and commerce. They obtained Macao as a settlement from the Chinese as early as 1537, and their trading operations followed close on the discoveries of their navigators on the coast of Africa, in India, and in the Indian Archipelago. Spain spread her dominion over Central and South America, and forced the labor of the subject natives into the gold and silver mines, which seemed in that age the chief prize of her conquests. France introduced her trade in both the East and West Indies, and was the first to colonize Canada and the lower Mississippi. The Dutch founded New York in 1621; and England, which in boldness of naval and commercial enterprise had attained high rank in the reign of Elizabeth, established the thirteen colonies which became the United States, and otherwise had a full share in all the operations which were transforming the state of the world. The original disposition of affairs was destined to be much changed by the fortune of war, and success in foreign trade and colonization, indeed, called into play other qualities besides those of naval and military prowess. The products of so many new countries—tissues, dyes, metals, articles of food, chemical substances—greatly extended the range of European manufacture. But in addition to the mercantile faculty of discovering how they were to be exchanged and wrought into a profitable trade their use in arts and manufactures required skill, invention, and aptitude for manufacturing labor, and these again, in many cases, were found to depend on abundant possession of natural materials, such as coal and iron. In old and populous countries, like India and China, modern manufacture had to meet and contend with ancient manufacture, and had at once to learn from and improve

Discovery of America.

Increase of trading settlements and colonies.

economically on the established models, before an opening could be made for its extension. In many parts of the New World there were vast tracts of country, without population or with native races too wild and savage to be reclaimed to habits of industry, whose resources could only be developed by the introduction of colonies of Europeans; and innumerable experiments disclosed great variety of qualification among the European nations for the adventure, hardship, and perseverance of colonial life. There were countries which, whatever their fertility of soil or favor of climate, produced nothing for which a market could be found; and products such as the sugarcane and the seed of the cotton plant had to be carried from regions where they were indigenous to other regions where they might be successfully cultivated, and the art of planting had to pass through an ordeal of risk and speculation. There were also countries where no European could labor, and the ominous work of transporting African negroes as slaves into the colonies—begun by Spain in the first decade of the 16th century, followed up by Portugal, and introduced by England in 1562 into the West Indies, at a later period into New England and the Southern States, and finally domiciled by royal privilege of trade in the Thames and three or more outports of the kingdom,—after being done on an elaborate scale, and made the basis of an immense superstructure of labor, property, and mercantile interest over nearly three centuries, had, under a more just and ennobling view of humanity, to be as elaborately undone at a future time. These are some of the difficulties that had to be encountered in utilizing the great maritime and geographical conquests of the new epoch. But one cannot leave out of view the obstacles, arising from other sources, to what might be dreamed to be the regular and easy course of affairs. Commerce, though an undying and prevailing interest of civilized countries, is but one of the forces acting on the policy of states, and has often to yield the pace to other elements of national life. It were needless to say what injury the great but vain and purposeless wars of Louis XIV. of France inflicted on that country, or how largely the fruitful and heroic energies of England were absorbed in the civil wars between Charles and the Parliament, to what poverty Scotland was reduced, or in what distraction and savagery Ireland was kept by the same course of events. The grandeur of Spain in the preceding century was due partly to the claim of her kings to be Holy Roman Emperors, in which imperial capacity they entailed intolerable mischief on the Low Countries and on the commercial civilization of Europe, and partly to their command of the gold and silver mines of Mexico and Peru, in an eager lust of whose produce they brought cruel calamities on a newly-discovered continent where there were many traces of antique life, the records of which perished in their hands or under their feet. These ephemeral causes of greatness removed, the hollowness of the situation was exposed; and Spain, though rich in her own natural resources, was found to be actually poor—poor in number of people, poor in roads, in industrial art, and in all the primary conditions of interior development. An examination of the foreign trade of Europe two centuries after the opening of the maritime route to India and the discovery of America would probably give more reason to be surprised at the smallness than the magnitude of the use that had been made of these events.

Mr. David Macpherson, who published his elaborate *Annals of Commerce* in 1805, states that in 1764 the total imports of Great Britain amounted in official value to £11,250,660, and the total exports to £17,446,306.<sup>1</sup> He found from the Custom House books that in 1800 the imports had increased to £30,570,004, and the exports to £43,152,019, which he deemed an encouraging amount of progress, as, in view of the events, then deemed peculiarly

<sup>1</sup> The imports and exports of Ireland at this period, and till the Union, formed a separate account, but the great bulk of them were in her trade with England and Scotland. In 1799 the imports of Ireland from all other ports than Great Britain were £1,268,595, and her exports £769,692; while her imports from Great Britain were £4,011,468, and her exports to Great Britain £4,891,161. Foreign markets were found for Irish manufactures through the British ports, and Ireland was supplied with foreign and colonial merchandise through the same channels. In 1771 the exports of British linen from England were 4,411,040 yards, and of Irish linen 3,450,224 yards. In the same year the exports of linen from Scotland included 70,612 yards of Irish manufacture.

disastrous, that had occurred in the interval—the loss of the American colonies, the French Revolution, and the wars of Bonaparte—it may no doubt be held to be. Of the exports in 1800 £24,304,283 were British, and £18,847,735 foreign and colonial merchandise. The proportion of the latter shows to what extent this country had become the medium of trade between Europe and the East and West Indies; but as these re-exports must be deducted from the total imports, there is left only £11,722,269 of imports to Great Britain for her own purposes of manufacture and consumption. At the beginning of the century two-thirds of the foreign commerce of England was through London, and was largely in the hands of privileged companies. The commercial towns of the provinces and of Scotland had only begun to make some figure. In 1787 Liverpool was a small seaport, having only 445 vessels of 72,731 aggregate tonnage, and clearing inward and outward in foreign trade less than double the amount of her own tonnage. At the same period Glasgow, enriched though she had been by the trade with America, had only 46,000 inhabitants; and Manchester, though a place of considerable manufacture, was still waiting the great impulse to be given to her industry by liberal supplies of cotton, and by the inventions of Arkwright and Crompton.

It may be said, however, that in three eventful centuries the world had been well explored. Colonies had been planted on every coast; great nations had sprung up in vast solitudes or in countries inhabited only by savage or decadent races of men; the most haughty and exclusive of ancient nations had opened their ports to foreign merchantmen; and all parts of the world been brought into habitual commercial intercourse. The seas subdued by the progress of navigation to the service of man, had begun to yield their own riches in great abundance; and the whale, seal, herring, cod, and other fisheries, prosecuted with ample capital and hardy seamanship, had become the source of no small traffic in themselves. The lists of imports and exports and of the places from which they flowed to and from the centres of trade, as they swelled in bulk from time to time, show how busily and steadily the threads of commerce had been weaving together the labor and interests of mankind, and extending a security and bounty of existence unknown in former ages.

Apart from wars, which commerce directly tends to avert, but which often spring from Tariffs forces more powerful for the time than commercial interest, there remained little more by which a rapid extension of international trade could be impeded, save causes arising from ignorance or impolicy; and among these deserves chiefly to be noticed the prevailing practice of nations, in promoting their own several industries and trade, to wage a subtle war in times of peace on the industries and trade of each other. That foreign imports, and even domestic exports, should contribute some quota to the public revenue is in itself a reasonable proposition. The custom-house, which has to register goods coming in and going out, and to exercise an official regulation in the ports, should defray at the least its own expense, like any other necessary mercantile function. The convenience of raising public revenue by duties on imports and exports is amply evinced by the universal adoption of this expedient; and the convenience will always be materially modified by the more or less crude or scientific form which the system of taxation has assumed, by the financial exigency of states, and by the degree in which other objects than those of revenue have been permitted to enter into the general policy. It has been argued with much plausibility that there are certain stages and conditions of some branches of industry, in which it is politic to protect them against unequal competition in their own markets with the more advanced arts and appliances of foreign countries, until they have by this means acquired ability to stand upon their own merits; and this being once admitted, the transition is easy to the general doctrine that, since every nation always finds that there are commodities which other nations can produce much better and cheaper than it can produce them for itself, it is wise and expedient to place the admission of nearly all foreign goods and produce under a custom duty protective of the native industry. The interest of the public revenue is here lost in another line of policy, because protective duties carry the consequence that several parts of a nation have to pay to several other parts more of their own means for what they need than they should have had to pay to

the foreigner, and under a system of this kind the sources of public revenue, so far from being increased, are certain of being impaired. On the other hand, there are imports so entirely of foreign origin, and so free from considerations of competition with domestic industry, that a large revenue may be raised upon them in the custom-house, without disturbing the freedom or equity of international trade. The immense customs revenue of the United Kingdom from duties on tea, coffee, and tobacco (duties on wines and foreign spirits may be excluded since they are set off by excise duties on native liquors) is a remarkable example of the power of levying public revenue in the ports without infringing any commercial or economic principle. The question of tariffs thus appears to be capable of reasonable solution as long as it is kept within the circle of what is permanently expedient to the public revenue. When it passes beyond these bounds it launches into a sea of complicated errors. The idea or self-interest that has force to discourage the imports of foreign commodities by protective duties passes naturally onward to bounties on the export of some favored articles of domestic produce, under which the same practical result is conversely produced, and one part of the nation has to pay in taxes to the state some proportion of the price necessary to effect a sale abroad of the produce of another part of the nation. When bounties are given they have to be accompanied with a series of compensations or "drawbacks," and the confusion has often become so great, as when the export bounty is on the manufactured article and the protective duty on the imported raw material, or as, say, when there is a duty on foreign wool, and woollen goods on export are entitled to a drawback, that the state has been reduced to a dilemma, and anything it did seem only to make the condition worse. This medley of cross-purposes is increased by the means adopted by parent states on one hand to bolster, on another to monopolize to themselves, the trade of their colonies, and by the elaborate rules of preference and exclusion by which maritime nations have attempted to favor their own ships in the carrying trade of the seas.

All the mischief of the protective and prohibitory system was exhibited by the Orders in Council of the British Government, and the Berlin and Milan decrees of Bonaparte, fulminated in the passion and fury of war; and if these high acts of power were seen to be not only futile and sublimely ridiculous, but in their aim and effects destructive of all commercial civilization, it would argue little reason on the part of nations to carry out the same objects through the more calm, systematic, and insidious operation of mutually hostile tariffs. Though nothing dies more slowly than the spirit of monopoly in trade, yet from many signs it may be hoped that this obstacle to commerce will gradually disappear like others.

The present century has witnessed an extension of the commercial relations of mankind of which there is no parallel in previous history. The facts are so well known that it is unnecessary to reproduce them in any detail; and yet it may be useful to indicate, however lightly, the principal phenomena. The heavy debts and taxes, and the currency complications in which the close of the Napoleonic wars left the European nations, as well as the fall of prices which was the necessary effect of the sudden closure of a vast war expenditure and absorption of labor, had a crippling effect for many years on trading energies. Yet even under such circumstances commerce is usually found, on its well-established modern basis, to make steady progress from one series of years to another. The powers of production had been greatly increased by a brilliant development of mechanical arts and inventions. The United States had grown into a commercial nation of the first rank. The European colonies and settlements were being extended, and assiduously cultivated, and were opening larger and more varied markets for manufactures. In 1819 the first steamboat crossed the Atlantic, from Savannah, Ga., to Russia *via* England, and a similar adventure was accomplished from England to India in 1825—events in themselves the harbingers of a new era in trade. There began also to be signs, in the general prominence given to the study of economic principles, and in the policy of Mr. Huskisson in England, of a growing public opinion in favor of greater freedom of trade; and China, after many efforts, was opened under treaty to an intercourse with foreign nations which was

soon to attain surprising dimensions. These various causes supported the activity of commerce in the first four decades; but the great movement which has made the century so remarkable was chiefly disclosed in practical results from about 1840.

It has been seen above what the amount of the foreign trade of Great Britain was in the first year of the century. In 1839 the total value of British produce and manufactures exported, then including under the Legislative Union of the Kingdoms Irish produce and manufactures, was £53,233,580; and the total value of imports was £62,048,000, of which £12,796,000 was exported to other countries. The number of vessels belonging to the British empire in 1839, while the navigation laws were still in force, was 27,745, of an aggregate tonnage of 3,068,433, and 191,283 men. In 1850 the exports of home produce and manufactures had increased to £71,368,000, and the imports to £100,469,000, of which £21,874,000, was exported. In 1873, which may be taken as the close of the period under review, the declared value of exports of British and Irish produce and manufactures reached the enormous total of £255,073,336, and the imports the still more astonishing total of £370,380,742. In the returns for 1873 the exports of foreign and colonial merchandise are given only in quantities, but in the two succeeding years the value of this branch of export trade is given as £10,251,220 in 1874, when the total imports were £370,054,834, and £12,103,732 in 1875, when the total imports were £373,941,125—much less than in 1800, when the official value of re-exports is given as £18,847,735, on a total import of only £30,570,004, indicating, on the one hand, how greatly direct import from the countries of origin to the countries of use must have increased during the century, and, on the other hand, in how much larger proportion our imports of foreign and colonial merchandise had been entered for home consumption. The shipping in 1873, not of the British empire as in 1839, but of the United Kingdom alone, had increased, under repeal of the navigation laws, to 21,581 vessels, 5,748,097 tons, and 202,239 men.

The total value of British and Irish exports in 1873, as compared with 1839, shows an increase of 379 per cent., and of imports an increase of 496 per cent.—an expansion of trade within the third of a century wholly without example. In the years from 1800 to 1839 the increase of domestic exports had been only 119 per cent., and of imports 102 per cent. A larger progressive increase of imports than of exports has been a feature of British commerce for the last twenty years, and would seem to bear out the opinion of economists that this is the result of all prosperous foreign trade, though an excess of imports over exports so large as £120,000,000 per annum cannot possibly be due to the cause which they have usually assigned for it, *viz.*, the profit accruing from the exchange of goods less valuable for goods more valuable in the respective countries, and is probably only accounted for by the large investments of British capital of late years abroad, the interest of which has for the most part to be paid in merchandise.<sup>1</sup>

<sup>1</sup> The difference between *official* and *real* value in the returns, over the periods here referred to, vitiates in some measure the figures, not only as regards the old and discarded criterion of "the balance of trade," but as a means of exact comparison of one period with another; while, at the same time, they hold valid enough as regards the relative value of the several branches of import and export trade. Official valuation, the rates of which were fixed as far back as 1696, was long applied both to imports and exports, till at the close of last century the real or declared value of domestic exports began to be given along with the official value, and the discrepancy of the two—the official value increasing, and the real value declining in proportion to the quantities—gave rise to an opinion that we were always selling more of the products of our industry for less value in exchange, whereas it was the result of the cheapening of production by machines and steam-power, and anything but a proof either of industrial or mercantile loss. The official valuation of imports was much longer adhered to than in the case of exports, till of late years the practice has been to give the real or declared value in both branches of the commerce. It must be admitted, however, to Mr. McCulloch and other authorities, that these returns of value, however near the mark, can never show a balance of trade in the sense once supposed. The value given in the ports cannot exactly correspond with the value realized, since the whole system of trade proceeds on the fact that certain goods and produce are of more value in one country than in another. It was remarked as long ago as 1800 that the export of coffee was much over-valued in the official returns, and if coffee, one would say tea, and most other foreign and colonial produce; but the import of these articles having been valued on the same official scale, this could not affect the proportion either in quantity or value between the re-export and the total import of foreign and colonial merchandise. What is shown by the above figures to have been this proportion then, and what has occurred since so greatly to change the relation of imports and exports, is consistent with what might be



An increase of the foreign trade of the United Kingdom from £115,231,580 to £625,454,078, in the course of thirty-four years, presents a vaster theme than can be easily grasped and it may be enough here simply to supply some concise information—(1) as to the commodities which entered into so large a commerce, and (2) as to the distribution of the movement in the various quarters of the world. In the *Parliamentary Account of Revenue, Population, and Commerce for 1839*, a summary is given of the principal articles of British and Irish export, and their respective values; and by placing these in juxtaposition with the same articles of export from the Board of Trade returns for 1873, as in the following table, a pretty comprehensive view may be obtained of the impulse given to our various manufacturing industries:—

	1839.	1873.
Apparel and Haberdashery	£1,332,427	£10,032,483
Brass and Copper Manufactures	1,280,506	3,820,508
Coal	542,609	1,207,411
Cotton Manufactures	16,378,445	13,205,618
" Twist and Yarn	6,858,193	61,447,357
Earthenware	771,173	15,876,363
Glass	357,315	2,063,633
Hardware and Cutlery	1,828,521	1,344,694
Iron and Steel, Wrought and Unwrought	2,719,824	4,938,182
Iron Manufactures	3,292,220	37,779,586
" Yarn	618,485	7,295,121
" Yarn		1,975,738
Jute Manufacture		1,591,581
" Yarn		206,525
Machinery and Mill Work	286,482	9,994,169
Silk Manufactures	868,118	1,876,313
" Thrown, Twist, and Yarn		1,567,837
Woolen Manufactures—		
By Piece	5,800,869	26,279,235
By Yarn	620,247	
Woolen and Worsted Yarn	423,320	5,403,983

These figures speak largely for themselves. The British export of cotton manufactures in 1839 was so great as to cast into the shade every other export, and, though its increase since that period has been wonderful, yet it is gratifying to observe, in the progress of other branches, the greater breadth and variety which the manufacturing industry of the United Kingdom has assumed. The export of cotton goods and yarns in 1839 was nearly a half of our whole export of produce and manufactures. In 1873 they were less than a third. Indeed, if coal and iron, and iron and steel manufactures be put together, they will be found much to exceed in export value the cotton industry, though it must be added that to the extension of the latter there are yet no apparent limits. Many articles of export, which in 1839 were too inconsiderable to be included in a summary of principal articles, and not a few which had not then appeared in the export list, have since risen to a value much exceeding that of some principal articles in 1839; as for example, in 1873 alkali and chemical products, £4,676,861; beer and ale, £2,419,575; books, £912,534; herrings, £1,027,121; paper manufactures, £973,899; painters' colors and materials, £1,016,975; stationary other than paper, £672,970; telegraphic wire and apparatus, £2,359,563; and iron, steam, and sailing ships, made to foreign order, of which there is no record in the Board of Trade returns whatever. The imports of the United Kingdom in 1873, besides many new commodities of great aggregate value, such as esparto, guano, gutta-percha, hops, jute, oil-seed and oil-seed cakes, petroleum, pyrites, and various chemical substances, present a general increase over the whole range of foreign and colonial merchandise, most marked in raw materials and provisions, of which the chiefly notable example, since they may fitly be embraced in the same category, includes wheat, corn, flour, rice, cattle, sheep, pigs, bacon, butter, predicated on grounds of general reason. It was certain that when Britain was supporting a great war on the Continent, and paying heavy subsidies to European Governments, she should have to send large quantities both of her own produce and her foreign and colonial imports to the countries where she was spending her capital so freely and continuously. It was equally certain that, when this burden was thrown off, when her great debt had been consolidated, and its interest was being paid out of her own resources, and a surplus capital was once more developed, she would use her foreign and colonial merchandise more largely in her own arts, manufactures, and consumption, and that in any lengthened course of such prosperity her imports would begin to exceed her exports instead of the reverse. The excess of British imports over exports, including exports of foreign and colonial merchandise, began to appear in the Board of Trade returns about 1850; and this is coincident with the period within which we have to date an increasing investment of British capital in foreign and colonial securities.

cheese, eggs, poultry, potatoes, all manner of farm and dairy produce, the import value of which in 1873 is found to have amounted to £85,036,365.

This, however marvellous, is indeed but the commerce of our kingdom, but it contains the main current of the commerce of the whole world, and is consequently an example, though a strong and concentrated example, of what has been passing in other mercantile communities. The exports of all nations have not been computed at more than £800,000,000 to £850,000,000. Deducting from the larger sum the British and Irish exports, it follows that more than two-thirds of the exports of all other parts of the world are imported into the United Kingdom. Any permanent increase of trade in so large a centre is impossible without an increase throughout the general sphere, though this increase may be variously distributed. The following statistical results of Professor Levi exhibit in the briefest form where the chief movement has been in the remarkable epoch under consideration, so far as it can be seen through the trade of the United Kingdom:<sup>1</sup>

*Relation of Whole Trade of United Kingdom.*

	1840.	1870.
With Europe	41	40 per cent.
" Asia	13	18
" Africa	5	8
" America	37	29
" Australia	4	5

*Decennial Increase of Trade.*

	1840-50.	1850-60.	1860-70.
Europe	24	64	63
Asia	45	156	34
Africa	61	144	84
Australia	26	274	1
All countries	39	90	46

It is always critical to assign specific causes for commercial results on so vast a scale and over so wide a theatre, for in such cases there must not only have been a long antecedent preparation of means to enable such rapid and gigantic efforts to be made, but it is certain that many economic causes will be found to have been in concurrent operation, effects themselves becoming causes in turn, and though in apparent conflict, one checking the excess of the other, yet in reality extending and sustaining the general impulse. But three grand characteristics of the period have been adduced with almost common consent as affording an explanation of the phenomena—(1) the adoption of free trade by Great Britain, (2) the Californian and Australian gold discoveries, and (3) steam navigation, railways, telegraphs;—and these may obviously be accepted as the most powerful forces ever brought to bear on the extension of trade in any one age.

The measures by which Sir Robert Peel introduced this great change in the policy of the United Kingdom were marked by four general objects, merging by practical sequence in the absolute principle of freedom of trade—1st, to remove from the tariff all prohibitions of foreign import, among the chief of which were agricultural live stock, while retaining for a limited period some protective regulation; 2d, to place hundreds of articles of the nature of raw materials of manufacture, and others of less importance, yet useful in the arts, on a footing of entire freedom from customs duty; 3d, to reduce the duties on foreign manufactures which came into competition with home manufactures; and 4th, to repeal the corn laws, admitting foreign grain on a nominal fixed duty, which last involved an equally complete relief to provisions, live stock, agricultural produce of every kind, and to foreign manufactures. When the landlords and farmers were placed in full and direct competition with the world, no class of manufacturers had any excuse left for the slightest shred of protection. All these measures had the appearance more of liberal concessions to foreign nations than of any advantage to home producers; and this is, no doubt, the reason why free trade was so long resisted, and many were unable to see, until the problem was visibly demonstrated, that in liberating commerce, even in developing foreign resources, the most powerful impulse may be given to all the springs of domestic prosperity. The immediate effects in increasing the public revenue—even the customs revenue, which seemed endangered by the abolition of so many duties—in reviving

<sup>1</sup> *History of British Commerce*, by Leone Levi.

British trade and manufactures, and imparting new life to agriculture itself, were so great that the free trade policy was speedily carried up to its highest points of triumph. The differential duties on foreign and colonial, slave and free labor sugar were removed, and the navigation laws, in favor of which the greatest prejudice had long existed, were fully conformed to the new policy. The expected influence of so successful an illustration of free trade on other nations has not yet been realized to any considerable extent. A more liberal system of trade with France and other European countries has only been effected by treaty, which, however mutually advantageous in its results, is in its temporary and provisional character more or less unsatisfactory. It was not enough that Great Britain could say to her neighbors that free trade had worked well not only for herself but for them. There was always the ready retort of the protected interests in the respective countries that what was good for England in her somewhat exceptional condition might not be good, or might even be impossible, for them; and here the controversy has rested. But it must be allowed to argue a vast deal for the power of free trade that Great Britain in the face of so many unreciprocal tariffs, has been able to open an effective market in her ports for amounts of foreign goods and produce which thirty years ago would have been deemed fabulous, while at the same time circulating her own commodities in such increasing quantities to all parts of the world. There can be little question that the free commercial policy of this country has been one of the leading springs of the late marvellous extension of international trade.

The effect of the Californian and Australian gold mines has been compared to that of the silver mines of South America at two periods—when their treasures began to be distributed in Europe, and again when the abundance and cheapness of quicksilver increased their productiveness;—but there is one difference at least, viz., that under the greatly more active life of the present age, as compared with the 16th and 17th centuries, the results of the Californian and Australian gold discoveries were much more rapidly developed than in the other case, and may be said to have passed and been exhausted under the eyes of a single generation. We should thus be better able to judge the effect of sudden, though, as they prove, always temporary, increases of the supplies of the precious metals.

The two events in question were almost coincident, and they came when a general extension of trade had already been ten years in progress. The first effect was to produce a great emigration to the countries in which the gold-fields were situated, and this was followed by large exports of goods to the same quarters, which, as usually happens when business falls under speculative impulses out of the ordinary mercantile course, were much overdone, and ended eventually in heavy loss to the shippers. Abundance of labor had been supplied to the gold-fields with unwonted celerity, and as the labor was not unremunerative, and in many cases was even rewarded by large findings of gold, the commotion in emigration, traffic, and shipping was sustained for a considerable time. The coffers of the banks of England and France were soon filled with the new supplies of gold, and these imparted increased confidence to banking operations by which they were as soon redistributed. All this was calculated to give additional impulse and extension to the commercial forces already in motion. There was a new increase of demand for goods; much labor had been transferred from old seats of industry to new fields; and there was rise of wages, and rise of prices. But whether the effects would have been different whatever other produce than gold had been the impelling cause may be much doubted. The effect of increased supplies of the precious metals *per se* on prices is difficult to trace, and is seldom detected by the keenest analysis, more especially in a period of extending trade and industry, for the precious metals are then more quickly absorbed, and many causes, of which their increased supply is but one, and the least, are operating on the value of goods. The Californian and Australian mines remain productive, though in much diminished amount, and their most permanent effect on commerce will probably be found to be that they helped materially to build California into a populous State, which has become one of the largest granaries of wheat in the world, and to make the Australian colonies

a growing empire, of such varied resources that its foreign trade, greatly as it had increased in the first ten years of the gold discoveries, continued to increase in the subsequent ten years, when its produce of gold had declined into a subordinate interest.

Immensely important as the creative and stimulating effect of the free trade of Britain and the Californian and Australian gold discoveries had been, they pale before a mighty service that remains to be noticed, and which, in the prolific force of a world aroused to commerce, they had all the while been carrying forward in their train.

There is little need of remark in this place on steamships, railways, and telegraphs—equally marvellous in their power of facilitating commerce and in the rapidity of their construction to this end—beyond a simple indication. The words alone convey what an age we have been living in, and what the international progress in commerce must have been. In 1839 the ocean steamers in the world, if any, could have been counted on one's fingers. In the United Kingdom alone there are now 1597 steam vessels, of nearly 1000 average tonnage, wholly employed in foreign trade. All the greater maritime states have lines of ocean steamers, and there is scarce any part of the world to which goods and passengers are not carried with the speed, regularity, and capacity which steam-power has given to navigation. That goods might be hauled overland by steam was only deemed possible when George Stephenson opened the first short railway in England in 1825. There are now 17,000 miles of railway in the United Kingdom, or one mile of steam-road to every seven square miles of area, carrying both goods and passengers with the ease and celerity of this new system. A similar work has been done in other civilized nations, and over many thousands of miles of comparatively desert tracts of country. The only densely-peopled quarter of the world unknown to railway enterprise is China, and in China a short railway has just been opened from Shanghai to Woosung, amid the curiosity and welcome of the populace. The rapid development of telegraphy is more wonderful even than that of steamships or railways. Difficult problems of pure science, of science applied to art, and of material manufacture, had to be solved and tested at every step, and all this had to be done with the slightest attractions to capital on the stock exchange. Yet the telegraph wires have been laid successfully under the Atlantic, the Pacific, and the Eastern Seas, and there remain now but few parts of the commercial world to which messages may not be sent and answers received within a few hours. These wondrous and wondrously combined powers of science and mechanism have realized, in the highest form conceivable to the practical mind, the facility of transport and the means of rapid communication and intelligence which commerce had been seeking at infinite distance from the beginning of time, but seeking in vain. Their influence on the interior economy of commonwealths has been no less marked than on the exterior distribution of their products. They are the work of less than half a century, and yet to form them has cost tens of thousands of millions sterling of capital. On whatever side the question is considered, nothing less than marvels are presented to our reason. For, supposing these achievements possible, the science, art, and labor prepared and ready, where was the wealth to be found to accomplish them? It may be said that steamships, railways, and telegraphs have been called into existence by the rising energy and resources of commerce, and it may also be said that at every stage they have created the traffic by which alone they could be sustained and extended.

The international lending of capital has attained such magnitude, and is so often lost sight of in the study of more visible imports and exports, as to require careful consideration, not only on the part of the immediate lenders and borrowers, but of all who are engaged in foreign trade.<sup>1</sup> Capital in its monetary form of transfer, is as much a commodity as the more usual articles of trade; and when a country lends large sums to another country, the same effects are produced on the rates of exchange for the time being, and

<sup>1</sup> The amount of foreign loans and securities, of a public character, held in the United Kingdom has been variously estimated at from 1000 to 1500 millions sterling.

more protractedly on the general course of import and export, as would be produced by an equivalent amount of goods exported by the borrowing country. The imports of the borrower, during the period of expenditure of the loans, will increase; and the exports, though they may not diminish, will lose in some measure their previous proportion to the imports. These are consequences worthy of observation in the general conduct of mercantile business, but they also go farther. The free lending of money from country to country, with its incidents of higher rates of interest, and a certain degree of speculative adventure, is legitimate. By this means the richer parts of the world help to develop the poorer, as well as to increase their own prosperity; and when the debts thus contracted become valid and transferable securities, they are an important element in equalizing exchange where temporarily disturbed. But the extreme looseness with which this branch of commerce is conducted almost exceeds belief. The proceedings of the recent Committee on Foreign Loans have thrown some light on the subject. As long as bankers and financiers of repute put loans on the market without care as to their objects or security, or an exercise of the least mercantile judgment as to the probable effect of the loans on the value of requisite materials, and with the view simply of making some large immediate profit to themselves, and dropping the whole charge and risks, often by deceptive means, into the hands of a helpless public of investors, the most deplorable consequences must ensue. It is scarcely an exaggeration to say that in the years 1869-72 the foreign railway and other undertakings thus launched were such as there were not materials in the markets of the whole world to carry through, without an enhancement of values that should not only render the undertakings themselves hopeless, but seriously cripple much well-established trade. In the more solid class of foreign loans, bearing the security of not unprosperous states, it has frequently happened that nearly the whole revenue of the state was derived from customs duties. While the borrowing proceeded, the imports of the state increased, and the revenue flourished, giving a guarantee to the creditors. When the loan had been expended, and the return interest and redemptions had to be paid, the imports suddenly declined, and the revenue security on which the money had been lent disappeared, throwing the states themselves into much commercial embarrassment, in some cases into political convulsions. This subject cannot here be further pursued, but its bearings on trade are sufficiently apparent.

It may be said, in conclusion, that commerce has acquired a security and extension, in all its most essential conditions, of which it was void in any previous age. It can hardly ever again exhibit that wandering course from route to route, and from one solitary centre to another, which is so characteristic of its ancient history, because it is established in every quarter of the globe, and all the seas and ways are open to it on terms fair and equal to every nation. Wherever there is population, industry, resource, art, and skill, there will be international trade. Commerce will have many centres, and one may relatively rise or relatively fall; but such decay and ruin as have smitten many once proud seats of wealth into dust cannot again occur without such cataclysms of war, violence, and disorder as the growing civilization and reason of mankind and the power of law, right, and common interest forbid us to anticipate. But, with all these advantages, it must not be supposed that the future course of trade is free of difficulty. The very magnitude of commerce now suggests what serious work devolves on all who are engaged in it. If in the older times it was thought that a foreign merchant require to be not only a good man of business, but even a statesman, it is evident that all the higher faculties of the mercantile profession must still more be called into request when imports and exports are reckoned by hundreds instead of fives or tens of millions, when the markets are so much larger and more numerous, the competition so much more keen and varied, the problems to be solved in every course of transaction so much more complex, the whole range of affairs to be overseen so immensely widened. It is not a company of merchants, having a monopoly, and doing whatever they please, whether right or wrong, that now hold the commerce of the world in their hands, but large communities of free merchants in all parts of the world, affiliated to manufactures and producers equally free, each under strong tempta-

tion to do what may be wrong in the pursuit of his own interest, and the only security of doing right being to follow steady lights of information and economic science common to all. The triumphs of commerce and its auxiliaries have been exhibited in the present article. Easy transport of goods by land and sea, prompt intelligence from every point of the compass, general prevalence of mercantile law and safety, have all been accomplished; and the world is opened to trade. But intellectual grasp of principles and details, and the moral integrity which is the root of all commercial success, have to be severely tested in this vaster sphere. (R. 80.)

COMMERCE, a town of France in the department of Meuse, at the head of an arrondissement, on the left bank of the Meuse, twenty miles east of Bar-le-Duc. It possesses a castle built in 1708 and now used as cavalry barracks, a Benedictine convent occupied by the prefecture, a hospital rebuilt in the 18th century, and a cloth-market. Its public walks are very fine, and lead out in various directions to pleasant suburban villages. The industrial establishments include foundries, lime-kilns, and a cotton factory; and the trade runs mainly on cattle, grain, wood, and basket-work. Population, 4191.

Commercy dates back to the 9th century, and at that time its lords were dependent on the bishop of Metz. In 1544 it was besieged by Charles V. in person. For some time the lordship was in the hands of Cardinal de Retz, who lived in the town for a number of years, and there composed his memoirs. From him it was purchased by Charles IV., duke of Lorraine, who bestowed it on his daughter Anne on her marriage with the prince of Ile-Bonne. In the beginning of the 18th century it formed a principality under the prince of Vaudemont; and in 1744 it became the residence of Stanislas, king of Poland, who spent a great deal of care on the embellishment of the town and neighborhood. A description of his improvements is given in the *Journal des Savants* for 1752.

COMMODOUS, LUCIUS AURELIUS (161-192), emperor of Rome from 180 to 192, was born at Lanuvium in 161, and was the son of the philosopher-emperor M. Aurelius, and of the younger Faustina. His teachers were carefully selected; but all the pains bestowed on his education did not prevent him from choosing the society and the pursuits of profligate favorites and common gladiators. Blind to his faults, however, his father gave him the title of emperor when not more than fifteen years of age; and at sixteen he shared the imperial power in every department except the chief pontificate. On the death of Aurelius, whom he had accompanied in the war against the Germans, Commodus hastily concluded peace, and hurried back to the pleasures of the capital (180). From the first he gave himself up to unbounded license; but for some years his vices were all private. In 183, however, he was attacked, at the instigation of his sister Lucilla, by an assassin, who declared that he struck in the name of the senate; and the nobility paid the penalty by the murder of any of that rank who afterwards aroused the slightest suspicion in the mind of the emperor. At the same time the vulgar vanity of Commodus manifested itself in a manner that exposed him to the scorn of the meanest citizen. No longer content with showing his strength and dexterity to a little group of favorites in the palace, he presented himself as a spectacle in the arena, and, carefully protected from serious danger, displayed his skill by shooting hundreds of wild animals, and by meeting in fight hundreds of gladiators. He called himself the Roman Hercules, and commanded that he should be worshipped as such. Plots against his life naturally began to spring up. That of his favorite Perennis was discovered in time. The next danger was from the people, who were infuriated by the death of corn. The mob repelled the prætorian guard, but the execution of the hated minister, Cleander, quieted the tumult. The attempt also of the daring highwayman Maternus to seize the empire was betrayed; but at last Eclectus the emperor's chamberlain, Lætus the prefect of the prætorians and his mistress Marcia, finding their names on the list of those doomed to death, united to destroy him. He was poisoned, and then strangled by a wrestler named Narcissus, on the 31st December, 192, in the thirty-second year of his age. It was said that he had intended to disgrace the office of consul by taking the auspices at the commencement of a new year of office, not in the consular robe but in the garb of a secutor, and surrounded not by the senate but by a band of gladiators. His guards alone, accustomed

to his lavish bounty, regretted his death; and Pertinax, being chosen by the conspirators, was allowed quietly to succeed him.

COMMON LAW, like civil law, is a phrase with many shades of meaning, and it is probably safest to define it with reference to the various things to which it is opposed. It is contrasted with statute law, as law not promulgated by the sovereign body; with equity, as the law prevailing between man and man, unless when the Court of Chancery assumes jurisdiction; and with local or customary law, as the general law for the whole realm, tolerating variations in certain districts and under certain conditions. It is also sometimes contrasted with civil, or canon, or international law, which are foreign systems recognized in certain special courts only and within limits defined by the common law. As against all these contrasted kinds of law, it may be described broadly as the universal law of the realm, which applies wherever they have not been introduced, and which is supposed to have a principle for every possible case. Occasionally, it would appear to be used in a sense which would exclude the law developed by at all events the more recent decisions of the courts.

Blackstone divides the civil law of England into *lex scripta*, or statute law, and *lex non scripta*, or common law. The latter, he says, consists of (1) general customs, which are the common law strictly so called, (2) particular customs prevailing in certain districts, and (3) laws used in particular courts. The first is the law by which "proceedings and determinations in the king's ordinary courts of justice are guided and directed." That the eldest son alone is heir to his ancestor, that a deed is of no validity unless sealed and delivered, that wills shall be construed more favorably and deeds more strictly, are examples of common law doctrines, "not set down in any written statute or ordinance, but depending on immemorial usage for their support." The validity of these usages is to be determined by the judges—"the depositaries of the law, the living oracles who must decide in all cases of doubt, and who are bound by an oath to decide according to the law of the land." Their judgments are preserved as records, and "it is an established rule to abide by former precedents where the same points come again in litigation." The extraordinary deference paid to precedents is the source of the most striking peculiarities of the English common law. There can be little doubt that it was the rigid adherence of the common law courts to established precedent which caused the rise of an independent tribunal administering justice on more equitable principles—the tribunal of the chancellor, the Court of Chancery. And the common law courts—the Queen's Bench, Common Pleas, and Exchequer—have always, as compared with the Court of Chancery, been distinguished for a certain narrowness and technicality of reasoning. At the same time the common law has never been a fixed or rigid system. In the application of old precedents to the changing circumstances of society, and in the development of new principles to meet new cases, the common law courts have displayed an immense amount of subtlety and ingenuity and a great deal of sound sense. The continuity of the system is not less remarkable than its elasticity. Two great defects of form disfigure the English law. The first is the separation of common law and equity. The second is the overwhelming mass of precedents in which the law is embedded. The recent Judicature Act is an attempt to remedy the first by merging the jurisdiction of all the courts in one supreme court, and causing equitable principles to prevail over those of the common law where they differ. The second can only be removed by some well-conceived scheme of the nature of a code or digest (see CODE). The English common law may be described as a pre-eminently national system. Based on Saxon customs, moulded by Norman lawyers, and jealous of foreign systems, it is, as Bacon says, as mixed as our language and as truly national.

COMMON PLEAS, COURT OF (*Communia Placita*), was one of the three common law courts at Westminster—the other two being the Queen's Bench and Exchequer. The jurisdiction of all three, together with that of the Court of Chancery, the Court of Probate and Matrimonial Causes, and the Court of Bankruptcy, is vested in the new High Court of Justice, established by the Judicature Act, 1873. One division of that court is called the Common Pleas division, and there all the business which before the Act was

"within the exclusive cognizance of the Court of Common Pleas" must still be transacted.

COMMON PRAYER. See LITURGY.

COMMONS. It is a well-known result of the application of the historical method to laws and institutions, that it has reversed many of our leading conceptions of the natural or original forms of property. That the primitive form of property in land was not severalty but commonality, that land was held not by individuals but by communities, and that individual ownership was slowly evolved out of common ownership, are propositions as nearly as possible the opposite of our *a priori* ideas on the subject. The existence of rights of common is one of the traces of the ancient system still remaining in our law, but its real significance was for a long time obscured by the feudal theories on which the law of real property is based.

There seems to be good reason to believe that among the English, as among other Teutonic nations, the system of land-holding by village communities prevailed. For an account of that system reference may be made to Sir H. Maine's lectures, or to the short essay by Professor Nasse, a translation of which has been published by the Cobden Club (*On the Agricultural Community of the Middle Ages*). It may be sufficient to state here the bare outlines of the system. The "mark," or territory occupied by the community, was divided into the following parts:—(1) The township, where were the houses held by heads of families in severalty; (2) The arable land, divided into several plots, but subject to regulations as to common cultivation—the most usual of which is the three-field system; the land was to be fallow every third year, and the whole community had rights of pasturage on the fallow portion, and on the stubble of the fields under crop at certain portions of the year between harvest and seed-time; (3) The meadow-land, which in like manner was common for a period after the hay harvest, and was afterwards fenced off in separate allotments for the new crop; (4) The common or waste land, not appropriated for cultivation, and over which the community had rights of pasturage, wood-cutting, &c. After the Conquest we find the mark superseded by the manor, and although it has long been the fashion to find the absolute beginning of the latter system in the Conquest, there seems to be good reason to believe that its leading elements—the ideas of lordship and tenure—had been developed among the Anglo-Saxons themselves (see Digby's *Introduction to the History of the Law of Real Property*). At all events, the manorial system became defined and fixed under the Norman lawyers, and remains still the legal basis of property in land. All land is regarded as being held of the king, and the king's tenants might have tenants of their own. The practice of sub-infeudation, as it was called, was stopped by the statute *Quid Emptores*, 1290, which enacted that, when a lord alienated a portion of his land, the alienee, instead of being tenant of the alienor, should take his place as tenant to the lord next above him. Since this statute, therefore, no new manors could be created. All lands were supposed to be traceable originally to a grant from the king. Out of the lands so granted to him, the lord would grant certain portions to free tenants on certain rents and services, and these are the freeholders of the manor. His own portion would be cultivated by *villains*, or *serfs*, attached to the soil, and these ultimately developed into the important class of copyholders. There remains the uncultivated and unappropriated land, over which the freeholders had certain rights of common supposed to be incident to their original grant. Within the manor were certain courts (Court Leet, Court Baron, Customary Court), the most important of which is the Court Baron, or assembly of the freeholders, partly judicial and partly administrative. It is regarded by the common law as the inseparable concomitant of a manor, so that if there be no Court Baron there is no manor. The historical investigations to which we have referred point to the identity of the Court Baron with the assembly of the village community. The lord's waste in like manner represents the common waste of the community not appropriated in severalty, and used by all in common for pasturage, &c. The legal theory, however, supposes that the whole organization is created by grant; the lord is the owner of the soil, and the rights of tenants are merely such as he has granted to them out of consideration for rents and services reserved. Whatever has not

been so granted belongs as a matter of course to the lord. The rights of common come to be regarded as of the nature of servitudes—*jura in alieno solo*—exceptional privileges granted over land by its real owner to his tenants.

Rights of common enjoyed by the freeholders of the manor as incident to their tenure are said to be *appendant*, or attached to their holdings. Rights of common not coeval with the original grant, or enjoyed by strangers in respect of land not belonging to the manor at all, are said to be *appurtenant*. Rights claimed irrespectively of land altogether are called rights of common *in gross*. Similar rights in copyholders depend on the *custom* of the manor.

The most important right of common is *Common of Pasture*, which if *appendant* can only be claimed for beasts used for tillage—such as horses, oxen, and sheep,—and in respect of arable land only (for manure); if *appurtenant*, it may extend to swine, goats, geese, &c., and is not confined to arable land; if *in gross*, it is subject to no restriction as to the species of beasts. The claim must be for some number limited and defined, and where no number is fixed, it is restricted to beasts *levant* and *couchant*—a phrase which, according to judicial interpretation, means such cattle as the winter estate of the tenement, together with the hay, &c., obtained from it in summer, could support. Some lands are subject to this common of pasture during certain portions of the year only—*e.g.*, in the case of lammas-lands from the 1st of August, for eight months after which they are held in severalty. This arrangement may be compared with what is said of the village community above. Such lands are said to be *commonable*.

*Common of Piscary* is a right of fishing in a particular stream.

*Common of Estovers* is the right of cutting wood on another's estate.

*Common of Turbary* is the right of cutting turfs, and must be claimed in respect of land on which a house has been built, as "turves are only wanted to burn in a house."

In some manors there is a right of digging and taking coals, minerals, &c. Subject to these rights, everything belongs to the lord of the manor, and a custom to exclude him from all manner of profit would be held void as being unreasonable.

In our earliest legislation on the subject of commons, the rights of the commoner appear to have a firmer footing than the theory which derives them from the grant of the lord would lead us to expect. The Statute of Merton (1235) gives relief to the lords whose efforts to improve their wastes have been frustrated by commoners bringing an assize of novel disseisin for their pasture, and the lord in such cases was to be held blameless if sufficient pasture, with ingress and egress, had been provided. It only applied, as we learn from the criticism of Bracton, to *common appendant*, and to cases where the right is expressly limited in number or kind. The statute of Westminster the second (1285) extended it to rights *appurtenant*. Under these statutes inclosures can be made on the following conditions only:—

1. It must be proved that sufficient pasturage has been left for the commoners.
2. If there is common of pasture in gross, inclosure cannot be made.
3. The statutes do not authorize inclosures which would infringe upon any other common rights, as turbary, piscary, &c.
4. They do not affect copyholders.

(See *Six Essays on the Preservation of Commons*.)

It will be observed that, in relation to the rights described, the lord and the commoners are the only parties recognized by the law. The public in general have no rights. It has been alleged, indeed, that the immemorial use of open spaces near large towns by the inhabitants for exercise and recreation raises the presumption of a dedication—a question we need not discuss here. It is chiefly, however, in connection with the needs of the public, especially of the inhabitants of large towns, that the law of commons is still a subject of some practical importance. Until quite recently the inclosure of commons was regarded as a matter affecting the lord alone, or at most the lord and the commoners. Of late, the interest of the public at large in preserving the commons uninclosed has been strenuously asserted, and as we shall see has been recognized in legislation.

At common law, in spite of the predominance given to the rights of the lord, there was no means of converting the common or any portion of it into the severalty of the lord, unless to a comparatively small extent, under the Statutes of Merton and Westminster the second. The increase of population and the growing need for food-producing land made it the interest of the lord, and it may be considered of the public also, that much of the common ground should be brought under cultivation. Down to the year 1800 this was effected by private Inclosure Acts, of which there were as many as 1600 or 1700. The provisions which it had been customary to insert in these special Acts were in 1801, after the manner of which we have so many examples, consolidated in Sir John Sinclair's Inclosure Act, 41 Geo. III. c. 109. At this time the inclosure and cultivation of common lands were looked forward to as a means of increasing the national wealth. It is not till 1836 that we find any recognition of the desirability, on public grounds, of preventing inclosures under certain circumstances, *viz.*, in the 6 and 7 Will. IV. c. 115, for facilitating the inclosure of open and arable fields (which applied to what have been called commonable lands and not to manorial wastes). The 55th section forbids inclosures within ten miles of London, or within corresponding distances of smaller towns. Subject to the provisions of these Acts about 2000 private Inclosure Acts had been passed, when in 1845 came the General Inclosure Act, 8 and 9 Vict. c. 148. Its object is stated to be to facilitate the inclosure and improvement of commons and other lands, now subject to rights of property, which obstruct cultivation and the productive employment of labor, &c. Commissioners are to be appointed who shall judge of the expedience of an inclosure and superintend its execution. All common lands are brought within the scope of the Act, but manorial wastes are not to be inclosed without the previous sanction of Parliament, which was also made necessary for inclosures within fifteen miles of London, or within two miles of any city of 10,000 inhabitants, or within two and half miles of any city of 20,000 inhabitants, and so on. (A later Act, 15 and 16 Vict. c. 79, made the consent of parliament necessary in all cases under this Act.) Village greens are not to be inclosed, and by § 30 the commissioners are authorized to require, as one of the conditions of the inclosure, the appropriation of an allotment for the exercise and recreation of the neighborhood on the following scale:—In a parish of 10,000 inhabitants not more than 10 acres; between 5000 and 10,000 inhabitants not more than 8 acres; between 2000 and 5000 not more than 5 acres; and under 2000 not more than 4. Allotments might also be made for the laboring poor. Under this Act inclosures proceeded apace, and the commissioners have been accused of unduly favoring inclosure, and neglecting the powers with which they were intrusted for the protection of the public. Alluding to this feeling the Home Secretary (Mr. Cross), in proposing the Bill which afterwards became the Act of 1876, stated that of 414,000 acres which had been inclosed under the Act less than 4000 had been dedicated to purposes of recreation and exercise, and he admitted that, whereas inclosures had formerly been treated as private estate improvement to which the owner was entitled, a great change of opinion had taken place as to the rights of the public. This feeling found expression in the Metropolitan Commons Act, 1866, which absolutely prohibits all further inclosure of metropolitan commons, and facilitates schemes for the management and improvement of such commons for the benefit of the public, due compensation being made for beneficial interests affected thereby. This, it will be observed, is a complete change of attitude. Whereas the lord was formerly treated as the real owner, and allowed to buy off partial interests, the public is now placed in that position, and the lord becomes an encumbrancer to be bought off like any other.

The revival of public interest in commons led to resistance being offered in courts of law to the unauthorized inclosure of commons by lords of the manor. One of the most important of these cases is that of *Warrick v. Queen's College, Oxford* (6 *Chancery Appeals*, 716), in which the plaintiff, as a freeholder of the manor of Plumstead, obtained a decree against the defendants, who had inclosed a portion of the common of the manor. The judgment of the Lord Chancellor (Hatherley) on that occasion contains a statement of the view now taken by the courts of claims to rights of common. In the *Commissioners of Sewers v. Le*

Glasse, the Corporation of London defeated attempted inclosures in Epping Forest.

In 1869, a committee of the House of Commons presented a report on metropolitan commons, and many of their recommendations have been embodied in the Inclosure Act, 1876, of which the following are the chief provisions. The preamble of the Commons Act, 1876, states that, under the Inclosure Acts, 1845 to 1868, the commissioners are empowered to authorize, by provisional orders subject to assent of Parliament, the inclosure of commons, provided the inclosure is made on such terms as may be necessary for the protection of public interests, and provided they are of opinion that such inclosure is expedient, having regard to the benefit of the neighborhood; and that it is desirable that circumstances bearing on the expediency of the proposed inclosure should be more fully brought under the notice of the commissioners, and that inclosure of commons in severalty should not be made unless the commissioners are satisfied that it would be of benefit to the neighborhood as well as to private interests, and that further effect ought to be given to the provisions relating to allotments for purposes of exercise and recreation. The commissioners may entertain applications either for (1) the regulation or (2) the inclosure of a common. The regulation includes the adjustment of rights and the improvement of a common; and the latter comprises (1) draining, manuring, and levelling the common, (2) planting trees or otherwise beautifying it, (3) making by-laws, (4) general management, and (5) appointment of conservators. In case of "inclosure," as well as "regulation," the commissioners may insert provisions for the benefit of the neighborhood, e.g., the securing free access to particular points of view, preserving trees or historical objects, reserving playing-grounds, making roads, &c. In the case of suburban commons (i.e. situated within six miles of any town) the sanitary authority shall be represented. The commissioners are directed to require evidence as to the benefit of the neighborhood, and, in the case of inclosure, information as to the advantages of inclosure as compared with regulation. Rules are provided for inspecting the common, holding meetings, &c. The provisional order shall contain all the statutory provisions for the benefit of the neighborhood that are applicable to the case, and, where the common to be inclosed is waste land of a manor, a description of the allotments for recreation-ground. Compensation must be provided for private interests affected by the order. Two-thirds of the persons whose interests are affected must assent to the order, and in the case of a manorial waste the lord must consent, or his representative in interest, before the commissioners can certify the expediency of the order. When the freemen of a town have interests in the common, the consent of two-thirds of them must be obtained. The Inclosure Acts are amended by certain sections relating to field-gardens and recreation-grounds. Encroachments on or inclosure of village-greens are to be deemed a public nuisance. Illegal inclosures on commons settled under this Act are within the jurisdiction of the county court. Persons intending to inclose a common otherwise than under this Act must give three months' notice of their intention by advertisement. The section of the Inclosure Act, 1845, which fixes a limit to allotments for recreation-grounds is repealed. The Act does not apply to metropolitan commons. (E. E.)

COMMONS, HOUSE OF. See PARLIAMENT.

COMMUNE, the smallest administrative division of France, corresponding in its main features to the municipal borough of England. Communes constitute legal corporations of elaborate organization, capable of holding property, contracting debts, and appearing as persons in court. The chief magistrate of a commune is the *maire*, who is assisted by one or more *adjoints*, and a deliberative assembly, called the *conseil municipal*, or municipal council. As an agent of the national Government, he is charged with the local promulgation and execution of the general laws and decrees of the country; and as a member of the municipality he has to attend to the police, the revenue, and the public works of the commune, and, in general, to act as representative of the corporation. In communes that either rank as the administrative centres of a department, *arrondissement*, or *canton*, or have a population of more than 3000, the *maire* is nominated by the central Government; in those which are not thus distinguished, the appointment lies with the *prefect* of the department. Suspension from office may be

inflicted by the *prefect*; but deposition can only proceed from the Government. An *adjoint* may be intrusted by the *maire* with the discharge of any of his functions; and as the *maire's* representative he may preside over the *conseil municipal* even if he be not otherwise a member of the body. The councillors are elected by the votes of the communal electors; and like the *maire* and the *adjoints*, they hold office for a term of five years. The decisions of the council in regard to the local budget and various other matters are subject to revision and amendment by the *prefect* of the department.

See Leber, *Hist. critique du pouvoir municipal*, 1823; Reynouard, *Hist. du droit municipal*, 1829; Dupin, *Hist. de l'administration locale*, 1829; Champagnac, *Du passé du présent, et de l'avenir de l'organ. munic. en France*, 1843; Gorges, *Organisation de la commune en France*, 1848.

COMMUNISM is the name that has been given to the schemes of social innovation which have for their starting-point the attempted overthrow of the institution of private property. It is not to be wondered at that so stupendous an undertaking should have failed, except in a very few instances, in its immediate object. The principle of private property has been called by one who was by no means a blind worshipper of the social condition which has been built upon it, "that primary and fundamental institution on which, unless in some exceptional and very limited cases, the economical arrangements of society have always rested." To attack this primary and fundamental institution indicates a mind so bold as well as so imaginative that it might well be thought that the assaults upon it would be few and far between, limited to a single country or to a single age, or at least to a class of individuals rendered desperate by having nothing to lose by a general social revolution. The opinion that a communist is a man who has no property to lose, and who therefore advocates a general redistribution of wealth, is very wide-spread and popular. It is embodied in the well-known lines of the corn-law rhymer:—

"What is a Communist? One who hath yearnings  
For equal division of unequal earnings.  
Idler or bungler, or both, he is willing  
To fork out his penny and pocket your shilling."

The facts connected with the history of communism show that the movements against the institution of private property have taken place in nearly every country, and in almost every age. They have originated with men of such divergent intellectual rank as Plato and Robert Owen, as widely sundered in respect of time, country, and social surroundings as the Essenes, Sir Thomas More, Saint Simon, and Father Rapp. The mere mention of these names goes some way towards the refutation of the popular conception of a communist as a needy adventurer seeking a means to possess himself of the property of others. There may have been some so-called communists attracted to the movement by the hope of being enabled to live on the labor and industry of their neighbors; but such men have never originated any socialistic movement, and their motives have generally been quickly detected by the genuine communists, who have not infrequently adopted very vigorous means to expel such black sheep from their flock. Among the modern leaders of communistic movements who have actually reduced to practice the theoretical schemes of *The Republic* and *Utopia* have been men who have devoted great wealth and rare organizing faculties to the carrying out of their plans for the reconstruction of society. It has been estimated that Robert Owen, during the course of his long life, devoted no less a sum than £60,000 from his own private fortune to the promotion of communistic schemes; what he sacrificed indirectly to his views on social reform cannot be easily estimated. His faculty for the successful conduct of business was so remarkable that at the early age of twenty-six, without a shilling of capital of his own, he was appointed manager of the mills of the Chorlton Company with a salary of £1000 a year, besides one-ninth of the profits realized by the company. There can be no doubt that Owen had the personal qualities which would have enabled him to amass a colossal fortune if his ambition had lain in that direction. The immense pecuniary and personal sacrifices which he made to the cause of communism show that he at least was animated by motives the direct opposite of the selfishness and sloth generally attributed to the advocates of that system. Another leading communist,

Prevalence  
of communistic  
views.

Saint Simon, was the representative of one of the most ancient families of the French nobility. A career in the army was open to him in which he might easily have satisfied the usual ambition of the class to which he belonged. As a young man he served with distinction through five campaigns.

Many other instances might be given of the disinterestedness of the leaders of communistic schemes. Among American associations one of the most successful as to the number and material prosperity of its members is the society known as the Perfectionists of Oneida and Wallingford. Their founder, John Humphrey Noyes, is the son of a banker, and a man fitted by education and natural gifts to have succeeded in any of the ordinary careers of professional or commercial activity. Whether we look at communism as depicted in the pages of Plato's *Republic* and Sir Thomas More's *Utopia*, or in the practical efforts made to realize these philosophical speculations by such men as Owen and Noyes, we find no justification for the assumption that the movement is one for enabling "idlers and bunglers" to live on the industry and talents of their more energetic and skilful neighbors.

As we are here saying what communism is not, rather than endeavoring to define what it is, this is perhaps the right place to state that communism, meaning thereby community of goods and the abolition of private property, has no connection with the doings of the *Commune* of Paris which was overthrown in May, 1871. The French word *Commune* is a household word in France for "Township" or "Corporation." Every town and village in France has its *Commune* or municipality. In nearly every town and village there is corporate property called *Les Biens Communaux*, and this property is vested in the corporation or *Commune*. The similarity, however, of the French word for corporation to ours for expressing the doctrine of community of goods has led to a great amount of misconception and confusion, even among writers who are generally careful and well informed. The revolution of the *Commune* was entirely political; it propounded no new economic theories. It arose from a joint effort of many sections of extreme politicians who were agreed in nothing but in demanding the establishment of (1) a democratic republic, and (2) the communal (or corporate) independence of Paris. Only about seven out of the seventy members of the Communal Government were communists in the economic sense, and those seven were among the most thoughtful and least violent of the party to which they belonged. They never had an opportunity of giving any official sanction to their communistic views, and they were gradually thrust on one side by their more violent and unscrupulous comrades. This is therefore not the place to attempt anything like an account of the brief reign of the *Commune*, which indeed belongs to the history of Paris. It is sufficient to state that its doings were not even tinged with communism in the economic sense of the word.

Communistic schemes have found advocates in almost every age and in many different countries. The foremost men both of thought and action have from time to time been attracted by them. They have been so various in scope, and the amount of detail with which they are described by their authors is so considerable, that it is difficult to get at the underlying principle which is common to them all. It must be remembered that the philosophic communism of Plato and More has been adapted to the wants of actual daily life by rough German peasants and Lancashire operatives; and though of course the actual has differed a good deal from the ideal commune, yet their resemblance is, under the circumstances, very much more striking than their divergence. The one thing that is shared by all communists, whether speculative or practical, is deep dissatisfaction with the economic conditions by which they are surrounded. In Plato's *Re-*

public. *Utopia*. public the dissatisfaction is not limited to merely economic conditions. In his examination of the body politic there is hardly any part which he can pronounce to be healthy. He would alter the life of the citizens of his state from the very moment of birth. Children are to be taken away from their parents and nurtured under the supervision of the state. The old nursery tales, "the blasphemous nonsense with which mothers fool the manhood out of their children," are to be suppressed. Dramatic and imitative poetry are not to be allowed. Education, marriage, the number of births, the occupations of the citizens are to be controlled by the guardians or heads

of the state. The most perfect equality of conditions and careers is to be preserved; the women are to have similar training with the men, no careers and no ambition are to be forbidden to them; the inequality and rivalries between rich and poor are to cease, because all will be provided for by the state. Other cities are divided against themselves. "Any ordinary city, however small, is in fact two cities, one the city of the poor, the other of the rich, at war with one another" (*Republic*, bk. iv. p. 249, Jowett's translation). But this ideal state is to be a perfect unit; although the citizens are divided into classes according to their capacity and ability, there is none of the exclusiveness of birth, and no inequality is to break the accord which binds all the citizens, both male and female, together into one harmonious whole. The marvellous comprehensiveness of the scheme for the government of this ideal state makes it belong as much to the modern as to the ancient world. Many of the social problems to which Plato draws attention are yet unsolved, and some are in process of solution in the direction indicated by him. He is not appalled by the immensity of the task which he has sketched out for himself and his followers. He admits that there are difficulties to be overcome, but he says in a sort of parenthesis, "Nothing great is easy." He refuses to be satisfied with half measures and patchwork reforms. "Enough, my friend! but what is enough while anything remains wanting?" These sentences indicate the spirit in which philosophical as distinguished from practical communists from the time of Plato till to-day have undertaken to reconstruct human society.

Sir Thomas More's *Utopia* has very many of the characteristics of *The Republic*. There is in it the same wonderful power of shaking off the prejudices of the place and time in which it was written. The government of Utopia is described as founded on popular election; community of goods prevailed, the magistrates distributed the instruments of production among the inhabitants, and the wealth resulting from their industry was shared by all. The use of money and all outward ostentation of wealth were forbidden. All meals were taken in common, and they were rendered attractive by the accompaniment of sweet strains of music, while the air was filled by the scent of the most delicate perfumes. More's ideal state differs in one important respect from Plato's. There was no community of wives in Utopia. The sacredness of the family relation and fidelity to the marriage contract were recognized by More as indispensable to the wellbeing of modern society. Plato, notwithstanding all the extraordinary originality with which he advocated the emancipation of women, was not able to free himself from the theory and practice of regarding the wife as part and parcel of the property of her husband. The fact, therefore, that he advocated community of property led him also to advocate community of wives. He speaks of "the possession and use of women and children," and proceeds to show how this possession and use must be regulated in his ideal state. Monogamy was to him mere exclusive possession on the part of one man of a piece of property which ought to be for the benefit of the public. The circumstance that he could not think of wives otherwise than as the property of their husbands only makes it the more remarkable that he claimed for women absolute equality of training and careers. The circumstance that communists have so frequently wrecked their projects by attacking marriage and advocating promiscuous intercourse between the sexes may probably be traced to the notion which regards a wife as being a mere item among the goods and chattels of her husband. It is not difficult to find evidence of the survival of this ancient habit of mind. "I will be master of what is mine own," says Petruccio. "She is my goods, my chattels."

The Perfectionists of Oneida, a well-known communistic society in the United States which has put into practice community of wives, or, as they call it, complex marriage, justify their extraordinary social system by affirming that there is "no intrinsic difference between property in persons and property in things; and that the same spirit which abolished exclusiveness in regard to money would abolish, if circumstances allowed full scope to it, exclusiveness in regard to women and children" (Nordhoff's *Communistic Societies of the United States*, pp. 271-2). It is this notion of a wife as property that is responsible for the wild opinions communists have often held in favor of a community

of wives and the break-up of family relations. If they could shake off this notion and take hold of the conception of marriage as a contract, there is no reason why their views on the community of property should lead them to think that this contract should not include mutual fidelity and remain in force during the life of the contracting parties. It was probably not this conception of the marriage relation so much as the influence of Christianity which led More to discountenance community of wives in Utopia. It is strange that the same influence did not make him include the absence of slavery as one of the characteristics of his ideal state. On the contrary, however, we find in Utopia the anomaly of slavery existing side by side with institutions which otherwise embody the most absolute personal, political, and religious freedom. The presence of slaves in Utopia is made use of to get rid of one of the practical difficulties of communism, viz., the performance of disagreeable work. In a society where one man is as good as another, and the means of subsistence are guaranteed to all alike, it is easy to imagine that it would be difficult to ensure the performance of the more laborious, dangerous, and offensive kinds of labor. In Utopia, therefore, we are expressly told that "all the uneasy and sordid services" are performed by slaves. The institution of slavery was also made supplementary to the criminal system of Utopia, as the slaves were for the most part men who had been convicted of crime; slavery for life was made a substitute for capital punishment.

In many respects, however, More's views on the labor question were vastly in advance of his own time, and indeed of ours. He repeats the indignant protest of the *Republic* that existing society is a warfare between rich and poor. "The rich," he says, "devise every means by which they may in the first place secure to themselves what they have amassed by wrong, and then take to their own use and profit, at the lowest possible price, the work and labor of the poor. And so soon as the rich decide on adopting these devices in the name of the public, then they become law." One might imagine these words had been quoted from the programme of the International Society, so completely is their tone in sympathy with the hardships of the poor in all ages. More shared to the full the keen sympathy with the hopeless misery of the poor which has been the strong motive power of nearly all speculative communism. The life of the poor as he saw it was so wretched that he said, "Even a beast's life seems enviable!" Besides community of goods and equality of conditions, More advocated other means of ameliorating the condition of the people. Although the hours of labor were limited to six a day there was no scarcity, for in Utopia every one worked; there was no idle class, no idle individual even. The importance of this from an economic point of view is insisted on by More in a passage remarkable for the importance which he attaches to the industrial condition of women. "And this you will easily apprehend," he says, "if you consider how great a part of all other nations is quite idle. First, women generally do little, who are the half of mankind." Translated into modern language his proposals comprise universal compulsory education, a reduction of the hours of labor to six a day, the most modern principles of sanitary reform, a complete revision of criminal legislation, and the most absolute religious toleration. The romantic form which Sir Thomas More gave to his dream of a new social order found many imitators. The *Utopia* may be regarded as a prototype of Campanella's *City of the Sun*, Harrington's *Oceana*, Bacon's *Nova Atlantis*, Defoe's *Essay of Projects*, Fénelon's *Voyage dans l'Isle des Plaisirs*, and other works of minor importance.

It is remarkable that all communists have made a great point of the importance of universal education. All ideal communes have been provided by their authors with a perfect machinery for securing the education of every child. One of the first things done in every attempt to carry communistic theories into practice has been to establish a good school and guarantee education to every child. The first impulse to national education in the present century probably sprang from the very marked success of Robert Owen's schools in connection with the cotton mills at New Lanark. At a time (1806) when popular education was in the lowest possible condition, Owen, as manager and part owner of the New Lanark Mills, proposed to his partners to spend

£5000 upon new schools. They not unnaturally objected to an expenditure at that time quite unprecedented; whereupon Owen bought his partners out for £84,000, and took his own course upon the educational system he had brought forward. It is to be observed that communists have seldom or never relied on their peculiar system alone for the regeneration of society. Community of goods has indeed been their central idea, but they have almost invariably supported it by other projects of less questionable utility. Compulsory education, free trade, and law reform, the various movements connected with the improvement of the condition of women, have found their earliest advocates among theoretical and practical communists. The communists denounce the evils of the present state of society; the hopeless poverty of the poor, side by side with the self-regarding luxury of the rich, seems to them to cry aloud to heaven for the creation of a new social organization. They proclaim the necessity of sweeping away the institution of private property, and insist that this great revolution, accompanied by universal education, free-trade, a perfect administration of justice, and a due limitation of the numbers of the community, would put an end to half the self-made distresses of humanity. Has it never occurred to them that a similarly happy result might be attained if all these subsidiary reforms were carried out, leaving the principles of private property and competition to their own predominance in the economic world? If the principles of communism and of private property are to be fairly compared, the comparison must not be between communism as it might be and private property as it is. Communism to be successful requires to be accompanied by important reforms, toward which existing society founded on private property is gradually finding its way. The power which society, as at present constituted, has shown of adapting itself to altered circumstances, and of assimilating by slow degrees the more valuable concomitants of the most revolutionary theories, is strong proof that it does not deserve to be dealt with in the summary manner advocated by the communists.

We find in many socialistic writings of thirty or forty years ago the assumption expressed or implied that, in society as it is, the most valuable and essential reforms are impracticable. Louis Blanc on existing institutions. M. Louis Blanc, for instance, in his book called *L'Organisation du Travail*, first published in 1839, says that in the existing order of society the spread of education among the masses would be dangerous,—would, in fact, be impossible. This, if true, would be the strongest possible indictment against the existing order of society. But how have events falsified the assumptions made in the following passage? "On a vu pourquoi, dans le système actuel, l'éducation des enfants du peuple était impossible. . . . Beaucoup d'esprits sérieux pensent qu'il serait dangereux aujourd'hui de répandre l'instruction dans les rangs du peuple, et ils ont raison. Mais comment ne s'aperçoivent-ils pas que ce danger de l'éducation est une preuve accablante de l'absurdité de notre ordre social? Dans cet ordre social, tout est faux: le travail n'y est pas en honneur; les professions les plus utiles y sont dédaignées; un laboureur y est tout au plus un objet de compassion, et on n'a pas assez de couronnes pour une danseuse. Voilà, voilà pourquoi l'éducation du peuple est un danger!" (p. 100). Hence, he concludes, a social revolution ought to be attempted; a new system of society ought to be introduced; the old system of society is, he says, so "full of iniquities" that it cannot co-exist with a diffusion of education among the people. Even at the time when these words were written there was much to show that they were not true. Since they were written the spread of education has been most general in those countries in which the old social order, founded on private property and competition, is unshaken. Germany, Scotland, and America have an educated people, and they are distinguished among other countries for possessing a peaceful, law-abiding, and order-loving population. So far from education being a danger to the institution of private property, nearly every one has been convinced by events that it is much more seriously threatened by ignorance and the helpless desperation ignorance brings; and the old order of society has recognized the necessity of protecting itself by the diffusion of education.

*L'Organisation du Travail* furnishes another example of the mistake communists often make in thinking it is necessary to turn the world

Opposition to banking



upside down in order to bring about some desirable economic change. M. Louis Blanc is describing the organization necessary for the establishment of his "ateliers nationaux," which became so famous nine years later when the eloquent author of *L'Organisation du Travail* was a member of the Government of 1848. He is speaking of the place occupied by the credit and banking system in the existing economical order of society. "Que doit être le crédit? Un moyen de fournir des instruments de travail au travailleur. Aujourd'hui, nous l'avons montré ailleurs" (in an article in the *Revue de Progrès* called "Question des Banques") "le crédit est tout autre chose. Les banques ne prêtent qu'au riche. Voulussent-elles prêter au pauvre, elles ne le pourraient pas sans courir aux abîmes. Les banques constituées au point de vue individuel ne sauraient donc jamais être, quoi qu'on fasse, qu'un procédé admirablement imaginé pour rendre les riches plus riches et les puissants plus puissants. Toujours le monopole sous le dehors de la liberté, toujours le monopole sous les apparences du progrès! *L'Organisation proposée*" (that of the national workshops) "couperait court à tant d'iniquités. Cette portion de bénéfices, spécialement et invariablement consacrée à l'agrandissement de l'atelier social par le recrutement des travailleurs, voilà le crédit. Maintenant, qu'avez vous besoin des banques? Supprimez-les" (pp. 97-8). This passage is a striking instance of the way in which communistic writers are inclined to treat social and economic problems. M. Louis Blanc observed that the banking system at the time in which he wrote was in some respects defective. From the nature of their business and the security they were obliged from motives of self-preservation to demand, the banks lent only to those who were able to give them that security, i. e., to the rich. Even this statement requires some modification unless in the expression "the rich" is included every struggling farmer or tradesman who is helped over a time of pecuniary difficulty by the credit afforded to him by his banker. The fact remains, however, that the banks did not give credit to the laboring classes. Credit, urges M. Louis Blanc, which ought to be a means of furnishing the instruments of production to the laborer, is in reality no such thing. What is the remedy which he suggests for this deficiency in the credit system? An entire reorganization of the industrial world, in which every laborer will be supplied by the state with the tools and raw materials which his work requires. If this proposed reorganization were adopted there would no longer be any scarcity of credit, and as for banks, he cries triumphantly, they would no longer be necessary; let them be put down.

It is not M. Louis Blanc only who observed that the ordinary banking system cannot, from want of security, afford to make advances to the laboring classes. Herr Schulze-Delitzsch noted the same fact, but the remedy which he suggested, and which has been carried out with such great success in Germany, is very different from the heroic treatment recommended in the passage we have quoted from M. Blanc. The Schulze-Delitzsch credit banks which began to be established in Germany in the year 1851 are associations of artisans formed for the purpose of enabling the members to obtain by means of credit the capital necessary to production. These associations are entirely self-supporting; they have supplanted nothing, they have uprooted nothing. Their success, so far from weakening the ordinary banking system, has strengthened it by supplying one of its deficiencies. The individual workman cannot obtain an advance of capital upon credit because he cannot give adequate security that it will be repaid. But the credit banks are associations of workmen who are jointly and severally responsible for the repayment of loans made to any one of their number. A member of one of these associations can through its means obtain a loan on favorable terms, because the principle of the unlimited liability of each of the members for the repayment of a loan made to any one of them affords the means of offering to the lender most ample and sufficient security. The fact that the principle of unlimited liability is strictly maintained is really the essential characteristic of the security which the association is able to give to those who advance capital to it. If this principle were relaxed it is more than doubtful whether the security offered by the association would be sufficiently good to ensure advances of capital

being made to its members on remunerative terms. The unlimited liability of each for the debts of all necessitates great caution before a new member can be elected into one of these associations. The circumstances and previous career of candidates for membership are most carefully inquired into. They must give satisfactory evidence as to their previous character and industry, and they are required to give substantial proof that they are in a position to share the pecuniary responsibilities of the association by becoming shareholders in it. Care, however, is taken to elect no one who is not a *bona fide* workman. The capital required for making loans is partly obtained from the subscriptions of members, but the principal part of it is obtained in the open market, where the association, being able to offer good security, can obtain money on reasonable terms.

The success of these associations has been most striking. In 1865 there were 961 credit banks in existence in Germany. Of these 498 sent in a report of their financial condition to the central bureau, and their accounts showed that they then possessed nearly 170,000 members, and that the money annually advanced was equal to £10,000,000 sterling. As ten years have passed since the time when these reports were sent in, and the prosperity of the associations has during the interval been uninterrupted, there is every reason to believe that the number of members and the amount of the loans would at the present time show a very considerable increase. The very remarkable success of the credit banks is an instance of what great things can be done by self-help and without initiating any attack on the existing order of economic life. It is one of the least pleasing aspects of communism that communists not only do not attempt themselves to bring about by similar means an amelioration in the economic condition of society, but they have often gone out of their way to pour contempt and ridicule on such reforms as that introduced by Herr Schulze-Delitzsch. The establishment of the credit banks was looked on with great disfavor by the German communists. Their leader, Ferdinand Lassalle, published a book, said to be the most important of his economic writings, in which he bitterly attacked the credit banks and the co-operative system generally (*Herr Schulze-Delitzsch, Der ökonomische Julian, oder Kapital und Arbeit*, Berlin, 1864; *Dem deutschen Arbeitsstande und den deutschen Bourgeoisiegevidmet*). Co-operation, he saw, made no attack on the principles of private property and competition; and it was these principles which he had set himself to destroy. The good achieved by an amelioration of the condition of the people did not appear to him to outweigh the evils which he believed to be associated with every circumstance that favored the accumulation of capital in private hands. Co-operation, he urges, is only improved capitalism, and the very improvement by making it more formidable seemed only to make it more hateful to him.

In the same spirit of bitter hostility to all means of improving the existing condition of society without changing the basis on which it rests, communists have often shown great contempt for political liberalism. The changes proposed and carried out by political liberals are condemned by the communists as a mere patching up of an essentially worthless fabric which must be got rid of before anything better can be substituted in its place. At the time when the agitation for the Reform Bill carried in 1832 was uppermost in the minds of all English politicians, Robert Owen took an opportunity of proclaiming in public his belief in the utter futility of all political reform. The German communists, or socialists as they are often called, have, generally speaking, been very emphatic in expressing themselves in a similar strain. The following passage, taken from the writings of Karl Marx, a member of the International Society, is scarcely an exaggeration of the views of the German school of communism on the value and results of political liberalism:—

"Although the liberals have not carried out their principles in any land as yet completely, still the attempts which have been made are sufficient to prove the uselessness of their efforts. They endeavored to free labor, but only succeeded in subjecting it more completely under the yoke of capital; they aimed at setting at liberty all labor powers, and only riveted the chains of misery which held them bound; they wanted to release the bondman from the clod, and deprived him of the soil on which he stood by

buying up the land; they yearned for a happy condition of society, and only created superfluity on one hand and dire want on the other; they desired to secure for merit its own honorable reward, and only made it the slave of wealth; they wanted to abolish all monopolies, and placed in their stead the monster monopoly, capital; they wanted to do away with all wars between nation and nation, and kindled the flames of civil war; they tried to get rid of the state, and yet have multiplied its burdens; they wanted to make education the common property of all, and made it the privilege of the rich; they aimed at the greatest moral improvement of society, and have only left it in a state of rotten immorality; they wanted, to say all in a word, unbounded liberty, and have produced the meanest servitude; they wanted the reverse of all which they actually obtained, and have thus given a proof that liberalism in all its ramifications is nothing but a perfect Utopia."

The condition of England is often pointed at triumphantly by communists of other countries as a complete condemnation of the principles of private property, capitalism, and competition. Lassalle, Marx, Louis Blanc, and others quote passages from bluebooks, speeches of English statesmen, and writings of our public men in which the condition of the English poor is painted in the darkest colors. In England, they say, for the last half century you have had liberalism in the ascendant; you have had free trade, you have had an energetic and industrious people; the amount of capital eager for employment is practically unlimited; competition has had in nearly every branch of trade the most unrestricted development. In England, if anywhere, we may surely look for the nearest approach to perfection of which the present economic condition of society is capable. Then they proceed to quote passages from parliamentary speeches and official reports, and from English writers on political economy, all bearing witness to the terrible poverty and squalor in which a large proportion of the laboring class in this country spend their lives. M. Louis Blanc, in the book already referred to, quoted from Lord Lytton's *England and the English* a passage showing that the amount and quality of nutriment consumed by the inmates of our jails and workhouses were at that time far in excess of what could be obtained by the wages of the frugal and industrious workingman. Marx cites the following passage from Dr. Hunter's report to the Privy Council (1862-3) on the domiciliary condition of the agricultural laborer:—"The means of existence of the hind are fixed at the very lowest possible scale. What he gets in wages and domicile is not at all commensurate with the profit produced by his work. His means of subsistence are always treated as a fixed quantity; as for any further reduction of his income he may say *nihil habeo, nihil curo*. He is not afraid of the future; he has reached zero, a point from which dates the farmer's calculation. Come what may he takes no interest in either fortune or misfortune."

Whatever may be the value of the remedy which communism suggests for so melancholy a condition as that here described, it is surely useful that the attention of people who have "much goods laid up for many years" should be forcibly arrested, and that they should be made to consider why it is that in the richest country in the world the condition of a large proportion of the laboring classes is so bad that it can hardly be made worse. But at present there is a general conviction that the remedy proposed by communists is one which it would be overwhelmingly difficult to apply, and it is also believed that even if it were applied it would be of doubtful efficacy. Some of the most obvious difficulties associated with the practical adoption of communism have been already adverted to. The social, political, and industrial edifice which is the outcome of centuries of effort and sacrifice would be destroyed by the adoption of communism; it would be necessary to reconstruct society from its very foundations; and society, like a constitution, is one of those things which cannot be made—it must grow. Then also the efficacy of communism as a remedy for the miserable condition of the poor is, to say the least, doubtful. To what cause may be assigned most of the pauperism, misery, and squalor which hang like a cloud over the lives of so many of the laboring classes? What was the principal agency which brought about calamities like the Irish and

the Orissa famines? There can be but one answer to these questions,—the pressure of population on the means of subsistence. Many communistic writers have passionately denied this, and have denounced with all the fervor of emotional natures the doctrines laid down by Malthus that population tends to increase faster than subsistence is capable of being increased. No one, however, has attempted to throw doubt on the main fact on which the Malthusian doctrine rests, that every-where, except in very new countries with a large extent of unoccupied fertile land, checks on population are in active operation. These checks must exist everywhere where population does not increase at its greatest possible speed. Under favorable conditions population sometimes has doubled itself in 20 years. Professor Cairnes has stated that in Ireland the population more than doubled itself in the 38 years between 1767 and 1805. At the rate of increase of the ten years ending 1870, the population of England would double itself in 63 years, that of France in 265 years. In France and England, therefore, checks on population are, in a varying degree, in active operation; and the same may be said of all old countries. It is important, however, to inquire into the nature of the checks on population in actual operation. They may be divided into two classes, the first carrying with it nothing but misery and degradation, the second implying a high degree of self-restraint, independence, and foresight. In the first class may be placed war, pestilence, famine, and all the diseases incident to insufficient food and overcrowding. In the second class may be placed prudential restraints on marriage and on the number of births to each marriage, and emigration. Every circumstance which weakens the efficiency of the checks on population comprised in the second class necessarily adds to the force of the checks which we have placed in the first class. In other words, any circumstance which relaxes the force of the prudential checks on population tends to produce the miseries of famine, scarcity, and "starvation diseases." What would be the effect of communism on the population question? Would it strengthen or weaken the motives which promote a prudential limitation of numbers? Nearly all communists, whether theoretical or practical, have faced in one way or another the population question. The solutions they have offered differ widely. Let us first see what the greatest of theoretical communists have had to say on the subject.

Plato seems to have thought the matter an easy one, and says that the guardians of his state must control the number of births. In Utopia the age at which men and women were allowed to marry was fixed by the state, and all irregularities in defiance of this rule were to be severely punished. The population was also to be kept within certain limits by means of migration, emigration, or colonization. But the theoretical communists of modern times have hardly found words strong enough to express their detestation of the principle that any limitation is desirable to the possible number of births. The writings of Malthus are spoken of as "an outrage on household life." His language, it is said, "brutalized the purest feelings of domesticity." M. Louis Blanc inveighs against the doctrines of political economists, and protests that they are blaspheming God when they say that the prosperity of the poor would be promoted by a limitation of the population. Why are you not logical? he cries. If you were you would recommend that the children of the poor should be put to death! And in another place he speaks of "cette économie politique sans entrailles dont Ricardo a si complaisamment posé les prémisses, et dont Malthus a tiré avec tant de sang-froid l'horrible conclusion. Cette économie politique portait en elle même un vice qui devait la rendre fatale à l'Angleterre et au monde" (*L'Organisation du Travail*, p. 71). Practical communists have not, however, met the population question in the spirit indicated by these quotations. Several of the most successful realizations of communistic life have maintained the strictest celibacy among their members. The Essenes, who practised community of goods before the Christian era, were a sect composed entirely of men, who lived in seclusion from the world, and were in many important respects the prototypes of Christian hermits or monks.

Two of the most important communistic societies of the United States have also made celibacy an essential feature

Checks  
on pop-  
ulation.

Control of  
marriages  
and births.

of their system. The "Economites" and the "Shakers," the societies to which reference is made, have existed since 1805 and 1792 respectively. They are strictly celibate, their numbers being recruited by converts from the outside world and to a slight extent by the adoption of pauper children and orphans from neighboring towns. Other communistic societies maintain the authority of the heads of the society to limit the number of marriages. The Spartan Government, which in many important respects was communistic, exercised the most absolute control over the increase of population. Among the Moravians marriage is not permitted to take place without the consent of the heads of the society, who furnish the newly-married couples with a suitable marriage-portion. The Separatists, an American community of German origin, established in 1817, favor celibacy, although they do not enforce it. No marriage can take place without the consent of the trustees of the society; and they further discourage marriage by entering among the articles of their religion a declaration of their belief that celibacy is more in accordance with the divine will than marriage. The Amana community also, a German society in the United States, which dates its origin from early in the last century, discourages marriage among its members. No man is allowed to marry before he is twenty-four years of age. Mr. Nordhoff relates that the reason for this rule was explained to him by one of the elders of the Amana Society in these words,—“They” (the young men) “have few cares in life, and would marry too early for their own good—food and lodging being secured them—if there were not a rule upon the subject.” The religious tone of the community is also set against marriage. “In the Amana Church there are three classes, orders, or grades, the highest consisting of those members who have manifested in their lives the greatest spirituality and piety. Now if the newly-married couple should have belonged for years to this highest class, their wedding would put them down into the lowest, or the ‘children’s order,’ for a year or two until they had won their slow way back by deepening piety” (Nordhoff’s *Communistic Societies of the United States*, pp. 36-7). Even the Perfectionists, whose extraordinary system of “complex marriage” has been already referred to, take many precautions against a superabundant population. The number of births is controlled by the heads of the society. The founder of the community writes as follows: “Previous to about two and a half years ago we refrained from the usual rate of child-bearing for several reasons—financial and otherwise.” Even when the number of births was increased it was stated that they were purposely kept within such limits that “judicious moral and spiritual care, with the advantage of a liberal education,” could be guaranteed to every child (Nordhoff, p. 276). The practical answer made by communists to the population question, even in so wealthy a country as America, in which unoccupied fertile land can be easily and cheaply obtained, is that a strict limitation of numbers is absolutely essential to their social and industrial well-being. As a matter of fact the population of nearly all the American communistic societies has not increased at all, but has greatly declined during the last fifty years. The number of Shakers, for instance, in 1823 was 3800; their number in 1874 was 2415. The Icarians, the only American community which makes marriage compulsory, have declined in twenty-five years from 1500 to 65.

It would, however, be rash to conclude from these facts that the general adoption of communism would tend to strengthen the prudential checks on population. We have seen that modern communists, when freed from the trammels of actual experience of the daily working of the system they advocate, have vigorously denounced the theory and practice of Malthusianism. The American communities have declined in numbers partly in consequence of the adoption in two of them of celibacy as a religious principle. It is also impossible to avoid the conclusion that their numbers have fallen off partly in consequence of the unattractive conditions of communistic life. The young members of these societies not unfrequently leave them when they arrive at manhood and womanhood. The routine and absence of spontaneity of communistic life is a weight to young and active minds that is not counter-balanced by security from want, or what has been called a bread-and-butter prosperity. The numbers of marriages and of

births have been controlled in other of these societies in virtue of the absolute despotism which is vested in their chiefs; individual liberty is entirely suspended; the smallest minutiae of the daily life of their members is regulated from headquarters. A government which decides at what hour its subjects shall go to bed at night and rise in the morning; which prescribes the color, shape, and material of the dresses worn, the time of meals, the quality of the food consumed, the daily task apportioned to each member; which enforces a rule that each of its subjects shall leave every morning a notice stating at what exact spot he or she will be found during each hour of the day; a government which can do all these things will find no great difficulty in controlling the number of marriages and births. Mr. Nordhoff states that “the fundamental principle of communal life is the subordination of the individual’s will to the general interest or the general will; practically this takes the shape of unquestioning obedience by the members towards the elders or chiefs of their society.” If, however, communism were adopted throughout a whole nation, the minute despotism which now distinguishes the government of existing communistic societies, and which furnishes them with an effectual control over the growth of population, would cease to be possible; or if, indeed, it should ever become possible it would be through the careful suppression of individual liberty, and through the strenuous encouragement of everything which tended to destroy self-reliance on the part of the people and to build up the absolute power of the state. A people who purchased material prosperity at the price of their liberty would strike a bad bargain, especially when it is remembered that the limitation of the number of marriages and births which is enforced by the central authority in a communistic society can be effected by voluntary self-control in a society based on private property and competition. The difference, therefore, so far as the population question is concerned, between communism and private property is whether the necessary restraint upon the possible number of births shall proceed from the direct intervention of the state, or whether it shall proceed from the combined motives of self-interest, self-control, and parental obligation on the part of the people themselves. It should be remembered that what communism professes to be able to do is to ensure to every member of a communistic society an ample supply of the necessaries and conveniences of life. If the population question is pressing now when the workhouse and parochial relief are the only refuge of those who cannot maintain themselves, would it not become much more pressing if a man could obtain freely, and without fulfilling any disagreeable conditions, food, house, and clothing for himself, and as many children as he chose to bring into existence? It is this consideration which has forced upon the government of communistic societies the control of the marriages and births of their members. Even where the principles of communism are adopted in so very materially modified a form as they are in our poor-law system, legislative control over population has been enforced. The regulation which separates man and wife in the workhouse is a practical recognition of the principle that, where the State guarantees a maintenance, it must, in self-protection, exercise control over the numbers of those dependent on it for support. Self-help brings with it self-control; state-help makes state-control indispensable. In the present economic condition of society the solution of the population question is not to be found in placing in the hands of the state, as communism has done, absolute control over domestic life. The solution of the problem must be sought in education, in an improved standard of comfort and a determination on the part of the people not to sink below it, and in a reform of the most communistic portion of our poor-law system,—the lavish distribution of out-door relief.

There are some charges made against communism which may be brought with at least equal force against the economic and industrial arrangements which now prevail. One of these is that communism does not avail itself sufficiently of the motive of self-interest in order to obtain from each laborer the best and most conscientious work of which he is capable. If, it is urged, the result of a man’s industry belongs not to himself solely but to the whole community of which he is a member, he will not throw the same energy and zeal into his work as he will if everything which he produces be

Self-inter-  
est as a  
motive to  
labor.

longs solely to himself. There can be no doubt of the truth of this statement; self-interest is a force on which industrial machinery chiefly relies for motive power. But it is remarkable that the prevailing system of working for fixed weekly wages checks the play of self-interest in the workman much more completely than it is checked in a communistic society by the fact that the results of the labor of each are shared by all. A workman who is in receipt of fixed weekly wages has no motive to reach any higher standard of excellence or expedition in his work than such as will prevent him from being discharged for bad work or laziness. It is a complaint constantly heard among employers of labor that the only ambition of the men seems to be to see how little work they can do for their wages. The actual existence of this feeling among workmen is proved by many of the rules of trades' unions,—such as that which limits the number of bricks which a hod-man is allowed to carry, and which in one case forbade the use of wheelbarrows in taking bricks from one spot to another. Mr. Thornton's book *On Labor* gives several examples of the rules adopted by trades' unions to check the tendency which is sometimes found in a workman to exert himself to do his best and thus show his superiority over his fellows. "Not beating one's mates" has by several unions been made the subject of special enactment. . . . The Manchester Bricklayers' Association has a rule providing that 'any man found running or working beyond a regular speed shall be fined 2s. 6d. for the first offence, 5s. for the second, 10s. for the third, and if still persisting shall be dealt with as the committee think proper.'" It was urged by the trade unionists in the textile manufactures of Lancashire and Yorkshire as a serious argument for placing impediments in the way of the employment of women in these industries that they were apt to take a pride and pleasure in the excellence and rapidity of their work, and that their vanity was such that a word of praise or encouragement from the overlooker would cause them to redouble their exertions (Report of Dr. Bridges and Mr. Holmes on the condition of women and children employed in Textile industries, 1873).

These examples are more than sufficient evidence that the present industrial system does not bring into play the motive force of direct self-interest in stimulating the exertions of the laborers. In this respect communism would seem at first sight to compare favorably with mere wages-receiving industry; for in a communistic society every man and woman has some direct share, however small, in the results of his or her labor. If more is produced, there will be more to receive; and instead of a trades' union, every member of which is pledged, under penalties, to work slowly and to watch that his fellow-workmen do the same, communism gives to each laborer a direct interest not only in working well himself, but in watching to see that honest and steady work is done by his neighbors. As a matter of fact, the American communistic societies have found no difficulty in enforcing the habit of careful and regular industry on their members. The American communists do not as a rule work hard; for they find that they can provide for all the wants of a community without excessive or exhausting toil. But there are no idle members, and every member works well and steadily while he is working. That the quality of their work is good is proved by the fact that their commercial reputation stands very high. The garden seeds, the production of which is the staple trade among the Shakers, have been celebrated for their excellence for more than seventy years all over the United States. "The Oneida Perfectionists established the reputation of their silk twist in the market by giving accurate weight and sound material; the woollen stuffs of Amasa command a constant market, because they are well and honestly made; and in general I have found that the communists have a reputation for honesty and fair dealing among their neighbors, wherever their products are bought and sold" (Nordhoff).

It must, however, be remembered that a few small communities, such as those which exist in America, afford no fair test of what would be the effect of a general adoption of communism on industrial activity and efficiency. The communists in the United States only number about 5000, including children; and though there are eight different societies, these are divided into 72 separate communities, the Shakers alone having 68. On an average, therefore,

each community consists of less than 70 persons. The elaborate despotism of communistic government, together with the minute surveillance which the small size of these communities renders possible, makes it easy for the leaders of these societies to exact from each member his quota of toil; idleness would be at once detected and would not be suffered to exist, as the power of expelling an idle member would be resorted to if the voice of public opinion were not sufficient to induce him to mend his ways. Similar means of detecting and preventing idleness would be completely absent if communism were generally adopted. There would, of course, in this case be no power of expelling an idle member, and the difficulty of detecting and proving to the central authorities a disposition on the part of any of the members to avoid a fair share of work would increase *pari passu* with the size of the community. The motive of self-interest in promoting good work is much more powerful in a small communistic society than in a large one. A man can appreciate the value of his own industry much more clearly if the resulting product is shared between 60 or 70 persons, every one of whom is well known to him, than he can if it is thrown into the common stock of 20,000 people. The weakening of the motives of self-interest which is inherent in communism is reduced to a minimum in small communities, but it would act with fatal results to industrial activity if there should ever be an attempt to make communism universal. For, much as the present system falls short of making the most of the great engine of self-interest among those who merely work for wages, there is no such failure among the other industrial classes. Capitalists, landowners, inventors, Cornish tributers, and members of co-operative productive societies and copartnerships are all brought under the stimulating influence of self-interest, and thus devote themselves to industrial projects with a zeal completely and necessarily unknown among those who work for wages or those who are members of communistic societies. It is the special feature of co-operation that it brings the motive of self-interest into activity among manual laborers. Without attempting, as communism does, to overthrow all existing economic institutions, it takes these as they are, and men and women as they are, and suggests a means by which the laborer, no less than the capitalist, can be stimulated by direct self-interest to throw some energy and enthusiasm into his work.

We referred above to the melancholy picture drawn by Karl Marx, Louis Blanc, and others of the condition of the English poor. Since they wrote, co-operation has in some parts of England done much to brighten the social and industrial condition of the working classes. The *Times* of 18th August, 1875, gives an account of the co-operative manufactures in the town of Oldham. In this one town there are 80 joint-stock co-operative mills; in the county of Lancashire there are 150. The bulk of the shareholders are artisans, who labor in the mills, and who therefore have a direct and immediate interest in the results of their industry. Cotton-spinning and weaving are the principal businesses carried on in these mills. The principle of self-interest has had the effect of producing, not mere activity on the part of the laborer, but thoroughly sound and honest work. We are told by the *Times* that these mills possess a high reputation for probity of manufacture. They are worked partly with capital subscribed by the shareholders, in £5 or £10 shares, and partly with borrowed capital which bears a fixed rate of interest. Many of the mills pay a dividend of 10 per cent. on their share capital; the ledgers and account-books of each society are open to all the shareholders, who also exercise the power of electing in open meeting the managers and officers of the association. The shareholders frequently invest money on loan to the societies of which they are members, so that the interests of the lenders and of the shareholders are identified in the most absolute manner possible. The most important of these associations is perhaps the Industrial Co-operative Society of Oldham founded in the year 1850-1. From very small beginnings it has gradually extended its operations until in the year 1874 it divided a dividend of £40,000 among its shareholders in four quarterly instalments of £10,000 each. The total turnover of this society is £250,000 a year. It forms, as it were, a kind of bank to the other co-operative societies. At Christmas 1874 it had out on loan to these associations a number of sums varying

from £11,732 downwards, making a total of £45,437. The Sun Mill Company, another of the Oldham co-operative associations, has a share capital of £100,000. It is stated in a parliamentary return published in 1874 that there are in England and Wales 790 co-operative societies, with 340,930 members, a share capital of £3,334,104, and a loan capital of £431,808. Their net profits for the year 1873 were £958,721, of which £861,964 was distributed as dividends among the members of the society, and £18,555 was paid away as interest to non-members. There can be no doubt that co-operation was to a great extent originated in England by communists. It is an outcome of the communistic movement, for it was in the first instance mainly promoted by social reformers who had proved by many failures the futility of communism as an engine of social regeneration. Notwithstanding its origin, there is, however, no movement more distinctly non-communistic than co-operation. It strengthens the principles of capital and private property by making every co-operator a capitalist, and thus personally interesting him in the maintenance of the present economic condition of society.

When the really great results of co-operation in this country are compared with the very limited success of nearly a century of communism in America, the conclusion is inevitable that co-operation is much more effectual than communism in producing a radical improvement in the condition and status of labor, that it is easier to graft upon existing institutions, and that its working is unaccompanied by the despotism, the crushing of individuality, and the discouragement of self-help, which are the admitted dangers and drawbacks of communism. The state banks and national workshops of M. Louis Blanc's economic dreams were realized in 1848-50 in a manner that must have caused the severest disappointment to their philanthropic author; failure and discredit were their only practical results. The Social Democrats of Germany, with Lassalle at their head, have left nothing tangible which can be said to have advanced their cause. The Schulze-Delitzsch credit banks, which they assailed as an improved form of capitalism, have done and are doing more for labor in Germany than the whole Social Democratic party has ever done.

In France the names of Saint Simon, Fourier, Bazard, and Enfantin, suggest chiefly a series of tragic failures. In England Owen's name recalls the brief existence of Harmony Hall and Orbiston, the establishment of the Labor Exchange and the issue of Labor Notes, and a number of other schemes which raised great hopes and expectations that were doomed to a speedy disappointment. In America the success of communism, such as it is, is hardly more encouraging than its failure in Europe. The measure of material prosperity achieved is not very considerable, bearing in mind the length of time most of the societies have existed and the ease and cheapness with which unoccupied land can be obtained in the United States. Mr. Nordhoff estimates the capitalized wealth of the 72 American communes at twelve millions of dollars, or about £2,400,000 sterling. They own between 150,000 and 180,000 acres of land, or on an average about 36 acres a head—a comparatively small holding for America. The 72 communes are spread over 13 States; they possess some of the most fertile land in the world; one of the Shaker villages owns a magnificent estate of 4500 acres lying in the famous Miami bottom, a soil much of which is so fertile that after sixty years of cropping it will still yield from 60 to 70 bushels of corn to the acre without manuring. The material condition of the inhabitants of the communistic villages compares favorably, no doubt, with that of the German peasants by whom the majority of American communes were originally started; but the monotony, the personal submission, the impossibility of privacy or temporary seclusion, the absence of anything like intellectual activity in these societies, would render the life well-nigh unbearable to people who had been previously accustomed to a higher standard of happiness than that at present within the reach of the ordinary day-laborer. Many communistic experiments in America have been unsuccessful. Mr. J. H. Noyes, in his book on "American Socialism," gives a short history of no fewer than forty-seven of these failures. Comparing the history of those societies which have died a natural death with that of those which still continue to exist, it is found that the successful societies had no advantage either in the wealth of their members or

the intellectual ability of their leaders. Most of the successful societies began poor; most of the unsuccessful societies began with what were believed to be sufficient means to achieve success. Many of the unsuccessful societies were founded by high-minded, highly-cultivated men and women, and their members were distinguished for their education and intellectual attainments. From these facts and with ample means through personal experience for forming a correct opinion, Mr. Nordhoff draws the conclusion that in a communistic experiment success depends upon a feeling among all the members "of the unbearableness of the circumstances" in which their lives were originally cast. They must have suffered from wrong and oppression, as well as from want, before communism can appear as a welcome change in their manner of life. Hence the poorer and more narrow and miserable the condition of the people who start a communistic experiment the more likely is it under judicious leaders to succeed. People are easily satisfied when almost any change in their lives must be for the better. It would be most undesirable to detract from the achievement of the American communes in raising the poorest and most miserable peasants to a degree of material prosperity, which compares with that of the well-to-do small farmer in England or America. This is no small feat; and they have also proved the possibility of putting communism into a practical form, at any rate on a small scale, and under exceptionally favorable economic conditions. But it is impossible to doubt that their principal value to the world has been in illustrating the limitations and drawbacks of the system. As long as communism remained an unexplored region given over to the dreamers of dreams and the seers of visions, it was impossible to prove that it did not possess all the marvellous perfection they fondly attributed to it. The American societies offer a life which is confessedly attractive only to those whose original circumstances are exceptionally unfortunate; to these communism can give, together with a congenial religious atmosphere, material prosperity of a humble type, accompanied by the sacrifice of individuality, liberty, privacy, and intellectual development. It can hardly be denied that these experiments prove that, even were communism on a large scale practically possible, it could never satisfy the aspirations of those who look for a time when increased material prosperity among the working-classes shall be accompanied by a corresponding increase of intellectual activity, political responsibility, and personal independence. The old form of society would seem to be more favorable than communism to the growth of these qualities; and it is probable that the American experiments may help to establish the conviction among economic revolutionists that more can be accomplished by grafting new institutions, such as co-operation, on the old plant of private property than can be achieved by rooting it up altogether, and planting the seedling of communism in its stead.

See Reybaud, *Les Reformateurs Modernes*; Nordhoff, *Communistic Societies of the United States*; Rev. M. Kaufmann, *Socialism*; Louis Blaa, *L'Organisation du Travail*; A. J. Booth, *Life of Robert Owen, Saint Simon and Saint-Simonism*, and art. "Charles Fourier" in *Fortnightly Review*, vol. xii., new series. See also the articles FOURIER, OWEN, and SAINT SIMON. (M. G. F.)

COMO, a city of Italy, capital of the province of its own name, at the south-west corner of the Lake of Como, in a beautiful valley surrounded by richly-clad mountains. It lies in 45° 48' 26" N. lat. and 9° 4' 45" E. long., and is distant twenty-eight miles by rail from Milan. The city proper is still surrounded by its ancient walls and towers; but two pretty extensive suburbs, known as Vico and St. Agostino, have grown up outside—the former containing a large number of fine villas, and the latter devoted specially to manufacturing purposes. The principal buildings are the cathedral, the broletto or town hall, the churches of St. Fedele and St. Abondio, the *Palazzo Giovinio*, with its library and collection of antiquities, the Gallio College, and the theatre. The cathedral, erected by the voluntary contributions of the citizens, is a structure of various dates and styles of architecture,—the earliest portions being by Lorenzo de' Spazi of the end of the 14th century, while the cupola is the work of Guvara, an architect of the first half of the 18th. The most interesting, perhaps, of the monuments which it preserves, is that of Benedetto

Gioivo, an early historian of the city. The broletto dates from 1215, and is built of alternate courses of black and white marble; but of still greater value as an artistic effort is the church of St. Abondio, a small but exquisite structure of the 11th century, built, it would seem, in the lower portions of Roman remains, and remarkable for an "apee of extraordinary height and richness rising between two tall campaniles." There are extensive factories in Como for the spinning and weaving of silk; it also manufactures woollens, cotton, and soap; and there are iron-works in the immediate vicinity. To its position on the lake and its command of the Splügen and St. Gotthard lines of communication, it is indebted for a considerable trade by way of transit and distribution. About a mile to the south of the town is the tower of Baradello, famous as the place where the Torriani of Milan were confined in cages by the Visconti party, over whom they had previously tyrannized. The population of Como is 24,350.

Como is readily identified with the ancient *Comum*, a city of Gallic origin, situated within the territory of the Galli Insubres. Though from an early period a flourishing and important centre, it never played a very conspicuous part in ancient history. Soon after the beginning of the 2d century a.c., the people of Comum joined the Insubres in an attack on the Romans; but they were defeated, and their city fell into the hands of the conquerors, and became a Roman colony. The first colonists, however, were unable to maintain themselves against the inroads of the Rhetian Gauls; and additional settlers were sent down from time to time. Julius Cæsar, in particular, introduced 5000, of whom a tenth were Greeks; and the colony assumed for a short time the name of *Novum Comum*. On the accession of Cæsar to supreme power, Comum obtained the complete right of citizenship; but though it was at this time at the height of its prosperity, it never took rank higher than a municipal town. In the early part of the Middle Ages it formed for a time, like many of the towns of Italy, an independent republic; but after a considerable struggle it had to submit to Milan. Its deliverance was effected in 1158 by Frederick I. of Germany, to whom its citizens had appealed; but in the 15th century it again succumbed before the Milanese nobles. In 1520 it was captured by Charles V. During the Roman period the Pliny family were connected with the city; and in more modern times it numbers among its celebrities Paulus Jovius, Piasa the astronomer, and Volta the electrician. See Cantu, *Storia di Como*, 1829; and Monti, *Storia di Como*, 1829.

COMO, LAKE OF, or, in Italian, *Lago di Como*, known to the Romans as *Lacus Larius*, is, from the beauty of its scenery and the mildness of its climate, one of the most celebrated of all the Italian lakes. It is situated in the province of Como, in that part of the country which belonged to the kingdom of Lombardy; and it occupies the bottom of a great valley, which, stretching south from the neighborhood of Chiavenna at the foot of the Splügen, breaks up at Bellaggio into two branches which run respectively south-east and south-west. The lake is thus divided into three basins, of which the south-western is known more particularly as the Lago di Como, and the south-eastern as the Lago di Lecco. The northern part of the original basin has been silted up by the débris brought down from the valleys of San Giacomo and Bregaglia by the River Mera; and not only has the Adda, which enters from the east, filled up the branch that in all probability once extended up the Valtelline as far as Morbegno, but it has also, by its delta, or cone of ejection, cut off from the main body of the lake the part now known as the Lago di Mezzola. Of the real form of the bed of the lake there was hardly any knowledge till 1865, when a survey was undertaken by Signor Gentilli and M.M. Casella and Bernasconi. The results obtained were published by Gentilli in the second volume of the *Memoirs of the Società Italiana di Scienze Naturali*, and by his coadjutors in a separate pamphlet entitled *Cenni Orografici sul Lago di Como*. It appears that the greatest depth is 1341 feet, which was registered in a section of the Lago di Como from Torrighia to Como. From the northern extremity of the lake the basin gradually grows deeper as we advance southwards, till it shallows towards the promontory of Bellaggio; in the south-western branch it grows rapidly deeper again, while in the south-eastern it shallows to 390 or 290 feet. This difference of the two branches is easily explained by the fact that the Lago di Como is a closed basin except at its junction with the main body of the lake, and throughout a coast line of upwards of forty miles receives only two unimportant torrents, while the Lago di Lecco is in the direct course of

the Adda, which makes its exit by the southern extremity. The total length of the lake, from Como to its northern extremity, is about thirty miles, and its greatest width, between Menaggio and Varenna, about two miles and a half. The shores of the lake are studded with ancient castles, flourishing hamlets, and the villas of wealthy proprietors. On the eastern side the principal places are Collicopiano, Dervio, Bellano, Varenna, Mandello, and Lecco; and along the western Gravedona, Dongo, Menaggio, Cadenabbia, Argegno, Moltrasio, and Cernobbio. Bellaggio, as already mentioned, is situated at the promontory where the lake bifurcates southwards. The Villa Vigorni, near Menaggio, formerly the property of Mylius of Frankfurt, contains sculptures of Thorwaldsen, Marchesi, and Argenti; the Villa Giulia, near Bellaggio, belongs to the king of the Belgians; the Villa Carlotta or Sommariva, near Cadenabbia, took its name from Charlotte of Prussia, wife of the duke of Saxe-Meiningen; the Villa d'Este, near Cernobbio, was at one time the residence of Queen Caroline of England. The Villa Raimondi or Odescalchi, is the largest of all.

For further details, besides the publications already referred to, see Cantu, *Como e il suo lago* (last edition, 1872); Leonhard, *Der Comersee und seine Umgebungen*, Leipsic, 1862; P. A. Curti, *Il lago di Como e il pian d'Erba*, 1872; and an article by John Ball in the eighth volume of the *Geol. Mag.*

COMONFORT, IGNACIO (1812-1863), a Mexican soldier and politician, who, after occupying a variety of civil and military posts, was in December, 1855, made provisional president by Alvarez, and from December, 1857, was for a few weeks constitutional president. See MEXICO.

COMORES, or COMORO ISLANDS, a group in the Mozambique Channel, between Madagascar and Cape Delgado, on the east coast of Africa, discovered by Houtman in 1598, and consisting of the four main islands of Angaziya, Angazecha, or Great Comoro, Anzuan or Johanna, Mohilla, and Mayotta, and a considerable number of diminutive islets. 1. *Comoro*, the largest, has a length of about thirty-five miles, with a width of about twelve, and a population of 35,000. Near its southern extremity it rises into a fine dome-shaped mountain, which has a height of upwards of 8500 feet, and is visible for more than 100 miles. Eruptions are recorded for the years 1830, 1855, and 1858; and traces of the last of these commotions are still very distinct. The island is politically divided into various petty principalities, and maintains its own petty feuds. The natives are tall of stature and well-formed, and appear to be mainly of Arabic descent, with a mixture of Malagasy blood. The chief towns are Maroni, Izanda, and Mouchamouli; the first, situated at the head of a bay in 11° 40' 44" S. lat., being the seat of the principal sultan in the island. 2. *Johanna*, next in size, rises in a succession of richly wooded heights till it culminates in a central peak, upwards of 5000 feet above the sea, in 12° 14' 17" S. lat. and 44° 27' 34" E. long. The whole island is under one sultan, who resides at the town of Johanna on the north side. The natives are hospitable to foreigners, and especially to Englishmen. Domestic slavery exists, but of a very mild description. The capital, which is sometimes called Moussamondou, is substantially built of stone, surrounded by a wall, and commanded by a dilapidated citadel; it is the seat of an English consul, and carries on a considerable trade in supplying ships with provisions. There is a small but safe anchorage at Pomony, where coal is kept for H.M. ships in the Mozambique Channel. The population amounts to about 12,000. 3. *Mayotta*, about 21 miles long by 6 or 7 miles in breadth, is surrounded by an extensive and dangerous coral-reef. The principal heights on its extremely irregular surface are Mavegani Mountain, which rises in two peaks to a maximum of 2164 feet, and Uchongin, which only falls below it by about 60 feet. The island belongs to the French since 1843, and they have established a small military and naval colony on the contiguous islet of Zaudzi, which lies within the reef in 12° 46' 48" S. lat. and 45° 20' 14" E. long. There are substantial Government buildings and storehouses; the garrison numbers about 100 soldiers; and a number of sugar estates have been formed, especially on the eastern side of the island. Before the French acquisition Mayotta was subject to Dansulu, king of the Sacalavas, who had been expelled from the north-west coast of Madagascar by the conquest of Radama, king of the Ovaha. Population, 12,000. 4

*Mohilla*, the smallest, is 15 miles in length, and 7 or 8 miles at its maximum breadth, with a population of 6000. Unlike the other three it has no peaks, but rises gradually to a central ridge about 1900 feet in height. It is governed by an independent sovereign resident at Douany, a walled town close to the coast, in 12° 17' S. lat. and 43° 46' E. long. The most important town besides the capital is Numa-Choa.

All the islands possess a very fertile soil; they produce cocoa-nuts, rice, maize, sweet-potatoes, yams, sugar, coffee, cotton, indigo, and various tropical fruits. A large number of cattle and sheep, the former similar to the small species at Aden, are reared by the natives; turtle is caught in abundance along the coasts, and forms an article of export, and the fauna is comparatively rich for the size of the area. Population of the group, 65,000.<sup>1</sup>

See T. B. Leigh, "Mayotta and the Comoro Islands," in *Jour. Roy. Geog. Soc.*, 1849; De Horsey, "On the Comoro Islands," in *Jour. Roy. Geog. Soc.*, 1864.

COMPANY is one of the many words used to denote the association of individuals in the pursuit of some common purpose. Partnership, union, society, club, corporation, and company, all have this shade of meaning in common, although they differ from each other in many particulars. The suggested derivation of the word company (from *cum panis*) may be compared with the original meaning of *guild*. A guild was a feast, and the first associations named guilds, like the first associations named companies, had for their object the furtherance of a common entertainment. Corporation, unlike the other words of similar meaning, has in law a very definite signification. It applies only to an association which has been endowed with a fictitious personality, enabling it to sue and be sued, to acquire rights and incur obligations, without the individual members thereof being implicated. Company, on the other hand, may be used generally to describe almost any kind of association. In practice, however, it is confined to two classes of associations. The first are those joint-stock companies whose vast proportions and wide ramifications are among the most striking features of modern industrial life. The other are the livery or city companies, which still retain the name and the constitution, while they have long abandoned the objects of the guilds of the Middle Ages. See CORPORATIONS.

*Joint Stock Companies.*—Commercial companies are a comparatively modern creation in English law. The common law appears to have recognized no privileged associations except those which were incorporated by charter, or statute, or prescription. All other associations, no matter what their numbers or purpose, were mere assemblages of individuals. A trading association was at the best only a partnership, and between large partnerships and small partnerships there was no legal difference whatever. Each of the members was responsible for all the debts of the association, and all the members had to unite in instituting or defending any process of law. The inconvenience of such disabilities must have increased with the growth of trade. On the other hand, if the society applied to the Crown for a charter, and succeeded, it became a corporation, and the members were rendered irresponsible for its debts. What was wanted for trade was a society which might sue and be sued like a corporation, while its members remained personally liable for its debts. Joint-stock companies were regarded at first with great disfavor by the Legislature. In 1719 was passed the Bubble Act (6 Geo. I. c. 18). The first part of the Act, reciting the utility of the practice of assuring ships and lending money on bottomry, empowers the king to create by charter two corporations to deal in such ventures; and all assuring of ships or lending of money on bottomry by any other corporation, partnership, or society, is made illegal. Private persons, acting for themselves, may still continue to underwrite policies and lend money. The Act then recites the growth of dangerous and mischievous undertakings and projects, wherein the undertakers and subscribers have presumed to act as if they were corporate bodies, and have pretended to make their shares transferable, and enacts that "all and every the undertakings and attempts described as aforesaid, and all other public undertakings and attempts tending to the common grievance, prejudice, and inconvenience of his Majesty's subjects, or great numbers of them, in their trade, commerce, or other lawful affairs; and all public

subscriptions, receipts, payments, assignments, transfers pretended assignments and transfers; and all other matters and things whatsoever, for furthering, countenancing, or proceeding in any such undertaking or attempt; and more particularly, the acting or presuming to act as a corporate body or bodies, the raising or pretending to raise transferable stock or stocks, the transferring or pretending to transfer or assign any share or shares in such stock or stocks, without legal authority, either by act of Parliament or by any charter from the Crown, to warrant such acting as a body corporate, or to raise such transferable stock or stocks, or to transfer shares therein; and all acting or pretending to act, under any charter formerly granted from the Crown for particular or special purposes therein expressed, by persons who do or shall use, or endeavor to use, the same charters for raising a capital stock, or for making transfers or assignments, or pretended transfers or assignments, of such stock, not intended or designed by such charter to be raised or transferred; and all acting or pretending to act under any obsolete charter, become void by non-user or abuser, or for want of making lawful elections which were necessary to continue the corporations thereby intended, shall (as to all or any such acts, matters, and things, as shall be acted, done, attempted, endeavored, or proceeded upon after the said 24th day of June, 1720) for ever be deemed to be illegal or void, and shall not be practised or in wise put in execution." And all such undertakings are to be deemed public nuisances. Although wholly powerless to prevent the growth of joint-stock companies, the Bubble Act was not repealed till 1825. The Bubble Act is supposed to have been passed in the interest of the famous South Sea Company. By 9 Anne c. 21 the Crown was empowered to incorporate the persons interested in the public debt, with certain privileges of trade on the South Seas. By 6 Geo. I. c. 4 the company thus created was authorized to increase its stock. The supposed advantages of the company turned out to be a delusion. In the meantime numberless other speculations of a similar character were started, and in many cases pretended to act under charters which were either obsolete or insufficient for the purpose. The South Sea Company prosecuted these adventurers under the Bubble Act, but while it succeeded in exposing their real character it also helped thereby to weaken public confidence in its own. For a period of nearly ninety years the Bubble Act remained inoperative, but at the end of that period several cases under it were brought into court (*Collyer On Partnership*). At the same time, by 6 Geo. IV. c. 91 the Crown was enabled to grant charters of incorporation under which members might be made responsible for the corporation's debts. In 1834 the Crown was empowered to grant to companies by letters patent, without incorporation, the privilege of suing and being sued by a public officer. When a charter could not be obtained, companies might be incorporated, or empowered to plead by public officers, under special Acts of Parliament. For such corporate or quasi-corporate privileges application had to be made either to the Crown or Parliament. In 1826 banking companies were allowed to obtain the privilege of suing by public officer on complying with certain rules. In 1844, all companies (with some exceptions) were enabled to obtain a certificate of incorporation without applying for a charter or a special Act. Banking companies, however, were required to apply to the Crown for a charter. Members of companies thus created were still responsible, to the whole extent of their fortune, for the debts of the companies. In 1855 limited liability was introduced by 18 and 19 Vict. c. 133, shareholders being made responsible to the extent only of the amount of their shares. Companies with this privilege must use the word "limited" after their names. The dissolution and winding-up of insolvent companies remained to be simplified, and from 1846 to 1850 various measures were introduced, enabling different classes of companies to be wound up, without the usual process by bill to which the shareholders, as partners, necessarily had to appear. The legislative history of companies, thus briefly traced, exhibits their development out of simple partnerships in a not uninteresting manner. Partnerships in the eye of the law, they are looked upon by the Legislature as false pretenders to the character of corporations; they are at first denounced as nuisances, then tolerated, and gradually relieved one by one from those legal incidents of partnership which impede their functions in the organization of commerce. In 1862 a consolidation

<sup>1</sup> [These islands were ceded to France by treaty of May, 1866.—AM. ED.]

of the numerous Acts relating to companies was effected by the Act for the incorporation, regulation, and winding-up of trading companies and other associations, which gave to the Court of Chancery exclusive jurisdiction in winding-up. The following are a few of the chief provisions of this important Act. It prohibits the formation of any company, association, or partnership, of more than ten persons for the business of banking, and of more than twenty persons for any business having for its object the acquisition of gain, unless it is registered under this Act. Companies, formed by Act of Parliament or letters patent, or engaged in mining within the jurisdiction of the stannaries, are exceptions. Or, as it may be otherwise stated, all associations for the acquisition of gain, other than those last mentioned, and excluding banking partnerships of fewer than ten, or other trading societies of fewer than twenty members, will be illegal unless registered under this Act. Any seven or more persons, joining together for the pursuit of any lawful object, may form an incorporated company by subscribing a memorandum of association and registering. The liability of members may be unlimited, or it may be limited to the amount unpaid of the nominal value of their shares, or to sums guaranteed. The memorandum of association must contain particulars as to the name, object, &c., of the proposed company; and companies limited by share or guarantee must use the word "limited" after their names. Companies limited by shares may, and other companies, whether limited by guarantee or unlimited, must also send articles of association, containing regulations for the management of the company. The Act contains in a schedule a table of regulations which may be adopted in such companies, and in the case of companies limited by shares will be held to apply, unless expressly modified or excluded by the articles. The memorandum and articles of association are sent to the registrar, who issues a certificate of incorporation, and the subscribers and persons joining them thereupon become a corporate body with perpetual succession, and a common seal, and power to hold lands, but with liability on the part of members to contribute to the assets of the company in the manner prescribed by the Act. Companies, not intended for the pursuit of gain, may not hold more than 2 acres of land without a license from the Board of Trade. Part II. deals with the distribution of capital and liabilities of members of companies and associations under this Act. When a company is wound up, every present and past member shall be liable to contribute to the assets of the company, with the following (among other) qualifications:—No past member shall be liable, if he has ceased to be a member for a year before the winding-up, nor shall he be liable for any debt contracted by the company after he has ceased to be a member, nor unless present members are unable to satisfy the contributions required. Part III. contains provisions for the protection of creditors and of members. Part IV. treats of the winding-up of companies, which may be either by the court or voluntary. A company may be wound up by the court (*i.e.*, the Court of Chancery in England and Ireland, and Court of Session in Scotland) in the following cases, *viz.*, when a special resolution of the company has been passed requiring it; when the company does not begin business within a year from its incorporation, or suspends business for a year; when the members are reduced to less than seven; when it is unable to pay its debts; and when the court thinks it ought to be wound up. Where a voluntary winding-up has been begun, the court may order it to be continued, subject to the supervision of the court. Part V. constitutes a registration office. Part VI. applies the Act to companies registered under the various Joint-Stock Companies Acts. Part VII. defines the companies "authorized to register under this Act." Part VIII. applies the Act to unregistered companies. Part IX. contains a repealing clause and some temporary provisions. After five years' experience of the original Act an amending Act was published in 1867, and the two are to be construed together. The Companies Act 1867 contains provisions facilitating changes in the constitution of companies. A limited company may have directors with unlimited liability. A company limited by shares may under certain conditions reduce its capital, or divide its capital or part thereof into shares of smaller amount than is fixed by the memorandum of association. Associations not intended for gain may have the privileges of limited liability without being compelled to use the word "limited" after their

names. A company may have some shares fully paid and others not. A limited company may issue warrants for shares fully paid up, in name of bearer. There are several sections dealing with contracts made on behalf of a company, and one important section, the 38th, enacts that any prospectus not specifying such contracts shall be deemed fraudulent on the part of the promoters, &c., issuing the same, as regards any person taking shares in the company on the faith of such prospectus. This section was drawn to meet the practice of concealing from investors contracts which would be binding on the intended company when formed, and its somewhat ambiguous phraseology has been the subject of much discussion in the law courts. See, for example, *in re Coal Economizing Gas Company—Lover's case*, *Law Reports 1*, Chancery Division 182.

The objects of certain trading companies, as, for example, railways, involve an interference with the rights of private persons, which requires the direct authority of the Legislature. Such undertakings are therefore authorized by special Acts of Parliament, which begin as private bills before one or other of the two Houses, and pass through both, and receive the assent of the sovereign in the same manner as public bills (*see BILL*). The principles on which state interference with private rights is thus granted have so far been ascertained and fixed by the practice of many parliaments, that the procedure in private bills has tended to assimilate itself more and more to an ordinary litigation. The committees are tribunals acknowledging certain rules of policy, and hearing evidence from witnesses and arguments from professional advocates. An important point in the history of this kind of legislation is marked by the three Consolidation Acts of 1845 (8 and 9 Vict.). The Companies Clauses Consolidation Act consolidates sundry provisions relating to the constitution and management of joint-stock companies, usually introduced into Acts of Parliament authorizing the execution of undertakings of a public nature by such companies. The Lands Clauses Consolidation Act applies to undertakings authorized by special Act to take or purchase land. The Railways Clauses Consolidation Act applies to Acts authorizing the construction of railways. The clauses of the Consolidation Acts are to be taken as incorporated in a special Act of the class in question, unless they are expressly varied or excepted thereby. A further development of the same tendency may be observed in proposals which have been made from time to time to hand over the authority of Parliament, in relation to such companies, to a permanent tribunal.

*Livery Companies.*—These societies, now chiefly remarkable as a feature in the municipal organization of London, belong to a class of institutions which at one time were universally prevalent in Europe. In most other countries they have disappeared; in England, while their functions have wholly changed, the organization remains. The origin of the city companies is to be found in the craft-guilds of the Middle Ages. The absence of a strong central authority, such as we are now accustomed to, doubtless accounts for the tendency to confederation in the beginning of modern societies. Artificial groups, formed in imitation of the family, discharged the duties which the family was no longer able, and which the state was not yet able, to undertake. The inhabitants of towns were forced by external pressure into the societies known as guild-merchants, which in course of time monopolized the municipal government, became exclusive, and so caused the growth of similar societies among their excluded citizens. The craft-guilds were such societies, composed of handicraftsmen, which entered upon a severe struggle for power with the earlier guilds and finally defeated them. The circumstances and results of the struggle are stated to have been of much the same character in England and on the Continent. In London the victory of the crafts is decisively marked by the ordinance of the time of Edward II., which required every citizen to be a member of some trade or mystery, and by another ordinance in the 49th of Edw. III., which transferred the right of election of corporate officers (including members of Parliament) from the ward representatives to the trading companies. Henceforward, and for many years, the companies engrossed political and municipal power in the city of London.

The trading fraternities assumed generally the character of corporations in the reign of Edward III. Many of them had been chartered before, but their privileges,



hitherto exercised only on sufferance and by payment of their terms, were now confirmed by letters patent. Edward III. himself became a member of the fraternity of Linen Armorers, or Merchant Tailors, and other distinguished persons followed his example. From this time forward they are called livery companies, "from now generally assuming a distinctive dress or livery." The origin of the Grocers' Company is thus described:—"Twenty-two persons, carrying on the business of pepperers in Soper's Lane, Chesapeake, agreed to meet together, to a dinner, at the Abbot of Bury's, St. Mary Axe, and commit the particulars of their formation into a trading society to writing. They elect after dinner two persons of the company so assembled—Roger Osekyn and Lawrence de Hallwell—as their first governors or wardens, appointing, at the same time, in conformity with the pious custom of the age, a priest or chaplain to celebrate divine offices for their souls" (Heath's "Account of the Grocers' Company," quoted in Herbert's *Twelve Great Livery Companies*, vol. i. p. 43). The religious observances and the common feasts were characteristic features of those institutions. They were therefore not merely trade unions in the current meaning of that phrase, but may rather be described as forms of industrial self-government, the basis of union being the membership of a common trade, and the authority of the society extending to the general welfare, spiritual and temporal, of its members. It must be remembered that they flourished at a time when the separate interests of master and servant had not yet been created, and, indeed, when that fundamental division of interests arose, the companies gradually lost their functions in the regulation of industry. The fact that the craftsmen were a homogeneous order will account for the wide authority claimed by their societies, and the important public powers which were conceded to them. Their regulations, says Herbert, "chiefly regarded the qualifications of members, keeping their trade secrets, the regulations of apprenticeship and of the company's peculiar concerns, the domestic management of the fraternity and its funds, and the uniting together of it in brotherly love and affection. To these may be added, as forming a prominent feature in all the ancient communities, the regulation of their religious and other ceremonies." In the regulation of trade they possessed extensive powers. They required every one carrying on the trade to join the company. In the 37th of Edward III., in answer to a remonstrance against the mischief caused by "the merchants called grocers who engrossed all manner of merchandise vendable, and who suddenly raised the prices of such merchandise within the realm," it was enacted "that all artificers and people of mystery shall each choose his own mystery before next Candlemas, and that, having so chosen it, he shall henceforth use no other." Dr. Brentano (*On Guilds*) holds that it is wrong to represent such regulations as monopolistic, inasmuch as there was no question whatever of a monopoly at that time nor until the degeneration of the craftguilds into limited corporations of capitalists. In the regulation of trade the right of search was an important instrument. The wardens of the grocers are to "assayen weights, powders, confections, platers, oyntments, and all other things belonging to the same crafts." The goldsmiths had the assay of metals, the fishmongers the oversight of fish, the vintners of the tasting of wine, &c. The companies enforced the regulations on their members by force. Many of their ordinances looked to the domestic affairs and private conduct of the members. The grocers ordain "that no member of the fraternite take his neyghbor's house y<sup>e</sup> is of the same fraternite, or enhance the rent against the will of the foresaid neyghbor." Perjury is to be punished by the wardens and society with such correction as that other men of the fellowship may be warned thereby. Members reduced to poverty by adventures on the sea, increased price of goods, borrowing and pledging, or any other misfortune, are to be assisted "out of the common money, according to his situation, if he could not do without."

Following what appears to be the natural law of their being, the companies gradually lost their industrial character. The course of decay would seem to have been the following: The capitalists gradually assumed the lead in the various societies, and the richer members engrossed the power, and the companies tended to become hereditary and exclusive. Persons might be members who had nothing to

do with the craft, and the rise of great capitalists and the development of competition in trade made the regulation of industry by means of companies no longer possible. For an account of the "degeneration of craftguilds" a general reference may be made to Brentano *On Guilds*, c. iv. The usurpation of power on the part of the richer members was not always effected without opposition. Brentano refers to a pamphlet on the Clothworkers' Company, published in 1649, which asserts that "the commonalty" in the old charters meant, not the whole guild, but only the masters, wardens, and assistants. Herbert records a most interesting dispute in the Goldsmiths' Company in 1529. The mode of electing officers, and the system of management generally, was challenged by three members who called themselves "artificers, poor men of the craft of goldsmiths." The company, or rather the wardens, the assistants, and livery, presented a petition to the lord mayor, which was answered by the discontented craftsmen. The dispute was carried into the Court of Chancery and the Star Chamber. The artificers accused the company of subverting their grants, misappropriating the funds, and changing the constitution of the society, and they complain of this being done by the usurpation of persons who "were but merchant goldsmiths, and had but little knowledge in the science." In 1531 the three complainants were summarily expelled from the company, and then the dispute seems to have ended. In the last stage of the companies the members have ceased to have any connection with the trades, and in most cases their regulative functions have disappeared. The one characteristic which has clung to them throughout is that of owners of property and managers of charitable trusts. The connection between the companies and the municipality is shortly as follows. The ordinance of Edward II. required freemen of the city to be members of one or other of the companies. By the ordinance of 49 Edw. III. the trading companies were to nominate the members of common council, and the persons so nominated alone were to attend both at common council and at elections. An ordinance in 7 Richard II. restored the elections of common councillors to the wards, but corporate officers and representatives in Parliament were elected by a convention summoned by the lord mayor from the nominees of the companies. An Act of Common Council in 7 Edw. IV. appointed the election of mayor, sheriffs, &c., to be in the common council, together with the masters and wardens of the companies. By 15 Edw. IV. masters and wardens were ordered to associate with themselves the honest men of their mysteries, and come in their best liveries to the elections; that is to say, the franchise was restricted to the "liverymen" of the companies. At this time the corporation exercised supreme control over the companies, and the companies were still genuine associations of the traders and householders of the city. The delegation of the franchise to the liverymen was thus, in point of fact, the selection of a superior class of householders to represent the rest. When the corporation lost its control over the companies, and the members of the companies ceased to be traders and householders, the liverymen were no longer a representative class, and some change in the system became necessary. The Act 11 Geo. II. c. 18, and the Reform Acts of 1832 and 1867, reformed the representation in several particulars. The liverymen of the companies, being freemen of the city, have still, however, the exclusive power of electing the lord mayor, sheriffs, chamberlain, and other corporate officers.

The contributions made by the companies to the public purposes of the state and the city are interesting points in their early history. Their wealth and their representative character made them a most appropriate instrument for the enforcement of irregular taxation. The loan of £21,263, 6s. 8d. to Henry VIII. for his wars in Scotland, in 1544, is believed by Herbert to be the first instance of a pecuniary grant to the Crown, but the practice rapidly gained ground. The confiscation of ecclesiastical property at the time of the Reformation affected many of the trusts of the companies; and they were compelled to make returns of their property devoted to religious uses, and to pay over the rents to the Crown. In course of time the taxation of the companies became "a regular source of supply to Government." The historians of the city have for the most part described these as unjust and tyrannical exactions, but, looking at the representative and municipal character of the companies and the purposes to which their contri-

butions were applied, we may regard them as a rough but not unfair mode of taxation. The Government, when money was wanted for public works, informed the lord mayor, who apportioned the sums required among the various societies, and issued precepts for its payment. Contributions towards setting the poor to work, erecting the Royal Exchange, cleansing the city ditch, discovering new countries, furnishing military and naval armaments, for men, arms, and ammunition for the defence of the city, are among what Herbert calls the sponging expedients of the Government. The Crown occasionally interfered in a more unjustifiable manner with the companies in the exercise of their patronage. The Stuarts made strenuous efforts to get the control of the companies. Terrified by the proceedings in the *quo warranto* case, most of the companies surrendered their charters to the Crown, but such surrenders were annulled by the Act of 2 William and Mary reversing the judgment in *quo warranto* against the city. The livery companies now in existence are the following:—

Apothecaries.	Felt Makers.	Needlemakers.
Armors and Bra- siers.	Fishmongers.	Painter Stainers.
Bakers.	Fletchers.	Parish Clerks.
Barbers.	Founders.	Pattern Makers.
Basket Makers.	Framework Knitters.	Pewterers.
Blacksmiths.	Fruiters.	Plasterers.
Bowyers.	Girdlers.	Plumbers.
Brewers.	Glass-sellers.	Poulterers.
Broderers.	Glovers.	Saddlers.
Butchers.	Gold and Silver Wire-drawers.	Salts.
Carmen.	Goldsmiths.	Scriveners.
Carpenters.	Grocers.	Shipwrights.
Clockmakers.	Gunmakers.	Silkthrowers.
Clothworkers.	Haberdashers.	Skinners.
Coach and Coach- harness Makers.	Horners.	Spectacle Makers.
Cooks.	Innholders.	Stationers.
Coopers.	Ironmongers.	Tallow Chandlers.
Cordwainers.	Joiners.	Tilers and Brick- layers.
Curriers.	Leathersellers.	Tinplate Workers.
Cutlers.	Loriners.	Turners.
Distillers.	Makers of Playing Cards.	Upholsterers.
Drapers.	Masons.	Vintners.
Dyers.	Mercers.	Watermen.
Fan Makers.	Merchant Taylors.	Wax Chandlers.
Farriers.	Musicians.	Weavers.
Fellowship Porters.		Wheelwrights.
		Woolmen.

The following are the twelve great companies:—Mercers, Grocers, Drapers, Fishmongers, Goldsmiths, Skinners, Merchant Taylors, Haberdashers, Salters, Ironmongers, Vintners, Cloth-workers. The "Irish Society" was incorporated in the 11 James I. as the "governor and assistants of the new plantation in Ulster, within the realm of Ireland." The twelve companies contributed in equal portions the sum of £80,000 for the new scheme, by which it was intended to settle a Protestant colony in the lands forfeited by the Irish rebels. The companies divided the settlement into twelve nearly equal parts, assigning one to each, but the separate estates are still held to be under the paramount jurisdiction of the Irish Society. The charter of the society was revoked by the Court of Star Chamber in the reign of Charles I., but a new one was granted by Charles II., under which the society still acts.

Most of the companies administer charities of large but unascertained value. Many of them are governors of important schools, e.g., the Skinners have the Tonbridge Grammar School; the Mercers, St. Paul's School; the Merchant Taylors, the school bearing their name, &c. There is no exact information to be had as to the value of these trusts, or the manner in which they are administered. The *History of the Twelve Great Livery Companies*, by W. Herbert (London, 1837), may be referred to on this subject.

Admission to the companies is now subject to the payment of considerable fees. For example, in the Merchant Taylors the fees are—Upon taking up the freedom, by patrimony or servitude, £1, 3s. 4d., by redemption, £84; on admission to the livery, £80, 8s.; on election to the Court of Assistants, £115, 10s. The hospitality of the companies is well-known. The advantages of being a member, still more of being a liveryman or assistant, of one of the rich companies are doubtless considerable. There are indications that the position of the city companies is likely to be for some time to come the subject of political

discussion. It may be briefly said that they are being threatened on two sides—on one side by those who desire to see extensive reforms in the municipal organization of the metropolis; and on the other by those who wish to carry forward the process of inspection and revision of endowments, which has already overtaken the universities, schools, and other charities. (E. B.)

COMPARATIVE ANATOMY is the term employed to express that branch of anatomy in which the construction, form, and structure of two or more animals are compared with each other, so as to bring out their features of similarity or dissimilarity. It is sometimes used, in contrast with the term human anatomy, to signify the anatomy of the lower animals, but this is an imperfect and inexact use of the term, as the anatomy of man may be made comparative when it is examined in comparison with that of animals. The study of comparative anatomy is of especial importance to the physiologist, the embryologist, the veterinarian, and the zoologist. To the physiologist because, from the comparison of the bodies of different animals with each other, modifications in the size, form, and structure of any particular organ can be traced, and conclusions can be drawn on the importance of the function of the organ in the economy. Moreover, with a knowledge of comparative anatomy, the physiologist can conduct experiments on animals which have organs similar in structure to those of man, and determine their function more precisely than would be possible in the human body. To the veterinarian a knowledge of the comparative anatomy of the domestic animals is essential to the study of their diseases. To the embryologist, a knowledge of the anatomy of different animals throws light on the signification of the structural changes which the body of any particular animal passes through in the course of its development. To the zoologist, a knowledge not only of the external form but of the internal structure of animals is essential in order that he may frame a precise system of classification. In the present work the anatomy of the different great classes and some of the more important orders of the animal kingdom is arranged under special heads—that of the amphibia under AMPHIBIA, of birds under BIRDS, of monkeys under APES, &c. See also ANATOMY, vol. i. pp. 700 and 717.

COMPASS, THE MARINER'S, consists of three principal parts,—the card, the needle on its lower surface, and the case. The whole is enclosed in the compass-box, or binnacle. The term compass is said to have been applied to the instrument because the card involves or compasses the whole plane of the horizon, or because the needle indicates the whole circle of possible variations of direction. The surface of the card is divided by radiating lines into 32 parts, each containing  $11^{\circ} 15'$ ; these constitute the 32 points or rhumbs; the half-points and quarters are subdivisions of the same. The north pole is denoted on the card by a *flour-de-lis*; <sup>1</sup> and the line which joins the north and south poles passes through the axis of the needle. The points are named according to their proximity to the four cardinal points; for instance, the point mid-way between N. and N.E. is called north-north-east, being nearer north than east, and is marked N.N.E.; the point mid-way between N. and N.N.E. is termed north by east, and is marked N. by E. The circumference of the card is sometimes divided into 360°. The divisions of the card are shown in the following figure. The card is directed by the needle, which, with it, is pivoted on a vertical axis. With a little variation, the needle points nearly to the geographical north, and hence the mode of steering by the compass. Four or more parallel magnets, with like poles pointing in like directions, may be combined to form the needle; and by this arrangement the magnetic movement is increased for a given weight of steel. The needle is usually suspended on a central cap of ruby or agate, the point of suspension being of a similar hard material. On the inside of the compass-box is a vertical line known as lubber's point; and since this and the pivot of the card are in the same plane with the ship's keel, the point on the circumference of the card opposite to lubber's point shows the angle the ship's course makes with the magnetic meridian. The compass is kept horizontal by the use of a gimbal, or ring moving freely on an axis, within which it swings on an axis at right angles. In the azimuth compass the circumferences

<sup>1</sup> According to Mr. T. S. Davies, this may originally have been an ornamented cross.

of the card is divided into degrees and parts by a vernier, and is fitted up with sight-vanes to take amplitudes and azimuths, for the purpose of determining the variation of the compass by observation. The variation is applied to the magnetic course shown by the steering compass, and thus the true course with respect to the meridian becomes known.

The conditions that chiefly affect the use of the mariner's compass are those of the magnetic declination and deviation. The declination is the angle contained between the geographical or true and the magnetic meridian; or, as Barlowe defines it, the swerving of the pointing of the magnetical needle in the horizon from the meridian line there. The angle of declination varies according to Locality, and must be ascertained at sea by means of the

tically obviated, but in iron ships it has to be partly allowed for, partly compensated. Barlow used a correcting plate of iron to overcome the directive action on the compass due to the magnetism of wooden vessels. On Professor Airy's method, the permanent magnetism of ships is compensated by a steel magnet placed at a given distance below the compass; it is, however, liable to changes of intensity, occasioned by shocks, vibration, unequal heating, and other causes, a fact which led the late Dr. Scoresby to propose the employment of a compass aloft, out of the region of the ship's influence. The induced magnetism of ships can be only imperfectly compensated, since it varies according to the ship's bearing, and as she rolls and pitches; but corrections can be made for the heeling error. The discovery of the dip of the magnetic needle is ascribed by Gilbert to Robert Norman, a nautical instrument maker at Wapping, who, about 1590, introduced the employment of a sliding weight on the needle for the correction of the dip at different points of the earth's surface.

The earliest references to the use of the compass are to be found in Chinese history, from which we learn how, in the sixty-fourth year of the reign of Ho-ang-ti (2634 a.c.), the emperor Huan-yuan, or Ho-ang-ti, attacked one Tohi-yeou, on the plains of Tchou-lou, and finding his army embarrassed by a thick fog raised by the enemy, constructed a chariot (Tchinan) for indicating the south, so as to distinguish the four cardinal points, and was thus enabled to pursue Tohi-yeou, and take him prisoner. (Klaproth, *Lettre à M. le Baron Humboldt sur l'invention de la Boussole*, Paris, 1834. See also Mailla, *Histoire générale de la Chine*, tom. i. p. 316, Paris, 1777.) Several other allusions to the compass are contained in early Chinese records. The power of the loadstone to communicate polarity to iron is said to be for the first time explicitly mentioned in a Chinese dictionary, finished in 121 A.D., where the loadstone is defined as "a stone with which an attraction can be given to the needle." The first mention of the use of the compass for the purpose of navigation—an art that has apparently retrograded rather than advanced among the Chinese—occurs in the Chinese encyclopædia, *Po-ien-yun-fou*, in which it is stated that under the Tsin dynasty, or between 265 and 419 A.D., "there were ships directed to the south by the needle." The Chinese, Mr. Davis informs us, once navigated as far as India, but their most distant voyages at present extend not further than Java and the Malay Islands to the south (*The Chinese*, vol. iii. p. 14, London, 1844). According to an Arabic manuscript, a translation of which was published by Eusebius Renaudot (Paris, 1718), they traded in ships to the Persian Gulf and Red Sea in the 9th century. Staunton, in vol. i. of his *Embassy to China* (London, 1797), after referring to the early acquaintance of the Chinese with the property of the magnet to point southwards, remarks (p. 445), "The nature and the cause of the qualities of the magnet have at all times been subjects of contemplation among the Chinese. The Chinese name for the compass is *sin-nang-ching*, or needle pointing to the south; and a distinguishing mark is fixed on the magnet's southern pole, as in European compasses upon the northern one." "The sphere of Chinese navigation," he tells us (p. 447), "is too limited to have afforded experience and observation for forming any system of laws supposed to govern the variation of the needle. . . . The Chinese had soon occasion to perceive how much more essential the perfection of the compass was to the superior navigators of Europe, than to themselves, as the commanders of the 'Lion' and 'Hindustan,' trusting to that instrument, stood out directly from the land into the sea." The number of points of the compass, according to the Chinese, is twenty-four, which are reckoned from the south pole; the form also of the instrument they employ is different from that familiar to Europeans. The needle is peculiarly poised, with its point of suspension a little below its centre of gravity, and is exceedingly sensitive; it is seldom more than an inch in length, and is less than a line in thickness. It appears thus sufficiently evident that the Chinese are not indebted to Western nations for their knowledge of the use of the compass. "It may be urged," writes Mr. T. S. Davies, "that the different manner of constructing the needle amongst the Chinese and European navigators shows the independence of the Chinese of us, as theirs is the *worse* method, and had they copied from us, they would have used the better one" (*Thomson's British Annual*, 1837, p. 291). On the other hand, it does not seem improbable that a knowledge of the mariner's compass was communicated by them directly or indirectly to the early Arabs, and through the latter was introduced into Europe. Sismondi has remarked (*Literature of Europe*, vol. i.) that it is peculiarly characteristic of all the pretended discoveries of the Middle Ages that when the historians mention them for the first time they treat them as things in general use. Gunpowder, the compass, the Arabic numerals, and paper, are nowhere spoken of as discoveries, and yet they must have wrought a total change in war, in navigation, in science, and



FIG. 1.—Compass Card.

azimuth compass. The discovery of the variation of declination was made by Stephen Burrowes when voyaging between the north cape of Finmark and Vaigatch (Vaigates), and was afterwards determined by Gillebrand, professor of geometry at Gresham College. In 1683, in a communication to the Royal Society (*Phil. Trans.*, June 16, p. 214), Dr. E. Halley shows that the irregularity observed in the variations of the compass at sea is not due to the attraction of the land, and comes to the conclusion that the whole globe of the earth is one great magnet, having four magnetical poles or points of direction. The declination for any place is subject to secular variations: thus, at Paris in 1681, it was 2° 30' to the W., in 1865 it was 18° 44' W. Halley, in a paper entitled "Account of the Cause of the Change of the Variation of the Magnetical Needle" (*Phil. Trans.*, Oct. 19, 1692, pp. 563-578), points out, with other instances of secular variation, that between 1580 and 1692 the direction of the needle at London changed from 11° 15' E. to 6° W., or more than 17°, and demonstrates that the direction is in no place fixed or constant, though in some places it changes faster than in others. Besides the secular, there are annual and diurnal variations of small amount. The existence of the latter was discovered by Mr. Graham about 1719. The deviation of the compass is the departure of the north and south line from the magnetic meridian, owing to the magnetism of the ship itself, or that induced in it by the earth's magnetic force. It was first observed during 1772-74 by Mr. Wales, the astronomer of Captain Cook. When surveying along the coast of New Holland in 1801 and 1802, Captain Matthew Flinders made the discovery that there was a difference in the direction of the magnetic needle, according as his ship's head pointed to the E. or W.—westerly in the former, easterly in the latter case. When the ship's head was N. or S. the needle took the same direction, or nearly so, that it would on shore, and showed a variation from the true meridian which was about a medium between that given by it when east and when west. He found, also, that the error in variation was nearly proportionate to the number of points which the ship's head was from the north or south. (*Phil. Trans.*, 1805, p. 186.) The deviation in wooden ships can be prac-

in education. Tiraboschi (*Storia della Letteratura Italiana*, tom. iv. lib. ii. p. 204, et seq., ed. 2, 1788), in support of the conjecture that the compass was introduced into Europe by the Arabs, adduces their superiority in scientific learning, and their early skill in navigation. He quotes a passage on the polarity of the loadstone from a treatise translated by Albertus Magnus, attributed by the latter to Aristotle, but apparently only an Arabic compilation from the works of various philosophers. As the terms *Zoron* and *Aphron*, used there to signify the south and north poles, are neither Latin nor Greek, Tiraboschi suggests that they may be of Arabian origin, and that the whole passage concerning the loadstone may have been added to the original treatise by the Arabian translators.

Dr. W. Robertson asserts (*Historical Disquisition concerning Ancient India*, p. 227) that the Arabs, Turks, and Persians have no original name for the compass, it being called by them *Bussola*, the Italian name, which shows that the thing signified is foreign to them as well as the word. The Rev. G. P. Badger has, however, pointed out (*Travels of Ludovico di Varthema*, trans. J. W. Jones, ed. G. P. Badger, Hakluyt Soc., 1863, note, pp. 31 and 32) that the name of Bushla or Busba, from the Italian *Bussola*, though common among Arab sailors in the Mediterranean, is very seldom used in the Eastern seas.—*Dabrah* and *Beit el-Ibrah* (the Circle, or House of the Needle) being the ordinary appellatives in the Red Sea, whilst in the Persian Gulf *Kiblah-nâmeh* is in more general use. Robertson quotes Sir J. Chardin as boldly asserting "that the Asiatics are beholden to us for this wonderful instrument, which they had from Europe a long time before the Portuguese conquests. For, first, their compasses are exactly like ours, and they buy them of Europeans as much as they can, scarce daring to meddle with their needles themselves. Secondly, it is certain that the old navigators only coasted it along, which I impute to their want of this instrument to guide and instruct them in the middle of the ocean. . . . I have nothing but argument to offer touching this matter, having never met with any person in Persia or the Indies to inform me when the compass was first known among them, though I made inquiry of the most learned men in both countries. I have sailed from the Indies to Persia in Indian ships, when no European has been aboard but myself. The pilots were all Indians, and they used the forestaff and quadrant for their observations. These instruments they have from us, and made by our artists, and they do not in the least vary from ours, except that the characters are Arabic. The Arabs are the most skillful navigators of all the Asiatics or Africans; but neither they nor the Indians make use of charts, and they do not much want them; some they have, but they are copied from ours, for they are altogether ignorant of perspective." The observations of Chardin, who flourished between 1643 and 1713, cannot be said to receive support from the testimony of some earlier authorities. That the Arabs must have been acquainted with the compass, and with the construction and use of charts, at a period nearly two centuries previous to Chardin's first voyage to the East, may be gathered from the description given by Barros of a map of all the coast of India, shown to Vasco da Gama by a Moor of Guzerat (about the 15th July, 1498), in which the bearings were laid down "after the manner of the Moors," or "with meridians and parallels very small (or close together), without other bearings of the compass; because, as the squares of these meridians and parallels were very small, the coast was laid down by these two bearings of N. and S., and E. and W., with great certainty, without that multiplication of bearings of the points of the compass usual in our maps, which serves as the root of the others." Further, we learn from Osorio that the Arabs at the time of Gama "were instructed in so many of the arts of navigation, that they did not yield much to the Portuguese mariners in the science and practice of maritime matters." (See *The Three Voyages of Vasco da Gama*, Hakluyt Soc., 1869; note to chap. xv. by the Hon. H. E. J. Stanley, p. 138.) Also the Arabs that navigated the Red Sea at the same period are shown by Varthema to have used the mariner's chart and compass (*Travels*, p. 31).

Again, it appears that compasses of a primitive description, which can hardly be supposed to have been brought from Europe, were employed in the East Indies certainly as early as several years previous to the close of the 16th century. In William Barlowe's *Navigators' Supply*, published in 1597, we read:—"Some few yeeres since, it so fell out that I had several conferences with two East Indians which were brought into England by master Candish [Thomas Cavendish], and had learned our language: The one of them was of Mamilia [Manilla] in the Isle of Luzon, the other of Misao in Japan. I questioned with them concerning their shipping and manner of sayling. They described all things farre different from ours, and shewed, that in steade of our Compass, they use a magnetically needle of sixe ynches long, and longer, upon a pinne in a dish of white China earth filled with water; In the bottomme whereof they have two crosse lines, for the foure principall windes; the rest of the divisions being reserved to the skill of their Pilots." Bailak Kibdjaki, also, an Arabian writer, shows in his *Merchant's*

*Treasure*, a work given to the world in 1282, that the magnetised needle, floated on water by means of a splinter of wood or a reed, was employed on the Syrian seas at the time of his voyage from Tripoli to Alexandria (1242), and adds:—"They say that the captains who navigate the Indian seas use, instead of the needle and splinter, a sort of fish made out of hollow iron, which, when thrown into the water, swims upon the surface, and points out the north and south with its head and tail" (Klaproth, *Lettre*, p. 57). Furthermore, although the sailors in the Indian vessels in which Niccola de' Conti traversed the Indian seas in 1420, are said to have had no compass, still, on board the ship in which Varthema, less than a century later, sailed from Borneo to Java, both the mariner's chart and compass were used; it has been questioned, however, whether in this case the compass was of Eastern manufacture (*Travels of Varthema*, Intro. xciv., and p. 249). We have already seen that the Chinese as late as the end of the 18th century made voyages with compasses on which but little reliance could be placed; and it may perhaps be assumed that the compasses early used in the East were mostly too imperfect to be of much assistance to navigators, and were therefore often dispensed with on customary routes. The simple water-compass is said to have been used by the Coreans so late as the middle of the 18th century; and Dr. T. Smith, writing in the *Philosophical Transactions* for 1683-4, says of the Turks (p. 439), "They have no genius for Sea-voyages, and consequently are very raw and unexperienced in the art of Navigation, scarce venturing to sail out of sight of land. I speak of the natural Turks, who trade either into the black Sea or some part of the Morea, or between Constantinople and Alexandria, and not of the Pyrats of Barbary, who are for the most part Renegado's, and learnt their skill in Christendom. . . . The Turkish compass consists but of 8 points, the four Cardinal and the four Collateral." That the value of the compass was thus, even in the latter part of the 17th century, so imperfectly recognized in the East may serve to explain how in earlier times that instrument, long after the first discovery of its properties, may have been generally neglected by navigators.

The Saracen geographer, Edrisi, who lived about 1100, is said by Boucher to give an account, though in a confused manner, of the polarity of the magnet (Hallam, *Mid. Ages*, vol. iii. chap. 3, part 2); but the earliest definite mention as yet known of the use of the mariner's compass in the Middle Ages occurs in a treatise entitled *De Usibus*, written by Alexander Neckam in the 12th century. He speaks there of a needle carried on board ship which being placed on a pivot, and allowed to take its own position of repose, shows mariners their course when the polar star is hidden. In another work, *De Naturis Rerum*, lib. ii. c. 89, he writes,—"Mariners at sea, when, through cloudy weather in the day which hides the sun, or through the darkness of the night, they lose the knowledge of the quarter of the world to which they are sailing, touch a needle with the magnet, which will turn round till, on its motion ceasing, its point will be directed towards the north" (W. Chappell, *Nature*, No. 348, June 15, 1876). The magnetical needle, and its suspension on a stick or straw in water, are clearly described in *La Bible Guiois*, a poem probably of the 13th century, by Guiot de Provins, wherein we are told that through the magnet (*la manette* or *Fasmanière*), an ugly brown stone to which iron turns of its own accord, mariners possess an art that cannot fail them. A needle touched by it, and floated by a stick on water, turns its point towards the pole-star, and a light being placed near the needle on dark nights, the proper course is known (*Hist. littéraire de la France*, tom. ix. p. 199; Barbasan, *Fabliaux*, tom. ii. p. 328). Cardinal Jacques de Vitry, bishop of Acon in Palestine, in his *History* (cap. 89), written about the year 1218, speaks of the magnetic needle as "most necessary for such as sail the sea;" and another French crusader, his contemporary, Vincent de Beauvais, states that the adamant (loadstone) is found in Arabia, and mentions a method of using a needle magnetized by it which is similar to that described by Kibdjaki. From quotations given by Antonio Capmany (*Questiones Criticas*) from the *De Contemplatione* of Raymond Lully, of the date 1272, it appears that the latter was well acquainted with the use of the magnet at sea; and before the middle of the 13th century Gauthier d'Espinois alludes to its polarity, as if generally known, in the lines:

"Tous autres comme l'aimant deçoit [detourne]  
L'aiguillette par force de vertu,  
A ma dame tot le mont [monde] retenue  
Qui sa beauté connoit et aperçoit."

Guido Guinizelli, a poet of the same period, writes:—"In those parts under the north are the mountains of loadstone, which give the virtue to the air of attracting iron; but because it [the loadstone] is far off, [it] wishes to have the help of a similar stone to make it [the virtue] work, and to direct the needle

<sup>1</sup> Adamas in India reperitur . . . Ferrum occultis quadam natura ad se trahit. Acus ferrea postquam adamantem contigerit, ad septentrionalem . . . semper convertitur, unde valde necessarium est navigantibus in mari.

<sup>2</sup> Sicut acus per naturam vertitur ad septentrionem dum sit tarta magnetis.—Sicut acus nautica dirigit marinarios in sua Navigatione.

towards the star."<sup>1</sup> Brunetto Latini also makes reference to the compass in his encyclopædia *Livres dou trésor*, composed about 1260; and a letter written in 1269, attributed to Peter Adsigner, shows that the declination of the needle had already been observed at that date. From Torfæus we learn that the compass, fitted into a box, was already in use among the Norwegians about the middle of the 13th century (*Hist. Rer. Norvegicarum*, iv. c. 4, p. 345, Hafnise, 1711); and it is probable that the use of the magnet at sea was known in Scotland at or shortly subsequent to that time, though King Robert, in crossing from Arran to Carrick in 1306, as Barbour, writing in 1375, informs us, "na nedill had na stane," but steered by a fire on the shore.

From the above it will have been evident that, as Barlowe remarks concerning the compass, "the lame tale of one Flavius at Amelphus, in the kingdome of Naples [Flavio Gioja of Amalphi, cir. 1307], for to have devised it, is of very slender probabilitie;" and as regards the assertion of Dr. Gilbert, of Colchester (*De Magnete*, p. 4, 1600), that Marco Polo introduced the compass into Italy from the East in 1260,<sup>2</sup> we need only quote the words of Col. Yule (*Book of Marco Polo*):—"Respecting the mariner's compass and gunpowder, I shall say nothing, as no one now, I believe, imagines Marco to have had anything to do with their introduction."

When and by whom the card was added are still matters of conjecture; but the thirty-two points or rhumbs into which it is divided were recognized at least as early as the time of Chaucer, who, in 1391, wrote, "Now is thin Orizonte departed in xxiiii parties by thi asymutz, in significacions of xxiiii parties of the world; al be it so that ship men rikne thilke parties in xxxii" (*Treatise on the Astrolobe*, ed. Skeat, Early Eng. Text Soc., Lond. 1872).

The improvement of the compass has been but a slow process. *The Libel of English Politie*, a poem of the first half of the 15th century, says with reference to Iceland (chap. x.)—

"Out of Bristowe, and costes many one,  
Men haue practised by nedle and by stone  
Thider warden within a litle while."  
Hakluyt, *Principal Navigations*, p. 201, Lond., 1599.

From this it would seem that the compasses used at that time by English mariners were of a very primitive description. Barlowe, in his treatise *Magnetical Advertisements*, printed in 1616 (p. 66), complains that "the Compassee nedle, being the most admirable and usefull instrument of the whole world, is both amongst ours and other nations for the most part, so bunglerly and absurdly contrived, as nothing more." The form he recommends for the needle is that of "a true circle, having his Axis going out beyond the circle, at each end narrow and narrower, unto a reasonable sharpe point, and being pure steels as the circle it selfe is, having in the middest a convenient receptacle to place the capitell in." In 1750 Dr. Gowan Knight found that the needles of merchant-ships were made of two pieces of steel bent in the middle and united in the shape of a rhombus, and proposed to substitute straight steel bars of small breadth, suspended edgewise, and hardened throughout. He also showed that the Chinese mode of suspending the needle conduces most to sensibility. In 1820 Prof. Barlow reported to the Admiralty that half the compasses in the Royal Navy were mere lumber, and ought to be destroyed. Since then many improved varieties of ships' compasses have been introduced, of which may be mentioned those of Pope, Preston, Walker, Dent, Stebbing, Gowland, Gray, Duchemin, and Harris. In the last the needle turns upon a point which is the centre of a doubly-curved bar of copper, fixed as a diameter to a ring of the same metal. In the Admiralty compass the bowl is of copper, the card of mica; and compound magnetic bars, as proposed by Scoresby, are employed.

The most remarkable and, as shown by trial, most satisfactory form of the compass is that patented in 1876 by Sir William Thomson (see fig. 2). The card consists of a central boss and an outer rim, both of aluminium, connected together by fine silk cords. Eight or twelve small magnets, 2 to 3 inches long, having their corresponding ends tied together by threads of equal lengths, are suspended by silk cords from the rim, to which is attached thin paper marked with the points of the compass and degrees. The concentration, in this wise, of the greater part of the weight in the rim gives a long period of free oscillation, and consequently great steadiness; and as the card of a 10-inch compass, with its suspended needle and sapphire, weighs only 178 grains, the frictional error is very slight. Owing to the smallness of the needles, a perfect correction for all latitudes of a quadrantal error of 5 or 6 degrees for a 10-inch, and of 11 or 12 degrees for a 7-inch compass can be effected by means of a couple of iron globes not more than 6 inches in

diameter, fixed on opposite sides of the binnacle. The thwartship and the fore-and-aft components of the ship's magnetic force are neutralised by two adjustable correctors placed one over the other, and so arranged that in their zero position the middle line of both is vertically under the centre of the compass. Each corrector consists of two bar magnets movable round a common horizontal axis perpendicular to their lengths. To correct the heeling error, an adjustable magnet is applied below the compass in a line through its centre perpendicular to the deck. For taking bearings, a new instrument, the azimuth mirror, is provided, whereby the image of the object reflected from a plane mirror is thrown, as in a camera lucida, on the graduated circle of the compass card, and is seen through a

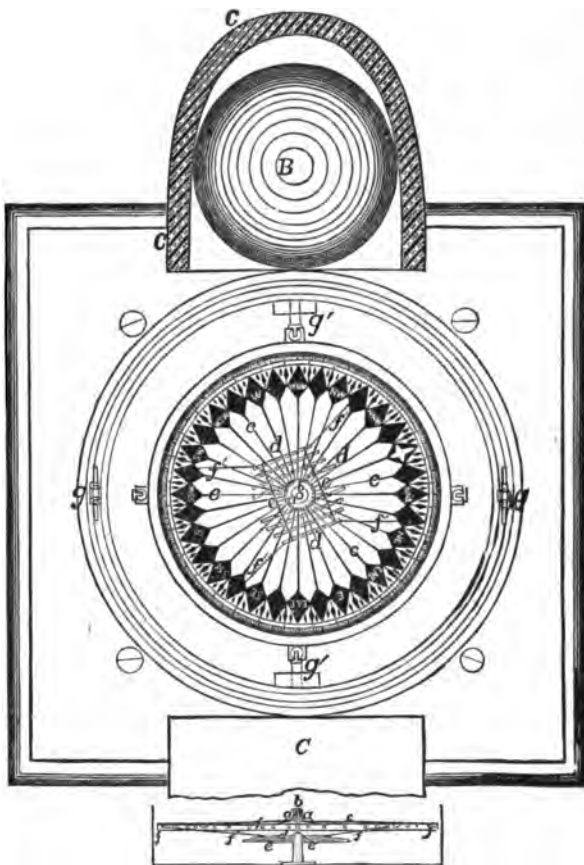

Fig. 2.—Plan and Transverse Section of Sir William Thomson's Compass-card.

B, Corrector for quadrantal error; C, Box for corrector; a, Aluminium boss; b, Central cap of sapphire; c, Cords connecting rim and boss; d, Magnets; e, Threads connecting magnets; f, Aluminium rim; g, Cords supporting magnets; g, g', Knife edges for gimbals.

convex lens. Another improvement is the use of knife edges instead of journals for supporting the gimbals. A hemispherical space below the compass-case, nearly filled with castor-oil, serves to calm the vibrations of the bowl.

See articles MAGNETISM and NAVIGATION; Cavallo, *Treatise on Magnetism*, 2d ed., Lond., 1800; Macpherson, *Annals of Commerce*, 1805; Airy, *Phil. Trans.*, 1839, and 1846, part I, and *Magnetism*, sect. x., 1870; Johnson, *On the Deviations of the Compass*, 1852; Evans, *Phil. Trans.*, 1860; Scoresby, *The Compass in Iron Ships*, 1855, &c.; Evans and Smith, *The Admiralty Manual of the Compass*; Merrifield, *Magnetism and the Deviation of the Compass*, part II., 1872; Harris, *Rud. Treat. on Magnetism*, 1872; Thomson, in *Nature*, vol. x., p. 388, 1874.

(F. H. B.)

COMPIÈGNE, a town of France, at the head of an arrondissement, in the department of Oise, situated on the left bank of the Oise, which is there crossed by a handsome bridge of three arches, 36 miles east of Beauvais, on the railway between Paris and St. Quentin, in 49° 25' 4" N. lat. and 2° 49' 35" E. long. It is famous as the occasional residence of the French kings from a very early period; and it possesses a considerable number of fine edifices.

<sup>1</sup> Gîngamé, *Hist. lit. de France*, t. I. p. 413.  
<sup>2</sup> "According to all the texts he returned to Venice in 1296, or, as is more probable, in 1298."—Yule.

Among these may be mentioned the church of St. Jacques, of the 13th century; St. Antoine, of the 15th and 16th; the town-house, a picturesque building of the late Gothic style, dating from the 16th; the theatre; and the royal palace, which is one of the most extensive and magnificent structures of the kind in France. It was erected mainly under Louis XV. and XVI., but large additions have been made in more recent times. The gardens are beautifully laid out, and in the neighborhood is the famous forest of Compiègne, which covers an area of 30,000 acres, and includes the site of the camp constructed by Cæsar in his campaign against the Bellocaci. The town is the seat of a civil and a commercial tribunal, and has a communal college, a public library, and a museum in the town-hall. The principal manufactures are hosiery, muslins, ropes, and wooden wares; and there is a fair trade in corn and wood. Population in 1872, 11,859 in the town, and 12,281 in the commune.

Compiègne, or, as it is called in the Latin chronicles, Compendium, seems originally to have been a hunting-lodge of the early Frankish kings. It was enriched by Charles the Bald with two castles, and a Benedictine abbey dedicated to Saint Cornelle, the monks of which retained down to the 18th century the privilege of acting for three days as lords of Compiègne, with full power to release prisoners, condemn the guilty, and even inflict sentence of death. It was in Compiègne that Louis the Debonnaire was deposed in 833; and at the siege of the town in 1430, Joan of Arc was taken prisoner by the English. The abbey church received the dust of Louis II., Louis V., and Hugh the Great; and for a long time it had the distinction of possessing the oldest organ in France, a gift from Constantine Copronymus to Pepin the Short. In 1624 the town gave its name to a treaty of alliance concluded by Richelieu with the Dutch; and it was in the palace that Louis XV. gave welcome to Marie Antoinette, that Napoleon I. received Marie Louise of Austria, that Louis XVIII. entertained the Emperor Alexander of Russia, and that Leopold, king of the Belgians, was married to the Princess Louise. Under Napoleon III. it was the annual resort of the court during the hunting season, and thus became the scene of many a remarkable assembly. In 1871 the town was an important post of communication between France and Germany.

COMPOSTELLA, a city of Spain in the Galician province of Coruña, more frequently called Santiago, in honor of its patron saint, St. James, whose shrine was long one of the principal places of pilgrimage in Christendom. It gives its name to one of the four military orders of Spain, which rank as follows:—Compostella, Calatrava, Alcántara, and Manresa. See SANTIAGO.

COMPTON, HENRY (1632-1713), bishop of London, was the youngest son of the earl of Northampton. After the restoration of Charles II. he became cornet in a regiment of horse, but he soon quitted the army for the church. He was made bishop of Oxford in 1674, and in the following year was translated to the see of London. He was also appointed a member of the Privy Council, and intrusted with the education of the two princesses—Mary and Anne. Compton showed a liberality most unusual at the time to Protestant dissenters, whom he wished to reunite with the established church. He held several conferences on the subject with the clergy of his diocese; and in the hope of influencing candid minds by means of the opinions of unbiassed foreigners, he obtained letters treating of the question (since printed at the end of Stillingfleet's *Unreasonableness of Separation*), from Le Moine, professor of divinity at Leyden, and the famous French Protestant divine, Claude. But to Roman Catholicism he was strongly opposed. On the accession of James II. he consequently lost his seat in the council and his deanery in the Chapel Royal; and for his firmness in refusing to suspend Dr. Sharpe, whose writings against Popery had rendered him obnoxious to the king, he was himself suspended. At the Revolution, Compton embraced the cause of William and Mary; he performed the ceremony of their coronation; his old position was restored to him; and, among other appointments, he was chosen as one of the commissioners for revising the liturgy. During the reign of Anne he remained a member of the Privy Council, and he was one of the commissioners appointed to arrange the terms of the union of England and Scotland; but, to his bitter disappointment, his claims to the primacy were twice passed over.

He published, besides several theological works, *A Translation from the Italian of the Life of Donna Olympia Maladichini*,

*who governed the Church during the time of Pope Innocent X., which was from the year 1644 to 1655 (1667), and A Translation from the French of the Jesuits' Intrigues (1669).*

COMTE, AUGUSTE, the most eminent and important of that interesting group of thinkers whom the overthrow of old institutions in France turned towards social speculation. Vastly superior as he was to men like De Maistre on the one hand, and to men like Saint Simon or Fourier on the other, as well in scientific acquisitions as in mental capacity, still the aim and interest of all his thinking was also theirs, namely, the renovation of the conditions of the social union. If, however, we classify him, not thus according to aim, but according to method, then he takes rank among men of a very different type from these. What distinguishes him in method from his contemporaries is his discernment that the social order cannot be transformed until all the theoretic conceptions that belong to it have been rehandled in a scientific spirit, and maturely gathered up into a systematic whole along with the rest of our knowledge. This presiding doctrine connects Comte with the social thinkers of the 18th century,—indirectly with Montesquieu, directly with Turgot, and more closely than either with Condorcet, of whom he was accustomed to speak as his philosophic father.

Isidore - Auguste - Marie - François - Xavier Comte was born in January, 1798, at Montpellier. Youth. where his father was a receiver-general of taxes for the district. He was sent for his earliest instruction to the school of the town, and in 1814 was admitted to the Ecole Polytechnique. His youth was marked by a constant willingness to rebel against merely official authority; to genuine excellence, whether moral or intellectual, he was always ready to pay unbounded deference. That strenuous application which was one of his most remarkable gifts in manhood showed itself in his youth, and his application was backed or inspired by superior intelligence and aptness. After he had been two years at the Ecole Polytechnique he took a foremost part in a mutinous demonstration against one of the masters; the school was broken up, and Comte like the other scholars was sent home. To the great dissatisfaction of his parents, he resolved to return to Paris (1816), and to earn his living there by giving lessons in mathematics. Benjamin Franklin was the youth's idol at this moment. "I seek to imitate the modern Socrates," he wrote to a school friend, "not in talents, but in way of living. You know that at five and twenty he formed the design of becoming perfectly wise, and that he fulfilled his design. I have dared to undertake the same thing, though I am not yet twenty." Though Comte's character and aims were as far removed as possible from Franklin's type, neither Franklin nor any man that ever lived could surpass him in the heroic tenacity with which, in the face of a thousand obstacles, he pursued his own ideal of a vocation.

For a moment circumstances led him to think of seeking a career in America, but a friend who preceded him thither warned him of the purely practical spirit that prevailed in the new country. "If Lagrange were to come to the United States, he could only earn his livelihood by turning land surveyor." So Comte remained in Paris, living as he best could on something less than £80 a year, and hoping, when he took the trouble to break his meditations upon greater things by hopes about himself, that he might by and by obtain an appointment as mathematical master in a school. A friend procured him a situation as tutor in the house of Casimir Périer. The salary was good, but the duties were too miscellaneous, and what was still worse, there was an end of the delicious liberty of the garret. After a short experience of three weeks Comte returned to neediness and contentment. He was not altogether without the young man's appetite for pleasure; yet when he was only nineteen we find him wondering, amid the gayeties of the carnival of 1817, how a gavotte or a minuet could make people forget that thirty thousand human beings around them had barely a morsel to eat. Hardship in youth has many drawbacks, but it has the immense advantage over academic ease of making the student's interest in men real, and not merely literary.

Towards 1818 Comte became associated as friend and disciple with a man who was destined to exercise a very decisive influence upon the turn of his speculation. Henry, count of Saint Simon, was second cousin of the famous duke of Saint Simon, the friend of the Regent, and author

Influence of Saint Simon.

of the most important set of memoirs in a language that is so incomparably rich in memoirs. He was now nearly sixty, and if he had not gained a serious reputation, he had at least excited the curiosity and interest of his contemporaries by the social eccentricities of his life, by the multitude of his schemes and devices, and by the fantastic ingenuity of his political ideas. Saint Simon's most characteristic faculty was an exuberant imagination, working in the sphere of real things. Scientific discipline did nothing for him; he had never undergone it, and he never felt its value. He was an artist in social construction; and if right ideas, or the suggestion of right ideas, sometimes came into his head, about history, about human progress, about a stable polity, such ideas were not the products of trains of ordered reasoning; they were the intuitional glimpses of the poet, and consequently as they professed to be in real matter, even the right ideas were as often as not accompanied by wrong ones.

The young Comte, now twenty, was enchanted by the philosophic veteran. In after years he so far forgot himself as to write of Saint Simon as a depraved quack, and to deplore his connection with him as purely mischievous. While the connection lasted he thought very differently. Saint Simon is described as the most estimable and lovable of men, and the most delightful in his relations; he is the worthiest of philosophers. Even after the association had come to an end, and at the very moment when Comte was congratulating himself on having thrown off the yoke, he honestly admits that Saint Simon's influence has been of powerful service in his philosophic education. "I certainly," he writes to his most intimate friend, "am under great personal obligations to Saint Simon; that is to say, he helped in a powerful degree to launch me in the philosophical direction that I have now definitely marked out for myself, and that I shall follow without looking back for the rest of my life." Even if there were no such unmistakable expressions as these, the most cursory glance into Saint Simon's writings is enough to reveal the thread of connection between the ingenious visionary and the systematic thinker. We see the debt, and we also see that when it is stated at the highest possible, nothing has really been taken either from Comte's claims as a powerful original thinker, or from his immeasurable pre-eminence over Saint Simon in intellectual grasp and vigor and coherence. As high a degree of originality may be shown in transformation as in invention, as Molière and Shakespeare have proved in the region of dramatic art. In philosophy the conditions are not different. *Il faut prendre son bien où on le trouve.*

It is no detriment to Comte's fame that some of the ideas which he recombined and incorporated in a great philosophical structure had their origin in ideas that were produced almost at random in the incessant fermentation of Saint Simon's brain. Comte is in no true sense a follower of Saint Simon, but it was undoubtedly Saint Simon who launched him, to take Comte's own word, by suggesting to his strong and penetrating mind the two starting points of what grew into the Comtist system—first, that political phenomena are as capable of being grouped under laws as their phenomena; and second, that the true destination of philosophy must be social, and the true object of the thinker must be the reorganization of the moral, religious, and political systems. We can readily see what an impulse these far-reaching conceptions would give to Comte's meditations. There were conceptions of less importance than these, in which it was impossible not to feel that it was Saint Simon's wrong or imperfect idea that put his young admirer on the track to a right and perfected idea. The subject is not worthy of further discussion. That Comte would have performed some great intellectual achievement, if Saint Simon had never been born, is certain. It is hardly less certain that the great achievement which he did actually perform was originally set in motion by Saint Simon's conversation, though it was afterwards directly filiated with the fertile speculations of Turgot and Condorcet. Comte thought almost as meanly of Plato as he did of Saint Simon, and he considered Aristotle the prince of all true thinkers; yet their vital difference about Ideas did not prevent Aristotle from calling Plato master.

After six years the differences between the old and the young philosopher grew too marked for friendship. Comte began to fret under Saint Simon's pretensions to be his director. Saint Simon, on the other hand, perhaps began to feel uncomfortably conscious of the superiority of his

disciple. The occasion of the breach between them (1824) was an attempt on Saint Simon's part to print a production of Comte's as if it were in some sort connected with Saint Simon's schemes of social reorganization. Comte was never a man to quarrel by halves, and not only was the breach not repaired, but long afterwards Comte, as we have said, with painful ungraciousness took to calling the encourager of his youth by very hard names.

In 1835 Comte married. His marriage was one of those of which "magnanimity owes no account to prudence," and it did not turn out prosperously. His family were strongly Catholic and royalist, and they were outraged by his refusal to have the marriage performed other than civilly. They consented, however, to receive his wife, and the pair went on a visit to Montpellier. Madame Comte conceived a dislike to the circle she found there, and this was the too early beginning of disputes which lasted for the remainder of their union. In the year of his marriage we find Comte writing to the most intimate of his correspondents:—"I have nothing left but to concentrate my whole moral existence in my intellectual work, a precious but inadequate compensation; and so I must give up, if not the most dazzling, still the sweetest part of my happiness." We cannot help admiring the heroism which cherishes great ideas in the midst of petty miseries, and intrepidly throws all squalid interruptions into the background which is their true place. Still, we may well suppose that the sordid cares that come with want of money made a harmonious life none the more easy. Comte tried to find pupils to board with him, but only one pupil came, and he was soon sent away for lack of companions. "I would rather spend an evening," wrote the needy enthusiast, "in solving a difficult question, than in running after some empty-headed and consequential millionaire in search of a pupil." A little money was earned by an occasional article in *Le Producteur*, in which he began to expound the philosophic ideas that were now maturing in his mind. He announced a course of lectures (1826), which it was hoped would bring money as well as fame, and which were to be the first dogmatic exposition of the Positive Philosophy. A friend had said to him, "You talk too freely, your ideas are getting abroad, and other people use them without giving you the credit; put your ownership on record." The lectures were intended to do this among other things, and they attracted hearers so eminent as Humboldt the cosmologist, as Poinot the geometer, as Blainville the physiologist.

Unhappily, after the third lecture of the course, Comte had a severe attack of cerebral derangement, brought on by intense and prolonged meditation, acting on a system that was already irritated by the chagrin of domestic failure. He did not recover his health for more than a year, and as soon as convalescence set in he was seized by so profound a melancholy at the disaster which had thus overtaken him, that he threw himself into the Seine. Fortunately he was rescued, and the shock did not stay his return to mental soundness. One incident of this painful episode is worth mentioning. Lamennais, then in the height of his Catholic exaltation, persuaded Comte's mother to insist on her son being married with the religious ceremony, and as the younger Madame Comte apparently did not resist, the rite was duly performed, in spite of the fact that the unfortunate man was at the time neither more nor less than raving mad. To such shocking conspiracies against common sense and decency does ecclesiastical zealotry bring even good men like Lamennais. On the other hand, philosophic assailants of Comtism have not always resisted the temptation to recall the circumstance that its founder was once out of his mind,—an unworthy and irrelevant device, that cannot be excused even by the provocation of Comte's own occasional acerbity. As has been justly said, if Newton once suffered a cerebral attack without on that account forfeiting our veneration for the *Principia*, Comte may have suffered in the same way, and still not have forfeited our respect for what is good in the systems of Positive Philosophy and Positive Polity.

In 1828 the lectures were renewed, and in 1830 was published the first volume of the *Course of Positive Philosophy*. The sketch and ground-plan of this great undertaking had appeared in 1826. The sixth and last volume was published in 1842. The twelve years covering the publication of the first of

Marriage.

Serious illness.

Official work.

Comte's two elaborate works were years of indefatigable toil, and they were the only portion of his life in which he enjoyed a certain measure, and that a very modest measure, of material prosperity. In 1833 he was appointed examiner of the boys in the various provincial schools who aspired to enter the École Polytechnique at Paris. This and two other engagements as a teacher of mathematics secured him an income of some £400 a year. He made M. Guizot, then Louis Philippe's minister, the important proposal to establish a chair of general history of the sciences. If there are four chairs, he argued, devoted to the history of philosophy, that is to say, the minute study of all sorts of dreams and aberrations through the ages, surely there ought to be at least one to explain the formation and progress of our real knowledge? This wise suggestion, which still remains to be acted upon, was at first welcomed, according to Comte's own account, by Guizot's philosophic instinct, and then repulsed by his "metaphysical rancor."

Meanwhile Comte did his official work conscientiously, sorely as he grudged the time which it took from the execution of the great object of his thoughts. We cannot forbear to transcribe one delightful and touching trait in connection with this part of Comte's life. "I hardly know if even to you," he writes in the expansion of domestic confidence to his wife, "I dare disclose the sweet and softened feeling that comes over me when I find a young man whose examination is thoroughly satisfactory. Yes, though you may smile, the emotion would easily stir me to tears if I were not carefully on my guard." Such sympathy with youthful hope, in union with the industry and intelligence that are the only means of bringing the hope to fulfilment, shows that Comte's dry and austere manner veiled the fires of a generous social emotion. It was this which made the over-worked student take upon himself the burden of delivering every year from 1831 to 1848 a course of gratuitous lectures on astronomy for a popular audience. The social feeling that inspired this disinterested act showed itself in other ways. He suffered the penalty of imprisonment rather than serve in the national guard; his position was that though he would not take arms against the new monarchy of July, yet being a republican, he would take no oath to defend it. The only amusement that Comte permitted himself was a visit to the opera. In his youth he had been a play-goer, but he shortly came to the conclusion that tragedy is a stilted and bombastic art, and after a time comedy interested him no more than tragedy. For the opera he had a genuine passion, which he gratified as often as he could, until his means became too narrow to afford even that single relaxation.

Of his manner and personal appearance we have the following account from one who was his pupil:—"Daily, as the clock struck eight on the horologue of the Luxembourg, while the ringing hammer on the bell was yet audible, the door of my room opened, and there entered a man, short, rather stout, almost what one might call sleek, freshly shaven, without vestige of whisker or moustache. He was invariably dressed in a suit of the most spotless black as if going to a dinner party; his white neck-cloth was fresh from the laundress's hands, and his hat shining like a racer's coat. He advanced to the arm-chair prepared for him in the centre of the writing-table, laid his hat on the left hand corner; his snuff-box was deposited on the same side beside the quire of paper placed in readiness for his use, and dipping the pen twice into the ink-bottle, then bringing it to within an inch of his nose, to make sure it was properly filled, he broke silence: 'We have said that the chord AB, &c. For three quarters of an hour he continued his demonstration, making short notes as he went on, to guide the listener in repeating the problem alone; then, taking up another cahier which lay beside him, he went over the written repetition of the former lesson. He explained, corrected, or commented till the clock struck nine; then, with the little finger of the right hand brushing from his coat and waistcoat the shower of superfluous snuff which had fallen on them, he pocketed his snuff-box, and resuming his hat, he as silently as when he came in made his exit by the door which I rushed to open for him."

In 1842, as we have said, the last volume of the *Positive Philosophy* was given to the public. Instead of that contentment which we like to picture as the reward of twelve years of mer-

itorious toil devoted to the erection of a high philosophic edifice, the author of this great contribution found himself in the midst of a very sea of small troubles. And they were troubles of that uncompensated kind that harass without elevating, and waste a man's spirit without softening or enlarging it. First, the jar of temperament between Comte and his wife had become so unbearable that they separated (1842). It is not expedient for strangers to attempt to allot blame in such cases, for it is impossible for strangers to know all the deciding circumstances. We need only say that in spite of one or two disadvantageous facts in her career which do not concern the public, Madame Comte seems to have uniformly comported herself towards her husband with an honorable solicitude for his well-being. Comte made her an annual allowance, and for some years after the separation they corresponded on friendly terms. Next in the list of the vexations that greeted Comte on emerging from the long tunnel of philosophizing, was a lawsuit with his publisher. The publisher had imperceptibly inserted in the sixth volume a protest against a certain foot-note, in which Comte had used some hard words about M. Arago. Comte threw himself into the suit with an energy worthy of Voltaire, and he won it. Third, and worst of all, he had prefixed a preface to the sixth volume, in which he deliberately went out of his way to rouse the active enmity of the very men on whom depended his annual re-election to the post of examiner for the Polytechnic School. The result of this perversity was that by and by he lost the appointment, and with it one-half of his very modest income. This was the occasion of an episode, which is of more than merely personal interest.

Before 1842 Comte had been in correspondence with our distinguished countryman, J. S. MILL. Mr. Mill had been greatly impressed by Comte's philosophic ideas; he admits that his own *System of Logic* owes many valuable thoughts to Comte, and that, in the portion of that work which treats of the logic of the moral sciences, a radical improvement in the conceptions of logical method was derived from the *Positive Philosophy*. Their correspondence, which was extremely full and copious, and which we may hope will one day be made accessible to the public, turned principally upon the two great questions of the equality between men and women, and of the expediency and constitution of a sacerdotal or spiritual order. When Comte found himself straitened, he confided the entire circumstances to his English friend. As might be supposed by those who know the affectionate anxiety with which Mr. Mill regarded the welfare of any one whom he believed to be doing good work in the world, he at once took pains to have Comte's loss of income made up to him, until Comte should have had time to repair that loss by his own endeavor. Mr. Mill persuaded Grote, Molesworth, and Raikes Currie to advance the sum of £240. At the end of the year (that is, in 1845) Comte had taken no steps to enable himself to dispense with the aid of the three Englishmen. Mr. Mill applied to them again, but with the exception of Grote, who sent a small sum, they gave Comte to understand that they expected him to earn his own living. Mr. Mill had suggested to Comte that he should write articles for the English periodicals, and expressed his own willingness to translate any such articles from the French. Comte at first felt in with this plan, but he speedily surprised and disconcerted Mr. Mill by boldly taking up the position of "high moral magistrate," accusing the three defaulting contributors of a scandalous falling away from righteousness and a high mind. Mr. Mill was chilled by these pretensions; they struck him asavoring of a totally unexpected charlatantry; and the correspondence came to an end. For Comte's position in the argument one feels that there is much to be said. If you have good reason for believing that a given thinker is doing work that will destroy the official system of science or philosophy, and if you desire its destruction, then you may fairly be asked to help to provide for him the same kind of material freedom that is secured to the professors and propagators of the official system by the state or by the universities. And if it is a fine thing for a man to leave money behind him in the shape of an endowment for the support of a scientific teacher of whom he has never heard, why should it not be just as natural and as laudable to give money, while he is yet alive, to a teacher

Question of  
a subsidy.

Completion  
of *Positive  
Philosophy*.



whom he both knows and approves of? On the other hand, Grote and Molesworth might say that, for anything they could tell, they would find themselves to be helping the construction of a system of which they utterly disapproved. And, as things turned out, they would have been perfectly justified in this serious apprehension. To have done anything to make the production of the *Positive Polity* easier would have been no ground for anything but remorse to any of the three. It is just to Comte to remark that he always assumed that the contributors to the support of a thinker should be in all essentials of method and doctrine that thinker's disciples; aid from indifferent persons he counted irrational and humiliating. But is an endowment ever a blessing to the man who receives it? The question is difficult to answer generally; in Comte's case there is reason in the doubts felt by Madame Comte as to the expediency of relieving the philosopher from the necessity of being in plain and business-like relations with indifferent persons for a certain number of hours in the week. Such relations do as much as a doctrine to keep egoism within decent bounds, and they must be not only a relief, but a wholesome corrective to the tendencies of concentrated thinking on abstract subjects.

#### Money.

What finally happened was this. From 1845 to 1848 Comte lived as best he could, as well as made his wife her allowance, on an income of £200 a year. We need scarcely say that he was rigorously thrifty. His little account books of income and outlay, with every item entered down to a few hours before his death, are accurate and neat enough to have satisfied an ancient Roman householder. In 1848, through no fault of his own, his salary was reduced to £80. M. Littré and others, with Comte's approval, published an appeal for subscriptions, and on the money thus contributed Comte subsisted for the remaining nine years of his life. By 1852 the subsidy produced as much as £200 a year. It is worth noticing, after the story we have told, that Mr. Mill was one of the subscribers, and that M. Littré continued his assistance after he had been driven from Comte's society by his high pontifical airs. We are sorry not to be able to record any similar trait of magnanimity on Comte's part. His character, admirable as it is for firmness, for intensity, for inexorable will, for iron devotion to what he thought the service of mankind, yet offers few of those softening qualities that make us love good men and pity bad ones. He is of the type of Brutus or of Cato—a model of austere fixity of purpose, but ungracious, domineering, and not quite free from petty bitterness.

#### Literary method.

If you seek to place yourself in sympathy with Comte it is best to think of him only as the intellectual worker, pursuing in uncomfited obscurity the laborious and absorbing task to which he had given up his whole life. His singularly conscientious fashion of elaborating his ideas made the mental strain more intense than even so exhausting a work as the abstract exposition of the principles of positive science need have been, if he had followed a more self-indulgent plan. He did not write down a word until he had first composed the whole matter in his mind. When he had thoroughly meditated every sentence, he sat down to write, and then, such was the grip of his memory, the exact order of his thoughts came back to him as if without an effort, and he wrote down precisely what he had intended to write, without the aid of a note or a memorandum, and without check or pause. For example, he began and completed in about six weeks a chapter in the *Positive Philosophy* (vol. v. ch. 55), which would fill forty of the large pages of this *Encyclopædia*. Even if his subject had been merely narrative or descriptive, this would be a very satisfactory piece of continuous production. When we reflect that the chapter in question is not narrative, but an abstract exposition of the guiding principles of the movements of several centuries, with many threads of complex thought running along side by side all through the speculation, then the circumstances under which it was reduced to literary form are really astonishing. It is hardly possible for a critic to share the admiration expressed by some of Comte's disciples for his style. We are not so unreasonable as to blame him for failing to make his pages picturesque or thrilling; we do not want sunsets and stars and roses and ecstasies; but there is a certain standard for the most serious and abstract subjects. When compared with such philosophic writing as Hume's, Diderot's, Berkeley's, then

Comte's manner is heavy, labored, monotonous, without relief, and without light. There is now and then an energetic phrase, but as a whole the vocabulary is jejune; the sentences are overloaded; the pitch is flat. A scrupulous insistence on making his meaning clear led to an iteration of certain adjectives and adverbs, which at length deaden the effect beyond the endurance of all but the most resolute students. Only the profound and stimulating interest of much of the matter prevents one from thinking of Rivarol's ill-natured remark upon Condorcet, that he wrote with opium on a page of lead. The general effect is impressive, not by any virtues of style, for we do not discern one, but by reason of the magnitude and importance of the undertaking, and the visible conscientiousness and the grasp with which it is executed. It is by sheer strength of thought, by the vigorous perspicacity with which he strikes the lines of cleavage of his subject, that he makes his way into the mind of the reader; in the presence of gifts of this power we need not quarrel with an ungainly style.

Comte pursued one practice which ought to be mentioned in connection with his personal history, the practice of what he styled *hygiène cérébrale*. After he had acquired what he considered to be a sufficient stock of material, and this happened before he had completed the *Positive Philosophy*, he abstained deliberately and scrupulously from reading newspapers, reviews, scientific transactions, and everything else whatever, except two or three poets (notably Dante) and the *Imitatio Christi*. It is true that his friends kept him informed of what was going on in the scientific world. Still this partial divorce of himself from the record of the social and scientific activity of his time, though it may save a thinker from the deplorable evils of dispersion, moral and intellectual, accounts in no small measure for the exaggerated egoism, and the absence of all feeling for reality, which marked Comte's later days.

One important incident in Comte's life now remains to be spoken of. In 1845 he made the acquaintance of Madame Clotilde de Vaux, a lady whose husband had been sent to the galleys for life, and who was therefore, in all but the legal incidents of her position, a widow. Very little is known about her qualities. She wrote a little piece which Comte rated so preposterously as to talk about George Sand in the same sentence; it is in truth a flimsy performance, though it contains one or two gracious thoughts. There is true beauty in the saying—"It is unworthy of a noble nature to diffuse its pain." Madame de Vaux's letters speak well for her good sense and good feeling, and it would have been better for Comte's later work if she had survived to exert a wholesome restraint on his exaltation. Their friendship had only lasted a year when she died (1846), but the period was long enough to give her memory a supreme ascendancy in Comte's mind. Condillac, Joubert, Mill, and other eminent men have shown what the intellectual ascendancy of a woman can be. Comte was as inconsolable after Madame de Vaux's death as D'Alembert after the death of Mademoiselle L'Espinasse. Every Wednesday afternoon he made a reverential pilgrimage to her tomb, and three times every day he invoked her memory in words of passionate expansion. His disciples believe that in time the world will reverence Comte's sentiments about Clotilde de Vaux as it reveres Dante's adoration of Beatrice—a parallel that Comte himself was the first to hit upon. It is no doubt the worst kind of cynicism to make a mock in a realistic vein of any personality that has set in motion the idealizing thaumaturgy of the affections. Yet we cannot help feeling that it is a grotesque and unseemly anachronism to apply in grave prose, addressed to the whole world, those terms of saint and angel which are touching and in their place amid the trouble and passion of the great mystic poet. Only an energetic and beautiful imagination, together with a mastery of the rhythm and swell of impassioned speech, can prevent an invitation to the public to hearken to the raptures of intense personal attachment from seeming ludicrous and almost indecent. Whatever other gifts Comte may have had—and he had many of the rarest kind,—poetic imagination was not among them, any more than poetic or emotional expression was among them. His was one of those natures whose faculty of deep feeling is unhappily doomed to be inarticulate, and to pass away without the magic power of transmitting itself.

*Positive Polity.*

Comte lost no time, after the completion of his *Course of Positive Philosophy*, in proceeding with the *System of Positive Polity*, to which the earlier work was designed to be a foundation. The first volume was published in 1851, and the fourth and last in 1854. In 1848, when the political air was charged with stimulating elements, he founded the Positive Society, with the expectation that it might grow into a reunion as powerful over the new revolution as the Jacobin Club had been in the revolution of 1789. The hope was not fulfilled, but a certain number of philosophic disciples gathered round Comte, and eventually formed themselves, under the guidance of the new ideas of the latter half of his life, into a kind of church. In the years 1849, 1850, and 1851, Comte gave three courses of lectures at the Palais Royal. They were gratuitous and popular, and in them he boldly advanced the whole of his doctrine, as well as the direct and immediate pretensions of himself and his system. The third course ended in the following uncompromising terms—"In the name of the Past and of the Future, the servants of Humanity—both its philosophical and its practical servants—come forward to claim as their due the general direction of this world. Their object is to constitute at length a real Providence in all departments,—moral, intellectual, and material. Consequently they exclude once for all from political supremacy all the different servants of God—Catholic, Protestant, or Deist—as being at once behindhand, and a cause of disturbance." A few weeks after this invitation, a very different person stepped forward to constitute himself a real Providence.

In 1852 Comte published the *Catechism of Positivism*. In the preface to it he took occasion to express his approval of Louis Napoleon's *coup d'état* of the second of December,—“a fortunate crisis which has set aside the parliamentary system, and instituted a dictatorial republic.” Whatever we may think of the political sagacity of such a judgment, it is due to Comte to say that he did not expect to see his dictatorial republic transformed into a dynastic empire, and, next, that he did expect from the Man of December freedom of the press and of public meeting. His later hero was the Emperor Nicholas, “the only statesman in Christendom,” as unlucky a judgment as that which placed Dr. Francia in the Comtist Calendar.

In 1857 he was attacked by cancer, and died peaceably on the 6th of September of that year. The anniversary is always celebrated by ceremonial gatherings of his French and English followers, who then commemorate the name and the services of the founder of their religion. Comte was under sixty when he died. We cannot help reflecting that one of the worst of all the evils connected with the shortness of human life is the impatience which it breeds in some of the most ardent and enlightened minds to hurry on the execution of projects, for which neither the time nor the spirit of their author is fully ripe.

In proceeding to give an outline of Comte's system, we shall consider the *Positive Polity* as the more or less legitimate sequel of the *Positive Philosophy*, notwithstanding the deep gulf which so eminent a critic as Mr. Mill insisted upon fixing between the earlier and the later work. There may be, as we think there is, the greatest difference in their value, and the temper is not the same, nor the method. But the two are quite capable of being regarded, and for the purposes of an account of Comte's career ought to be regarded, as an integral whole. His letters when he was a young man of one-and-twenty, and before he had published a word, show how strongly present the social motive was in his mind, and in what little account he should hold his scientific works, if he did not perpetually think of their utility for the species. “I feel,” he wrote, “that such scientific reputation as I might acquire would give more value, more weight, more useful influence to my political sermons.” In 1822 he published a *Plan of the Scientific Works necessary to Reorganize Society*. In this opusculum he points out that modern society is passing through a great crisis, due to the conflict of two opposing movements,—the first, a disorganizing movement owing to the break-up of old institutions and beliefs; the second, a movement towards a definite social state, in which all means of human prosperity will receive their most complete development and which direct

*Early writings.*

application. How is this crisis to be dealt with? What are the undertakings necessary in order to pass successfully through it towards an organic state? The answer to this is that there are two series of works. The first is theoretic or spiritual, aiming at the development of a new principle of co-ordinating social relations, and the formation of the system of general ideas which are destined to guide society. The second work is practical or temporal; it settles the distribution of power, and the institutions that are most conformable to the spirit of the system which has previously been thought out in the course of the theoretic work. As the practical work depends on the conclusions of the theoretical, the latter must obviously come first in order of execution.

In 1828 this was pushed further in a most remarkable piece called *Considerations on the Spiritual Power*—the main object of which is to demonstrate the necessity of instituting a spiritual power, distinct from the temporal power and independent of it. In examining the conditions of a spiritual power proper for modern times, he indicates in so many terms the presence in his mind of a direct analogy between his proposed spiritual power and the functions of the Catholic clergy at the time of its greatest vigor and most complete independence,—that is to say, from about the middle of the 11th century until towards the end of the 13th. He refers to De Maistre's memorable book, *Du Pape*, as the most profound, accurate, and methodical account of the old spiritual organization, and starts from that as the model to be adapted to the changed intellectual and social conditions of the modern time. In the *Positive Philosophy*, again (vol. v. p. 344), he distinctly says that Catholicism, reconstituted as a system on new intellectual foundations, would finally preside over the spiritual reorganization of modern society. Much else could easily be quoted to the same effect. If unity of career, then, means that Comte from the beginning designed the institution of a spiritual power, and the systematic reorganization of life, it is difficult to deny him whatever credit that unity may be worth, and the credit is perhaps not particularly great. Even the re-adaptation of the Catholic system to a scientific doctrine was plainly in his mind thirty years before the final execution of the *Positive Polity*, though it is difficult to believe that he foresaw the religious mysticism in which the task was to land him. A great analysis was to precede a great synthesis, but it was the synthesis on which Comte's vision was centred from the first. Let us first sketch the nature of the analysis. Society is to be reorganized on the base of knowledge. What is the sum and significance of knowledge? That is the question which Comte's first masterwork professes to answer.

The *Positive Philosophy* opens with the statement of a certain law of which Comte was the discoverer, and which has always been treated both by disciples and dissidents as the key to his system. This is the Law of the Three States. It is as follows. Each of our leading conceptions, each branch of our knowledge, passes successively through three different phases; there are three different ways in which the human mind explains phenomena, each way following the other in order. These three stages are the Theological, the Metaphysical, and the Positive. Knowledge, or a branch of knowledge, is in the Theological state when it supposes the phenomena under consideration to be due to immediate volition, either in the object or in some supernatural being. In the Metaphysical state, for volition is substituted abstract force residing in the object, yet existing independently of the object; the phenomena are viewed as if apart from the bodies manifesting them; and the properties of each substance have attributed to them an existence distinct from that substance. In the Positive state, inherent volition or external volition and inherent force or abstraction personified have both disappeared from men's minds, and the explanation of a phenomena means a reference of it, by way of succession or resemblance, to some other phenomenon,—means the establishment of a relation between the given fact and some more general fact. In the Theological and Metaphysical state men seek a cause or an essence; in the Positive they are content with a law. To borrow an illustration from an able English disciple of Comte:—“Take the phenomenon of the sleep produced by opium. The Arabs are content to attribute it to the ‘will of God.’ Molière's medical student accounts for it

Law of the Three States.

Digitized by Google

by a *specific principle* contained in the opium. The modern physiologist knows that he cannot account for it at all. He can simply observe, analyze, and experiment upon the phenomena attending the action of the drug, and classify it with other agents analogous in character."—(Dr. Bridges.)

The first and greatest aim of the Positive Philosophy is to advance the study of society into the third of the three stages,—to remove social phenomena from the sphere of theological and metaphysical conceptions, and to introduce among them the same scientific observation of their laws which has given us physics, chemistry, physiology. Social physics will consist of the conditions and relations of the facts of society, and will have two departments,—one, statical, containing the laws of order; the other dynamical, containing the laws of progress. While men's minds were in the theological state, political events, for example, were explained by the will of the gods, and political authority based on divine right. In the metaphysical state of mind, then, to retain our instance, political authority was based on the sovereignty of the people, and social facts were explained by the figment of a falling away from a state of nature. When the positive method has been finally extended to society, as it has been to chemistry and physiology, these social facts will be resolved, as their ultimate analysis, into relations with one another, and instead of seeking causes in the old sense of the word, men will only examine the conditions of social existence. When that stage has been reached, not merely the greater part, but the whole, of our knowledge will be impressed with one character, the character, namely, of positivity or scientificity; and all our conceptions in every part of knowledge will be thoroughly homogeneous. The gains of such a change are enormous. The new philosophical unity will now in its turn regenerate all the elements that went to its own formation. The mind will pursue knowledge without the wasteful jar and friction of conflicting methods and mutually hostile conceptions; education will be regenerated; and society will reorganize itself on the only possible solid base—a homogeneous philosophy.

The *Positive Philosophy* has another object besides the demonstration of the necessity and propriety of a science of society. This object is to show the sciences as branches from a single trunk,—is to give to science the ensemble or spirit of generality hitherto confined to philosophy, and to give to philosophy the rigor and solidity of science. Comte's special object is a study of social physics, a science that before his advent was still to be formed; his second object is a review of the methods and leading generalities of all the positive sciences already formed, so that we may know both what system of inquiry to follow in our new science, and also where the new science will stand in relation to other knowledge.

The first step in this direction is to arrange scientific method and positive knowledge in order, and this brings us to another cardinal element in the Comtist system, the classification of the sciences. In the front of the inquiry lies one main division, that, namely, between speculative and practical knowledge. With the latter we have no concern. Speculative or theoretic knowledge is divided into abstract and concrete. The former is concerned with the laws that regulate phenomena in all conceivable cases; the latter is concerned with the application of these laws. Concrete science relates to objects or beings; abstract science to events. The former is particular or descriptive; the latter is general. Thus, physiology is an abstract science, but zoology is concrete. Chemistry is abstract, mineralogy is concrete. It is the method and knowledge of the abstract sciences that the Positive Philosophy has to reorganize in a great whole.

Comte's principle of classification is that the dependence and order of scientific study follows the dependence of the phenomena. Thus, as has been said, it represents both the objective dependence of the phenomena and the subjective dependence of our means of knowing them. The more particular and complex phenomena depend upon the simpler and more general. The latter are the more easy to study. Therefore science will begin with those attributes of objects which are most general, and pass on gradually to other attributes that are combined in greater complexity. Thus, too, each science rests on the truths of the sciences that precede it, while it adds to them the truths by which it is itself constituted.

Comte's series or hierarchy is arranged as follows:—(1) Mathematics (that is, number, geometry, and mechanics) (2) Astronomy, (3) Physics, (4) Chemistry, (5) Biology (6) Sociology. Each of the members of this series is one degree more special than the member before it, and depends upon the facts of all the members preceding it, and cannot be fully understood without them. It follows that the crowning science of the hierarchy, dealing with the phenomena of human society, will remain longest under the influence of theological dogmas and abstract figments, and will be the last to pass into the positive stage. You cannot discover the relations of the facts of human society without reference to the conditions of animal life; you cannot understand the conditions of animal life without the laws of chemistry; and so with the rest.

This arrangement of the sciences, and the Law of the Three States, are together explanatory of the course of human thought and knowledge. They are thus the double key of Comte's systematization of the philosophy of all the sciences from mathematics to physiology, and his analysis of social evolution, which is the base of sociology. Each science contributes its philosophy. The co-ordination of all these partial philosophies produces the general Positive Philosophy. "Thousands had cultivated science, and with splendid success; not one had conceived the philosophy which the sciences when organized would naturally evolve. A few had seen the necessity of extending the scientific method to all inquiries, but no one had seen how this was to be effected. . . . The Positive Philosophy is novel as a philosophy, not as a collection of truths never before suspected. Its novelty is the organization of existing elements. Its very principle implies the absorption of all that great thinkers had achieved; while incorporating their results it extended their methods. . . . What tradition brought was the results; what Comte brought was the organization of these results. He always claimed to be the founder of the Positive Philosophy. That he had every right to such a title is demonstrable to all who distinguish between the positive sciences and the philosophy which co-ordinated the truths and methods of these sciences into a doctrine."—(G. H. Lewes.)

We may interrupt our short exposition here to remark that Comte's classification of the sciences has been subjected to a vigorous criticism by Mr. Herbert Spencer. Mr. Spencer's two chief points are these:—(1) He denies that the principle of the development of the sciences is the principle of decreasing generality; he asserts that there are as many examples of the advent of a science being determined by increasing generality as by increasing speciality. (2) He holds that any grouping of the sciences in a succession gives a radically wrong idea of their genesis and their interdependence; no true filiation exists; no science develops itself in isolation; no one is independent, either logically or historically. M. Littré, by far the most eminent of the scientific followers of Comte, concedes a certain force to Mr. Spencer's objections, and makes certain secondary modifications in the hierarchy in consequence, while still cherishing his faith in the Comtist theory of the sciences. Mr. Mill, while admitting the objections as good, if Comte's arrangement pretended to be the only one possible, still holds that arrangement as tenable for the purpose with which it was devised. Mr. Lewes asserts against Mr. Spencer that the arrangement in a series is necessary, on grounds similar to those which require that the various truths constituting a science should be systematically co-ordinated, although in nature the phenomena are intermingled.

The first three volumes of the *Positive Philosophy* contain an exposition of the partial philosophies of the five sciences that precede sociology in the hierarchy. Their value has usually been placed very low by the special followers of the sciences concerned; they say that the knowledge is second-hand, is not coherent, and is too confidently taken for final. The Comtist replies that the task is philosophic, and is not to be judged by the minute accuracies of science. In these three volumes Comte took the sciences roughly as he found them. His eminence as a man of science must be measured by his only original work in that department,—the construction, namely, of the new science of society. This work is accomplished in the last three volumes of the *Positive Philosophy*, and the

The double key of Positive Philosophy.

Classification of sciences.

Criticism on Comte's classification.

second and third volumes of the *Positive Polity*. The Comtist maintains that even if these five volumes together fail in laying down correctly and finally the lines of the new science, still they are the first solution of a great problem hitherto unattempted. "Modern biology has got beyond Aristotle's conception; but in the construction of the biological science, not even the most unphilosophical biologist would fail to recognize the value of Aristotle's attempt. So for sociology. Subsequent sociologists may have conceivably to remodel the whole science, yet not the less will they recognize the merit of the first work which has facilitated their labors."—*Congreve*.

We shall now briefly describe Comte's principal conceptions in sociology, his position in respect to which is held by himself, and by others, to raise him to the level of Descartes or Leibnitz. Of course the first step was to approach the phenomena of human character and social existence with the expectation of finding them as reducible to general laws as the other phenomena of the universe, and with the hope of exploring these laws by the same instruments of observation and verification as had done such triumphant work in the case of the latter. Comte separates the collective facts of society and history from the individual phenomena of biology; then he withdraws these collective facts from the region of external volition, and places them in the region of law. The facts of history must be explained, not by providential interventions, but by referring them to conditions inherent in the successive stages of social existence. This conception makes a science of society possible. What is the method? It comprises, besides observation and experiment (which is, in fact, only the observation of abnormal social states), a certain peculiarity of verification. We begin by deducing every well-known historical situation from the series of its antecedents. Thus we acquire a body of empirical generalizations as to social phenomena, and then we connect the generalizations with the positive theory of human nature. A sociological demonstration lies in the establishment of an accordance between the conclusions of historical analysis and the preparatory conceptions of biological theory. As Mr. Mill puts it:—"If a sociological theory, collected from historical evidence, contradicts the established general laws of human nature; if (to use M. Comte's instances) it implies, in the mass of mankind, any very decided natural bent, either in a good or in a bad direction; if it supposes that the reason, in average human beings, predominates over the desires, or the disinterested desires over the personal,—we may know that history has been misinterpreted, and that the theory is false. On the other hand, if laws of social phenomena, empirically generalized from history, can, when once suggested, be affiliated to the known laws of human nature; if the direction actually taken by the developments and changes of human society, can be seen to be such as the properties of man and of his dwelling-place made antecedently probable, the empirical generalizations are raised into positive laws, and sociology becomes a science." The result of this method is an exhibition of the events of human experience in co-ordinated series that manifest their own graduated connection.

Next, as all investigation proceeds from that which is known best to that which is unknown or less well known, and as, in social states, it is the collective phenomenon that is more easy of access to the observer than its parts, therefore we must consider and pursue all the elements of a given social state together and in common. The social organization must be viewed and explored as a whole. There is a nexus between each leading group of social phenomena and other leading groups; if there is a change in one of them, that change is accompanied by a corresponding modification of all the rest. "Not only must political institutions and social manners, on the one hand, and manners and ideas, on the other, be always mutually connected; but further, this consolidated whole must be always connected by its nature with the corresponding state of the integral development of humanity, considered in all its aspects, of intellectual, moral, and physical activity."—(Comte).

Is there any one element which communicates the decisive impulse to all the rest,—any predominating agency in the course of social evolution? The answer is that all the other parts of social existence are associated with

Decisive importance of intellectual development.

and drawn along by, the contemporary condition of intellectual development. The Reason is the superior and preponderant element which settles the direction in which all the other faculties shall expand. "It is only through the more and more marked influence of the reason over the general conduct of man and of society, that the gradual march of our race has attained that regularity and persevering continuity which distinguish it so radically from the desultory and barren expansion of even the highest animal orders, which share, and with enhanced strength, the appetites, the passions, and even the primary sentiments of man." The history of intellectual development, therefore, is the key to social evolution, and the key to the history of intellectual development is the Law of the Three States.

Among other central thoughts in Comte's explanation of history are these:—The displacement of theological by positive conceptions has been accompanied by a gradual rise of an industrial régime out of the military régime;—the great permanent contribution of Catholicism was the separation which it set up between the temporal and the spiritual powers;—the progress of the race consists in the increasing preponderance of the distinctively human elements over the animal elements;—the absolute tendency of ordinary social theories will be replaced by an unflinching adherence to the relative point of view, and from this it follows that the social state, regarded as a whole, has been as perfect in each period as the co-existing condition of humanity and its environment would allow.

Historical elucidations.

The elaboration of these ideas in relation to the history of the civilization of the most advanced portion of the human race occupies two of the volumes of the *Positive Philosophy*, and has been accepted by competent persons of very different schools, as a master-piece of rich, luminous, and far-reaching suggestion. Whatever additions it may receive, and whatever corrections it may require, this analysis of social evolution will continue to be regarded as one of the great achievements of human intellect. The demand for the first of Comte's two works has gone on increasing in a significant degree. It was completed, as we have said, in 1842. A second edition was published in 1864; a third some years afterwards; and while we write (1876) a fourth is in the press. Three editions within twelve years of a work of abstract philosophy in six considerable volumes are the measure of a very striking influence. On the whole, we may suspect that no part of Comte's works has had so much to do with this marked success as his survey and review of the course of history.

Their value and popularity.

The third volume of the later work, the *Positive Polity*, treats of social dynamics, and takes us again over the ground of historic evolution. It abounds with remarks of extraordinary fertility and comprehensiveness; but it is often arbitrary; its views of the past are strained into coherence with the statical views of the preceding volume; and so far as concerns the period to which the present writer happens to have given special attention, it is usually slight and sometimes random. As it was composed in rather less than six months, and as the author honestly warns us that he has given all his attention to a more profound co-ordination, instead of working out the special explanations more fully, as he had promised, we need not be surprised if the result is disappointing to those who had mastered the corresponding portion of the *Positive Philosophy*. Comte explains the difference between his two works. In the first his "chief object was to discover and demonstrate the laws of progress, and to exhibit in one unbroken sequence the collective destinies of mankind, till then invariably regarded as a series of events wholly beyond the reach of explanation, and almost depending on arbitrary will. The present work, on the contrary, is addressed to those who are already sufficiently convinced of the certain existence of social laws, and desire only to have them reduced to a true and conclusive system."

Social dynamics in the *Positive Polity*.

What that system is it would take far more space than we can afford to sketch even in outline. All we can do is to enumerate some of its main positions. They are to be drawn not only from the *Positive Polity*, but from two other works,—the *Positivist Catechism*; a *Summary Exposition of the Universal Religion, in Twelve Dialogues between a Woman and a*

The Positivist system.

*Priest of Humanity*; and, second, *The Subjective Synthesis* (1856), which is the first and only volume of a work upon mathematics announced at the end of the *Positive Philosophy*. The system for which the *Positive Philosophy* is alleged to have been the scientific preparation contains a Polity and a Religion; a complete arrangement of life in all its aspects, giving a wider sphere to Intellect, Energy, and Feeling than could be found in any of the previous organic types,—Greek, Roman, or Catholic-feudal. Comte's immense superiority over such pre-Revolutionary utopians as the Abbé Saint Pierre, no less than over the group of post-revolutionary utopians, is especially visible in his firm grasp of the cardinal truth that the improvement of the social organism can only be effected by a moral development, and never by any changes in mere political mechanism, or any violence in the way of an artificial redistribution of wealth. A moral transformation must precede any real advance. The aim, both in public and private life, is to secure to the utmost possible extent the victory of the social feeling over self-love, or Altruism over Egoism. This is the key to the regeneration of social existence, as it is the key to that unity of individual life which makes all our energies converge freely and without wasteful friction towards a common end. What are the instruments for securing the preponderance of Altruism? Clearly they must work from the strongest element in human nature, and this element is Feeling or the Heart. Under the Catholic system the supremacy of Feeling was abused, and the Intellect was made its slave. Then followed a revolt of Intellect against Sentiment. The business of the new system will be to bring back the Intellect into a condition not of slavery, but of willing ministry to the Feelings. The sub-ordination never was, and never will be, effected

The key to social regeneration.

except by means of a religion, and a religion, to be final, must include a harmonious synthesis of all our conceptions of the external order of the universe. The characteristic basis of a religion is the existence of a Power without us, so superior to ourselves as to command the complete submission of our whole life. This basis is to be found in the Positive stage, in Humanity, past, present, and to come, conceived as the Great Being.

The Religion of Humanity.

"A deeper study of the great universal order reveals to us at length the ruling power within it of the true Great Being, whose destiny it is to bring that order continually to perfection by constantly conforming to its laws, and which thus best represents to us that system as a whole. This undeniable Providence, the supreme dispenser of our destinies, becomes in the natural course the common centre of our affections, our thoughts, and our actions. Although this Great Being evidently exceeds the utmost strength of any, even of any collective, human force, its necessary constitution and its peculiar function endow it with the truest sympathy towards all its servants. The least amongst us can and ought constantly to aspire to maintain and even to improve this Being. This natural object of all our activity, both public and private, determines the true general character of the rest of our existence, whether in feeling or in thought; which must be devoted to love, and to know, in order rightly to serve, our Providence, by a wise use of all the means which it furnishes to us. Reciprocally this continued service, while strengthening our true unity, renders us at once both happier and better."

The Great Being.

The exaltation of Humanity into the throne occupied by the Supreme Being under monotheistic systems made all the rest of Comte's construction easy enough. Utility remains the test of every institution, impulse, act; his fabric becomes substantially an arch of utilitarian propositions, with an artificial Great Being inserted at the top to keep them in their place. The Comtist system is utilitarianism crowned by a fantastic decoration. Translated into the plainest English, the position is as follows: "Society can only be regenerated by the greater subordination of politics to morals, by the moralization of capital, by the renovation of the family, by a higher conception of marriage, and so on. These ends can only be reached by a heartier development of the sympathetic instincts. The sympathetic instincts can only be developed by the Religion of Humanity." Looking at the problem in this way, even a moralist who does not expect theology to be the instrument of social revival, might still ask whether the sympathetic instincts will not necessarily be already developed to their highest point, before people will be persuaded to accept the re-

Remarks on the Religion.

ligion, which is at bottom hardly more than sympathy under a more imposing name. However that may be, the whole battle—into which we shall not enter—as to the legitimacy of Comtism as a religion turns upon this erection of Humanity into a Being. The various hypotheses, dogmas, proposals, as to the family, to capital, &c., are merely propositions measurable by considerations of utility and a balance of expediencies. Many of these proposals are of the highest interest, and many of them are actually available; but there does not seem to be one of them of an available kind, which could not equally well be approached from other sides, and even incorporated in some radically antagonistic system. Adoption, for example, as a practice for improving the happiness of families and the welfare of society, is capable of being weighed, and can in truth only be weighed, by utilitarian considerations, and has been commended by men to whom the Comtist religion is naught. The singularity of Comte's construction, and the test by which it must be tried, is the transfer of the worship and discipline of Catholicism to a system in which "the conception of God is superseded" by the abstract idea of Humanity, conceived as a kind of Personality.

And, when all is said, the invention does not help us. We have still to settle what is for the good of Humanity, and we can only do that in the old-fashioned way. There is no guidance in the conception. No effective unity can follow from it, because you can only find out the right and wrong of a given course by summing up the advantages and disadvantages, and striking a balance, and there is nothing in the Religion of Humanity to force two men to find the balance on the same side. The Comtists are no better off than other utilitarians in judging policy, events, conduct.

The particularities of the worship, its minute and truly ingenious re-adaptations of sacraments, prayers, reverent signs, down even to the invocation of a new Trinity, need not detain us. They are said, though it is not easy to believe, to have been elaborated by way of Utopia. If so, no Utopia has ever yet been presented in a style so little calculated to stir the imagination, to warm the feelings, to soothe the insurgency of the reason. It is a mistake to present a great body of hypotheses—if Comte meant them for hypotheses—in the most dogmatic and peremptory form to which language can lend itself. And there is no more extraordinary thing in the history of opinion than the perversity with which Comte has succeeded in clothing a philosophic doctrine, so intrinsically conciliatory as his, in a shape that excites so little sympathy and gives so much provocation. An enemy defined Comtism as Catholicism minus Christianity, to which an able champion retorted by calling it Catholicism plus Science. Hitherto Comte's Utopia has pleased the followers of the Catholic, just as little as those of the scientific, spirit.

The worship and discipline.

The elaborate and minute systematization of life, proper to the Religion of Humanity, is to be directed by a priesthood. The priests are to possess neither wealth nor material power; they are not to command, but to counsel; their authority is to rest on persuasion, not on force. When religion has become positive, and society industrial, then the influence of the church upon the state becomes really free and independent, which was not the case in the Middle Age. The power of the priesthood rests upon special knowledge of man and nature; but to this intellectual eminence must also be added moral power and a certain greatness of character, without which force of intellect and completeness of attainment will not receive the confidence they ought to inspire. The functions of the priesthood are of this kind:—To exercise a systematic direction over education; to hold a consultative influence over all the important acts of actual life, public and private; to arbitrate in cases of practical conflict; to preach sermons recalling those principles of generality and universal harmony which our special activities dispose us to ignore; to order the due classification of society; to perform the various ceremonies appointed by the founder of the religion. The authority of the priesthood is to rest wholly on voluntary adhesion, and there is to be perfect freedom of speech and discussion; though, by the way, we cannot forget Comte's detestable congratulations to the Czar Nicholas on the "wise vigilance" with which he kept watch over the importation of Western books.

The priesthood.

Digitized by Google

Women. From his earliest manhood Comte had been powerfully impressed by the necessity of elevating the condition of women. (See remarkable passage in his letters to M. Valat, pp. 84-7.) His friendship with Madame de Vaux had deepened the impression, and in the reconstructed society women are to play a highly important part. They are to be carefully excluded from public action, but they are to do many more important things than things political. To fit them for their functions, they are to be raised above material cares, and they are to be thoroughly educated. The family, which is so important an element of the Comtist scheme of things, exists to carry the influence of woman over man to the highest point of cultivation. Through affection she purifies the activity of man. "Superior in power of affection, more able to keep both the intellectual and the active powers in continual subordination to feeling, women are formed as the natural intermediaries between Humanity and man. The Great Being confides specially to them its moral Providence, maintaining through them the direct and constant cultivation of universal affection, in the midst of all the distractions of thought or action, which are for ever withdrawing men from its influence. . . . Besides the uniform influence of every woman on every man, to attach him to Humanity, such is the importance and the difficulty of this ministry that each of us should be placed under the special guidance of one of these angels, to answer for him, as it were, to the Great Being. This moral guardianship may assume three types,—the mother, the wife, and the daughter; each having several modifications, as shown in the concluding volume. Together they form the three simple modes of solidarity, or unity with contemporaries,—obedience, union, and protection,—as well as the three degrees of continuity between ages, by uniting us with the past, the present, and the future. In accordance with my theory of the brain, each corresponds with one of our three altruistic instincts,—veneration, attachment, and benevolence."

Conclusion. How the positive method of observation and verification of real facts has landed us in this, and much else of the same kind, is extremely hard to guess. Seriously to examine an encyclopædic system, that touches life, society, and knowledge at every point, is evidently beyond the compass of such an article as this. There is in every chapter a whole group of speculative suggestions, each of which would need a long chapter to itself to elaborate or to discuss. There is at least one biological speculation of astounding audacity, that could be examined in nothing less than a treatise. Perhaps we have said enough to show that after performing a great and real service to thought, Comte almost sacrificed his claims to gratitude by the invention of a system that, as such, and independently of detached suggestions, is markedly retrograde. But the world has strong self-protecting qualities. It will take what is available in Comte, while forgetting that in his work which is as irrational in one way as Hegel is in another.

The English reader is specially well placed for satisfying such curiosity as he may have about Comte's philosophy. Miss Martineau condensed the six volumes of the *Philosophie Positive* into two volumes of excellent English (1853); Comte himself gave them a place in the Positivist Library. The *Catechism* was translated by Dr. Congreve in 1858. The *Politique Positive* has been reproduced in English (Longmans, 1875-7) by the conscientious labor of Comte's London followers. This translation is accompanied by a careful running analysis and explanatory summary of contents, which make the work more readily intelligible than the original. For criticisms, the reader may be referred to Mr. Mill's *Auguste Comte and Positivism*; Dr. Bridges's reply to Mr. Mill, *The Unity of Comte's Life and Doctrines* (1866); Mr. Herbert Spencer's essay on the *Genesis of Science*, and pamphlet on *The Classification of the Sciences*; Professor Huxley's "Scientific Aspects of Positivism," in his *Lay Sermons*; Dr. Congreve's *Essays Political, Social, and Religious* (1874); Mr. Fiske's *Outlines of Cosmic Philosophy* (1874); Mr. Lewis's *History of Philosophy*, vol. ii. (s. no.)

COMUS (from *κῶμος*, revel, or a company of revellers) was, in the later mythology of the Greeks, the god of festive mirth. In classic mythology the personification does not exist; but Comus appears in the *Eikōtes*, or *Descriptions of Pictures*, of Philostratus, a writer of the 3d century A.D., as a winged youth, slumbering in a standing attitude, his legs crossed, his countenance flushed with wine, his head—which is sunk upon his breast—crowned with dewy

flowers, his left hand feebly grasping a hunting spear, his right an inverted torch. Ben Jonson introduces Comus, in his masque entitled *Pleasure reconciled to Virtue* (1619), as the portly jovial patron of good cheer, "First father of sauce and deviser of jelly." In the *Comus, sive Phagesiposia Cimmerica; Somnium* (1608, and at Oxford, 1634), a moral allegory by a Dutch author, Hendrik van der Putten, or Erycius Puteanus, the conception is more nearly akin to Milton's, and Comus is a being whose enticements are more disguised and delicate than those of Jonson's deity. But Milton's Comus is a creation of his own. His story is one

"Which never yet was heard in tale or song,  
From old or modern bard, in hall or bower."

Born from the loves of Bacchus and Circe, he is "much like his father, but his mother more"—a sorcerer, like her, who gives to travellers a magic draught that changes their human face into the "brutal form of some wild beast," and, hiding from them their own foul disfigurement, makes them forget all the pure ties of life, "to roll with pleasure in a sensual sty."

CONCA, SEBASTIANO (1676-1764), a painter of the Florentine school, was born at Gaeta, and studied at Naples under Francesco Solimena. In 1708, along with his brother Giovanni, who acted as his assistant, he settled at Rome, where for several years he worked in chalk only, to improve his drawing. He was patronized by the Cardinal Otoboni, who introduced him to Clement XI.; and a Jeremiah painted in the church of St. John Lateran, was rewarded by the Pope with knighthood and by the cardinal with a diamond cross. His fame grew quickly, and by and by he received the patronage of most of the crowned heads of Europe. He painted on till near the day of his death, and left behind him an immense number of pictures, mostly of a brilliant and showy kind, which are distributed among the churches of Italy. Of these the *Probatice*, or *Pool of Siloam*, in the hospital of Santa Maria della Scala at Siena, is considered the finest.

CONCAN, or KONCAN, a maritime tract of Western India, situated within the limits of the Presidency of Bombay, and extending from the Portuguese settlement of Goa on the S. to the territory of Daman, belonging to the same nation, on the N. On the E. it is bounded by the Ghâts, and on the W. by the Indian Ocean. This tract comprises the two British districts of Tannah and Ratnagiri, and may be estimated at 300 miles in length, with an average breadth of about 40. From the mountains on its eastern frontier, which in one place attain a height of 4700 feet, the surface, marked by a succession of irregular hilly spurs from the Ghâts, slopes to the westward, where the mean elevation of the coast is not more than 100 feet above the level of the sea. Several mountain streams, but none of any magnitude, traverse the country in the same direction. One of the most striking characteristics of the climate is the violence of the monsoon rains—the mean annual fall at Maháleshwar amounting to 239 inches. It is believed that the abundant moisture borne along from the Indian Ocean by this aerial current, becomes arrested and condensed by the mountain barrier of the Ghâts, and in this manner accounts for the excessive rains which deluge the Concan. The products of this country are the same as those of Malabar; and the hemp raised is said to be of a stronger quality than that grown above the Ghâts. The coast has a straight general outline, but is much broken into small bays and harbors. This, with the uninterrupted view along the shore, and the land and sea breezes, which force vessels steering along the coast to be always within sight of it, rendered this country from time immemorial the seat of piracy; and so formidable had the pirates become in the 18th century, that all ships suffered which did not receive a pass from the chiefs of the pirates. The Great Mogul maintained a fleet for the express purpose of checking them, and they were frequently attacked by the Portuguese. British commerce was protected by occasional expeditions from Bombay, commencing about 1756; but the piratical system was not finally extinguished until 1812.

According to ancient traditions, this country was inhabited by a tribe of savages, till they were conquered by the Hindus, who gave it to a tribe of Brahmans; and it was held by them until it was taken possession of by the Mahometan kings of Bijápúr. It was conquered in the 17th century by Sivájí, the

founder of the Mahratta empire. Towards the close of the same century Konaji Angria established a kingdom on this coast, extending 120 miles from Tannah to Bankat, together with the inland country as far back as the mountains. The dominion of this prince and his family over a portion of the tract continued till the line became extinct, and the territory lapsed to the paramount power. The remainder of the Concan had been already incorporated with the British dominions since the fall of the Peshwa in 1818.

CONCEPCION, a city of Chili, the capital of the province of the same name. Founded by Pedro de Valdivia, it was originally situated where the small village of Penco now stands, on the Bay of Talcahuano; but having been first pillaged and destroyed by the Araucanians, and in 1730 levelled to the ground by an earthquake, the town was removed to its present site, 36° 49' S. lat., 72° 50' W. long., in a fertile plain on the north side of the Bio-Bio, about five miles from the sea and 270 miles south-west of Santiago. In the year 1835 it was again laid in ruins by an earthquake, which so terrified the inhabitants that for a long time the place remained partly unoccupied. Afterwards, however, the streets were rebuilt, and the area occupied by the town has been greatly extended. The main streets and squares are broad and spacious; the dwelling-houses (mostly of only one floor) are among the best planned and constructed in Chili; and the cathedral, churches, and public buildings are handsome edifices. Powerful flour-mills are in the town and neighborhood, as well as immense cellars (bodegas) for the storage of wheat and wine. It is connected by rail with its two ports—Tomé and Talcahuano, and with all the important towns of the interior. Population, 19,200.

CONCLAVE. The word conclave is used to signify any company of persons gathered together in consultation; its proper meaning is any such gathering of persons *locked up together* (*con*, collective pronoun, and *clavis*, a key); and the technical meaning, which has superseded all other uses of the word, save where some other significance is specially indicated, is the meeting of the members of the Sacred College of Cardinals for the purpose of electing a Pope.

The Pope, who is simply the bishop of Rome, was originally chosen by the entire body of the people constituting the church at Rome. Gradually, and by a process of encroachment, the several steps of which are, as might be expected, very obscure, the right of nomination was confined to the clergy, the people still retaining a right of objection, exercised very much in the same manner as the forbidding bans of marriage is now exercised. The grasping tyranny of the clergy combined with the lawless turbulence of the laity, consisting no longer, as originally, of a select body of religious men, but of the entire population, to cause this participation of the laity also to fall into disuse. The next step was to allow the privilege of the vote only to the chief among the clergy—*cardinales*—the cardinal clergy, so called as the principal virtues were called cardinal virtues (see *CARDINAL*). During some centuries the emperor was understood to have a controlling voice in the election, in such sort that his approbation was necessary for the validity of it. But the practice varied much in this respect, according as the emperor was or was not strong, near at hand, or interested in the election. The history of this part of the subject is exceedingly obscure; but it is certain that at least one Pope provided that the consent of the emperor should be necessary for the election of his successor, and on the other hand that other elections were made about the same period without the emperor's participation.

It was not till many years after the right of election had been abusively confined to the cardinals, that the practice of shutting up those dignitaries for the purpose of exercising that right was resorted to. And in the earliest instances that "conclave" seems to have been an involuntary imprisonment imposed on them *ab extra*. In 1216 the Perugians constrained the nineteen cardinals who elected Honorius III. to enter into conclave the day after the death of Innocent III., who died at Perugia, keeping them imprisoned till the election should be completed. Gregory IX. was similarly elected at Rome in 1227, the cardinals having been shut up against their will by the senators and people of Rome. In 1272 Gregory X. was elected at Viterbo by seventeen cardinals, who had not only been shut up against their will, but from over whose heads the roof of the building in which the conclave was held was

removed by the citizens in order to hasten their deliberations.

This Gregory, in a council held at Lyons in 1274, promulgated a code of law for the conducting of the Papal election, comprised in fifteen rules. And these rules, though modified by subsequent pontiffs in some respects, and supplemented by a vast number of more minute regulations, remain to the present day the foundation and origin of all the law and practice of Papal elections. The text of this code is too lengthy to be given here. It may be read in the original Latin in the *Life of Gregory X.*, by Pagi, as in many other works,—the *Notes to Platina* by Panvinius, &c.;—or in English, slightly abbreviated, in a volume on the Papal conclaves by T. A. Trollope (p. 64). The substance of some of the more important provisions may be given summarily, as follows. Cardinals to go into conclave on the tenth day after the Pope's death, attended by one person only, unless in a case of evident need, when two may be permitted. Cardinals to live in conclave in common without separation between bed and bed by wall, curtain, or veil (modified by subsequent rules to the present practice of a wooden cell for each cardinal). No access to conclave to be permitted. An opening to be left for food to be passed in. No vote shall be given save in conclave. Cardinals who quit the conclave by reason of sickness cannot vote. Those who arrive after the closing of it may enter and vote. Cardinals who may have been censured or excommunicated cannot be excluded from conclave. An election can only be made by a two-thirds majority of those present. Any man, lay or ecclesiastic, not a heretic and not canonically incapacitated, may be elected Pope. No entreaties or promises to be made by one cardinal to another with a view of influencing the vote. All bargains, agreements, undertakings, even though corroborated by an oath having such an object, to be of no validity; and "let him that breaks such be deemed worthy of praise rather than of the blame of perjury."

Very many popes have sought to enforce and make yet more stringent this last all-important rule, by reiterated fulminations of excommunication *ipso facto*, in any and every case of its contravention. The most solemn forms of oath that language can devise have been prescribed. The Bulls condemning all simoniacal bargainings have been ordered to be invariably read with every circumstance of solemnity in every conclave before the business of the meeting is entered on. And the result of all these multiplied precautions, precepts, prohibitions, and menaces has been that a study of the history of the Papal conclaves leaves the student with the conviction that no election untainted by simony has ever yet been made, while in a great number of instances the simony practised in the conclave has been of the grossest, most shameless, and most overt kind.

The form of oath, as practised at the present day, which the cardinal pronounces in the act of delivering his vote, is as follows: "Testor Christum Dominum, qui me iudicaturus est, me eligere quem secundum Deum iudico eligi debere"—"I call to witness Christ our Lord, who shall be my judge, that I am electing him who before God I think ought to be elected." The words seem at first sight to have been chosen and put together with the view of rendering them as solemn and as binding on the conscience of the elector as possible. Yet a little examination of them will show that they are well adapted to afford room for a whole host of equivocations. And, in fact, volumes of subtle casuistry have been written on the exact sense of the terms of the cardinal's oath, and on the degree of literalness in which it must be assumed to be binding on the conscience; e.g., it is the opinion of conclave tacticians that an elector may often injure the final chance of success of a candidate by voting for him at those first scrutines, which are not intended really to result in any election, but are a mere exploring of the ground and trial of strength. Is an elector, then, to injure the chance of the man he deems the fittest to be elected by voting for him at such times? Again, a man may, doubtless often does, conscientiously believe himself to be the fittest man to be elected. Must he invalidate his own election by voting for himself? Or must he vote for some other, whom he does not think the fittest man? It has been asked, may a man vote for a candidate whom he does not think the fittest man, when it is clear that that candidate will be elected? The answer has been in the affirmative, "because

it is fitting that an election be made with concord and without giving rise to evil passions." In fact, it is well-nigh certain that if every elector at every scrutiny voted for the man whom he thought fittest to be elected, there could not be any election by a two-thirds majority at all,—so absolutely and necessarily a matter of compromise is every election!

The present practice is for such cardinals as are present in Rome to enter conclave on the tenth day after the Pope's death. Each cardinal finds a boarded cell constructed in the Quirinal or Vatican,—recently the Quirinal, henceforward necessarily the Vatican,—assigned to him by lot. Every morning and every evening they proceed to a scrutiny, i.e., to a solemn voting by specially prepared voting papers (which conceal the name of the voter, to be opened only in the case of an election being made at that scrutiny) in the Sistine or in the Paoline Chapel. After each scrutiny an "accessit" takes place;—i.e., after the number of the votes for each candidate has been declared, it is open to every voter to declare by a similar secret vote that he "accedes" to such or such a candidate. If no election is thus arrived at, the same process is repeated every morning and every evening, till some cardinal is found to have the requisite majority of two-thirds of those who are present, plus one, the candidate's own vote being subtracted. Thereupon the "adoration" immediately takes place, and the *Habemus Pontificem* is proclaimed "*Urbi et Orbi*." (T. A. T.)

CONCORD, a city of the United States of America, capital of New Hampshire, is situated near the centre of the State, on the Merrimack River, 42 miles N.W. of Portsmouth and 75 miles N.N.W. of Boston by railroad. It is pleasantly laid out, for the most part on the west side of the river; and its principal streets are lined with trees. The State-house, which is a handsome edifice built of granite, occupies an open space ornamented with elms and maple trees. The town contains also a city hall and three public libraries; while in the neighborhood there is the State asylum for the insane, with a farm attached for the employment of the inmates. Concord is well supplied with water, and, having both railroad and canal communication, is advantageously situated for the development of its manufactures. These consist chiefly of carriages, dry goods, leather goods, and furniture. Granite of a superior quality is also quarried in the neighborhood; and a large trade is carried on in dressed and undressed blocks. The site of the town was first occupied by settlers in 1725; it was known as Rumford until 1765, when it received its present name. It was incorporated as a city in 1853, and is now the seat of the courts formerly held in Portsmouth. Population in 1870, 12,241.

CONCORD, a town of the United States, in Middlesex county, Massachusetts, is 20 miles north-west of Boston by railroad. It is a quiet place of 2400 inhabitants, containing a good public library. The interest attached to the town arises from the prominent part its citizens took in the early Revolutionary war. It was here, on the 19th April, 1775, that the first blood was shed in the War of Independence (concurrent with the battle of Lexington), when an English detachment was driven from the town by Colonel Barrett at the head of some militia and "minutemen." A granite obelisk, 25 feet in height, was erected in 1835 on the spot where the first English soldiers fell.

CONCORDANCE, a verbal index, in which all the leading words used by an author are alphabetically arranged, with a reference to the place where each occurs. The want of such a work first made itself felt in the department of biblical interpretation, and the earliest concordances were those of the Scriptures. Hence the application of the term has been generally limited to a Biblical index. The first of these was compiled under the direction of Cardinal Hugo de St. Caro, who died about 1262. This concordance was formed from the Vulgate translation, and it is said that nearly 500 Dominican monks were employed on it. The earliest Hebrew concordance, called *The Light of the Way*, was produced by Rabbi Mordecai Nathan (1438–48), and published at Venice in 1523. This was followed by the much more complete and accurate work of Marius de Calasio, a Franciscan friar, whose concordance, based on that of Nathan, was published at Rome in 1621. Buxtorf's is the next Hebrew concordance that deserves mention—a work marked by much care and scholarship, but following the

Masoretic divisions of the Old Testament, and so less likely to be of use to the general student. It was published at Basel in 1632, and abridged by Ravius, under the title *Fount of Zion* (Berlin, 1677). In 1754, Dr. John Taylor of Norwich published his *Hebrew Concordance, Adapted to the English Bible, Disposed after the Manner of Buxtorf*. This held the first place among works of the kind, until the appearance of Dr. Julius Fürst's *Hebrew and Chaldean Concordance*. Of Greek concordances to the Septuagint, the best is that compiled by Abraham Trommius, minister of Groningen, which was published at Amsterdam in 1718. This is a work distinguished by great industry and erudition; it forms a complete index and lexicon to the Septuagint, all save the book of Daniel, which was not at that time included in the Septuagint version. Among Greek concordances to the New Testament, the principal place is held by that of Erasmus Schmid (1638), reprinted in a corrected form at Gosham in 1717. An abridged edition of this valuable work is published by Messrs. Bagster, in their *Polymicrian Series*. The first of English concordances was one to the New Testament, published at London, before 1540. The earliest concordance to the entire Bible, in English, was formed by Marbeck (London, 1550). This work is very imperfect, and refers only to chapters, not to verses. It was followed by various others, among which may be noted the *Cambridge Concordance* (1689). The *Englishman's Concordance*, designed for the use of students who are acquainted only with the vernacular, is valuable for purposes of exegesis, and the comparison of different English translations of the same Greek and Hebrew words. But all of these were thrown into the shade by the full and trustworthy work of Alexander Cruden. This is entitled *A Complete Concordance to the Holy Scriptures of the Old and New Testament*, and was published in 1737. It has been frequently re-edited, and still retains its place as an authority. Besides concordances to the entire Bible, verbal indexes to separate portions of it have been prepared. There is a *Concordance of the Proverbs of Solomon, and of his Sentences in Ecclesiastes*; a *Concordance of the Metrical Psalms and Paraphrases* (Edin., 1856), and a *Concordance of the Prayer-Book Version of the Psalms*. There is also a *Concordance of the Apocrypha*. Concordances to other works than the Scriptures are of more recent date. The very earliest is a *Concordance of Feudal Law*, compiled at the end of the 17th century. Twiss and Ayscough each prepared a concordance to the works of Shakespeare, but these were both incomplete and incorrect. Mrs. M. Cowden Clarke supplied the deficiency by her elaborate *Concordance to Shakespeare's plays*, and Mrs. H. H. Furness by her *Concordance to his Sonnets*. A *Concordance to Milton* was published in 1867. The latest works of this class are the *Concordance to the Works of Alfred Tennyson, D.C.L.*, by D. B. Brightwell (1869), and that to the works of Alex. Pope by Edwin Abbott (1875).

CONCORDAT is an agreement between the Pope, as representing the Catholic Church, and a temporal sovereign, with reference to the rights of the church within the territory of the latter. It must be borne in mind that the pretensions of Hildebrandism (1074 to 1300 A.D.) were very great; they included a power of absolving sovereigns and subjects from their oaths, a large feudal revenue collected abroad, a peculiar status for the Catholic clergy. Against these, temporal sovereigns claimed what were called *jura majestatis circa sacra*—viz., *jus advocatiae* (Schutzrecht), or the supreme patronage of the national church; *jus cavendi* (Recht der Versorge), or right of considering whether ecclesiastical regulations conflict with civil duties; and *jus inspiciendi*, or general right of superintending the morals of the church and the administration of its property. The great historical assertions of Papal supremacy were made in the Decretals:—"Venerabilem," sent in 1197 by Innocent III. to the majority of the imperial electors who had chosen Philip of Swabia; "*Ad Apostolicam*," by which Innocent IV. in 1245 deposed Frederick II. from the imperial throne on the ground of perjury, sacrilege, and heresy; "*Clericis Laicos*" and "*Unam Sanctam*" (1296 and 1302), which dealt with the taxation of church property, and laid down the principle "*oportet autem gladium esse sub gladio*." The same claims appear in the Extravagant "*De Consuetudine*" issued by John XXII. in 1322, and in the frequently published Bull "*In Cena Domini*" (1773). The Encyclical Letter "*Quanta Cura*," and relative Syllabus of 1864, and the *Constitutione "Pastor Aeternus"* of 1870, contain the latest expression by the Pope of his international functions. It



was after the empire had, by the decree of Frankfort (1838), declared that Papal confirmation and coronation were unnecessary, and the reformatory councils of Constance and Basel had increased the controlling power of the whole church, and diminished the appeals and *annates* which caused so much discontent, that pragmatic sanctions and concordats began to be used to regulate the relations between the different European powers and the Papacy. The French Pragmatic of 1268, which defended the local jurisdictions and rights of presentation, and prohibited Papal imports except for pious, rational, and urgent causes, and the Pragmatic Sanction which in 1438 at the Council of Bruges the French clergy composed in imitation of the Basel decrees, were largely modified in favor of Rome by the concordat entered into in 1510 between Francis I. and Leo X. This arrangement left the nomination of bishops with the Crown, which before had merely given a *conseil d'avis* for the election by chapter, but assigned no term within which the Pope must institute. The consequence was that whenever it suited his purpose the Pope delayed institution. After a long period of irritating dispute the French clergy, led by Le Pellier and Bossuet, in their famous declaration of 1682, formally asserted what are now called Cismontane or national church principles. Louis XIV. had considerably enlarged the Crown right of *Régale*, which included the revenues of vacant churches, but he was now (1693) ignominiously compelled to write a letter to Innocent XI., in which he undertook not to enforce the edict of 1682. The suppression of the Jesuits, in 1773, was a heavy blow to the temporal influence of Rome. It was mainly brought about by the behavior of Clement XIII. The duke of Parma had prohibited appeals from his territory to Rome in questions about the benefices of Parma, and had also republished the principle, familiar in the common law of Europe, that no Papal rescript should take effect in Parma without receiving the ducal *exequatur*. Clement then fired off the "Monitorio di Parma," excommunicating in terms of the Bull "*In Cœna*" all concerned in the Parmesan edict. The indignant reaction which followed in all the courts of Catholic Europe decided the triumph of Ganganelli and the Regalistic party, who were opposed at the Vatican by the Ultramontane party of Zelanti. Under the civil constitution which the French Church received from the Revolution, the bishops received institution from their metropolitan. In 1801 a concordat was arranged between Napoleon as first consul and Pius VII. Under this the consul nominated and the Pope appointed bishops, who were all required to swear allegiance to the republic.<sup>1</sup> The much more important matters of the verification of Bulls by *Exequatur*, *Placitum*, or Letters of *Pareatis*, the position of the delegates of the church, the effect to be given to the decrees of councils held out of France, and the *Appel comme d'Abus*, were all settled by the "Regulations of the Gallican Church," better known as the Organic Articles, with regard to which the Pope was not consulted. Shortly afterwards Napoleon, by the decree of Schönbrunn (1809), annexed the Papal dominions to France, and imprisoned the Pope at Fontainebleau, where the "false" concordat of 1813 was signed. The main provision of this was to devolve the right of institution on the metropolitan bishop, if not exercised by the Pope within six months. In 1817 the Bourbons tried to negotiate a retrograde concordat, but the attempt was fortunately frustrated. The political attitude of Guizot and Napoleon III. towards Gregory XVI. and Pius IX. was friendly, but in 1870 the Prussian victories brought to an end the French occupation of the Papal States which had begun in the intervention of 1849, and had been continuous from 1864. By the Italian statute of guarantees (13th May, 1871) personal inviolability and the honors of a sovereign are secured to the Pope. He has also a large income and several residences, and a private postal and telegraphic service; and he is allowed to receive diplomatic agents from foreign states. The same statute gives complete freedom to the church, but deprives it of coercive jurisdiction. The royal *Placet* is relinquished as unnecessary, but a stringent penal law (7th June, 1871), is directed against seditious words, writings, or acts of the clergy.

In the empire the earliest concordat is the Concordatum Calixtinum of 1122, between Henry V. and Pope Calixtus

II. The benefits of the Basel Decrees were in great measure lost by the concordat entered into in 1448 between Frederick III. and Nicholas V. The political position of the Pope was much altered by the Treaty of Westphalia, which, without his consent, and even against his protests, conceded the right to certain nations of freely exercising the Protestant religion.

Early in the 18th century the cause of the national church in Austria, and of the immediate divine right of Episcopacy, was placed on solid foundations of learning and argument by the writings of Van Espen (*Jus ecclesiasticum universum hodiernæ disciplinæ*, Cologne, 1702; *Tractatus de promulgatione legum ecclesiasticarum*). The abuses of the permanent *Nuntiatura*, maintained by the Pope, called forth the *Punctation* of the four archbishops who met at Ems, 25th August, 1786. Joseph II. had already carried out large reforms, but these episcopal resolutions recommended still further changes in the "*Rekursus ad Principem*," or proportion of appeals to Rome, the power of dispensation and of granting faculties, the administration of conventual property and charitable funds, the reservation of benefices and their transmission by inheritance, the exaction of *annates* and *pallium* money, &c. Under the decrees of Joseph II. in 1781, no Papal Bulls or rescripts were allowed to be published, except such as had received the *Placitum Regium*, and had been effected through the intervention of the imperial and royal agency at Rome. In 1850, however, both the bishops and the faithful under their charge were allowed to have recourse to the Pope in spiritual matters, and to receive the decisions of his Holiness without the previous consent of the secular authorities. With the exception of the three archbishoprics of Olmütz, Salzburg, and Breslau, where the archbishop is elected by the chapter, the practice was, on a bishopric becoming vacant, for the emperor to propose three candidates from whom the Pope selects one—a selection subsequently ratified by the emperor. The same decree of 1850, proceeding on the anti-revolutionary imperial patent of 4th March, 1849 (§ 2), permits Catholic bishops to issue admonitions and ordinances, without consent of the civil power, to decree ecclesiastical punishments which do not affect purely civil rights, to suspend and remove from ecclesiastical office, and to declare emoluments forfeited, and to control education in primary and intermediate schools and in the universities. This arrangement was sealed by the concordat of 18th August, 1855 (printed fully in *Times*, 20th November, 1855), which, however, was repealed by the series of Church Acts passed by Prince Auersperg in 1874, in imitation of the Falk legislation of Prussia.

The relations of Belgium with Rome were of course at one time determined by the decree of the French National Assembly (1791) and the concordat between Pius VII. and Napoleon (1801). On 18th June, 1827, William I., Protestant king of the Netherlands, entered into a concordat with Pope Leo XII., which confirmed and extended the provisions of the earlier concordat relating to the institution of bishops by letters apostolic. The power which the Crown then reserved of striking out objectionable names from the list of candidates prepared by the chapter was entirely renounced by the 16th Article of the Belgian Constitution of 1830, which declares that the state has no right to interfere with the nomination or installation of any religious ministers, or to prevent them from corresponding with their superiors or from publishing their Acts. But then the Government has this indirect control, that all the salaries of the Catholic clergy are voted in the annual budget, and do not belong to the church. The concordat of 1827 was never in force in Holland, where the fundamental law of 1848 (§ 65) declares that no Dutchman can accept titles without the permission of the king, and where public opinion has prevented the creation of Catholic bishops.

Spain, although the most Catholic of powers, has, at least since the accession of the Austrian dynasty, zealously defended its national church rights against the Pope. In 1568, Philip II. claimed as royal prerogative the right to present to all Spanish bishoprics, and created a Board, "*Supremo Consejo de la Camara*," to preserve the royal jurisdiction, to protect the canons, and to watch over the external policy in ecclesiastical matters. The Pope having sided with Austria in the Succession War, the breach between Spain and Rome widened during the 18th century. The principles that no causes should be carried before a judge outside the kingdom, that benefices should be

<sup>1</sup> Several bishops, who refused this oath, were driven from France, and formed in England *La Petite Eglise*, which existed for some time (see *The Guardian*, 4 Feb., 1862).

conferred only on natives, that sovereigns are not subject to interdict or spiritual censure, that all Bulls should, before publication, be subject to the royal *Cedula*, were loudly and angrily proclaimed; and in 1805 the king attacked the secret influences of the *Curia* by directing that all applications to Rome for grants and dispensation should receive the *Visto Bueno* of the royal agent at Rome. The estrangement continued in the 19th century, when till 1848 the Pope refused to recognize the succession of Isabella II. under the Pragmatic Sanction of 1830. From 1753 to 1851, matters had stood on a concordat which the eminent statesman, De Carbajal, persuaded Ferdinand VI. to negotiate with Clement XII. It gave the king the right of presentation to vacant bishoprics (patronatos) and to the Pope 22,000,000 reales as compensation for the loss of *annates* and fees on briefs. The concordats of 1851 and 1859 are more favorable to Rome; but the attempt of Canovas del Castillo and the Cardinal Simeoni to procure a recognition of the 1851 concordat, in 1875, was defeated by General Jovellar.

In non-Roman Catholic states, of course, no valid concordat could be framed. Accordingly, as in the cases of Prussia (1821) and Hanover (1824), edicts relating to the adjustment of dioceses, or other matters not purely spiritual, were issued by the Pope under the name of Bullæ Circumscriptionis. These were formerly sanctioned by the Home Government, and directed to be printed in the collection of laws.

The most important sources of information on this subject are the reports presented to Parliament in 1816 and 1851, on the "Regulation of Roman Catholic Subjects in Foreign Countries," which have been summarized in the 2d volume of Sir R. Phillimore's *Commentaries on International Law*. The works of Van Espen and the *Enchiridion Juris Ecclesiastici* of George Reohberger (1809) are standard works. The French concordats have been elaborately discussed by M. de Pradt, at one time archbishop of Malines, in *Les Quatre Concordats*, 3 vols. Brussels, 1815, and *Suite des Quatre Concordats*, 1 vol., Paris, 1820. The works of the eminent jurist Portalis, who took an active part in the discussion of the latter French concordats, may also be consulted.—*Discours, Rapports, et Travaux inédits sur le Concordat de 1801, les Articles Organiques, &c.* (W. C. S.)

CONCORDIA, the goddess of concord, a Roman divinity, in whose honor several temples were erected at Rome. The most ancient of these was that built on the declivity of the Capitol by Camillus, 367 B.C. In this temple the senate sometimes assembled. It was restored by Livia, the wife of Augustus, and consecrated by Tiberius, 9 A.D. In the time of Constantine and Maxentius it was destroyed by fire, but was again restored. The second temple was erected close to that of Vulcan by Cn. Flavius; and there was a third built by L. Manlius, on the Capitoline Hill. Concordia was represented as a matron holding in her right hand a patera, or an olive branch, and in her left a cornucopia. Her symbols were two hands joined together, and two serpents entwined about a caduceus, or herald's staff.

CONCORDIA, a village of Italy in the province of Venice, 35 miles N.E. of the city of that name, and in the immediate neighborhood of the town of Portogruaro, of importance as preserving the name and marking the site of a famous Roman city of the later empire. It was probably founded by Augustus, on the pacification of his dominions, and consequently bears the full title of Colonia Julia Concordia. Its rapidly growing prosperity, well attested even by the fragmentary remains of its buildings, was suddenly crushed by Attila in 452 A.D.; but its continued existence throughout the Middle Ages is proved both by history and by archaeology. The baptistery still extant is in the style of the 9th century, and an inscription preserves the memory of a bishop Regimpotus of the 10th. The place has been brought again into notice by the discovery, in 1873, of the old Christian cemetery which has furnished upwards of 160 stone coffins, in several cases distinguished by inscriptions of considerable import to the historian.—See *Bullettino dell' Istituto di Corr. Arch.* 1874.

CONCRETE, an artificial conglomerate or rubble masonry, consisting of a mixture of coarse pieces of stone, gravel, shingle, broken brick, or crushed slag with sand and Portland or other cement. It is employed for laying the foundations of bridges and of building on soft or wet ground, as also in the construction of moles and breakwaters, and of houses and churches; for the backing of wharves, of the abutments of arches, and of masonry gen-

erally where heavy walls are required; for the substance of fire-proof doors; for the making of sewer-pipes; and as a paving for streets and floors. It soon hardens after use, becoming a stony mass little permeated by moisture. In the shape of blocks, sometimes weighing very many tons, it has been found of great value for the formation of harbors and sea-walls in places to which stone could not have been transported. The foundations of the breakwater pier at Douglass, Isle of Man, were made by laying down concrete within frames resting on submarine rock. The quay walls of Stobcross Docks, Glasgow, are supported on triple groups of concrete cylinders, 27½ feet in length and resting on iron shoes. Each cylinder is formed by sinking in the soil a column of eleven rings of concrete; this, after being cleared of the sand and gravel it contains, is filled with Portland cement concrete. Walls are made of concrete either by allowing it to harden in mass between two faces of boarding, or by making it into blocks and building as with bricks. Concrete was employed by the Romans, by whom the term *signinum* was applied to a kind of plaster composed of powdered tiles and mortar; and Smeaton gained the idea of applying it to the construction of river-works from an inspection of the ruins of Corfe Castle in Dorsetshire, a Saxon structure. In the Middle Ages it was much used in the making of fortifications.

The composition of concrete necessarily depends to some extent upon the nature and qualities of the materials most available for making it. The *béton aggloméré* of M. F. Coignet is composed of about 180 parts of sand, 44 of slaked lime, 33 of Portland cement, and 20 of water. A mixture of the cement with the sand and lime is first made, with the addition of small quantities of water; the mass is then incorporated with the requisite amount of water in a cylindrical machine, from the bottom of which it is delivered ready for compression in moulds. This composition can be formed into blocks of any desired bulk; and these, after exposure to the weather for a few weeks, acquire a hardness equal to that of good building stone. A good concrete can be made from 60 parts of coarse pebbles, 25 of rough sand, and 15 of lime. Sempie recommends a mixture of 8 parts of pebbles, 4 of sharp river sand, and 1 of lime. The proportions given by Treussart are unslaked hydraulic lime 30 parts by measure, trass of Andernach 30, sand 30, gravel 20, broken stone or hard limestone 40 parts; and for another concrete, hydraulic lime 33 parts, pozzuolana 45, sand 22, broken stone and gravel 60 parts; the former is used as soon as made, the latter should be exposed about 12 hours after preparation. Burnt clay and pounded brick may be used in the same proportions as the trass, but are best not employed in sea-water. The quantity of natural or artificial pozzuolanas is increased, and that of the gravel or stone decreased, if rich limes are used (Burnell, *Limes, &c.*). Excellent concrete is made from Thames or other river ballast mingled with ¼th or ⅓th its bulk of lime; in setting it contracts about one-fifth of its volume, a cubic yard of the concrete requiring 30 cubic feet of ballast and 3½ cubic feet of lime. Hydraulic concrete must contain a sufficiency of mortar to aggregate the whole mass of rubbly material, and the lime or cement should be thoroughly slaked before the immersion of the concrete. For the breakwater at Dover Mr. Lee employed 16 foot cubes of concrete made in moulds, composed of Portland cement, Portland stone chippings, sand, and shingle. The blocks at the mole, Marseilles, were formed from 5 parts of sand, 2 of broken stone, and 3 of Theil lime. The concrete used at the extension of the London docks consisted of 1 part of blue Lias lime to 6 of gravel and sand; and that made by M. Vicat for the bridge at Souillac, on the Dordogne, contained, with 26 parts of hydraulic lime, 39 of granitic sand, and 66 of gravel. The composition for the Copenhagen sea-forts was 1 part of Portland cement, 4 of sand, and 16 of fragments of stone.

Austin's artificial stone is a concrete of sand and other materials cemented by lime. Ransome's concrete stone is made by subjecting a mixture of sodium silicate and clean pit sand, to which between 5 and 10 per cent. of chalk has been added, to the action of a solution of calcium chloride, whereby insoluble calcium silicate and soluble sodium chloride, or common salt, are produced, the former acting as a cementing material for the particles of sand. The stone is made non-absorbent by giving the face of it a wash with sodium silicate, and then a second application of the

calcium chloride. (See H. Reid, *A Practical Treatise on Concrete*, London, 1869.)

**CONCUBINAGE**, the state of a man and woman cohabiting as married persons without the sanction of a legal marriage. In a scriptural sense, it denotes cohabiting lawfully with a wife of second rank, who enjoyed no other conjugal right but that of cohabitation, and whom the husband could repudiate and dismiss with a small present (Gen. xxi.). In like manner he could, by means of presents, exclude his children by her from the heritage (Gen. xxv.). To judge from the conjugal histories of Abraham and Jacob, the immediate cause of concubinage was the barrenness of the lawful wife, who in that case introduced her maid-servant to her husband, for the sake of having children. This resembles the singular practice authorized not only in Israel (Deut. xxv.), and anciently in Athens and Sparta, but by the laws of Menu, that a brother, or some other person, should be substituted when the married couple had been unable to produce offspring. In process of time, however, concubinage appears to have degenerated into a regular custom among the Jews; and the institutions of Moses were directed to prevent excess and abuse in that respect.

The Roman *concubinatus* differed from *justas nuptias* in not giving the father the *potestas* over his children, and from *contubernium*, which was the concubinage of slaves. It was a permanent monogamous relation, free from some of the restrictions imposed by the civil law upon marriages. Although the married woman had a more dignified position, concubinage was thought the appropriate union for persons of different ranks, as *patronus* and *liberta*. By imperial legislation, *naturales liberi* and concubines were gradually admitted to limited rights of succession; and the legitimation *per subsequens matrimonium* completed their status.

Concubinage is also used to signify a marriage with a woman of inferior condition, to whom the husband does not convey his rank. Such concubinage was beneath marriage both as to dignity and civil rights, yet concubine was a reputable title, and very different from that of "mistress" among us. The concubine also might be accused of adultery in the same manner as a wife. By French law the presence of a concubine in the house entitles the wife to a divorce. This kind of concubinage is still in use in some countries, particularly in Germany, under the title of *halbehe* (half-marriage), or left-hand marriage, in allusion to the manner of its being contracted, namely, by the man giving the woman his left hand instead of the right. This is a real marriage, though without the usual solemnity; and the parties are both bound to each other for ever, though the female cannot bear the husband's name and title. Neither spouse has any right of succession to the other, but the children take a third of the father's estate, if he leaves no lawful children.

Du Cange observes that one may gather from several passages in the epistles of the popes that they anciently allowed of such connections. The seventeenth canon of the first Council of Toledo (400 A.D.) declares that he who with a faithful wife keeps a concubine is excommunicated; but that if the concubine serve him as a wife, so that he has only one woman, under the title of concubine, he shall not be rejected from communion. This applied not only to laymen, but to inferior priests, who were then allowed to marry. The latter councils extend the name concubine to disreputable women not kept in the house. That is also the meaning of the word in the 8th rubric of the concordat of 1517 between Leo X. and Francis I. The Council of Nicea refers to a class of secret concubines, *superinductæ*, and St. Augustine denounces all irregular relations.

It is certain the patriarchs had a great number of wives, and that these did not all hold the same rank,—some being inferior to the principal wife. Solomon had 700 wives and 300 concubines. Q. Curtius observes that Darius was followed in his army by 365 concubines, all in the equipage of queens.

In most Mahometan and other polygamous countries, female slaves are used as concubines and enjoy a certain status. Under the ancient *Fueros*, which succeeded the *Lex Visigothorum* in Spain, concubinage was recognized by the name of *barragania*. The parties entered into a contract (*costa de manebria e campanera*), by which the man took the concubine *por todos los dios que yo vis-*

*quiere*, and she received right to bread, table, and knife (*a pan, mesa, e cuchello*). Apart from contract, some *Fueros* gave the faithful concubine a right of succession to one-half of the man's acquired property. The Council of Valladolid (1228) reprobated the *barragania* of priests. Similarly the *Gragas*, or ancient law of Iceland, recognized the *frilla*, or concubine, alongside of the *hufreyria*, or lawful wife, though the two were not permitted to dwell in the same house. According to the Danish *hand vesten*, the concubine who had publicly lived with a man and partaken his meals for three winters became a lawful wife. The Celtic handfast marriage may also be referred to. (W. C. S.)

**CONDAMINE**, CHARLES MARIE DE LA. See LA CONDAMINE.

**CONDÉ**, a town of France, in the department of Nord, arrondissement of Valenciennes, is situated at the confluence of the Scheldt and the Haine, and at the terminus of the Mons canal, two miles from the Belgian frontier. It contains a hotel de ville and an arsenal, a church and a hospital. Brewing is carried on to a small extent, as well as the manufacture of oil and salt, and there is a large trade in coal. The place is of considerable antiquity, dating at least from the later Roman period. Taken in 1676 by Louis XIV., it definitely passed into the possession of France by the Treaty of Nimeguen two years later, and was afterwards fortified by Vauban. During the revolutionary war it was attacked and taken by the Austrians (1794); and in 1815 it again fell to the Allies. Condé gives its name to a distinguished branch of the Bourbon family. Population of the town in 1872, 3748; of the commune, 4964.

**CONDÉ SUR NOIREAU**, a town of France, in the department of Calvados, and arrondissement of Vire, is situated at the confluence of the Noireau and the Drouance, 28 miles south of Caen. The town is the seat of a civil tribunal, and its manufactures are not unimportant, comprising cotton and woollen weaving, dyeing, and tanning. The two old churches of St. Sauveur and St. Martin are worthy of remark, the latter possessing a very fine stained-glass window representing our Lord's Passion. A statue has been erected here to Dumont d'Urville, the traveller, a native of the town. Condé formerly belonged to the countship of Mortain; and it owes its origin to a fort which is said to have been constructed by the Romans. It fell into the hands of the English in 1418, but was retaken by Charles VII. in 1449. Much interest was shown by the inhabitants in the Reformation movement, and a provincial synod was held in the town in 1674. At the Revolution it lost its name of Condé, and during that period was known only as Noireau. Population of the town in 1872, 6445.

**CONDÉ, PRINCES OF.** The title of prince of Condé (assumed from the ancient town of Condé, noticed above) was borne by a branch of the House of Bourbon. The first who assumed it was the famous Huguenot leader, Louis de Bourbon, the fifth son of Charles de Bourbon, duke of Vendôme (see next article). His son, Henry, prince of Condé (1552-1588), also belonged to the Huguenot party. Fleeing to Germany, he raised a small army, with which in 1575 he joined Alençon. He became leader of the Huguenots, but after several years' fighting was taken prisoner of war. Not long after he died of poison, administered, according to the belief of his contemporaries, by his wife, Catherine de la Trémouille. This event, among others, awoke strong suspicions as to the legitimacy of his heir and namesake, Henry, prince of Condé (1588-1646). King Henry IV., however, did not take advantage of the scandal. In 1609 he caused the prince of Condé to marry Charlotte de Montmorency, whom shortly after Condé was obliged to save from the king's persistent gallantry by a hasty flight, first to Spain and then to Italy. On the death of Henry, Condé returned to France, and intrigued against the regent, Mary de Medici; but he was seized, and imprisoned for three years: There was at that time before the court a plea for his divorce from his wife, but she now devoted herself to enliven his captivity at the cost of her own liberty. During the rest of his life Condé was a faithful servant of the king. He strove to blot out the memory of the Huguenot connections of his house by affecting the greatest zeal against Protestants. His old ambition changed into a desire for the safe aggrandizement of his family, which he magnificently achieved, and with that end he bowed before

Richeüeu, whose niece he forced his son to marry. His son Louis, the great Condé, is separately noticed below. The next in succession was Henry Jules, prince of Condé (1643-1709), the son of the great Condé and of Clémence de Maillé, niece of Richelieu. He fought with distinction under his father in Franche-Comté and the Low Countries; but he was heartless, avaricious, and undoubtedly insane. The end of his life was marked by singular hypochondriacal fancies. He believed at one time that he was dead, and refused to eat till some of his attendants dressed in sheets set him the example. His grandson, Louis Henry, duke of Bourbon (1692-1740), who did not assume the title of prince of Condé which belonged to him, was member of the council of regency which ruled during the minority of Louis XV., and first minister from the death of the duke of Orleans in 1723 to 1726, when he was superseded by Cardinal de Fleury. He greatly enriched his family and his mistress, De Prie, by taking every advantage of his position; but he made himself unpopular by the weight of taxes which he imposed. The son of the Duke of Bourbon, Louis Joseph, prince of Condé (1736-1818), after receiving a good education, distinguished himself in the Seven Years' War, and most of all by his victory at Johannisberg. As governor of Burgundy he did much to improve the industries and means of communication of that province. At the Revolution he took up arms in behalf of the king, became commander of the "army of Condé," and fought in conjunction with the Austrians till the peace of Campo Formio in 1797, being during the last year in the pay of England. He then served the emperor of Russia in Poland, and after that (1800) returned into the pay of England, and fought in Bavaria. In 1800 Condé arrived in England, where he resided for several years. On the restoration of Louis XVIII. he returned to France. He died in Paris 1818. He wrote *Essai sur la Vie du grand Condé* (1798).

See *L'Histoire de l'Armée de Condé*, by Muret; *Vie de Louis Joseph, prince de Condé*, by Chamballand; *Histoire des trois derniers princes de la maison de Condé*, by Créteineau-Joly; and *Histoire de la maison de Condé*, by the Duc d'Aumale (translated by R. B. Borthwick, 1872).

CONDÉ, LOUIS DE BOURBON, PRINCE OF (1530-1569), fifth son of Charles de Bourbon, duke of Vendôme, younger brother of Anthony, king of Navarre, was the first of the famous House of Condé. Brave though deformed, gay, but extremely poor for his rank, Condé was led by his ambition to a military career. He fought with distinction in Piedmont under Marshal de Brissac; in 1552 he forced his way with reinforcements into Metz, then besieged by Charles V.; he led several brilliant sorties from that town, and in 1554 he commanded the light cavalry on the Meuse against Charles. He then joined the Huguenots, and he was concerned in the conspiracy of Amboise, which aimed at forcing from the king by aid of arms the recognition of the Reformed religion. He was consequently condemned to death, and was only saved by the decease of Francis II. At the accession of the boy-king, Charles IX., the policy of the court was changed, and Condé received from Catherine de' Medici the government of Picardy. But the struggle between the Catholics and the Huguenots soon recommenced; in 1562, 200 of the latter were massacred at Vassy by Duke Francis of Guise. Upon this Condé retired from Paris, put himself at the head of 1500 horsemen, and took possession of Orleans. Having raised troops in Germany, and entered into negotiations with Elizabeth of England, he marched on Paris, with 8000 foot and 500 horse. A battle took place at Dreux, in which the leaders on both sides, Condé and Montmorency, were taken prisoners. Condé was liberated by the pacification of Amboise in the next year (1563). In 1567 the war broke out again. It was strongly suspected by the Huguenots that Catherine was meditating a great and final blow—the revocation of the Edict of Amboise, the perpetual imprisonment of Condé, and the death of Coligni; and their suspicions were confirmed by the levy of soldiers, including 6000 Swiss, which she was engaged in making. Coligni determined to oppose her with a still bolder plan. The Huguenots were to rise *en masse*, crush the Swiss before they could join the main army, and take possession of the young king, his brothers, and Catherine herself. But both the Swiss and the royal family escaped safely to Paris. Paris was blockaded, and an indecisive battle

fought at St. Denis. During the next year peace was again made, but soon after Catherine attempted to seize both Condé and Coligni. They fled to La Rochelle, and troops were collected. At the battle of Jarnac, with only 400 horsemen, and without having made himself sufficiently certain of the support of the infantry, Condé rashly charged the whole Catholic army. Worn out with fighting, he at last gave up his sword, and a Catholic officer named Montesquieu treacherously shot him through the head (15th December, 1569).

CONDÉ, LOUIS DE BOURBON, PRINCE OF (1621-1681), called during the lifetime of his father Duc d'Enghien, but usually known as Condé the Great, was a distinguished French general, and one of the leaders of the Fronde. He was the son of Henry, prince of Condé, and Charlotte de Montmorency, and was born at Paris on the 7th September, 1621. As a boy, under the careful supervision of his father, he studied diligently and displayed much talent at the Jesuits' College at Bourges; at seventeen he was sent to govern Burgundy; and while yet in his teens he had displayed his extraordinary courage in more than one campaign.

During the youth of Enghien all power in France was in the hands of Richelieu; to him even the princes of the blood had to yield precedence, and among the obsequious courtiers none more eagerly sought his favor than Henry, prince of Condé. Enghien, therefore, with all his exaggerated pride, was forced to bow and render homage. Once, having ventured to pass through Lyons without visiting the great minister's brother, he was forced to retrace his steps 200 leagues, in order to atone for the slight. But a far more momentous sacrifice was required of him. He was already deeply in love with Mlle. de Vigean, who in turn was passionately devoted to him, yet, to flatter the cardinal, he was compelled by his father, at the age of twenty, to give his hand to Richelieu's niece, Claire Clémence de Maillé Brézé, a child of thirteen years of age.

In 1643 Enghien was appointed to command against the Spaniards. He was opposed by experienced generals, De Mello and Fuentes, and the forces of the enemy were composed of veterans; on the other hand, the strength of the French army was placed at his command, and with him served Gassion and other skilful leaders who had fought under Gustavus Adolphus. At Rocroy a great battle took place. At first defeat threatened the French, but, by the rapidity and boldness of his tactics, Enghien changed the event into a decided victory, and at the age of twenty-two made himself the most famous French general of his day. The achievement was well followed up, and after several other successes, Thionville was forced to capitulate. Returning to Paris in triumph, Enghien gave himself up to pleasure, and in gallantry and intrigues strove to forget his enforced and hateful marriage. In 1644 he was sent into Germany to the assistance of Turenne, who was hard pressed by the able Comte de Mercy. At Fribourg for several days there was continuous fighting, which cost dear to both sides, but especially to the French, whose lives were ruthlessly squandered by their general. The result, however, was equal to a great French victory; for, alarmed at the stern discipline displayed by his army, the towns of the Rhine, including Mayence, opened their gates to the duke. The next winter Enghien spent, like every other winter during the war, amid the gayeties of Paris. The summer campaign of 1645 opened with the defeat of Turenne by Mercy, but there followed a series of brilliant victories won by Enghien, who fought in person with untiring energy and careless courage. In the battle of Nordlingen, in which Mercy was killed, his horse was twice shot under him, and he received several serious wounds. The capture of Philipsburg was the most important of his other achievements during this campaign. In 1648 the duke of Orleans took the command, and Enghien volunteered to serve under him; but after the capture of Mardyke Orleans returned to Paris, leaving Enghien to take Dunkirk.

It was in this year that the old prince of Condé died. The enormous power that fell into the hands of his successor was naturally looked upon with serious alarm by the regent and her minister. Condé's birth and military renown placed him at the head of the French nobility; but, added to that, the family of which he was chief was both enormously rich and master of no small portion of France. Condé himself held Burgundy, Berry, and the marches of Lorraine, as well as other less im-

portant territory; his brother Conti held Champagne, his brother-in-law Longueville, Normandy. When, therefore, he sought the office of admiral of France, the Government, determined to permit no increase of his already overgrown authority, refused on various pretexts to comply. But Mazarin did not dare to use it, as he had intended, as a dowry for his niece; and compensation was made to the prince by the gift of the post of captain-general, with power to appoint every officer in the army. Still dissatisfied, Condé now sought permission to raise an army at his own expense, and conquer Franche-Comté for himself. This could not be allowed; and Mazarin made an attempt, which for the moment proved successful, at once to find him employment and to tarnish his fame as a general. He was sent to lead the revolted Catalans. Supported in the meanest way, he was unable to achieve anything, and, being forced to raise the siege of Lerida, he returned home in bitter indignation. In 1648, however, he received the command in the important field of the Low Countries; and at Lens a battle took place, which, commencing with a panic in his own regiment, was retrieved by Condé's coolness and bravery, and ended in a victory that fully restored his prestige.

In September of the same year Condé was recalled to court, for the regent required his support. She was then engaged in a determined struggle against the Parliament of Paris, which, led by the noble Matthieu Molé, the Pym of France, was, like the contemporary Long Parliament in England, fighting for popular freedom, but hampered, unlike the Long Parliament, both by its too tender reverence for the royal prerogative and by its alliance with De Retz and a section of the nobility, whose sole wish was to make of it a tool to gain the ends of their personal ambition. Influenced by the fact of his royal birth and by his arrogant scorn for the bourgeois, Condé lent himself to the court party. With his usual insolence he bullied and swore in the Parliament; and finally, after much hesitation, he consented to lead the army which was to reduce Paris.

On his side, insufficient as were his forces, the war was carried on with vigor. When an opportunity offered at Charenton, he struck terror into the Parisians by putting 3000 of their picked forces to the sword. But such opportunities were seldom afforded him. The burgher soldiers had too tender a regard for their own safety to expose themselves outside the walls when his troops were in sight; their most warlike achievement was the sham-fight with the garrison of the Bastille, when both sides used blank cartridge, and the duchess de Longueville with her ladies, seated in the thickest of the fire, ate sweetmeats and smiled on their valor. The prince of Conti, who had been won over by De Retz to accept the office of commander-in-chief of the army of the Parliament, considered that he sufficiently fulfilled the duties of his exalted position by riding at the head of his troops through the streets of Paris, and regularly quitting them as they passed out of the gates. Enthusiasm was kept up by the duchess de Longueville's brilliant and crowded receptions. But at length their substantial losses, and a threatening of scarcity of food, made the citizens weary of the war. The Parliament became timid as it watched the events of the contemporary revolution in England. The regent and Mazarin were still more alarmed by the same terrible warning, as well as by their fears of a Spanish invasion and a declaration in favor of Paris from Turenne, who was advancing thither with his army. A conference was accordingly held at Ruel, and with great difficulty Mazarin and Molé brought about peace.

Once more the court met at Paris, again given up to selfish ambition, vanity, and intrigues. Condé, most ambitious and vain of all, too vain to stoop even to civility, quickly earned for himself universal dislike. With no other apparent reason than an arbitrary whim, he forced the queen to reinstate as captain of the guard a certain conceited marquis named Jarsay, who had tormented her with his presumptuous love addresses. He prevented the marriage of one of Mazarin's nieces with the duke of Mercœur, refused to meet the cardinal in the council, and treated him with vulgar rudeness. The other nobles he offended by his airs of unapproachable superiority; he thwarted their attempts to attain the paltry ceremonial dignities—such as the high privilege of sitting at the royal receptions or assisting in the royal toilette—which were the dearest objects of

their ambition; he kept them waiting hours in his ante-chamber, and yawned in their faces when they were admitted into his presence. With the Fronde he was tricked into an open quarrel. By the contrivance of Mazarin shots were fired into his empty carriage, and he was persuaded that they had been aimed at his life, and that De Retz and Beaufort, the noble patrons of the Fronde, were responsible for the deed. The prince at once accused them openly before the Parliament, nor would his pride allow him to own his mistake when the utter worthlessness of Mazarin's witnesses was conclusively proved. De Retz, an intriguer superior to Mazarin in boldness and scarcely inferior in duplicity, now secretly joined with the court. Yet, knowing as he did that he was surrounded by powerful enemies, Condé, secure in his own strength, ventured, by a fresh insult, to goad the resentment of the regent into an uncontrollable desire for vengeance. The young duke of Richelieu was engaged, with the sanction of the queen and of his aunt and guardian, the duchess of Aiguillon, to the profligate Mlle. de Chevreuse, but was in love with a widow named Mme. de Pons. His alliance was of the highest value, for his uncle, the great minister, had left him several offices of importance, including the governorship of Havre de Grace. Wishing therefore to gain his friendship, Condé contrived his marriage with the lady he loved, and haughtily informed the queen that his presence rendered it valid without her consent. Urged by her own passionate indignation at the prince's defiance, and by the bitter complaints of the duchess of Aiguillon and Mlle. de Chevreuse, Anne no longer hesitated to resort to force.

Condé, Conti, and Longueville were accordingly arrested. But Bouillon and Turenne, who were also to be seized, made their escape; and Prince Marsillac (the Rochefoucauld of the *Maximes*) carried off his mistress, Condé's sister, the duchess of Longueville. By stratagem the young princess of Condé also obtained refuge in her husband's strong castle of Montrond. Vigorous attempts for the release of the princes began to be made. The women of the family were now its heroes. The dowager princess, though too miserly to part with her money to help her children, claimed from the Parliament the fulfilment of the reformed law of arrest, which forbade imprisonment without trial. The duchess of Longueville entered into negotiations with Spain. And the slighted young wife, with Lenet as adviser, having gathered an army around her, obtained entrance into Bordeaux and the support of the Parliament of that town. She alone, among the nobles who took part in the folly of the Fronde, gains our respect and sympathy. Faithful to a faithless husband, she came forth from the retirement to which he had condemned her, to fight for him with tact and bravery amid the rough bustle of war and politics, and to display an unselfishness and a sense of justice of which there is no other example among those who surrounded her, with their paltry aims and worthless lives. When the Parliament of Bordeaux patriotically refused to accept the assistance from Spain which the Frondeurs wished to force upon it, and the mob was stirred up by the duke of Bouillon to constrain it by violence, she risked her life to quiet the tumult.

The delivery of the princes was not, however, due to her efforts. Bordeaux was fortified, it is true, and resisted Mazarin for a time, but, after the defeat of Turenne by Du Plessis at Rethel, peace was made on account of the vintage. The discomfiture of Mazarin was caused by the junction of the old Fronde (the party of the Parliament and of De Retz) and the new Fronde (the party of the Condés). An angry comparison, that had been drawn by the cardinal between the popular leaders and those who in England had two years before overthrown the monarchy and brought their king to the scaffold, was made by the skill of De Retz to arouse in the Parliament a characteristic storm of indignation, from which Mazarin was glad to escape by flight. The regent prepared to follow him; but her intention became known. The night air resounded with the peals of bells from Notre Dame and all the lesser churches of Paris. The refuse of the city, mingled with respectable burghers and haughty nobles, poured into the streets. The news that the king was about to be carried away was spread everywhere by the emissaries of the coadjutor. The court of the palace was soon filled by the motley crowd. They passed up the staircase, and into the very room where the child-king lay, with precocious cunning feigning to be

asleep. At the awful sight, and abashed by the queen's cool derision, the mob reverentially withdrew. But Anne was forced to order the release of the princes from their prison at Havre; and Mazarin, humbling himself, rode down thither, and, falling at Condé's feet, piteously begged his protection and friendship.

The regent at once employed every means to draw Condé from his alliance with the Fronde. She made him offers which, from their very extravagance, might have aroused his suspicion,—he and his family were to hold something like the half of the kingdom; and Condé, relying on these faithless promises, carried out his part of the bargain by breaking with De Retz, the intended marriage of whose mistress, Mlle. de Chevreuse, with the duke of Conti he refused in haughty terms to permit. Meanwhile the queen had secretly gained over the coadjutor. A rumor reached Condé that he was to be assassinated or arrested; he fortified the Hôtel de Condé, and then retired from Paris, collected soldiers, and entered into negotiations with the archduke. He was consequently accused of high treason before the Parliament by order of the regent, and De Retz brought forward the charge. Condé appeared in person to meet it; and the building was filled with two bands of armed soldiers in the pay of the two parties. It seemed that the very Parliament House was to be the scene of civil war. The prince and the coadjutor spoke with vehemence and passion. Condé's hand was on the hilt of his sword, and the soldiers were only waiting for the signal to commence a deadly conflict when a solemn appeal from President Molé calmed the frenzied assembly, and prevailed upon the rival nobles to dismiss their troops. Condé at once retired to his fortress of Montrond, where, after conference with his brother and sister, as well as Nemours and La Rochefoucauld, he resolved on renewing the civil war.

But his party was far from being as strong as it had been in the previous rising. Two causes alienated many of his most important allies: the rebellion was no longer against a regent, for the king had just attained his majority; and the rebel had sought and obtained aid from the foreign power of Spain. The Parliament of Paris declared him a traitor; Longueville, Orleans, Turenne, and Bouillon went over to the court. Even the faithful city of Bordeaux became estranged, for the duchess of Longueville encouraged the mob in acts of outrage. Mazarin now ventured to cross the frontier with an army. But at once the Parliament proscribed him; and the lieutenant-general, followed by Nemours and Beaufort, took up arms against the court. Mademoiselle forced her way through a hole in the walls of Orleans, with one or two of her ladies, and frightened the magistrates into espousing the revolt. But Beaufort and Nemours did not agree, and their army was in danger of being destroyed by Turenne. Condé came to his help, having in disguise crossed the enemy's country and passed close by the royal troops. The very next night Hocquincourt's camp was burnt, and Condé, hurrying to Paris, formed an alliance with Turenne, and sought to win over the Parliament. But Molé stripped off the veil of patriotism with which he sought to conceal his selfishness, and pointed out that he was allied with a foreign power, and that he was actually treating with the detested cardinal. The prince retaliated by stirring up the mob, and leaving the city to its savage caprice. At length he quitted Paris to save the rebel army which was hotly pressed by Turenne, and the magistrates persuaded the facile lieutenant-general to close the gates. At the gate St. Antoine, on the 2d July, 1652, Turenne and Condé met. Condé fought in person with marvellous energy; he seemed, said Turenne, to be twelve men at once; but, pressed by numbers as he was, it was apparent that he could hope for safety only by being admitted within the walls of Paris. Fortunately he had in the city as champion one of the most remarkable women of that strange time, Mademoiselle, the daughter of Gaston, duke of Orleans, and the author of the *Mémoires*, who hoped to succeed his sickly wife, or, better still, by his means to obtain the hand of the young king. She frightened and persuaded the provost of the merchants and L'Hôpital, the governor of Paris, into opening the gates and turned the cannon of the Bastille on the army of Turenne. Keeping his ground so long as daylight lasted, at nightfall Condé entered the city. It was given up to pillage and murder. Fire was set to the building where the magistrates had met, and the magistrates

themselves narrowly escaped with their lives. Famine began to be felt, and pestilence appeared. Deserted by crowds of his followers, bitterly disappointed, and worn out, as was whispered at the time, by his excesses, Condé was seized with fever. Mazarin, going into exile, freed the court from the odium of his name; and the Fronde melted away.

On his recovery (October, 1652), Condé fled from Paris and joined the Spanish army. The swift, bold tactics which had gained him glory were now impossible; he was constantly hampered by the ancient and ponderous methods of the Spaniards, by their inflexible etiquette, and their lordly laziness. He gained some successes, as the entry into Cambray, which was invested by Turenne, and the raising of the siege of Valenciennes; but fortune was in general on the side of France. At length in 1659, after the disastrous battle of the Dunes, Spain, tired of the war, consented to the disadvantageous peace of the Pyrenees, and at the same time Condé obtained his pardon from Louis, who thought him less dangerous as a subject than as possessor of the independent sovereignty of Luxembourg, which had been offered him by Spain as a reward for his services.

Thenceforth he was excluded from court intrigues, and for several years he resided on his estate at Chantilly, where he gathered round him a brilliant company, which included many of the greatest men of genius that France has seen—Molière, Racine, Boileau, La Bruyère, La Fontaine, Nicole, Bourdaloue, and Bossuet. But the quarrel between Luvois the minister of war and Turenne again opened a field for his ambition. In 1668 he laid before the former a scheme for seizing Franche-Comté, the execution of which was intrusted to him, and successfully carried out. In the next year Condé was offered the crown of Poland, which, however, Louis would not allow him to accept. In 1672, he took part in the war with Holland, and forced the passage of the Rhine, at which engagement he was severely wounded in the wrist. In 1673, he met the Prince of Orange in the great but undecided battle of Seneffe. He served for the last time in 1675, as general of the army of the Rhine, which had been left without commander by the death of Turenne. After this campaign, prematurely worn out by the toils and excesses of his life, and tortured by the gout, he returned to Chantilly, where he spent the eleven years that remained to him in quiet retirement. In the end of his life he specially sought the companionship of Bourdaloue, Nicole, and Bossuet, declared himself a convert, and devoted himself to the ordinances of religion. He died on the 11th December, 1686, at the age of sixty-five. Bourdaloue attended him on his death-bed, and Bossuet pronounced a glowing funeral panegyric upon him.

Condé's character is a type of that of the French noble of his day. To be regarded as a brilliant conqueror in love and war, to hold the first place at court, swaying the councils of his sovereign at his will, and receiving universal homage—these were the selfish and only objects of his ambition. His vanity was such that he looked on no man as his equal; Louis XIV. himself could not have shown an arrogance more insolent. He was said by one who knew him well to be the hardest-hearted man in France. Ruthless and savage, he was also an intriguer not less unscrupulous, though incomparably less adroit, than his victorious enemy, the subtle Italian cardinal. Thus he had all the faults of the French noble on a colossal scale; he had also his virtues in a more extraordinary degree. Where all were brave, he was conspicuous above all for a thoughtless courage which nothing could dismay, and to which, combined with the intense enthusiasm and rapidity of thought that inspired him on the field of battle, he owed the most brilliant of his victories. And the evening of his life, when, done with ambition, he gave himself to the delights of literature, reveals a new and finer side of a character that would otherwise appear all harsh and without beauty.

Condé's unhappy wife, Clémence de Maillé, some years before had been banished to Châteauroux. An accident, seized upon by her husband with unseemly eagerness, brought about her ruin. A servant had entered her private room, and after threatening her loudly, stabbed her, and made his escape. Her contemporaries, greedy as they were of scandal, refused to believe any evil of one so pure and noble; but the prince declared himself convinced of

her unfaithfulness, placed her in confinement, and carried his resentment so far that his last letter to the king was to request him never to allow her to be released.

See the numerous *Mémoires* of the time, especially those of Lenet, Motteville, La Rochehoucauld, De Kets, Grammont, Namours, Coligni, and Mademoiselle; the *Lettres de Mme. de Sévigné*; the lives of Condé, by Adrien Lemercier, Desormeaux, Voivreuil, Mahon, and Louis Joseph, prince of Condé; Fitzpatrick, *The Great Condé and the period of the Fronde*; Cousin, *Histoire de Mlle. de Longueville*. (r. x. w.)

CONDÉ, LOUIS HENRY JOSEPH (1756–1830), duke of Bourbon, and last prince of Condé, was the son of Louis Joseph, prince of Condé. Several of the earlier events of his life, especially his marriage with the Princess Louise of Orleans, and the duel that the prince of Artois provoked by raising the veil of the princess at a masked ball, caused much scandal. At the Revolution he fought with the army of the emigrés in Liège. Between the return of Napoleon at Elba and the battle of Waterloo, he headed with no success a royalist rising in La Vendée. In 1829 he appointed the Duc d'Aumale his heir; and exactly a year after he was found strangled with a handkerchief round his neck. A famous trial was the consequence, in which no verdict was given.

CONDÉ, JOSÉ ANTONIO (1765–1820), a distinguished Spanish Orientalist, was born at Paraleja, in the province of Cuenca, and was educated at the university of Alcalá. Intended by his father for the law, he found means to learn not only Greek, but even Hebrew and Arabic. A subordinate post in the royal library enabled him at an early age to abandon his legal studies, and to devote himself entirely to literature; and in 1796 he published a volume of paraphrases from the Greek idyllists. This was followed, in 1799, by an edition of the Arabic text of Edrisi's *Description of Spain*, accompanied with notes and a translation. Though by no means free from inaccuracies, this publication greatly advanced the editor's reputation. He was made a member of several learned societies, and was one of the commission of three appointed to continue the bibliographical labors of Sanchez; and he received royal aid in the studies requisite for the composition of his next work, the famous *History of Moorish Rule in Spain*. On Napoleon's appearance in Madrid (1808), Condé identified himself with the party of France. Joseph Bonaparte made him librarian in chief at the royal library; and he had to leave his native land with the retreating invaders. After a residence of some years in Paris, spent in arranging materials for his history, Condé was at last permitted to return to Spain in 1818 or 1819. His countrymen, however, would not forgive him for his apostasy; he sunk into poverty, and died soon after his return. His history (*Historia de la Dominación de los Arabos en España*) was published by subscription. Only the first volume received the author's final corrections, the other two being compilations from his MSS. This work, although confused and inexact, a chronicle rather than a history, may yet be read with advantage; an English translation (1854) occupies three volumes of Bohn's *Standard Library*. Notwithstanding its imperfections, the book opened an era in Spanish literature; and Condé himself must be regarded as the earliest laborer in a field which has since yielded a rich and abundant harvest.

CONDER, JOSIAH, an English littérateur, was born in Falcon Street, Aldersgate, London, on 17th September, 1789, and belonged to an old nonconformist family, proud of its hereditary piety and nonconformity. Leaving school at the age of thirteen, he began to assist his father in his business as a bookseller at Bucklersbury; and in this situation he found abundant pabulum for the literary tastes which he had already begun to develop. The first time he appeared in print was in the poet's corner of the *Athenæum*, No. 11; and in 1810 he joined the well-known Taylor family in the little volume called the *Associate Minstrels*. From 1811, when his father retired, till 1819, he carried on the business on his own account; but in the latter year he determined to adopt literature as a profession, and thenceforward till his death his pen was never idle. As editor of the *Eclectic Review*, which had been published under his name since 1814, he was regarded as the literary representative of evangelical nonconformity; and in 1832 he became still more publicly and completely associated with the interests of the party as the editor of the newly

established organ called the *Patriot*. Besides contributing voluminously to both these periodicals, he published work after work on religious, political, and miscellaneous subjects; but in too many cases these owed their origin merely to the necessity of producing something that had a market value. That he frequently put forth mere paste and scissors work he makes no shame to confess,—conscious that if his labor was somewhat ignoble it was at least performed with scrupulous honesty. His whole literary activity was influenced by his religious convictions, and it was not only as editor of the *Eclectic* that he endeavored to “reconcile those long divorced parties—religion and literature.” His most popular work was his *Modern Traveller*, a series of thirty volumes descriptive of the various countries of the globe; but he will probably be longest remembered as the author of a few hymns not unworthy to rank with the best examples of nonconformist psalmody. He died on December 27, 1855. His life has been written by his son, Eustace R. Conder.

His principal publications are—*On Protestant Nonconformity*, 2 vols., 1818; *The Star in the East, with other Poems*, 1823; *Analytical View of all Religions*, 1838; *The Literary History of the New Testament*, 1845; *The Harmony of History with Prophecy*, 1849.

CONDILLAC, ÉTIENNE BONNOT DE (1715–1780), Abbé de Mureaux, a distinguished writer in logic, psychology, and economic science, was born at Grenoble. Very little is known about the particulars of his life. He was the younger brother of the Abbé de Mably, and associated in his youth with Rousseau, Diderot, Duclos, and other philosophers, but afterwards allowed the intimacy to die out. He was of a serious and dignified character, and devoted himself to a life of laborious study. Like Comte and Mill, he acknowledges himself to have been largely indebted to a lady for his philosophical inspiration. While still young he was appointed preceptor to the duke of Parma, grandson of Louis XV., for whose instruction a large number of his works were composed. He was chosen by the French Academy of Sciences to succeed the Abbé d'Olivet in 1768, but after delivering a discourse on that occasion he never again appeared at the meetings. He lived in retirement on his estate of Flux, near Beaugency, till his death on 3d August, 1780.

Condillac's philosophical opinions are contained mainly in *L'Origine des Connaissances Humaines*, *Traité des Systèmes*, *Traité des Sensations*, *Grammaire*, *L'Art d'Ecrire*, *L'Art de Raisonner*, *L'Art de Penser*, *La Logique*, and his posthumous work, *La Langue des Calculs*. The first of these was his earliest production, and may be regarded as the preliminary sketch of his entire system. It touches more or less distinctly on all the topics which are discussed in the others. But the doctrines it contains receive a fuller and more mature statement elsewhere, and there are many important departures from them in the latter works.

Condillac's philosophical writings may be studied from three points of view. Like Locke, he begins with a polemic against innate ideas and abstract systems. This takes up a large part of the *Essai sur l'Origine* and almost the whole of the *Traité des Systèmes*. In the *Logique* and the *Art de Raisonner* he expounds and illustrates the analytic method, which he regards as the only true method of science, and which is further illustrated in *La Langue des Calculs*. *L'Art de Penser* consists largely of quotations from the *Essai sur l'Origine*. In the *Traité des Sensations*, Condillac applies his analytic method to the solution of the psychological problem of the origin of our ideas and the formation of the mental faculties. It cannot be said that he strictly confines himself to the questions here assigned to his different works. His inveterate antipathy to innate ideas and abstract systems, his favor for analysis, and his peculiar psychological doctrines appear more or less in them all.

Condillac's main attacks are directed against the innate ideas of Descartes, Malebranche's theory of the mental faculties, the monadology of Leibnitz, and the first part of Spinoza's *Ethik*. He thinks that innate ideas were assumed because men had not sagacity and penetration enough to go back to the origin of ideas and trace their genesis, and he finds the consequences of the system to be the multiplication of abstract principles, and a pretence of accounting for everything by the use of abstract terms. Malebranche is justly censured for giving comparisons instead of reasons

in his explanation of understanding and will. In criticising the monadology of Leibnitz, Condillac exaggerates the vagueness and inadequacy of the ideas furnished by the reason, and the clearness of those of the senses. He cannot comprehend how each monad represents the universe in virtue of its relations to it. But may there not be a sense in which the ultimate particular in the infinitude of its relations is a mirror of the universe? Condillac regarded Spinozism as the best example of an abstract system, and criticised in detail the first part of the *Ethik*, in order to show that Spinoza failed both as to clearness of ideas and precision in the use of signs—two essential conditions of the geometrical method which he adopted. Condillac divides the various philosophical systems into three classes:—(1) abstract systems which rest only on abstract principles; (2) hypotheses, or systems grounded on mere suppositions; (3) one true system, that of Locke, which is evolved from the facts of experience. The first he treats with unmitigated scorn; the second he admits under limitations; the third alone he regards as the true method of philosophy.

An act of reasoning, according to Condillac, consists in detecting a judgment which is implicitly contained in another. Sometimes, to go from the known to the unknown, it is necessary to pass through a series of intermediate judgments, each of which is contained in the one preceding. For example, the judgment that mercury will rise to a certain height in the barometer is contained implicitly in the judgment that air has weight; but we require a series of intermediate judgments to see that the former is a consequence of the latter. The evidential force of a reasoning thus consists in the identity between the judgments of which it consists. They are the same; only the expression changes. Such a principle could not be made to cover all the varieties of reasoning. Accordingly Condillac tries to reduce them all to the mathematical form. To reason is to calculate, and to calculate is to reason; and reasoning, like calculation, comes to be a merely mechanical operation. Condillac rejects the common explanation of reasoning, that it is a comparison of two terms with a common third to find their relation to each other. He sees no need for a middle term. The force of the demonstration, he thinks, lies in the identity of the two extremes, which is made evident by decomposing them. Of the syllogism he says that it makes reasoning consist in the form of expression rather than in the development of the ideas, and that most of its rules have been framed with a view to concluding from the genus to the species, whereas thought sets out from particulars.

Regarding the criterion of truth, he attacks the Cartesian test of truth, and proposes instead of it his own criterion of identity. In the *Essai sur l'Origine des Connaissances* he brings two objections against Descartes:—(1) the methodic doubt is insufficient and even useless, because, while calling our ideas in question, it leaves them in all their indeterminateness; (2) it is impracticable, for we cannot doubt about the relations which exist between familiar and determinate ideas like those of numbers. Of the Cartesian criterion of truth, "all that is contained in the clear and distinct idea of a thing may be affirmed of it with truth," Condillac says that it is both useless and dangerous, and should not have been extended to cases different from the one which gave it birth. For Condillac the sign of truth is identity. The evidence of a proposition is in the identity of the two terms. The evidence of a reasoning is in the identity of the successive propositions. No definition, however, is given of identity. It is said to be recognized when a proposition can be expressed in terms equivalent to these,—"the same is the same." But Condillac draws a distinction between identical propositions that are frivolous and those which are instructive, and explains the latter to be those in which the terms are identical in thought, but different in expression. Condillac held that three kinds of evidence are needed to arrive at certainty—the evidence of fact, the evidence of feeling, and the evidence of reason. The evidence of fact informs us of the relations which bodies have to us; it can have no other object. The evidence of feeling enables us to distinguish what passes in us, the modes or states of the mind. Some good remarks are made in chapter iii., part i., of *L'Art de Penser*, on the attentive observation of consciousness. The evidence of reason is discussed in the first three chapters of the first part of *L'Art de Raisonner*. There

<sup>1</sup>[Pierre (1756-1837), born in Aveyron, taught philosophy in Toulouse and the Institute in Paris, wrote a work on the cause and sources of our ideas, which was adopted by the French government as a text-book.—AM. ED.]

Condillac merely formulates the principle of identity, and cites as examples the geometrical theorems which his pupil will require, that he may understand the rest of the work.

Condillac was of opinion that one method of analysis is common to all the sciences. Our cognitions ought to form a system in which all is strictly connected together. Every series of facts should be reduced to an initial fact, of which the others are only transformations. Identity is a rule of method as well as a criterion of certainty; and analogy completes the primary lessons which are given us by nature. Condillac takes as his model the method of mathematics, and reiterates through his logical writings that we must take nature for our guide. On the relation of analysis to language he held that there is an innate language, although there are no innate ideas. This language produces a kind of analysis, since it is necessary for the communication of our ideas to analyze and express in succession what is simultaneous in thought. Analysis then reacts on language and improves it. Finally, perfection of language leads to perfection of analysis, and science is only a *langue bien faite*.

The method of invention is discussed chiefly in the *Essai sur l'Origine des Connaissances* and in the *Langue des Calculs*. In the former, Condillac bids us take the simple ideas furnished by sensation and reflection, form different collections of them, which in their turn will produce others, and give distinct names to these different collections. In the *Langue des Calculs* the idea of analogy is developed. This is not the analogy set forth in the *Art de Raisonner*, which consists only in forming more or less probable conjectures about the unknown from the known. The analogy of the *Logique* and the *Langue des Calculs* is that which creates and regulates languages, which causes us to invent different systems of signs and submit them to uniform rules.

Reasoning cannot have the purely subjective character which Condillac's theory assigns to it. It takes its departure from the idea, which is objective, and therefore establishes a real relation between the mind and its object. On the question of the need for a middle term it is not enough to decompose the two ideas. The two decompositions must meet at a point, and that is the middle term. Laromiguière<sup>1</sup> preserves the intermediate ideas, which he thinks are found by analysis of the extremes. So they are. But it has been urged that there is a twofold analysis—of the species into its genera and of the genus into its species—whereby the middle term is found. Condillac is inconsistent with himself in his criticism of Descartes. His first objection to the methodic doubt is based on the opinion that all our errors proceed from the indeterminate character of language, and that the use of definite signs is the only security against error. But he believes that analysis makes language; and the methodic doubt is a kind of analysis, for it remounts to the primary truths. His second objection, that we cannot doubt about mathematical relations, is invalidated by his own statement that mathematics are only part of metaphysics. Condillac is right in saying that the Cartesian criterion of truth lacks a theory of ideas and of their origin. But it is not to be condemned as useless because it is incomplete. Condillac was led away by the supposed need for a sign whereby to recognize truth. As Hegel would have put it, he refused to go into the water until he could swim. But it would be as difficult to determine the value of the sign as that of the truth itself. Some such criterion as identity is the only resource of empiricism. But if the notion of identity is derived from experience, it cannot give certainty. If, that it may serve as the basis of logic, it is regarded as necessary, then empiricism cannot reconcile it with its psychology. Laromiguière tries to get over the difficulty of accounting for progress in a system based on the notion of identity, by drawing a distinction between partial identity and total identity, and saying that the former alone should be admitted. But what is partial identity? Condillac himself takes refuge in extreme idealism. Truth, he says, considered in itself and in the divine intelligence, is one and identical. But he had himself laid down the rule to limit our consideration to the condition of human knowledge, and of course he had no idea of developing thought as such from its primal unit by dialectic process after the manner of Hegel. As to the three kinds of evidence, Condillac in reality reduces the evidence of fact to that of



feeling and that of reason. His numerous contradictions are largely due to his attempts to defend the authority of the senses, while he accepts the idealistic theory of external perception. The objections to identity as a criterion of truth apply as well to Condillac's statement of the evidence of reason. And if the three kinds of evidence are inadequate taken separately, they cannot suffice when combined. Condillac rightly insisted that there is one fundamental method for all the sciences; but he nowhere reconciles this unity of method with the variety of form which it assumes as applied to different objects. By demanding at the outset the initial fact, of which all the others are to be shown to be transformations, he virtually quits the safe road of experience. He errs, too, in thinking that the method of mathematics is applicable to all the sciences. His oft-repeated advice to follow nature would have been advantageously accompanied by a clearer explanation of what nature is. One thing which he certainly excludes from it is the mind viewed as the seat of intellectual principles. Condillac's analysis combines what are generally regarded as the two distinct processes of analysis and synthesis. Synthesis he conceives to be that method which starts from abstract principles, and accordingly he treats it with supreme disdain. But while banishing the name he retains the thing, and insists that no analysis is complete without a process of recomposition.

The logic of Condillac finds its most important application in psychology. In the *Essai sur l'Origine des Connaissances* he starts from sensation as the primitive fact, and seeks to show that all the ideas and operations of the mind are only transformations of it. He neglected, however, to make sure of his way back to the primitive fact of sensation, before using it as his starting point. Under the influence of Locke, he simply assumed it, and applied his ingenuity to derive from it all the ideas and operations of the mind. Throughout the *Essai sur l'Origine* he confounds sensation with perception in a way that vitiate his whole argument. At the outset he affirms that sensations are ideas, because representative of objects. It is difficult to understand in what sense he uses such language. For a long time it was supposed that he regarded the pure sensation as the primary element of consciousness; but his more recent followers have adopted a different interpretation. They try to make out that his meaning was that in the simplest state of consciousness the whole mind is to be found, equipped with all its so-called faculties. Condillac found an opinion prevailing that the mind is partitioned off, as it were, into a variety of different faculties, each having its separate function, which it discharges independently of the others. It was against this opinion, they say, that he contended. He maintained that the mind is not a congeries of faculties, but is one and indivisible, and appears in all its forms of activity in the simplest state of consciousness. This opinion is difficult to reconcile with his avowed purpose, to which he adheres throughout all his psychological treatises, of tracing the genesis of the faculties; for sensation would then not be a primitive fact, from which all the later furniture of the mind is derived by a process of transformation. There would, in fact, be no generation of the faculties, for all would be given in the rudimentary consciousness, and any reasoned account of their relations to each other would need to refer to something anterior to the individual consciousness. Probably the more correct view to take of Condillac's psychology is that when he tried to deal with sensation, pure and simple, he found it impossible to do so, and was compelled to invest the mere sensation with all the ideas of reason, that it might do duty in his system. No doubt either interpretation would save Condillac's consistency with his great principle of identity. The sameness of the elementary sensation with the higher faculties and ideas is secured, whether the faculty is degraded to the level of the sensation, or the sensation is raised to the level of the faculty. And there is much in Condillac to countenance either view. But it is probable that if he had been willing to concede that the mind is all in the primary sensation, in the sense in which his later followers understand him, he would have felt the necessity of exhibiting the relations of the different mental operations, which in such case would be moments of the sensation, anterior to the sensation, instead of subsequent to it, in terms of the relations of different sensations to each other. The opening sentences of the *Traité des Sensations* show that Condillac was aware

of the difficulties attending the study of our rudimentary consciousness on the presuppositions of sensationalism. If the mind at birth was a *tabula rasa*, there can be no traces left of our primary state. It is in vain therefore to interrogate our consciousness to learn what it was then. To show how all proceeds from sensation, we must consider our senses separately. As Condillac could not do this by examining his own consciousness, he devised the experiment of the statue. It is supposed to be possessed of a mind destitute at first of every sort of ideas, and only to have the use of its senses at the pleasure of the experimenter, who opens them at his choice to their appropriate impressions. A beginning is made with the sense of smell, because it seems to contribute least to our knowledge. The other senses are successively experimented on, singly and in groups, and at last the statue is found to have become an animal able to preserve itself. Condillac claims to have stripped man for the first time of all his habits. Feeling is observed at its birth, and proof is given of how we acquire the use of our faculties. The principle of their development is found in the various degrees of pleasure and pain attaching to our sensations; for none of them are indifferent absolutely. The contrast between pleasure and pain impels us to court some sensations and flee others. A sense of need is produced by the want of an object judged necessary for happiness. Needs beget desires; old needs repeated and new ones formed are the ground of the development of our knowledge and our faculties. The outcome of Condillac's psychology is given in briefest form in chapters vii. and viii. of the *Logique*. Laromiguière corrected Condillac by substituting attention for sensation as the principle of the active half of the mental phenomena. Cousin pointed out that attention is a voluntary act. He showed the essential difference between desire and will, as also between sensation and desire, and remarked that the organic impression must not be confounded with the sensation. If the sensation is the condition of the exercise of the faculties, still it is not the principle of any.

Condillac defines personality to be a collection of sensations plus the ability to say "me." But this plus is of vast importance. How comes it that this particular collection of sensations can say "me"? Because, answers Condillac, it is a collection of present and remembered sensations. But whether does the statue say "me" because it can remember its sensations, or remember its sensations because it can say "me"? Is not all that is involved in saying me already involved in memory, so that his answer merely repeats the fact which it professes to explain? Condillac thought so in his first stage, as he then found the feeling of one's own existence to be an essential element of reminiscence. Then, indeed, reminiscence was distinguished by him from memory, but only in an artificial way. A collection of sensations is a less correct account of personality than the synthetic unity of Kant. What renders the collection possible? For Condillac its essential condition, a unifying principle, is wanting. That cannot be found in sensation. It is a condition of the ordering of sensations, and is the all-important unit, out of which a true philosophy of spirit must grow. Sensations cannot give an answer to the question what constitutes experience. Even Mill had to confess that it must at least be sensations which have the strange property of turning back upon themselves. Condillac has the very same phrase, "As long as the statue changes not, it exists without any return upon itself." Thus, in their own inarticulate way, the sensationalists are compelled to postulate the synthetic unity of Kant. And just as it is present in the first fibre of personality, the first flash of self-consciousness, its various modes of operation are no less essentially present throughout all the subsequent fabric of experience, and in the full sunlight of conscious life. To trace and treat them is the work of philosophy proper, which may be briefly distinguished from the natural sciences as that which deals with the universal aspect of thought, while they deal with the particular. Both are necessary factors of concrete thought. Experience will never spring out of categories alone, nor will it arise out of particulars alone. The method of observation proper to the natural sciences may lead us to the border ground of the two territories, but for exploring the region of the universals there is needed a keener vision and a deeper principle. It is the fault of Condillac, as of

all the sensationalists, that he does not apply the analytic method faithfully enough to bring himself consciously face to face with the universal factor of experience. It is interesting to note in him the progress towards a more thorough use of analysis. In the *Essai sur l'Origine* he was of opinion that any single sensation was an idea, i.e., representative of external entities, and that a single sense is adequate to produce an experience more limited in degree, but the same in kind as ours. So he maintained against Locke and Berkeley that we can know through sight alone the magnitudes, distances, and situations of objects. His position then much resembled that of the so-called common-sense philosophers. To him an external world was as necessarily present in sense as to them; and his criticism of Spinoza, that the assumption in his definitions of what he meant to prove by means of them made his work easy, may very aptly be applied to the *Essai sur l'Origine*. If a complete experience is given in a single sensation, it will be easy to find it in a succession of them. But the *Traité des Sensations* marks an advance upon these views. Now a sensation is not *per se* an idea. A stricter use of analysis detects other elements in ideas. Condillac saw from the first that a sensation to be an idea must be representative of something out of the present consciousness. Now he sees that, to be so, it must either exist in the memory or be modified by judgments. That is to say, it must be the sensation of a series of sensations, which has the marvellous power of returning upon itself; or, in more intelligible language, it must be held in the grasp of the synthetic unity of thought. In the *Origine* Condillac really develops experience out of perception, or sensations regarded as synonymous with ideas. In the *Traité des Sensations* he has come to know that a sensation as such is not an idea. But although he still professes to develop all the mental operations out of sensation, he is as far as ever from bridging over the gap between sensations and ideas, or even from acknowledging in his actual procedure the existence of such a gap at all.

When Condillac, largely owing, as he tells us, to the influence of Mlle. Ferrand, abandoned the position of the *Essai sur l'Origine*, that by sight alone we can judge of the magnitudes, distances, &c., of objects, he seems to have been in unstable equilibrium between sensationalism and a very different mode of philosophizing. In the *Traité des Sensations* he shows how these judgments are founded not upon the direct intimations of sight, but upon an association that has sprung up between the sensations which we owe to different senses. The mind, he sees clearly, has come to deal with relations among sensations. He even goes the length of saying that the idea of impenetrability cannot be a sensation, but is a judgment founded on sensation. He was then on the verge of intellect proper, and within sight of something deeper than sensation. The intelligible order of things is dimly seen by him to be the reality for us, and he tries hard, in the *Traité des Sensations*, to show how we become aware of it through the interaction of the different senses. But just then he falls back again into sensationalism. He loses hold of judgment as the all-important element, and conceives the senses in some strange way to acquire a habit of immediately informing us of what a moment before he saw it needed an act of judgment to reach. For an instant he had a glimpse of thought as constitutive of experience. But forthwith the vision passes, and its place is taken by a mysterious and totally unintelligible habit or instinct of sense. Accordingly, in the *Art de Penser*, he is back again to the gross statements of the *Origine*, that we may find in sensation the ideas of extension and figure, and perceive as distinctly and clearly that they do not belong to us, or to what in us is the subject of thought, but to something outside of us.

It is not difficult to see how his theory of reason sprang out of his theory of the origin of knowledge, for of course his psychology was thought out before his logic. If all is sensation, and we can never get beyond sensation, then our advancing knowledge must be only a ringing of the changes upon the primary sensation. The latest results will be identical in the fullest sense with the first beginnings, and all science will be reduced to a development of language, a series of identical expressions, to which we are driven by the limitation of our faculties preventing us from seeing the identity between remote terms. Thus, in *L'Art de Raisonner*, he shows at length that the demonstration of the rule for finding the area of a triangle is necessitated by

our inability to see the identity between the idea we have of "measure" and that we have of the product of the height of the triangle by half the base. Similarly, the argument in the *Traité des Sensations* is necessitated by our inability to see the essential identity between sensation and thought. Every successive proposition is identical in idea with the preceding one, and differs from it only in expression. There is no advance or development in matter. In his psychology it is the same sensation throughout. In his theory of reasoning it is always the same idea throughout. The difference is merely in form, and it is not difficult to see how, in a philosophy which neglects intelligible relations, and ignores the truth that they are constitutive of experience, form must of necessity be degraded and become mere form of words. This is the complaint which is urged by Hegel against all the natural sciences. He, so to speak, accepts the verdict of Condillac upon them. So far as they attempt to prove anything, he says, they are a mere string of identical propositions. But to Hegel form was everything. The development of the notion is what constitutes the universe; and accordingly he thought that a different formula of reasoning must be found from any hitherto recognized. Syllogistic reasoning is not adequate to any real development of form. It sinks down into a mere change of verbal expression, as Condillac had asserted, while the matter of thought is left precisely where it was. But matter is only the potentiality of form, and form is no mere transformation of verbal expression, but an organic growth of thought. Is there any standing ground between the identity of Condillac and the dialectic of Hegel?

There are many later systems which it would be interesting to compare with the thoughts of Condillac, notably the psychology of Beneke, the later views of Mr. Lewes, and the logical doctrines of Professor Jevons. There is a remarkable similarity between the identity of Condillac and the substitution of similars of Professor Jevons. The logical machine is almost like a realized ideal of Condillac; and Professor Jevon's new system of symbols would probably have been hailed by Condillac as the *langue bien faite*, the counterpart of algebra, for which he sighed in vain.

Condillac's important work *Le Commerce et le Gouvernement* was published in 1776, the same year in which the *Wealth of Nations* appeared. The best European economists are said to be now gravitating to the opinion that Condillac's is the true conception of economic science. His work treats economic science as the science of commerce or exchanges. It was originally intended to consist of three parts, but the last never appeared. In the first part he develops the principles of economic science, and treats of the phenomena of commerce or exchanges. The second part considers the relations of commerce and government, and their reciprocal influence. The third part was to have contained a number of examples, to show that his theories had facts to rest upon as well as argument. His great merit was to have fixed upon the wants and desires of the human mind as the source of value. Hence he did not look on labor as a cause of value. In an exchange both parties are gainers, for each gives what is comparatively superfluous to him for what is necessary. Therein, he thinks, lies the spring of all commercial activity. He is a strong free trader, and answers by anticipation Saint Simon, Fourier, and their followers regarding the right of inheritance.

Condillac was a most voluminous writer. A collected edition of his works was published in 23 volumes at Paris in 1798, and was followed by another in 32 volumes in 1803. Several partial editions, containing those of his works which form the *Cours d'Études* for the young duke of Parma,<sup>1</sup> were published

<sup>1</sup> Condillac's opinions about education, which he carried out in the instruction of the young duke of Parma, are interesting and important. He declares his method to be the same as that by which men have created the arts and sciences. He is very severe upon the error of cultivating only the memory until a supposed "age of reason" has been reached. The young child begins to reason, he thinks, in learning to use its senses, and no delay should be made in encouraging him to observe his own mental processes and the facts around him. So long as he is unable to make observations for himself he should be informed about those of others. The teacher's great object should be to train his pupil to think, to find pleasure in mental exercise, and to frame just ideas. Condillac took the hint as to the right order of studies from the experience of nations. First he directed his pupil's attention to those objects and studies which meet the primary wants of man. Then he cultivated his taste. Finally, he directed his thoughts to speculation. He characteristically regarded the arts of speaking, writing, reasoning, and thinking as fundamentally the same, and reduced them all to that of speaking. Condillac had perfect confidence in his method, and

different times. The following is a list of his works:—*Essai sur l'origine des connaissances humaines* (1746); *Traité des sens* (1749); *Traité des sensations* (1754); *Cours d'études*, published in 13 volumes in 1755, comprising the "Grammaire," "l'Art d'écrire," "l'Art de raisonner," "l'Art de penser," "l'Histoire ancienne" and "l'Histoire moderne," "l'Étude de l'histoire," and "Traité des animaux;" a sequel to the *Traité des sensations* (1775); *Le commerce et le gouvernement* (1776). A *Logique*, written as an elementary treatise at the request of a Polish council of public instruction, appeared in 1780, a few months before the author's death. *La langue des calculs* was not published till 1798. An English translation of the *essai sur l'origine* by Thomas Nugent was published in 1756, and is usually as a supplement to Locke's *Essay on the Understanding*.

References—Louis Robert, *Les Théories logiques de Condilliac* (Paris, 1869); F. Réthori, *Condilliac ou l'Empirisme et le Rationalisme* (Paris, 1864); Laromiguière, *Leçons de Philosophie, paradoxes de Condilliac*; George H. Lewes, *History of Philosophy*, vol. ii. (1871); Whewell's *Philosophy of Discovery* (1860); Mill's *Logic*, book ii. chap. 2, sec. 2. There is an excellent account of Condilliac's economic doctrines in Macleod's *Dictionary of Political Economy*. See also Dugald Stewart's *Preliminary Dissertation* in the eighth edition of the *Encyclopædia Britannica*, vol. i. p. 172. (D. B.)

CONDOM, a town of France, at the head of an arm of the Garonne, in the department of Gers, 26 miles from Auch, on the Bayse, a tributary of the Garonne, there crossed by two stone bridges. The church of St. Peter, formerly a cathedral, is included among the historic monuments of France, and deserves notice for the height of its vaulted roof. The manufactures of the town include woollen fabrics and porcelain; and its trade is mainly in rural produce and brandy. The nucleus of the place was furnished by an abbey, founded in the 10th century; in 1317 it was made a bishopric by Pope John XXII., and in 1549 the monks were appointed canons of the cathedral. In the 18th century it was the centre of a district called condomois, which contained the towns of Nerac, Gabaret, and Mont de Marsan; and it possessed three convents and 20 nunneries. Among its celebrities are Duplex the historian, and Montluc the leader of the crusade against the Albigensians. Bossuet was bishop of Condom in 1669. Population in 1872, 5205.

CONDOR (*Sarcorhamphus gryphus*), a New World vulture, and the largest of existing birds, although by no means attaining the dimensions attributed to it by early writers. It usually measures about 4 feet from the point of the beak to the extremity of the tail, and 9 feet between the tips of its wings, while it is probable that the expanse of wing never exceeds 12 feet. The head and neck are destitute of feathers, and the former, which is much flattened above, is in the male crowned with a caruncle, or comb, while the skin of the latter in the same sex lies in folds, forming a wattle, dilatible at pleasure. The adult plumage is of a uniform black, with the exception of a fringe of white feathers nearly surrounding the base of the neck, and certain wing feathers which, especially in the male, have large patches of white. The middle toe is greatly elongated, and the third but slightly developed, while the claws of all the toes are comparatively straight and blunt, and are thus of little use as organs of prehension. The female, contrary to the usual rule among birds of prey, is smaller than the male.

The condor is a native of South America, where it is confined to the region of the Andes, from the Straits of Magellan to 4° north latitude,—the largest condors, it is said, being found about the volcano of Coquimba, situated on the equator. It is often seen on the shores of the Pacific, especially during the rainy season, but its favorite haunts for roosting and breeding are at elevations of 10,000 to 16,000 feet. There, during the months of February and March, on inaccessible ledges of rock, it deposits two white eggs, from 3 to 4 inches in length, its nest consisting merely of a few sticks placed around the eggs. The period of incubation lasts for seven weeks, and the young are covered with a whitish down until almost as large as their parents. They are unable to fly till nearly two years old, and continue for a considerable time after leaving wing to roost and hunt with their parents. The white ruff on the neck, and the similarly colored feathers coated with its success, although it does not seem very appropriate for a child of seven years, the age of the prince. His ideas on the importance of early attention to the cultivation of the reasoning powers and the educational uses of observation and experiment are far from being obsolete.

of the wing, do not appear until the completion of the first moulting. By preference the condor feeds on carrion, but it does not hesitate to attack sheep, goats, and deer, and for this reason it is hunted down by the shepherds, who, it is said, train their dogs to look up and bark at the condors as they fly overhead. They are exceedingly voracious, a single condor of moderate size having been known, according to Orton, to devour a calf, a sheep, and a dog in a single week. When thus gorged with food, they are exceedingly stupid, and may then be readily caught. For this purpose a horse or mule is killed, and the carcass surrounded with palisades to which the condors are soon attracted by the prospect of food, for the weight of evidence seems to favor the opinion that those vultures owe their knowledge of the presence of carrion more to sight than to scent. Having feasted themselves to excess, they are set upon by the hunters with sticks, and being unable, owing to the want of space within the pen, to take the run without which they are unable to rise on wing, they are readily killed or captured. They sleep during the greater part of the day, searching for food in the clearer light of morning and evening. They are remarkably heavy sleepers, and are readily captured by the inhabitants ascending the trees on which they roost, and noosing them before they awaken. Great numbers of condors are thus taken alive, and these, in certain districts, are employed in a variety of bull-fighting. They are exceedingly tenacious of life, and can exist, it is said, without food for over forty days. Although the favorite haunts of the condor are at the level of perpetual snow, yet it rises to a much greater height, Humboldt having observed it flying over Chimborazo at a height of over 23,000 feet. "No other living creature," says a recent traveller in the Andes, "can remove at pleasure so great a distance from the earth, and it seems to fly and respire as easily under the low barometric pressure of 13 inches as at the sea-shore. It can dart in an instant from the dome of Chimborazo to the sultry coast of the Pacific." In walking it trails its wings on the ground, and has an exceedingly awkward gait, but on wing the movements of the condor, as it wheels in majestic circles, are remarkably graceful. The birds flap their wings on rising from the ground, but after attaining a moderate elevation they seem to sail on the air, Darwin having watched them for half an hour without once observing a flap of their wings. There is a brown condor, "condor pardo," which naturalists have generally regarded as the young of the "condor negro." Recent investigations have, however, proved it to be a distinct species. It has been named *Sarcorhamphus cequatorialis*.

CONDORCET, MARIE JEAN ANTOINE NICOLAS CARITAT, MARQUIS DE, was born at Ribemont, in Picardy, on the 17th September, 1743. He descended from an ancient family who took their title from the castle of Condorcet, near Nion, in Dauphiny. He was educated at the Jesuit College in Rheims and at the College of Navarre in Paris, and early displayed the most varied mental activity. His first public distinctions were gained in the department of mathematics. At the age of sixteen, his performances in analysis elicited high commendation from D'Alembert and Clairaut, and at the age of twenty-two he composed a treatise on the integral calculus which obtained warm and general approbation from the most competent judges. With his many-sided intellect and richly-endowed emotional nature, however, it was impossible for him to be a mere specialist, and least of all to be a mere mathematician. Philosophy and literature attracted him no less than geometry or the calculus, and social action, work for the public weal, was dearer to him than any form of intellectual exercise. In the year 1769 he was received as a member of the Academy of Sciences. His contributions to its memoirs are numerous, and many of them are on the most abstruse and difficult mathematical problems. Being of a very genial, susceptible, and enthusiastic disposition, he was the friend of almost all the distinguished men of his time, and a zealous propagator of the religious and political views then current among the literati of France. D'Alembert, Turgot, and Voltaire, for whom he had great affection and veneration, and by whom he was highly respected and esteemed, contributed largely to the formation of his opinions. His *Lettre d'un laboureur de Picardie à M. Necker* was written under the inspiration of Turgot, in defence of free internal trade in corn. His *Lettre d'un théologien*, &c., was attributed to Voltaire, being

impregnated throughout with the Voltairian anti-religious spirit. He was induced by D'Alembert to take an active part in the preparation of the *Encyclopædia*. His *Éloges des Académiciens de l'Académie Royale des Sciences morts depuis 1666 jusqu'en 1699* (1773) gained him the merited reputation of being an eloquent and graceful writer. He was elected to the perpetual secretaryship of the Academy of Sciences in 1777, and was received into the French Academy in 1782. Three years afterwards he published a work on the application of the mathematical theory of probabilities to judicial decisions. This work is admitted to have demonstrated that the calculus had a wider range than had previously been suspected, and to have permanently secured for its author a distinguished place in the history of the doctrine of probability. A second edition of it greatly enlarged and completely recast and revised appeared in 1804, ten years after his death, under the title of *Éléments du calcul des probabilités et son application aux jeux de hasard, à la loterie, et aux jugements des hommes, &c.* He married in 1786 a sister of Marshal Grouchy and Madame Cabanis. His wife, said to have been one of the most beautiful women of her time, is known in literature by her excellent translation of Adam Smith's *Theory of Moral Sentiments*. In 1786 Condorcet published his *Vie de Turgot*, and in 1787 his *Vie de Voltaire*. Both works were widely and eagerly read, and are perhaps, from a merely literary point of view, the best of Condorcet's writings.

The political tempest which had been long gathering over France now began to break and to carry everything before it. Condorcet was, of course, at once hurried along by it into the midst of the conflicts and confusion of the Revolution. He greeted with enthusiasm the advent of democracy, and labored hard to secure and hasten its triumph. He was indefatigable in writing pamphlets, suggesting reforms, and planning constitutions. The first political functions which he exercised were those of a member of the municipality of Paris. He was next chosen by the Parisians to represent them in the Legislative Assembly, and then appointed by that body one of its secretaries. In this capacity he drew up most of its addresses, but seldom ascended the tribune, his pen being a more effective weapon than his tongue. He was the chief author of the address to the European powers when they threatened France with war. He devised likewise a bold and comprehensive scheme for the organization of public instruction, and not only brought it before the Assembly but published an exposition of it in five elaborate memoirs. In the Convention he sat for the department of the Aisne. At the trial of Louis XVI. he voted the king guilty of conspiring against liberty, and worthy of any punishment short of death, but recommended an appeal to the people. He took an active part in the framing of a constitution, which was laid before the Convention in February, 1793, with an elaborate prefatory dissertation of Condorcet's composition, but another was introduced, adopted, and decreed. Condorcet's severe criticism of this latter document, his denunciation of the arrest of the Girondists, and his objection to the violent conduct of the Mountain, led to his being accused of conspiring against the Republic. He was condemned and declared to be *hors la loi*. Friends sought for him an asylum in the house of a Madame Vernet. Without even requesting to know his name, this truly heroic woman, as soon as she was assured that he was an honest and virtuous man, said, "Let him come, and lose not a moment, for while we talk he may be seized." When the execution of the Girondists showed him that his presence exposed his protectress to a terrible danger, he resolved to seek a refuge elsewhere. "I am outlawed," he said, "and if I am discovered you will meet the same sad end as myself. I must not stay." Madame Vernet's reply deserves to be immortal, and should be given in her own words: "La Convention, Monsieur, a le droit de mettre hors la loi: elle n'a pas le pouvoir de mettre hors de l'humanité; vous resterez." From that time she had his movements strictly watched lest he should attempt to quit her house. It was partly to turn his mind from the idea of attempting this, by occupying it otherwise, that his wife and some of his friends, with the co-operation of Madame Vernet, prevailed on him to engage in the composition of the work by which he is best known—the *Esquisse d'un tableau historique des progrès de l'esprit humain*. Certain circumstances having led him

to believe that the house of Madame Vernet, 21 Rue Servandoni, was suspected and watched by his enemies, he, by a fatally successful artifice, baffled the vigilance of his generous friend and escaped. Disappointed in finding even a night's shelter at the chateau of one whom he had befriended, he had to hide for three days and nights in the thickets and stone-quarries of Clamart. On the evening of the 7th April, 1794—not, as Carlyle says, on a "bleared May morning,"—with garments torn, with wounded leg, with famished looks, he entered a tavern in the village named, and called for an omelette. "How many eggs in your omelette?" "A dozen." "What is your trade?" "A carpenter." "Carpenters have not hands like these, and do not ask for a dozen eggs in an omelette." When his papers were demanded he had none to show; when his person was searched a Horace was found on him. The villagers seized him, bound him, haled him forthwith on bleeding feet towards Bourg-la-Reine; he fainted by the way, was set on a horse offered in pity by a passing peasant, and, at the journey's end, was cast into the cold, damp prison-cell. When the jailers looked in on the morning his body lay dead on the floor. Whether he had died from suffering and exhaustion, from apoplexy, or from poison, is an undetermined question.

Condorcet held many opinions which comparatively few will be found ready to indorse, but he was undoubtedly a most sincere, generous, and noble-minded man. He was eager in the pursuit of truth, ardent in his love of human good, and ever ready to undertake labor or encounter danger on behalf of the philanthropic plans which his fertile mind contrived and his benevolent heart inspired. He lived at a time when calumny was rife, and various slanders were circulated regarding him, but fortunately the slightest examination proves them to have been inexcusable fabrications. That while openly opposing royalty he was secretly soliciting the office of tutor to the Dauphin; that he was accessory to the murder of the Duc de la Rochefoucauld; or that he sanctioned the burning of the literary treasures of the learned congregations, are stories which can be distinctly shown to be utterly untrue.

Condorcet's philosophical fame is chiefly associated with the work which he wrote when lying concealed from the emissaries of Robespierre in the house of Madame Vernet. With the vision of the guillotine before him, with confusion and violence around him, he comforted himself by trying to demonstrate that the evils of life had arisen from a conspiracy of priests and rulers against their fellows, and from the bad laws and institutions which they had succeeded in creating, but that the human race would finally conquer its enemies and completely free itself of its evils. His fundamental idea is that of a human perfectibility which has manifested itself in continuous progress in the past, and must lead to indefinite progress in the future. He represents man as starting from the lowest stage of barbarism, with no superiority over the other animals which does not result directly from superiority of bodily organization, and as advancing uninterruptedly, at a more or less rapid rate, in the path of enlightenment, virtue, and happiness. The stages which the human race has already gone through, or, in other words, the great epochs of history, are regarded as nine in number. The first three can confessedly be described only conjecturally from general observations as to the development of the human faculties, and the analogies of savage life. In the first epoch, men are united into hordes of hunters and fishers, who acknowledge in some degree public authority and the claims of family relationship, and who make use of an articulate language. In the second epoch—the pastoral state—property is introduced, and along with it inequality of conditions, and even slavery, but also leisure to cultivate intelligence, to invent some of the simpler arts, and to acquire some of the more elementary truths of science. In the third epoch—the agricultural state—as leisure and wealth are greater, labor better distributed and applied, and the means of communication increased and extended, progress is still more rapid. With the invention of alphabetical writing the conjectural part of history closes and the more or less authenticated part commences. The fourth and the fifth epochs are represented as corresponding to Greece and Rome. The Middle Ages are divided into two epochs, the former of which terminates with the

Crusades, and the latter with the invention of printing. The eighth epoch extends from the invention of printing to the revolution in the method of philosophic thinking accomplished by Descartes. And the ninth epoch begins with that great intellectual revolution, and ends with the great political and moral Revolution of 1789, and is illustrious, according to Condorcet, through the discovery of the true system of the physical universe by Newton, of human nature by Locke and Condillac, and of society by Turgot, Price, and Rousseau. There is an epoch of the future—a tenth epoch,—and the most original part of Condorcet's treatise is that which is devoted to it. After insisting that general laws regulative of the past warrant general inferences as to the future, he argues that the three tendencies which the entire history of the past shows will be characteristic features of the future are:—(1) the destruction of inequality between nations; (2) the destruction of inequality between classes; and (3) the improvement of individuals, the indefinite perfectibility of human nature itself—intellectually, morally, and physically. These propositions have been much misunderstood. The equality to which he represents nations and individuals as tending is not absolute equality, but equality of freedom and of rights. It is that equality which would make the inequality of the natural advantages and faculties of each community and person beneficial to all. Nations and men, he thinks, are equal, if equally free, and are all tending to equality because all tending to freedom. As to indefinite perfectibility, he nowhere denies that progress is conditioned both by the constitution of humanity and the character of its surroundings. But he affirms that these conditions are compatible with endless progress, and that the human mind can assign no fixed limits to its own advancement in knowledge and virtue, or even to the prolongation of bodily life.

The book of Condorcet is pervaded by a spirit of excessive hopefulness, and contains numerous errors of detail, which are fully accounted for by the circumstances in which it was written. Its value lies entirely in its general ideas. Its chief defects spring from its author's narrow and fanatical aversion to all philosophy which did not attempt to explain the world exclusively on mechanical and sensational principles, to all religion whatever, and especially to Christianity and Christian institutions, and to monarchy.

Of the two editions of Condorcet's works which have been published, the earlier is in 21, and the later, to which is prefixed a *Biographie de Condorcet*, by M. Arago, is in 10 volumes. There is an able essay on Condorcet in Mr. J. Morley's *Critical Miscellanies*. On Condorcet as an historical philosopher see A. Comte's *Cours de Philosophie Positive*, iv. 252–253, and *Système de Politique Positive*, iv., Appendice Général, 109–111; Laurent's *Études*, xli. 121–126; Morley's *Crit. Misc.*, 89–110; and Flint's *Philosophy of History in France and Germany*, i. 125–138.

(R. F.)

**CONDOTTIERI.** The condottieri (Italian, *condottiere*, captain, from *condotta*, conduct, *condurre*, to lead; Latin, *conducere*) were leaders of military companies, often numerous enough to constitute a large army, which they used to hire out to carry on the wars of the Italian states. The condottieri played a very important part in Italian history during the 14th and 15th centuries, especially from the middle of the 14th to the middle of the 15th. The explanation of their origin is to be sought in the special circumstances of Italy towards the close of the Middle Ages. The republics and lordships into which the country was divided were incessantly engaged in war, while the arts of peace and luxury were cultivated to such a degree that the military spirit of the people had greatly declined in comparison with the rest of Europe. In many cities, such as Milan, tyrants had begun to supersede the old republican governments, and they found it much safer to engage a mercenary army to fight their battles than to arm their own subjects. Soldiers of foreign armies, which then as afterwards not seldom overran the Italian soil, did not always return, but often stayed with their feudal leaders, and lived at free quarters. Montreal d'Albano, a gentleman of the Provence, was the first to give a definite form to these lawless bands. A severe discipline and an elaborate organization were introduced within the company itself, while in their relations to the people the most barbaric license was permitted. Montreal himself was put to

death at Rome by Cola di Rienzi, and Count Lando succeeded to the command. The Grand Company, as it was called, soon numbered about 7000 cavalry and 1500 select infantry, and was for some years the terror of Italy. They seem to have been Germans chiefly. On the conclusion (1360) of the peace of Bretigny between England and France, Sir John Hawkwood, an able general, led an army of English mercenaries, called the White Company, into Italy, which, in the service of Pisa, and afterwards of Florence, took a prominent part in the confused interminable wars of the next thirty years. Towards the end of the century the Italians began to organize armies of the same description, the first of importance being the company of St. George, originated by Alberigo, count of Barbiano. The defeat of the German emperor, Rupert, by the great condottiere, Jacopo del Verme, due to the superior equipment and organization of the Italian army, taught the northern barbarians to respect the skill of the south. Shortly after, the organization of these mercenary armies was carried to the highest perfection by Sforza Attendolo, condottiere in the service of Naples, who had been a peasant of the Romagna, and by his rival Braccio di Montone in the service of Florence. The army and the renown of Sforza were inherited by his son Francesco Sforza, who married a natural daughter of one of the Visconti of Milan, conducted the wars of that city against Venice, and eventually became duke of Milan (1450), which his family continued to rule for some generations. Less fortunate was another great condottiere, Carmagnola, who first served one of the Visconti, and then conducted the wars of Venice against his former masters, but at last awoke the suspicion of the Venetian oligarchy, and was put to death before the palace of St. Mark (1432). Towards the end of the 15th century, when the large cities had gradually swallowed up the small states, and Italy itself was drawn into the general current of European politics, and became the battle-field of powerful armies,—French, Spanish, and German,—the condottieri disappeared. The soldiers of the condottieri were almost entirely cavalry, and were clad in armor from head to foot. Not being connected with the people among whom they fought by any of the ordinary ties of humanity, and given up to all the license of the worst profession in the world, they were a dreadful scourge wherever they went. They were always ready to change sides at the prospect of higher pay. And as they were connected with each other by the interest of a common profession, and the possibility that the enemy of to-day might be the friend and fellow-soldier of to-morrow, their battles were often as bloodless as they were theatrical. Splendidly equipped armies of several thousand strong were known to fight for several hours with hardly the loss of a man. (See Symonds's *Renaissance in Italy: the Age of the Despots*, ch. ii.)

**CONNECTE, THOMAS**, a French Carmelite monk and preacher, was born at Rennes. He travelled through Flanders and Picardy, denouncing the vices of the clergy and the extravagant dress of the women, especially their lofty head-dresses, or *hennins*. He ventured to teach that he who is a true servant of God need fear no Papal curse, that the Roman hierarchy is corrupt, and that marriage is permissible to the clergy, of whom only some have the gift of continence. He was listened to by immense congregations; and it is said that one of the means he employed to maintain his reputation as a preacher was never allowing himself to be seen in private. From Flanders, where his sumptuary reform disappeared with his departure, he passed to Italy, and, despite the opposition of Nicolas Kenton, provincial of the Carmelites, he introduced several changes into the rules of that order. But at length he was seized by order of the Pope, condemned, and burnt for heresy (1434).

**CONEGLIANO**, a town of Italy, in the province of Treviso, on the River Muteva, with a station on the railway from Venice to Trieste, about 36 miles north of the former city. It is commanded by a large castle on a neighboring height, and it possesses a cathedral, two conventual buildings, a number of benevolent institutions, and a triumphal arch erected in honor of the Emperor Francis I. of Austria. Several of the private houses were adorned with frescoes by Pordenone; and the cathedral and the church of S. Fiore preserve the handiwork of Cima da Conegliano, an eminent artist born in the town. Marshal Mouncey bore the title of duke of Conegliano. Population about 6000.

**CONFARREATIO**, a ceremony observed among the ancient Romans at the nuptials of those persons more particularly whose children were destined to be vestal virgins or *flamines diales*. *Confarreatio* was the most solemn of the three forms of marriage, but in later times the ceremony fell into disuse, and Cicero mentions but two, namely, *coemptio* and *usus*. The name is said to have originated in the bride and bridegroom sharing a cake of salted wheaten bread (*far* or *panis farreus*), in the presence of the *pontifex maximus*, or *flamen dialis*, who performed the ceremony. This form of marriage could only be dissolved by another equally solemn ceremony, which was called *disfarreatio*. The names *patrimi* and *matrimi* were applied to children sprung from this kind of marriage.

**CONFECTIONERY**, a term of rather vague application, but which may be held to embrace all preparations which have sugar for their basis or principal ingredient. In this way it may be said to include the preservation of fruits by means of sugar, the manufacture of jams and jellies, the art of preparing fruit-syrups and pastes, ices, and sweetened beverages, in addition to the various manufactures in which sugar is the more prominent and principal ingredient. The variety of the preparations thus indicated is unlimited; and we can here but notice the branches of the manufacture of sugar preparations, such as lozenges, comfits, &c., which now constitute an extensive industry.

The simplest form in which sugar is prepared as a sweet for eating is that of *lozenges*. These are simply refined sugar ground to a very fine powder, mixed with dissolved gum, and flavored with essential oil or other ingredients. The appliances for making lozenges on the large scale, and the processes through which the materials pass, are in many respects similar to those used in biscuit baking. The fine loaf sugar is ground to an impalpable powder between a pair of millstones, after which it is mixed with dissolved gum arabic sufficient to form a very stiff dough, and the whole is thoroughly incorporated in a mechanical mixer similar to Vicker's dough-mixing machine (see **BAKING**). The doughy mass is then rendered homogeneous and reduced to a uniform cake by repeatedly passing pieces backward and forward between a pair of heavy metal rollers, the surfaces being kept from adhering by being dusted with starch flour. The cake, when sufficiently spread out, is transferred to a piece of tough web paper, and passed by an intermittent motion under a frame of cutters of the size and form of the lozenges to be formed. These punch out and take up the lozenges, and when the tube of the cutters is well filled, the whole frame is turned over, and the cut out lozenges emptied into a tray. The scrap passes along on the web, and is again rolled out into cakes with the paste from the mixer. Nothing further is done with the lozenges than allowing them to dry and harden on trays in racks in a heated apartment. Lozenges are colored and flavored with a great variety of ingredients, which are added in proper proportions with the dissolved gum. Medicated lozenges of many kinds are in extensive use, the various medicinal ingredients being similarly incorporated with the gum.

Hard confections, or *comfits*, constitute the second leading variety of confectionery. To make these a core or centre of some kind is required, and this may consist either of a seed or fruit, as a coriander or an almond; or it may be a small lozenge, as in the case of pan drops. Around such a core are deposited successive layers of sugar, and there is no limit to the size to which such comfits may be made. The cores are placed in large copper pans or vessels, which are geared to revolve at an inclined angle, so that by their revolution their contents keep constantly in motion, tumbling over each other. The copper pans are revolved by steam or other power, and they are kept hot by a steam jacket or double casing, into which steam is admitted through the centre on which the pans revolve. A pure strained syrup of sugar is prepared, a quantity of which is periodically applied to the contents of the pan as they appear to get dry, and after receiving a certain coating, the comfits in progress of manufacture are removed to dry and harden for some time. The comfits thus receive alternate coatings in the pan and dryings till they attain the size wanted, when they are finished with a coating of thin syrup, which may be colored if required, and long continued friction in the pan. After hardening in a drying

apartment these comfits are ready for use. A great variety of seeds and fruits are used as cores, the principal of which are almonds, caraways, corianders, cloves, cassia, pistachios, and perfumed cherry kernels.

Many forms of confection are prepared from solutions of sugar, which are boiled up to the point of crystallization. Of these ordinary *sugar candy*, or crystallized sugar, may be taken as the type. It is prepared from solutions of either brown or refined sugar, to the latter of which cochineal or some other coloring ingredient is frequently added. These solutions, when boiled to a proper degree, are poured into moulds across which at sufficient intervals are stretched pieces of string. The sugar gradually crystallizes from its solution on the sides of the mould and on the string,—it being in the mean time kept in an apartment heated from 90° to 100° Fahr. When sufficiently deposited, the remaining liquor is drained off, and the crystals removed and dried in a high uniform heat. *Fondants*, in the preparation of which the French confectioners excel, are made from solutions boiled to the point of crystallization, properly colored and flavored, and cast into moulds made of starch. *Sugar drops* are made from fine sugar mixed with a small proportion of water and coloring and flavoring material as desired. The mixture is dissolved by heat without allowing it to boil, and it is then poured in separate drops on a sheet of paper, on which they quickly set and harden.

What is termed boiled sugar, that is, sugar which has been boiled till, on cooling and hardening, it assumes a glassy appearance and fracture, is the basis of another extensive variety of confectionery. Of this class *barley sugar* is the type and simplest example. It merely consists of sugar boiled as above indicated, flavored with a little oil of lemon, poured on a marble slab, cut into strips, and rolled or twisted into sticks. Boiled sugar is prepared in innumerable fanciful forms by passing it, while still in a viscous condition, through small machines in which pairs of brass rollers, having patterns sunk in their surface, stamp these patterns in the plastic material. It is also worked up into the form of balls, plaited into coils, and formed into party-colored stalks, &c. By vigorous and long-continued drawing out of boiled sugar, while it is in a plastic condition, the molecular structure of the material is changed, and from being glassy and transparent it becomes opaque, porous, and granular in appearance. In this way the preparation known as *rock* is manufactured. Various preparations of chocolate are largely used as confectionery (see **CHOCOLATE**).

**CONFESSION** is a verbal acknowledgment of sin. Among the Jews it was the custom, on the annual feast of expiation, for the high priest to make confession of sins to God in the name of the whole people. Besides this general confession, the Jews were enjoined, as a first principle of their religion, to confess their sins individually to God. Herein, indeed, lay one marked and leading feature of difference between their creed and that of the heathen around them. The Jew was taught to regard his Maker as a merciful God, who forgives sin (Mic. vii. 18, 19; Isa. lvii. 16–19). While, however, the contrite heart was insisted on as the all-important element on man's part, outward signs of humiliation were valued as tokens and manifestations of the inward sentiment, as is seen in such cases as those of David, Ahab, and the captives who returned from Babylon (2 Sam. xii. 16; 1 Kings xxii. 27; Neh. ix. 2, 3). Such conduct implied admission of wrong-doing before man as well as before heaven. In some cases, as in that of Achan (Josh. vii. 19), acknowledgment before man was demanded. In others, as in those involving sin or trespass offerings, some degree of acknowledgment to the priest seems to be implied (Lev. iv. v.). Restitution of things stolen, and general reparation for injustice were also enjoined (Ezek. xxxiii. 15, &c.) as evidences of sincerity.

In the Christian church public offenders were from an early period put to open penance. We find St. Paul enjoining this, but subsequently interceding that the offender be not dealt with too severely (1 Cor. v. 2; 2 Cor. ii. 6, 7). The growth of private (or *auricular*) confession is more difficult to trace. Even those who would be most inclined to represent it as primitive admit that for the first three centuries little or no mention is made of any such practice; and though they would fain attribute such silence to persecution, or to the reserve known as the *disciplina arcani*, they seem inclined to admit that private confession was a development, and grew up gradually. Passages from the

fathers, such as St. Cyprian, St. Basil, St. Gregory of Nyssa, and others, recommending the practice, have to be confronted with the small prominence given to it in the works of St. Augustine and the strong declarations of St. Chrysostom on the sufficiency of confession to God. But the practice gradually became more common, especially in the West, and more a matter of rule and precept; until at length, in the fourth Lateran Council, held under Pope Innocent III., in 1215, it was enjoined upon all members of the Church of Rome once a year, by the famous 21st canon, beginning with the words, *Omnis utriusque sexus fidelis*. The mediæval church of the West fixed the number of sacraments as seven, and insisted on auricular confession as an essential part of the sacrament of penance. Confession and absolution was reserved for the priesthood. Yet a certain recognition of a quasi-priestly power, residing in the church at large, and in some sense therefore in the laity, appears in the Roman office-books, and we find laymen, in cases of extreme emergency, confessing and absolving each other. (An instance occurs in one of the earliest and most admirable of French biographies, Joinville's *Life of St. Louis*.) Russia appears now to be the country where, at least in theory, confession is most insisted upon, as a certificate of annual confession (often, it is said, purchased) is a condition of being a witness in court.

At the Reformation the reformed communities were unanimous in rejecting enforced auricular confession, but it is a mistake to suppose that they were equally unanimous in reprobating its use in cases where it was sought by the free choice of penitents. The Augsburg Confession (part i. art. 11) retains it, and Melancthon asserts that many frequently availed themselves of it. Luther did not even deny its claim to a sacramental character; nor has it ever died out among the Lutherans. But the sacramental character is denied by Calvin and the Calvinistic churches generally. Peter Martyr, Chamier, and others seem to identify absolution with the preaching of God's Word. Nevertheless absolution still retained, for a long time, a disciplinary character even among these bodies. Thus we find the Scottish ministers offering absolution to the marquis of Montrose before his execution at Edinburgh on May 21, 1650; and his refusal seems, according to the historian Burton, to have influenced his enemies in the matter of the sepulture granted to his remains. Private confession also finds a place in the English-prayer-book and homilies. Before the Revolution of 1688 it was so far common that we find Bishop Burnet, in his *History of His Own Times*, naming this or that clergyman as confessor in the family of such and such a nobleman. To divulge anything thus confided is as strictly forbidden in the reformed English as in the mediæval or modern Roman church, though an exception is made in the English canons in the case of such crimes as might endanger the life of the recipient of the confession by making him an accessory in the eye of the law.

The connection of confession with casuistry and with the morality of nations, cannot be discussed here. As regards casuistry, it must suffice to allude to the great name of Pascal, and the controversy arising out of his celebrated *Lettres Provinciales*. The question of its effect on morality is still more complex and difficult to estimate. As a rule, we may expect to find its influence well spoken of by Roman Catholics and the reverse in the opposite camps; nevertheless, some Protestant writers, as Hallam, and perhaps Sismondi, appear to view it with a certain amount of tolerance and even favor, while some Roman Catholic writers (e.g., Vitellascchi, under the pseudonym *Pomponio Leto*), on the contrary, seem inclined to censure at any rate its extreme development in the form of direction, as injurious to proper self-reliance and independence of character.

It remains to add, that the terms *confessor* and *confessional* are used by ecclesiastical writers in very distinct senses, which can only be judged of by the context in which they are found. The statement that a given priest is the confessor—say of the king of Spain—means, of course, that he is the person to whom that sovereign confesses; but the term found simply after a name, as "St. Leonard, confessor," means that the person so designated underwent more or less of suffering on behalf of the Christian faith, though he may not have been an actual martyr. This latter sense is the usual one in ancient writers. In like

manner the term *confessional*, which is now commonly employed to signify the structure placed in Roman Catholic churches for the purpose of hearing confessions, meant originally, in Christian antiquity, the place where a martyr had been buried. It was subsequently applied to a tomb built over a spot thus hallowed either in the crypt or in the upper part of a church.

The authorities on the subject embrace, as has been seen, acts of councils, confessions of faith, and an abundance of controversial works. The foreign Reformers—Luther, Melancthon, Calvin, Zwingli—have all touched upon it in their writings. Among Anglican works may be named Jewel's *Apology*, and Marshall's *Penitential Discipline of the Early Church* (republished in the Anglo-Catholic Library, 1844), and various modern *Catene* of authorities, as Gray's *Statement on Confession*. The Roman Catholic view is set forth in such works as Klee's *Dogmatik and History of Dogmas* (Mayence, 1834, 1838), and Martigny's *Dictionnaire des antiquités chrétiennes*, Paris, 1865. The subject is a prominent one in the Acts of the Council of Trent, and for the fourth Lateran Council the student may refer to Labbé's *Concilia* (tom. vii., Paris, 1714). (J. G. C.)

CONFIRMATION, an ecclesiastical term denoting the laying on of hands, in the admission of baptized persons to the enjoyment of full Christian privileges. The antiquity of this ceremony is, by all the older writers, carried as high as the apostles, and founded upon their example and practice. In the primitive church the ceremony was performed immediately after baptism, if the bishop were present at the solemnity. Among the Greeks, and throughout the East, it still accompanies baptism; but the Roman Catholics make it a distinct and independent sacrament. Seven years is the stated but not the uniform age for confirmation. The view put forth in the English prayer-book is, that the person confirmed releases his godfather and godmother, by taking upon himself the baptismal vows in their place,—an aspect of the matter not apparently recognized in the ancient church, which regarded it almost exclusively as a means of grace and a preparation for the reception of the Holy Communion. This ordinance is usually reserved for the bishop only. It has, however, always been a moot point, whether he may not delegate a presbyter to perform it for him. Such delegation is not uncommon in the Eastern Churches, but is practically unknown in the West. The Calvinists (in common with most non-episcopal communities) have always rejected confirmation.

CONFUCIUS, the famous sage of China (550 or 551–478 B. C.). They are very few among all the millions of the Chinese people who would not heartily repeat the lines with which the first paragraph in a popular history of the sage concludes:—

"Confucius! Confucius! How great was Confucius!  
Before him there was no Confucius,  
Since him there has been no other.  
Confucius! Confucius! How great was Confucius!"

The man whose memory is thus cherished by a third portion of the human race, and the Condition of China in stamp of whose character and teachings is still time of Confucius. impressed, after so long a time, on the institutions of his country, demands our careful study. In order to understand the events of his life and the influence of his opinions, we must endeavor to get some impression of the China that existed in his time, in the 5th and 6th centuries before our Christian era.

The dynasty of Chow, the third which within historic time had ruled the country, lasting from 1122 to 256 B. C., had passed its zenith, and its kings no longer held the sceptre with a firm grasp. It must not be supposed that the territory under their sway extended over all the eighteen provinces which now constitute what is called "China proper." It was not a sixth part of the present empire. On the south it hardly reached half way from the Ho, or Yellow River, to the Kiang, or Yang-tze. Cheh-kiang, Kiang-si, Hu-nan, Fuh-kien, Kwang-tung, Kwang-si, Kwei-chow, and the great provinces of Yunnan, Sze-ch'uen, and Kan-suh on the west, were thinly peopled by barbarous tribes which acknowledged no subjection to "the Middle States." Ho-nan and Shan-si, with portions of Shen-si, Chih-li, Shan-tung, Gan-hwui, Kiang-su, and Hu-pih, were all which formed the dominions of Chow. For thirteen years of his life Confucius wandered about from state to state, seeking rest and patrons; but his journeyings were confined within the mod-

ern provinces of Ho-nan and Shan-tung, and the borders of Chih-li and Hu-pih. Many Europeans now living have travelled over much more of China than he did. The fact helps us to realize the relation of Confucius to his age, and it shows us that he gained his high position through his own unaided powers and the influences of his native country. It has never been hinted, as in the case of his contemporary, the founder of Taoism, that he learned anything from abroad.

Within this China of the Chow dynasty there might be a population, in Confucius's time, of from 10,000,000 to 15,000,000. We read frequently, in the classical books, of the "ten thousand states," in which the people were distributed; but that is merely a grand exaggeration. In what has been called, though erroneously, as we shall see, *Confucius's History of his Own Times*, we find only 13 states of note, and the number of all the states, large and small, which can be brought together from it, and the much more extensive supplement to it by Tso K'iu-ming, not much posterior to the sage, is under 150.

Chow was a feudal kingdom. The lords of the different territories belonged to five orders of nobility, corresponding closely to the dukes, marquises, earls, counts, and barons of feudal Europe. The theory of the constitution required that the princes, on every fresh succession, should receive investiture from the king, and thereafter appear at his court at stated times. They paid to him annually certain specified tributes, and might be called out with their military levies at any time in his service. A feudal kingdom was sure to be a prey to disorder unless there were energy and ability in the character and administration of the sovereign; and Confucius has sketched, in the work referred to above, the *Annals of Lu*, his native state, for 242 years, from 722 to 481 B.C., which might almost be summed up in the words: "In those days there was no king in China, and every prince did what was right in his own eyes." In 770 B.C. a northern horde had plundered the capital, which was then in the present department of Si-gan, Shen-si, and killed the king, whose son withdrew across the Ho and established himself in a new centre, near the present city of Loh-yang, in Ho-nan; but from that time the prestige of Chow was gone. Its representatives continued for four centuries and a half with the title of king, but they were less powerful than several of their feudatories. The *Annals of Lu*, enlarged by Tso K'iu-ming so as to embrace the history of the kingdom generally, are as full of life and interest as the pages of Froissart. Feats of arms, great battles, heroic virtues, devoted friendships, and atrocious crimes make the chronicles of China in the 5th, 6th, and 7th centuries before the birth of Christ as attractive as those of France and England in the 14th and some other centuries after it. There was in China in the former period more of literary culture and of many arts of civilization than there was in Europe in the latter. Not only the royal court, but every feudal court, had its historiographers and musicians. Institutions of an educational character abounded. There were ancient histories and poems, and codes of laws, and books of ceremonies. Yet the period was one of wide-spread and ever-increasing suffering and degeneracy. While the general government was feeble, disorganization was at work in each particular state.

But three things must be kept in mind when we compare feudal China with feudal Europe,—three elements which wrought to give to the former peculiarities of character for which our better acquaintance with the latter will not have prepared us. First, we must take into account the long duration of the time through which the central authority was devoid of vigor. For about five centuries state was left to contend with state, and clan with clan in the several states. The result was chronic misrule, and misery to the masses of the people, with frequent famines. Secondly, we must take into account the institution of polygamy, with the low status assigned to woman, and the many restraints put upon her. In the ancient poems, indeed, there are a few pieces which are true love-songs, and express a high appreciation of the virtue of their subjects; but there are many more which tell a different tale. The intrigues, quarrels, murders, and grossnesses that grew out of this social condition it is difficult to conceive, and would be impossible to detail. Thirdly, we must take into account the absence of strong and definite religious beliefs, properly so called, which has always

been a characteristic of the Chinese people. We are little troubled, of course, with heresies, and are not shocked by the outbreaks of theological zeal; but where thought as well as action does not reach beyond the limits of earth and time, we do not find man in his best estate. We miss the graces and consolations of faith; we have human efforts and ambitions, but they are unimpregnated with divine impulses and heavenly aspirations.

Confucius appeared, according to Mencius, one of his most distinguished followers (371–288 B.C.), at a crisis in the nation's history. "The world," he says, "had fallen into decay, and right principles had disappeared. Perverse discourses and oppressive deeds were waxen rife. Ministers murdered their rulers, and sons their fathers. Confucius was frightened by what he saw,—and he undertook the work of reformation."

The sage was born, according to the historian Sze-ma Ts'in, in the year 550 B.C.; according to Kung-yang and Kuh-liang, two earlier commentators on his *Annals of Lu*, in 551; but all three agree in the month and day assigned to his birth, which took place in winter. His clan name was K'ung, and it need hardly be stated that Confucius is merely the Latinized form of K'ung Fu-tze, meaning "the philosopher or master K'ung." He was a native of the state of Lu, a part of the modern Shan-tung, embracing the present department of Yen-Chow and other portions of the province. Lu had a great name among the other states of Chow, its marquises being descended from the duke of Chow, the legislator and consolidator of the dynasty which had been founded by his father and brother, the famous kings Wan and Wu. Confucius's own ancestry is traced up, through the sovereigns of the previous dynasty of Shang, to Hwang-ti, whose figure looms out through the mists of fable in prehistoric times. A scion of the house of Shang, the surname of which was Tze, was invested by King Wu with the dukedom of Sung in the present province of Ho-nan. There, in the Tze line, towards the end of the 8th century B.C., we find a K'ung Kia, whose posterity, according to the rules for the dropping of surnames, became the K'ung clan. He was a high officer of loyalty and probity, and unfortunately for himself had a wife of extraordinary beauty. Hwa Tuh, another high officer of the duchy, that he might get this lady into his possession, brought about the death of K'ung Kia, and was carrying his prize in a carriage to his own palace, when she strangled herself on the way. The K'ung family, however, became reduced, and by and by its chief representative moved from Sung to Lu, where in the early part of the 6th century we meet with Shuh-liang Heih, the father of Confucius, as commandant of the district of Tsow, and an officer renowned for his feats of strength and daring.

There was thus no grander lineage in China than that of Confucius; and on all his progenitors, since the throne of Shang passed from their line, with perhaps one exception, he could look back with complacency. He was the son of Heih's old age. That officer, when over seventy years, and having already nine daughters and one son, because that son was a cripple, sought an alliance with a gentleman of the Yen clan, who had three daughters. The father submitted to them Heih's application, saying that, though he was old and austere, he was of most illustrious descent, and they need have no misgivings about him. Ching-tsai, the youngest of the three, observed that it was for their father to decide in the case. "You shall marry him, then," said the father, and accordingly she became the bride of the old man, and in the next year the mother of the sage. It is one of the undesigned coincidences which confirm the credibility of Confucius's history, that his favorite disciple was a scion of the Yen clan.

Heih died in the child's third year, leaving his family in straitened circumstances. Long afterwards, when Confucius was complimented on his acquaintance with many arts, he accounted for it on the ground of the poverty of his youth, which obliged him to acquire a knowledge of matters belonging to a mean condition. When he was five or six, people took notice of his fondness for playing with his companions at setting out sacrifices, and at postures of ceremony. He tells us himself that at fifteen his mind was set on learning; and at nineteen, according to the ancient and modern practice in China, in regard to early unions, he was married,—his wife being from his ancestral state of Sung. A son, the only one, so far as we know, that he



ever had, was born in the following year; but he had subsequently two daughters. Immediately after his marriage we find him employed under the chief of the Ki clan to whose jurisdiction the district of Tsow belonged, first as keeper of stores, and then as superintendent of parks and herds. Mencius says that he undertook such mean offices because of his poverty, and distinguished himself by the efficiency with which he discharged them, without any attempt to become rich.

In his twenty-second year Confucius commenced his labors as a teacher. He did so at first, probably, in a humble way; but a school, not of boys to be taught the elements of learning, but of young and inquiring spirits who wished to be instructed in the principles of right conduct and government, gradually gathered round him. He accepted the substantial aid of his disciples; but he rejected none who could give him even the smallest fee, and he would retain none who did not show earnestness and capacity. "When I have presented," he said, "one corner of a subject, and the pupil cannot of himself make out the other three, I do not repeat my lesson."

Two years after, his mother died, and he buried her in the same grave with his father. Some idea of what his future life was likely to be was already present to his mind. It was not the custom of antiquity to raise any tumulus over graves, but Confucius resolved to innovate in the matter. He would be travelling, he said, to all quarters of the kingdom, and must therefore have a mound by which to recognize his parents' resting-place. He returned home from the interment alone, having left his disciples to complete this work. They were long in rejoining him, and had then to tell him that they had been detained by a heavy fall of rain, which threw down the first product of their labor. He burst into tears, and exclaimed, "Ah! they did not raise mounds over their graves in antiquity." His affection for the memory of his mother and dissatisfaction with his own innovation on ancient customs thus blended together; and we can sympathize with his tears. For the regular period of 27 months, commonly spoken of as three years, he observed all the rules of mourning. When they were over he allowed five more days to elapse before he would take his lute, of which he had been devotedly fond, in his hands. He played, but when he tried to sing to the accompaniment of the instrument, his feelings overcame him.

For some years after this our information about Confucius is scanty. Hints, indeed, occur of his devotion to the study of music and of ancient history; and we can perceive that his character was more and more appreciated by the principal men of Lu. He had passed his thirtieth year when, as he tells us, "he stood firm" in his convictions on all the subjects to the learning of which he had bent his mind fifteen years before. In 517 B. C. two scions of one of the principal houses in Lu joined the company of his disciples in consequence of the dying command of its chief; and being furnished with the means by the marquis of the state, he made a visit with them to the capital of the kingdom. There he examined the treasures of the royal library, and studied the music which was found in its highest style at the court. There, too, according to Ssema Ts'in, he had several interviews with Lao-tze, the father of Taoism. It is characteristic of the two men, that the latter, a transcendental dreamer, appears to have thought little of his visitor, while Confucius, an inquiring thinker, was profoundly impressed with him.

On his return to Lu, in the same year, that state fell into great disorder. The marquis was worsted in a struggle with his ministers, and fled to the neighboring state of Ts'i. Thither also went Confucius, for he would not countenance by his presence the men who had driven their ruler away. He was accompanied by many of his disciples; and as they passed by the T'ai Mountain, an incident occurred, which may be narrated as a specimen of the way in which he communicated to them his lessons. The attention of the travellers was arrested by a woman weeping and wailing at a grave. The sage stopped, and sent one of his followers to ask the reason of her grief. "My husband's father," said she, "was killed here by a tiger, and my husband also, and now my son has met the same fate." Being asked why she did not leave so fatal a spot, she replied that there was there no oppressive government. "Remember this," said Confucius to his disciples, "remember this, my children,

oppressive government is fiercer and more feared than a tiger."

He did not find in Ts'i a home to his liking. The marquis of the state was puzzled how to treat him. The teacher was not a man of rank, and yet the prince felt that he ought to give him more honor than rank could claim. Some counsellors of the court spoke of him as "impracticable and conceited, with a thousand peculiarities." It was proposed to assign to him a considerable revenue, but he would not accept it while his counsels were not followed. Dissatisfactions ensued, and he went back to Lu.

There for fifteen more years he continued in private life, prosecuting his studies, and receiving many accessions to his disciples. He had a difficult part to play with the different parties in the state, but he adroitly kept himself aloof from them all; and at last, in his fifty-second year, he was made chief magistrate of the city of Chung-too. A marvellous reformation, we are told, forthwith ensued in the manners of the people; and the marquis, a younger brother of the one that fled to Ts'i and died there, called him to higher office. He was finally appointed minister of crime,—and there was an end of crime. Two of his disciples at the same time obtained influential positions in the two most powerful clans of the state, and co-operated with him. He signalized his vigor by the punishment of a great officer and in negotiations with the state of Ts'i. He labored to restore to the marquis his proper authority, and as an important step to that end, to dismantle the fortified cities where the great chiefs of clans maintained themselves like the barons of feudal Europe. For a couple of years he seemed to be master of the situation. "He strengthened the ruler," it is said, "and repressed the barons. A transforming government went abroad. Dishonesty and dissoluteness hid their heads. Loyalty and good faith became the characteristics of the men, and chastity and docility those of the women. He was the idol of the people, and flew in songs through their mouths."

The sky of bright promise was soon overcast. The marquis of Ts'i and his advisers saw that if Confucius were allowed to prosecute his course, the influence of Lu would become supreme throughout the kingdom, and Ts'i would be the first to suffer. A large company of beautiful women, trained in music and dancing, and a troop of fine horses, were sent to Lu. The bait took; the women were welcomed, and the sage was neglected. The marquis forgot the lessons of the master, and yielded supinely to the fascinations of the harem. Confucius felt that he must leave the state. The neglect of the marquis to send round, according to rule, among the ministers portions of the flesh after a great sacrifice, furnished a plausible reason for leaving the court. He withdrew, though very unwillingly and slowly, hoping that a change would come over the marquis and his counsellors, and a message of recall be sent to him. But no such message came; and he went forth in his fifty-sixth year to a weary period of wandering among various states.

It may be well to pause here in the sketch of his life, and consider what his object and hope had been.

A disciple once asked him what he would consider the first thing to be done, if intrusted with the government of a state. His reply was, "The rectification of names." When told that such a thing was wide of the mark, he held it to, and indeed his whole social and political system was wrapped up in the saying. He had told the marquis of Ts'i that good government obtained when the ruler was ruler, and the minister minister; when the father was father, and the son son. Society, he considered, was an ordinance of heaven, and was made up of five relationships,—ruler and subject, husband and wife, father and son, elder brothers and younger, and friends. There was rule on the one side of the first four, and submission on the other. The rule should be in righteousness and benevolence; the submission in righteousness and sincerity. Between friends the mutual promotion of virtue should be the guiding principle. It was true that the duties of the several relations were being continually violated by the passions of men, and the social state had become an anarchy. But Confucius had confidence in the preponderating goodness of human nature, and in the power of example in superiors. "Not more surely," he said, "does the grass bend before the wind than the masses yield to the will of those above them." Given

Magistrate and minister of crime.

Grief for loss of his mother.

His ideas of government.

the model ruler, and the model people would forthwith appear. And he himself could make the model ruler. He could tell the princes of the states what they ought to be; and he could point them to examples of perfect virtue in former times,—to the sage founders of their own dynasty; to the sage Tang, who had founded the previous dynasty of Shang; to the sage Yu, who first established a hereditary kingdom in China; and to the greater sages still who lived in a more distant golden age. With his own lessons and those patterns, any ruler of his day, *who would listen to him*, might reform and renovate his own state, and his influence would break forth beyond its limits till the face of the whole kingdom should be filled with a multitudinous relation-keeping, well-fed, happy people. "If any ruler," he once said, "would submit to me as his director for twelve months, I should accomplish something considerable; and in three years I should attain the realization of my hopes." Such were the ideas, the dreams of Confucius. But he had not been able to get the ruler of his native state to listen to him. His sage counsels had melted away before the glance of beauty and the pomps of life.

His professed disciples amounted to 3000, and among them were between 70 and 80 whom he described as "scholars of extraordinary ability." The most attached of them were seldom long away from him. They stood or sat reverently by his side, watched the minutest particulars of his conduct, studied under his direction the ancient history, poetry, and rites of their country, and treasured up every syllable which dropped from his lips. They have told us how he never shot at a bird perching nor fished with a net, the creatures not having in such a case a fair chance for their lives; how he conducted himself in court and among villagers; how he ate his food, and lay in his bed, and sat in his carriage; how he rose up before the old man and the mourner; how he changed countenance when it thundered, and when he saw a grand display of viands at a feast. He was free and unreserved in his intercourse with them, and was hurt once when they seemed to think that he kept back some of his doctrines from them. Several of them were men of mark among the statesmen of the time, and it is the highest testimony to the character of Confucius that he inspired them with feelings of admiration and reverence. It was they who set the example of speaking of him as the greatest of mortal men; it was they who struck the first notes of that pean which has gone on resounding to the present day.

Confucius was, it has been seen, in his fifty-sixth year when he left Lu; and thirteen years elapsed ere he returned to it. In this period were comprised his travels among the different states, when he hoped, and ever hoped in vain, to meet with some prince who would accept him as his counsellor, and initiate a government that should become the centre of an universal reformation. Several of the princes were willing to entertain and support him; but for all that he could say, they would not change their ways.

His first refuge was in Wei, a part of the present Ho-nan, the marquis of which received him kindly; but he was a weak man, ruled by his wife, a woman notorious for her accomplishments and wickedness. In attempting to pass from Wei to another state, Confucius was set upon by a mob, which mistook him for an officer who had made himself hated by his oppressive deeds. He himself was perfectly calm amid the danger, though his followers were filled with alarm. They were obliged, however, to retrace their way to Wei, and he had there to appear before the marchioness, who wished to see how a sage looked. There was a screen between them at the interview, such as the present regent-empresses of China use in giving audience to their ministers; but Tze-lu, one of his principal disciples, was indignant that the master should have demeaned himself to be near such a woman, and to pacify him Confucius swore an oath appealing to Heaven to reject him if he had acted improperly. Soon afterwards he left the state.

Twice again, during his protracted wanderings, he was placed in imminent peril, but he manifested the same fearlessness, and expressed his confidence in the protection of Heaven till his course should be run. On one of the occasions he and his company were in danger of perishing from want, and the courage of even Tze-lu gave way. "Has the superior man, indeed, to endure in this way?" he asked. "The superior man may have to endure want," was the reply, "but he is still the superior man. The

small man in the same circumstances loses his self-command."

While travelling about, Confucius repeatedly came across recluses,—a class of men who had retired from the world in disgust. That there was such a class gives us a striking glimpse into the character of the age. Scholarly and of good principles, they had given up the conflict with the vices and disorder that prevailed. But they did not understand the sage, and felt a contempt for him struggling on against the tide, and always hoping against hope. We get a fine idea of him from his encounters with them. Once he was looking about for a ford, and sent Tze-lu to ask a man who was at work in a neighboring field where it was. The man was a recluse, and having found that his questioner was a disciple of Confucius, he said to him: "Disorder in a swelling flood spreads over the kingdom, and no one is able to repress it. Than follow a master who withdraws from one ruler and another that will not take his advice, had you not better follow those who withdraw from the world altogether?" With these words he resumed his hoe, and would give no information about the ford. Tze-lu went back and reported what the man had said to the master, who observed: "It is impossible to withdraw from the world, and associate with birds and beasts that have no affinity with us. With whom should I associate but with suffering men? The disorder that prevails is what requires my efforts. If right principles ruled through the kingdom, there would be no necessity for me to change its state." We must recognize in these words a brave heart and a noble sympathy. Confucius would not abandon the cause of the people. He would hold on his way to the end. Defeated he might be, but he would be true to his humane and righteous mission.

It was in his sixty-ninth year, 483 B. C., that Confucius returned to Lu. One of his disciples, who had remained in the state, had been successful in the command of a military expedition, and told the prime minister that he had learned his skill in war from his master,—urging his recall, and that thereafter mean persons should not be allowed to come between the ruler and him. The state was now in the hands of the son of the marquis whose neglect had driven the sage away; but Confucius would not again take office. Only a few years remained to him, and he devoted them to the completion of his literary tasks, and the delivery of his lessons to his disciples.

The next year was marked by the death of his son, which he bore with equanimity. His wife had died many years before, and it jars upon us to read how he then commanded the young man to hush his lamentations of sorrow. We like him better when he mourned, as has been related, for his own mother. It is not true, however, as has often been said, that he had divorced his wife before her death. The death of his favorite disciple, Yen Hwui, in 481 B. C., was more trying to him. Then he wept and mourned beyond what seemed to his other followers the bounds of propriety, exclaiming that heaven was destroying him. His own last year, 478 B. C., dawned on him with the tragic end of his next beloved disciple, Tze-lu. His death. Early one morning, we are told, in the fourth month, he got up, and with his hands behind his back, dragging his staff, he moved about his door, crooning over—

"The great mountain must crumble  
The strong beam must break  
The wise man must wither away like a plant."

Tze-kung heard the words and hastened to him. The master told him a dream of the previous night, which, he thought, presaged his death. "No intelligent ruler," he said, "arises to take me as his master. My time has come to die." So it was. He took to his bed, and after seven days expired. Such is the account we have of the last days of the sage of China. His end was not unimpressive, but it was melancholy. Disappointed hopes made his soul bitter. No wife nor child was by to do the offices of affection, nor was the expectation of another life with him, when he passed away from among men. He uttered no prayer, and he betrayed no apprehension. Years before, when he was very ill, and Tze-lu asked leave to pray for him, he expressed a doubt whether such a thing might be done, and added, "I have prayed for a long time." Deep-treasured now in his heart may have been the thought that he had served his generation by the will of God: but he gave no sign.

When their master thus died, his disciples buried him with great pomp. A multitude of them built huts near his grave, and remained there, mourning as for a father, for nearly three years; and when all the rest were gone, Tze-kung, the last of his favorite three, continued alone by the grave for another period of the same duration. The news of his death went through the states as with an electric thrill. The man who had been neglected when alive seemed to become all at once an object of unbounded admiration. The tide began to flow which has hardly ever ebbed during three-and-twenty centuries.

The grave of Confucius is in a large rectangle separated from the rest of the K'ung cemetery, outside the city of K'uh-fow. A magnificent gate gives admission to a fine avenue, lined with cypress trees and conducting to the tomb, a large and lofty mound, with a marble statue in front bearing the inscription of the title given to Confucius under the Sung dynasty:—"The most sagely ancient Teacher; the all-accomplished, all-informed King." A little in front of the tomb, on the left and right, are smaller mounds over the graves of his son and grandson, from the latter of whom we have the remarkable treatise called *The Doctrine of the Mean*. All over the place are imperial tablets of different dynasties, with glowing tributes to the one man whom China delights to honor; and on the right of the grandson's mound is a small house said to mark the place of the hut where Tze-kung passed his nearly five years of loving vigil. On the mound grow cypresses, acacia, what is called "the crystal tree," said not to be elsewhere found, and the *Achillea*, the plant whose stalks were employed in ancient times for purposes of divination.

The adjoining city is still the home of the K'ung family; and there are said to be in it between 40,000 and 50,000 of the descendants of the sage. The present chief of the family is in the line of the 75th generation, and has large estates by imperial gift, with the title of "Duke by imperial appointment and hereditary right, continuator of the sage." It is thus no empty honor which is still given by the sovereigns of China to Confucius, in the persons of his descendants.

The dynasty of Chow finally perished two centuries and a quarter after the death of the sage at the hands of the first historic emperor of the nation,—the first of the dynasty of Ts'in, who swept away the foundations of the feudal system, and laid those of the despotic rule which was subsequently and gradually matured, and continues to the present day. State after state went down before his blows, but the name and followers of Confucius were the chief obstacles in his way. He made an effort to destroy the memory of the sage from off the earth, consigning to the flames all the ancient books from which he drew his rules and examples (save one), and burying alive hundreds of scholars who were ready to swear by his name. But Confucius could not be so extinguished. The tyranny of Ts'in was of short duration, and the next dynasty, that of Han, while entering into the new China, found its surest strength in doing honor to his name, and trying to gather up the wreck of the ancient books. It is a great and a difficult undertaking to determine what there was about Confucius to secure for him the influence which he has wielded. Reference has been made to his literary tasks; but the study of them only renders the undertaking more difficult. He left no writings in which he detailed the principles of his moral and social system. *The Doctrine of the Mean*, by his grandson Tze-sze, and *The Great Learning*, by Ts'ang Sin, the most profound, perhaps, of his disciples, give us the fullest information on that subject, and contain many of his sayings. The *Lun Yu*, or Analects, "Discourses and Dialogues," is a compilation in which many of his disciples must have taken part, and has great value as a record of his ways and utterances; but its chapters are mostly *disjecta membra*, affording faint traces of any guiding method or mind. Mencius, Hsiin K'ing, and writers of the Han dynasty, whose works, however, are more or less apocryphal, tell us much about him and his opinions, but all in a loose and unconnected way. No Chinese writer has ever seriously undertaken to compare him with the philosophers and sages of other nations.

The sage, probably, did not think it necessary to put down many of his own thoughts in writing, for he said of himself that he was a "transmitter, and not a maker." Nor did he lay claim to have any divine revelations. He was not

born, he declared, with knowledge, but was fond of antiquity, and earnest in seeking knowledge there. The rule of life for men in all their relations, he held, was to be found within themselves. The right development of that rule, in the ordering not of the individual only, but of society, was to be found in the words and institutions of the ancient sages.

China, it has already been observed, had a literature before Confucius. All the monuments of it, however, were in danger of perishing through the disorder into which the kingdom had fallen. The feudal system that had subsisted for more than 1500 years had become old. Confucius did not see this—did not see how

"The old order changeth, giving place to new,  
And God fulfils himself in many ways,  
Lest one good custom should corrupt the world."

It was impossible that in his circumstances he should see it. China was in his eyes drifting from its ancient moorings, drifting on a sea of storms "to hideous ruin and combustion;" and the expedient that occurred to him to arrest the evil was to gather up and preserve the records of antiquity, illustrating and commending them by his own teachings. For this purpose he lectured to his disciples on the histories, poems, and constitutional works of the nation. What he thus did was of inestimable value to his own countrymen, and all other men are indebted to him for what they know of China before his time, though all the contents of the ancient works have not come down to us.

He wrote, we are told, a preface to the *Shu King*, or Book of Historical Documents. The preface is, in fact, only a schedule, without any remark by Confucius himself, giving the names of 100 books, of which it consisted. Of these we now possess 59, the oldest going back to the 23d century, and the latest dating in the 8th century B. C. The credibility of the earlier portions, and the genuineness of several of the documents have been questioned, but the collection as a whole is exceedingly valuable.

The *Shi King*, or ancient poems, as existing in his time, or compiled by him (as generally stated, contrary to the evidence in the case), consisted of 311 pieces, of which we possess 305. The latest of them dates 585 years B. C., and the oldest of them ascends perhaps twelve centuries higher. It is the most interesting book of ancient poetry in the world, and many of the pieces are really fine ballads. Confucius was wont to say that he who was not acquainted with the *Shi* was not fit to be conversed with, and that the study of it would produce a mind without a single depraved thought. This is nearly all we have from him about the poems.

The *Li*, or Books of Rites and Ancient Ceremonies and of Institutions, chiefly of the Chow dynasty, have come down to us in a sadly mutilated condition. They are still more than sufficiently voluminous, but they were edited, when recovered under the Han dynasty, with so many additions, that it is hardly worth while to speak of them in connection with Confucius, though much of what was added to them is occupied with his history and sayings.

Of all the ancient books not one was more prized by him than the *Yih King*, or "The Book of Changes," the rudiments of which are assigned to Fuh-hsi in the 30th century B. C. These rudiments, however, are merely the 8 trigrams and 64 diagrams, composed of a whole and a broken line (—, — —), without any text or explanation of them earlier than the rise of the Chow dynasty. The leather thongs, by which the tablets of Confucius's copy were tied together, were thrice worn out by his constant handling. He said that if his life were lengthened he would give fifty years to the study of the *Yih*, and might then be without great faults. This has come down to us entire. If not intended from the first for purposes of divination, it was so used both before and after Confucius, and on that account it was exempted, through the superstition of the emperor of the Ts'in dynasty, from the flames. It is supposed to give a theory of the phenomena of the physical universe, and of moral and political principles by the trigrams and the different lines and numbers of the diagrams of Fuh-hi. Almost every sentence in it is enigmatic. As now published, there are always subjoined to it certain appendixes, which are ascribed to Confucius himself. Pythagoras and he were contemporaries, and in the fragments of the Samian philosopher about the "elements of numbers as the elements of realities" there is a remarkable analogy

with much of the *Yü*. No Chinese critic or foreign student of Chinese literature has yet been able to give a satisfactory account of the book.

But a greater and more serious difficulty is presented by his last literary labor, the work claimed by him as his own, and which has already been referred to more than once as the *Annals of Lu*. Its title is the *Ch'un T'sü*, or "Spring and Autumn," the events of every year being digested under the heads of the four seasons, two of which are used by synecdoche for the whole. Mencius held that the composition of the *Ch'un T'sü* was as great a work as Yu's regulation of the waters of the deluge with which the *Shu King* commences, and did for the face of society what the earlier labor did for the face of nature. This work also has been preserved nearly entire, but it is excessively meagre. The events of 242 years barely furnish an hour or two's reading. Confucius's annals do not bear a greater proportion to the events which they indicate than the headings in our Bibles bear to the contents of the chapters to which they are prefixed. Happily Tso K'iu-ming took it in hand to supply those events, incorporating also others with them, and continuing his narratives over some additional years, so that through him the history of China in all its states, from year to year, for more than two centuries and a half, lies bare before us. Tso never challenges the text of the master as being incorrect, yet he does not warp or modify his own narratives to make them square with it; and the astounding fact is, that when we compare the events with the summary of them, we must pronounce the latter misleading in the extreme. Men are charged with murder who were not guilty of it, and base murders are related as if they had been natural deaths. Villains, over whose fate the reader rejoices, are put down as victims of vile treason, and those who dealt with them as he would have been glad to do are subjected to horrible executions without one word of sympathy. Ignoring, concealing, and misrepresenting are the characteristics of the *Spring and Autumn*.

And yet this work is the model for all historical summaries in China. The want of harmony between the facts and the statements about them is patent to all scholars, and it is the knowledge of this, unacknowledged to themselves, which has made the literati, down to the present day, labor with an astonishing amount of fruitless ingenuity and learning to find in individual words, and the turn of every sentence, some mysterious indication of praise or blame. But the majority of them will admit no flaw in the sage or in his annals. His example in the book has been very injurious to his country. One almost wishes that critical reasons could be found for denying its authenticity. Confucius said that "by the *Spring and Autumn* men would know him and men would condemn him." It certainly obliges us to make a large deduction from our estimate of his character and of the beneficial influence which he has exerted. The examination of his literary labors does not on the whole increase our appreciation of him. We get a higher idea of the man from the accounts which his disciples have given us of his intercourse and conversations with them, and the attempts which they made to present his teachings in some systematic form. If he could not arrest the progress of disorder in his country, nor throw out principles which should be helpful in guiding it to a better state under some new constitutional system, he gave important lessons for the formation of individual character, and the manner in which the duties in the relations of society should be discharged.

Foremost among these we must rank his distinct enunciation of "the golden rule," deduced by him from his study of man's mental constitution. Several times he gave that rule in express words:—"What you do not like when done to yourself do not do to others." The peculiar nature of the Chinese language enabled him to express this rule by one character, which for want of a better term we may translate in English by "reciprocity." When the ideagram is looked at, it tells its meaning to the eye,—"a thing seen weightier than a thing heard." It is composed of two other characters, one denoting "heart," and the other—itsself composite—denoting "as." Tze-kung once asked if there were any one word which would serve as a rule of practice for all one's life, and the master replied, yes, naming this character (心, *shü*), the "as heart," my heart—that is, in sympathy with yours and then he added his usual explanation of it, which has been given above. It

has been said that he only gave the rule in a negative form, but he understood it also in its positive and most comprehensive force, and deplored, on one occasion at least, that he had not himself always attained to taking the initiative in doing to others as he would have them do to him.

Another valuable contribution to ethical and social science was the way in which he inculcated the power of example, and the necessity of benevolence and righteousness in all who were in authority. 1200 years before he was born, an ancient hero and king had proclaimed in China: "The great God has conferred on the people a moral sense, compliance with which would show their nature invariably right. To cause them tranquilly to pursue the course which it indicates is the task of the sovereign." Confucius knew the utterance well; and he carried out the principle of it, and insisted on its application in all the relations of society. He taught emphatically that a bad man was not fit to rule. As a father or a magistrate, he might wield the instruments of authority, and punish the transgressors of his laws, but no forth-putting of force would countervail the influence of his example. On the other hand, it only needed virtue in the higher position to secure it in the lower. This latter side of his teaching is far from being complete and correct, but the former has, no doubt, been a check on the "powers that be," both in the family and the state, ever since Confucius became the acknowledged sage of his country. It has operated both as a restraint upon evil and a stimulus to good.

A few of his more characteristic sayings may here be given, the pith and point of which attest his discrimination of character and show the tendencies of his views:—

"What the superior man seeks is in himself; what the small man seeks is in others."

"The superior man is dignified, but does not wrangle; social, but not a partisan. He does not promote a man simply because of his words, nor does he put good words aside because of the man."

"A poor man who does not flatter, and a rich man who is not proud, are passable characters; but they are not equal to the poor who yet are cheerful, and the rich who yet love the rules of propriety."

"Learning, undigested by thought, is labor lost; thought, unassisted by learning, is perilous."

"In style all that is required is that it convey the meaning."

"Extravagance leads to insubordination, and parsimony to meanness. It is better to be mean than insubordinate."

"A man can enlarge his principles; principles do not enlarge the man." That is, man is greater than any system of thought.

"The cautious seldom err."

Sententious sayings like these have gone far to form the ordinary Chinese character. Hundreds of thousands of the literati can repeat every sentence in the classical books; the masses of the people have scores of the Confucian maxims, and little else of an ethical nature, in their memories,—and with a beneficial result.

Confucius laid no claim, it has been seen, to divine revelations. Twice or thrice he did vaguely intimate that he had a mission from heaven, and that until it was accomplished he was safe against all attempts to injure him; but his teachings were singularly devoid of reference to anything but what was seen and temporal. Man as he is, and the duties belonging to him in society, were all that he concerned himself about. Man's nature was from God; the harmonious acting out of it was obedience to the will of God, and the violation of it was disobedience. But in affirming this, there was a striking difference between his language and that of his own ancient models. In the *King* the references to the Supreme Being are abundant; there is an exulting awful recognition of Him as the almighty personal Ruler, who orders the course of nature and providence. With Confucius the vague, impersonal term, Heaven, took the place of the divine name. There is no glow of piety in any of his sentiments. He thought that it was better that men should not occupy themselves with anything but themselves.

There were, we are told in the *Analec*, four things of which he seldom spoke—extraordinary things, feats of strength, rebellious disorder, and spiritual beings. Whatever the institutions of Chow prescribed about the services to be paid to the spirits of the departed, and to other spir-

Wise say-  
ings.

His re-  
ligion and  
philos-  
ophy.

us, he performed reverently up to the letter; but at the same time, when one of the ministers of Lu asked him what constituted wisdom, he replied: "To give one's self earnestly to the duties due to men, and while respecting spiritual beings, to keep aloof from them,—that may be called wisdom."

But what belief underlay the practice, as ancient as the first footprints of history in China, of sacrificing to the spirits of the departed? Confucius would not say. There was no need, in his opinion, to trouble the mind about it. "While you cannot serve men," he replied to the inquiry of Tze-lu, "how can you serve spirits?" And what becomes of a man's own self, when he has passed from the stage of life? The oracle of Confucius was equally dumb on this question. "While you do not know life," he said to the same inquirer, "what can you know about death?" Doubts as to the continued existence of the departed were manifested by many leading men in China before the era of Confucius. In the pages of Tso K'iu-ming, when men are swearing in the heat of passion, they sometimes pause, and rest the validity of their oaths on the proviso that the dead to whom they appeal really exist. The "expressive silence" of Confucius has gone to confirm this skepticism.

His teaching was thus hardly more than a pure secularism. He had faith in man, man made for society, but he did not care to follow him out of society, nor to present to him motives of conduct derived from the consideration of a future state. Good and evil would be recompensed by the natural issues of conduct within the sphere of time,—if not in the person of the actor, yet in the persons of his descendants. If there were any joys of heaven to reward virtue, or terrors of future retribution to punish vice, the sage took no heed of the one or the other.

A very remarkable man Confucius was, persistent and condensed, but neither his views nor his character were perfect. In the China then existing he saw terrible evils and disorders, which he set himself, in the benevolence of his heart, to remedy, but of one principal cause of its unhappy condition he had no idea. Near the beginning of this article, the existence of polygamy and the evils flowing from it were referred to. Confucius never appeared to give the subject a thought. We saw how he mourned on the death of his mother; but no generous word ever passed his lips about woman as woman, and apparently no chivalrous sentiment ever kindled in his bosom. Nor had he the idea of any progress or regeneration of society. The stars all shone to him in the heavens behind; none beckoned brightly before. It was no doubt the moral element of his teaching, springing out of his view of human nature, which attracted many of his disciples, and still holds the best part of the Chinese men of learning bound to him; but the conservative tendency of his lessons—nowhere so apparent as in the *Ch'un Tsiu*—is the chief reason why successive dynasties have delighted to do him honor. (J. L'E.)

CONGE D'ELIRE, a license from the Crown issued under the Great Seal to the dean and chapter of the cathedral church of the diocese, authorizing them to elect a bishop or archbishop, as the case may be, upon the vacancy of any episcopal or archi-episcopal see in England or in Wales. According to the *Chronicle* of Ingulphus, abbot of Crowland, who wrote in the reign of William the Conqueror, the bishoprics in England had been, for many years prior to the Norman Conquest, royal donatives conferred by delivery of the ring and of the pastoral staff. Disputes arose for the first time between the Crown of England and the See of Rome in the reign of William Rufus, the Pope claiming to dispose of the English bishoprics; and ultimately King John, by his charter *Ut libera sunt electiones totius Angliæ* (1214), granted that the bishops should be elected freely by the deans and chaplains of the cathedral churches, provided the royal permission was first asked, and the royal assent was required after the election. This arrangement was confirmed by subsequent statutes passed in the reigns of Edward I. and Edward III respectively, and the practice was ultimately settled in its present form by the statute for the non-payment of first-fruits to the bishop of Rome (25 Henry VIII. c. 20). According to the provisions of this statute, upon the avoidance of any episcopal see, the dean and chapter of the cathedral church are to certify the vacancy of the see to the Crown, and to pray that they may be allowed to proceed to a new election. The Crown thereupon grants to the dean and chapter its license under the Great Seal to elect a new bishop, ac-

companied by a letter missive containing the name of the person whom the dean and chapter are to elect. The dean and chapter are thereupon bound to elect the person so named by the Crown within twelve days, in default of which the Crown is empowered by the statute to nominate by letters patent such person as it may think fit, to the vacant bishopric. Upon the return of the election of the new bishop, the metropolitan is required by the Crown to examine and to confirm the election, and the metropolitan's confirmation gives to the election its canonical completeness. In case of a vacancy in a metropolitanical see, an episcopal commission is appointed by the guardians of the spiritualities of the vacant see to confirm the election of the new metropolitan.

CONGER. See EEL.

CONGLETON, a market-town and municipal borough of England, in the county of Cheshire, near the border of Staffordshire, 26 miles south of Manchester by rail. It is finely situated in a deep valley, on the banks of the Dane, a tributary of the Weaver.



Arms of Congleton.

Its main streets are well built, and its western suburb consists of handsome villas and gardens. Though a place of considerable antiquity, it makes little figure in history, and possesses few buildings of architectural interest. The parish churches, the guildhall, built in 1822, the market hall, and the town-hall dating from 1864 are the most important. At one time the leather laces known as "Congle-

ton points" were in high repute; but the principal industry of the town is now the manufacture of silk, which was introduced in 1752 by a Mr. Pattison of London. The making of salt is carried on to an extent which gives employment to nearly 200 men; and at the census of 1871 upwards of 700 were engaged in the neighboring coal mines. There is canal communication with Macclesfield. In 1871 the population of the municipal borough, which embraces 2564 acres, was 11,344, inhabiting 2559 houses.

CONGLETON, HENRY BROOK PARNELL, FIRST BARON (1776-1842), was the second son of Sir John Parnell, chancellor of the Irish Exchequer, and was educated at Eton and Cambridge. In 1801 he succeeded to the family estates, and married a daughter of the earl of Portarlington; and in 1802, by his father-in-law's interest, he was returned for Portarlington to Parliament, but he speedily resigned the seat. In 1806 he was returned for Queen's County, for which he sat till 1832, when he withdrew from the representation. In 1833, however, he was returned for Dundee; and after being twice re-elected for the same city (1835 and 1837), he was raised to the peerage in 1841 with the title of Baron Congleton of Congleton. In 1842, having suffered for some time from ill health and melancholy, he committed suicide. He was a liberal Whig, and took a prominent part in the struggle of his party. In 1806 he was a lord of the Treasury for Ireland; it was on his motion on the Civil List that the duke of Wellington was defeated in 1830; in that year and in 1831 he was secretary at war; and from 1835 till 1841 he was paymaster of the forces and treasurer of the ordnance and navy. He was the author of several volumes and pamphlets on matters connected with financial and penal questions, the most important being that *On Financial Reform*, 1830.

CONGO, a country of Western Africa, extending along the coast of the Atlantic for about 185 English miles, from the River Zaire or Congo (see AFRICA, vol. i. p. 227), which separates it from Cacongo and Loango on the north, to the Dande, which marks the boundary of Angola on the south. No very definite limit can be assigned on the eastern side; but it is hardly to be regarded as Congo territory at more than 250 miles inland. At one time the name Congo was applied not only to the country thus defined, but also to Loango, Angola, and Benguela—in short, to all the territory claimed by the Portuguese in this part of the continent.

The coast of Congo presents for the most part a succes-

sion of low cliffs and bluffs of red sandstone, sinking at intervals almost to the level of the sea; and for about 30 to 60 miles inland the country remains comparatively flat. It then begins to rise in irregular terraces till it reaches a height of about 1500 or 1600 feet; and its surface is broken with an endless variety of hill and valley and undulating plateau. The prevailing rocks in the lower terraces are mica, schist, gneiss, and shale; further inland there are extensive limestone formations; and igneous rocks occur in several quarters. The whole country is abundantly watered, partly by tributaries of the Zaire, and partly by independent streams that flow westward to the Atlantic. Of the latter the more important are the Ambrizette, the Loge, and the Lifune; but even these are only navigable for barges. The former, as far as Congo proper is concerned, are individually insignificant. During the rainy season the surplus water is carried down in a thousand torrents, but the beds are quite dry during most of the year.

**Minerals.** The mineral wealth of Congo is only partially explored, and even the deposits that are known to exist are very sparingly utilized. Copper mines have been worked at intervals for a considerable period at Bembe; and, though now abandoned by the Portuguese, they appeared to Lieutenant Grandy to contain a good supply of ore. Very fine malachite is also found in other parts of the country. Iron is obtained in the northern districts along the Zaire, where the general diffusion of the metal is proved by the red ferruginous character of the soil, and the fact that most of the streams are more or less chalybeate. A lake of bitumen is reported at Kinsao, near Mangu Grande; the same substance occurs at Muserra, and another deposit has been worked by the natives at Libongo. Red gum-copal occurs in various places,—among others, near Mangu Grande and in the Mossulo country; but the superstition of the natives interferes with its excavation. That diamonds have ever been found there seems no reason to believe; but garnets and even rubies occur. Salt is manufactured by the natives along the coast.

**Climate.** The climate of Congo is, in comparison with that of most tropical countries, remarkably cool and agreeable. In the hot season the thermometer is seldom more than from 80° to 86° Fahr. in the shade, and in the "cacimbo," or cool season, it usually ranges from 60° during the night to 75° during the day. This low temperature is principally due to the westerly breeze which sets in from the Atlantic about nine or ten o'clock in the morning, and continues blowing, not unfrequently with considerable violence, till after sunset. As this breeze dies away towards the interior, the heat is perceptibly greater; but the increasing elevation of the country soon reduces the temperature to similar limits. The different seasons of the year occur at slightly different periods, according to the altitude and position of the several districts; but the hot or rainy season may be regarded as extending from October to May or June, and the "cacimbo" as occupying the rest of the year. In October there are usually light rains in the lower country; and these are succeeded by the *Moula na Chintomba*, or great rains, which are accompanied by violent storms and thunder. Next follows, from December to March, a period known as the "little dries," and then comes another spell of heavy rains and atmospheric disturbance. In the neighborhood of Banza Umpata, about 200 miles inland, the natives, according to Lieutenant Grandy, divide the year into the following five seasons:—*Sevo*, or summer, from the beginning of July to the middle of September; *Bangala*, or the dry season, to the end of November; *Nasansa*, to the middle of February; *Kunday*, or the period of the heavy rains, to the middle of April; and *Kintombo*, or spring, to the end of June. In its effects on the human constitution, the climate of Congo is much less deleterious than that of the coast regions further to the north; and in the higher districts even the European can maintain himself with ease in a fair state of health. Fevers and agues are not uncommon, but do not last long; and the natives suffer from bronchitis, pleurisy, small-pox, and skin diseases. The curious sleep-disease appeared in 1870, but did not spread through the country.

**Vegetation.** The flora of Congo is rich and various; and the country may be divided with remarkable precision into different zones, distinguished by the prevail-

ing character of the vegetation. According to Mr. Monteiro, the traveller, as he advances inland from Ambriz, finds during the first 25 miles baobabs, euphorbias, aloes, "muxixes" or "mukazo" (*Sterculia tomentosa*), and a great abundance of *Sansevieria angolensis*; he passes next into a region of larger, shadier trees, which continue for the next 35 miles, when the scene again changes, and the whole forest becomes one tangled maze of the most luxuriant and beautiful creepers. Near Bembe the country opens up and the oil-palm becomes the prevailing tree. In the first zone the grasses are short and delicate, in the second they are stronger and taller; in the third they develop into gigantic species with sharp knife-like blades, from 5 to 16 feet in height, which cover vast open stretches, and for several months in the year render communication through the country almost impossible. The cashew tree is exceedingly abundant along the coast from Congo to Ambrizette. The principal objects of native cultivation are manioc or cassava, yams, ground-nuts (*Arachis hypogaea*), and maize. Sesamum and sweet potatoes are sparingly grown. Coffee of good quality is found wild in various parts, especially in the neighborhood of Encoge. Chili pepper is abundant, and forms the principal condiment in use among the natives, who not unfrequently eat it to their own injury. The plantain, the papaw, the orange, and the pine-apple are the principal fruits, but many others thrive well. Beans, cabbages, pumpkins, cucumbers, melons, spinach, and other European vegetables can be successfully cultivated, and the first two are used by the natives. Of the beans, indeed, there are two species, the ordinary haricot and the tree-bean; the latter is sometimes left to grow for two years. The principal beverage of the inhabitants is the palm wine, but they also manufacture a beer called "garapa," from the Indian corn. According to Selim Agha, who accompanied Burton in 1863, cotton and rice come to perfection in four months, the cassava takes six or nine, and three or four are sufficient for cabbages, lettuce, endive, and carrots.

The domestic animals of Congo consist chiefly of goats, swine, dogs, and cats; and there are also a few sheep with coats of hair instead of wool. The goats are beautiful creatures, but the swine and dogs are poor and half-starved. No beasts of burden are employed by the natives; and the mules, asses, and camels introduced by the Portuguese died out. Horned cattle there are none, though they thrive well enough on the coast under the white man's care.

The larger wild animals are similar to those of the neighboring countries on the south; but the River Zaire seems to be a natural limit for many species on the north. The variety of birds is remarkable. Flamingoes, spoon-bills, herons, ducks, and various other aquatic species abound in the rivers and marshes. The common African crow, bright-colored starlings, rollers, and doves are very common in the lower country; and sun-birds and other insectivora frequent the palm-trees. The white ant is the most abundant of the insect tribes, and mosquitoes of a most virulent sort are very common. The chigoe (*Pulex penetrans*), introduced in 1870, spread through the country, but seems to be dying out again. Bees abound, but are not domesticated.

Animal food is not in very general use, although the natives will eat the flesh of almost any beast or bird. The Mussurongos consider the cat a great dainty; field rats are regularly captured for the kitchen by the various tribes; the king-cricket, and some species of caterpillars, are sought after for the same purpose, and the white ant is greedily devoured in the winged state.

Congo is as destitute as the other countries of tropical Africa of what a European would call a city. The native *bansas*, or townships, consist of a few hundred huts clustered together; and the Portuguese settlements are merely commercial factories or military posts. The places of most importance along the coast are Mangu Pequeno, Mangu Grande, Quinzao, Mocula, Ambrizette, Muserra, Quicimbo, Ambriz, and Libongo. On the River Zaire may be mentioned King Antonio's Town, Boma (anciently Lambi), and Vinda la Nzidi, or Congo Town; but the last two are on the north side of the river, and therefore are hardly to be included within our limits. The principal inland town is São Salvador, or Congo Grande, with a population at one time extravagantly estimated at 50,000; and Banza Noki to the north

and Bembe and Encoge to the south are worthy of mention. The number of villages is very considerable, and together they must make up a fair population; but it is evident from the condition of the country, as well as from the reports of the older travellers, that formerly the inhabitants must have been much more numerous.

The ordinary huts of the natives are formed of mats woven from a reedy grass, or the fibres of plants. That of the chief is constructed more skillfully of palm leaves, and is encompassed with a fence of reeds. In the coast towns the huts, though each is built separate, are comparatively close to each other; while further inland much more space is allowed to intervene, and hedges are frequently grown round small groups. The Muschicongos build on a larger scale than their Ambriz neighbors, and not unfrequently have two compartments. The household furniture and utensils, in simplicity and rudeness, are on a par with the domestic inclosures. Baskets are made of the fibres of the palm tree, and bowls and bottles of gourds and other vegetables; earthen vessels are used for boiling the victuals, and wooden spoons to eat them, while a mat of grass thrown on a raised platform constitutes the only bedding.

**Tribes.** There is no political or ethnographical unity in the country. No one tribe is predominant, and the king of Congo, whatever may have formerly been his authority, is now no more than a local chieftain, like a dozen others. The tribes numerically important are the Musurongos, who extend from the Zaire as far south as Mangue Grande; the Muschicongos, who lie inland to the north of Bembe; the Ambrizians along the coast, and inland as far as Quiballa; and the Mossulos to the north of the Dande. Besides the king of Congo, the king of North Bamba, or of the district between the Ambrizette and the Loge, and the king of Encoge, with the title of "Dembo Ambuilla," possess a certain amount of prestige. Every "town" has its own headman and assembly of "Macotas," or councillors; and these in company manage its affairs. The office of headman confers no despotic power, and it descends by inheritance not from father to son, but from uncle to nephew or niece. The languages of

**Language.** the Musurongo, Mushicongo, and Ambriz tribes are radically one, and indeed the natives of the whole of this part of the coast, for a distance of 450 miles, can understand one another's speech. Under the name of *Fiote* this common tongue has been the object of some little attention. Barbot gives a list of 33 words, Douville a more extended vocabulary of what he calls *la langue Magaloua*, and the authors of the *Congo Expedition* a third and much better collection. Vowels and liquids are numerous, and gutturals altogether absent, so that the language has a soft and harmonious sound. In number of words it is remarkably rich. According to Captain Burton, its likeness to the Kisawahali of Zanzibar is so great that he was frequently able to understand whole sentences from this resemblance alone. Along the coast a considerable number of the natives can speak Portuguese or even English; but their pronunciation is extremely faulty, and they transfer the idiom of their own speech to the foreign tongue.

**Manners and customs.** The religion, if such it can be called, of the Congoese is a gross fetishism, and almost the only trace of their former superficial Christianization is the superstitious value attached to some stray crucifix now employed as a charm, a little more potent, it may be, than a string of beads or a land-shell filled full of birds' dung and feathers. Belief in witchcraft is very general, and develops itself in the most trivial and irrational style. Circumcision is practised by all the tribes, and the rite is usually performed on boys of from eight to twelve years of age, who have to undergo a preparatory discipline, and live apart from the rest of the community for a month in a special hut. Polygamy prevails, every man having wives according to his wealth and rank. There is no nuptial ceremony, but the bridegroom makes a present to the father-in-law, provides the bride with her marriage outfit, and bears the cost of a family feast. The costume of both men and women varies considerably with rank and the degree of European influence; but in general it is very slight. The bodies of the dead are not unfrequently desiccated by roasting, and then buried in the huts which they formerly occupied. The interment is

often delayed for a year or more, that all the relatives may be present at the "wake."

Since the stoppage of the slave trade a very considerable traffic has been developed in the natural products of the country, and were it not for the inherent indolence of the natives it might be increased almost to any extent. The principal exports are the fibre of the baobab, first utilized as a paper material by Mr. Monteiro in 1858; ground nuts, which find a ready market, especially in France, as an oil seed; ivory brought down from the interior; palm oil, sesamum, coffee, and an inferior kind of Indian-rubber, obtained from a species of *Landolphia*. The commercial prosperity of the Congo River has been frequently interrupted by the attacks of the Musurongo pirates, but this annoyance has been somewhat checked by the vigorous measures of the English cruisers. The last expedition of repression was that of Commodore Sir W. Hewett, in 1875.

Congo was discovered by Diego Cam, probably in 1484. He erected a stone pillar at the mouth of the river, which accordingly took the title of Rio de Padrão, and established friendly relations with the natives, who reported that the country was subject to a great monarch, Mwan Congo, or Lord of Congo, resident at Ambaese Congo. The Portuguese were not long in making themselves influential in the country. Gonçalo Sousa was despatched on a formal embassy in 1490; and the first missionaries entered the country in his train. The king was soon afterwards baptized, and Christianity was nominally established as the national religion. In 1534 a cathedral was founded, and in 1560 the Jesuits arrived with Paulo Dias de Novaes. Of the prosperity of the country at this time the Portuguese have left the most glowing and indeed incredible accounts. The attention of the Portuguese was, however, turned more particularly to the southern districts of Angola and Benguela, and their hold on Congo loosened. In 1627 their cathedral was removed to São Paul de Loanda, and São Salvador declined in importance. In the 18th century, again, in spite of the invasions of the Dutch and French, some steps were taken towards re-establishing their authority; in 1758 they formed a settlement at Encoge; from 1784 to 1789 they carried on a war against the natives of Mussulo; in 1791 they built a fort at Quincollo on the Loge, the ruins of which are still existent, and for a time they worked the mines of Bembe. At present, however, they possess no fort or settlement to the north of Ambriz, which was first occupied in 1855. The connection of other European nations with Congo has hitherto been either exploratory or commercial, and nothing more powerful has been established than "a factory" or "comptoir." In 1816 an expedition was despatched from England under the command of J. K. Tuckey, R. N., for the examination of the Zaire. It reached the river on July 6th, and managed to push up stream as far as Sangala, the highest rapid; but sickness broke out, the commander and several others died, and the expedition had to return. A survey of the first twenty-five miles of the river was effected in 1826 by the "Levin" and the "Barraouta," belonging to Captain Owen's expedition; and in 1827-29 the Frenchman Douville spent some time in various parts of the country. In 1857 the German explorer, Dr. Bastian, passed from Ambriz inland as far as São Salvador; and in the same year Captain Hunt, in the "Alecto," made an attempt to ascend the river, but only reached the cataracts. Captain Burton attained the same limit in 1863, and also proceeded inland as far as Bansa Noki. In 1872 an expedition under Lieutenant Grandy was despatched from England for the purpose of advancing from the west coast to the relief of Livingstone. Ambriz was chosen as the starting point, and Bembe was reached in 11 days, on the 23d of March, 1873. The 15th of May found the party at Congo, but they were detained there till June 20th. Passing through Kilembella, Moila, and Tungwa (a place of about 1600 inhabitants), they arrived at Bansa Umpala, on a tributary of the Zaire, about 200 miles inland, but were then obliged to retrace their steps to Congo, whence they proceeded to Bansa Noki and the main river, intending to push their way up the stream. The death of Livingstone was soon after reported; and a recall shortly reached them, which brought the expedition to a close. They found the natives "exceedingly timid, superstitious, and suspicious, evidently believing that the foreigners had come to interfere with their trade and country." In 1875 a German expedition, under Captain von Homeyer, commenced exploratory operations along the Congo for the purpose of preparing the way for German colonization.

See the older travellers in the collections of Astley, Pinkerton, Churchill, Puchas, and Philipp; Pellioer de Tovar, *Mission Evangelica al Reyno de Congo*, Madrid, 1649; Tuckey, *Narrative of an expedition to explore the Congo*, 1818; Douville, *Voyage au Congo*, 1832; Owen, *Voyages to Africa, Arabia, &c.*, 1833; Hunt, "Ascent of the Congo," in the *Proceedings of the Roy. Geo. Soc.* for 1858; Bastian, *Eis*

*Besuch in San Salvador*, Bremen, 1859, and *Die Deutsche Expedition an die Loango Küste*, Jena, 1874; Behm, "Die Congo Fluss," in *Petermann's Mittheilungen*, 1872; Lieut. Grandy's report in the *Proceedings of Roy. Geo. Soc.*, 1874, and also in the *Geograph. Mag.*, 1875; J. J. Monteiro, *Angola and the River Congo*, London, 1875; Burton, *Two trips to Gorilla Land and the Cataracts of the Congo*, 1876; P. Duparquet, "Voyage au Zaire," and Codine, "Decouverte de la cöte d'Afrique . . . pendant les annés 1484-1488," in *Bull. de la Soc. de Géogr.*, 1876.

CONGREGATIONALISM, a designation assumed of late years by the religious denomination formerly known as Independents. This change of name has arisen from no radical alteration in the particular doctrinal or ecclesiastical opinions of that sect (see INDEPENDENTS), but in order to express more definitely the positive aspects of their church life and organization. The negative term Independent implied chiefly a renunciation "of the authority of pope, prelate, presbytery, prince, or parliament," and thus brought into prominence the antagonistic position of the churches so named towards National, Episcopal, and Presbyterian Churches. The word Congregational has been now almost universally substituted for it to indicate more clearly the brotherhood and fellowship maintained in their separate communities, the spiritual equality of every member, the right and the duty of all in the church to have a voice in its deliberations and decisions, the essential necessity for each society to originate its own outward forms of life. As one of the latest exponents of Congregationalism has said,<sup>1</sup> "When the restraints of outward law are repudiated, it is necessary to insist with all the greater intensity on making the polity of the church the expression of its own highest life. Everything must be subordinated to this. The polity must come from within; it must not be imposed from without; it may recognize outward circumstances but must not be controlled by them. If the organization of the church is to be a vital growth, the life which it is to reveal is the life which the church has received from Christ. Ecclesiastical statesmen have no right to construct various forms of polity to express the spirit and tendencies prevailing among different races of men, in different countries, and in different churches; the polity of the church must be created by the idea of the church." It is maintained that this conception of a church organization is entirely in harmony with the genius of the New Testament, and is better expressed by the word Congregational than Independent. In this sense it is applicable to other communities, in particular to the Baptists, who sometimes adopt it. Probably another reason for its employment has been the growing tendency towards outward union among churches that were mainly characterized by their isolation from each other. Independency was often regarded as a synonym for non-catholicity, and there was so strict a jealousy against all possible interference from without that close association or united action was exceedingly difficult, even amongst those whose doctrinal beliefs and ecclesiastical polity were the same. An endeavor has been made to overcome such obstacles common to co-operation without destroying or infringing the independence of the individual church, and the Congregationalists now have numerous missionary societies for home and foreign work, an association in every county, and a general Congregational Union for England and Wales. The last was established after much discussion in 1833, when a declaration of faith, church order, and discipline was adopted under these express conditions. "It is not intended that the following statement should be put forth with any authority, or as a standard to which assent should be required. Disallowing the utility of creeds and articles of religion as a bond of union, and protesting against subscription to any human formularies as a term of communion, Congregationalists are yet willing to declare, for general information, what is commonly believed among them, reserving to every one the most perfect liberty of conscience." In 1871 a revision of the constitution of the Union took place, when the fundamental "principle" of its existence was thus re-asserted. "The Union recognizes the right of every individual church to administer its affairs, free from external control, and shall not, in any case, assume legislative authority or become a court of appeal." The objects it seeks to promote were then also more

definitely stated in these words, "to uphold and extend evangelical religion primarily in connection with churches of the Congregational order; to promote Scriptural views of church fellowship and organization; to strengthen the fraternal relations of the Congregational churches, and facilitate co-operation in everything affecting their common interests; to maintain correspondence with the Congregational churches and other Christian communities throughout the world; to obtain statistics relating to Congregational churches at home and abroad; to assist in procuring perfect religious equality for all British subjects, and in promoting reforms bearing on their moral and social condition." The chairman is elected annually by the vote of the delegates from the churches present at the annual meeting. Unions of a similar character exist in Scotland, Ireland, and the colonies. In 1876 it was computed<sup>2</sup> that the total of Congregational churches and branch churches in Great Britain and the colonies was 3895, with other preaching places, supplied mainly by lay agency, to the number of 1248. The ordained ministers, including the missionaries of the London Missionary Society, were 3205; there were 17 colleges, employing 52 professors, and educating 430 students. The expenditure for missions at home and abroad, not calculating the amounts expended by individual churches throughout the world for special local missions, was £147,270. In 1875 the Congregationalists opened their Memorial Hall and Library, which is erected in London on the site of the old Fleet Prison, in commemoration of the heroism and spiritual fidelity of the two thousand clergymen who were ejected "from their homes and livings as ministers of Christ in the Church of England, under the stringent, inhuman, and unjust provisions of the Act of Uniformity." In that building the various societies of the Congregationalists now hold their meetings.

Congregationalism in the United States has, from the earliest period of its existence, recognized the principle that each Christian society, though complete in itself, is nevertheless related to all other churches of the same faith and order. The weakness and scattered condition of those little communities which followed the settlement of the Pilgrim Fathers threw them into close association, they assisted each other by friendly advice, and from that sprang the system of councils. These have now become important institutions exercising considerable influence. It is claimed that, though every church is "independent of all outward control," "a fraternal fellowship is yet to be maintained among these independent churches; and when insoluble difficulties arise, or specially important matters claim decision—as where a pastor is to be settled or dismissed, or a church itself is to adopt its creed and commence its organic life—it is proper that the advice of other churches should be sought and given in council; such action, however, in no case being anything more than a labor of fraternal suasion or self-justification."<sup>3</sup> Increase Mather says, "It has ever been their declared judgment that, where there is want either of light or peace in a particular church, it is their duty to ask for counsel, with which neighbor churches ought to assist by sending their elders and other messengers to advise and help them in their difficulties; and that in momentous matters of common concern particular churches should proceed with the concurrence of neighbor churches; so in the ordination of a pastor, much more in the deposing of one. Thus it has ever been in the churches of New England." Some writers contend that "Congregationalism differs from Independency by its recognition of this practical fellowship between the churches." The councils thus summoned are dissolved as soon as the business is settled, and should the church to which advice is offered be unwilling to accept and act upon it the other churches may consider the desirability of withdrawing from any further association with it. There are permanent councils in Connecticut, called "consociations," but they are not general in the States. In some of the county unions of England a committee is appointed annually, to which churches may appeal in any difficulty which they are unable to remove of themselves,—an approach towards the American system. According to a religious census taken by the Government there were in the United States in 1850, 1725 Congregational churches, with 807,335 sittings; these had increased in 1870 to 2687 churches and

<sup>1</sup> *Ecclesia, A Second Series of Essays on Theological and Ecclesiastical Questions*, p. 371.

<sup>2</sup> See *Congregational Year Book*, 1877.

<sup>3</sup> *Congregationalism: What it is, whence it is, and how it works*, 3d ed., Boston, 1871.



1,117,212 sittings. For the education of the ministry there are seven theological institutions. (w. B.)

CONGRESS, in diplomacy, a term applied to an assemblage of sovereigns or ambassadors of the highest rank, convoked for the purpose of concluding a general peace, or of treating the general political interests of Europe. In this latter sense a modern congress may be regarded as a representative council of states or nations, by which differences may be adjusted, and the rules of international law determined and enforced. The greatest progress yet made in the relations of sovereign states is, that disputes, which in former times would have led to immediate war, may now be resolved, in many instances, by the common deliberations of the European powers. The term CONGRESS, however, is only strictly applicable to meetings of this nature on the most important occasions, and when all the powers are represented. The term CONFERENCE is used to describe diplomatic meetings of ministers of the first or second rank, called together for a special purpose, either to modify existing treaties by consent, or to suggest means of dealing with a critical state of affairs. Meetings of this kind have become in modern times very frequent, and are the recognized mode of dealing with the questions arising between sovereign states, and sometimes even between states and their subjects. The proceedings of these conferences are recorded in protocols, agreed to and signed by the plenipotentiaries. These documents have not always the form of treaties or conventions, but they establish the principles on which the powers agree to act, and the rules by which they are bound in honor and good faith. The number of Congresses which have been held in the last two centuries is not very large, and we shall proceed briefly to pass them in review. Conferences have occurred so frequently that it would be impossible to describe them in detail. The most important examples are, perhaps, the Conference of Petersburgh in 1825, which led to the independence of Greece; the Conference of London, in 1831, which separated the kingdom of Belgium from Holland; the Conference of Paris on the affairs of Crete; the Conference of 1871 for the modification of the Treaty of Paris of 1856; and the abortive Conference of Constantinople in 1877, when the six powers vainly endeavored to obtain from the Porte guarantees for the better government of its Christian subjects. These two forms of diplomatic council differ more, however, in form and degree than in kind. Their object is the same, namely, to determine and enforce the mutual obligations of states; and they may therefore be treated under one head.

The first time we have been able to trace the use of the term *Congress*, in its modern sense, is in 1636, when the Pope attempted to open negotiations for peace at Cologne, under his own mediation; but the attempt failed, and the Thirty Years' War continued for twelve years more to devastate the world. At length, however, it was agreed by the preliminaries of Hambug, signed on the 25th December, 1641, that a Congress should be held at Munster and at Osnaburgh, in Westphalia, meeting simultaneously in both those towns; the French mediating minister, representing the Catholic party, being at Munster, and the Swedish minister, representing the Protestants, at Osnaburgh. The opening of the Congress was fixed for the 11th July, 1643; but the proceedings were delayed by numerous formalities, by questions of rank and precedence, by questions of neutrality and safe-conduct, and by the death of Richelieu and Louis XIII. The negotiations began in earnest in June, 1645. Never before had so august an assembly met in Europe for the termination of a sanguinary war, for the establishment of peace between two hostile creeds, and for the regulation of territorial questions by common agreement. The Empire was represented by Count Maximilian von Trautmansdorf; France by Count d'Avaux; Sweden by John Oxenstiern, a son of the great chancellor; the Pope by Cardinal Chigi, afterwards himself Pope Alexander VII.; Spain by Count Pefaranda, and by two of her subjects from Franche Comté, not to mention lesser names. England had no representative at the Congress of Westphalia. The questions in dispute and the result of these long deliberations (which were not terminated until the 24th October, 1648, by the signature of the two great treaties of Munster and Osnaburgh) were worthy of the statesmen engaged in them and of the time spent in the negotiations; for the Congress of Westphalia laid the foundations of modern Europe, and its leading principles

subsisted not only into the present century, but down to the war of 1870-71. It terminated the long contest between France and Austria. It established the equal rights of the Catholic, Lutheran, and Calvinistic churches in Germany. It rendered 350 German princes almost independent of the Empire, and it planted the germ of the future greatness of Prussia. This form of the German body remained unaltered till the French Revolution. But it also gave to France and Sweden a right, as mediating powers at Munster, to interfere in the affairs of Germany—a right which supported the aggressive policy of Louis XIV., and caused, in the event, innumerable quarrels. The diplomatic communications at Munster all passed through the mediators, and were generally framed in Latin. The discussions were also carried on in that language. A separate peace between the Dutch and the Spaniards was also signed at Munster in 1648, as represented in Terburg's celebrated picture, now in the National Gallery, but this was not an act of the Congress.

The term Congress was applied to the diplomatic meetings which negotiated the Peace of Nimeguen in 1678 and the Peace of Ryswick (so called from a castle near the Hague) in 1697. A contemporary French author, De Rouille, remarked that these meetings ought to be termed assemblies, not congresses, since the latter word was coarse and inappropriate. The term has since entirely lost its improper meaning, derived from an obsolete form of ecclesiastical procedure, and the diplomatic signification has triumphed. At Nimeguen England appeared for the first time at a Continental Congress, from the interest she took in the fate of Holland, and was worthily represented by Sir William Temple; France by Colbert de Croissy, D'Estades, and D'Avaux; Spain by Don Pedro Ronquillo, governor of the Lower Countries; and Holland by the count of Nassau and Beverning. Separate treaties were signed between the various parties. The Congress of Ryswick was of still greater importance to England, for it terminated the war in which we had long been engaged with France, and extorted from Louis XIV. the recognition of the right of William and Mary to the British crown. The peace was of short duration, for the War of Succession broke out in 1701; the grand alliance was formed between England, Holland, and Austria; France was defeated; peace was nearly restored in 1709 at the conferences of Gertruydenberg, which were privately carried on between the marquis de Torcy and the Grand Pensionary, but not finally concluded till 1712, when a Congress of all the belligerent powers (except the king of Spain) assembled at Utrecht. France was represented by the marshal d'Huxelles, England by the bishop of Bristol (it was the last time an English bishop acted in a civil and diplomatic capacity), the emperor by Count Sinzendorf. The decisive negotiation for peace was, however, carried on secretly and separately between London and Versailles, and whilst the Congress was occupied with formalities, Bolingbroke came to an agreement with France, which broke up the alliance and compelled the other powers to terminate the war. The other Congresses of the 18th century are those of Soissons in 1727, remarkable for the fact that Cardinal Fleury, then prime minister of Louis XV., attended it in person, and of Aix-la-Chapelle in 1748, which terminated a general war. By each of these Congresses the treaties of Westphalia, Nimeguen, Ryswick, and Utrecht were renewed and confirmed; so that their labors formed a continuous series and identical body of international legislation. No Congress was held at the termination either of the Seven Years' War in 1763 or of the American war in 1783, but the style of a Congress was assumed by the German plenipotentiaries who met at Teschen in 1779 to end the war of the Bavarian succession. It hardly deserved the name.

The French Revolution and the wars of the Empire swept away the entire political fabric of continental Europe and the treaties on which it was based. No attempt was made during that period to convoke a Congress for the purpose of a general pacification and territorial settlement; for the Congress of Rastadt, which met in December, 1797, and sat till April, 1799, was designed mainly to re-establish amicable relations between France and the German empire, and was not attended by the representatives of England, Russia, or Spain. These negotiations proved abortive; war was renewed; the Congress was broken up; and the ministers of the French Directory—Bonnier and Roberjot—were massacred by a party of Aus-

trian Szeklers as they quitted the town. The Austrian Government never entirely cleared itself of complicity in this crime against the rights and usages of nations; and the event aggravated the hostility existing between France and Germany.

Upon the fall of Napoleon, it was agreed by the 32d Article of the Peace of Paris, signed on the 30th May, 1814, between France and the allied powers, that "within two months all the powers which had been engaged in the war on either side should send plenipotentiaries to Vienna to settle, at a general Congress, the arrangements required to complete the provisions of the Treaty of Peace." The Congress of Vienna, which met, with some allowance for delays early in November of the same year, was by far the most splendid and important assembly ever convoked to discuss and determine the affairs of Europe. The emperor of Russia, the king of Prussia, the kings of Bavaria, Denmark, and Wurtemberg, were present in person in the Austrian capital at the court of the Emperor Francis. Prince Metternich presided over the Congress. Prince Talleyrand represented France. Great Britain sent the secretary of state for foreign affairs—Lord Castlereagh,—besides the duke of Wellington, Lord Clancarty, and Lord Cathcart. Mr. Stratford Canning, now the sole survivor of that illustrious assembly, took part in the discussion of the affairs of Switzerland, where he was then minister. Prussia was represented by Prince Hardenberg and Baron Humboldt. A hundred sovereigns and ministers were collected in Vienna, all animated by a general desire for peace and a lively sense of their own interests. Chevalier Gentz, who was named protocolist to the Congress, and who in fact drafted the treaties which were ultimately signed by all the powers, has left us a curious account of the secret proceedings of this prodigious assembly. Strange to say, the Congress itself, that is to say, the representatives of all these principalities and powers, *never met* in council; nor did any formal exchange of their respective credentials take place. The business was entirely transacted by committees of the five great powers—Austria, England, France, Prussia, and Russia; to whom, for certain purposes, the ministers of Spain, Sweden, and Portugal were added. Even with this arrangement the progress of the negotiations was extremely slow. For three months nothing was done. It was said, "Le Congrès danse, mais ne marche pas." Serious differences arose; the pretensions of Russia and Prussia, acting in concert, seemed even to threaten a renewal of war; and a secret treaty was concluded on the 3d December between England, France, and Austria, in view of that contingency. The return of Napoleon from Elba in March, 1815, roused the Congress from its lethargy and terminated its disputes, by the necessity for common action; and at length the great treaties of Vienna were signed on the 7th June, 1815—eleven days before the battle of Waterloo—by the plenipotentiaries of the eight powers. It is acknowledged by the draftsmen of these treaties that, after all, this work was somewhat hastily and imperfectly done. Yet upon the whole, that Congress succeeded in restoring peace to Europe, which was not seriously disturbed for forty years; and it laid the foundation of a system of public law, which was long held sacred, as the common basis of the rights of every member of the European family. At the present time, after the changes which have taken place in Poland, in Italy, in Germany, in Denmark, and in France, it can hardly be said that any fragments of the work of the Congress of Vienna retain their authority, or that any similar general compact has taken its place.

The intimate relations which had sprung up during the war gave rise to a mystical union of the northern sovereigns, projected and prepared by the emperor of Russia, under the name of the Holy Alliance; and the intention of the authors of that agreement was that the powers should meet and act together in the event of fresh disturbances occurring in Europe. The practical result of this policy was seen in 1823 when another Congress met at Verona, not for the purpose of restoring peace, but in order to crush the signs of freedom and independence then beginning to display themselves in Europe. In Spain the nation demanded a constitution—she was invaded by France; in Naples a popular movement took place—Naples was occupied by Austrian troops, and the king fled to Laybach; in Germany, the people were irritated by the breach of all the liberal promises made during the

war. The Congress of Verona was the source and centre of the most violent reactionary policy; and although the duke of Wellington attended it on behalf of England, it was chiefly to protest against its system of despotic intervention in the affairs of other states. M. de Chateaubriand has left an account of this, the darkest hour of the politics of Europe, in which he took an active and inglorious part. On this occasion, however, England renewed her protest against the slave trade, and obtained a declaration of the Powers condemning it.

The last Congress held in Europe was that of 1856, which met in Paris to terminate the Crimean war. Austria and Prussia, though not actual belligerents, were admitted to take part in the deliberations and general acts of the Congress, and for the first time in history the ambassadors of the Ottoman Porte appeared at a European Congress, and were formally received into the concert of the great powers. Count Walewski presided over this Congress, as minister of foreign affairs of France; Lord Clarendon, British secretary of state, and Lord Cowley were the representatives of England. In this Congress it was remarkable that France, eager for peace and anxious to court the good-will of Russia, sided with her recent adversary, and that the concessions obtained by the victorious allies were due mainly to the firmness of the British plenipotentiaries. After the conclusion of the negotiations for peace, the question of the maritime rights of belligerents and neutrals was formally brought before the Congress, as a body representing all the great powers of Europe; and a declaration was signed, which has been discussed more fully in another place. (See DECLARATION OF PARIS.) But this is an important example of the authority which may be fitly assumed and exercised by a Congress, to determine controverted questions of public law by a species of declaratory enactment.

In the autumn of 1863, the Emperor Napoleon formally proposed to the other great Powers that a Congress should assemble in Paris for the purpose of settling various questions, which appeared to threaten the future peace of Europe. To this proposal the Continental States assented; but England gave a positive refusal, on the ground, stated by Lord Russell, that such measures of prospective legislation were more likely to embroil the several Powers than to establish peace. The project was therefore abandoned; but the wars which ensued in Denmark, in Austria, and in France, within the next seven years, justified the views taken by Napoleon III. as to the dangers that threatened the peace of the world.

The most convenient summary of the Acts of the various Congresses which have been held from 1645 to 1815 is to be found in Koch Sohle's *Histoire Abrégée des Traités de Paix*. The Acts of the Congress of Vienna were published at great length by Kluber in his *Geschichte des Wiener Congresses*. The proceedings of the Congresses and Conferences in which Great Britain has taken part have invariably been laid before Parliament. (H. R.)

CONGREVE, WILLIAM (1670-1729), the greatest English master of pure comedy, was born, according to the latest and likeliest accounts, in 1670, according to the inscription on his monument, in 1672; and whether in England or in Ireland, at Bardsey near Leeds or at some place unknown beyond St. George's Channel, has likewise been matter of doubt and dispute; but we may presumably accept the authority of Lord Macaulay, who decides against Dr. Johnson in favor of the later date, and dismisses without notice the tradition of an Irish birth-place. To Ireland, at all events, is due the credit of his education,—as a schoolboy at Kilkenny, as an undergraduate at Dublin. From college he came to London, and was entered as a student of law at the Middle Temple. The first fruits of his studies appeared under the boyish pseudonym of "Cleophil," in the form of a novel, whose existence is now remembered only through the unabashed avowal of so austere a moralist as Dr. Johnson, that he "would rather praise it than read it." In 1693 Congreve's real career began, and early enough by the latest computation, with the brilliant appearance and instant success of his first comedy, *The Old Bachelor*, under the generous auspices of Dryden, then as ever a living and immortal witness to the falsehood of the vulgar charge which taxes the greater among poets with jealousy or envy, the natural badge and brand of the smallest that would claim a place among their kind. The discrowned laureate had never, he said, seen such a first play; and indeed the



**THE CAPITOL, WASHINGTON**



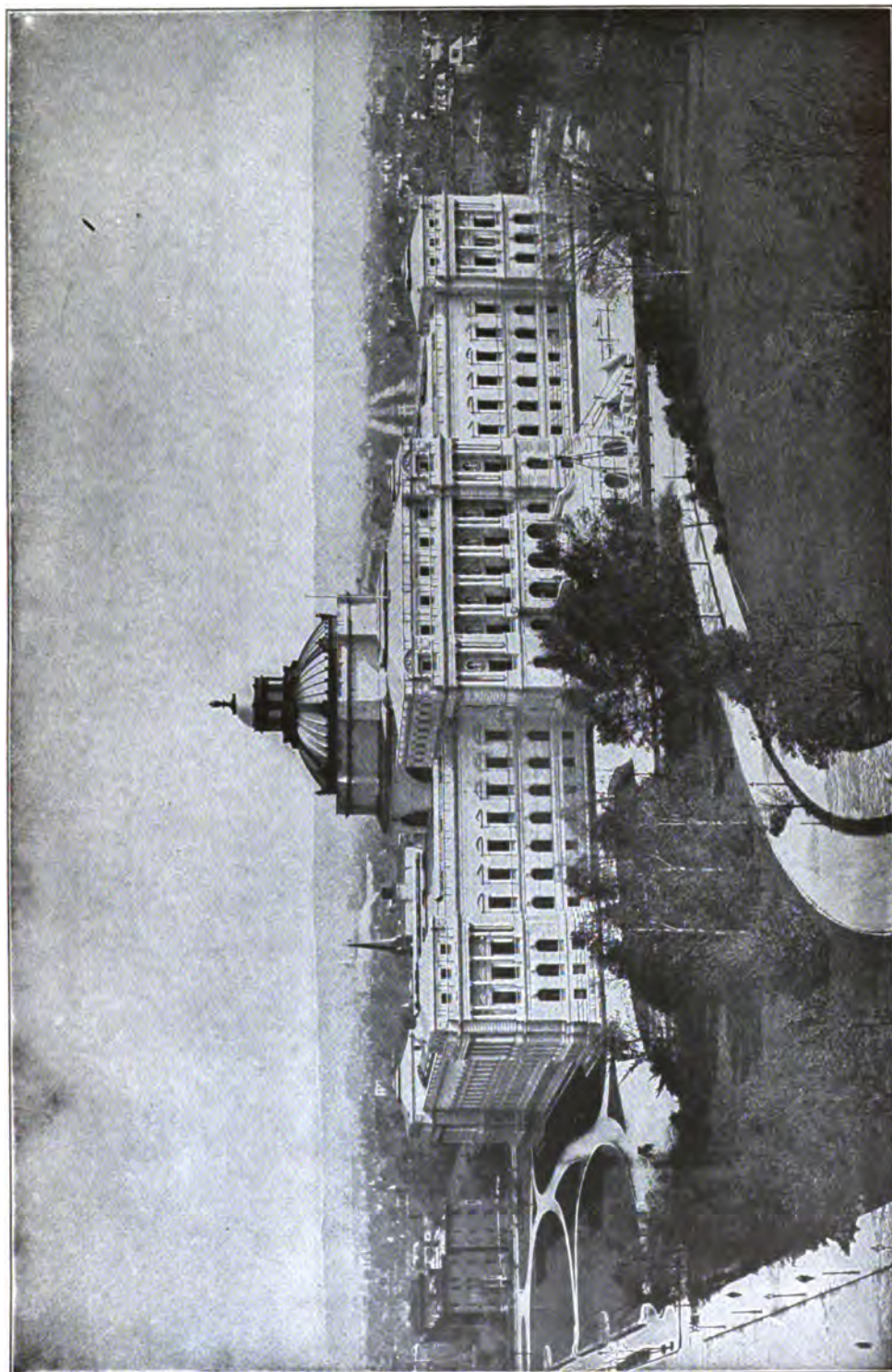

CONGRESSIONAL LIBRARY, WASHINGTON, D. C.



graceless grace of the dialogue was as yet only to be matched by the last and best work of Etherege, standing as till then it had done alone among the barefaced brutalities of Wycherley and Shadwell. The types of Congreve's first work were the common conventional properties of stage tradition; but the fine and clear-cut style in which these types were reproduced was his own. The gift of one place and the reversion of another were the solid fruits of his splendid success. Next year a better play from the same hand met with worse fortune on the stage, and with yet higher honor from the first living poet of his nation. The noble verses, as faultless in the expression as reckless in the extravagance of their applause, prefixed by Dryden to *The Double Dealer*, must naturally have supported the younger poet, if indeed such support can have been required, against the momentary annoyance of assailants whose passing clamor left uninjured and secure the fame of his second comedy; for the following year witnessed the crowning triumph of his art and life, in the appearance of *Love for Love*. Two years later his ambition rather than his genius adventured on the foreign ground of tragedy, and *The Mourning Bride* began such a long career of good fortune as in earlier or later times would have been closed against a far better work. Next year he attempted, without his usual success, a reply to the attack of Jeremy Collier, the nonjuror, "on the immorality and profaneness of the English stage,"—an attack for once not discreditable to the assailant, whose honesty and courage were evident enough to approve him incapable alike of the ignominious precaution which might have suppressed his own name, and of the dastardly mendacity which would have stolen the mask of a stranger's. Against this merit must be set the mistake of confounding in one indiscriminate indictment the levities of a writer like Congreve with the brutalities of a writer like Wycherley,—an error which ever since has more or less perverted the judgment of succeeding critics. The general case of comedy was then, however, as untenable by the argument as indefensible by the sarcasm of its most brilliant and comparatively blameless champion. Art itself, more than anything else, had been outraged and degraded by the recent school of the Restoration; and the comic work of Congreve, though different rather in kind than in degree from the bestial and blatant license of his immediate precursors, was inevitably for a time involved in the sentence passed upon the comic work of men in all ways alike his inferiors. The true and triumphant answer to all possible attacks of honest men or liars, brave men or cowards, was then as ever to be given by the production of work unarraignable alike by fair means or foul, by frank impeachment or furtive imputation. In 1700 Congreve thus replied to Collier with the crowning work of his genius,—the unequalled and unapproached master-piece of English comedy. The one play in our language which may fairly claim a place beside or but just beneath the mightiest work of Molière is *The Way of the World*. On the stage which had recently acclaimed with uncritical applause the author's more questionable appearance in the field of tragedy, this final and flawless evidence of his incomparable powers met with a rejection then and ever since inexplicable on any ground of conjecture. During the twenty-eight years which remained to him, Congreve produced little beyond a volume of fugitive verses, published ten years after the miscarriage of his master-piece. His even course of good fortune under Whig and Tory Governments alike was counterweighed by the physical infirmities of gout and failing sight. He died, January 29, 1729, in consequence of an injury received on a journey to Bath by the upsetting of his carriage; was buried in Westminster Abbey, after lying in state in the Jerusalem Chamber; and bequeathed the bulk of his fortune to the chief friend of his last years, Henrietta, duchess of Marlborough, daughter of the great duke, rather than to his family, which, according to Johnson, was then in difficulties, or to Mrs. Braucegirdle, the actress, with whom he had lived longer on intimate terms than with any other mistress or friend, but who inherited by his will only £200. The one memorable incident of his later life was the visit of Voltaire, whom he astonished and repelled by his rejection of proffered praise and the expression of his wish to be considered merely as any other gentleman of no literary fame. The great master of well-nigh every province in the empire of letters, except the only one in which his host reigned supreme, replied

that in that sad case Congreve would not have received his visit.

The fame of our greatest comic dramatist is founded wholly or mainly on but three of his five plays. His first comedy was little more than a brilliant study after such models as were eclipsed by this earliest effort of their imitator; and tragedy under his hands appears rouged and wrinkled, in the patches and powder of Lady Wishfort. But his three great comedies are more than enough to sustain a reputation as durable as our language. Were it not for these we should have no samples to show of comedy in its purest and highest form. Ben Jonson, who alone attempted to introduce it by way of reform among the mixed work of a time when comedy and tragedy were as inextricably blended on the stage as in actual life, failed to give the requisite ease and the indispensable grace of comic life and movement to the action and passion of his elaborate and magnificent work. Of Congreve's immediate predecessors, whose aim had been to raise on French foundations a new English fabric of simple and unmixed comedy, Wycherley was of too base metal and Etherege was of metal too light to be weighed against him; and besides theirs no other or finer coin was current than the crude British ore of Shadwell's brutal and burly talent. Borrowing a metaphor from Landor, we may say that a limb of Molière would have sufficed to make a Congreve, a limb of Congreve would have sufficed to make a Sheridan. The broad and robust humor of Vanbrugh's admirable comedies gives him a place on the master's right hand; on the left stands Farquhar, whose bright light genius is to Congreve's as female is to male, or "as moonlight unto sunlight." No English writer, on the whole, has so nearly touched the skirts of Molière; but his splendid intelligence is wanting in the deepest and subtlest quality which has won for Molière from the greatest poet of his country and our age the tribute of exact and final definition conveyed in that perfect phrase which salutes at once and denotes him—"ce moqueur pensif comme un apôtre." Only perhaps in a single part has Congreve half consciously touched a note of almost tragic depth and suggestion; there is something well-nigh akin to the grotesque and piteous figure of Arnolphe himself in the unvenerable old age of Lady Wishfort, set off and relieved as it is, with grace and art worthy of the supreme French master, against the only figure on any stage which need not shun comparison even with that of Céliamène. (A. C. S.)

CONGREVE, SIR WILLIAM, Bart. (1772-1828), the inventor of the Congreve rocket, was the eldest son of Sir William Congreve, Bart., of Walton in Staffordshire. He procured a commission in the artillery, became lieutenant-general, and assisted the duke of York in the changes introduced by him into the management of the army. He also obtained a seat in the House of Commons for Gattton, and afterwards for Plymouth. He wrote an *Elementary Treatise on the Mounting of Naval Ordnance* (1812), and a *Description of the Hydro-pneumatic Lock* (1815).

CONI (Italian, CUNEO), the capital of the province of the same name, is situated on an eminence at the junction of the Stura and Gesso, 46 miles south-west by rail from Turin and 86 miles north-east from Nice by the Col di Tenda. It was famous in Piedmontese warfare as a place of great strength; but in 1801, after the battle of Marengo, it was dismantled by the French. It is the seat of a bishopric (founded in 1817), and the official residence of the intendant-general of division. The principal street and square are arcaded on both sides. The churches are built in a line with the houses, and though of very plain exterior they are ornamented internally with beautiful marbles, frescoes, and gilding. Their form is nearly square, but in the interior that of a Greek cross is produced by the arrangement of the piers. Since the railway has been opened between Savena and Turin, Coni has lost the Mediterranean traffic; its commerce is now confined to Turin and the neighboring towns on the plain. In the vicinity a good wine is made called Barolo. Population, 24,300.

CONIC SECTIONS. A conic section is the curve in which a plane cuts a cone, which is defined in Euclid's *Elements* as "a solid figure described by the revolution of a right-angled triangle about one of the sides containing the right angle, which side remains fixed." Though the properties of conic sections can be investigated from this point of view, we consider it more advantageous to start from the following definition, which is derived from one

of the properties which all conic sections possess in common.

**Definition.**—If a point move in such a way in a plane that its distance from a fixed point in the plane always bears a fixed ratio to its distance from a fixed straight line in the plane, the point will trace out a conic section.

The curve is called an *ellipse* if the distance from the fixed point is less than, a *parabola* if it is equal to, and a *hyperbola* if it is greater than, the distance from the fixed straight line.

The fixed point is called a *focus*, and the fixed straight line a *directrix* of the curve.

The fixed ratio of the distance from the focus to the distance from the directrix is called the *eccentricity* of the curve.

The discovery of the conic sections seems to have originated in the school of Plato. It is probable that the followers of that philosopher were led to the discovery of these curves, and to the investigation of many of their properties, in seeking to resolve the two famous problems of the duplication of the cube and the trisection of an angle, for which the artifices of the ordinary or plane geometry were insufficient. Two solutions of the former problem, by the help of the conic sections, are preserved by Eutocius, and are attributed by him to Menechmus, the scholar of Eudoxus, who lived a little after the time of Plato.

The writings of Archimedes that have reached us show that the geometers before his time had advanced a great length in investigating the properties of the conic sections. This author expressly mentions numerous demonstrations of preceding writers, and often refers to properties as known to mathematicians. His own discoveries are worthy of the most profound and inventive genius of antiquity. In the quadrature of the parabola he gave the first and the most remarkable instance that has yet been discovered of the exact equality of a curvilinear to a rectilinear space. He determined the proportion of the elliptic spaces to the circle, and he invented many propositions respecting the mensuration of the solids formed by the revolution of the conic section about their axes.

It is chiefly from the writings of Apollonius of Perga that we know how far the ancient mathematicians carried their speculations concerning these curves. (See APOLLONIUS.) His work on the conic sections, written in eight books, was held in such high estimation by the ancients as to procure for him the name of the Great Geometer. The first four books of this treatise only have come down to us in the original Greek; in these the author claims no further merit than that of having collected, amplified, and arranged the discoveries of preceding mathematicians. One improvement he introduced deserves particular notice. The geometers who preceded him derived each curve from a *right cone*, which they conceived to be cut by a plane perpendicular to its slant side; and Apollonius was the first to show that all the curves are produced from any sort of cone, whether right or oblique, according to the different inclinations of the cutting plane. An Arabic MS. discovered in 1658, and two others brought from the East a few years later, contain the first seven books of the treatise of Apollonius; the eighth book appears to be irrecoverably lost. Dr. Halley, who in 1710 put forth a correct edition of the Conics of Apollonius, guided by the account of the different books preserved by Pappus, has given a very able restoration of the eighth book. The last four books of the Conics of Apollonius, containing the higher or more recondite parts of the science, are generally supposed to be the fruit of the author's own researches, and do much honor to his geometrical skill and invention. Even in our times the whole treatise must be regarded as a very extensive work on the conic sections,—modern mathematicians having made few discoveries of which there are not some traces to be found in the work of Apollonius.

The geometers who followed Apollonius seem to have contented themselves with commenting on his treatise. It was only about the middle of the 16th century that the study of this branch of mathematical science was revived; since that time no part of mathematics has been more cultivated, or has been illustrated by a greater variety of ingenious writings. The applications of the properties of these curves in natural philosophy have, in modern times, given them a degree of importance which they did not formerly possess; and a knowledge of them is now indispensable to any one who seeks to acquaint himself with the remarkable physical discoveries of the present age.

Apollonius and all the earlier writers on conic sections derived the elementary properties of the curves from the nature of the cone; but in 1665 Dr. Wallis, in his *De Sectionibus Conicis*, laid aside the consideration of the cone, deriving the properties of the curves from a description *in plano*. In the following treatise, as has been already stated, the properties of the conic sections are deduced from their description in a plane.

An assemblage of points, all of which satisfy some condition, whether or not they form a continuous curve, is called a *locus*; as, for example, we could define a circle as the locus of a point whose distance from a fixed point is constant, or a conic section as the locus of a point whose distance from a fixed point always bears a constant ratio to its distance from a fixed straight line.

The following is a proposition which is very useful in the discussion of the properties of conic sections.

**LEMMA.**—The locus of a point in a plane whose distances from two fixed points in the plane always bear a constant ratio to one another is a circle.

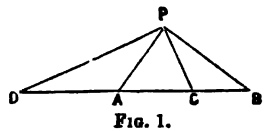

FIG. 1.

$$\frac{CA}{CE} = \frac{DA}{DB} = \frac{PA}{PB}$$

Join PC, PD.

Then, because

$$PA : PB = CA : CB,$$

PC is the internal bisector of the angle APB (Eucl. vi. 9);

and because

$$PA : PB = DA : DB,$$

PD is the external bisector of the angle APB (Eucl. vi. A).

Therefore the angle CPD is a right angle, and the locus of P a circle described on the line CD as diameter.

### PART I.—THE PARABOLA.

#### DEFINITIONS.

A straight line perpendicular to the directrix, terminated at one extremity by the parabola, and produced indefinitely within it, is called a *diameter*.

The point in which a diameter meets the parabola is called its *vertex*.

The diameter which passes through the focus is called the *axis* of the parabola; and the vertex of the axis is called the *principal vertex*.

**COROLLARY.**—A perpendicular drawn from the focus to the directrix is bisected at the vertex of the axis.

A straight line terminated both ways by the parabola, and bisected by a diameter, is called an *ordinate* to that diameter.

The segment of a diameter between its vertex and an ordinate, is called an *abscissa*.

A straight line meeting the parabola in two points P, Q is called a *chord*.

The focal chord which is bisected by a diameter is called the *parameter* of that diameter.

The limiting position of the chord PQ, which it assumes when the point Q moves up to and coincides with P, is called the *tangent* at P.

A line through P at right angles to the tangent is called the *normal* at P.

#### PROPOSITION I.

To find where a parabola of given focus and directrix is cut by a straight line parallel to the directrix.

Let S (fig. 2) be the focus, and XK the directrix. Draw SX perpendicular to XK, and bisect SX in A; draw AZ at right angles to SX, and equal to AS. Join XZ.

Let QN be any straight line parallel to the directrix, cutting XZ in Q and the axis in N.

With centre S and radius equal to QN, describe a circle cutting QN in P and P'; these will be points on the parabola, because

$$SP : XN = QN : XN = ZA : AX = 1 : 1.$$

∴ SP = XN = distance of P from the directrix.

It is clear that if the point

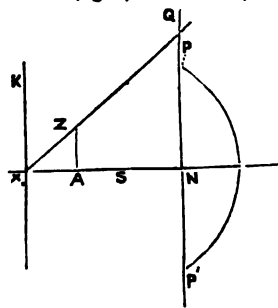

FIG. 2.



Peria, the point P' on the opposite side of the axis also exists, and therefore the parabola is symmetrical with respect to the axis.

Again, the point P will exist, or, in other words, the circle will cut QN, as long as SP or QN is greater than SN, which is always the case as long as QN lies on the same side of AZ as the focus.

The whole of the curve, therefore, lies to the right of AZ, and branches off to an infinite distance from the directrix.

PROP. II.

To find where a parabola of given focus and directrix is cut by a straight line parallel to the axis.

Let S (fig. 3) be the focus, and KK the directrix; draw AY bisecting SX at right angles.

Let KQ be any line parallel to the axis cutting the directrix in K. Join SK cutting AY in Y, and draw YP at right angles to SK cutting KQ in P. P will be a point on the curve.

It is easily shown that the triangles SPY, KPY are equal in all respects, and that  $SP = PK$ .

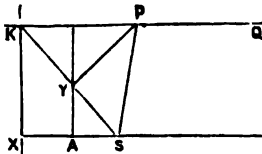

FIG. 3.

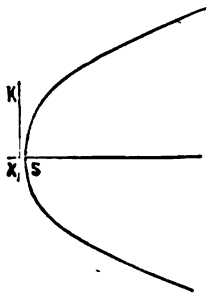

FIG. 4.

Now, the point P will exist, or, in other words, YP will intersect KQ, for all positions of KQ.

The parabola, therefore, branches off on either side of the axis to an infinite distance, and is cut by a straight line parallel to the axis in one point only.

It appears from what has gone before that the general shape of the curve is of the form given in fig. 4, which shows the focus, directrix, and axis.

It can be easily seen that all points within the curve are nearer to the focus than to the directrix, and all points without the curve are nearer to the directrix than to the focus.

A parabola can be described mechanically in the following manner (see fig. 5):—

Suppose a bar KQ to move always parallel to itself, with its end K on a line at right angles to it; then, if a string of length equal to KQ, attached to the bar at Q, and also to a fixed point S, be always kept tight by means of a ring P sliding on KQ, a pencil at P would trace a parabola whose focus is S and directrix XK.

PROP. III.

If a chord PQ (fig. 6) intersect the directrix in Z, then SZ will be the external bisector of the angle PSQ.

Join SP, SQ, and draw PM, QN perpendicular to the directrix.

Then, because the triangles PMZ, QNZ are similar,

$$PZ : QZ = PM : QN = SP : SQ.$$

∴ (Eucl. vi. A) SZ bisects the external angle of the triangle PSQ.

Corollary.—If the point Q move up to and become coincident with P, or if, in other words, the chord PQ become the tangent to the parabola at P, then the angle PSZ will become a right angle.

PROP. IV.

The tangent at any point of a parabola bisects the angle between the focal distance of the point and the perpendicular from the point on the directrix.

Let PZ (fig. 7) be the tangent at P, meeting the directrix in Z; then, if PM be drawn perpendicular to the directrix, it is easily seen that the two triangles SPZ, MPZ are equal in all respects, and the angle SPZ equal to the angle MPZ.

If SM be joined, it can be shown that it is bisected at right angles by PZ, and that its middle point is the point Y in Prop. II.

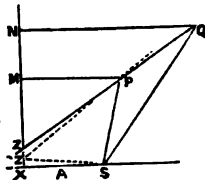

FIG. 6.

The line AY, it will be observed, is the tangent to the parabola at the vertex A.

It appears, therefore, that the locus of the foot of the perpendicular from the focus on the tangent at any point is the tangent at the vertex.

It can also be seen that, if the tangent at P meet the axis in T, then  $SP = ST$ . For the angles STP, SPT are each equal to the angle MPT, and therefore (Eucl. i. 6) SP, ST are equal.

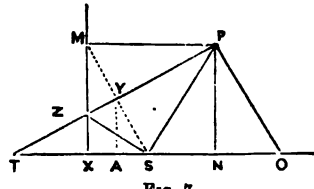

FIG. 7.

It may further be remarked that, if O be any point in the tangent at P, then the triangles SPO, MPO are equal in all respects.

If PN be drawn perpendicular to the axis to meet it in N,

$$\text{then it will be seen that } PN = 2AY \text{ and } TN = 2AN = 2AT.$$

Now, in the right-angled triangle TYS,—

$$TA : AY = AY : AS \text{ (Eucl. vi. 8),}$$

and therefore  $YA^2 = TA \cdot AS$

$$\text{Therefore } PN^2 = 4YA^2 = 4TA \cdot AS = 4AS \cdot AN.$$

If the normal PG be drawn meeting the axis in G, then the triangles PNG, YAS are similar, and therefore—

$$NG : AS = PN : YA = 2 : 1 \therefore NG = 2AS$$

PROP. V.

To draw a tangent to a parabola at a point on the curve.

First Method.—Take a point T in the axis (fig. 7), such that ST is equal to SP, and join TP. Then STP will be the tangent at P.

Second Method.—Draw SZ at right angles to SP, meeting the directrix in Z. ZP is the tangent at P.

Third Method.—On SP as diameter describe a circle; this will touch the tangent at the vertex AY in a point Y. YP is the tangent at P.

PROP. VI.

To draw a pair of tangents to a parabola from an external point.

First Method.—Let O (fig. 8) be the point. Join OS, and with centre O and radius OS describe a circle cutting the directrix (which it will always do in M and M').

Draw MP, M'P', parallel to the axis, cutting the parabola in P and P'. Join OP, OP'. They are tangents to the parabola at P and P'.

Join SP, SP'.

In the triangles OPS, OPM,

$$OP, PM = OP, PS \text{ each to each, and } OM = OS \text{ by the construction;}$$

therefore the angles OPS, OPM are equal, and therefore OP is a tangent to the curve at P (Prop. iv.).

Second Method.—Let O (fig. 9) be the point. Upon OS as diameter describe a circle cutting the tangent at the vertex (which it will always do) in Y and Y'.

Join YO, Y'O, and, if necessary, produce them to meet the curve in P, P'. They will be tangents to the curve at P, P'.

Because OYS is a semi-circle, therefore the angle OYS is a right angle, and therefore YO is a tangent to the parabola (Prop. iv.).

PROP. VII.

If OP, OP' (fig. 8) be tangents to the parabola at P, P', then the triangles OSP, P'SO are similar, and  $SO^2 = SP \cdot SP'$ .

Because the angle OSP = angle OMP = angle OM'P' = angle OSP', and the angle OPS = angle OPM = angle SMM' = 1/2 angle SOM' (Eucl. iii. 20) = angle SOP' (Prop. vi.); therefore the

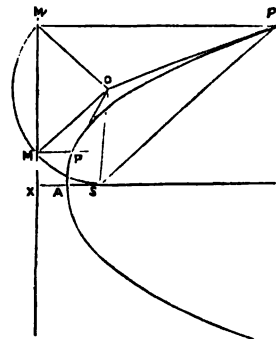

FIG. 8.

remaining angles OPS, P'OS are equal, and the triangles OPS, P'OS similar; and therefore (Eucl. vi. 4)

$$SP : SO = SO : SP', \text{ or} \\ SO^2 = SP \cdot SP'.$$

PROP. VIII.

If O be the intersection of OP, OP', the tangents to the parabola at P and P', then OV drawn parallel to the axis will bisect PP'.

From fig. 8 we see that, if a line through O meet MM' in Z, MM' is bisected in Z; and, because MP, ZOV, and M'P' are parallel, therefore PP' is bisected in V.

PROP. IX.

The angle between two tangents is equal to half the angle subtended at the focus by the chord of contact.

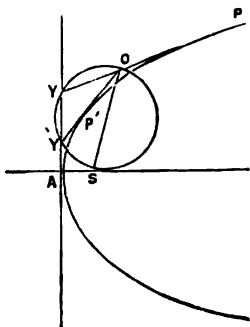

Fig. 9.

From fig. 9 we see that angle YOY' = angle YSY' = angle YSA = angle Y'SA = 1/2 angle PSA = 1/2 angle P'SA = 1/2 angle PSP'.

It may be shown, by means of this proposition, that the circle which is described about the triangle formed by any three tangents to a parabola passes through the focus.

PROP. X.

If OV (fig. 10) meet the parabola in Q, the tangent at Q is parallel to PP', and OV will be bisected in Q.

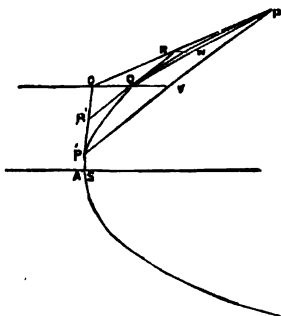

Fig. 10.

Draw the tangent RQR' at Q, meeting OP, OP' in R, R'. Join PQ, and let RW be drawn parallel to OQV meeting PQ in W.

Then PW = WQ (Prop. viii.). Therefore OR = RP (Eucl. vi. 2). Similarly we can show that OR' = R'P'.

Therefore  $OR : RP = OR' : R'P'$ ,

and therefore RR' is parallel to PP' (Eucl. vi. 2); and also

$$OQ : QV = OR : RP$$

$\therefore OQ = QV.$

PROP. XI.

If V be the middle point of a chord PP', and Q be the point at which the tangent is parallel to PP', then  $PV^2 = 4SQ \cdot QV$ .

Suppose in fig. 10 SQ, SR joined, and PO produced to meet the axis in T.

Then angle ORQ = 1/2 angle QSP (Prop. ix.) = angle QSR (Prop. vii.), and angle QRS = angle RPS (Prop. vii.) = angle STP (Prop. iv.) = angle QOR (Eucl. i. 29); therefore the two triangles OQR, SQR are similar, and

$$OQ : QR = QR : SQ$$

therefore

$$QR^2 = SQ \cdot OQ.$$

But

$$PV = 2QR, \text{ and } OQ = QV,$$

therefore

$$PV^2 = 4SQ \cdot QV.$$

PROP. XII.

The parameter of the diameter QV is 4SQ.

If the tangent at Q (fig. 11) meets the axis in T,

$$SQ = ST \\ = QV.$$

Therefore the equality

$$PV^2 = 4SQ \cdot QV$$

becomes

$$PV^2 = 4SQ^2$$

therefore

$$PV = 2SQ$$

or

$$PP' = 4SQ.$$

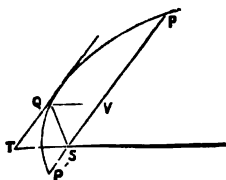

Fig. 11.

PROP. XIII.

If POP' (fig. 12) be any chord, and OR be drawn parallel to the axis through any point O to meet the curve in R, then  $PO \cdot OP' = 4SQ \cdot RO$ , where 4SQ is the parameter of diameter PP'

Draw RW parallel to PP' to meet QV in W.

Then  $PV^2 = 4SQ \cdot QV$   
and  $RW^2 = 4SQ \cdot QW$ ,  
and  $RO = WV$  and  $RW = OV$ .

Therefore

$$PO \cdot OP' = PV^2 - OV^2 \text{ (Eucl. II. 5)} \\ = PV^2 - RW^2 \\ = 4SQ \cdot QV - 4SQ \cdot QW \\ = 4SQ \cdot WV = 4SQ \cdot RO$$

PROP. XIV.

If POP', pOp' be any two chords intersecting in O, and Q, q are the points of contact of the tangents parallel to them, then

$$PO \cdot OP' : pO \cdot Op' = SQ : Sq.$$

By Prop. xiii.,  $PO \cdot OP' = 4SQ \cdot RO$  and similarly  $pO \cdot Op' = 4Sq \cdot RO$ .

Therefore

$$PO \cdot OP' : pO \cdot Op' = 4SQ \cdot RO : 4Sq \cdot RO = SQ : Sq$$

PROP. XV.

The area included between any chord of a parabola and the curve is two-thirds the area of the triangle formed by the chord and the tangents to the curve at its extremities.

It is easily seen in fig. 10 that the area of the triangle ORR' is one-quarter the area of the triangle OPP', and therefore one-half the area of the triangle QPP'.

Now if we draw tangents where RW, R'W' meet the curve, we shall have two pairs of triangles whose areas are in the ratio 1:2, and so we may go on indefinitely. The sum of all the external triangles will be half the sum of all the internal triangles.

The sum of the external triangles is the curvilinear area OPQP', and the sum of the internal triangles is the curvilinear area PQQP'. Therefore

$$2 \times \text{area OPQP}' = \text{area PQQP}' \\ \therefore 2 \times \text{triangle OPP}' = 3 \text{ area PQQP}' \\ \text{area PQQP}' = \frac{1}{3} \text{ triangle OPP}'.$$

or

PART II.—THE ELLIPSE.

DEFINITIONS.

A straight line passing through the centre, and terminated both ways by the ellipse, is called a *diameter*.

The extremities of a diameter are called its *vertices*.

The diameter which passes through the foci is called the *transverse axis*, also the *major axis*.

The diameter which is perpendicular to the transverse axis is called the *conjugate axis*, also the *minor axis*.

Any straight line not passing through the centre, but terminated both ways by the ellipse, and bisected by a diameter, is called an *ordinate* to that diameter.

Each of the segments of a diameter intercepted between its vertices and an ordinate, is called an *abscissa*.

A *chord*, *tangent*, and *normal* are defined exactly in the same words as in the case of the parabola.

PROP. I.

To find where an ellipse of given focus, directrix, and eccentricity is cut by a straight line parallel to the directrix.

Let S (fig. 13) be the focus, XK the directrix, and e the eccentricity.

Draw SX perpendicular to XK, and divide it internally and externally in the ratio e:1 in the points A, A', so that

$$SA : AX = SA' : A'X = e : 1.$$

It is clear that A and A' will both be on the same side of X as S is, because the eccentricity e is less than 1.

Draw AZ at right angles to SX and equal to AS; and join ZX.

Let QN be any straight line parallel to the directrix, cutting XZ in Q and the axis in N. With centre S and radius equal to QN describe a circle cutting QN in P and P'; these will be points on the ellipse; for we have

$$SP : XN = QN : XN = ZA : AX = SA : AX = e : 1.$$

It is clear that if this point P exists, the point P' on the opposite side of the axis also exists, and therefore the ellipse is symmetrical with respect to the axis. Again, the point P

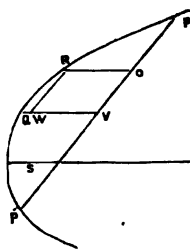

Fig. 12.

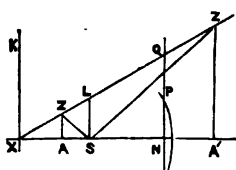

Fig. 13.

will exist, or, in other words, the circle will cut QN as long as SP or QN is greater than SN, which is always the case as long as the angle QSN is greater than half a right angle. Now if SL, A'Z' be drawn at right angles to SX, cutting XZ in L, Z', then (Eucl. vi. 4)

$$\begin{aligned} Z'A' : A'X &= ZA : AX. \\ \text{But } SA' : A'X &= SA : AX \\ \text{and } SA &= ZA \\ SA' &= Z'A' \end{aligned}$$

From which it is easily seen that the angle Z'SA' is half a right angle. The whole curve therefore lies between the two lines AZ, A'Z'.

PROP. II.

To find where an ellipse of given focus, directrix, and eccentricity is cut by a straight line perpendicular to the directrix.

Let S (fig. 14) be the focus, XK the directrix, and e the eccentricity.

Draw SX perpendicular to XK, and divide SX in A, A', so that

$$SA : AX = SA' : A'X = e : 1;$$

and draw AR, A'R' at right angles to SX.

Let KQ be any line parallel to the axis cutting the directrix in K. Join SK cutting AR, A'R' in R, R', and upon RR' as diameter describe a circle cutting KQ in P, P'; these will be points on the curve.

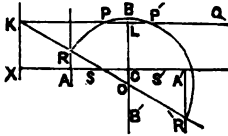

FIG. 14.

$$\text{For } SR : RK = SA : AX = e : 1 = SA' : A'X = SR' : R'K.$$

Therefore by the Lemma in the introduction

$$SP : PK = SP' : P'K = SR : RK = e : 1.$$

Therefore P and P' are points on the ellipse.

Now, if the point P exists, the point P' also exists, and it is easily seen that the middle point L of PP' lies on a straight line bisecting AA' at right angles. The curve therefore is symmetrical, not only with respect to the axis AA', but also with respect to this line bisecting AA' at right angles. The middle point C of AA' is called the centre of the curve, from the fact that every straight line through C is bisected at the point.

It is evident from what has preceded that, if we measure CS = CS, and CX' = CX, in the opposite direction to CS and CX, and draw X'K' parallel to XK, the ellipse might be described with S' for focus, X'K' for directrix, and eccentricity e.

The ellipse, therefore, has two foci and two directrices.

$$\begin{aligned} \text{Now, since } SP : PK &= SP' : P'K = e : 1. \\ \text{Therefore } SP + SP' : PK + P'K &= e : 1, \\ \text{but } PK + P'K &= 2KL = 2CX. \\ \therefore SP + SP' &= 2e \cdot CX. \end{aligned}$$

$$\begin{aligned} \text{Now, it is easily seen that } SP' &= S'P; \\ \text{Therefore } SP + S'P &= 2e \cdot CX; \end{aligned}$$

or the sum of the focal distances of any point on the curve is constant.

$$\begin{aligned} \text{Again } SA : AX &= SA' : A'X = e : 1, \\ \text{Therefore } SA + SA' : AX + A'X &= e : 1. \\ \text{But } AX + A'X &= 2CX, \\ \therefore SA + SA' &= SP + S'P. \end{aligned}$$

$$\begin{aligned} \text{And } SA' &= S'A, \\ \text{Therefore } SP + S'P &= SA + S'A \\ &= AA'; \end{aligned}$$

or the sum of the focal distances of any point on the ellipse is equal to the major axis.

The point P will exist, or, in other words, the circle on RR' as diameter will intersect KQ, if OL is less than OR when O is the middle point of RR'.

$$\begin{aligned} \text{Now } SX : SK &= CA : OR, \\ \therefore OR \cdot SX &= SK \cdot CA; \\ \text{and } OL = OC + CL &= KX \cdot \frac{SC}{SX} + KX. \end{aligned}$$

Therefore the point exists if

$$\begin{aligned} \cdot KX \cdot SC + KX \cdot SX &< SK \cdot CA; \\ \text{i.e., if } KX \cdot CX &< SK \cdot CA; \\ \text{if } KX^2 \cdot CX^2 &< SK^2 \cdot CA^2; \\ \text{if } KX^2 \cdot (CX^2 - CA^2) &< SX^2 \cdot CA^2; \\ \text{if } KX^2 &< \frac{SX^2 \cdot CA^2}{CX^2 - CA^2}; \text{ or if } KX < CB, \\ \text{when } CX^2 - CA^2 : CA^2 &= SX^2 : CB^2. \end{aligned}$$

When KX has this value the points P, P' coincide in CL, say at B or B'.

It appears therefore that the ellipse lies wholly within a certain rectangle, and that its general shape is of the form given in fig. 15 which shows the centre C, the foci S, S', and directrices XK and X'K'.

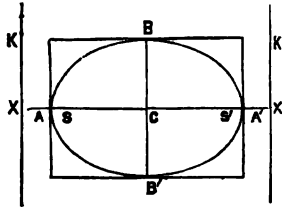

FIG. 15.

It can easily be shown that the sum of the focal distances of any point within the ellipse is less than, and the sum of any point without greater than, AA', and also that the ratio of the focal distance of any point within the ellipse to its distance from the corresponding directrix is less

than, and the ratio for any point without greater than, the eccentricity.

An ellipse can be described mechanically in the following manner:

If an endless string be placed over two small fixed pegs S, S' and be kept tight so as to form a triangle PSS', then a pencil at P would trace out an ellipse whose foci are S, S', and whose major axis is equal to the length of the string minus the distance between the pegs.

PROP. III.

If a chord PQ (fig. 16) intersect in Z the directrix corresponding to the focus S, then SZ will be the external bisector of the angle PSQ.

Join SP, SQ; and draw PM, QN perpendicular to the directrix.

Then because the triangles PMZ, QNZ are similar,

$$PZ : QZ = PM : QN = SP : SQ$$

∴ (Eucl. vi. A) SZ bisects the external angle of the triangle PSQ.

COROLLARY.—If the point Q moves up to and coincides with P, or, in other words, the chord PQ becomes the tangent to the ellipse, at P, then the angle PSZ will be a right angle.

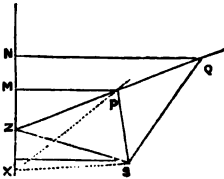

FIG. 16.

PROP. IV.

The foot of the perpendicular from the focus on the tangent always lies on the circle described on the major axis as diameter.

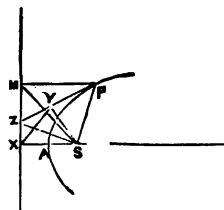

FIG. 17.

Let PZ (fig. 17) be the tangent at P, meeting the directrix in Z. Let S be the corresponding focus. Join SP, SZ, and draw PM, SY, perpendicular to the directrix and the tangent respectively. Join YX, SM.

Because the angles PMZ, PSZ are right angles, a circle will circumscribe PSZM; and because the angles SYZ, SXZ are right angles, a circle will circumscribe SYZX.

Therefore angle SYX = angle SZX = supplement of angle SZM = angle SPM; and angle SXY = angle SZY = angle SMP. Therefore the triangles SYX, SPM are similar, and SY : YX = SP : PM = SA : AX.

Therefore the locus of Y is a circle on AA' as diameter. (Lemma, Introduction.)

PROP. V.

The product of the perpendiculars from the foci on the tangent is constant.

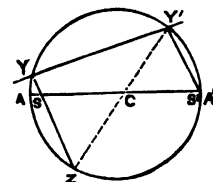

FIG. 18.

If SY, S'Y' (fig. 18) be the perpendiculars from the foci on any tangent, then it is easily seen that, if YS be produced to meet the circle on AA' as diameter again in Z, ZCY' is a straight line, and S'Y' = SZ.

Therefore SY · S'Y' = SY · SZ = AS · SA' (Eucl. iii. 35)

PROP. VI.

The tangent at any point of an ellipse makes equal angles with the focal distances of the point.

Let the tangent  $ZPZ'$  (fig. 19) at the point  $P$  meet the two directrices in  $Z, Z'$ . Join  $ZS, SP, PS', S'Z'$ , and draw  $MPM'$  parallel to the axis, to meet the directrices in  $M, M'$ . Then because  $SP : PZ = ePM : PZ = ePM' : PZ' = S'P' : PZ'$ , and the angles  $PSZ, PS'Z'$  are right angles (Prop. vii), therefore the triangles  $PSZ, PS'Z'$  are similar (Eucl. vi. 7). Therefore the angle  $SPZ = \text{angle } S'PZ'$ .

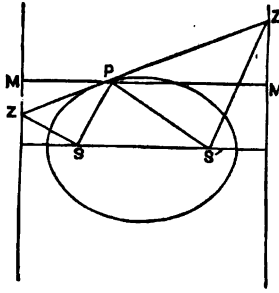

FIG. 19.

PROP. VII.

To draw a tangent to an ellipse at a point on the curve.  
*First Method.*—Join  $SP, S'P$ , and draw a line bisecting the external angle of  $SPS'$ . This line is the tangent at  $P$ . (Prop. vi.)  
*Second Method.*—Draw  $SZ$  at right angles to  $SP$ , meeting the corresponding directrix in  $Z$ .  $ZP$  is the tangent at  $P$ . (Prop. iii.)  
*Third Method.*—On  $SP$  as diameter describe a circle which will touch the circle on  $AA'$  as diameter in a point  $Y$ .  $YP$  is the tangent at  $P$ . (Prop. iv.)

PROP. VIII.

To draw a pair of tangents to an ellipse from an external point.

*First Method.*—Let  $O$  (fig. 20) be the point, and  $S, S'$  the foci. Join  $OS$ . With centre  $O$  and radius  $OS$  describe a circle; and with centre  $S'$  and radius equal to  $AA'$  describe another circle. It can be shown that these two circles will always intersect in two points  $M, M'$ .  
 Join  $S'M, S'M'$ , cutting the curve in  $P, P'$ . Then  $OP, OP'$  will be tangents to the curve.  
 Join  $SP, S'P'$ .  
 Now  $SP + PS' = AA' = MS'$   
 =  $MP + PS'$   
 therefore  $SP = MP$ ;  
 and  $OS = OM$ ;  
 therefore the two triangles  $OPS, OPM$  are equal in all respects, and the angle  $OPS = \text{angle } OPM$ .  
 Therefore  $OP$  is a tangent to the ellipse at  $P$ . (Prop. vi.)  
*Second Method.*—Let  $O$  (fig. 21) be the point, and  $S, S'$  the foci.  
 Join  $OS$ , and upon it as diameter describe a circle, cutting the circle described on  $AA'$  as diameter (which it will always do) in  $Y, Y'$ .  
 Join  $OY, OY'$ , and produce them if necessary to meet the curve in  $P, P'$ . They will be tangents to the curve at  $P, P'$ .  
 Because  $OYS$  is a semicircle, the angle  $OYS$  is a right angle, and therefore  $OY$  is a tangent to the ellipse. (Prop. iv.)

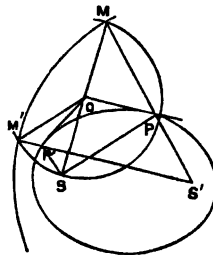

FIG. 20.

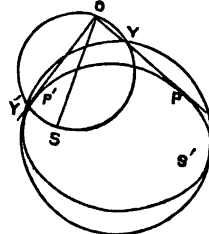

FIG. 21.

PROP. IX.

If  $OP, OP'$  be tangents to the ellipse at  $P, P'$ , and  $S$  be a focus, the angles  $OSP, OSP'$  are equal.

In fig. 20 we have

$$\begin{aligned} \text{angle } OSP &= \text{angle } OMP \\ &= \text{angle } M'MS' - \text{angle } M'MO \\ &= \text{angle } MM'S' - \text{angle } MM'O \\ &= \text{angle } OM'S' = \text{angle } OSP'. \end{aligned}$$

PROP. X.

If  $OP, OP'$  be two tangents to the ellipse, and  $S, S'$  be the foci, the angles  $SOP, S'OP'$  are equal.

In fig. 21 suppose  $S'Z, S'Z'$  be drawn perpendicular to  $OP, OP'$  respectively, then

$$SY \cdot S'Z = SY' \cdot S'Z' \quad (\text{Prop. v.})$$

therefore

$$SY : SY' = S'Z' : S'Z.$$

Also the angle  $YSY' = \text{supplement of angle } POP' = Z'SZ$ .

Therefore the triangles  $YSY', Z'SZ$  are similar, and the angle  $Y'YS = S'Z'Z$ , and angle  $Y'YS = \text{angle } Y'OS$ , and angle  $S'Z'Z = \text{angle } S'OZ$ .  
 Therefore  $\text{angle } SOP = \text{angle } S'OP'$ .

PROP. XI.

If  $C$  (fig. 22) be the middle point of  $AA'$ , then  $CA^2 = CS \cdot CX$ .

$$SA' : A'X = e : 1 = SA : AX.$$

$$\therefore SA' + SA : SA = A'X + AX : AX,$$

or

$$AA' : SA = XX' : AX$$

$$\therefore AA' : XX' = SA : AX = e : 1. \quad (1)$$

Again,

$$SA' - SA : SA = A'X - AX : AX.$$

or

$$SS' : SA = AA' : AX$$

$$\therefore SS' : AA' = SA : AX = e : 1. \quad (2)$$

From (1) and (2),

$$AA' : XX' = SS' : AA',$$

or

$$CA : CX = CS : CA$$

$$\therefore CA^2 = CS \cdot CX. \quad (3)$$

Also

$$\begin{aligned} CS : CX &= CS^2 : CA^2 \\ &= CA^2 : CX^2. \quad (4) \end{aligned}$$

PROP. XII.

If  $PN$  be an ordinate of the ellipse, then  $PN^2$  always bears a constant ratio to  $AN \cdot NA'$ .

By similar triangles  $PNA', Z'XA'$  (fig. 22),  $PN : NA' = Z'X : XA'$ ,

and by similar triangles  $PNA, ZX A$ ,

Therefore  $PN : NA = ZX : XA$ .

Now it appears from Prop. iii. that the angle  $Z'SZ$  is a right angle; therefore  $ZX \cdot XZ' = SX^2$  (Eucl. vi. 8);

and  $XA \cdot XA' = CX^2 - CA^2$ .

Therefore  $PN^2 \cdot AN \cdot NA' = SX^2 \cdot CX^2 - CA^2$

=  $CB^2 \cdot CA^2$  (Prop. ii.)

PROP. XIII.

The ordinates of the ellipse and of the circle described on  $AA'$  as diameter are in a constant ratio.

If, in fig. 22,  $NP$  be produced to meet the circle on  $AA'$  as diameter in  $Q$ , then

$$QN^2 = AN \cdot NA'$$

$$\text{and } PN^2 = AN \cdot NA'$$

$$= CB^2 : CA^2 \quad (\text{Prop. xii.})$$

$$\therefore PN^2 : QN^2 = CB^2 : CA^2$$

$$\text{and } PN : QN = CB : CA.$$

COROLLARY.—The ordinates of two ellipses which have a common major axis are in a constant ratio.

It can easily be shown from the last result, if  $QPN, Q'P'N'$  be two common ordinates of the circle and ellipse,—(1)

that the chords  $PP', QQ'$  will meet the axis in the same

point; (2) that the tangents at  $P, Q$  will meet the axis at the same

point; (3) that the intersection of the tangents at  $P, P'$  and the

intersection of the tangents at  $Q, Q'$  will lie on a straight line

perpendicular to the axis; (4) that the middle points of  $PP'$

and  $QQ'$  lie on a straight line perpendicular to the axis.

It can also be shown by means of this proposition that the

area of the circle is to the area of the ellipse as  $AC$  to  $BC$ , and

that the area of the parallelogram formed by the four tangents

at the extremities of two conjugate diameters (see definition

below) is constant, and is equal to  $AC \cdot BC$ .

PROP. XIV.

The middle points of all parallel chords in an ellipse lie on a straight line through the centre.

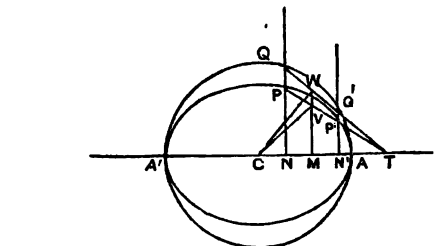

FIG. 23.

Let  $QPN, Q'P'N$  (fig. 23) be two common ordinates of the circle on  $AA'$  as diameter and the ellipse.

Let  $W, V$  be the middle points of  $QQ', PP'$ .  $W, V$  lie on a straight line which bisects  $NN'$  at right angles.

Now, as long as  $PP'$  remains parallel to itself,  $QQ'$  must remain parallel to itself, and therefore its middle point  $W$  lies on a fixed straight line, the diameter at right angles to  $QQ'$ . Therefore  $V$  lies on a fixed straight line through  $C$ , since  $WM = BC = AC$ .

The tangents at the points where  $CV$  cuts the ellipse will be parallel to the chords  $PP'$  which  $CV$  bisects.

*Definition.*—If  $CD$  be drawn parallel to the tangent at  $P$ , then  $CD$  is said to be *conjugate* to  $CP$ .

Now it is evident that  $CD$  and  $CP$  will correspond to two radii at right angles in the circle on  $AA'$  as diameter, and therefore if  $CD$  is conjugate to  $CP$ ,  $CP$  will also be conjugate to  $CD$ .

PROP. XV.

If  $CP, CD$  (fig. 24) be semi-conjugate diameters, then  $CP^2 + CD^2 = AC^2 + BC^2$ .

Draw  $QPN, Q'DN'$  common ordinates of the circle and the ellipse.

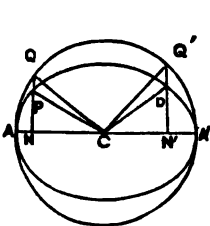

FIG. 24.

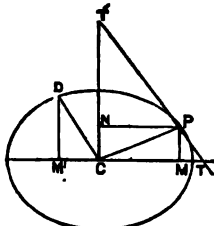

FIG. 25.

Then  $CQ, CQ'$  will be at right angles, and therefore the two triangles  $QCN, CQ'N'$  will be equal in all respects.

and

$$\begin{aligned} \therefore NC &= Q'N' \\ QN &= CN' \\ \therefore QN^2 + Q'N'^2 &= QN^2 + NC^2 = AC^2. \\ \therefore PN^2 + DN'^2 &= BC^2 \text{ (Prop. xii.)} \\ \therefore CP^2 + CD^2 &= CN^2 + N'^2 + CN'^2 + N'D^2 \\ &= Q'N'^2 + N'^2 + QN^2 + N'D^2 \\ &= AC^2 + BC^2. \end{aligned}$$

It follows that if the tangent at  $P$  meets the axis in  $T, T'$  (fig. 26), then

$$PT \cdot PT' = CD^2.$$

Draw ordinates  $PM, DM'$  to the major axis, and  $PN$  to the minor axis.

Then

$$PT : PM = CD : DM'$$

and

$$PT' : PN = CD : CM'$$

and

$$\begin{aligned} \therefore PT \cdot PT' : PM \cdot PN &= CD^2 : CM' \cdot DM'. \\ \therefore PT \cdot PT' : CD^2 &= PM \cdot PN : CM' \cdot DM' \\ &= \frac{PM}{CM'} : \frac{DM'}{CM} \\ &= \frac{BC}{AC} : \frac{BC}{AC} = 1 : 1 \\ \therefore PT \cdot PT' &= CD^2. \end{aligned}$$

PROP. XVI.

If  $CP, CD$  be semi-conjugates, and  $QV$  be an ordinate parallel to  $CD$ , then  $QV^2 = PV \cdot VP' = CD^2 : CP^2$ .

Draw  $QR$  an ordinate parallel to  $CP$ , and draw  $UQW$  the tangent to the ellipse at  $Q$ , meeting  $CP, CD$  in  $U, W$ .

Then

$$CR \cdot CW = CD^2$$

$$\therefore CR^2 : CD^2 = CR : CW = UV : CU.$$

Again

$$CU \cdot CV = CP^2$$

$$\therefore CU : CV = CP^2 : CV^2$$

or

$$CU - CV : CU = CP^2 - CV^2 : CP^2$$

Hence

$$UV : CU = PV \cdot VP' : CP^2$$

or

$$QR^2 : CD^2 = PV \cdot VP' : CP^2$$

PROP. XVII.

If  $POP'$  (fig. 26) be any chord, and  $BOC'R'$  the diameter through  $O$ , then

$$PO \cdot OP' : RO \cdot OR' = CD^2 : CR^2,$$

where  $CD$  is the semi-diameter parallel to  $PP'$ .

Draw  $OVWQ$  conjugate to  $PP'$ , meeting the curve in  $Q$ , and the ordinate through  $R$  in  $W$ .

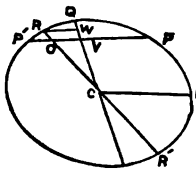

FIG. 26.

Then  $PV^2 : CQ^2 - CV^2 = CD^2 : CQ^2$   
 and  $RW^2 : CQ^2 - CW^2 = CD^2 : CQ^2$  (Prop. xvi.)  
 $\therefore PV^2 - RW^2 : \frac{CV^2}{CW^2} = CQ^2 - CV^2 - (CQ^2 - CW^2) : \frac{CQ^2}{CW^2}$   
 $= -CD^2 : CQ^2.$

Now  $PV^2 - RW^2 : \frac{CV^2}{CW^2} = PV^2 - OV^2 - PO \cdot OP' : \frac{CV^2}{CW^2}$

and  $CQ^2 - CV^2 - (CQ^2 - CW^2) : \frac{CV^2}{CW^2}$   
 $= -CQ^2 \cdot \left( \frac{CW^2 - CV^2}{CW^2} \right)$   
 $= -CQ^2 \cdot \frac{CR^2}{CR^2 - CQ^2}.$

Therefore  $PO \cdot OP' : CQ^2 \cdot \frac{RO \cdot OR'}{CR^2} = CD^2 : CQ^2$   
 or  $PO \cdot OP' : RO \cdot OR' = CD^2 : CR^2.$

PROP. XVIII.

If  $POP', pOp'$  be any two chords, and  $CD, Cd$  the semi-diameters parallel to them, then

$$PO \cdot OP' : pO \cdot Op' = CD^2 : Cd^2.$$

From the last proposition we have

$$PO \cdot OP' : RO \cdot OR' = CD^2 : CR^2$$

and

$$pO \cdot Op' : rO \cdot Or' = Cd^2 : CR^2$$

Therefore

$$PO \cdot OP' : CD^2 = RO \cdot OR' : CR^2$$

$$= pO \cdot Op' : Cd^2$$

or

$$PO \cdot OP' : pO \cdot Op' = CD^2 : Cd^2.$$

PROP. XIX.

If the two extremities of a rod slide along two fixed straight lines at right angles to one another, any fixed point in the rod will describe an ellipse.

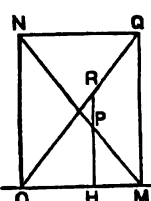

FIG. 27.

Let  $OM, ON$  (fig. 27) be the two fixed straight lines, and  $MPN$  any position of the rod, and  $P$  the tracing point.

Complete the rectangle  $QMON$  and join  $OQ$ , and draw, parallel to  $ON$ ,  $RPH$  to meet  $OQ$  in  $R$  and  $OM$  in  $H$ .

Then it can easily be shown that

$$OR = NP$$

and that

$$RH : PH = OR : PM = PN : PM.$$

The locus of  $R$  is a circle whose centre is  $O$  and radius  $PN$ . And the locus therefore of  $P$  is an ellipse whose axes are in  $OM$  and  $ON$  and equal to  $PN, PM$  respectively.

PROP. XX.

If a circle roll on the inside of a fixed circle of double the radius, any fixed point in the circumference of the moving circle will trace out a diameter of the fixed circle, and any other point in the plane of the moving circle will trace out an ellipse.

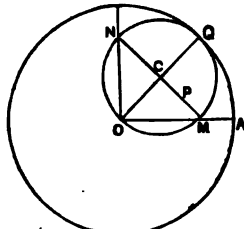

FIG. 28.

If the point  $M$  (fig. 28) coincided with  $A$  at the beginning of the motion and the circle now touch at  $Q$ , the arcs  $MQ, QA$  must be equal. Therefore if  $C$  and  $O$  be the centres, the angle  $QCM$  is double the angle  $QOM$ , and therefore  $OCQ$  is always a straight line; as also  $MCN$ .

It is clear therefore that the motion of a point  $P$  in  $MN$  is exactly the same as in that of a point in the moving rod. (Prop. xix.)

PART III.—THE HYPERBOLA.

DEFINITIONS.

A straight line passing through the centre, and terminated by the hyperbola, is called a *diameter*.

The extremities of a diameter are called its *vertices*.

The diameter which passes through the foci is called the *transverse axis*.

A straight line  $BCB'$  passing through the centre, perpendicular to the transverse axis, such that

$$BC^2 = B'C^2 = SC^2 - AC^2,$$

is called the *conjugate axis*.

Any straight line terminated both ways by the hyperbola, and bisected by a diameter produced, is called an *ordinate* to that diameter.

Each of the segments of a transverse diameter produced,

intercepted by its vertices and an ordinate, is called an *abscissa*.

A *chord*, *tangent*, and *normal* are defined exactly in the same words as in the case of the parabola.

PROP. I.

To find where an hyperbola of given focus, directrix, and eccentricity is cut by a straight line parallel to the directrix.

Let  $S$  (fig. 29) be the focus,  $XK$  the directrix and  $e$  the eccentricity.

Draw  $SX$  perpendicular to  $XR$ , and divide it internally and externally in the ratio  $e$  to 1 in the points  $A, A'$ , so that

$$SA : AX = SA' : A'X = e : 1.$$

It is clear that  $A$  will lie between  $S$  and  $X$ , and  $A'$  without  $SX$  on the side remote from  $S$ .

Draw  $AZ$  at right angles to  $SX$  and equal to  $AS$ , and join  $XZ$ . Let  $QN$  be any straight line parallel to the directrix cutting  $XZ$  in  $Q$  and the axis in  $N$ .

With centre  $S$  and radius equal to  $QN$ , describe a circle cutting  $QN$  in  $P$  and  $P'$ ; these will be points on the hyperbola.

It is clear that if the point  $P$  exists, the point  $P'$  on the opposite side of the axis also exists, and therefore the hyperbola is symmetrical with respect to the axis.

Again, the point  $P$  will exist, or, in other words, the circle will cut  $QN$  as long as  $SP$  or  $QN$  is greater than  $SN$ , which is always the case as long as the angle  $QSN$  is greater than half a right angle.

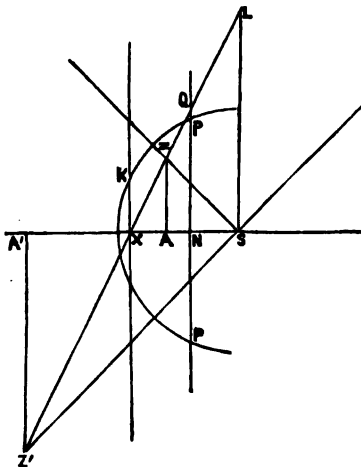

FIG. 29.

Now, if  $SL, A'Z'$  be drawn at right angles to  $SX$ , cutting  $XZ$  in  $L, Z'$  then (Eucl. vi. 4)

$$\begin{aligned} Z'A' : A'X &= ZA : AX, \\ \text{but } SA' : A'X &= SA : AX, \\ \text{and } SA &= ZA, \\ \therefore SA' &= Z'A', \end{aligned}$$

from which it is easily seen that the angle  $Z'SA'$  is half a right angle.

The whole curve therefore lies without the two lines  $AZ, A'Z'$ .

PROP. II.

To find where an hyperbola of given focus, directrix, and eccentricity is cut by a straight line perpendicular to the directrix.

Let  $S$  (fig. 30) be the focus,  $XK$  the directrix, and  $e$  the eccentricity.

Draw  $SX$  perpendicular to  $XK$ , and divide  $SX$  in  $A, A'$ , so that

$$SA : AX = SA' : A'X = e : 1;$$

and draw  $AR, A'R'$  at right angles to  $SX$ .

Let  $KQ$  be any line parallel to the axis, cutting the directrix in  $K$ . Join  $SK$ , cutting  $AR, A'R'$  in  $R, R'$ , and upon  $RR'$  as diameter describe a circle cutting  $KQ$  in  $P, P'$ ; these will be points on the curve. Now

$$\begin{aligned} SR : RK &= SA : AX = e : 1 \\ &= SA' : A'X \\ &= SR' : R'K. \end{aligned}$$

Therefore by the Lemma in the introduction

$$SP : PK = SP' : P'K = SR : RK = e : 1.$$

Therefore  $P$  and  $P'$  are points on the hyperbola.

Now, if the point  $P$  exists, the point  $P'$  also exists, and it is

easily seen that the middle point  $L$  lies on a straight line bisecting  $AA'$  at right angles. The curve, therefore, is symmetrical, not only with respect to the axis  $AA'$ , but also with respect to the line bisecting  $AA'$  at right angles. The middle point  $O$  of

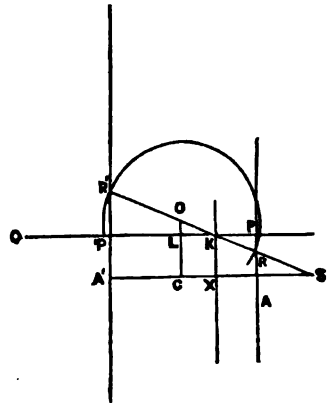

FIG. 30.

$AA'$  is called the *centre* of the curve, from the fact that every straight line through  $C$  is bisected at the point.

It is evident from what has preceded that if we measure  $CS' = CS$  and  $CX' = CX$ , in the opposite direction to  $CS$  and  $CX$ , and draw  $X'K'$  parallel to  $XK$ , the hyperbola might be described with  $S'$  for focus,  $X'K'$  for directrix, and eccentricity  $e$ .

The hyperbola therefore has two foci and two directrices.

Now, since

$$SP : PK = SP' : P'K = e : 1,$$

therefore

$$SP' - SP = P'K - PK = e - 1,$$

but

$$P'K - PK = 2LK = 2CX$$

$$\therefore SP' - SP = 2e \cdot CX.$$

Now it is easily seen that  $SP' = S'P$ ,

therefore

$$S'P - SP = 2e \cdot CX,$$

or the difference of the focal distances of any point on the curve is constant.

Again  $SA : AX = SA' : A'X = e : 1$

$$\therefore SA' - SA = A'X - AX = e - 1,$$

but

$$SA' - SA = AA'$$

and

$$A'X - AX = 2CX.$$

$$\therefore SP' - SP = SA' - SA = AA',$$

or the difference of the focal distances of any point on the hyperbola is equal to the transverse axis.

The point  $P$  will always exist, or in other words, the circle on  $R, R'$  as diameter will always intersect  $KQ$ , because  $R, R'$  are on opposite sides of  $KQ$ .

Any straight line therefore parallel to the axis cuts the curve, and the curve must take the form given in fig. 31, which shows the centre  $C$ , the foci  $S, S'$ , and the directrices  $XK, X'K'$ .

It can easily be shown that the difference of the focal distances of any point on the concave side or either of the two branches (which is called within the curve) is greater than  $AA'$ , and the difference of the focal distances of any point outside the curve is less than  $AA'$ ; and also that the ratio of the focal distance of any point within the hyperbola to its distance from the corresponding directrix is less, and the ratio for any point without is greater, than the eccentricity.

If a line  $BCB'$  be drawn perpendicular to  $ACA'$ , and points

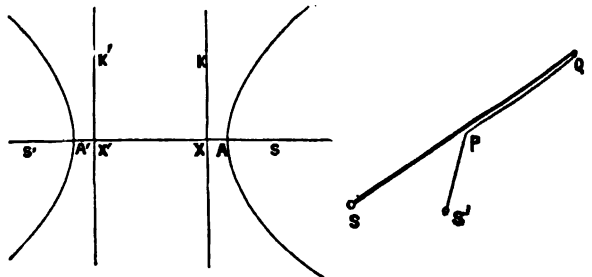

FIG. 31.

$B, B'$  taken in it such that  $CB^2 = CB'^2 = CS^2 - CA^2$ , then  $AA'$  is called the *transverse axis*, and  $BB'$  the *conjugate axis* of the hyperbola.

If an hyperbola be described with  $BB'$  for transverse axis, and

AA' for conjugate axis, then this hyperbola is said to be *conjugate* to the first one.

It is clear that the foci of the conjugate hyperbola will be in BCB' at the same distance from C as S and S'.

An hyperbola can be described mechanically in the following manner:—

Suppose a bar SQ (fig. 32) to revolve round its extremity S which is fixed; then if a string of given length, attached to the bar at Q, and also to a fixed point S', be always kept tight by means of a ring P sliding on SQ, a penoil at P would trace a hyperbola whose foci are S, S', and whose transverse axis is equal to the length of the rod minus the length of the string.

PROP. III.

If a chord PQ intersect in Z the directrix corresponding to the focus S, then SZ will be the external bisector of PSQ if P, Q both lie on the same branch of the hyperbola, and SZ will be the internal bisector of the angle PSQ, if P, Q lie on different branches.

It can be shown exactly as in Prop. iii. on the ellipse that  $PZ : QZ = SP : PQ$ ,

which proves the proposition.

Corollary.—If the point Q moves up to and coincides with P, or in other words, the chord PQ becomes the tangent to the hyperbola at P, then the angle PSZ will become a right angle.

PROP. IV.

The foot of the perpendicular from the focus on the tangent always lies on the circle described on the transverse axis as diameter.

This proposition is proved in exactly the same way as Prop. iv. on the ellipse.

PROP. V.

The product of the perpendiculars from the foci on the tangent is constant.

This proposition is proved exactly in the same way as Prop. v. on the ellipse, the only difference in the figure being that S, S' lie without the circle instead of within as in the case of the ellipse.

PROP. VI.

The tangent at any point of an hyperbola makes equal angles with the focal distances of the point.

Let the tangent PZZ' at the point P (fig. 33) meet the two directrices in Z, Z'.

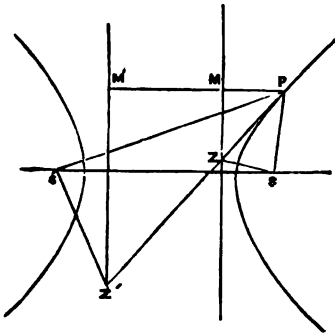

Fig. 33.

Join ZS, SP, PS', S'Z', and draw PMM' parallel to the axis to meet the directrices in M, M'.  
Then because

$$\begin{aligned} SP : PZ &= ePM : PZ \\ &= ePM' : PZ' \\ &= PS' : PZ', \end{aligned}$$

and the angles PSZ, PS'Z' are right angles (Prop. iii.), therefore the triangles PSZ, PS'Z' are similar (Eucl. vi. 7). Therefore the angle SPZ = angle S'PZ'.

PROP. VII.

To draw a tangent to an hyperbola at a point on the curve.

First Method.—Join SP, S'P, and draw a line bisecting the angle SPS': this line is the tangent at P. (Prop. vi.)

Second Method.—Draw SZ at right angles to SP, meeting the corresponding directrix in Z. ZP is the tangent at P. (Prop. iii.)

Third Method.—On SP as diameter describe a circle which will touch the circle on AA' as diameter in some point Y. YP is the tangent at P. (Prop. iv.)

PROP. VIII.

To draw a pair of tangents to an hyperbola from an external point.

First Method.—Let O (fig. 34) be the point, and S, S' the foci. Join OS; with centre O, and radius OS, describe a circle; and with centre S' and radius equal to AA' describe another circle. It can be shown that these circles will always intersect in two points M, M'.

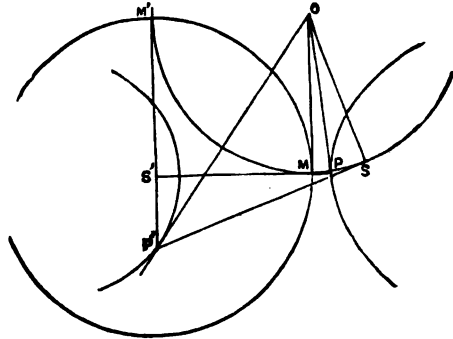

Fig. 34.

Join S'M, S'M' cutting the curve in P, P'. Then OP, OP' will be tangents to the curve. Join SP, SP'.

$$\text{Now } S'P - SP = AA' = S'M - S'P = MP,$$

therefore  
and

$$\begin{aligned} SP &= MP; \\ OS &= OM; \end{aligned}$$

therefore the two triangles OPS, OPM are equal in all respects, and the angle OPS = OPM.

Therefore OP is a tangent to the hyperbola at P (Prop. vi.).

Second Method.—Let O (fig. 35) be the point, and S, S' the foci.

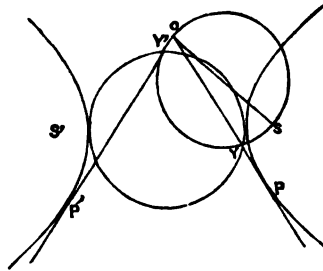

Fig. 35.

Join OS, and upon it as diameter describe a circle cutting the circle described on AA' as diameter (which it will always do) in Y, Y'.

Join OY, OY', and produce them if necessary to meet the curve in P, P'. They will be tangents to the curve at P, P'.

Because OYS is a semicircle, the angle OYS is a right angle, and therefore OY is a tangent to the hyperbola (Prop. iv.).

PROP. IX.

If OP, OP' be tangents to the same branch of an hyperbola at P, P' and S be a focus, the angles OSP, OSP' are equal; if OP, OP' be tangents to different branches, the angles OSP, OSP' are supplementary.

This proposition is proved in the same manner as Prop. ix. on the ellipse.

PROP. X.

If OP, OP' be two tangents to the hyperbola, and S, S' be the foci, the angles SOP, S'OP' are equal.

This proposition is proved exactly in the same way as Prop. x. on the ellipse.

PROP. XI.

If C be the middle point of AA', then  $CA^2 = CS \cdot CX$ .

$$\begin{aligned} SA' : A'X &= e : 1 = SA : AX \\ \therefore SA' - SA : SA &= A'X - AX : AX. \end{aligned}$$

Again  
or

$$\begin{aligned} \therefore AA' : XX' &= SA : AX = e : 1. \quad \dots (1) \\ SA' + SA : SA &= A'X + AX : AX. \\ SS' : SA &= AA' : AX. \\ \therefore SS' : AA' &= SA : AX = e : 1. \quad \dots (2) \end{aligned}$$

From (1) and (2)

$$\begin{aligned} AA' : XX' &= SS' : AA \\ CA : CX &= CS : CA \\ \therefore CA^2 &= CS \cdot CX. \quad \dots (3) \\ CS : CX &= CS^2 : CA^2 \\ &= CA^2 : CX^2. \quad \dots (4) \end{aligned}$$

Also

PROP. XII.

If PN be an ordinate of the hyperbola, then PN<sup>2</sup> always bears a constant ratio to AN . NA'.

It is proved exactly as in the case of the ellipse Prop. xii., that  
 $PN^2 : AN . NA' = CB^2 : CA^2$ .

PROP. XIII.

The ordinates of two hyperbolas which have the same transverse axis are in a constant ratio.

Let PP'N be the common ordinate of two hyperbolas, whose transverse axis is AA', and whose conjugate axes are CB, CB'.

Then  $PN^2 : AN . NA' = CB^2 : CA^2$

and  $P'N^2 : AN . NA' = CB'^2 : CA'^2$ .

Therefore  $PN^2 : CB^2 = AN . NA' : CA^2$   
 $= P'N^2 : CB'^2$

$\therefore PN : CB = P'N : CB'$

or

$PN : P'N = CB : CB'$ .

DEFINITION.

The diagonals of the rectangle formed by the tangents to a hyperbola and its conjugate at their vertices are called *asymptotes*.

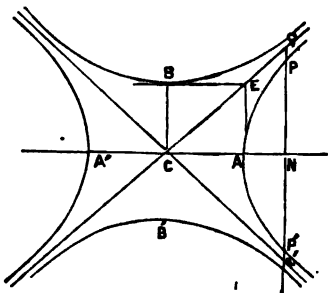

FIG. 36.

PROP. XIV.

If a straight line be drawn through any point Q on one of the asymptotes perpendicular to the transverse axis, meeting the hyperbola in P, P' and the other asymptote in Q' (fig. 36), then  $QP . QP' = BC^2$ .

From similar triangles QNC, EAC, we have

$$QN^2 : CN^2 = BC^2 : AC^2.$$

and from Prop. xii.

$$PN^2 : AN . NA' = BC^2 : AC^2.$$

$$\therefore QN^2 - PN^2 = CN^2 - AN . NA' = BC^2 : AC^2;$$

but

$$QN^2 - PN^2 = QP' . QP,$$

and

$$AN . NA' = CN^2 - CA^2;$$

$$\therefore QP . QP' : CA^2 = BC^2 : CA^2,$$

$$QP . QP' = BC^2.$$

It is easily seen that

$$QP = Q'P',$$

therefore

$$PQ . PQ' = BC^2.$$

Similarly it can be shown that if RQR' be drawn parallel to AA', to meet the hyperbola in R, R', then

$$QR . QR' = AC^2.$$

It is clear that the further the point Q moves away the greater the line PQ' becomes, and it can be made greater than any assignable quantity, however large; and since  $PQ . PQ' = BC^2$ , therefore the line PQ becomes smaller and smaller, and can be made less than any assignable quantity, however small. Hence the asymptote never actually reaches the curve, though the distance between them constantly decreases, and can be made smaller than any assignable quantity.

It can easily be shown that if the asymptote cuts a directrix in the point F, then

$$CF = CA.$$

As the asymptote may be considered as the tangent to the hyperbola at a point at an infinite distance, the foot of the perpendicular from the focus on the asymptote must lie on the circle whose diameter is AA' (Prop. iv.).

SE therefore must be perpendicular to the asymptote, as appears from other reasons (from Prop. iii., for example)

PROP. XV.

If QPP'Q' (fig. 37) be any chord cutting the asymptotes in Q, Q' and the curve in P, P', then  $QP = P'Q'$ , and  $QP . PQ' = CD^2$ , where CD is the semi-diameter in the conjugate hyperbola parallel to PP'.

Draw RPR', DWW' perpendicular to the transverse axis, meeting the asymptotes in R, R', and W, W'.

Then from similar triangles PRQ, DWC

$$PQ : PR = CD : DW$$

and from similar triangles PR'Q', DW'C

$$PQ' : PR' = DC : DW'$$

Therefore  $PQ . PQ' : PR . PR' = CD^2 : DW . DW'$ ;  
 but  $DW . DW' = BC^2 = PR . PR'$  (Prop. xiv.),  
 therefore  $PQ . PQ' = CD^2$   
 $= P'Q . P'Q'$ .

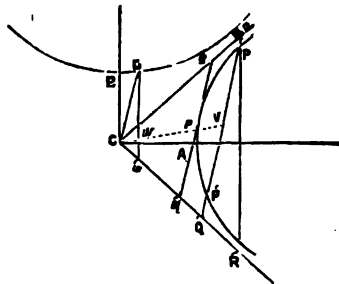

FIG. 37.

Now, if V be the middle point of QQ', then

$$PQ : PQ' = QV^2 - PV^2$$

and

$$P'Q' : P'Q' = QV^2 - P'V^2$$

Therefore

$$PV = P'V.$$

Thus V is the middle point of PP', as well as of QQ', or in other words,  $PQ = Q'P'$ .

It is clear that when the points PP' coincide, or we have the tangent parallel to PP', say  $qpq$ , then

$$qp = p'q' = CD,$$

and also that the line Cp will bisect all chords parallel to the tangent at p.

PV is called an *ordinate* to the diameter Cp.

DEFINITION.

A chord which is parallel to the tangent at P is said to be *conjugate* to CP.

If a diameter CD be drawn parallel to the tangent at P to meet the conjugate hyperbola in D, CP, CD are said to be *conjugate semi-diameters*.

It is clear from Prop. xv. that a diameter is *conjugate* to the chords which it bisects.

PROP. XVI.

If CD be conjugate to CP, then CP is conjugate to CD.

Let the tangent at P meet the asymptote in L, then PL is parallel to CD; it is also equal to CD (Prop. xv.); therefore DL is equal and parallel to CP (Euclid i. 33).

Therefore LD is the tangent to the conjugate hyperbola at D, and therefore CP is conjugate to CD.

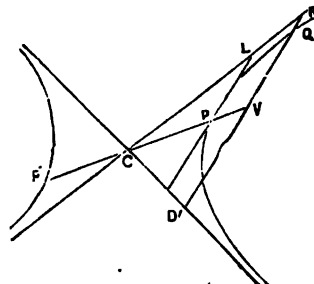

FIG. 38.

It is easily seen that PD is bisected by one asymptote, and parallel to the other asymptote.

PROP. XVII.

If P'CEV (fig. 38) be a diameter, and QV be an ordinate to CP then  $QV^2 : PV . P'V = CD^2 : CP^2$ .

Draw PL the tangent at P to meet an asymptote in L, and let QV produced meet the asymptotes in R, R'.



Then  $RV^2 - QV^2 = RQ \cdot QR' = PL^2$ .  
 Therefore  $QV^2 = RV^2 - PL^2$   
 $= \left(\frac{CV^2}{CP^2} - 1\right) PL^2$   
 $= \frac{CV^2 - CP^2}{CP^2} CD^2$   
 $= \frac{PV \cdot P'V}{CP^2} CD^2$ .

Therefore  $QV^2 : PV \cdot P'V = CD^2 : CP^2$ .

PROP. XVIII.

If POP' (fig. 39) be any chord, and ORCR' the diameter through O, then

$$PO \cdot OP' : RO \cdot OR' = CD^2 : CR^2,$$

where CD is the semi-diameter parallel to PP'.

Draw CQWV conjugate to PP', meeting the curve in Q, and the ordinate through R in W.

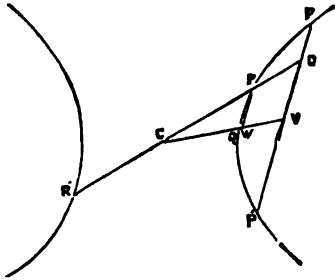

FIG. 39.

Then  $PO \cdot OP' = PV^2 - OV^2$   
 $= PV^2 - RW^2 = \frac{CV^2}{CW^2}$   
 Now  $PV^2 : CV^2 = CQ^2 : CD^2 = CQ^2 : CQ^2$   
 and  $RW^2 : CW^2 = CQ^2 : CD^2 = CQ^2 : CQ^2$   
 $\therefore PV^2 - RW^2 = \frac{CV^2}{CW^2} : CV^2 = CQ^2 : (CW^2 - CQ^2) = \frac{CV^2}{CW^2} : CD^2 = CQ^2$ .

or  $PO \cdot OP' : CQ^2 = \left(\frac{CV^2}{CW^2} - 1\right) = CD^2 : CQ^2$   
 $\therefore PO \cdot OP' : CD^2 = CV^2 - CW^2 : CW^2$   
 $= CO^2 - CR^2 : CR^2$   
 $= RO \cdot OR' : CR^2$ .

Therefore  $PO \cdot OP' : RO \cdot OR' = CD^2 : CR^2$ .

PROP. XIX.

If POP', pOp' be any two chords, and CD, Cd the semi-diameters parallel to them, then

$$PO \cdot OP' : pO \cdot Op' = CD^2 : Cd^2.$$

From the last proposition we have

$PO \cdot OP' : RO \cdot OR' = CD^2 : CR^2$ ,  
 $pO \cdot Op' : RO \cdot OR' = Cd^2 : CR^2$   
 Therefore  $PO \cdot OP' : CD^2 = RO \cdot OR' : CR^2$   
 $= pO \cdot Op' : Cd^2$   
 or  $PO \cdot OP' : pO \cdot Op' = CD^2 : Cd^2$ .

PROP. XX.

If from a point Q on one asymptote (fig. 40) or finates QPM, QDN be drawn to two conjugate hyperbolas in P, D, PD will be parallel to the other asymptote.

$QM^2 : QN^2 = QM^2 : CM^2 = BC^2 : AC^2$   
 and  $QM^2 - PM^2 : QN^2 - DN^2 = BC^2 : AC^2$ .  
 $\therefore PM^2 : DN^2 = BC^2 : AC^2 = QM^2 : QN^2$   
 or  $PM : DN = QM : QN$ .

Therefore DP is parallel to NM (Eucl. vi. 2), and NM is parallel to BA, and therefore to the other asymptote.

COROLLARY.—It follows therefore that OP, OD are conjugate (Prop. xvi.).

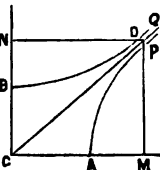

FIG. 40.

PROP. XXI.

If CP, CD be conjugate semi-diameters  $CP^2 - CD^2 = CA^2 - CB^2$ .

Let ordinates PM, DN (fig. 41) in the two hyperbolas be produced, they will meet in a point Q on the asymptote (Prop. XI, Cor.).

Then  $CP^2 - CD^2 = CM^2 + MP^2 - CN^2 - ND^2$   
 $= QN^2 + MP^2 - QM^2 - DN^2$   
 $= QN^2 - DN^2 - (QM^2 - PM^2)$   
 $= CA^2 - CB^2$  (Prop. xiv.).

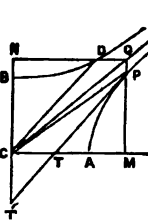

FIG. 41.

It follows that if the tangent at P meets the axes in T, T', then

For  $PT \cdot PT' = CD^2$ .  
 and  $PT : CD = PM : CN$   
 and  $PT' : CD = CM : DN$   
 $\therefore PT \cdot PT' : CD^2 = PM \cdot CM : CN \cdot DN$   
 $= PM \cdot QN : QM \cdot DN$   
 $= 1 : 1$   
 $\therefore PT \cdot PT' = CD^2$ .

PROP. XXII.

If CP, CD be conjugate semi-diameters, the area of the triangle CPQ is constant.

Produce QP (fig. 42) to meet the other asymptote in Q'; and join MON, PLD. They are parallel to CQ.

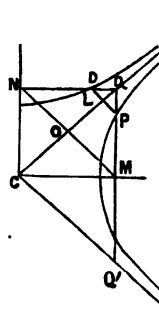

FIG. 42.

$\therefore QO : LO = QM : PM$  (Eucl. vi. 2.)  
 $QO^2 : LO^2 = QM^2 : PM^2$   
 $\therefore QO^2 - LO^2 : QO^2 = QM^2 - PM^2 : QM^2$   
 or  $QL \cdot LC : QO^2 = BC^2 : QM^2$   
 or  $4CL \cdot LQ : CQ^2 = BC^2 : QM^2$   
 $= CA^2 + CB^2 : CB^2$   
 $= CS^2 : CB^2$   
 $\therefore 4CL \cdot LQ = CS^2$ .

Now in the right angled triangle PQD, L is the middle point of the hypotenuse; therefore  $PL = LD = LQ$ .

$$\therefore 4CL \cdot LP = CS^2.$$

If PL' be drawn parallel to CL to meet the other asymptote,

$$4PL \cdot PL' = CS^2,$$

and the area of the quadrilateral CLPL' is constant.

It follows that, if the tangent at P meets the asymptotes in K, K', the area of the triangle CKK' is constant; also that the area of the quadrilateral formed by the tangents at the extremities of two conjugate diameters is constant.

PART IV.—THE CONE AND ITS SECTIONS.

DEFINITIONS.

If through the point V, without the plane of the circle ADB (fig. 43), a straight line AV be drawn, and produced indefinitely both ways, and if the point V remain fixed while the straight line AV is moved round the whole circumference of the circle, a superficies of two sheets, which is called a *cone*, will be generated by its motion.

The fixed point V is called the *vertex of the cone*.

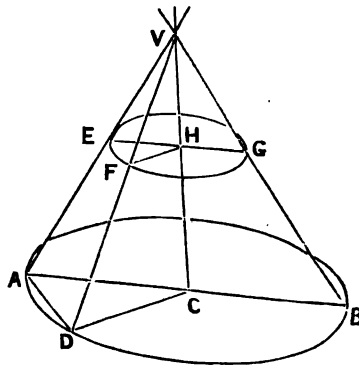

FIG. 43.

The circle ADB is called the *base of the cone*.

Any straight line drawn from the vertex to the circumference of the base is called a *side of the cone*.

A straight line VC drawn through the vertex of the cone, and the centre of the base, is called the *axis of the cone*.

If the axis of the cone be perpendicular to the base, it is called a *right cone*.

If the axis of the cone be not perpendicular to the base, it is called a *scalene cone*.

PROP. I.

If a cone be cut by a plane passing through the vertex, the section will be a triangle.

Let  $ADVB$  be a cone of which  $VC$  is the axis; let  $AD$  be the common section of the base of the cone and the cutting plane; join  $VA, VD$ . When the generating line comes to the points  $A$  and  $D$ , it is evident that it will coincide with the straight lines  $VA, VD$ ; they are therefore in the surface of the cone, and they are in the plane which passes through the points  $V, A, D$ , therefore the triangle  $VAD$  is the common section of the cone and the plane which passes through its vertex.

PROP. II.

If a cone be cut by a plane parallel to its base, the section will be a circle, the centre of which is in the axis.

Let  $EFG$  be the section made by a plane parallel to the base of the cone, and  $VAB, VCD$  two sections of the cone made by any two planes passing through the axis  $VC$ ; let  $EG, HF$  be the common sections of the plane  $EFG$  and the planes  $VAB, VCD$ . Because the planes  $EFG, ADB$  are parallel,  $HE, HF$  will be parallel to  $CA, CD$ , and

$$AC : EH = (VC : VH) : CD : HF;$$

but  $AC = CD$ , therefore  $EH = HF$ . For the same reason  $GH = HF$ ; therefore  $EFG$  is a circle of which  $H$  is the centre and  $EG$  the diameter.

PROP. III.

If a scalene cone  $ADVB$  (fig. 44) be cut through the axis by a plane perpendicular to the base, making the triangle  $VAB$ , and from any point  $H$  in the straight line  $AV$  a straight line  $HK$  be drawn in the plane of the triangle  $VAB$ , so that the angle  $VHK$  may be equal to the angle  $VBA$ , and the cone be cut by another plane passing through  $HK$  perpendicular to the plane of the triangle  $ABV$ , the common section  $HFKN$  of this plane and the cone will be a circle.

Take any point  $L$  in the straight line  $HK$ , and through  $L$  draw  $EG$  parallel to  $AB$ , and let  $EFGN$  be a section parallel to

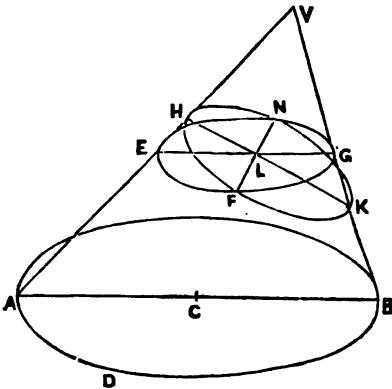

Fig. 44.

the base, passing through  $EG$ ; then the two planes  $HFKN, EFGN$  being perpendicular to the plane  $VAB$ , their common section  $FLN$  is perpendicular to  $ELG$ , and since  $EFGN$  is a circle (by last Prop.), and  $EG$  its diameter, the square of  $FL$  is equal to the rectangle contained by  $EL$  and  $LG$  (Eucl. iii. 85); but since the angle  $VHK$  is equal to  $VBA$  or  $VGE$ , the angles  $EHK, EGK$  are equal, therefore the points  $E, H, G, K$ , are in the circumference of a circle (Eucl. iii. 21), and  $HL \cdot LK = EL \cdot LG$  (Eucl. iii. 35) =  $FL^2$ , therefore the section  $HFKN$  is a circle of which  $HLK$  is a diameter (Eucl. iii. 35). This section is called a *Subcontrary Section*.

PROP. IV.

If a cone be cut by a plane which does not pass through the vertex, and which is neither parallel to the base nor to the plane of a subcontrary section, the common section of the plane and the surface of the cone will be an ellipse, a parabola, or an hyperbola, according as the plane passing through the vertex parallel to the cutting plane falls without the cone, touches it, or falls within it.

Let  $ADVB$  (figs. 45, 46, 47) be any cone, and let  $ONP$  be the common section of a plane passing through its vertex and the plane of the base, which will either fall without the base, or touch it, or fall within it.

Let  $FKM$  be a section of the cone parallel to  $VPO$ ; through  $C$  the centre of the base draw  $CN$  perpendicular to  $OP$ , meeting the circumference of the base in  $A$  and  $B$ ; let a plane pass through  $V, A$ , and  $B$ , meeting the plane  $ONP$  in the line  $NV$ , the surface of the cone in  $VA, VB$ , and the plane of the section  $FKM$  in  $LK$ ; then, because the planes  $ONP, MKF$  are parallel,  $EL$  will be parallel to  $VN$ , and will meet  $VB$  one side of the

cone in  $K$ ; it will either meet  $VA$  the other side in  $H$ , as in fig. 45, within the cone; or it will be parallel to  $VA$ , as in fig. 46; or it will meet  $VA$ , produced beyond the vertex, in  $H$ , as in fig. 47.

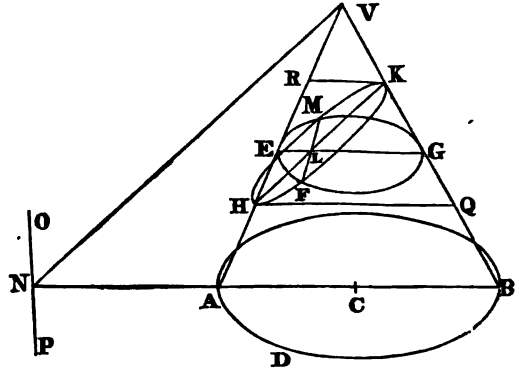

Fig. 45.

Let  $EFGM$  be a section of the cone parallel to the base, meeting the plane  $VAB$  in  $EG$ , and the plane  $FKM$  in  $FM$ , and let  $L$  be the intersection of  $EG$  and  $FM$ ; then  $EG$  will be parallel

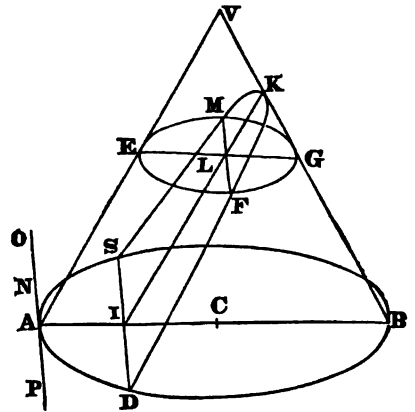

Fig. 46.

to  $NE$ , and  $FM$  will be parallel to  $PO$ , and therefore will make the same angle with  $LK$ , wherever the lines  $FM, LK$  cut each other; and since  $BN$  is perpendicular to  $PO$ ,  $EG$  is perpen-

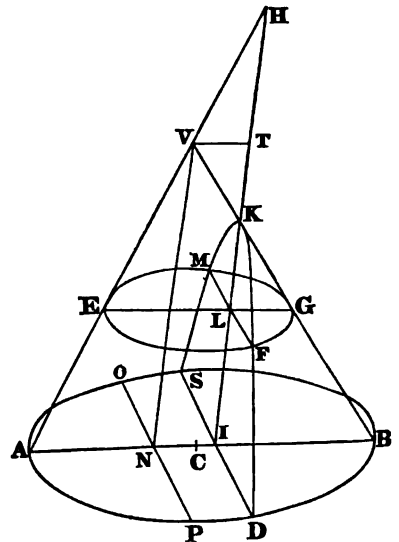

Fig. 47.

dicular to  $FM$ . Now the section  $EFGM$  is a circle of which  $EG$  is the diameter (Prop. ii.), therefore  $FM$  is bisected at  $L$ , and  $FL^2 = EL \cdot LG$ .

CASE 1. Let the line PNO be without the base of the cone. Through K and H (fig. 45) draw KR and HQ parallel to AB. The triangles KLG, KHQ are similar, as also HLE, HKR; therefore  
 $KL : LG = KH : HQ,$   
 and  
 $HL : LE = KH : KR;$

therefore  $KL \cdot HL : LG \cdot LE$  (or  $LF^2$ ) ::  $KH^2 : HQ \cdot KR$ .  
 Now the ratio of  $KH^2$  to  $HQ \cdot KR$  is the same wherever the sections HFKM, EFGM intersect each other; therefore  $KL \cdot HL$  has a constant ratio to  $LF^2$ , consequently (Prop. xii. on the ellipse) the section HFKM is an ellipse, of which HK is a diameter and MF an ordinate.

CASE 2. Next, suppose the line ONP to touch the circumference of the base in A. Let DIS (fig. 46) be the common section of the base and the plane FKM; the line DIS is evidently parallel to FLM, and perpendicular to AB, therefore  $DI^2 = AI \cdot IB$ , hence  
 $DI^2 : FL^2 = AI \cdot IB : EL \cdot LG.$

But since EG is parallel to AB, and IK parallel to AV, AI is equal to EL, and

$$IB : LG = KI : KL,$$

$$DI^2 : FL^2 = KI : KL.$$

therefore

Hence it follows from Prop. xi. on the parabola that the section DFKMS is a parabola, of which KLI is a diameter, and DIS, FLM ordinates to that diameter.

CASE 3. Lastly, let the line PNO fall within the base; draw VT (fig. 47) through the vertex parallel to EG. The triangles HVT, HEL are similar, as also the triangles KVT, KGL, therefore

$$HT : TV = HL : LE,$$

$$KT : TV = KL : LG;$$

and

$$\text{therefore } HT \cdot KT : TV^2 = HL \cdot LK : LE \cdot LG \text{ or } LF^2.$$

Hence it appears that  $HL \cdot LK$  has to  $LF^2$  a constant ratio, therefore the section DFKMS is an hyperbola, of which KH is a transverse diameter and FM an ordinate to that diameter (Prop. xii. on the hyperbola).

From the four preceding propositions it appears that the only lines which can be formed by the common section of a plane and a cone are these five:—1. Two straight lines intersecting each other in the vertex of the cone; 2. A circle; 3. An ellipse; 4. A parabola; 5. An hyperbola. The first two of these, however, viz., the pair of straight lines and circle, may be referred to the hyperbola and the ellipse; for if the axes of an hyperbola be supposed to retain a constant ratio to each other, and, at the same time, to diminish continually, till at last the vertices coincide, the hyperbola will evidently become two straight lines intersecting each other in a point; and a circle may be considered as an ellipse, whose axes are equal, or whose foci coincide; so that the only three sections which require to be separately considered are the *ellipses*, the *parabola*, and the *hyperbola*.

PART V.—OF CURVATURE.

DEFINITIONS.

If a circle touch a curve at any point P and pass through another point Q on the curve, then if Q move up to P the limiting position of the circle, when Q coincides with P, is called the *circle of curvature* of the curve at P.

The centre of this circle is called the *centre of curvature* of the curve at the point P.

PROPOSITION I.

The common chords of any conic and any intersecting circle are equally inclined to the axis or axes of the conic.

Let P, Q, R, S be the points of intersection of a conic and a circle.

Let PR, QS intersect in O.

Then because P, Q, R, S lie on a circle

$$PO \cdot OR = QO \cdot OS \text{ (Eucl. iii. 35);}$$

and because POR, QOS are two chords in a conic, the ratio

$$PO \cdot OR : QO \cdot OS$$

(in the parabola) = parameter of PR : parameter of QS.  
 (in the ellipse and hyperbola) = square on the semi-diameter parallel to PR : square on the semi-diameter parallel to QS.

Now parameters of chords in the parabola, and semi-diameters parallel to chords in the ellipse and hyperbola, are equal only when the chords are equally inclined to the axes.

The same proof applies to the pairs of chords PQ, RS and PS, QR.

COROLLARY 1.—If a circle touch a conic at P and cut it in Q and R, the chords PQ, PR are equally inclined to the axis, and the chord QR and the tangent at P are also equally inclined to the axis. This is seen by considering the case of S moving up to and coinciding with P.

COROLLARY 2.—If the circle of curvature of a conic at a point P intersect the conic again in Q, then the chord PQ and the tangent to the conic at P are equally inclined to the axis of the conic.

This is seen by considering the case of R and S, both moving up to and coinciding with P.

PROP. II.

To draw the circle of curvature at any point of a conic.

Draw the tangent at P, of which methods have been given above. Draw PQ equally inclined to the axis, cutting the conic again in Q. Draw PO at right angles to the tangent, and make the angle PQO equal to the angle QPO.

This gives O the centre of the circle of curvature.

PROP. III.

The focal chord of curvature in the parabola is equal to 4SP.

Let the common chord of the circle of curvature and the parabola be PQ, cutting the axis at F (fig. 48).

Draw the double ordinate PNP', cutting the axis at N; the tangents at P, P' will meet the axis in the same point T. Then angle PFT

$$= \text{angle PTF} = \text{angle P'TF}.$$

$$\therefore TP', PQ \text{ are parallel.}$$

$$\therefore PQ = 2PV = 4PF = 4PT.$$

Now let PS produced cut the circle again in U; join UQ.

$$\text{Then angle UQP} = \text{angle TPU}$$

(Eucl. iii. 32) = angle PTS

$$= \text{angle PFT};$$

$$UQ \text{ is parallel to } SF$$

$$\therefore PU : PS = PQ : PF = 4 : 1,$$

$$PU = 4SP.$$

therefore

or

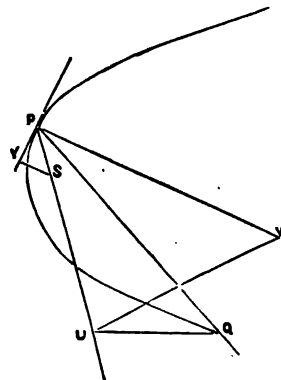

FIG. 48.

PROP. IV.

To find an expression for the chord of curvature at any point of a parabola drawn in any direction.

Using the same construction as in Prop. iii., let PW (fig. 49) be the chord required.

Draw SY parallel to the given direction to meet the tangent at P in Y.

$$\text{Then angle PWU} = \text{angle SPY}$$

$$\text{(Eucl. iii. 32).}$$

$$\text{and angle UPW} = \text{angle YSP.}$$

Therefore the triangles UWP, YSP are similar, and

$$PW : PU = SP : SY$$

$$\text{or } PW \cdot SY = PU \cdot SP = 4SP^2.$$

$$\therefore PW = \frac{4SP^2}{SY}$$

$$\text{COROLLARY.—The diam-}$$

eter of curvature =  $\frac{4SP^2}{SY}$  where SY is the perpendicular on the tangent

PROP. V.

If the chord of intersection PQ (fig. 50) of an ellipse or hyperbola with the circle of curvature at P meet CD the semi-diameter conjugate to CP in K, then

$$PQ \cdot PK = 2CD^2.$$

Draw the double ordinate PNP'; the tangents at P, P' meet in the axis at T, and the tangent at P' is parallel to PQ, and therefore CP' bisects PQ in V.

Let PQ meet the axis in F, F', then

$$PV : PF' = P'V : P'C = TF : TC$$

$$= PF : PK$$

$$\text{since } CD \text{ is parallel to } PT.$$

$$\text{Therefore } PV \cdot PK = PF \cdot PF'$$

$$= PT \cdot PT' = CD^2$$

(Ellipse, Prop. xv. and Hyperbola, Prop. xxi.)

and

$$\therefore PQ \cdot PK = 2CD^2.$$

PROP. VI.

If the chord of curvature PQ' (fig. 51) of an ellipse or hyperbola in any direction meet CD in K', then

$$PQ' \cdot PK' = 2CD^2.$$

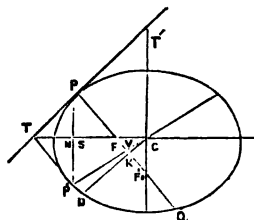

FIG. 50.

The angle  $Q'QP$  = angle  $TPK'$  = angle  $PKE'$ ;  
 therefore the triangles  $PKK'$ ,  $PQ'Q$  are similar,  
 and  $PQ' : PQ = PK : PK'$   
 $\therefore PQ' \cdot PK' = PQ \cdot PK = 2CD^2$ .

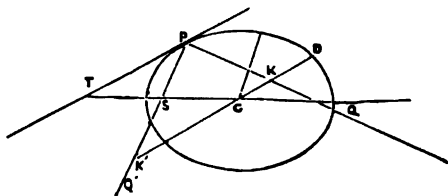

FIG. 51.

If  $PQ''$  be the chord of curvature through the focus, then

$$PK'' = CA$$

$$PQ'' \cdot CA = 2CD^2.$$

and

If  $PQ'''$  be the chord of curvature through the centre

$$PK''' = CP$$

$$PQ''' \cdot CP = 2CD^2.$$

and

If  $PQ''''$  be the diameter of curvature

$$PK'''' = CD = CA \cdot CB$$

and

$$PQ'''' \cdot PK'''' = 2CD^2.$$

$$\therefore PQ'''' \cdot CA \cdot CB = 2CD^2.$$

For other powerful methods of investigating the properties of the conic sections which have been much developed of late reference is made to GEOMETRY and other headings. (M. M. T.)

CONINGTON, JOHN (1825–1869), the first occupant of the "Corpus" chair of Latin literature in the University of Oxford, was born on the 10th August, 1825, at Boston in Lincolnshire, his father, the Rev. Richard Conington, being incumbent of the chapel of ease in that town. He was a remarkably precocious child, knowing his letters when fourteen months old, and being able to read well at three and a half. After two years' training at Beverley grammar school, he was sent in 1838 to Rugby, where his "remarkable memory and very good scholarship" drew special commendation from Dr. Arnold. In 1843 he went to Oxford, matriculating at University College at midsummer, but entering upon residence in the October term at Magdalen, where in the interval he had been nominated to a demyship. His university distinctions were numerous. He was Ireland and Hertford scholar in 1844; in March, 1846, he was elected to a scholarship at University College; in December of the same year he obtained a first-class in classics, graduating B.A. soon afterwards; and in February, 1848, he became a fellow of University College. Finding no career open to him at the university, and having obtained the Eldon scholarship in 1849, he proceeded to London in fulfilment of its conditions to keep his terms at Lincoln's Inn. The profession of law, however, proved eminently distasteful to him, and after six months he resigned the scholarship, and returned to more congenial work at Oxford. During his brief residence in London he formed a connection with the *Morning Chronicle*, which was maintained for some time. He showed no special aptitude for journalism, but a series of articles on University Reform (1849–50) are noteworthy as the first public expression of his views on a subject that always deeply interested him. In 1854 his appointment to the chair of Latin literature, newly founded by Corpus Christi College, gave him a position which exactly suited him. He had published, in 1848, an edition of the *Agamemnon* of Æschylus with notes and a translation into English verse, and he had devoted much study to the other plays of Æschylus, of which the only published result is the very valuable edition of the *Choephoroi* (1857). From the time that he became professor, however, he confined himself with characteristic conscientiousness almost exclusively to Latin literature. The only important exception was the translation of the last twelve books of the *Iliad* in the Spenserian stanza in completion of the work of Worsley, and this was undertaken as a labor of love, in fulfilment of a promise made to his dying friend. In 1852 he commenced, in conjunction with Mr. Goldwin Smith, a complete edition of Virgil with a commentary, of which the first volume appeared in 1858, the second in 1864, and the third soon after his death. Mr. Goldwin Smith was compelled to withdraw from the work at an early stage, and in the last volume his place was taken by Mr. Nettleship. In

1863 appeared Conington's translation of the *Odes* and *Carmen Seculare* of Horace. This was followed in 1866 by the work by which its author is best known to the general public, the translation of the *Æneid* of Virgil into the octosyllabic metre of Scott, which deservedly takes almost the highest rank in its own department. The version of Dryden is the work of a stronger artist; but for fidelity of rendering, for happy use of the principle of compensation so as to preserve the general effect of the original, and for beauty as an independent poem, Conington's version is unrivalled. That the measure chosen does not reproduce the majestic sweep of the Virgilian verse is a fault in the conception and not in the execution of the task, and Conington maintained that his choice had advantages which more than counterbalanced this defect. His last effort in his favorite task of translation was his rendering of the *Satires*, *Epistles*, and *Art of Poetry* of Horace, which was published in 1869. He died at Boston on the 23d October, 1869. His edition of Persius, with a commentary and a spirited prose translation, was published posthumously in 1872. In the same year appeared his *Miscellaneous Writings*, edited by Symonds, with a memoir by Professor H. J. S. Smith.

CONJEVERAM, a town of South-Eastern India, in the district of Chingleput, situated in the valley of the Wegawati, about 45 miles south-west of Madras, on the route to Arcot. It consists of wide, irregular streets of mud-built houses, with cocoa-nut trees planted between them. The town is celebrated for its two pagodas, one dedicated to Kamachuma, and the larger one to Siva. The principal inhabitants are Brahmans. Handkerchiefs and cloths are manufactured.

CONNAUGHT, one of the four provinces of Ireland, occupying the western quarter of the island. It comprises the counties of Galway, Mayo, Sligo, Leitrim, and Roscommon, and contains an area of 6862 square miles, or 4,392,085 acres, of which 2,889,000 are under cultivation. The annual value of property, which, however, is based on a lower scale of prices than now obtains, is estimated at £4,188,631; and the land is divided among 5264 proprietors. An average holding in this province amounts in extent to 795 acres, while in all Ireland it amounts to only 293 acres; and the average value is 6s. 9d. per acre, while that of all Ireland amounts to 18s. 2d. The western portion is hilly and occasionally mountainous, while the eastern part is generally level. It is well watered, and has on the greater portion of its eastern boundary the River Shannon. The River Moy is navigable from Killala to Ballina; the extensive lakes Conn, Corrib, and Maak, are navigable; and the sea coast affords many fine bays and harbors. The climate is moist and temperate. Agriculture is the main support of the population, but little progress has been made in its pursuit. The population may be considered as almost purely Celtic, and more than a third of the people speak the Irish language—a larger proportion than in the other provinces. The number of inhabitants in the province at and since the census of 1841 has been as follows:—

	Inhabitants.	Catholics.	Protestants.
1841.....	1,418,859	...	...
1851.....	1,010,031	...	...
1861.....	918,135	866,023	47,112
1871.....	845,075	805,849	41,226

In early times Connaught comprised, beyond its present limits, the territory of Thomond, forming the present county of Clare, and North Breifne, the present county of Cavan. When Sir Henry Sydney, in the 16th century, divided the province into counties, he adopted the ancient boundaries, excluding North Breifne; but in 1602 the county of Clare was restored to Munster, and Connaught now comprises the counties mentioned above.

CONNECTICUT (Indian, *Quonektaut*, i.e., Long River), one of the six New England, and one of the thirteen original, States of the American Union, lies between 41° and 42° 3' N. lat., and 71° 55' and 73° 50' W. long.

*Physical Description.*—It is bounded N. by Massachusetts about 88 miles; E. by Rhode Island, 45 miles; S. by Long Island Sound, 100 miles; W. by New York about 68 miles (in a direct line). The S. W. corner projects along the Sound under New York for about 13 miles. The area is 4750 square miles, or one-tenth of that of New York. The State lies on the S. slope of the hilly regions of New England, with a general surface much diversified; there is, however, no land above 1000 feet in elevation. Besides

the Connecticut, two other large rivers flow from the N. into the Sound—the Housatonic and the Thames. The Connecticut is the largest river in New England, rising on the N. border of New Hampshire, 1600 feet above the sea, flowing S. S. W., separating Vermont and New Hampshire, crossing the W. part of Massachusetts, and central part of Connecticut, flowing S. S. E. below Middletown, and falling into the Sound at Saybrook. Its length is more than 400 miles, with a width in Connecticut varying from 500 to 1000 feet. It is navigable to Middletown (30 miles) for vessels drawing 10 feet, and to Hartford (60 miles) for those drawing 8 feet. Its principal tributary in Connecticut is the Tunxis, or Farmington, which flows S. E. from the slopes of the Green Mountains in Massachusetts, then abruptly N., and, breaking through the trap range, S. E. again to the Connecticut River at Windsor, instead of taking its seemingly natural course to New Haven, whither a part of its waters were formerly carried by the Farmington Canal. The E. part of the State is drained by the Thames, which is formed by the Yantic and Shetucket,—the Quinnebaug

slate flagging from Bolton and Haddam is abundant in supply, and in great demand. Granite, gneiss, hydraulic lime, tiling slate, clay (fire, potters', and porcelain), and sulphate of barytes are found in great quantities. There were twenty extensive quarries and mines in the State in 1870. There are over 100 miles of deeply indented coast on the Sound (which measures 140 miles by 24 miles), affording excellent harbors. The chief of these are Stonington, New London, Saybrook, New Haven, Bridgeport, and Fairfield. The harbor at New London is one of the best in the country, capacious, and never frozen over. The climate of the State, while very changeable, is very healthful,—the mortality being below the average of the other States. There is scarcely any spring season, but summer opens abruptly about May 3, and the cold weather begins in November. The winters, with their keen N.W. winds, are severe, but the serenity of the sky and dryness of the air make some compensation. The mean temperature for the year is 48° Fahr. Consumption is the most fatal disease, causing 16 per cent. of all the deaths. The vegetation is rich and varied. The most abundant trees are chestnut, walnut, birch, oak, elm, maple, beech, and ash. The forests have been recklessly cut away, and only patches of woodland remain; but the people are waking up to the importance of tree-planting. As for zoology, songbirds of all sorts are plentiful, and the grouse and woodcock are increasing under the game laws, after having been nearly killed out. The Sound abounds in the best qualities of fish and shell-fish, while the freshwater varieties of the former are found in great quantities in the rivers and ponds. Aside from these there are few animals of importance save the domestic ones.



Sketch Map of Connecticut.

*Population. Divisions.*—The State is divided into 8 counties:—Hartford, New Haven, New London, Fairfield (all incorporated in 1666), Windham (1728), Litchfield (1751), Middlesex, and Tolland (1785), New London, Middlesex, New Haven, and Fairfield occupy the lower half of the State, bordering on the Sound; the others occupy the other half, adjoining Massachusetts. The number of towns in 1876 was 187; and there were ten cities:—Hartford, the capital (population in 1870, 37,180), New Haven (50,840), Bridgeport (18,969), Norwich (16,653), Waterbury (10,826), Middletown (6923), Meriden (10,521), New London (9576), New Britain (9480), and South Norwalk. There were also 17 boroughs largely engaged in industry, of which the chief are Birmingham, Danbury, Danielsonville, Fairfield, Stamford, Stonington, Wallimantic, and Winsted. The population of the State in 1679 was 12,535; in 1774 it had risen to 197,856; and from 1790 it was as follows (the last column showing its place among the other States as regards population):

	White.	Free Colored.	Slave.	Total.	Rank.
1790	232,374	2808	2764	237,946	8
1800	244,721	5330	951	251,002	8
1810	255,179	6453	310	261,942	9
1820	267,181	7870	97	275,148	14
1830	289,603	8047	25	297,675	16
1840	301,856	8105	17	309,978	20
1850	363,099	7693	none	370,792	21
1860	451,504	8627	"	460,131	24
1870	527,549	9668	"	537,217	25

joining the latter about two miles above. It is navigable to Norwich for the Sound steamers and West India trading vessels. In the W. part of the State is the Housatonic, with its main branch—the Naugatuck—which joins it at Derby. To this place it is navigable for small vessels. Besides these large streams there are very many smaller ones, affording, in their rapid descent from the hills, an immense amount of water power. Geologically the State is chiefly Eozoic, excepting the Triassic Sandstone and post-Tertiary terraces of the Connecticut River valley. There are several well-defined ranges of hills. Of these the Housatonic Hills are the most westerly, and extend along that river to the coast. The Green Mountain range, running S. from Vermont, terminates near New Haven. The Blue Hills of Southington—the highest in the State—are a part of the Mount Tom range of Massachusetts, and lie between the Green Mountain range and the Connecticut River. On the E. side of the river is a fourth range which the river crosses at Chatham. While the hills run N. and S., it is noticeable that the three main rivers bend (and on about the same parallel) to the S.E. The ridges and dikes of trap are exceedingly numerous through the centre of the State, having been forced up through the red sandstone which is found underlying and on the borders of the trap. These ridges have abrupt columnar W. fronts and gentle E. slopes. The mineral wealth of the State is considerable. Copper is found in the Simsbury mines at Granby, and at Bristol; but these mines have lost their former importance since the working of the abundant and purer ores of Lake Superior. Iron ore is found in great quantities in Salisbury, Kent, Sharon, Cornwall, and Canaan, and has been worked for 125 years. Limestone and marble of the very best quality are found at Canaan, Washington, and Milford. At Portland and Cromwell, on both sides of the Connecticut River, are the well-known immense quarries of freestone largely in demand for building. The excellent

In 1870 there were about 7000 more females than males. About one-fifth of the population were foreign born, chiefly Irish, German, English, French, Canadian, and Scotch. It is the third State in the density of its population (113.15 to the square mile), Massachusetts (186) and Rhode Island (208) exceeding it, while New York follows next (87). In 1875 the births were 14,323 (141 illegitimate); marriages, 4385 (below the average for the last 11 years); deaths, 9833 (25 per cent. from diseases of the respiratory organs); divorces, 476 (one for every 9.21 marriages solemnized; the average for 12 years is 455). The laws regarding divorce are very lax.

*Industry and Finances.*—Of the total population over ten years of age in 1870 (425,896), there were engaged in all occupations, 193,421; chiefly classed as—in agriculture, 43,653; in professional and personal service, 88,704; in trade, 24,720; and in manufactures, 86,344. There is very

little soil that can be called good, except in the river valleys, and agriculture is as backward as in other parts of New England. The hills through the State furnish excellent pasturage and cheap fuel. The chief cultivated fruits are apples, pears, grapes, and the numerous kinds of berries. The principal crops are hay, oats, rye, corn, potatoes, and tobacco; and in the Connecticut River valley (extending, in this State, 30 miles N. of Middletown, and 20 miles wide) farming is very productive. The tobacco raised in the valley is said to be superior to any other. In the uplands dairy products and cattle raising are the chief resources of the farmer. There were in 1870, 25,508 farms, having 1,646,752 acres of improved land, and 717,664 acres unimproved, of which 577,333 were woodland. The value of these farms was \$124,241,382. Though the number of farms has increased since 1850 and 1860, yet the acreage devoted to them has decreased, as has also the cultivated farm land in proportion to the uncultivated. The farms are passing into the hands of the Irish and Germans, who do their own work and live with few comforts. Pisciculture is receiving much attention, commissioners having been appointed in 1866, who have well stocked the ponds and rivers. Black-bass, trout, and shad have been very successfully cultivated, and it is hoped as much can be done with salmon. Notwithstanding the extensive sea coast and fine harbors, the foreign commerce is not heavy,—the coast trade and fisheries being more important. There are in the State five custom districts, of which the ports of entry are Fairfield, Middletown, New Haven, New London, and Stonington. The imports from foreign countries and domestic exports for the year ending June 30, 1875, were as follows:—

Ports.	Imports.	Exports.
Fairfield .....	\$6617	\$28,927
Middletown .....	619	none.
New Haven.....	1,174,921	2,925,631
New London .....	274,165	118,605
Stonington .....	858	none.
<b>Total .....</b>	<b>\$1,457,180</b>	<b>\$3,073,163</b>

The chief articles of export were grain, fire-arms, provisions, and manufactures of wood. Of the total number of enrolled, registered, and licensed vessels (820), 718 were sailing vessels, with a tonnage of 53,329, and 78 were steam vessels, with a tonnage of 26,550. The fisheries are carried on from New London and Stonington. In 1875, there were 173 vessels engaged in the cod and mackerel fisheries, with a tonnage of 3756; and in the whale fishery 14, with a tonnage of 2050—a great reduction on the decade from 1850 to 1860. Engaged in coastwise trade and fisheries, there entered 2257 vessels and cleared 1678. In foreign trade there entered 161 and cleared 102. In 1870, 1001 persons were engaged in fisheries, and the annual product was \$769,799. Ship-building is a considerable industry. In 1875 34 vessels were built of 5915 tons. The great industry of the State is in manufactures. These are

exceedingly numerous and very productive, and most of them such as require ingenuity and intelligence on the part of the workmen. The chief industries and some of the statistics in 1870 are noted in the preceding table.

It ranks first among the States in the production of cloth, India-rubber goods, and hardware, and (small as it is) eight in the total value of all manufactured products. It must be remembered, however, in connection with the above statistics that the ninth United States census of 1870 is very inaccurate in relation to manufactures, the superintendent estimating it only about one-quarter of the capital invested is reported, and that there are other great errors in the way of under-estimate. In 1875 Connecticut had 1 mile of railway to 5.16 square miles of territory, and to 585 inhabitants. (Massachusetts had 1 mile to 4 square miles and 909 inhabitants; England 1 mile to 5.02 square miles and 1954 inhabitants.) There were 23 railroad companies, with 1184 miles of single track. The cost of these was \$75,831,210; receipts for the year, \$12,020,194 (50 per cent. for passengers); net earnings, \$2,816,004, being 3.71 per cent. the cost of the roads. Nine roads, costing nearly 8 millions have no net income. The capital stock of all the companies was \$59,282,784 (paid in), and debt, \$17,077,739. The amount paid in dividends (only eight companies make any) was 4.3 per cent. on the entire capital of all the roads, but 9.24 on the capital of the dividend-paying ones. There is an elaborate system of State inspection of the roads and their accounts. There is a State tax of one per cent. on the market value of stock at bonds after deducting cash on hand. The principal lines of those running N. and S., connecting the shore with the valleys of the interior, and forming highways between the important cities of New England and New York City. Connected with these are important steamboat lines (passenger and freight) from Stonington, New London, and New Haven to New York. The wagon roadways all over the State are kept in very good condition, except in the poorer hill towns. There are about 13,000 miles of them, costing annually about \$650,000. The banking interest of the State is commensurate with its large business, and shows a steadily increasing prosperity. At January 1, 1876, there were 79 national banks in the State, with capital of \$25,687,820; 4 State banks, with a capital of \$1,450,000, and assets \$3,917,953; 12 trust companies, with capital of \$2,450,000, and assets \$6,183,643. These all do heavy discounting and lending business with their capital at deposits, and pay dividends of 8 to 12 per cent. on their stock. The savings banks numbered 87, with a deposit of \$76,489,312 and 208,030 depositors. The average income (during 1875) was 6.62 per cent., nearly all of which is paid to depositors, there being no capital stock. The management is very strictly controlled by law, and about three-quarters of the assets are lent on real estate in the State. The whole number of fire and marine insurance companies doing business in the State in 1875 was 130, of which 32 were Connecticut companies. The assets of these last were \$17,345,790, of which over 16 millions were held by 10 companies (mostly in Hartford). The premiums received by all the companies were \$1,949,867, and the corresponding losses \$1,248,989; total risks written in the State \$165,660,801. The premiums received by the Connecticut companies from their entire business were \$9,195,617, and corresponding losses \$5,203,416. The life and accident companies doing business numbered 27, of which 11 were Connecticut companies; the assets of the last were \$98,964,945. There were 2740 life policies issued in Connecticut in 1875, insuring \$5,066,438. The life premiums paid amounted to \$1,927,666. The policies in force in the State numbered 25,359, insuring \$51,063,720. The Connecticut companies (all of Hartford) issued 26,104 policies, insuring \$48,822,881 in 1875 (a large reduction on previous years), and paid losses of \$6,463,473. The State debt in 1860 was only \$50,000, which was borrowed for the school fund. From July 1, 1861, to October 1, 1866, five issues of bonds were made, amounting to \$10,000,000, drawing 6 per cent. interest. This debt has been steadily reduced, and on April 1, 1876, was \$5,014,500, or deducting cash in the treasury, only \$4,302,775. The revenue of the State for the year ending March 31, 1876, was \$2,117,719. This amount was chiefly derived from the tax of 1 mill on the grand list of the towns (\$437,473), from savings banks (\$462,664), mutual insurance companies (\$398,266), and railroads (\$302,758). In 1860 the assessed value of all property in the State was \$341,256,976, and the true value \$444,274,114. In 1870 the assessed value of real estate was \$204,110,500, and of personal estate \$221,322,728; total, \$425,433,228. The true value was \$774,631,524. In 1860 the total taxation, not national, was \$1,015,039; in 1870, \$6,064,843. The total indebtedness of towns and cities in the State on June 1, 1874, was \$13,995,096, more than one-third of which was incurred in aid of railroads.

*Social Statistics.*—A large number of public and charitable institutions are maintained wholly or in part by the State, and for them it spent \$135,463 during the year ending March 31, 1876. Among them are the following. The American Asylum for the Deaf and Dumb, at Hartford, was incorporated in 1816, being the oldest institution of the kind in the United States.

	Estab-lish-ments.	Steam engines Horse-power.	Water-wheels Horse-power.	Hands.	Capital.	Annual Product.
Cotton goods (of all sorts).....	111	860	10,840	12,066	\$ 12,710,700	\$ 14,026,334
Woolen goods.....	103	2,258	6,110	7,285	12,490,400	17,365,148
Hardware.....	145	2,640	1,773	7,246	6,863,895	12,111,034
Iron work (all sorts).....	124	2,721	1,480	3,486	5,320,650	7,562,725
Machinery (all sorts).....	106	1,424	728	2,770	4,842,641	5,010,379
Paper (all sorts).....	66	567	5,007	1,497	2,988,046	4,874,291
Sewing-machines and fixtures.....	9	815	30	2,525	2,492,000	3,949,000
Plated ware.....	32	685	499	2,107	2,337,500	4,066,306
Carriages and wagons .....	205	185	401	2,341	2,292,810	4,164,480
India-rubber and elastic goods.....	13	1,183	981	1,946	2,345,000	4,239,329
Silk goods.....	23	401	300	1,703	1,414,130	3,814,845
Firearms.....	8	654	224	1,607	1,793,770	2,222,873
Cutlery and edge tools.....	41	376	1,046	1,788	1,306,550	2,099,895
Hats and caps.....	33	584	56	2,464	1,153,300	3,740,371
Clocks, also materials and cases	28	461	430	1,471	1,006,650	7,153
Boots and shoes.....	281	19	30	2,417	585,800	9,546
Bleaching and dyeing .....	18	13	258	188	150,100	9,743
<b>Total (the above and all others) }</b>	<b>5,128</b>	<b>25,979</b>	<b>54,895</b>	<b>89,528</b>	<b>95,281,278</b>	<b>161,065,474</b>







In all, 2056 persons have received instruction, with an average attendance in 1875 of 218. The funds of the institution amount to \$338,925. The annual State grant is \$11,000. The charge per pupil is \$175 a year. There is no asylum for the blind, but an annual grant of \$6000 is made for the care of the indigent blind at the Perkins Institute at Boston. There is a general hospital at New Haven chartered in 1827, with a training school for nurses attached; funds, \$20,000; annual grant, \$2000; patients in 1875, 436. The Hartford Hospital was opened August 1, 1860; funds, \$153,500, but considerably in debt; annual grant, \$2000; patients in 1875, 707. The Connecticut Hospital for the Insane, at Middletown, was opened in 1868; cost, \$640,043; it accommodates 450 with attendants and physicians, and is always crowded. To April 1, 1876, 1272 had been admitted. One half the board of paupers is paid by the State. Revenue in 1875, \$124,305, of which the State paid \$62,004. The Retreat for the Insane at Hartford was opened in 1824, and has treated 5786 patients. Though receiving large State and private aid, it is intended for patients who can pay for comfortable accommodation. It had in 1875 about 159 inmates. The Reform School at West Meriden was opened in 1854; cost, \$115,000, with a farm of 195 acres. The expense to the State in 1875 was \$30,368. Boys from ten to sixteen years old may be sent to it for crime, by the several courts, for not less than 9 months, and during minority. The inmates are required to labor 6½ hours a day, and attend school 4½ hours. The Industrial School for Girls at Middletown was opened in 1870. Its property has cost \$122,363, mostly given by individuals. The expense to the State in 1875 was \$16,223, and the inmates numbered 53. Girls from eight to sixteen may be committed to it for vagrancy, and are taught housekeeping, sewing, box-making, and farm and garden work. The School for Imbeciles at Lakeville cost \$10,000, appropriated by the legislature. In 1875 its income was \$14,165, with an average of 95 inmates. The State prison at Wethersfield, erected in 1827, is inadequate to the needs of the State, having, in March, 1876, 40 more prisoners than cells, viz., 252 prisoners. Its income in 1875 was \$25,539, and payments \$28,414,—the deficit being due to the recent decrease in the demand for convict labor. The punishments are solitary confinement, fetters, and shackles. The warden may deduct five days from the term of imprisonment for good behavior. Schools were begun in New Haven in 1640. The provision and regulation of schools rested with the towns till 1712; with towns and parishes together till 1798; with parishes alone till 1856, when the towns were restored to their original place in the system. Though school districts existed in 1725, and were legalized in 1766, they were not fully endowed corporate bodies till 1839. Schools have been maintained in three ways,—by taxes, by tuition-fees or rate-bills, and by the income of invested funds. Taxes were a source of income from the beginning to 1821, and were restored in 1854. Rate-bills were not discontinued till 1868. Local school funds were begun towards the close of the 17th century, and increased by sales of land in 1733, and by excise on liquors, tea, &c., authorized by acts of May, 1766, and October, 1774. The State school fund was begun in 1795, it being the money procured by the sale of lands granted by Charles II. in 1662, and described as "from Narragansett Bay on the east to the South Sea on the west." This was, in fact, a strip of land 70 miles wide, and running one-eighth of the circumference of the globe. Subsequently, this being found to interfere with other colonial grants, all this territory was given up, save portions in New York and Ohio. The land was sold for \$1,200,000; the fund, however, has increased, and at September 1, 1874, was \$2,044,266; the dividend per child has varied from \$1.50 to \$1 per year, decreasing with the increase of population; the fund is almost wholly invested in real estate mortgages at 7 per cent. Another fund, the entire income of which since 1855 has been devoted to schools, is the Town Deposit Fund. The 24th Congress of 1835-6 voted to deposit the surplus revenue of the Union, then on hand, with the different States in proportion to their national representation. Connecticut received \$764,670, which was divided among the towns according to their population in 1830; the present income from this is about \$46,000 a year. (While Connecticut has preserved this fund almost intact, in other States it has been squandered or lost.) At present, aside from the income of these funds, the maintenance of the schools is provided for by these taxes:—the town tax, which must be sufficient to maintain 30 weeks of school in the larger, and 24 in the smaller districts; the district tax to provide for buildings and repairs, or any deficit; and the State appropriation of \$1.50 per child per year. In 1865 a State Board of Education was established, whose secretary is Superintendent of Public Instruction. The following are statistics for the year ending August 31, 1875:—Districts, 1506; public schools, 1650; children from four to sixteen (on January 1, 1875), 134,976, of whom 95 per cent. attended school. Average length of school, 176 days. Teachers: males, 721; females, 1910. Average pay per month: males, \$70; females, \$39. Income of public schools from all sources, \$1,592,858. Provision for higher education is made by various private and endowed schools, but is by no

means complete. The State Normal School at New Britain was opened in 1850; the annual State grant is \$12,000, and it graduates about 100 pupils a year. In 1870 there were in the State 29 academies and seminaries, with 127 instructors, 1602 pupils, and 8000 volumes in their libraries. There are three colleges. Yale College (Congregational), in New Haven, was established in 1701 by the ten foremost ministers of the colony; in 1876 it had 90 instructors, nearly 1100 students in all departments, and 101,000 volumes in the libraries; its productive funds were about \$1,500,000, and its property \$5,000,000. Besides its classical course, it has faculties and schools of theology, law, medicine, fine arts, together with the very prosperous Sheffield Scientific School, and several post-graduate courses of study. Trinity (formerly Washington) College, at Hartford, was founded in 1823 by Episcopalians; its property is about \$1,000,000, a considerable portion of which is in productive funds; it has about 20 instructors, 90 students, and 16,000 volumes in its library. Wesleyan University (Methodist) at Middletown was founded in 1831; property in 1875, \$400,000; income, \$47,000; instructors, 15; students, 190; library, 27,000 volumes; women were admitted in 1872. There is a theological institute (Congregational) at Hartford, and the Berkeley Divinity School (Episcopal) is at Middletown. In 1870 the State had 64 public libraries, with 285,937 volumes; these receive State aid. There are several valuable private libraries relating to American subjects at Hartford. The newspapers and periodicals numbered 71, circulating 203,725, and issuing annually 17,454,740 copies. There were 827 religious organizations, having 902 edifices, with 338,735 sittings, and property worth \$13,428,109. The Congregationalist is by far the most numerous and wealthy denomination, followed by Episcopalians, Methodists, Baptists, and Roman Catholics.

**Government.**—Connecticut is represented in the National Congress by two senators and four representatives, and has now six votes in the Presidential electoral college. The State constitution provides distinct executive, legislative, and judicial powers. The chief officer, or governor, must be over thirty years of age. A majority vote in each house of the legislature carries a bill over his veto. His salary is \$2000. The legislature, or General Assembly, consists of a senate and house of representatives, and meets annually on the Wednesday after the first Monday in January. The senate consists of not less than 18, or more than 24, members from districts determined by the General Assembly according to population. The representatives are two from each town incorporated before 1785 or having over 5000 inhabitants, and one from every other. The senators now number 18, the representatives 244. Each legislator is paid \$300 a year. There is much special and excessive legislation. All elections are by ballot. Representatives are elected annually, and the general State officers and senators biennially, on the Tuesday after the first Monday in November. Any male citizen of the United States, aged twenty-one, who shall have resided in the State one year, and in the town where he offers to vote, six months, and who can read any article of the constitution, is entitled to vote. The pardoning power is vested in the Assembly. The judicial power is vested in the following courts:—A supreme court of errors, consisting of a chief and four associates; a superior court, consisting of six judges, together with the five of the court of errors. These are all chosen for eight years by the Assembly, but are disqualified on attaining the age of seventy. They may be removed by impeachment, or by the governor on a two-thirds address of each house. Their salary is \$4000 each. There are also five courts of common pleas, presided over by a single judge, chosen for four years by the Assembly, with a salary of \$2500. There are inferior courts in certain cities and boroughs, with judges chosen biennially by the Assembly. Numerous justices of the peace are elected biennially by the people of the towns where they live. Probate courts are held in each district, of which there are 113; the judges are elected biennially by the people. A somewhat faulty revision of the General Statutes of the States was made in 1875. A peculiarity of the State is that, when cities are formed, they still remain (frequently) parts of towns, and have a double government. The State militia embraced, in 1875, 2636 men, though those liable to serve (viz., between the ages of eighteen and forty-five) numbered 62,103. The governor is commander-in-chief, and under him are a brigadier-general and staff and field officers. The brigade comprises four regiment of infantry (one from each congressional district) and one section of light artillery. Two regiments go into encampment for a week and the other two have a

full parade each year. The arms of the State are—three vines in fruit—2 and 1, all proper—with the motto, "Qui transtulit sustinet."

**History.**—The Dutch first explored the country in 1620, but made no settlement till 1633. Then they settled at Hartford, buying of the Pequot Indians, but selling soon after to the English. James I. granted the first English patent to all New England in 1620 to Lord Say-and-Seal and others. In 1634–36 permanent settlements were made at Hartford, Wethersfield, and Windsor by companies from Massachusetts under a patent from the Plymouth colony, covering the present State and also portions of Rhode Island, Massachusetts, Long Island, and an undefined territory to the west. In 1637 these towns organized an independent government, declared war against the Pequots, and, under Captain J. Mason, nearly destroyed the tribes. In 1638 New Haven and vicinity was settled by an English company under Rev. J. Davenport and Governor Eaton. This colony was united to Connecticut in 1662, as was Saybrook in 1644. In 1639 Connecticut, chiefly through the influence of the Rev. J. Hooker of Hartford, adopted a constitution. This was "the first one written out, as a complete form of civil order, in the New World, and embodies all the essential features of the constitutions of the American States, and of the Republic itself, as they exist at the present day. It is the free representative plan which characterizes the country." In this constitution, and during the administration of it (till 1661), the only authority recognized was the "supreme power of the commonwealth," and the people were practically independent. When Charles II. came to the throne, J. Winthrop, jun., succeeded, in 1662, in obtaining a most liberal charter, which constituted Connecticut so completely a self-governed colony that no changes were needed in the instrument when she became one of the American States. Nor was it altered till 1818. From 1685 to 1687 James II. made strenuous efforts to take away all the New England charters; and in the latter year, Sir E. Andross, the royally appointed governor, came to Hartford while the Assembly was sitting, and demanded the charter. It was, however, concealed in the famous Charter Oak; and, at the dethronement of James II. in 1689 (after a year and a half of oppressive rule by Andross), the colonial Government resumed its functions as if nothing had happened. From the union of the colonies, Hartford was the seat of Government till 1701, from which date it shared the honor with New Haven until 1874, when it became the sole capital. The code, commonly called the *Blue Laws of Connecticut*, is now generally considered to have been a forgery by the Rev. Samuel Peters. The early statutes were not peculiarly severe or intolerant, and no case of execution for witchcraft is known. During the French and Indian wars Connecticut supplied her full quota of soldiers; and, during the revolt of the colonies, she furnished more men in proportion to her population, and more aid in proportion to her wealth, than any other colony. A few days before the Declaration of Independence she instructed her delegates to propose such a measure. The efficient and wise governor at the time, whom Washington used to call Brother Jonathan (Trumbull), has bequeathed his nickname to the country. Connecticut ratified the U. S. Constitution, January 9, 1788, being the fifth colony to do so. She took an active part in the war of 1812, though it cost the ruin of her West India and coasting trade. The present constitution was adopted in 1818, doing away with slavery, and being otherwise remarkable for its liberality and wisdom. It has been considerably amended to meet the needs of increased and differently distributed population, and of industrial progress. Under Governor Buckingham the State took a very prominent part in the civil war of 1861–65. She furnished 64,882 men, mostly for three years; and the war expenses, not only of the State and towns, but of private individuals, were enormous. The administration of the government since has been unusually honest and cautious, owing to the even balance of the political parties who alternate in its conduct. There is no just and complete history of the State, but its records from 1636 are preserved, and furnish the best source of information. The general histories of Bancroft and Palgrave, and the special ones of Trumbull, Hollister, and Barber, present the history very fairly down to the present century. There is a bulky history of *Connecticut during the War of 1861–65*, by Crofut and Morris. In Hartford is an enterprising Historical Society with

some published collections. The Reports of the Board of Education are valuable in this connection. (W. G. A.)

**CONNEMARA**, a wild and picturesque district in the west of Galway, Ireland, indented by numerous bays from the Atlantic, whence it derives its name. It corresponds in boundary with the barony of Ballinahinch, lying between the bays of Kilkieran and Ballinakill; but the name is often applied in a general way to the whole western division of county Galway.

**CONNOR, BERNARD** (1666–1698), physician, was born in Kerry, Ireland. He studied medicine at Montpellier, and afterwards at Paris. Having travelled through Italy with the two sons of the high chancellor of Poland, he was introduced at the court of Warsaw, and appointed physician to John Sobieski, king of Poland. In 1695 he visited England, and read a course of lectures on physiology in London and Oxford. He was afterwards elected member of the Royal Society and College of Physicians, and was invited to Cambridge, where he also delivered public lectures. He was the author of a treatise entitled *Evangelium Medici* (the Physician's Gospel), in which he endeavored to explain the Christian miracles as due to natural causes. He also wrote a *History of Poland* in 2 vols.

**CONOLLY, JOHN** (1794–1867), physician, studied medicine at Edinburgh, where he took the degree of M.D. in 1821. He settled in practice at Chichester, whence he removed to Stratford-on-Avon. In 1827 he was appointed, when only thirty-three years of age, professor of practice of physic in University College, London. This chair he resigned after holding it four years. Subsequently he practised medicine in Warwick until 1839, in which year he was elected resident physician to the Middlesex County Asylum at Hanwell. It was in this capacity that Conolly made his name famous, by carrying out in its entirety and on a large scale the principle of non-restraint in the treatment of the insane. This principle had been acted on in two small asylums—the Retreat near York, and the Lincoln Asylum; but it was due to the philanthropic energy of Conolly in sweeping away all mechanical restraint in the great metropolitan lunatic hospital, in the face of strong opposition, that the principle became diffused over the whole kingdom, and accepted as fundamental. Dr. Conolly was granted the degree of D.C.L. by the University of Oxford in 1851, in acknowledgment of these services. He died in 1867. See a memoir by Sir James Clark, Bart., published in 1869.

**CONON**, an Athenian general. Having already commanded on several occasions, he was chosen as one of the ten generals who superseded Alcibiades in 406 B. C. He was not present at the battle of Arginusæ, and consequently he was allowed to remain in command. In 405, however, the Athenian fleet was surprised by Lysander, at Ægospotami, and Conon fled to his friend, Évagoras, king of Cyprus. On the outbreak of the war between Sparta and the Persians, he obtained from King Artaxerxes joint command with Pharnabazus of a Persian fleet. With it in 394 B. C. he defeated the Lacedæmonians near Cnidus, and thus deprived them of the empire of the sea, which they had held since the taking of Athens. Sailing down the Ægean to Athens, he expelled the Lacedæmonian harlots from most of the maritime towns, and finally completed his services to his country by restoring the long walls and the fortifications of the Piræus. According to one account, he was put to death by Tiribazus, when on an embassy from Athens to the Persian court; but it seems more probable that he escaped to Cyprus, where he had considerable property, and that he died there a natural death. See GREECE.

**CONRAD**. For the four emperors of this name, see GERMANY.

**CONRADIN** (1252–1268), son of the Emperor Conrad IV. and Elizabeth of Bavaria, was at the death of his father an infant some two years old. His uncle, Manfred, the illegitimate son of Frederick II., declared himself his champion, but, having recovered the Two Sicilies, himself seized the throne. Urban IV. now called in the aid of Charles of Anjou, who defeated Manfred, and took possession of the crown. But Charles showed favor to none but his own countrymen, and at the entreaty of the Ghibelline leaders, by whom he was acknowledged as emperor, Conradin, now only sixteen, led an army into Italy. After gaining some advantages he was utterly defeated in Au-

gust, 1263, and soon after, being betrayed into the hands of Charles, he was unjustly tried, condemned, and executed in the market-place of Naples, with the consent of the Pope. He left his kingdom by will to Peter of Aragon. See SICILY.

CONRART, or CONBARD, VALENTIN (1603-1675), one of the founders of the French Academy, was born at Paris in 1603, and was educated, under Calvinist parents, for a commercial life. After his father's death, however, he turned his attention to literature, made himself proficient in his own language, and in those of Italy and Spain, and being brought into contact with men of letters, soon acquired a reputation, which for many years he did nothing to support. He was made councillor and secretary to the king; and this, together with a benevolent character, a faultless taste, and a certain charm of disposition and conversation, gained him a host of friends in the highest circles. Some, however, refused to join in the applause that everywhere greeted Conrart, and posterity has echoed their verdict. His literary reputation has passed away almost as completely as that of his friend Chapelain; and a certain distinction of style, recognized by Sainte-Beuve, is all that he is now credited with. In 1629 Conrart's house became the resort of a knot of literary men, who met to talk over professional subjects, and to read for advice and approval such work as they produced. The indiscretion of one of the number led to an involuntary notoriety, and to the influx into the meetings of the club of many strangers. Among these was Boisrobert, Richelieu's news-monger and jester, who reported to his patron what he had seen and heard. The cardinal offered the society his protection, and in this way (1634) the French Academy was created. Conrart was unanimously elected secretary, and discharged the duties of his post for forty-three years, till his death in 1675. The intelligence and conscientiousness he displayed in this capacity are perhaps his greatest titles to distinction. To the last he rigidly adhered to his hereditary faith. See ACADEMY, vol. i. p. 72; Petitot, *Mémoires Relatifs à l'Histoire de France*, tome xviii.; and Sainte-Beuve, *Causeries de Lundi*, 19 Juillet, 1858.

CONSALVI, or GONSALVI, ERCOLE (1757-1824), cardinal and statesman, was born at Rome on the 8th of June, 1757, of a noble family originally belonging to Pisa. His boyhood was sickly, and presents nothing remarkable. From the college of Urbino, he passed to the Frascati College and the religious academy at Rome, studying theology, politics, music, and literature. Entering the Pontifical court as page in 1783, he rapidly advanced, and in 1797 obtained the office of auditor of the rota, which brought him into public notice. Accused of participation in the assassination of Duphot, he was arrested by the French on their seizure of Rome, and after a period of incarceration condemned, like so many of his brethren, to exile. On the death of Pius VI. he succeeded, in conjunction with Cardinal Maury, in securing in the conclave at Venice the election of Chiaramonti as Pius VII.; and the new pope rewarded his devotion by appointing him secretary of state. Though from the beginning an avowed antagonist of the principles of the Revolution, Consalvi was too wise not to know that even Rome required in some degree to acknowledge their influence. He accordingly instituted various reforms, and but for the bitter opposition of the Conservative party his measures would have been more thoroughgoing than they were. He permitted laymen to hold certain public offices, under surveillance of the prelates, organized a guard from among the Roman nobility, decreed a plan for redeeming the base coinage, permitted the communes a certain degree of municipal liberty, and promised the liquidation of the public debt. In the long debates between Rome and France about the Concordat, Consalvi was the leading power on the side of the church; and he fought for the Papal privileges during his visit to Paris, with a pertinacity and spirit that won at once the hatred and respect of Napoleon. Impressed with Napoleon's power, and anxious, if possible, to make him subservient to the designs of Rome, he strongly urged the Pope to accede to the conqueror's request that the imperial crown should be placed on his head by the most sacred hands in Christendom. During the Pope's absence on this mission he remained as virtual sovereign in Rome; and his regency was rendered remarkable by a great inundation, caused by the overflow of the Tiber, during which he exposed himself with heroic humanity, for the preservation of the sufferers. Not long after the return of the Pope, the amity between

the Vatican and the Tuileries was again broken. Rome was full of anti-Revolutionary and anti-Napoleonic strangers from all parts of Europe. The emperor was irritated; and his ambassador, Cardinal Fesch, kept up the irritation by perpetual complaints directed more especially against Consalvi himself. "Tell Consalvi," wrote the conqueror, still flushed with Austerlitz, "that if he loves his country he must either resign or do what I demand." Consalvi did accordingly resign on the 17th June, 1807, and was followed in rapid succession by Casoni, Doria, Gabrielli, and Pacca. When in 1808 Miollis entered Rome, and the temporal power of the Pope was formally abolished, he broke off all relations with the French, though several of them were his intimate friends. In 1809 he was at Paris, and, in a remarkable interview, of which he has left a graphic account in his memoirs, he received from Napoleon's own lips what was practically an apology for the treatment he had received. With unbending dignity, however, he retained his antagonism; and shortly afterwards he was one of the thirteen cardinals who refused to recognize the marriage of Marie Louise. The result, as is well known, was a confinement at Rheims which only terminated about three years afterwards, when Napoleon had extorted what terms he pleased from the half-captive Pope at Fontainebleau. On his release Consalvi hastened to his master's assistance; and he was soon after permitted to resume his functions under the restored pontificate at Rome. Despatched to England to meet the allied sovereigns, he was well received both by king and people; and at the Congress of Vienna he obtained the restitution of the Marches (Ancona, Treviso, and Fermo) and the Legations (Bologna, Ferrara, and Ravenna). The rest of his life was spent in the work of reorganizing the States of the Church, and bringing back the allegiance of Europe to the Papal throne. He was practically governor of Rome; and Pius was so much under his control that "Pasquin" said the Pope would have to wait at the gates of paradise till the cardinal came from purgatory with the keys. In his foreign policy he was actuated mainly by antagonism to Austria; in his domestic policy he imitated the centralizing system of France. In all essentials a most rigid churchman, he was disposed to yield in minor matters, and obtained the praise of many Protestant visitors to Rome for his affability and liberality. Science, literature, and especially the fine arts received his most abundant patronage; the ancient buildings of Rome were excavated and preserved by his direction; chairs of natural science and archæology were founded in the university; and extensive purchases were made for the Vatican Museum, which was augmented by the addition of the beautiful Braccio Nuovo, or new wing. These and the like expenses, however, were a heavy drain on the Papal treasury, and brought Consalvi into financial difficulties, from which he only got free by the imposing of unpopular taxes. On the death of Pius VII. he retired to his villa of Porto d'Anzio; and, though he afterwards accepted from the new Pope the honorary office of prefect of the college *De Propaganda Fide*, his political career was closed. He died on 22d of January, 1824, leaving the most of his moderate fortune to the poor. A fine portrait of Consalvi by Sir T. Lawrence is preserved at Windsor, and his tomb in South Marcella is surmounted by a monument by Rinaldi.

The memoirs of his life, written with great freedom of statement and considerable force of style, have been published by Crétineau-Joly in 1864. See also M. de Pradt, *Histoire des Quatre Concordats*, 1818-1820; L. Cardinali, *Elogio detto alla memoria del card. Consalvi*; *Cenni biografici sul Consalvi*, published at Venice in 1824; Bartholdi, *Züge aus dem Leben des Cardinals Herc. Consalvi*, 1825; Cardinal Wiseman, *Recollections of the last Four Popes*, 1858; Crétineau-Joly, *L'Église Romaine en face de la Révolution*, 1859; and Ernest Daudet, *Le Cardinal Consalvi*, 1866.

CONSANGUINITY, or KINDRED, is defined by the writers on the subject to be *vinculum personarum ab eodem stipite descendentium*, that is, the connection or relation of persons descended from the same stock or common ancestor. This consanguinity is either lineal or collateral. Lineal consanguinity is that which subsists between persons of whom one is descended in a direct line from the other, while collateral relations descend from the same stock or ancestor, but do not descend the one from the other. Collateral kinsmen, then, are such as lineally spring from one and the same ancestor, who is the *stipite*, or root, as well as the *stipes*, trunk, or common stock, whence these rela-

tions branch out. It will be seen that the modern idea of consanguinity is larger than that of *agnatio* in the civil law, which was limited to connection through males, and was modified by the ceremonies of adoption and emancipation, and also than that of *cognatio*, which did not go beyond the sixth generation, and was made the basis of Justinian's law of succession. The more limited meaning of *consanguinei* was brothers or sisters by the same father, as opposed to *uterini*, brothers or sisters by the same mother. The degrees of collateral consanguinity were differently reckoned in the civil and in the canon law. "The civil law reckons the number of descents between the persons on both sides from the common ancestor. The canon law counts the number of descents between the common ancestor and the two persons on one side only," and always on the side of the person who is more distant from the common ancestor. A recent American writer, Lewis Morgan (*Systems of Consanguinity and Affinity in the Human Family*, 1871), has given the terms used to denote kindred in 139 languages. The Mongoloids, the Malays, the Dravidas, and the American aborigines have the following system. All the descendants of a common ancestor or ancestors of the same generation call each other brother and sister; they call all males of the previous generations fathers, and of the following one sons. From this he draws the mistaken inference (shared by Lubbock) that the primitive marriage state was hetarism, or community of wives. The linguistic facts are more probably connected with considerations of social rank, and such associations as the vendetta. In fact, except Egypt and Persia, nearly the whole world, both civilized and savage, have joined in repudiating incest. The chief danger has now been seen to lie in the risk of transmitting defects in an aggravated form. The force of the feeling is seen in the custom of wife-stealing, or exogamy by violence. In many places even identity of name is held to be an impediment to marriage. (See also M'Lennan *On Primitive Marriage*, 2d edition, 1876.)

CONSCRIPTION. See ARMY, vol. ii., pp. 495, 526, 527, &c.

CONSECRATION, the act of devoting anything to sacred uses. The Mosaic law ordained that all the first-born both of man and beast should be consecrated to God. We find also that Joshua consecrated the Gibeonites, as Solomon and David did the Nethinims, to the service of the Temple; and that the Hebrews sometimes consecrated their fields and cattle to the Lord, after which they were no longer in their own power. In England (and, indeed, in all countries where any form of episcopacy prevails) churches have always been consecrated with particular ceremonies, the form of which is either left in a great measure to the discretion of the bishops, or provided for in the recognized office-books. Cemeteries are in like manner episcopally consecrated. Consecration is also used for the benediction of the elements in the Eucharist. Consecration, or the ancient heathen ceremony of the apotheosis of an emperor, is thus represented on medals:—On one side is the emperor's head, crowned with laurel, sometimes veiled, while the inscription gives him the title of *divus*; on the reverse is a temple, a bustum, an altar, or an eagle taking its flight towards heaven, either from off the altar, or from a cippus. In others the emperor is borne up in the air by the eagle. The inscription is always *consecratio*. These are the usual symbols; but on the reverse of that of Antoninus is the Antonine column. In the apotheosis of empresses, instead of an eagle, there is a peacock. The honors rendered to these princes after death were explained by the words *consecratio*, *pater*, *divinus*, and *deus*. Sometimes around the temple or altar are put the words *memoria felix*, or *memoria eterna*; and for princesses, *eternitas*, and *sideribus recepta*; whilst on the one side of the head is *dea*, or *bea*. The term *consecratio* is also applied by Roman authors to the devotion of priests and temples to the gods; this is likewise called *dedicatio* and *inauguratio*. In Greek we find the verbs *ἱεῖν*, *ἱεῖσθαι*, used to express the same idea, with the cognate noun *ἱερωσύνη* and (in late authors) *καθιερωσύνη*.

CONSERVATORY (Ital. *Conservatorio*, Fr. *Conservatoire*, Ger. *Conservatorium*), a name applied first in Italy, and afterwards throughout the Continent, to institutions for training in music and for preserving the true theory and practice of the art. They arose out of the necessity of providing trained choristers for the service of the church, and were generally maintained upon some charitable foundation which provided board in addition to a musical educa-

tion for orphans and the children of poor parents, other pupils being occasionally taken on payment of fees. When fully equipped, each conservatorio had two *maestri* or principals, one for composition and one for singing, besides professors for the various instruments. Though St. Ambrose and Pope Leo I., in the 4th and 5th centuries respectively, are sometimes named in connection with the subject, the historic continuity of the conservatoire in its modern sense cannot be traced farther back than the 16th century. The first to which a definite date can be assigned is the Conservatorio di Santa Maria di Loreto, at Naples, founded by Giovanni di Tappia in 1537. Three other similar schools were afterwards established in the city, of which the Conservatorio di Sant' Onofrio deserves special mention on account of the fame of its teachers, such as Alessandro Scarlatti, Leo, Durante, and Porpora. There were thus for a considerable time four flourishing conservatorios in Naples. Two of them, however, ceased to exist in the course of last century, and on the French occupation of the city the other two were united by Murat in a new institution under the title Reale Collegio di Musica, which admitted pupils of both sexes, the earlier conservatorios having been exclusively for boys. In Venice, on the other hand, there were from an early date four conservatorios conducted on a similar plan to those in Naples, but exclusively for girls. These died out with the decay of the Venetian republic, and the centre of musical instruction for Northern Italy was transferred to Milan, where a conservatorio on a large scale was established by Prince Eugene Beauharnais in 1808. The celebrated conservatoire of Paris owes its origin to the École Royale de Chant et de Déclamation, founded by Baron de Breteuil in 1784, for the purpose of training singers for the opera. Suspended during the stormy period of the Revolution, its place was taken by the Conservatoire de Musique, established in 1795 on the basis of a school for gratuitous instruction in military music, founded by the mayor of Paris in 1792. The plan and scale on which it was founded had to be modified more than once in succeeding years, but it continued to flourish, and in the interval between 1820 and 1840, under the direction of Cherubini, may be said to have led the van in musical progress in Europe. In more recent years that place of honor belongs decidedly to the conservatorium at Leipsic, founded by Mendelssohn in 1842, which, so far as composition and instrumental music are concerned, is now the chief resort of those who wish to rise to eminence in the art. Of other Continental conservatoires of the first rank may be named those of Prague, founded in 1810, of Brussels, founded in 1833 and long presided over by the celebrated Fetis, of Cologne, founded in 1849, and those instituted more recently at Munich and Berlin, the instrumental school in the latter being under the direction of Joachim. In England the functions of a conservatoire have been discharged by the Royal Academy of Music of London, which was founded in 1822, and received a charter of incorporation in 1830. With very limited resources, as compared with the larger Continental establishments, it has done excellent service in providing a constant succession of thoroughly-trained professional musicians. A national training-school of music was opened at South Kensington under distinguished auspices in May, 1876, the object being to provide a free education of the highest kind to pupils of remarkable promise as tested by examination.

CONSISTORY, a term applied originally to an antechamber or outer-room of the palace of the emperors of Rome, where the petitioners for justice assembled and awaited the presence of the emperor, who upon his entrance into the consistory took his seat upon a tribunal, whilst the others stood around him (*consistebant*). The word "consistory," as a term of ecclesiastical law, in which sense it is for the most part employed in modern times, came to be used first of all to denote certain ecclesiastical councils, in which the bishop was seated, whilst the presbyters and other clergy stood around him. It came by degrees to be used generally for all ecclesiastical councils in which a bishop presided, and in which matters of order rather than of doctrine were discussed and decided. The term "consistory," as used in the Latin Church, is applied at Rome to denote the assembly of the cardinals convoked by the Pope. This assembly is styled a consistory, "quia simul presente Papa consistunt cardinales," the Pope's presence being a necessary condition to constitute the assembly of the cardinals a consistory.

There are two kinds of consistory which the Pope is in the habit of convoking—a public consistory and a private consistory. A public consistory is now rarely summoned; it is in fact, an extraordinary assembly of the cardinals, at which other prelates and ecclesiastical magnates are present, and over which the Pope presides in his pontifical robes of state. It was usual for the Pope to receive foreign sovereigns and their ambassadors in a public consistory, and the hat used to be conferred on newly-created cardinals in such a consistory. The private or secret consistory is the ordinary court in which the cardinals attend on the Pope, and in which the Pope formally transacts certain ecclesiastical matters, which are of high importance and are termed consistorial matters; for instance, his Holiness nominates in secret consistory to all consistorial benefices, creates cardinals, appoints to vacant bishoprics, confirms the election of bishops, deposes bishops, decrees the pallium to be sent to archbishops, unites churches, grants extraordinary dispensations, &c. This ordinary consistory of the Pope is for the most part held in a chamber of the Papal palace at Rome known as the *camera papagali* or *papagalli*, which may be translated "The Painted Chamber," as Ducange renders it, "aula ornamentis decora." The phrase seems to have come into use in the Cœrimoniale Romanum, as "the Star Chamber" at Westminster came to be so called from the painting or tapestry on its walls. The term "consistory" is used in the Church of England to signify the tribunal or place of justice, which in olden times was fitted up within the nave of every cathedral church, for the most part on the left-hand side of the western entrance, for the bishop of the diocese or his vicar-general to hold his court for the hearing and deciding of ecclesiastical causes. Under the questionable influence of the spirit of resistance to the authority of the bishop, which has been a distinctive characteristic of the cathedral bodies in the Church of England from the earliest period of the Papal exemptions, the deans and chapters of the cathedral churches of England have in most cases caused the consistorial court of the diocesan bishop to be removed from the nave of the cathedrals, so that it is very rare to find at the present time traces of any such structure. The last trace of the diocesan consistory of the archbishop of Canterbury was removed from his cathedral within the memory of the living, when a restoration of the nave was made; and the consistorial court of the bishop of London, which was on the south side of the nave of St. Paul's cathedral church, has been converted in very recent times, under the auspices of the late Dean Milman, into a memorial chapel for the reception of a national monument of the first Duke of Wellington. The consistorial courts of the bishops of the Church of England are now but "the shadows of great names," as the state has deprived the judges of the consistorial courts of the jurisdiction formerly exercised by them in matrimonial and testamentary matters, and their corrective jurisdiction over criminous clerks has been transferred to other tribunals. It is not necessary, nor is it usual, for the bishops to hold their diocesan visitations in their consistorial courts.

The term "consistory" is used in certain of the Reformed churches, which do not recognize the order of bishops, to signify the supreme governing council of presbyters and elders, and such churches are hence termed consistorial churches.

**CONSOLIDATION ACTS.** The practice of legislating for small portions of a subject only at a time, which is characteristic of the English Parliament, produces as a necessary consequence great confusion in the statute law. The Acts relating to any subject of importance or difficulty will be found to be scattered over many years, and through the operation of clauses partially repealing or amending former Acts, the final sense of the Legislature becomes enveloped in unintelligible or contradictory expressions. Where opportunity offers, the law thus expressed in any statute is sometimes recast in a single statute, called a Consolidation Act. Among such are the Criminal Laws Consolidation Act and the Customs Laws Consolidation Act. These observations apply to the public general Acts of the Legislature. On the other hand, in settling private Acts, such as those relating to railway and canal enterprise, the Legislature always inserted certain clauses, founded on reasons of public policy applicable to the business in question. To avoid the necessity of constantly re-enacting the same principles in private Acts, their common

clauses were embodied in separate statutes, and their provisions are ordered to be incorporated in any private Act of the description mentioned therein. Such are the Lands Clauses Consolidation Act, the Companies Clauses Consolidation Act, and the Railways Clauses Consolidation Act, all passed in 1845.

**CONSOLS**, an abbreviation of *Consolidated Annuities*, had their origin in 1751, and now form the larger portion of the funded debt of the United Kingdom. In the progress of the national debt it was deemed expedient, on grounds which have been much questioned, instead of borrowing at various rates of interest, according to the state of the market or the need and credit of the Government, to offer a fixed rate of interest, usually three or three and a half per cent., and as the market required to give the lenders an advantage in the principal funded. Thus subscribers of £100 would sometimes receive £150 of three per cent. stock. In 1815, at the close of the French wars, a large loan was raised at as much as £174 three per cent. and £10 four per cent. stock for £100. The low rate of interest was thus purely nominal, while the principal of the debt was increased beyond all due proportion. This practice began in the reign of George II., when some portions of the debt on which the interest had been successfully reduced were consolidated into three per cent. annuities, and consols, as the annuities were called, and other stocks of nominally low interest, rapidly increased under the same practice during the great wars. In times of peace, when the rate of money has enabled portions of the debt at a higher interest to be commuted into stock of lower interest, it has usually been into consols that the conversion has been effected. Temporary deficits of the revenue have been covered by an issue of consols; exchequer bills when funded have taken the same form, though not constantly or exclusively; and some loans of the Government in recent times for special purposes, such as the relief of the Irish famine and the expenditure in the Crimean war, have been wholly or partly raised in consols. The consequence has been to give this stock a pre-eminence in the amount of the funded debt. It appears from a recent parliamentary return that of £773,313,229 of funded debt of the United Kingdom £398,147,075 consisted of consols, £107,227,854 of three per cent. reduced annuities, and £225,256,099 of new threes. The funds of the savings' banks have been applied to the absorption of reduced annuities and new threes in larger proportion than of consols. The characteristics of this large portion of the debt, though it would seem almost indistinguishable from the three per cent. reduced, which originated about the same period as the consolidated threes, are that the interest has never varied; no attempt has been made to convert it to a lower interest or into another form of stock; and not only from its larger amount than other stock is it most convenient to dealers, but from the great number and variety of its holders it is believed to express with the greatest nicety the state of monetary affairs. The price of consols, however, does not in ordinary times vary much. It has a tendency, indeed, to rise when all other securities are most shaken. In periods of panic and extreme pressure for money, it has gone down for a few days between 80 and 90; its most customary range may be said to be 95 to 97; and it has occasionally touched par. The legal provisions erecting consols are found in several clauses of 25 George II. c. 27, and the regulations for their redemption in section 24 of the same Act.

**CONSPIRACY**, in English law, is an agreement between two or more persons to do certain wrongful acts, which may not, however, be punishable when committed by a single person, not acting in concert with others. The following are enumerated in text-books as the things, an agreement to do which, made between several persons, constitutes the offence of conspiracy:—(1) Falsely to charge another with a crime punishable by law, either from a malicious or vindictive motive or feeling towards the party, or for the purpose of extorting money from him; (2) wrongfully to injure or prejudice a third person or any body of men in any other manner; (3) to commit any offence punishable by law; (4) to do any act with intent to pervert the course of justice; (5) to effect a legal purpose with a corrupt intent or by improper means; to which are added (6) conspiracies or combinations among workmen to raise wages.

The division is not a perfect one, but a few examples

under each of the heads will indicate the nature of the offence in English law. First, a conspiracy to charge a man falsely with any felony or misdemeanor is criminal; but an agreement to prosecute a man who is guilty, or against whom there are reasonable grounds for suspicion, is not. Under the second head the text books give a great variety of examples,—e. g. mock auctions, where sham bidders cause the goods to go off at prices grossly above their worth; a conspiracy to raise the price of goods by spreading false rumors; a conspiracy by persons to cause themselves to be reputed men of property, in order to deceive tradesmen; a conspiracy to cause by threats, contrivances, or other sinister means a pauper of one parish to marry a pauper of another in order to charge one of the parishes with the maintenance of both. These examples show how wide the law stretches its conception of criminal agreement. The third head requires no explanation. A conspiracy to murder is expressly made punishable by penal servitude and imprisonment (24 and 25 Vict. c. 100). A curious example of conspiracy under the fourth head is the case in which several persons were convicted of conspiracy to procure another to rob one of them, so that by convicting the robber they might obtain the reward given in such cases. The combination to effect a lawful purpose with corrupt intent or by improper means is exemplified by agreements to procure seduction, &c.

The most important question in the law of conspiracy, apart from the statute law affecting laborers, is how far things which may be lawfully done by individuals can become criminal when done by individuals acting in concert, and some light may be thrown on it by a short statement of the history of the law. In the early period of the law down to the 17th century, conspiracy was defined by the Ordinance of Conspirators of the 33 Edward I.—“Conspirators be they that do confedr or bind themselves by oath, covenant, or other alliance, that every of them shall aid the other falsely and maliciously to indite, or cause to indite, or falsely to move or maintain pleas, and also such as cause children within age to appeal men of felony, where they are imprisoned and sore grieved, and such as retain men in the country with liveries or fees to maintain their malicious enterprises, and this extendeth as well to the takers as to the givers.” The offence aimed at here is conspiracy to indict or to maintain suits falsely; and it was held that the agreement was in itself criminal, although the conspiracy was not actually completed (Poulterer's case, 1611). This developed into the rule that any agreement to commit a crime might be prosecuted as a conspiracy. A still further development of this doctrine is that a combination might be criminal, although the object apart from combination would not be criminal. The cases bearing on this question will be found arranged under the following heads, and in chronological order, in the *Law of Criminal Conspiracies and Agreements*, by R. S. Wright (London, 1873):—Combinations against Government; combinations to defeat or pervert justice; combinations against public morals or decency; combination to defraud; combination to injure otherwise than by fraud; trade combinations. “It is conceived,” says the author, “that on a review of all the decisions, there is a great preponderance of authority in favor of the proposition that, as a rule, an agreement or combination is not criminal unless it be for acts or omissions (whether as ends or means) which would be criminal apart from agreement.” A dictum of Lord Denman's is often quoted as supplying a definition of conspiracy. It is, he says, either a combination to procure an unlawful object, or to procure a lawful object by unlawful means; but the exact meaning to be given to the word “lawful” in this antithesis has nowhere been precisely stated. A thing may be unlawful in the sense that the law will not aid it, although it may not expressly punish it. The extreme limit of the doctrine is reached in the suggestion that a combination to hiss an actor at a theatre is a punishable conspiracy.

The application of this wide conception of conspiracy to trade disputes caused great dissatisfaction among workmen. By the Master and Servant Act, 1867, breach of contract of service might be made the subject of complaint before a magistrate, who was empowered to impose a fine when he thought it necessary. Trades unions were relieved from

the stigma of illegality—which had hitherto attached to them by reason of their being combinations “in restraint of trade”—by the Trades Unions Act, 1871. In the same year the Criminal Law Amendment Act (34 and 35 Vict. c. 32) specified certain acts which, if done with a view to coercing either master or workman, were to be punishable with imprisonment. But in the meantime, the mere combination of workmen not to work with a particular person was held by the judges to amount to a conspiracy at common law (so held by Mr. Baron Pollock at Leeds assizes in 1874). And the case of the London gas stokers, who were in 1872 convicted of a conspiracy to break their contract of service, directed attention to the question of punishing breach of contract as a crime. The following extract from Mr. Justice Brett's charge to the jury will show the view taken by the judge: “If you think there was an agreement between the defendants to interfere with the masters by molesting them so as to control their will, and if you think that molestation was such as would be likely in the minds of men of ordinary nerve to deter them from carrying on their business according to their own will, then that is an illegal conspiracy.” Again “was there a combination to hinder the company from carrying on and exercising their business by means of the men simultaneously breaking their contracts of service? Breach of contract is an illegal, nay more, it is a criminal act, and if they combined to interfere with their employes by breaking their contracts this would be using unlawful means.” So in 1867, in the case of *Drueett*, it had been laid down that if any set of men agreed among themselves to coerce the liberty of mind and thought of another by compulsion and restraint, they would be guilty of a criminal offence. These judicial opinions led to much agitation, which ended in the legislation of 1875. In that year was passed the Act for amending the law relating to conspiracy and to the protection of property, and for other purposes, 38 and 39 Vict. c. 86. This Act was intended to regulate the criminal, as the Employers and Workmen Act of the same year (c. 90) was intended to regulate the civil, questions arising out of the contract for service. The corresponding Acts of 1867 and 1871 are repealed. The 38 and 39 Vict. c. 86 enacts (§ 3) that “an agreement or combination by two or more persons to do, or procure to be done, any act in contemplation or furtherance of a trade dispute between employers and workmen shall not be indictable as a conspiracy, if such act committed by one person would not be punishable as a crime. When a person is convicted of any such agreement or combination to do an act which is punishable only on summary conviction, and is sentenced to imprisonment, the imprisonment shall not exceed three months, or such longer period, if any, as may have been prescribed by the statute for the punishment of the said act when committed by one person.” The effect of the two Acts of 1875 is that breach of contract between master and workmen is to be dealt with as a civil and not as a criminal case, with two exceptions. A person employed on the supply of gas and water, breaking his contract with his employer, and knowing, or having reasonable cause to believe, that the consequence of his doing so, either alone or in combination with others, will be to deprive the inhabitants of the place wholly or to a great extent of their supply of gas or water, shall be liable on conviction to a penalty not exceeding £20, or a term of imprisonment not exceeding three months. And generally any person will fully and maliciously breaking a contract of service or hiring, knowing or having reasonable cause to believe that the probable consequences of his so doing either alone or in combination with others will be to endanger human life or cause serious bodily injury, or to expose valuable property whether real or personal to destruction or serious injury, shall be liable to the same penalty. By section 7 every person who, with a view to compel any other person to abstain from doing or to do any act which such other person has a legal right to do or abstain from doing, wrongfully and without legal authority, (1) uses violence to or intimidates such other person, or his wife and children, or injures his property; or (2) persistently follows such other person about from place to place; or (3) hides any tools, clothes, or other property owned or used by such other person, or deprives him of or hinders him in the use thereof; or (4) watches or besets the house or other place where such other person resides, or works, or carries on business, or happens to be, or the approach to such house or place; or

(5) follows such other person with two or more other persons, in a disorderly manner, in or through any street or road, shall be liable to the before-mentioned penalties. Of course a combination to do any of these acts would be punishable as a conspiracy, as mentioned in section 3 above.

Seamen are expressly exempted from the operation of this Act. The exceptions as to contracts of service for the supply of gas and water, &c., were supported by the circumstances of the London gas stokers' case above mentioned.

Conspiracy at common law is a misdemeanor, and the punishment is fine or imprisonment, or both, to which may be added hard labor in the case of any conspiracy to cheat and defraud, or to extort money or goods, or falsely to accuse of any crime, and to obstruct, pervert, prevent, or defeat the cause of justice. Conspiracy to murder, whether the victim be a subject of the Queen or resident in her dominions or not, is by 24 and 25 Vict. c. 100 punishable by penal servitude. (E. E.)

CONSTABLE, in England, an ancient officer of the peace. The name, as well as the office, is, according to Blackstone, borrowed from the French. In the Middle Ages there was a great officer of this name, whose duties related to matters of chivalry. "The office of Lord High Constable," says Blackstone, "hath been disused in England, except only upon great and solemn occasions—as the king's coronation and the like—ever since the attainder of Stafford, duke of Buckingham, under King Henry VIII., as in France it was suppressed about a century after by an edict of Louis XIII., but from that office, says Lambard, this lower constableness was first drawn, and is, as it were, a very finger of that hand."

The Statute of Winchester (13 Edw. I. st. 2, c. 6), ordaining every citizen to have armor according to his condition to keep the peace, requires that in every hundred and franchise two constables be chosen to make the view of armor twice a year, and that the said constables "shall present before justices assigned such defaults as they do see in the county about armor, and of the suits, and of watches, and of highways; and also shall present all such as do lodge strangers in uplandish towns, for whom they will not answer." These are the officers known as *high constables*; who are especially charged with the peace of the hundred, just as the *petty constables* are charged with the peace of the parish or township. They were appointed at the court of the hundred, or in default thereof by justices at special sessions (7 and 8 Vict. c. 33, § 8). By a recent Act, 32 and 33 Vict. c. 47, they are practically abolished, as the justices of each county are required to consider and determine whether it is necessary that the office of high constable of each hundred, or other like district, should be continued.

The petty or parish constable unites two offices—the ancient one of head-borough or tithing man, and the modern one, instituted about the reign of Edward III., of assistant to the high constable. Considering what manner of men were for the most part appointed to these offices, Blackstone thought it was well that they should be kept in ignorance of the extent of their powers. Besides their general duties in the preservation of the peace they are charged with the execution of warrants and the service of summonses. No action can be brought against a constable for any act done in the execution of his office unless within six months from the time of its being committed. By 24 Geo. II. c. 44, the justice who signed the warrant must be made a co-defendant in any action against the constable, and on the production of such warrant at the trial the jury must find for the constable, notwithstanding any want of jurisdiction in the magistrate. Petty constables were formerly elected at the court leet or, in default thereof, by two justices. But by 5 and 6 Vict. c. 109, it is ordered that the justices shall annually issue their precept to the overseers of each parish in their county, requiring them to return a list of persons in such parish qualified and liable to serve as constables, and that the justices on special petty sessions shall revise the list, and select therefrom such number of constables as they may deem necessary. Every able-bodied man resident within the parish, between the ages of twenty-five and fifty-five, rated to the relief of the poor or to the county rate, on any tenements of the net yearly value of £4 and upwards, is qualified and liable to serve as constable for that parish. But large classes of persons are specially exempted from the liability to serve,—

including peers and members of Parliament, judges, justices, clergymen and ministers, lawyers, physicians, officers of the army and navy, public servants, &c. Licensed victuallers and beer-sellers, game-keepers, and convicts are disqualified. Every person so chosen must serve; but those who have served already shall not be liable to serve again until every other person liable shall have served. Boroughs under the Municipal Corporation Act do not come within this statute. In consequence of the establishment of a county constabulary it is now enacted, by 35 and 36 Vict. c. 92, that no such constable shall be appointed unless for parishes in regard to which the magistrates for the county shall at their general or quarter sessions determine that it is necessary that such appointment shall be made.

*Special Constables* are appointed to act on occasional emergencies when the ordinary police force is thought to be deficient. In the absence of volunteers the office is compulsory, on the appointment of two justices. The lord-lieutenant may also appoint special constables, and the statutory exemptions may be disregarded.

The Acts establishing and regulating county constabulary are the 2 and 3 Vict. c. 93, 3 and 4 Vict. c. 88, 19 and 20 Vict. c. 69, 20 Vict. c. 2, and 22 and 23 Vict. c. 32. The police force of every county shall be under the superintendence of a chief-constable, who, with the approbation of justices in petty sessions, may appoint constables and provisional superintendants. The chief-constable has the general superintendence and direction of the force (including the petty constables where they still exist), and he may dismiss them at his pleasure, subject to the orders of Quarter Sessions, and the rules established for the government of the force. The salaries and other expenses under these Acts are to be paid by a police rate, to be made by the justices at Quarter Sessions. Counties and boroughs may consolidate their police force. The Crown appoints inspectors to report on the efficiency of the police, and whenever a certificate shall be granted by the Secretary of State that the police has been maintained during the preceding year in a state of efficiency as to discipline and numbers, the Treasury shall grant a sum in aid of the expenses not exceeding one-fourth of the charge for pay and clothing.

CONSTABLE, ARCHIBALD (1774–1827), the well-known Edinburgh publisher, was born in the parish of Carnbee, Fifeshire, on the 24th February, 1774. Having been educated at the parish school, he was, at his own request, apprenticed to a bookseller in Edinburgh, named Peter Hill. From the first he took a great interest in books; and he obtained permission from his master to attend book sales, and purchase rare works, of which he drew up carefully-executed catalogues. When not yet twenty-one years of age he had married and commenced business on his own account. He took special interest in Scottish literature; the rare works in that department which he offered for sale soon brought him into notice, and from this and from his genial disposition and his unprecedented liberality towards authors, his business grew rapidly. In 1801 he became proprietor of the *Farmers' Magazine* and the *Scots' Magazine*, and on the 10th October, 1802, he published the first number of the *Edinburgh Review*. Constable was for many years on the most intimate and friendly relations with Sir Walter Scott. In January, 1802, he had a share in the publication of the *Minstrelsy of the Scottish Border*, and afterwards published a large proportion of Scott's poems and novels. Besides these, he published the *Annual Register*, and the works of Dugald Stewart, Brown, Playfair, and Leslie. In 1812 he purchased the copyright of the *Encyclopædia Britannica*, to which he added the supplement to the 4th, 5th, and 6th editions (1815–1824), extending to six volumes, and containing the celebrated dissertations by Stewart, Playfair, and Brande. Not the least important of his undertakings was *Constable's Miscellany*, projected in 1825, consisting of a series of original works, and standard works republished in a cheap form, the earliest and one of the most famous of the attempts to popularize wholesome literature. In 1826 pecuniary difficulties in which the firm of Constable and Co. became involved (its liabilities exceeding £250,000) obliged it to stop payment. From this time Constable's health gave way, and he died on 21st July, 1827, having, by his generous dealings with authors, his literary enthusiasm, and his efforts to promote the diffusion of standard literature, gained for himself one of the most distinguished names among British publishers.

See *Archibald Constable and His Literary Correspondents*, by his son, Thomas Constable (1873).

CONSTABLE, HENRY, one of the most considerable of the Elizabethan sonneteers, was born about 1556, in Yorkshire, as it is supposed, and certainly of a Roman Catholic family. He was sent to St. John's College, Cambridge, where in 1579 he took his degree of B.A. In the same year there appeared a volume entitled *The Forest of Fancy* by H. C., which has been attributed to Henry Chettle, but may with far more probability be assigned to Constable. This is a black-letter romance in prose and verse, of some slight literary value. Until 1592 we lose sight of the poet altogether, but in that year appeared his principal work, the book of sonnets called *Diana*. The only sonnets in the Italian form which had preceded them were those of Sidney, printed the year before, and as Constable had been writing those poems for many years he deserves credit as being one of the first to introduce this elegant form of verse among us. His sonnets are not merely quatorzains, like Shakespeare's; he preserves the exact arrangement of rhymes, except that he usually closes with a couplet. So popular was *Diana* that in 1594 a second enlarged edition appeared. But all this time a cloud was gathering round the poet. As a Catholic and a pronounced admirer of the queen of Scots, he came under suspicion of plotting treason against Elizabeth. Almost immediately after ushering Sir Philip Sidney's *Apology for Poetry* into the world with four magnificent sonnets, in 1595, he was obliged, in October of that year, to fly for his life to France. After a short stay in Paris, he wintered at Rouen, and then set off on a long pilgrimage to Rome, Poland, the Low Countries, and Scotland. In 1600 we find him still an exile, this time in Spain. About the year 1601 he could endure the growing home-sickness no longer, and returned to England in disguise. He was discovered at once and committed to the Tower, where he languished until 1604, when he was released. Of the date of his death we know no more than can be gathered from the fact that he is spoken of as alive in 1606, and as apparently not long dead in 1616. Besides the *Diana* he was the author of four important poems which were printed in the 1600 edition of *England's Helicon*. Two of these, the exquisite lyric of "Diaphenia like the Daffadowndilly," and the charming pastoral song of *Venus and Adonis*, hold a prominent place in our early literature,—the latter especially being believed to precede Shakespeare's epic in date of composition. Some very fine *Spiritual Sonnets* of Constable have been printed in our own day, and it is understood that certain compositions of this "ambrosiac muse," as Ben Jonson styled it, are still awaiting an editor. The style of Constable is fervid and full of color. Mr. Minto has well said that his words flow with happiest impulse "when his whole being is aglow with the rapture of beauty."

CONSTABLE, JOHN (1776–1837), landscape painter, was born at East Bergholt, in the Stour valley, Suffolk, June 11, 1776. Under the guidance of a certain John Dunthune, a plumber, he acquired in early life some insight into the first principles of landscape art, together with a habit of studying in the open air that was afterwards of much service to him. His father, who was a yeoman farmer, did not care to encourage this tendency, and set him to work in one of his windmills. The incessant watchfulness of the weather which this occupation required laid the foundation of that wonderful knowledge of atmospheric changes and effects of which his works give evidence. From an introduction to Sir George Beaumont, an amiable man but a poor painter, he became acquainted with the works of Claude and Girtin. In 1795 he was sent to London with a letter to Farington, the landscape painter. Farington encouraged him with predictions of coming eminence; and for two years he plodded on, drawing cottages, studying anatomy, and copying and painting, sometimes in London and sometimes in Suffolk. His progress, however, was not encouraging; and in 1797 he returned home, and for some time worked in his father's counting-house. In 1799 he again went to London to perfect himself as a painter; and on the 4th of February he was admitted a student of the Royal Academy. The lights and shadows of his studies from the antique at this period are praised by Leslie, but they were sometimes defective in outline. He worked from dawn till dusk, and was an untiring copyist of such masters as he had sympathy with, as Wilson, Ruysdael, and Claude. Drawings from nature made during the next year or two, in Suffolk or in Derbyshire, were of no great promise. Being naturally slow, he was yet groping

blindly for something not to be found for many years. In 1802 he attended Brooke's anatomical lectures, exhibited his first picture, and, refusing a drawing mastership offered him by Dr. Fisher, gave himself wholly to his vocation. He exhibited a number of paintings during the next eight years, but it was not till 1811 that he gave to the world, in his Dedham Vale, the first work in which his distinctive manner and excellences are evident. In 1816, having inherited £4000 on his father's death, he emerged from a painful state of poverty with which he had been struggling, and married. In 1818 he exhibited four of his finest works; and next year he sent to Somerset House the largest picture he had yet painted, the landscape known as Constable's White Horse. In the November following he was made associate of the Academy. His power at this time, though unrecognized, was at its highest. In 1823, however, after the exhibition of such masterpieces as the Stratford Mill, the Hay Cart, and the Salisbury Cathedral, he did not disdain to copy two Claudes. In 1824 two of his larger pictures, which he sold, were taken to Paris, and created there a profound sensation. Allowing a great deal for the influence of Bonington, who died four years afterwards, much of the best in contemporary French landscape may be said to date from them. Constable received a gold medal from Charles X., and his pictures were honorably hung in the Louvre.

In 1825 he painted his Loch ("silvery, windy, delicious" is his own description of it), and sent his White Horse to Lille for exhibition. It made, like the others, a great impression, and procured the painter a second gold medal. Other great works followed; and in 1829 he was elected Academician, to the astonishment and ill-concealed displeasure of many, and began to devote himself, in conjunction with Lucas, to the preparation of his book of *English Landscape Scenery*. Hard work brought on ill-health and low spirits; rheumatism laid hold of him, and for some time he could neither write nor paint. In 1832, however, he exhibited his Waterloo Bridge (painted, said his enemies, with his palette-knife only), with three other pictures and four drawings. In 1834 he painted his Salisbury from the Meadows, more generally known as the Rainbow, a picture he valued greatly; and in 1836 he delivered a course of lectures on his art at the Royal Institution. He died suddenly on the 1st of April, 1837, leaving his Arundel Castle and Mill wet on his easel.

The principles on which this great painter worked are not far to seek. He himself has said, "Ideal art in landscape is all nonsense;" and this sentence may be said to sum up the whole of his theory and practice of painting. Turner's pictures to him were merely "golden dreams;" Both and Berghem were only fit for burning; if he proclaimed the greatness of Claude and Titian, it was that he recognized their truth. Truth in its broadest and finest sense was his only aim. He studied the country untiringly and intently, sacrificing mere detail to the larger necessities of tone ("tone is the most seductive and inviting quality a picture can possess"), reproducing to an eminent degree the sentiment of what he saw, flooding his canvas with light and shadows as one finds them, and faithfully translating such glimpses as were revealed to him of the geniality of nature. His range was limited; he succeeded best with the county familiar to him from his boyhood; but his repetitions of manner and subject are in reality so many tentatives towards perfection. His merits were recognized in France; but his studio was full of unsold pictures at his death, and it is certain that he could not have earned a livelihood by his art without abandoning his theories. Since his death, however, his pictures have greatly increased in value, and his influence on contemporary French and English landscape is recognized as both great and good.

See Leslie, *Memoirs of the Life of John Constable, R. A.*, London, second edition, 1845; and *English Landscape Scenery, a Series of Forty Mesautint Engravings on Steel, by David Lucas, from pictures painted by John Constable, R. A.*, London, folio, 1855.

CONSTANCE, or COSTNITZ, a city of the grand duchy of Baden, and the chief town of a circle of its own name, formerly called the *See Kreis*, or Lake Circle, is situated on the southern or Swiss side of the Rhine, at its exit from the Lake of Constance, 30 miles east of Schaffhausen by railway. It stands 1298 feet above the level of the sea.



The older portion of the city is still surrounded by its ancient walls, but beyond their limits lie extensive suburbs, of which the most remarkable are Brühl, Kreuzlingen, Paradise, and Petershausen. The last of these, which has grown up round a free imperial abbey, is situated on the other side of the river, and communicates with the city by means of a long covered bridge raised on stone piers. A large number of the buildings of Constance are of mediæval origin, and several are of high interest both to the historian and antiquary. Most remarkable are the minster, originally founded in 1048, but dating in its present form mainly from the beginning of the 16th century; St. Stephen's Church, belonging to the 14th; the old Dominican convent on the island of Genf (now a cotton-printing factory); the *Kaufhaus*, or public mart, in the hall of which sat the famous council of 1414-1418; and the old chancery or town-hall, erected in 1508. Besides the various administrative offices of the circle the town further possesses a gymnasium, a lyceum, various collections of antiquities, a public collection of books and pictures in the *Wessenberg Haus*, and a valuable series of archives. Since the introduction of steamboat and railway communication the commercial prosperity of the city has greatly increased. It now contains cotton-factories, linen-factories, carpet-loom, and breweries, maintains a considerable activity in printing and publishing, and has a vigorous and varied local trade. Population in 1864, 8516; in 1872, 10,061.

Constance probably dates from the 3d or 4th century; but it first began to be of importance in the 6th, when it became the seat of the bishop who had previously been settled at Windisch or Vindonissa in Aargau. It afterwards obtained the rank of an imperial city, and rose to be one of the largest and most flourishing municipalities in Germany. From 1414 to 1418 it was the seat of the great ecclesiastical council which, under the presidency of the emperor Sigismund, and consisting of 26 princes, 140 counts, more than 20 cardinals, 20 archbishops, 91 bishops, 600 prelates and doctors, and about 4000 priests, constituted itself the highest authority in the church, condemned to death the reformers Huss and Jerome of Prague, expelled the three rival popes John XXIII., Gregory XII., and Benedict XIII., and elected Martin V. as the legitimate successor of St. Peter. Constance joined the Smalkaldic League and refused to accept the "Interim." It was accordingly deprived of its imperial privileges, and in 1549 was presented by the emperor to his brother, the Archduke Ferdinand, in whose territory it remained till 1805, when it was acquired by Baden. The bishopric, which was secularised in the latter year, had become the largest in all Germany, stretching over a great part of Würtemberg, Baden, and Switzerland, and containing 350 conventual establishments and 1760 parsonages.

CONSTANCE, LAKE OF (German, *BODENSEE*), a large sheet of water on the confines of Switzerland, surrounded on the S.W. by the cantons of Thurgau and St. Gall, E. by Tyrol, N.E. and N.W. by Würtemberg and Baden respectively. It is of an oblong shape, the western extremity being considerably contracted. The length of the lake from Bregenz to Spittelberg is 42 miles, with an average width of 7½ miles. It forms the great reservoir of the Rhine, receiving the upper waters of that river near the village of Altenrhein and parting with them at Constance. The mean level of the surface is 1290 feet above the sea. The depth between Romanshorn and Langenargen is 152 fathoms, between Constance and Friederichshafen 120 fathoms, and between Lindau and the mouth of the Rhine 45 fathoms.

CONSTANT DE REBECQUE, HENRI BENJAMIN, an eminent French statesman and publicist, was born at Lausanne, 25th October, 1757, and died at Paris 10th December, 1830. His family was French, and had taken refuge in Switzerland during the religious persecutions. Till the age of thirteen he lived in his father's house at Lausanne; he afterwards studied at Oxford, Erlangen, and Edinburgh successively. It was in these foreign studies that he made a beginning in the cosmopolitan culture which afterwards characterized him; in England especially he learned to admire constitutional government, and made the acquaintance of such men as Erskine and Mackintosh. Shortly before the Revolution he went to Paris, and became acquainted with some of the leading liberal spirits of that city, where, after further travels, he finally settled in 1795. He attached himself to the moderate republican party, and supported it through many changes of fortune, both in the Assemblies and by writing, under the Directory and

the Consulate, till 1802, when he was expelled from the Tribunate by Napoleon. The circle to which he belonged again provoked the anger of the First Consul by its private opposition to the Government, whereupon Constant, with his celebrated friend Madame de Staël, found it advisable to retire from France. Thus arrested in his political career he turned to literature, and proceeded to Weimar, where he enjoyed the acquaintance of Goethe and Schiller, translated *Wallenstein*, and wrote the romance of *Adolphe*. He did not return to France till the overthrow of Napoleon in 1814. Attracted by the prospect of the restoration of constitutional government he supported the Bourbons, and, apparently for a similar reason, he adhered to Napoleon during the Hundred Days. After the violence of the second Bourbon restoration had subsided Constant reappeared on the political scene to maintain the principles of constitutionalism. By all legal means, in the journals and in the Chambers, as well as by political tracts and pamphlets, under Louis XVIII. and Charles X. he combated, not without success, the reactionary measures of the government. Ill health detained him in the country during the revolution of July (1830); but at the urgent request of Lafayette he returned to the capital, and concurred in the elevation to the vacant throne of Louis Philippe. Notwithstanding his feeble health Constant continued to support the new Government, but an unsuccessful candidature for a seat in the Academy so aggravated his previous complaint that he died a few months after the triumph of the principles to which he had consecrated his life. Adverse circumstances had prevented the champion of representative government from playing a first part in the history of France, assuming that he had the faculty to do so. His voice was dry, his manner deficient in ease and grace, and he did not excel in improvising a reply; but his intellect was clear and powerful, his culture wide, and his industry remarkable.

The greater part of his political tracts are collected by himself under the title of *Cours de Politique Constitutionnelle*. J. P. Pages collected the speeches delivered at the Chamber of Deputies, 3 vols. in 8vo (1832-1833). His great philosophical work was *De la religion considérée dans sa source, ses formes, et ses développements*. The most important of his purely literary productions are the novels, *Adolphe* and *Cécile*, and the translation of *Wallenstein*. His philosophical work on religion, which occupied him more or less almost all his life, is an attempt to trace the successive transformations of the religious sentiment, his conclusion being that, while the religious instinct is imperishable, the doctrinal and ceremonial forms by which it expresses itself are transitory. A quotation or two will suffice to indicate his attitude towards the liberalism of the 18th century. "Christianity has introduced moral and political liberty into the world." "If Christianity has been often despised, it is because men have not understood it. Lucian was incapable of understanding Homer; Voltaire has never understood the Bible."

CONSTANTINE, the capital of the French province of the same name in Algeria, situated in the richest and most populous part of the country, about 50 miles inland from the port of Philippeville, in 36° 22' 21" N. lat. and 6° 36' 36" E. long. It holds a highly romantic position on a rocky plateau, cut off on all sides but the west by a deep but beautiful ravine, through which the Rummel finds its way. A striking contrast exists between the older and Moorish portion of the city, with its tortuous lanes and Oriental architecture, and the modern and French portion, with its rectangular streets and wide open squares, frequently bordered with trees and adorned with fountains. Of the squares the Place Nemours is the most spacious, but the Place du Palais is of more importance in the commercial and social life of the city. The public buildings may be divided into those dating from before the French conquest and later erections. Among the former are the Kasba or citadel, the mosques, the palace of the bey, and the harem of Salah; among the later the court-house or *palais de justice*, the theatre, the Protestant church, and several administrative buildings. The Kasba, which occupies the northern corner of the town, is partly of Roman construction, and preserves in its more modern portions numerous remains of other Roman edifices. It is now turned into barracks, and contains within its precincts a hospital capable of accommodating 1500 patients. The mosque of Sidi el Kattani, which ranks as the finest in the

city, dates only from the 18th century; but that of Souk-er-Rezel, now transformed into a Christian Church, and bearing the name of *Notre Dame des Sept Douleurs*, was built as early as 1143. The Great Mosque, or Djama-Kebir, occupies the site of what was probably an ancient Pantheon. A religious seminary, or Medersa, is maintained in connection with the Sidi el Kattani; and the French support a college and various minor educational establishments for both Arabic and European culture. There is an archaeological society, and a collection of local antiquities has been formed. The native industry of Constantine is chiefly confined to leather goods and woollen fabrics. A considerable trade is carried on with Tunis and other places on the Mediterranean, and caravans proceed regularly by Biscara and Tuggurt into the interior. The population of the city, composed of various elements, amounted in 1872 to 30,330.

Constantine, or, as it was originally called, Cirta or Kirtha, from the Phœnician word for a city, was in ancient times one of the most important towns of Numidia, and the residence of the kings of the Massylii. Under Micipsa it reached the height of its prosperity, and was able to furnish an army of 10,000 cavalry and 20,000 infantry. Though it afterwards declined, it still continued to be considered an important military post, and consequently its name is frequently mentioned during successive wars. Cæsar having bestowed a part of its territory on his supporter Sittius, the latter introduced a Roman settlement, and the town for a time was known as Colonia Sittianorum. In the war of Maxentius against Alexander, the Numidian usurper, it was laid in ruins; and on its restoration in 313 by Constantine it received the name which it still retains. It was left uncaptured during the Vandal invasion of Africa, but on the conquest of the Arabians it shared the same fate as the surrounding country. During the 12th century it was still a place of considerable prosperity; and its commerce was extensive enough to attract the merchants of Pisa, Genoa, and Venice. Frequently taken and retaken by the Turks, it finally became under their dominion the seat of a bey subordinate to the dey of Algiers. In 1826 it asserted its independence of that potentate, and was governed by Hadj Ahmed, the choice of the Kabyles. In 1837 the French under Marshal Valée took possession of the place, and about ten years afterwards it was occupied as a regular colony.

**CONSTANTINE.** Of the thirteen emperors of this name, two are here noticed separately. For the others see **ROMAN HISTORY** and **GREEK EMPIRE.**

**CONSTANTINE I. (274-337).** Flavius Valerius Aurelius Constantinus, surnamed Magnus, or the Great, was born at Naissus (*Nissa*),<sup>1</sup> in upper Mœsia, in February, 274. He was the son of Constantius Chlorus and Helena, the wife of obscure origin (a *stabularia*, or innkeeper, according to St. Ambrose), whom her husband was compelled to repudiate on attaining the dignity of Cæsar in 292.<sup>2</sup> The part of the empire assigned to Constantius was the extreme West, including Spain, Gaul, and Britain; but Constantine was detained in the East at the court of Diocletian, doubtless as a pledge for his father's loyalty. He served with such distinction under Diocletian in the campaign in Egypt which closed in 296, and subsequently under Galerius in the war with Persia, that he was appointed a tribune of the first rank. His majestic presence, his personal courage, and his skill in military exercises made him a great favorite with the army, and excited in a corresponding degree the jealousy of the naturally suspicious Galerius, who did not scruple, it is said, to expose him repeatedly to unusual hazards in the hope of getting rid of him. The effect of this was to strengthen in Constantine a constitutional wariness and discretion which were often of advantage to him in after life. In 305 Diocletian and Maximian abdicated, and were succeeded in the supreme rank of Augustus by the two Cæsars, Constantius and Galerius. Constantine, who had naturally the strongest claim to a Cæsarship, was passed over by Galerius, and Constantius could not venture to bestow the office while his son remained at what was virtually a hostile court. It was only after repeated letters from his colleague that Galerius gave a reluctant consent that Constantine should join his father. There was ground for supposing even then that the per-

mission was given only to be cancelled, and Constantine accordingly acted upon it with the utmost promptitude, making the journey across Europe from Nicomedia to Boulogne in an unusually short time. At Boulogne he found his father on the point of setting out for Britain, and accompanied him. The death of Constantius soon after at York (25th July, 306) brought Constantine to the first great turning-point in his career. The circumstances were critical: it was necessary to avoid on the one hand losing the favor of the army by undue hesitation, and on the other incurring the active hostility of Galerius by undue self-assertion; and Constantine displayed just that union of determination and prudence that the occasion required. Accepting with well-feigned reluctance the enthusiastic nomination of the army to the vacant throne, he wrote at the same time a carefully-worded letter to Galerius, expressing regret that circumstances had not permitted him to delay assuming the purple until the imperial approbation could be signified, and begging to be recognized as Augustus in succession to his father. On the reception of the news Galerius was greatly incensed, and threatened to give both the letter and its bearer to the flames; but more prudent counsels prevailed, and he ventured to indulge his resentment only so far as to deny the title of Augustus, which was conferred upon Severus, Constantine being acknowledged as Cæsar. The latter acquiesced in this arrangement with apparent contentment, and at once set himself as the recognized inheritor of his father's power to carry out his father's wise and vigorous policy. The barbarians of the north sustained repeated defeats, and were permanently held in check by the building of a line of forts on the Rhine; and the internal prosperity of the country was promoted by a confirmation of the tolerant policy adopted by Constantius towards the Christians, the persecuting edict of Galerius being treated as a dead letter.

The events of the next few years showed clearly the essential instability of the arrangement devised by Diocletian for the partition of the imperial power among Augustuses and Cæsars. It was in the very nature of the plan that under it those who were nominally colleagues should be in reality rivals, constantly plotting and counter-plotting for the sole supremacy. Accordingly the history of the empire from the period of the division of the imperial power by Diocletian to that of its reconsolidation under Constantine is mainly a record of the struggle for that supremacy. The narrative is necessarily intricate, and can only be fully given in a general historical article. The state of matters was complicated by a rebellion at Rome against Galerius, which had for its final result the contemporaneous reign of no less than six emperors,—Galerius, Licinius, and Maximian in the East, and Maximian, Maxentius, and Constantine in the West (308). Maxentius was the son of Maximian, and Constantine was his son-in-law, having married his daughter Fausta at Arles in 307, on which occasion he received the title of Augustus; but this family relationship did not prevent a conflict of interests. Maxentius claimed to be the sole rightful sovereign of Italy, and being supported by the prætorian guards compelled his father to quit Rome. Maximian, after a brief residence in Illyricum, from which he was driven by Galerius, took refuge at the court of his son-in-law, Constantine, who received him with the respect due to his rank. For the second time he resigned the purple, and affected to have no longer any desire of power. Very soon after, however, he was tempted, during the absence of Constantine on the Rhine, to reassume the imperial dignity and to enter into a plot with Maxentius for the overthrow of his son-in-law. Constantine, on receiving the news, acted with the necessary promptitude. He appeared at once with his troops before Arles, and compelled Maximian to retreat to Marseilles, whither he followed him. The town might have stood a protracted siege, but it preferred to deliver up the usurper, who avoided the execution of the sentence of death pronounced upon him by committing suicide<sup>3</sup> (February, 310).

The death of Maximian was the first of a series of events which ended in the establishment of Constantine as the sole emperor of the West. It was seized upon by Maxentius as a pretext for hostile measures, which Constantine, unwilling to engage in war, ignored as long as he safely could. When

<sup>1</sup> The legend that Constantine was a native of Britain has long been generally abandoned. The passage in the panegyrist that speaks of his having ennobled Britain "*illic oriendo*" refers probably to his accession, as Gibbon suggests.

<sup>2</sup> A later tradition, adopted with characteristic credulity by Geoffrey of Monmouth, that Helena was the daughter of a British king, is a pure invention.

<sup>3</sup> According to Lactantius (*De Mort. Persoo.*, c. 29, 30), Maximian was pardoned for this attempt, and the clemency of Constantine was only exhausted by the discovery of a plot for his assassination in bed, which failed, owing to the conjugal fidelity of Fausta. Gibbon discredits this story.

the time came for action, however, he acted, as was his wont, with decision. Maxentius was preparing to invade Gaul, when Constantine, encouraged by an embassy from Rome, anticipated him by entering Italy at the head of a large and well-disciplined army. He had crossed the Cottian Alps (Mont Cenis), and was in the plains of Piedmont before Maxentius knew that he had set out. A series of successes at Susa, Turin, and Verona culminated in the decisive victory of the Milvian Bridge, near Rome (28th October, 312), which left the capital open to the invader. In the hurried retreat of the defeated army Maxentius was pressed by the throng over the bridge into the river, and was drowned. The conduct of the conqueror was marked on the whole by wisdom and moderation. The slaughter of the two sons and of the more intimate favorites of the fallen emperor was a measure deemed essential if the fruits of the victory were to be retained, and cannot be imputed to wanton cruelty, especially as Constantine seems to have abstained from the too common practice of an indiscriminate massacre. The final disbanding of the prætorian guards and the destruction of their camp, the imposition of a poll-tax on the senators, and the assumption of the title of Pontifex Maximus were the other chief events of Constantine's first residence in Rome, which lasted only a few weeks,—a fact in itself significant of the decaying importance of the capital, if not prophetic of the early rise of a Nova Roma.

It was in the course of the expedition that ended with the victory of the Milvian Bridge that the celebrated incident occurred, which is said to have caused Constantine's conversion,—the appearance of a flaming cross in the sky at noon-day with the motto *Ἐν τούτῳ νικᾷ* (By this conquer). The story is told by Eusebius, who professes to have had it from the lips of the emperor himself, and also with considerable variation in the details by Lactantius, Nazarius, and Philostorgius. In order to understand the true relation of Constantine to Christianity, however, it is necessary to consider all the incidents bearing upon that relation together, and this, therefore, along with the others. There is the less violence to chronological order in delaying the critical examination of the story, inasmuch as it was first communicated by Constantine to Eusebius several years later, and as the Labarum, or standard of the cross, made in obedience to the heavenly vision was not exhibited to the army, according to Gibbon, till 323. The conversion, whatever its nature and whatever its cause, was followed, indeed, by one more immediate result of a significant kind in the important Edict of Milan (March, 313), issued by Constantine and Licinius conjointly, restoring all forfeited civil and religious rights to the Christians, and securing them full and equal toleration throughout the empire.

By the victory of the Milvian Bridge Constantine became the sole emperor of the West. Very soon after a like change took place in the East. Galerius had died in May, 311, and a war ensued between the two surviving emperors in which Maximin was the aggressor and the loser, as Maxentius had been in the West. After a decisive defeat near Heraclea (April, 313), he took to flight, and died at Tarsus, probably by his own hand, in August of the same year. Licinius thus attained the same place in the East as Constantine held in the West. The interests of the two who now divided between them the empire of the world had been apparently identified by the marriage of Licinius to Constantine's sister Constantia, which was celebrated with great pomp at Milan in March, 313. But in little more than a year they were engaged in a war, the origin of which is somewhat obscure, though it probably arose from the treachery of Licinius. After two battles, in which the Eastern emperor suffered severely, he was fain to sue for peace, which Constantine granted only on condition that Illyricum, Pannonia, and Greece should be transferred to his territory.

The peace lasted for nine years, a period during which Constantine's position grew stronger while that of Licinius grew weaker, wise and humane legal reforms and vigorous measures against the barbarians of the north marking the policy of the one, and caprice, indolence, and cruelty being the most conspicuous features in the conduct of the other. When the inevitable struggle for the supremacy came, though the army of Licinius was the larger, the issue was scarcely doubtful. The origin of the war which broke out in 323 is like that of the previous one in 314, not quite

clear; but it is probable that Constantine, having determined to make himself the sole master of the world, did not think it necessary to wait for provocation. The campaign was short but decisive. Licinius was totally defeated in a battle fought at Adrianople on the 3d July, 323. This was followed by the siege of Byzantium, in which Crispus, Constantine's eldest son, who was in command of the fleet, co-operated with his father by entering the Hellespont and defeating Amandus, the admiral of Licinius, after a two days' engagement. In a final battle fought at Chrysopolis (now Scutari) Licinius was totally routed, and he fled to Nicomedia. On the intercession of his wife Constantia, the sister of Constantine, the emperor promised to spare his life; but the promise was not kept. In 324 the defeated monarch was put to death by Constantine's orders at Thessalonica, which had been fixed as the place of his exile. A treasonable conspiracy was alleged against him, but there is no evidence in support of the charge; and possible danger in the future rather than any plot actually discovered seems to have prompted Constantine to a deed which cannot escape the censure of bad faith, if not of wanton cruelty.

With the war against Licinius the military career of Constantine may be said to have closed. He was now the sole emperor of both East and West. His enlightened policy had made his power throughout the empire so secure that any attempt to usurp it would have been utterly vain. Accordingly the remainder of his reign was passed in undisturbed tranquillity. The period of peace was not inglorious, including among lesser events the convocation of the Council of Nicæa (325) and the foundation of Constantinople (328). But unfortunately it was disgraced by a series of bloody deeds that have left an indelible stain on the emperor's memory. In 326 Constantine visited Rome to celebrate the twentieth anniversary (*vicennalia*) of his accession. During the festivities his eldest son Crispus was accused of treason by Fausta, and banished to Pola, in Istria, where he was put to death. Licinius, the emperor's nephew, being included in the same charge, likewise fell a victim, and a number of the courtiers also suffered. According to another version of the story, Fausta accused her step-son of attempting incestuous intercourse, and Constantine, discovering when it was too late that the accusation was false, caused her to be suffocated in her bath. The whole circumstances of Fausta's death, however, are involved in uncertainty, owing to the contradictions of the different narratives. The bloody tragedy struck horror into the minds of the citizens, and it was amid ominous indications of unpopularity that Constantine quitted Rome for the last time.

It had probably been for some time clear to his mind that the empire required in its new circumstances a new political centre. A Nova Roma would mark in a visible and concrete form the new departure in imperial policy which it had been the main object of the emperor's life to initiate. At least two other places—Sardica in Mesia, and Troy—had been thought of ere his choice was fixed upon Byzantium. No happier selection has ever been made. The natural advantages of the site are probably unsurpassed by those of any capital either in the Old or in the New World, and its political importance is evidenced by the frequency with which it has been the key to the situation in European diplomacy. The new capital, the building of which had been commenced in 328, was solemnly inaugurated on the 11th May, 330, being dedicated to the Virgin Mary. The fact that the ceremonial was performed exclusively by Christian ecclesiastics, and that no pagan temple was permitted to be erected in the new city, marks in an emphatic way the establishment of Christianity as the state religion.

The closing years of Constantine's life were uneventful. One of his last schemes was that for the partition of the empire after his death among his three sons by Fausta—Constantine, Constantius, and Constans; but it proved even less stable than the analogous scheme of Diocletian. In 337 Sapor II. of Persia asserted by force his claim to the provinces that had been taken from him by Galerius. Constantine was preparing to meet him at the head of an army, when he was taken ill, and after a brief and vain trial of the baths of Helenopolis retired to Nicomedia. Here he died on the 22d May, 337. The significance of his baptism on his deathbed by the Arian bishop, Eusebius of Nicomedia, will be indicated afterwards. His

body was taken to Constantinople, and buried according to his own instructions in the Church of the Apostles with imposing ceremony.

The most interesting and the most disputed subject in connection with the life of Constantine is the nature of his relation to Christianity. The facts bearing upon it are clear enough, and the controversy must therefore be entirely attributed to the manipulation and distortion of partisans. A brief statement of these facts will suffice to show how far his acceptance of Christianity was a matter of personal conviction, and how far, on the other hand, it was a matter of statesmanship. The generous conduct of Constantius towards the Christians betokens a certain measure of sympathy, and the term *Χριστιανόφρων* (Christian-minded) applied to him by Theophanes gives some ground for supposing that the paternal influence may have acted as a sort of *preparatio evangelica* in the mind of Constantine. But whatever may have been due to this, it did not bring him over to the new faith. His own narrative to Eusebius attributed his conversion to the miraculous appearance of a flaming cross in the sky at noon-day under the circumstances already indicated. The story has met with nearly every degree of acceptance from the unquestioning faith of Eusebius himself to the incredulity of Gibbon, who treats it as a fable, while not denying the sincerity of the conversion. On the supposition that Constantine narrated the incident in good faith, the amount of objective reality that it possesses is a question of altogether secondary importance. There is nothing improbable in the theory that accounts for the appearance of the cross by the not unfrequent natural phenomenon of a parhelion. It seems likelier, however, that Constantine gave external reality to what was nothing more than an optical delusion or a dream. Eusebius, it is true, narrates both the appearance at noon-day and a dream on the following night, in which the appearance was interpreted; but the very strength of the impression made on Constantine's mind may have led him to magnify the incident without conscious misrepresentation. Whatever the nature of the appearance may have been, its effect upon the emperor, to judge from his subsequent conduct, fell far short of a true or thorough conversion; it probably did not amount to more than the creation of a superstitious belief in the symbol of the cross. This is sufficient to account for the edict of toleration and for all his legislation that seems to be based upon sympathy with Christian ideas. On the other hand, the notion of conversion in the sense of a real acceptance of the new religion, and a thorough rejection of the old, is inconsistent with the hesitating attitude in which he stood towards both. Much of this may indeed be due to motives of political expediency, but there is a good deal that cannot be so explained. Paganism must still have been an operative belief with the man who, down almost to the close of his life, retained so many pagan superstitions. He was at best only half heathen, half Christian, who could seek to combine the worship of Christ with the worship of Apollo, having the name of the one and the figure of the other impressed upon his coins, and ordaining the observance of Sunday under the name *Dies Solis* in his celebrated decree of March, 321, though such a combination was far from uncommon in the first Christian centuries. Perhaps the most significant illustration of the ambiguity of his religious position is furnished by the fact that in the same year in which he issued the Sunday decree he gave orders that, if lightning struck the imperial palace or any other public building, "the haruspices, according to ancient usage, should be consulted as to what it might signify, and a careful report of the answer should be drawn up for his use." From the time of the Council of Nicea there are fewer signs of halting between two opinions, but the interest of the emperor in Christianity was still primarily political and official rather than personal. He summoned the council, presided over its first meeting, and took a prominent part in its proceedings both before and behind the scenes. The year before it met, he had, in a noteworthy letter to the Alexandrian bishops, urged such a scheme of comprehension as might include Arians and orthodox in the one church; and on this ground he has been claimed as the earliest of broad churchmen. When the result of its deliberations was the adoption, for the first time in the history of the church, of a written creed, he cordially approved of the proposal, and was thus the earliest to enforce uniformity by means of subscription. The two plans were incom-

patible, but the conduct of Constantine in supporting first the one and then the other was perfectly consistent. Throughout he acted in the interest of the state. The splitting up of the church into a number of bitterly contending factions would be a constant source of danger to the unity of the empire, while on the other hand the empire might gain fresh strength from the growing power of Christianity if that power were embodied in a compact and united organization. It was by this consideration, probably, that Constantine was guided in dealing with the Arian controversy; there are no traces of any engrossing personal interest on his part in the cardinal question of the *homoousion*. There are not wanting, indeed, several facts that show a real concern in the truths of Christianity as distinct from its social and political influence. Eusebius has recorded one of his sermons, and he seems to have preached frequently in refutation of the errors of paganism and in illustration and defence of the doctrines of the new faith. The same historian speaks of his taking part in the ceremonies of worship, and of his long vigils at the season of Easter. His delaying to receive baptism until he was on his death-bed does not imply that he delayed till then the full acceptance of Christianity, though it has frequently been so interpreted by those who were unaware that the doctrine that all sin committed before baptism was washed away by the simple observance of the rite not unnaturally made such procrastination very common. There is no historical foundation for the assertion of Baronius and other Catholic writers that the emperor received baptism from Pope Sylvester at Rome in 326. Equally baseless is the story of the so-called donation of Constantine, according to which the emperor, after his baptism, endowed the Pope with temporal dominion. It is to this that Dante alludes in his *Inferno* :—

Ab, Constantine! of how much ill was cause,  
Not thy conversion, but those rich domains  
That the first wealthy Pope received of thee.

It has been remarked by Stanley that Constantine was entitled to be called Great in virtue rather of what he did than of what he was. Tested by character, indeed, he stands among the lowest of all those to whom the epithet has in ancient or modern times been applied. Fearlessness, decision, political sagacity, and religious tolerance he possessed from first to last; but the generous clemency of which there are traces in his earlier years cannot have any longer worked effectually in him when he sanctioned the treacherous treatment of Licinius and the atrocities that connected themselves with the murder of Crispus. Tried by achievement, however, he stands among the very first of those who have ever won the title. In fact, there are two grounds at least on which as important a place may be claimed for him as for any sovereign who has reigned during the Christian era. What he did as the founder of the complex political system which exists among all civilized nations down to the present day, and what he did as the first Christian emperor, had results of the most enduring and far-reaching kind. It belongs to the historian of the empire to give a detailed account of the elaborate scheme he devised by which the civil functions of the state were separated from the military, and both from the spiritual,—the very idea of such distinctions having been previously unknown. The empire he by such means revived, though in the East it lasted a thousand years, was never again so strong as it was in his own hands; but the importance of his scheme consisted in this that it gave to empire itself, regarded as a system of government, a new structure and a new power which still survive in the political constitutions of the various nations of Europe. As to Christianity the historically significant fact is not his personal acceptance of it. It is rather that by his policy as a statesman he endowed the new religion for the first time with that instrument of worldly power which has made it—whether for good or for evil or for both is a subject of much discussion—the strongest social and political agent that affects the destinies of the human race.

The chief early sources for the life of Constantine are Eusebius, *De Vita Constantina*, which is strongly partial from the Christian standpoint of its author, and Zosimus, *Historia*, lib. ii., which is tinged by Pagan prejudice. Of secondary importance are Eutropius, Aurelius Victor, Laetantius *De Mortibus Persecutorum*, and the *Panegyrici Vereres*, vi.-x. The most valuable modern sources are Manso's *Leben Constantins des*

Grosven (1817), Burckhardt's *Die Zeit Constantins des Grossen* (1853), and Broglie's *L'Eglise et l'empire romain du I<sup>er</sup> siècle.* (W. B. S.)

CONSTANTINE, a Roman soldier, who, in the time of Honorius, in the 5th century A. D., rose to the dignity of emperor of Gaul, Spain, and Britain, but was finally conquered and put to death by Honorius.

CONSTANTINE VII., FLAVIUS PORPHYROGENITUS (906-959), emperor of the East, author, and patron of literature, born in 905 A. D., was the only son of Leo VI. The Eastern Church sanctioned no marriage beyond the second, and when Leo, being childless by three wives, had a son by his concubine Zoe, his attempt to legitimize his wife and son was inflexibly resisted by the Patriarch Nicholas, and his will was only carried out at the expense of excommunication. These circumstances were probably the reason why the name *Porphyrogenitus*, "born in the purple," i. e., in the purple chamber in which the empresses were confined, was, while applicable to all the emperors, emphatically applied to Constantine VII. When Constantine was only six years old Leo died, leaving him under the guardianship of his uncle Alexander; but Alexander also died in the next year; and Romanus Lecapenus, the chief admiral, supported by Zoe, was appointed colleague to Constantine, and held all real power till 944, when he was forced by his sons to enter a monastery. Meanwhile Constantine, though powerless, had been well treated, and had married Helena, the daughter of Romanus. On the deposition of his colleague, the people gave willing aid to Constantine's cause; and having banished his brothers-in-law, he became emperor in reality. Though wanting in strength of will, Constantine had intelligence and many other good qualities, and his reign on the whole was not unsatisfactory. (See GREEK EMPIRE.) He was poisoned by his son Romanus in 959. Constantine was a painter and a patron of art, a literary man and a patron of literature; and herein consists his real importance. Unable as he was to sift out the really important from the unimportant, and the credible from the incredible, it is yet from his pages that we gain the only knowledge of any extent which we possess of his time. He is the author of several works of considerable size:—1. *Περὶ τῶν θεμάτων*, an account of the provinces (*themata*) of the empire; 2. *De Administrando Imperio*, an account of the condition of the empire, and an exposition of the author's view of government, written for the use of his son Romanus; it also contains most valuable information as to the condition and history of various foreign nations with which the Eastern empire had been brought into connection,—as the Arabs, Iberians, Armenians, and the tribes north of the Danube—the Russians, Bulgarians, Hungarians, Chazars, and Patzinacite; 3. *Ἐπιτομὴ τῆς βασιλείου τάξεως*, which describes the customs of the Eastern Church and court; 4. A life of Basilus I., his grandfather; 5. Two treatises on warfare, of which his father Leo was perhaps part or sole author. The *Γεωπονικά*, a treatise on agriculture with which his name is connected, is generally supposed to have been executed at his command by Bassus Cassianus; and under his patronage many other works—including collections of the ancient historians (of which fragments are extant); lives of saints, and treatises on medicine—were compiled. Several Latin translations of the works of Constantine have been made, and his complete works were published at Leyden, 1617, and Paris, 1711.

CONSTANTINE PAVLOVICH (1779-1831), second son of the Czar Paul I. of Russia, was born at St. Petersburg on the 8th May, 1779. His name was chosen by his grandmother, the Empress Catherine, on account, it was believed, of the tradition according to which an emperor Constantine was to reign at Constantinople. At the age of seventeen the prince was married to the Princess Juliana of Saxe-Coburg, but after four years a separation took place. In all affairs connected with the army Constantine took the intensest interest. In 1799 he served in Italy, and he gained distinction at the battle of Austerlitz (1805) by the admirable order in which he retreated. He also served throughout the rest of the war with France, but never held supreme command. In the end of 1815 he was appointed generalissimo of the army of Poland. His rule was marked by an unreasonable severity, which produced deep and general discontent; but he introduced the strictest discipline. Though not nominally head of the Government, Constan-

tine's influence was very considerable; and it was all employed in support of arbitrary principles. He abolished the liberty of the press, and any literary man or student who expressed any opinion obnoxious to him was immediately thrown into prison. On the other hand he did much to carry out many material improvements. In 1820, having fallen in love with a Polish lady, he obtained through the influence of the emperor, his brother, a decree of the Holy Synod permitting him to marry the lady; and in return he signed a paper resigning all claim to the succession to the throne. On the death of the Czar Alexander in December, 1825, Nicholas, Constantine's younger brother, and after him heir to the throne, refused to allow himself to be crowned; but Constantine remained true to his promise, and though a conspiracy of the officers of the army in favor of a constitution took place, and the conspirators proclaimed Constantine czar, he persisted in supporting his brother, at whose coronation he appeared to take the oath of homage. After this Constantine's power in Poland became greater than before; his system of espionage and arbitrary government was more harshly put in force, and arrests without any specified charge became more common. At length in 1830, that year of revolutions, the general hatred of Russia burst into a rebellion. Some of the conspirators entered the prince's palace at Warsaw; but, the Polish guard remaining faithful, he escaped. He was, however, forced to release all Polish political prisoners, and to declare his intention of not calling in the Russian army to attack Poland. His Polish guard now requested liberty to rejoin the rest of the army. After granting permission, he withdrew it, and the guard deserted him. He was, nevertheless, allowed to reach the frontier in safety. In the consequent war Constantine took no important part, and after a time even the inferior command which he held was taken from him. The czar refused to allow him to live near St. Petersburg, and the place of his residence was fixed at the little town of Bialystok, on the border line of Poland and Lithuania. He died on the 27th June of the following year (1831).

CONSTANTINOPLE, the capital of Turkey and of the Ottoman empire, is situated at the junction of the Bosphorus and the Sea of Marmora, in 41° 0' 16'' N. lat. and 28° 59' 14'' E. long. It may be said to stand upon two promontories rather than upon two continents, since the quarter now called Galata was reckoned in the time of Arcadius the 13th Region, whereas Kadikeui (Chalcedon) and Iskudar or Scutari (Chrysopolis), situated on the opposite coast of Asia Minor, have been always distinct cities. The promontories on which the capital lies are divided the one from the other by the last and largest of those inlets which cut the western shore of the channel known as the Bosphorus. This inlet is a large and important harbor, running from east to north-west, capable of floating 1200 ships. It curls up in a course of little more than four miles to the foot of the hills which, joining the heights on either side, seem to form a vast amphitheatre, till it meets the united volume of two streams—the Cydaris and Barbysus of the ancients—the two whelps of the oracle,—

"Bless'd they who make that sacred town their home

By Pontius' mouth upon the shore of Thraee,

There where two whelps lap up the ocean foam,

Where hind and fish find pasture at one place."

This peculiar harbor has always, by reason both of its form and its fulness, been called the Golden Horn. It is "like a stag's horn," Strabo says, "for it is broken into wavy creeks like so many branches, into which the fish pelamys (*πηλαμύς*) running is easily snared." In former times this fish was, and at the present day might be, a source of rich revenue—ever from time immemorial rushing down from the Sea of Azoff and the Black Sea, and when it approaches the white rock, on which stands the Maiden's (miscalled Leander's) Tower, glancing off it, and shooting straight into the Horn, but never enriching the rival city on the coast of Asia—Chalcedon, "the City of the Blind." If the figure of a stag's horn resembles the harbor, that of an ancient drinking-horn would represent the general form of Constantinople proper—the Seraglio point being turned inward like the sculptured mouth-piece. On this knot the Megarian city stood gathered about its Acropolis, and occupying the easternmost hill on the verge of Europe. Constantine aimed at building his new capital, after the old, on seven hills; his wish was fulfilled—not at first however, but a century after its dedication,—and he wished

it to be in name, as in foundation, a counterpart of the ancient city. But it is the founder, not the model, that is commemorated in the name *Constantinople*, while its designation as "New Rome" lingers nowhere but in the official language of the Orthodox Eastern Church. Its Turkish name of *Istamboul*, or *Stamboul*, is said to be a corruption of the Greek words *εις την πλιν*. About the end of the 18th century it was corrupted by a fanatical fancy into *Islambol*, or the city of *Islam*. Like the name, the emblem also of the city was adopted from the Greeks by the Ottomans. The crescent and star formed its device from the earliest times, and is found on Byzantine coins and on the statues of *Hecate*. So the body-guard of the Sultan retain *insignia* of the Varangian Guard of the Greek empire, of which traces seem to have been discovered in the Crimea. The sign-manual of the sultans, rudely representing a left hand, originated with the action of a sultan who is said to have signed with a bloody hand a treaty with the republic of *Ragusa*.

Under *Constantine*, who founded it on the site of *BYZANTIUM* (*q. v.*), the city was more than doubled. His forum was fixed on the second hill; the walls were extended till a new inclosure was made, which spanned the peninsula from about the end of the old bridge to the mouth of the River *Lycus* in *Vlanga Bostan*; the line of his walls was not direct, but made a compass round the *Polyandron*, or *Heroon*. It is said that 40,000 Goths were employed in first raising and afterwards manning these works; the seven gates separated the eight cohorts, each of 5000 men. Being *Arians*, the Goths were allowed no room within the city which they made safe for the Orthodox, but had assigned to them a quarter outside, which was called, either from several columns or from the one of *Constantine* that stood thereabout, *Exocionion* (the region without the columns), and the Gothic inhabitants of the quarter were styled *Exocionites*. So noble was this body or guild accounted among their countrymen, that many illustrious Goths were enrolled in it,—with others, the kings of Italy. In the course of time, after *Anastasius* had drawn a longer line of defences higher up, from the neighborhood of *Lake Dercon* on the *Euxine* to *Selymbria* on the *Propontis*, and many of the Gothic cohorts were called away to defend these fortifications, the meaning of the name was by degrees forgotten, until it was changed into *Hexe-Kionia*, or *Hexe-Marmora* (six marble columns); and at last this corrupt form was rendered literally by the new occupants in their tongue *Abi-Mermer* (six columns), which name remains to the present day. As this is a landmark showing the limit of *Constantine's* walls on the south, another sign is extant bearing witness to their extent on the north. This is a mosque, once a church, which is visible from the *Golden Horn*. Its Turkish name, *Kahireh*, or *Kahrieh*, is thought to have been formed into a resemblance of that of the capital of *Egypt* from the Greek *χώρα*. The monastery to which this church of the Saviour belonged was *Μονὴ τῆς χώρας*, or, as we say, "in the fields." This was an ancient establishment, and its church, the oldest church in the city, dates from the 3d century. Hither were brought, and entombed in sarcophagi, the remains of *St. Babylas* and two other martyrs who suffered under *Decius* in the persecution of 250 A. D. At the beginning of the 5th century the Goths, being pressed by *Attila* and his Huns out of their settlements below the *Balkan*, flocked towards *Constantinople* to join their countrymen there and find refuge in its suburbs. It then became necessary to entrench this extra-mural camp. Accordingly in 412, under *Theodosian* walls. *Theodosius II.*, the first *Theodosian* wall was raised by the prefect *Anthemius*; and in 447 a second was added by the prefect *Cyrus Constantinus*, who advanced the fosse, and of the earth dug out of it formed an artificial terrace between two lines of defence. The Goths were long subjected to exclusion from the city; *Justinian* exempted the *Exocionites*, indeed, from the penalties which he exacted from all other *Arians* in the empire, but required them still to meet for public worship outside the walls. Some monuments to members of the body of *Federati*, found outside the fifth gate, and perhaps the name *Cerco-porta*, a memento of their round church, or one of their circular forts, may mark the residence, as they intimate the heresy, of the noble guards of the Greek emperor. *Arianism* had died out when this body was reinforced by the *Varangians*—*Anglo-Danes*—in the 11th century; ac-

cordingly, it is not surprising to recognize in a *Byzantine* church in a quarter called *Bogdan-Serai*, within the walls on the fifth hill, the church of *St. Nicholas* and *Augustine*, founded by an *Anglo-Saxon* who fled from the *Normans* to take service under the Greek emperor. It is maintained that most of the numbers distinguishing the cohorts attached to the several regions and walls remain to this day, as *Deuteron*, *Triton*, *Pempton*, and *Hebdomon*. Upon the completion of these *Theodosian* walls there ensued a double arrangement of gates; town-gates, communicating with the public roads, alternated with military gates which opened upon the terraces only. These town-gates, to the number of seven, communicated with the seven gates of *Constantine's* wall each by a broad street, which separated the cohorts and their quarters. These gates were opened in peace but shut in time of war, and then the bridges connecting them with the country roads and crossing the fosse in front were taken down at the approach of the enemy. The military gates had no such bridges leading from them; they served only to give egress to that part of the garrison which was required to work the engines of war planted upon the terraces outside and below. The city gates in the *Theodosian* walls had for the most part the same names as the gates in the wall of *Constantine* which corresponded to them—with this difference, that they were styled "New." Thus the gate "Roussion," so named from the "demus" of the "Rede," in the latter, answered to the "New" Roussion in the former. It is on this account that the existing gate is to this day called *Yeni Kapu* (*New gate*) as well as *Mevlaneh Kapusi* (gate of the *Dervishes*). The gate of *Adrianople* (*Edreneh Kapusi*) was formerly that of *Polyandron*, and took its title from the corresponding gate in the wall of *Constantine*, called so because it stood near the *Polyandron* or *Heroon* adjoining it, which was attached to the church of the *Holy Apostles*; the site is now occupied by the mosque of *Mahomet* the conqueror (*Mehmedieh*).

The landward walls of *Constantinople* bear marks of the labor of many hands, and represent different and distant epochs.<sup>1</sup> Their construction is unique. If the

<sup>1</sup> At several points these walls have been repaired and restored, and display the names of "rois constructeurs" from *Theodosius* to *John Paleologus*. They may be described roughly as four lines drawn across the promontory which they inclose for the distance of about four English miles, and knotted at each end into a citadel. The work at each extremity is more recent than what intervenes—that near the *Sea of Marmora* is to this day almost perfect; and the *Golden Gate* remains with its flanking towers of marble, much as it appeared in the 5th century, and fronted by the smaller arch which has generally appropriated the name. Of the five towers at the other end near the *Golden Horn* some remains exist, viz., the tower of *Anema* and that of *Isaac Angelus*. On the north side the wall of *Theodosius* breaks off at the palace of the *Hebdomon*, and the continuous fosse ceases where a later line has been thrown out with massive towers—this is the wall of *Heracellus*, supposed to have been raised to protect the imperial quarter of *Blachernae*, containing the palace of that name and the church of *St. Mary*. Similarly a second wall was constructed to cover the church of *St. Nicolas*, in the time of *Leo the Armenian*, whence it is called the *Leontine* wall. This line of defence, long impregnable, withstood siege after siege till the new artillery made three great breaches—the first between *Tekfur-Serai* and *Edreneh Kapusi*; the second near the fifth military gate—that of *Charisius*, in the valley of the *Lycus*; and the third between *Selymbria* gate and *Mevlaneh* gate.

The walls on the western or land side of the city are connected with the continuous line which defended it on the two sides that face the water, and which, with a few breaks, is still standing. That part which runs parallel with the *Golden Horn* is varied in *Balata* by the insertion of an arch, still preserving a *Victory*, and by a pier now lying far back on the strand; built first by *Zeno*, it displays on its successive towers the names of *Michael* and *Theophilus*. The other part which turns the point shows the same names, but differs widely here and there in construction from the portions across the land and by the *Horn*, being formed so as to receive the beating of the waves indirectly, and strengthened with shafts of marble so as to resist most effectually the corrosive action of sea-water. This contrivance is especially to be noticed between *Vlanga* and *Ahor-Kapusi*, and shows the foresight of the builders; the great tower which locks the sea-wall with the land walls is one mass of marble,—on the other hand the land walls are constructed for the most part of marble or stone and brick alternately, to resist more easily, as it has been supposed, shocks of earthquakes. In tracing the course of the sea-wall from the *Acropolis* to the *Seven Towers*, the sites of all and the ruins of some of the following places have been noted in order:—the *Orphanotrophæum*; the churches of *St. Demetrius*, *St. Barbara*, and the *Hodegetria*; the *Porta Carea* (corrupted into *Karacapu*) beyond the palace and harbor of *Boucoleon*; the imperial palace; the *Porphyry Chamber* (the origin of the epithet "born in the purple"); the palace of *Hormisdas*; the churches of *Sta. Sergius* and *Bacchus*; the *Portus Julianus* and *Sophianus*, now *Catara Limna*, with the *Sophiana Palace*; the *Contoscallum*, *Koum-Capu*; the harbor of *Theodosius*—outer and inner—now a garden called *Vlanga Bostan*,—its mouth flanked by two noble towers joined by a wall before the last siege; the harbor of *Emilianus*; *St. John of the Stradum*; and at last the citadel called *Heptapyrgion*, the *Seven Towers*. The entire circuit of the walls is about 18 miles.

outer defence of the fosse is reckoned they are quadruple; the two inner lines are furnished with a series of towers, the smaller below, the larger above—round, octagonal, or square—at about 50 feet apart. As the gaunt array of castles droops into the valley, or seems to climb the hill beyond, one may decipher some of its now obscure inscriptions on marble or in tile work (one seems to be a prayer to Christ), and wonder at the contrivance which appears to defy a natural law. The great ditch, now a productive vegetable garden, is divided into a number of compartments or open cisterns, which used to be filled with water brought by pipes, carried along each partition wall, and furnishing the supply from cisterns from within and without the city.

Equally remarkable with these fortifications is the system of large cisterns, which are said to have furnished water to 1,000,000 men during four months; they were a necessity to a city subject to perpetual assault. One seems to have been annexed to every considerable monastery and palace—imperial and patrician. They may be reckoned the more ancient portion of the city, which is thus subterraneous—for while the buildings above ground are scarcely any of them, in the condition now visible, older than the time of Justinian, the cisterns that can be distinguished date from the times of Arcadius, Theodosius, and Constantine.

The position assigned to the old imperial palace is, generally speaking, that of the mosque of Ahmed, which adjoins the Hippodrome. It was not one large edifice, but a scattered group of buildings within gardens, spreading to the Hippodrome on the one side, and on the other to the sea-shore; the northernmost point of its inclosure reached the site occupied now by the fountain of Ahmed III., then by the Geranium. This palace was gradually abandoned after the 12th century for that of Blachernæ within the Horn. It was separated from the church of St. Sophia by the Augusteum—the square in which stood the statue of Justinian looking towards Persia, the Milliarium, and among other monuments the column that bore the silver statue of the Empress Eudoxia, which occasioned the remonstrances of St. Chrysostom. Mahomet II. built his new palace (the seraglio) on the site of the Acropolis, about which ancient Byzantium had clustered, a situation specially favorable to his purpose, as it afforded the combined advantages of a lovely prospect, a perfect retreat from the noise of the city and a facility for observing all the movements in the harbor. In erecting it he followed the three divisions of the palace of the Byzantine emperors—(1) the *Chales*, the defensive part held by the guards; (2) the *Daphne*, which touched the Hippodrome and was used for receptions; and (3) the private chambers occupied by the imperial household. The three corresponding portions of the Ottoman palace are distinguished by their several gates:—(1) *Babi Houmaïoum*, the Imperial Gate, opening into the court of the Janissaries; (2) *Orta-Kapusi*, Middle Gate, in which the sultan receives on high festivals; and (3) *Babi Saadet*, Gate of Felicity, where he formerly received ambassadors. Of late years the sovereign has resided in winter at Dolma-bakcheh, or Tcheragan; in summer at Begler-beg on the Asiatic shore, or at some inland kiosk.

The main streets of the Stamboul of the present day follow the lines of the city of Constantine; thus the tramway, which turns from the New Bridge towards Serai Bournou, upon reaching the platform of St. Sophia, enters upon the direction of the *Méon* (Mése, middle street), now called Divan Yoli. The Mése parted into two branches, of which the one went to the gate Rousson, or new gate, the other to the Polyandron. On the north of the middle street one branch passed along the shore of the Golden Horn from the place where the railway station is, and issued at the gate Xylocircus near Balata. On the south, another street passed through the two Golden Gates. These three main lines were distinguished from the smaller tortuous streets by their adornment as well as by their breadth. They were bordered by rows or covered ways and arcades called *εμβολαί*, some of them double, with pavements above, decorated with statues, &c. A few traces of the *emboli* still remain *in situ*, just as there are fragments of the ancient bazaars, khans, and baths. Imperial gates closed the lines of these principal thoroughfares.

The following is an outline of the modern city, divided according to the seven hills and the intervening valleys.

On the 1st hill, the most easterly, are situated the remains of the Seraglio, former palace of the Ottoman sultans; the great church-mosque St. Sophia; St. Irene; the imperial mint; the Atmeidan (Hippodrome), with three of its numerous monuments remaining; the mosque of Ahmed, &c. Along the 1st valley are traced the walls of the Seraglio on the west, made up of ancient materials, and the *Babi Ali* or Sublime Porte. The tramway runs along this valley. On the 2d hill stands the Burnt Column, that of Constantine the Great (which stood in the centre of his forum, and under which are said to be the instruments of the Crucifixion and a Palladium of Troy), and the Mosque of Osman. The 2d valley is occupied by bazaars, several khans, and the mosque of Valideh Sultan, or *Yeni Jami*, overlooking the bridge and the head of the tramway. On the 3d hill are the *Seraquierat* (War Office) on the site of the cemetery of the Byzantines and the forum of Theodosius; the fire-tower, and the mosque of Suliman. Along the 3d valley is carried the Aqueduct of Valens, built out of the walls of Chalcedon destroyed for the citizens' rebellion; near it is *At-Bazar* (horse-market). On the 4th hill rises the mosque of Mahomet II., where stood the church of the Holy Apostles and the church of the Pantocrator. South of this mosque, in a garden, is seen *Kiz-tash*, the Maiden's Column, or column of Marcian, once that of Venus. On the 5th hill follows the mosque of Selim, on the edge of a large open cistern, south of which is the covered cistern of Arcadius. Below on the north lies the *Phanar* (so named from a lighthouse), the Greek quarter which reaches to the Golden Horn. This division includes the church of the Patriarchate, the great school of the Greek nation, the church-mosque *Fetiye Jamsi* (Pammacariou), and the church of the Mongols (*Mougloutissa*). The 6th hill is distinguished by the palace of the Hebdomon, with its coronation hall, built, it is said, by Constantine I., and known vulgarly as *Tekfur-Serai*—palace of the lord (*τοῦ κυρίου*). At its foot appears the church-mosque *Kahrieh*, or *Kahireh*, formerly *Monetes Choras* (*Μονητῆς χόρας*). Below this hill, the quarter called *Balata* from *Palatium*, now occupied by Jews, follows the *Phanar*, then the ancient suburb of *Blachernæ*. Here are seen some remains of the Pentapyrgion,—five towers used by the Greeks of the Lower Empire as a political prison. This quarter is succeeded by *Eyouh*, celebrated for its mosque—which no Christian may enter—and for its cemetery. In this quarter, after Greek precedent, the sovereign is invested. On the hill near, in the *Cosmidion*, the first crusaders pitched their tents. The 7th hill is to be looked for in the most southern corner of the city. It is occupied by the fortress of the Seven Towers, the political prison of the sultans. It is isolated by the River Lycus.

Of the ecclesiastical buildings of Constantinople by far the most important is the Mosque of St. Sophia, or *Aya Sofia Jamsi*, which ranks as perhaps the finest example of the Byzantine style. In striking contrast with the nobler specimens of Gothic architecture, it presents from the outside an uncouth and disproportionate appearance, even the effect of its unusual dimensions being destroyed by its lack of symmetry. But within the visitor cannot fail to be impressed by the bold span of the arches, and the still bolder sweep of the dome, while his eye is at once bewildered and charmed by the rich, if not altogether harmonious variety of decoration, from the many-colored pillars down to the mosaics and inscriptions on the walls. The dome is raised at the centre 180 feet above the ground, and has a diameter of 107 feet; its curve is so slight that the depth is only 46 feet, and round the rim it is relieved by a row of forty windows. The arrangement of the building may be understood from the plan on page 273; and the magnificent volumes of *Fossati* and *Salzenburg* furnish all that can be desired in the way of views of the different parts of the interior. The first stone of St. Sophia, or the Church of the Divine Wisdom, was laid in 532 on the site of several successive churches of the same name, the first of which had been erected by Constantine the Great. Anthemius of Tralles and Isidorus of Miletus were the architects employed by the emperor Justinian, at whose command the enterprise was commenced. No fewer than 10,000 workmen are said to have been engaged under the direction of 100 master builders; and when the work was completed it had cost the imperial treasury about

£1,000,000. The principal material of the walls was brick, but the whole interior was lined with costly marbles; and to add to its splendours the temples of the ancient gods at Heliopolis and Epheus, at Delos and Baalbec, at Athens and Cyzicus, were plundered of their columns. To render the dome as light as possible it was constructed of pumice-stone and Rhodian bricks, and to secure the building from the ravages of fire no wood was employed except for the doors. Not long after its completion the dome was shaken by an earthquake, but it was repaired by Isidore, the grandson of the original architect. In 1453 Mahomet converted the church into a mosque, and since that date numerous minor alterations have been made in the less essential parts of the building.

A pretty complete restoration was effected in 1847-49 by Fossati, who found that the weight of the dome was too great for the supporting walls, threatening the whole with destruction.<sup>1</sup>

The most remarkable of the church-mosques, besides St. Sophia, are the following:—(1) *Kutluk Aya Sophia*, the original model of the great church. It was built for Justinian before his accession, and dedicated to martyrs of his own Illyrian race—St. Sergius and Bacchus. The lower stage is the original fabric. Here, according to Mahometan tradition, Messiah appeared among the worshippers. (2) *Pantocrator* (the Almighty), now Zeirek Jamisi, a triple church of the Comneni. Its monastery became the headquarters of the

Church-mosques.

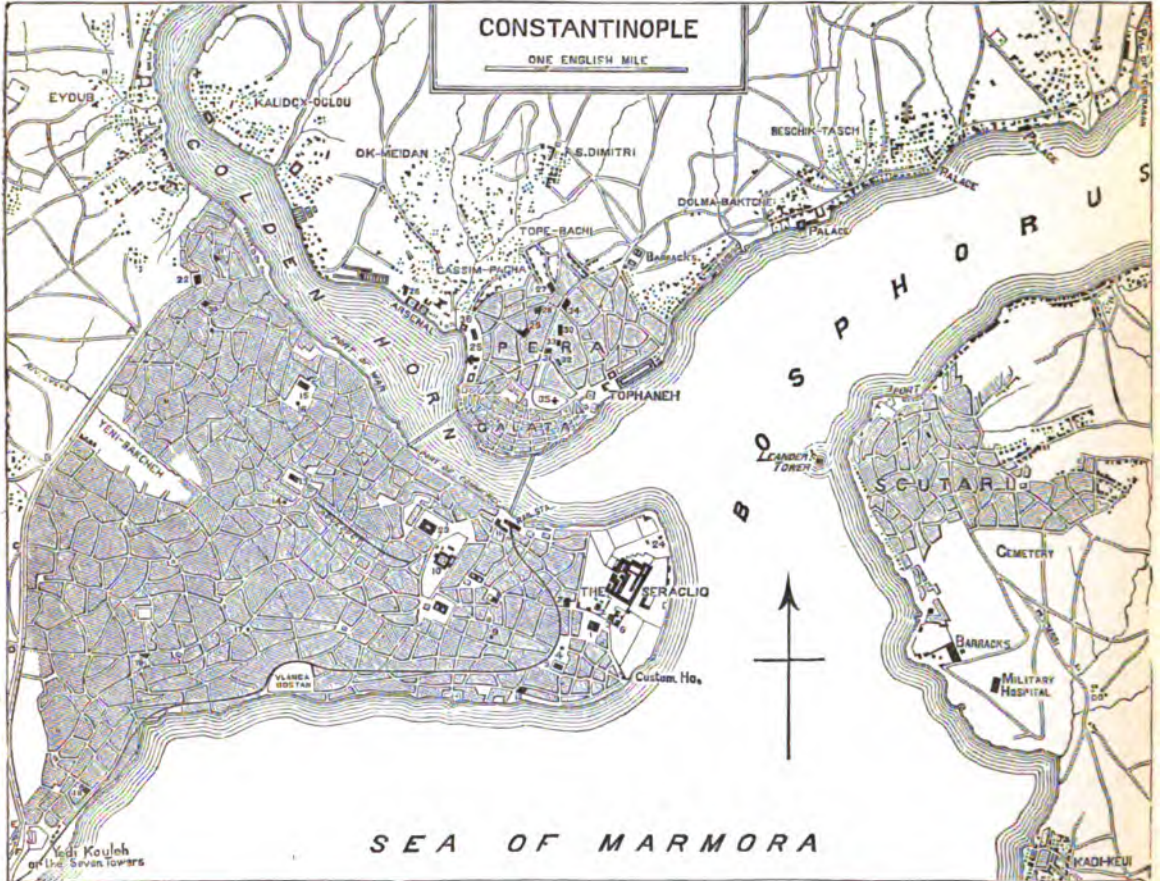

1. St. Sophia.
2. Mint.
3. St. Irene.
4. Atmeidan (Hippodrome).
5. Mosque of Sultan Ahmed.
6. Babi Humaioum.
7. Babi Ali (Sublime Porte).
8. Mosque of Sultan Osman.
9. Porphyry Column (Burnt Column).
10. Seraskierat (War Office).
11. Mosque of Valideh Sultan.
12. Kutchuk Aya Sophia (Little Sophia).

13. Mosque of Mahomet II.
14. Kiz Tash (Column of Marcian).
15. Mosque of Sellin.
16. Cistern of Arcadius.
17. Column of Do.
18. Emer-ahor Jamisi (St. John of the Studium).
19. Mosque of Exi Marmora.
20. Kahireh Jamisi (Church of the Saviour).
21. St. Mary of Blachernæ.
22. Blachernæ Palace.

23. Mosque of Sullman.
24. Column of Theodosius.
25. Naval Building Basin and Barracks.
26. Naval Hospital.
27. English Embassy.
28. German Do.
29. Dutch Do.
30. French Do.
31. Swedish Do.
32. Russian Do.
33. Austrian Do.
34. Galata Palace.

35. Crimean Memorial Church.
36. Divan Haneh (Admiralty).

GATES.

- A. Edreneh Kapual.
- B. Top Kapual.
- C. Yeni Kapu or Mevlaneh Kapual.
- D. Selymbria Kapual.
- E. Yedi Kouleh Kapual (Seven Towers).
- F. Golden Gate.

Latin in the 13th century. (3) *St. John of the Studium*—Emer-ahor—a basilica. Here was the famous monastery of Acemeti (watchers) and a school of church poets. (4) *The Church of the Saviour*, with the monastery of the Chora, as being not only *ἐν τῇ χώρῃ* ("in the fields,") but *ἡ χώρα τῶν ζῶντων* (the land of the living), a gem of beauty still, even in its decay, rich with mosaic of the 14th century of a style purer and more refined than that which is more often seen and admired at Ravenna and Palermo. In this church, alternately with the Hodegetria, was kept the Holy Robe of the Virgin, which was wont to be carried in procession when the walls were threatened, and with which the patriarch Photius is said to have scared away the first Russian fleet which came against the city down the Bosphorus in the 9th century. (5) *Pammacaristou*—Fetiyeh Jamisi. The Greek patriarch moved hither from the

Church of the Holy Apostles which had been assigned him. One dome of this church is still full of mosaic work.

The mosques of Constantinople are reckoned variously 1 The churches of Constantinople in 1202 were, according to Alberich, 500. Of more than 50 the remains or the sites have been identified. Six of these are in the possession of Christians,—five being held by the Greeks and one by the Armenians. The five churches are (1) Mouglioutissa (Mongolian); (2) St. George of the Cypress in Panathia; (3) the Ayasma (holy well) of St. Mary in Blachernæ; (4) the Ayasma of the Sleep of St. Mary, between the mosques Zeirek and Vefa; (5) the Ayasma of St. Therapios (a Cyprian martyr) in the Seraglio wall near Pasha Kapual. The church indicated as given to the Armenians is Perioleptou (Soulon Monastir). Possibly another church similarly transferred might be named, in Balata, to which a monastery was annexed. Three other churches, though not turned into mosques, have passed out of the hands of the Christians—St. Irene, Sta. Nicolas and Augustine, and St. Juliana. In the sea-wall of the Seraglio gardens in the eastern entrance of another church—perhaps St. George of the Mangana; to the north, is the Ayasma of the Saviour.



from 350 to 500, mesjids (chapels) included. Many of them retain the materials as well as occupy the sites of ancient churches. The great mosque of Suliman was chiefly built of the remains of the church of St. Euphemia at Chalcedon, where the fourth Ecumenical Council was held, 451. This church stood above the valley of Haidar-Pasha, near Kadikeni; an ayasma belonging to it stands near the railway terminus at a little distance from the shore. The imperial mosques, that of Eyoub included, are nine in number. Most of them stand on high ground; and, with the harmonious contrast of dome and minaret, they offer to the eye a more pleasing view than the Christian churches of the past. The hills may be counted as these lordly structures follow in stately order, and the monuments of Osman, Suliman, Mahomet, and Selim seem to repeat the form fixed on the first hill by the architects of Justinian; and on high festivals their soaring minarets,

were rolled up to the crest of the hill and then down on the other side to the inlet below Kassim-Pasha, on the edge of which the Divan-Haneh (Admiralty) now stands. Before reaching the point of intersection this street, called Koumbaraji Sokak (street of bombardiers), passes beside the elegant English Church (Crimean memorial church) which was consecrated under the name of Christ Church in 1868. The great tower of Galata, like that of the Seraskierat (War Office), on the opposite height in Stamboul, is used as a fire-tower. In the times of Genoese occupation it was the main castle or keep of the town; it was heightened, not founded, by those settlers from Italy. The original tower was built about the end of the fifth century by the emperor Anastasius Dicorus. Since that time it communicated with another huge tower (long ago destroyed), which stood near the site of the present terminus of the Adrianople Railway in Stamboul,—the tower of Eugenius. It was joined to this tower in time of war by an iron chain laid across the Golden Horn to keep out enemies' ships, while a similar chain, fastening the tower of Eugenius to a fort replaced now by the Maiden's tower (miscalled Leander's), barred the passage of the Bosphorus. From the tower of Galata there spread out, as spokes from an axle, some three or four lines of wall, which ran downward till they met on the right the line which guarded the quays, on the left a sweeping line which embraced that extension of the town which had crept along the shore as far as the modern Tophaneh. The inner line, which unequally divided the quarter that lies between the bridges, was double. Some portions of this and of the others still exist, with towers and gateways; but of the numerous tablets visible upon them when they were standing, two only remain in their original place. Below the double wall, which gave passage to troops from the great tower to the seaward wall, stands the remarkable mosque called Arabjamisi (Saracen's mosque). Its form and contents serve as a record of the history of Galata. Its minaret, unlike the minarets of Turkish mosques, is square, recalling the Moorish towers of Spain. Remains of Genoese monuments on its floor and in the outer court testify to its Christian use. Originally a Mahometan place of worship, it is not orientated, nor has it an apsidal termination. It is said to have been first built for the Arab colony that lingered here since the invasions of Constantinople by the Arabs. When Galata, already occupied by the Genoese at the commencement of the 13th century, was, from motives of gratitude or of policy, given up entirely to that colony of daring merchants by Michael Palæologus on his recovery of the city from the Latins, this mosque became their chief church; but when, nearly two centuries afterwards, the Ottoman Turks became masters of Constantinople, it reverted to its first purpose, and Christian worship gave way to Mahometan. Besides the great tower and some ruins of walls and towers, the massive blocks of building that are now banks and merchants' offices, the palace of the podestà, the Lombard church known as St. Benedict's, which is

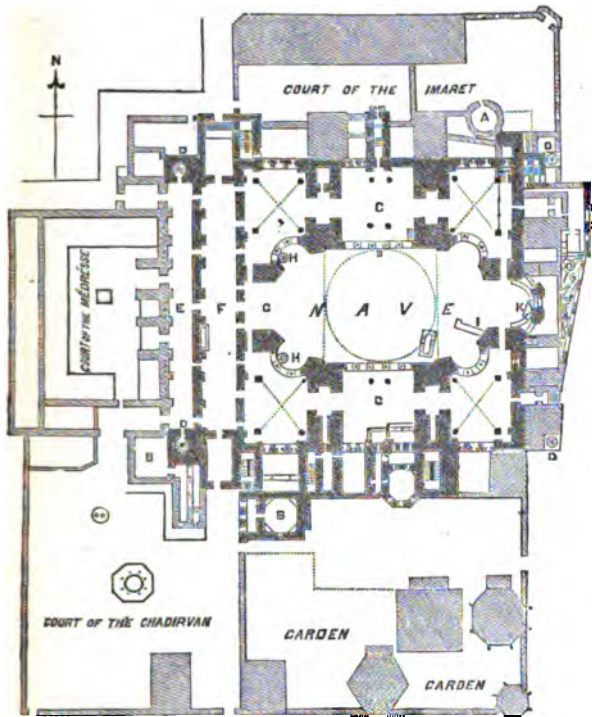

Plan of Mosque of St. Sophia.

- A. Ancient Baptistery.
- B. Ancient Baptistery.
- C. The Side Galleries.
- D. The Four Minarets.
- E. F. 1st and 2d Porch or Narthex.
- G. Front Gallery.
- H. Formerly the Emperor's and Patriarch's seats.
- I. The Mihrab, where the Koran is kept.
- K. Formerly the Altar.

more airy than the campaniles of the West, and beaming with festoons of light, shine out like beacons over the neighboring waters.

**Galata and Pera.**—Along the north shore of the Golden Horn spreads the quarter known as Galata, rising up to the crest of the hill and including the massive tower which crowns it. Beyond and above Galata, Pera stretches forward along the ridge that runs parallel with the shore. Both these quarters are chiefly inhabited by Christians, native and foreign. Galata is the seat of commercial establishments, Pera that of the diplomatic bodies. At the foot of the great tower of Galata is gathered a cluster of English institutions,—the consulate, consular court, consular prison, seamen's hospital, post-office, and sailors' home. Several institutions, native and foreign, have been established of late years in Pera. The main street which connects these two quarters winds up from the outer bridge. A little beyond the Municipality House it is crossed by another near the point where it separates the Russian Embassy from the Hotel d'Angleterre; hence the Greek name of Pera *Σταυροδρόμιον* (the cross roads). This street, rising tortuously from above Tophaneh, is said to have been formed by the track of Manomet's fleet of boats, which

at this day a centre of French philanthropic and religious works, are existing memorials of the settlements of those Genoese merchants, the active and successful rival of the Pisans and Venetians,—whose proper quarters lay at the foot of the tower of Eugenius, now within the Seraglio wall—and the ancestors of the enterprising merchants of later times who are known and respected as the Greeks of the island of Scio. The names Pera and Galata have not always been restricted to their present limits. *Pera*, like *Peræa*, is Greek, designating the region over the water, and was naturally employed as from Constantinople to mark that quarter of the city which lay on the other side of the Golden Horn. The name was accordingly first given to the lower portion of the town, now called Galata and formerly Syçæ (the fig-trees). This quarter of the city was enlarged and adorned by Justinian, but before his time, under Arcadius, it was reckoned one of the regions of Constantinople. The ground which it covered seems to have been used still earlier as a cemetery of the Christian citizens, and corresponded thus with the site of the Seraskierat in Stamboul, on the third hill, which heathen monuments—discovered on the spot—show to have been the burial-place of the citizens of Byzantium. As all Galata was in former times

called Pera, so Pera seems to have been sometimes included in Galata. Galata-Serai, the palace of the Turkish governor of Galata (now a Franco-Turkish lyceum), is situated in the centre of Pera. The name Galata, which has been the subject of much discussion, appears to be the corruption of the Italian *Calata* (descent), the name whereby that quarter of an Italian seaport town is known which spreads over the sloping shore. Until a few years ago Galata and Pera were separated by a dry moat. This has lately been filled up with streets.

**Bridges.** Two bridges of boats span the Golden Horn and unite Galata to Stamboul. The inner one, constructed of iron, though new, has, in taking the place, adopted the name of a former bridge constructed in the reign of the Sultan Mahmoud, and is still called the Old Bridge. It stretches from the western end of Galata to the quarter on the Stamboul side which is called Oun-Capou. The outer bridge is known as that of Karakeui, as it extends from a part of Galata so named, and also as the bridge of the Valideh-Sultan, because the opposite end of it rests on the shore below the mosque of the Valideh-Sultan, otherwise Yeni Jami, or the new mosque. A third bridge, constructed during the Crimean war between Hass-keui and Aivan Serai, has disappeared. There is said to have existed in ancient times one bridge—that of Justinian. The bridge built by Philip of Macedon seems to have crossed the river at the head of the Horn.

**Climate.** The climate of Constantinople is generally healthy, owing to the position of the city, its natural drainage, and the currents of the Bosphorus, but the temperature is subject to great and sudden changes.

**Population.** It is true of the capital, as of the country at large, that no point is so hard to ascertain as the sum total of the inhabitants and the relative proportions of its parts. Byzantium in 1851 reckoned the population of the city and its suburbs at about one million, viz.,—500,000 Turks, 220,000 or 300,000 Greeks, 50,000 or 120,000 Armenians, 70,000 Jews, 10,000 Franks, and 70,000 miscellaneous. Official statistics return the population of the city and suburbs as not exceeding 700,000 in 1877.

**Education.** The Mahometan public schools are of three classes: (1) The primary district schools—*Mahaleh*—for boys and girls mixed; (2) for boys, the provincial schools—*Rushdiyeh*—of a higher order; (3) for young men, the mosque schools—*Medresseh*,—a sort of theological seminaries. There are said to be 500 medressehs in Stamboul alone. In the first class of schools are taught the Turkish alphabet and the reading of the Koran in Arabic; in the second, reading, elements of writing, principles of arithmetic, and Turkish geography and history; in the third, besides theology, Turkish, Arabic, and sometimes the Persian language. The age of entrance into the first is about five years; into the second, ten. Most lads, on leaving these secondary schools, at about sixteen years of age, proceed no higher. Besides the public schools, which are open to all Mahometan youth without distinction, there are special Government schools. The five chief establishments are the military, naval, and artillery schools, the school of military engineering, and the medical school. To each of these is annexed a preparatory school—*Idadiyeh*. A few other special schools are a training-school for teachers in the *Rushdiyeh*, a school of languages for translators, and a school for managers of woods and forests. The most important institution for supplying good secondary instruction is the metropolitan lyceum of Galata, which has generally been under French direction. A large school for orphans of different nationalities was opened some years ago near the mosque of Selim in Stamboul.

Among the philanthropic establishments of the capital must be reckoned the *Imarets*, intended like the Greek *Xenones* to be at once hospitals and poor-houses. They are attached to most of the mosques, and may be about 300, though many are fallen into decay.

The bazaars call for particular notice. They are large fire-proof buildings, lighted from above, where the varied wares of the city are retailed.

The city numbers, besides, about 180 khans (groups of offices and store-houses for merchandise), and some 130 hammams, or baths.

**Trade.** The trade of Constantinople carried on now, as under the Greek empire, by foreigners, is not distinguished by any speciality. Its harbor is a convenient

centre to many lines of commerce, sheep's wool, mohair, goat-skins, grain, &c., being transhipped from the coasts of Asia and the Black Sea. Great improvements have been introduced of late. Besides the steamers which secure communication with foreign ports, others ply between the city and its suburbs on the Horn, the Bosphorus, and the Sea of Marmora.

The streets, though ill paved, have been some of them enlarged, and many on the Pera side are lighted with gas; but the greatest improvement of all is the formation of an active and highly disciplined fire-brigade.

It is sometimes said that modern Constantinople, after so many earthquakes in earlier centuries, and conflagrations in all, retains few relics of the past; but several monuments have been already named, and others might be added. They are most numerous about the Hippodrome—that centre and focus of the city's life, and theatre of its revolutions, its festivities, and its crimes. Besides the remains of six palaces, five columns entire or in fragments are pointed out—memorials of the 1st, 3d, 4th, and 5th centuries, and associated with the historical names of Claudius II. and Constantine, Theodosius and Arius, Arcadius, Eudoxia, Marcian, and Chrysostom. Tombs of the great lie about in various corners and courts. It is to be remembered, moreover, that the greater part of the Greek city is under ground,—that besides the ruins or remains of more than 20 churches, and of the colonnades that lined the streets or divided the bazaars, and which still are met with by the passenger along its public thoroughfares, there spread out of sight beneath his feet labyrinths of passages, cisterns, and prisons of length and direction unknown, so that he may be said to walk not so much on *terra firma* as on a continuous roof.

The history of the city is almost a record of its sieges. About 100 years after its enlargement or foundation by Constantine the Great (330 A. D.) began that series of assaults by sea and land before which it gave way only thrice, when its gates were opened to Dandolo, Michael Palæologus, and Mahomet II. Michael, by the aid of his Varangians, recovered, 200 years before its final capture, what the Latins had held nearly 60 years; and 100 years before it surrendered, the Ottoman Turks profited by the divisions in the empire, and were called into the east of Europe as the followers of the same anti-Christian standard had been called into the west, till the last Constantine fell in defending the city which the first had raised and named. Constantinople was threatened by the Huns in the reign of Theodosius the younger, 450; by the Huns and Slavs in that of Justinian, 553; by the Persians and Avars in that of Heraclius, 626. The Arabs besieged it in three different expeditions. They came under Sophian in 668, and attacked it six times, once every year (672–679), when Constantine Pogonatus was emperor. Leo the Isaurian repelled a second invasion under Moslemeh in 717. They were finally led by Haroun-al-Rashid, who made peace with Constantine and Irene in 782. The Russians assailed the sea-walls of the capital four times from 865 to 1043, in the reigns of Michael III. and his successors. Romanus Leapenus, who beat them back when they were come down the second time, had to repel another enemy—the Hungarians—in 924. It was not by arms but by the treachery of Gilpracht, the leader of the German guard, that Alexius Comnenus entered one of the land-gates and seized the throne (1081); and another Alexius, with his father Isaac Angelus, brought the Latins, who occupied the city for 56 years, after the two sieges of 1203 and 1204, until Michael Palæologus embossed his name as conqueror on the bronze gates of St. Sophia. In the 15th century Constantinople was attacked by the Turks twice; under Manuel it resisted Amurath in 1422; but under Constantine Palæologus it yielded to Mahomet in 1453. The city has thus been often the aim, rarely the prize, of invasion.

The captures of the city by the Latins and the Turks brought loss to the East and gain to the West. In an age when the Goths on the one side and Arabs on the other, had ruined traffic elsewhere, Constantinople was the greatest and almost the only commercial town in the world, while Greek supremacy at sea secured a flow of riches into the state; but the citizens being dispersed during the sixty years of Latin occupation, all commerce was trans-

Fire-brigade.

Ancient monuments.

History.

ferred to the cities of Italy. To that Latin conquest is mainly attributed the sudden development of the formative arts in the 13th century, for then there arose more frequent intercourse between the Greeks and the Italians, and many Greek artists were established in Italy, especially at Venice, Siena, Pisa, and Florence. In like manner the fall of the city before the Turks scattered Greek learning among the Latin and Teutonic races; when Greek libraries were burnt and the Greek language proscribed, Greek MSS. of the Bible, sedulously copied by the monks of Constantinople from the 5th to the 15th century, conveyed the text into Western Europe; the overthrow of the capital of Greek literature synchronized with the invention of printing, and in a great measure caused the revival of learning. Since that last siege which introduced the Ottoman rule, the city, from being the object, became the starting-point of invasion; for long ages the busy hive of science and art, it was turned into a swarming nest of hornets. The mausoleum of Haireddin (Barbarossa) at Beahiktash, a suburb of the city, is a memorial of the subjugation of the Northern States of Africa; a ruin, beneath the Burnt Column, once the residence of Busbek, in the 16th century, bears witness to the privileges and the restraints of the ambassadors of Germany; and inscriptions left on the inner walls of the Seven Towers, ranging in date from 1698 to 1800, record the imprisonment and the liberation or death of captives, Venetians, French, &c., and the obstinate struggles in which the Ottomans engaged with the different powers of Europe. The last European ambassador imprisoned there was Le Brun, envoy of the French republic; he was thrown in on the news of the French landing in Egypt, and remained three years. After the tide of fortune turned on the repulse of the Turkish forces from Vienna in 1683, Constantinople began to be once more the special mark for ambition or revenge. When the peace of Carlowitz was signed in 1699 a new enemy was rising in the North; in 1770 the city was threatened by the Russian fleet joined by the English squadron. In 1807 Vice-Admiral Duckworth, having forced the passage of the Dardanelles, appeared before Constantinople, but the Turks put themselves in a posture of defence, and after eight days the squadron retreated. For further historical details, see **TURKEY**.

Authorities—Paspali, Déthier, Glavany (local), besides Alemann on Procopius, Byzantium, Gibbon, Montesquieu, &c.  
(a. c. c.)

**CONSTANTINUS CEPHALAS.** See **ANTHOLOGY**, vol. ii. p. 91.

**CONSTANTIUS, FLAVIUS VALERIUS**, commonly called **CONSTANTIUS CHLORUS**, or the Pale (an epithet first applied by the Byzantine historians, though with doubtful accuracy, for there is evidence to show that he was, like his son, ruddy), Roman emperor and father of Constantine the Great, was born of noble Dalmatian family about 250 A. D. Having distinguished himself by his military ability and his able and gentle rule of Dalmatia, he was, in March, 292, adopted and appointed Cæsar by Maximian, whose daughter Theodosia he was obliged to marry after renouncing his wife Helena. By Helena he became the father of Constantine. He obtained the title Augustus in 305, and died the following year. See **ROMAN HISTORY**.

**CONSTITUTION AND CONSTITUTIONAL LAW.** The word Constitution in the time of the Roman empire signified a collection of laws or ordinances made by the emperor. We find the word used in the same sense in the early history of English law, e.g., the Constitutions of Clarendon. In its modern use constitution has been restricted to those rules which concern the political structure of society. If we take the accepted definition of a law as a command imposed by a sovereign on the subject, the constitution would consist of the rules which point out where the sovereign is to be found, the form in which his powers are exercised, and the relations of the different members of the sovereign body to each other where it consists of more persons than one. In every independent political society, it is assumed by these definitions, there will be found somewhere or other a sovereign, whether that sovereign be a single person, or a body of persons, or several bodies of persons. The commands imposed by the sovereign person or body on the rest of the society are positive laws, properly so called. The sovereign body not only makes laws, but has two other leading functions, viz.,

those of judicature and administration. Legislation is for the most part performed directly by the sovereign body itself; judicature and administration, for the most part, by delegates. The constitution of a society, accordingly, would show how the sovereign body is composed, and what are the relations of its members *inter se*, and how the sovereign functions of legislation, judicature, and administration are exercised. Constitutional law consists of the rules relating to these subjects, and these rules may either be laws properly so called, or they may not—i.e., they may or may not be commands imposed by the sovereign body itself. The constitutional rule, for example, that the Queen and Parliament are the sovereign, cannot be called a law; for a law presupposes the fact which it asserts. And other rules, which are constantly observed in practice, but have never been enacted by the sovereign power, are in the same way constitutional rules which are not laws. It is an undoubted rule of the constitution that the king shall not refuse his assent to a bill which has passed both Houses, but it is certainly not a law. Should the king veto such a bill his action would be unconstitutional, but not illegal. On the other hand the rules relating to the election of members to the House of Commons are nearly all positive laws strictly so called. Constitutional law, as the phrase is commonly used, would include all the laws dealing with the sovereign body in the exercise of its various functions, and all the rules, not being laws properly so called, relating to the same subject.

The above is an attempt to indicate the meaning of the phrases in their stricter or more technical uses. Some wider meanings may be noticed. In the phrase constitutional government, a form of government based on certain principles which may roughly be called popular is the leading idea. England, Switzerland, the United States, are all constitutional governments in this sense of the word. Russia, France under the last empire, and Spain, on the other hand, would generally be said to be countries without constitutional government. A country where a large portion of the people has some considerable share in the supreme power would be a constitutional country. On the other hand constitutional, as applied to governments, may mean stable as opposed to unstable and anarchic societies. Again, as a term of politics, constitutional has come to mean, in England at least, not obedience to constitutional rules as above described, but adherence to the existing type of the constitution or to some conspicuous portions thereof,—in other words, Conservative. Thus the abolition of the Irish Church, which was in every way a constitutional measure in the judicial meaning of words, was not a constitutional measure in the party sense. In a country like Spain, on the other hand, the party called constitutional is liberal.

The ideas associated with constitution and constitutionalism are thus, it will be seen, mainly of modern and European growth. They are wholly inapplicable to the primitive and simple societies of the present or of former times. The discussion of forms of government occupies a large space in the writings of the Greek philosophers,—a fact which is to be explained by the existence among the Greeks of many independent political communities, variously organized, and more or less democratic in character. Between the political problems of the smaller societies and those of the great European nations there is no useful parallel to be drawn, although the predominance of classical learning made it the fashion for a long time to apply Greek speculations on the nature of monarchy, aristocracy, and democracy to public questions in modern Europe. Representation, the characteristic principle of European constitutions, has, of course, no place in societies which were not too large to admit of every free citizen participating personally in the business of government. Nor is there much in the politics or the political literature of the Romans to compare with the constitutions of modern states. Their political system was almost from the beginning one of empire, ruled absolutely by a small assembly or by one man.

The impetus to constitutional government in modern times has to a large extent come from England, and it is from English politics that the phrase and its associations have been borrowed. England has offered to the world the one conspicuous example of a long, continuous, and orderly development of political institutions. The early date at which the principle of self-government was estab-

lished in this country, the steady growth of the principle, the absence of civil dissension, and the preservation in the midst of change of so much of the old organization, have given the English constitution a great influence over the ideas of politicians in other countries. This fact is expressed in the proverbial phrase—"England is the mother of parliaments." It would not be difficult to show that the leading features of the constitutions now established in other nations have been based on, or defended by, considerations arising from the political history of England.

In one important respect England differs conspicuously from most other countries. Her constitution is to a large extent *unwritten*, using the word in much the same sense as when we speak of unwritten law. Its rules can be found in no written document, but depend, as so much of English law does, on precedent modified by a constant process of interpretation. Many rules of the constitution have in fact a purely legal history, that is to say, they have been developed by the law courts, as part of the general body of the common law. Others have in a similar way been developed by the practice of Parliament. Both Houses, in fact, have exhibited the same spirit of adherence to precedent, coupled with a power of modifying precedent to suit circumstances, which distinguishes the judicial tribunals. In a constitutional crisis the House of Commons appoints a committee to "search its journals for precedents," just as the Court of Queen's Bench would examine the records of its own decisions. And just as the law, while professing to remain the same, is in process of constant change, so, too, the unwritten constitution is, without any acknowledgment of the fact, constantly taking up new ground.

In contrast with the mobility of an unwritten constitution is the fixity of a constitution written out, like that of the United States or Switzerland, in one authoritative code. The constitution of the United States, drawn up by a Convention in 1787, is contained in a code of articles. It was ratified separately by each State, and thenceforward became the positive and exclusive statement of the constitution. The legislative powers of the legislature are not to extend to certain kinds of bills, *e. g.*, *ex post facto* bills; the president has a veto which can only be overcome by a majority of two-thirds in both Houses; the constitution itself can only be changed in any particular by the consent of the legislatures or conventions of three-fourths of the several States; and finally the judges of the supreme court are to decide in all disputed cases whether an act of the legislature is permitted by the constitution or not. This is truly a formidable apparatus of provisions against change, and, in fact, only fifteen constitutional amendments have been passed from 1789 to the present day. In the same period the unwritten constitution of England has made a most marked advance, chiefly in the direction of eliminating the separate powers of the Crown, and diminishing those of the House of Lords. The Commons, through its nominees, the Ministry, has absorbed the entire power of the Crown, and it has more and more reduced the other House to a position of secondary importance. The American constitution of 1789 was a faithful copy, so far as it was possible to make one out of the materials in hand, of the contemporary constitution of England. The position and powers of the president were a fair counterpart of the royal prerogative of that day; the Senate and the Congress corresponded sufficiently well to the House of Lords and the House of Commons, allowing for the absence of the elements of hereditary rank and territorial influence. While the English constitution has changed much, the American constitution has changed little, if at all, in these respects. Allowing for the more democratic character of the constitutions, the organization of the supreme power in the United States is nearer the English type of the last century—is less modern, in fact—than is the English constitution of the present day.

One conspicuous feature of the English constitution, by which it is broadly distinguished from written or artificial constitutions, is the presence throughout its entire extent of legal fictions. The influence of the lawyers on the progress of the constitution has already been noticed, and is nowhere more clearly shown than in this peculiarity of its structure. As in the common law, so in the constitutions, change has been effected in substance without any corresponding change in terminology. There is hardly one of the phrases used to describe the position of the Crown

which can be understood in its literal sense, and many of them are currently accepted in more senses than one.

Notwithstanding the strongly marked historical character of our political institutions, the fallacy of regarding them as elaborate contrivances devised to effect the end of good government has always more or less prevailed. It finds expression in what is called the theory of checks and balances—the theory that power is so distributed among the different elements of the state that each acts as a check on the other, and none is supreme. So Blackstone and writers of his class tell us that the English constitution is the perfection of political wisdom, inasmuch as it combines the virtues of monarchy, aristocracy, and democracy without the faults which would attend any one of these varieties of government unmodified by the others. The tendency to repeat the English type of Parliament, in artificial or paper constitutions, is probably not entirely unconnected with this habit of mind. The question of a second chamber has been a practical difficulty of the first importance in all such constitutions. The attempt to imitate the duality of the English Parliament results in two co-ordinate Houses of legislature, each of which may at any moment bring legislation to a stop. "In both the American and the Swiss constitution," says an eminent writer on the subject (Mr. Bagehot), "the Upper House has as much authority as the second; it could produce the maximum of impediment; the dead-lock, if it liked; if it does not do so it is owing, not to the goodness of the legal constitution, but to the discreetness of members of the chamber." The explanation may not unreasonably be found in the impossibility of creating a second chamber with the same character which its history has imposed on the English House of Lords. Our two Houses are far from being of co-ordinate authority. In the last result, the will of the House of Commons must prevail.

A further exemplification of this view of the British constitution may be found in the fact that its highest executive council, the Cabinet, is not even known to the law.

Between England and some other constitutional countries a difference of much constitutional importance is to be found in the terms on which the component parts of the country were brought together. All great societies have been produced by the aggregation of small societies into larger and larger groups. In England the process of consolidation was completed before the constitution settled down into its present form. In the United States, on the other hand, in Switzerland, and in Germany, the constitution is in form an alliance among a number of independent states, each of which may have a constitution and laws of its own for local purposes. In federal governments it remains a question how far the independence of individual states has been sacrificed by submission to a constitution. In the United States constitutional progress is hampered by the necessity thus created of having every amendment ratified by the separate vote of three-fourths of the States.

(E. R.)

**CONSTITUTION OF BODIES.** The question whether the smallest parts of which bodies are composed are finite in number, or whether, on the other hand, bodies are infinitely divisible, relates to the *ultimate* constitution of bodies, and is treated of in the article **ATOM**.

The mode in which elementary substances combine to form compound substances is called the *chemical* constitution of bodies, and is treated of in **CHEMISTRY**.

The mode in which sensible quantities of matter, whether elementary or compound, are aggregated together so as to form a mass having certain observed properties, is called the *physical* constitution of bodies.

Bodies may be classed in relation to their physical constitution by considering the effects of internal stress in changing their dimensions. When a body can exist in equilibrium under the action of a stress which is not uniform in all directions it is said to be solid.

When a body is such that it cannot be in equilibrium unless the stress at every point is uniform in all directions it is said to be fluid.

There are certain fluids, any portion of which, however small, is capable of expanding indefinitely, so as to fill any vessel, however large. These are called gases. There are other fluids, a small portion of which, when placed in a large vessel, does not at once expand so as to fill the vessel uniformly, but remains in a collected mass at the bottom,

even when the pressure is removed. These fluids are called *liquids*.

When a liquid is placed in a vessel so large that it only occupies a part of it, part of the liquid begins to evaporate, or in other words it passes into the state of a gas, and this process goes on either till the whole of the liquid is evaporated, or till the density of the gaseous part of the substance has reached a certain limit. The liquid and the gaseous portions of the substance are then in equilibrium. If the volume of the vessel be now made smaller, part of the gas will be condensed as a liquid, and if it be made larger, part of the liquid will be evaporated as a gas.

The processes of evaporation and condensation, by which the substance passes from the liquid to the gaseous, and from the gaseous to the liquid state, are discontinuous processes, that is to say, the properties of the substance are very different just before and just after the change had been effected. But this difference is less in all respects the higher the temperature at which the change takes place, and Cagniard de la Tour in 1822<sup>1</sup> first showed that several substances, such as ether, alcohol, bisulphide of carbon, and water, when heated to a temperature sufficiently high, pass into a state which differs from the ordinary gaseous state as much as from the liquid state. Dr. Andrews has since<sup>2</sup> made a complete investigation of the properties of carbonic acid both below and above the temperature at which the phenomena of condensation and evaporation cease to take place, and has thus explored as well as established the continuity of the liquid and gaseous states of matter.

For carbonic acid at a temperature, say of 0° C., and at the ordinary pressure of the atmosphere, is a gas. If the gas be compressed till the pressure rises to about 40 atmospheres, condensation takes place, that is to say, the substance passes in successive portions from the gaseous to the liquid condition.

If we examine the substance when part of it is condensed, we find that the liquid carbonic acid at the bottom of the vessel has all the properties of a liquid, and is separated by a distinct surface from the gaseous carbonic acid which occupies the upper part of the vessel.

But we may transform gaseous carbonic acid at 0° C. into liquid carbonic acid at 0° C., without any abrupt change, by first raising the temperature of the gas above 30°-92° C. which is the *critical* temperature, then raising the pressure to about 80 atmospheres, and then cooling the substance, still at high pressure, to zero.

During the whole of this process the substance remains perfectly homogeneous. There is no surface of separation between two forms of the substance, nor can any sudden change be observed like that which takes place when the gas is condensed into a liquid at low temperatures; but at the end of the process the substance is undoubtedly in the liquid state, for if we now diminish the pressure to somewhat less than 40 atmospheres the substance will exhibit the ordinary distinction between the liquid and the gaseous state, that is to say, part of it will evaporate, leaving the rest at the bottom of the vessel, with a distinct surface of separation between the gaseous and the liquid parts.

The passage of a substance between the liquid and the solid state takes place with various degrees of abruptness. Some substances, such as some of the more crystalline metals, seem to pass from a completely fluid to a completely solid state very suddenly. In some cases the melted matter appears to become thicker before it solidifies, but this may arise from a multitude of solid crystals being formed in the still liquid mass, so that the consistency of the mass becomes like that of a mixture of sand and water, till the melted matter in which the crystals are swimming becomes all solid.

There are other substances, most of them colloidal, such that when the melted substance cools it becomes more and more viscous, passing into the solid state with hardly any discontinuity. This is the case with pitch.

The theory of the consistency of solid bodies will be discussed in the article *ELASTICITY*, but the manner in which a solid behaves when acted on by stress furnishes us with a system of names of different degrees and kinds of solidity.

A fluid, as we have seen, can support a stress only when it is uniform in all directions, that is to say, when it is of the nature of a hydrostatic pressure.

There are a great many substances which so far correspond to this definition of a fluid that they cannot remain in permanent equilibrium if the stress within them is not uniform in all directions.

In all existing fluids, however, when their motion is such that the shape of any small portion is continually changing, the internal stress is not uniform in all directions, but is of such a kind as to tend to check the relative motion of the parts of the fluid.

This capacity of having inequality of stress called into play by inequality of motion is called *viscosity*. All real fluids are viscous, from treacle and tar to water and ether and air and hydrogen.

When the viscosity is very small the fluid is said to be mobile, like water and ether.

When the viscosity is so great that a considerable inequality of stress, though it produces a continuously increasing displacement, produces it so slowly that we can hardly see it, we are often inclined to call the substance a solid, and even a hard solid. Thus the viscosity of cold pitch or of asphalt is so great that the substance will break rather than yield to any sudden blow, and yet if it is left for a sufficient time it will be found unable to remain in equilibrium under the slight inequality of stress produced by its own weight, but will flow like a fluid till its surface becomes level.

If, therefore, we define a fluid as a substance which cannot remain in *permanent equilibrium* under a stress not equal in all directions, we must call these substances fluids, though they are so viscous that we can walk on them without leaving any footprints.

If a body, after having its form altered by the application of stress, tends to recover its original form when the stress is removed, the body is said to be elastic.

The ratio of the numerical value of the stress to the numerical value of the strain produced by it is called the *coefficient of elasticity*, and the ratio of the strain to the stress is called the *coefficient of pliability*.

There are as many kinds of these coefficients as there are kinds of stress and of strains or components of strains produced by them.

If, then, the values of the coefficients of elasticity were to increase without limit, the body would approximate to the condition of a rigid body.

We may form an elastic body of great pliability by dissolving gelatine or isinglass in hot water and allowing the solution to cool into a jelly. By diminishing the proportion of gelatine the coefficient of elasticity of the jelly may be diminished, so that a very small force is required to produce a large change of form in the substance.

When the deformation of an elastic body is pushed beyond certain limits depending on the nature of the substance, it is found that when the stress is removed it does not return exactly to its original shape, but remains permanently deformed. These limits of the different kinds of strain are called the limits of perfect elasticity.

There are other limits which may be called the limits of cohesion or of tenacity, such that when the deformation of the body reaches these limits the body breaks, tears asunder, or otherwise gives way, and the continuity of its substance is destroyed.

A body which can have its form permanently changed without any flaw or break taking place is called *mild*; when the force required is small the body is said to be *soft*; when it is great the body is said to be *tough*. A body which becomes flawed or broken before it can be permanently deformed is called *brittle*. When the force required is great the body is said to be *hard*.

The stiffness of a body is measured by the force required to produce a given amount of deformation.

Its strength is measured by the force required to break or crush it.

We may conceive a solid body to approximate to the condition of a fluid in several different ways.

If we knead fine clay with water, the more water we add the softer does the mixture become, till at last we have water with particles of clay slowly subsiding through it. This is an instance of a mechanical mixture the constituents of which separate of themselves. But if we mix beeswax with oil, or rosin with turpentine, we may form permanent mixtures of all degrees of softness, and so pass from the solid to the fluid state through all degrees of viscosity.

<sup>1</sup> *Annales de Chimie*, 2<sup>me</sup> série, xxi. et xxii.  
<sup>2</sup> *Phil. Trans.*, 1869, p. 575.

We may also begin with an elastic and somewhat brittle substance like gelatine, and add more and more water till we form a very weak jelly, which opposes a very feeble resistance to the motion of a solid body, such as a spoon, through it. But even such a weak jelly may not be a true fluid, for it may be able to withstand a very small force, such as the weight of a small mote. If a small mote or seed is enclosed in the jelly, and if its specific gravity is different from that of the jelly, it will tend to rise to the top or sink to the bottom. If it does not do so we conclude that the jelly is not a fluid but a solid body, very weak, indeed, but able to sustain the force with which the mote tends to move.

It appears, therefore, that the passage from the solid to the fluid state may be conceived to take place by the diminution without limit either of the coefficient of rigidity, or of the ultimate strength against rupture, as well as by the diminution of the viscosity. But whereas the body is not a true fluid till the ultimate strength, or the coefficient of rigidity, is reduced to zero, it is not a true solid as long as the viscosity is not infinite.

Solids, however, which are not viscous in the sense of being capable of an unlimited amount of change of form, are yet subject to alterations depending on the time during which stress has acted on them. In other words, the stress at any given instant depends, not only on the strain at that instant, but on the previous history of the body. Thus the stress is somewhat greater when the strain is increasing than when it is diminishing, and if the strain is continued for a long time, the body, when left to itself, does not at once return to its original shape, but appears to have taken a set, which, however, is not a permanent set, for the body slowly creeps back to its original shape with a motion which may be observed to go on for hours and even weeks after the body is left to itself.

Phenomena of this kind were pointed out by Weber and Kohlrausch (*Pogg. Ann. Bd. 54*, 119 and 128), and have been described by O. E. Meyer (*Pogg. Ann. Bd. 131*, 108), and by Maxwell (*Phil. Trans.*, 1866, p. 249), and a theory of the phenomena has been proposed by Dr. L. Boltzmann (*Wiener Sitzungsberichte*, 8th October, 1874).

The German writers refer to the phenomena by the name of "elastische Nachwirkung," which might be translated "elastic reaction" if the word reaction were not already used in a different sense. Sir W. Thomson speaks of the viscosity of elastic bodies.

The phenomena are most easily observed by twisting a fine wire suspended from a fixed support, and having a small mirror suspended from the lower end, the position of which can be observed in the usual way by means of a telescope and scale. If the lower end of the wire is turned round through an angle not too great, and then left to itself, the mirror makes oscillations, the extent of which may be read off on the scale. These oscillations decay much more rapidly than if the only retarding force were the resistance of the air, showing that the force of torsion in the wire must be greater when the twist is increasing than when it is diminishing. This is the phenomenon described by Sir W. Thomson under the name of the viscosity of elastic solids. But we may also ascertain the middle point of these oscillations, or the point of temporary equilibrium when the oscillations have subsided, and trace the variations of its position.

If we begin by keeping the wire twisted, say for a minute or an hour, and then leave it to itself, we find that the point of temporary equilibrium is displaced in the direction of twisting, and that this displacement is greater the longer the wire has been kept twisted. But this displacement of the point of equilibrium is not of the nature of a permanent set, for the wire, if left to itself, creeps back towards its original position, but always slower and slower. This slow motion has been observed by the writer going on for more than a week, and he also found that if the wire was set in vibration the motion of the point of equilibrium was more rapid than when the wire was not in vibration.

We may produce a very complicated series of motions of the lower end of the wire by previously subjecting the wire to a series of twists. For instance, we may first twist it in the positive direction, and keep it twisted for a day, then in the negative direction for an hour, and then in the positive direction for a minute. When the wire is left to itself the displacement, at first positive, becomes negative

in a few seconds, and this negative displacement increases for some time. It then diminishes, and the displacement becomes positive, and lasts a longer time, till it too finally dies away.

The phenomena are in some respects analogous to the variations of the surface temperature of a very large ball of iron which has been heated in a furnace for a day, then placed in melting ice for an hour, then in boiling water for a minute, and then exposed to the air; but a still more perfect analogy may be found in the variations of potential of a Leyden jar which has been charged positively for a day, negatively for an hour, and positively again for a minute.<sup>1</sup>

The effects of successive magnetization on iron and steel are also in many respects analogous to those of strain and electrification.<sup>2</sup>

The method proposed by Boltzmann for representing such phenomena mathematically is to express the actual stress,  $L_t$ , in terms not only of the actual strain,  $\theta_t$ , but of the strains to which the body has been subjected during all previous time.

His equation is of the form

$$L_t = K\theta_t - \int_0^\infty \psi(\omega)\theta_{t-\omega}d\omega,$$

where  $\omega$  is the interval of time reckoned backwards from the actual time  $t$  to the time  $t-\omega$ , when the strain  $\theta_{t-\omega}$  existed, and  $\psi(\omega)$  is some function of that interval.

We may describe this method of deducing the actual state from the previous states as the historical method, because it involves a knowledge of the previous history of the body. But this method may be transformed into another, in which the present state is not regarded as influenced by any state which has ceased to exist. For if we expand  $\theta_{t-\omega}$  by Taylor's theorem,

$$\theta_{t-\omega} = \theta_t - \omega \frac{d\theta}{dt} + \frac{\omega^2}{1.2} \frac{d^2\theta}{dt^2} - \&c.,$$

and if we also write

$$A = \int_0^\infty \psi(\omega)d\omega, \quad B = \int_0^\infty \omega\psi(\omega)d\omega, \quad C = \int_0^\infty \frac{\omega^2}{1.2}\psi(\omega)d\omega, \&c.,$$

then equation (1) becomes

$$L = (KA)\theta + B \frac{d\theta}{dt} - C \frac{d^2\theta}{dt^2} + \&c.,$$

where no symbols of time are subscribed, because all the quantities refer to the present time.

This expression of Boltzmann's, however, is not in any sense a physical theory of the phenomena; it is merely a mathematical formula which, though it represents some of the observed phenomena, fails to express the phenomenon of permanent deformation. Now we know that several substances, such as gutta-percha, India-rubber, &c., may be permanently stretched when cold, and yet when afterwards heated to a certain temperature they recover their original form. Gelatine also may be dried when in a state of strain, and may recover its form by absorbing water.

We know that the molecules of all bodies are in motion. In gases and liquids the motion is such that there is nothing to prevent any molecule from passing from any part of the mass to any other part; but in solids we must suppose that some, at least, of the molecules merely oscillate about a certain mean position; so that, if we consider a certain group of molecules, its configuration is never very different from a certain stable configuration, about which it oscillates.

This will be the case even when the solid is in a state of strain, provided the amplitude of the oscillations does not exceed a certain limit, but if it exceeds this limit the group does not tend to return to its former configuration, but begins to oscillate about a new configuration of stability, the strain in which is either zero, or at least less than in the original configuration.

The condition of this breaking up of a configuration must depend partly on the amplitude of the oscillations, and partly on the amount of strain in the original configuration; and we may suppose that different groups of molecules, even in a homogeneous solid, are not in similar circumstances in this respect.

<sup>1</sup> See Dr. Hopkinson, "On the Residual Charge of the Leyden Jar," *Proc. R. S.*, xxiv. 408, March 30, 1876.

<sup>2</sup> See Wiedemann's *Galvanismus*, vol. II. p. 567.

Thus we may suppose that in a certain number of groups the ordinary agitation of the molecules is liable to accumulate so much that every now and then the configuration of one of the groups breaks up, and this whether it is in a state of strain or not. We may in this case assume that in every second a certain proportion of these groups break up, and assume configurations corresponding to a strain uniform in all directions.

If all the groups were of this kind, the medium would be a viscous fluid.

But we may suppose that there are other groups, the configuration of which is so stable that they will not break up under the ordinary agitation of the molecules unless the average strain exceeds a certain limit, and this limit may be different for different systems of these groups.

Now if such groups of greater stability are disseminated through the substance in such abundance as to build up a solid framework, the substance will be a solid, which will not be permanently deformed except by a stress greater than a certain given stress.

But if the solid also contains groups of smaller stability and also groups of the first kind which break up of themselves, then when a strain is applied the resistance to it will gradually diminish as the groups of the first kind break up, and this will go on till the stress is reduced to that due to the more permanent groups. If the body is now left to itself, it will not at once return to its original form, but will only do so when the groups of the first kind have broken up so often as to get back to their original state of strain.

This view of the constitution of a solid, as consisting of groups of molecules some of which are in different circumstances from others, also helps to explain the state of the solid after a permanent deformation has been given to it. In this case some of the less stable groups have broken up and assumed new configurations, but it is quite possible that others, more stable, may still retain their original configurations, so that the form of the body is determined by the equilibrium between these two sets of groups; but if, on account of rise of temperature, increase of moisture, violent vibration, or any other cause, the breaking up of the less stable groups is facilitated, the more stable groups may again assert their sway, and tend to restore the body to the shape it had before its deformation. (J. C. M.)

CONSUEGRA, a town of Spain, on the Amarguilla, in the province of Toledo, and 36 miles south-east of the city of that name. It contains about 7000 inhabitants, principally engaged in the manufacture of coarse woollens. Roman inscriptions and other remains bear witness to the antiquity of the town, which was formerly known as *Consabrum*; and on a neighboring hill are the ruins of its ancient castle.

CONSUL (*βπαρος*), the highest magistrate of the republic of ancient Rome. It is probable that the word is compounded of *con* and *salio*, so that *consules* signifies those who go together. They were in early times called *prætores*, *imperatores*, or *judices*.

From the abuse of the power which had been vested in the kings, the Romans were induced not only to expel the hated Tarquins from the city, but even to abolish the monarchical form of government altogether. Brutus and his companions, after the rape of Lucretia, made the people swear that no king should ever again reign at Rome. The state was henceforth ruled by two supreme magistrates called consuls. The consular office was instituted after the expulsion of the kings, 510 B. C., and continued, with few interruptions, till the establishment of the empire—a period of nearly 500 years. The leaders of the revolution which had expelled the kings were first raised to this rank. All the royal insignia were preserved except the crown. Twelve lictors preceded them alternately. The elder of the two, or he who had most children, or who had been first elected, had the *fasces* first, the other meanwhile being preceded by a public officer called *accensus*, and followed by the lictors. Sometimes they agreed to enjoy the *fasces* on alternate days, but generally for alternate months. By the law of Poplicola, the axe was taken from them and their *fasces* were lowered when they entered the assemblies of the people. A cloak with a scarlet border, and an ivory staff, were badges of their office. On public occasions they used a seat of ornamental ivory called the curule chair.

From the great power which their order originally possessed in the state, the patricians succeeded for a long

time in retaining the consulship among themselves. It was not till the year 445 B. C. that the plebeians acquired sufficient courage and strength to make any attempts to acquire the right of being elected to this office. Having once begun the struggle, however, they maintained it for the space of eighty years with a spirit and resolution which made even a foreign war desirable as a relief from internal contests. Livy relates that for five years (375–371 B. C.) the opposition raised by the plebeians, under the guidance of the tribunes L. Licinius Stolo and L. Sextius, was so formidable that neither consuls nor any other magistrates could be appointed, and there was what he calls a *solitudo magistratum*. At length the patricians, after attempting an evasion by the appointment of five military tribunes, were compelled to accede to the Licinian law, by which it was ordained (367 B. C.) that in all time coming one of the consuls should be a plebeian. L. Sextius was the first plebeian consul. But the power which was effectual in the passing of the law was not equal to its enforcement, for in 355 B. C. both consuls were patricians; and, as was often the case with Roman laws, it was found necessary to re-enact it. This time, however, the demands of the plebeians increased; and not satisfied with having one consul, they tried to add a clause ordaining it to be lawful for the people to elect both consuls from their own number. Although the attempt was successful, no example of the appointment of two plebeian consuls occurs till the year 215 B. C. The honor seems for the most part to have been equally divided between the two orders. The first foreigner who obtained the consulship was Cornelius Balbus, a native of Cadiz, and a man of extraordinary wealth.

The legal age for enjoying the consulship was forty-five; but this regulation was not strictly observed. Pompey was made consul in his thirty-sixth year, M. Valerius Corvus in his twenty-third, T. Quinctius Flaminius was created consul before he was thirty, Scipio Africanus the Elder at twenty-eight, and the Younger at thirty-eight. It was necessary for candidates to have discharged the inferior duties of *quæstor*, *ædile*, and *prætor* before they were eligible; and a regulation was made that they should be present at the election in a private capacity. It was also enacted that no one should be made consul a second time till after the lapse of ten years. But we find cases in which all these conditions were disregarded. Some were elected who had not previously borne any curule magistracy; and others were appointed in their absence. Some continued in office more than a year, as Marius, who was seven times consul without intermission; and others were re-elected before the allotted time had elapsed.

The election of consuls was made by the *comitia centuriata* in the Campus Martius. The assembly at which they were elected was always convoked and presided over by a consul, dictator, or interrex. It generally took place in the month of July, that an opportunity might be afforded for investigating the conduct of the successful candidates before they entered on their office, and that they might have time to become conversant with their duties. From their appointment to the day of their induction they were called *consules designati*, or consuls elect, and had the privilege of being first asked their opinion in the senate. The day upon which they assumed office was repeatedly changed. It seems originally to have been the Ides of September, when, in the rude days of Roman history, the consuls used annually to fix a nail in the temple of Jupiter Capitolinus to mark the year; but as it sometimes happened, when one died before the term of his office had expired, that another was immediately chosen to fill his place, the year of his successor was naturally finished before the usual time, and this necessitated a repeated change in the days of their appointment and induction. Sometimes, too, civil commotions prevented the election taking place at the usual time. As the consul whose year was completed could not in such cases discharge any of the consular duties, it was customary for the senate to nominate a temporary magistrate called interrex. His authority being limited to five days, a succession of interreges had frequently to be chosen before tranquillity was restored. At length (154 B. C.) it was enacted that consuls and all the ordinary magistrates, with the exception of the tribunes of the people, should begin their duties on the 1st of January. That day was marked by peculiar solemnities. At daybreak the consuls arose and consulted the auspices. Afterwards the senate and people waited upon them at their houses, and then with

the new magistrates clad in their state robes at their head, they all marched in solemn procession to the capitol. There victims were offered, and prayers presented for the safety and prosperity of the Roman people. After the conclusion of the religious rites a meeting of the senate was held, and the new consuls first exercised their functions by consulting it about the performance of religious ceremonies. Within five days after their induction they were obliged to swear, as they had done at their election, that they would strictly observe the laws; and at the close of their consulship they were required to take a similar oath declaring that they had done nothing contrary to the constitution.

The power of the consuls appears at first to have been similar to that of the kings; but in process of time several distinctions arose which combined to render the consular authority inferior to the regal. The office of high priest, which had been discharged by the kings, was in the time of the consulship executed by a special magistrate, called *rex sacrorum*, or *rex sacrificulus*. The power of life and death was afterwards denied to the consuls, and the symbolic axe removed from the *fasces*. While there was only one king, there were two consuls. The obvious design of the Romans in dividing the consulship was that their power might be weakened, and the safety of the people made more secure by the resistance which the ambitious designs of the one would receive from the other. For the same reason they elected them annually, and thus prevented that insolence of authority which the long continuation of it is apt to produce. They were restrained from illegal measures still further by fear of punishment when their term of office had expired; for the people had reserved to themselves the right of bringing them to trial for misconduct. The Valerian law weakened their authority by decreeing that no magistrate should scourge or put to death a Roman citizen who appealed to the people. Even the decision of one consul could be repealed by the other. But it was the creation of the tribunes of the people that especially contributed to limit their prerogatives, and strengthen the cause of liberty. And as additional magistracies were instituted, many of their old privileges were taken from them. Their judicial power was transferred to the prætors, and their censorial to the censors, while other duties originally discharged by them devolved upon ædiles and other new magistrates.

But notwithstanding these limitations, the power of the consuls was at all times very great. As civil magistrates they were at the head of the government, and all others, with the exception of the tribunes of the people, were subject to them. They assembled and presided over the senate and *comitia centuriata*; they introduced subjects of deliberation, proposed laws, and executed the decrees of both senate and people. The laws proposed by them generally received their name. The year was called after them. They gave audience to embassies, and communicated with other states. Before the establishment of the prætorship and censorship, they discharged the highest judicial functions, and superintended the assessment of the citizens. They had the right of summoning and enforcing the presence of any one they pleased. Every person was bound to turn out of the way, dismount, rise up, uncover the head, or show some similar token of respect, on passing them. The consul Acilius ordered the curule chair of the prætor Lucullus to be broken in pieces for a breach of this regulation. As military commanders they had absolute authority. They had the power of life and death over the lives of their soldiers; and accordingly they had axes in their fasces when in the field. When any great danger threatened the state the consuls were invested by the senate with extraordinary powers, which made them supreme in the city as well as out of it. Accordingly, in the early days of the republic, when the patricians were in sole possession of the consulship, and wished to subdue any outbreak of the plebeians, they feigned that some powerful enemy was marching against the city, and thus succeeded in obtaining extraordinary powers for the consuls.

After the consuls had resigned their office, they were commissioned by the senate to assume the government of provinces under the title of *proconsuls*. It was the prerogative of the senate to determine the provinces for the consuls, although it was left to themselves to decide by lot or agreement which of them each should receive. When the time arrived for a proconsul to set out for his province,

he was furnished by the senate with the troops appointed for him, and everything requisite for his command. Surrounded by a train of friends, and a numerous personal staff, he marched out of the city with great pomp. He was bound to travel direct to his province; and the towns through which he passed had to supply him with necessaries for his journey. Within his province he had the command of the troops, and could employ them as he pleased. He was supreme judge both in criminal and in civil causes, and could inflict the punishment of death—except on Roman citizens, who could appeal to Rome. Justice was generally administered at circuit courts, held once a year in the principal towns. The proconsulship continued likewise for one year only, but it was often prolonged by a decree of the senate.

Under the empire the consuls were superseded by the emperors. The title, indeed, remained, and all the ceremonies were performed with exactness, and perhaps even with more magnificence than formerly. It would seem as if they attempted to conceal the loss of real power by the trappings of external pomp. The day of their induction was even more than ever a day of note in the city. Sitting on curule chairs, which were placed on lofty chariots, arrayed in rich dresses in imitation of those which used to be worn by generals in a triumph, with shoes of cloth of gold upon their feet and sceptres in their hands, they passed through the city, scattering money among the crowd, and bestowing gifts upon their friends. Their first duty, however, no longer consisted in consulting the senate about the religious duties of the State, but in formally returning thanks to the emperor for their election. The emperors had arrogated the right of assuming the consulship to themselves, or disposing of it as they thought proper. Julius Cæsar was dictator and consul at the same time. Augustus made himself consul thirteen times during his reign. Vespasian proclaimed himself perpetual consul. And in bestowing it upon others, the emperors were not content with having one pair of consuls for one year. Desirous to conciliate as many of their friends as possible, they greatly shortened the duration of the office. It was held generally for two months, which allowed twelve consuls during one year. But sometimes it lasted only a few weeks, a few days, or even a few hours, according to the pleasure of the emperor. There happened to be twenty-five consuls in the year 189 A. D. But those who entered upon their office on the 1st of January were held in greater respect, and gave their names to the year. They were called, as in the time of the republic, *consules ordinarii*; while those who were raised to the office at other times were termed *consules suffecti*, or *consules minores*.

While the republic lasted, the time that elapsed between the election and ordination of consuls was short, generally from July to January. In the time of the emperors, ordination was sometimes deferred several years. The triumphs in 39 B. C. nominated consuls for eight succeeding years. In this way the title of *designatus* was frequently enjoyed long before the actual consulship. Caius, the grandson of Augustus, was consul *designatus* for five years. Nero was fourteen years old when he was nominated consul *designatus*, and twenty when he became consul.

Besides these different kinds of consuls, all of which existed in the republic, we find another class peculiar to the later days of the empire—honorary consuls. These enjoyed the titles and badges of consuls, but nothing more. They possessed their honors, though altogether free from their duties. All the consuls, in truth, during the period of which we speak, may with propriety be termed honorary, for the substance of their power had been taken from them. They had become the mere slaves of the emperors, although they still continued the formal discharge of their functions. Nevertheless, even in this degraded condition, the consulship was always regarded with veneration, and considered the highest dignity to which a Roman citizen could aspire.

CONSUL, a public officer authorized by the state whose commission he bears to manage the commercial affairs of its subjects in a foreign country, and formally permitted by the Government of the country wherein he resides to perform the duties which are specified in his commission, or *lettre de provision*. A consul, as such, is not invested with any diplomatic character, and he cannot enter on his official duties until a rescript, termed an *exequatur* (sometimes a mere countersign endorsed on the commission) has been



delivered to him by the authorities of the state to which his nomination has been communicated by his own Government. This *exequatur*, called in Turkey a *barat*, may be revoked at any time at the discretion of the Government where he resides. The status of consuls commissioned by the Christian powers of Europe to reside in the Levant, and to exercise judicial functions in civil and criminal matters between their own countrymen and strangers, is exceptional to the common law, and is founded on special conventions or capitulations with the Ottoman Porte. The English consuls in the Levant were originally the officers of "the governor and company of merchants of England trading in the Levant seas," created by letters patent from James I., which were cancelled in 1826. Besides the pure consular jurisdiction—exercised under the Order in Council 30th November, 1864, by a judge in the Supreme Consular Court at Constantinople, and by the ordinary consuls in provincial courts, subject to an appeal to her Majesty's Imperial Court of Appeal, in cases beyond £500 in value—there is also the jurisdiction of the consular court of the defender's nation, where the parties are both foreign Christians, and a Turkish tribunal for cases between Turks and foreign Christians. The tendency now is to substitute mixed tribunals in both these cases. The right of British consuls to be present in the native courts, when one of the parties is a British subject, was conceded by the Treaty of Dardanelles (1809). It is not unusual in the case of consuls-general resident in Mahometan countries that they should also be accredited as political agents, or *chargés d'affaires*, in which case they are invested with the diplomatic character, and are entitled to the privileges of public ministers.

The present system of consuls *d'outre mer*, or *à l'étranger*, was preceded by the system of domestic consuls, *judges consuls*, or *marchands*, in the chief maritime cities of the south of Europe. These constituted mere tribunals of commerce which had no special concern with foreign shipping or trade. Later on, the need was felt of a safe place of deposit and of an independent jurisdiction. Particular quarters of mercantile cities were assigned to foreign traders, and disputes were decided by officers variously called governors, protectors, ancients, aldermen (in the Hanse towns), syndics, jurats, *prévôts*, *capitouls*, and *échevins*—all names borrowed from municipal offices. The consul was generally a wholesale dealer, named by the rector and council of the home city. He had power to fine and banish from the quarter. Similar to these were the judge-conservators, elected by British residents in the Portuguese ports. This privilege long cemented the friendly relations of the two nations, and was formally renounced only in 1842. Another singular institution, containing more than the germ of the modern consulate, was "the *Cour de la Fonde*, whose jurisdiction had supplanted the old Court of the Reis or Ballis (established by Godfrey de Bouillon at Jerusalem for the benefit of Syrian merchants), and which included a cognizance of all commercial matters, its judges being a mixed body of Franks and Syrians" (Kent's *Commentaries*, by Abdy, p. 137). The 16th century saw the introduction of foreign consuls, but the earliest treaties of Great Britain with Spain and Turkey on this subject are dated in 1665 and 1675. The right to establish consuls is now universally recognized by Christian civilized states. Jurists at one time contended that according to international law a right of "extra-territoriality" attached to consuls, their persons and dwellings being sacred, and themselves amenable to local authority only in cases of strong suspicion on political grounds. It is now admitted that, apart from treaty, custom has established very few consular privileges; that perhaps consuls may be arrested and incarcerated, not merely on criminal charges, but for civil debt; and that, if they engage in trade or become the owners of immovable property, their persons certainly lose protection. This question of arrest has been frequently raised in Europe:—in the case of Barbut, a tallow-chandler, who from 1717 to 1735 acted as Prussian consul in London, and to whom the exemption conferred by statute on ambassadors was held not to apply; in the case of Cretico, the Turkish consul at London in 1808; in the case of Begley, the United States consul at Genoa, arrested in Paris in 1840; and in the case of De la Fuente Hermosa, Uruguayan consul, whom the *Cour Royale* of Paris in 1842 held liable to arrest for debt. In the same way consuls, unless protected by treaty, pay local taxes,

although they are generally exempt from general duties on articles of personal consumption, relief from income tax being often given by treaty. They are exempt from billeting and military service, but are not entitled (except in the Levant, where also freedom from arrest and trial is the rule) to have private chapels in their houses. The exception in favor of the Levant was illustrated in 1853, when the refugee Martin Koszta, who had become United States consul at Smyrna and *chargé d'affaires* at Constantinople, was seized by the Turks. This, although a case of suspicion on political grounds, called forth a protest from America, and restitution was made. The right of consuls to exhibit their national arms and flag over the door of the *bureau* is not disputed.

The duty of consuls, under the "General Instructions to British Consuls," is to advise Her Majesty's trading subjects, to quiet their differences, and to conciliate as much as possible the subjects of the two countries. Treaty-rights he is to support in a mild and moderate spirit; and he is to check as far as possible evasions by British traders of the local revenue laws. Besides assisting British subjects who are tried for offences in the local courts, and ascertaining the humanity of their treatment after sentence, he has to consider whether home or foreign law is more appropriate to the case, having regard to the convenience of witnesses and the time required for decision; and, where local courts have wrongfully interfered, he puts the Home Government in motion through the consul-general or ambassador. He sends in reports on the export and import trade of the district in which he resides; and he reports to the secretary of state when a vice-consul is required in any place, generally naming an English merchant. Under the Act 12 and 13 Vict. c. 68, extended by the Consular Marriage Act, 1868, consuls are empowered, on certain notices and declarations being given, to celebrate marriage between persons who have resided one month in the district, one of them being a British subject. They are also empowered by statute to advance for the erection or maintenance of Anglican churches, hospitals, and places of interment sums equal to the amount subscribed for the purpose by the resident British subjects.

As the powers and duties of consuls vary with the particular commercial interests they have to protect, and the civilization of the state in whose territory they reside, instead of abstract definition, we summarize the provisions on this subject of the British Merchant Shipping Acts.<sup>1</sup> Consuls are bound to send to the Board of Trade such reports or returns on any matter relating to British merchant shipping or seamen as they may think necessary. Where a consul suspects that the shipping or navigation laws are being evaded, he may require the owner or master to produce the log-book or other ship documents (such as the agreement with the seamen, the account of the crew, the certificate of registration); he may muster the crew, and order explanations with regard to the documents. Where an offence has been committed on the high seas, or abroad ashore, by British seamen or apprentices, the consul makes inquiry on oath, and may send home the offender and witnesses by a British ship, particulars for the Board of Trade being endorsed on the agreement for conveyance. He is also empowered to detain a foreign ship, the master or seamen of which appear to him through their misconduct or want of skill to have caused injury to a British vessel, until the necessary application for satisfaction or security be made to the local authorities. Every British mercantile ship, not carrying passengers, on entering a port gives into the custody of the consul to be endorsed by him the seamen's agreement, the indentures, &c.; a failure to do this is reported to the registrar-general of seamen. The following five provisions are also made for the protection of seamen. If a British master engage seamen at a foreign port, the engagement is sanctioned by the consul, acting as a Superintendent of Mercantile Marine Offices. The consul collects the property (including arrears of wages) of British seamen or apprentices dying abroad, and remits to H. M. paymaster-general. He also provides for the subsistence of seamen who are shipwrecked, discharged, or left behind, even if their service was with foreign merchants; they are generally sent home in the first British ship that happens to be in want of a complement, and the expenses thus

<sup>1</sup> See also instructions to Consuls prepared by the Board of Trade and approved by the Secretary of State for Foreign Affairs, 1855 and Supplementary Instructions, 1868.

incurred form a charge on the Parliamentary fund for the relief of distressed seamen, the consul receiving a commission of 2½ per cent. on the amount disbursed. Complaints by crews as to the quality and quantity of the provisions on board are investigated by the consul, who enters a statement in the log-book and reports to the Board of Trade. Money disbursed by consuls on account of the illness or injury of seamen is generally recoverable from the owner. With regard to passenger vessels, the master is bound to give the consul facilities for inspection and for communication with passengers, and to exhibit his "master's list," or list of passengers, so that the consul may transmit to the registrar-general, for insertion in the Marine Register Book, a report of the passengers dying and children born during the voyage. The consul may even defray the expenses of maintaining, and forwarding to their destination, passengers taken off or picked up from wrecked or injured vessels, if the master does not undertake to proceed in six weeks; these expenses becoming, in terms of the Passenger Acts 1855 and 1863, a debt due to Her Majesty from the owner or charterer. Where a salvor is justified in detaining a British vessel, the master may obtain leave to depart by going with the salvor before the consul, who after hearing evidence as to the service rendered and the proportion of ship's value and freight claimed, fixes the amount for which the master is to give bond and security. In the case of a foreign wreck the consul is held to be the agent of the foreign owner. Much of the notarial business which is imposed on consuls, partly by statute and partly by the request of private parties, consists in taking the declarations as to registry, transfers, &c., mentioned in Schedules B, C, F, G, H, L of the Mercantile Shipping Act. Under commercial treaties with China, British consuls in the free ports of Canton, Amoy, Foo-chow-foo, Ningpo, and Shanghai have extensive judicial and executive powers. The same observation applies to Japan. (See Order in Council of 9th March, 1865, and relative rules.)

The position of United States consuls is minutely described in the Regulations, Washington, 1870. Under various treaties and conventions they enjoy large privileges and jurisdiction. By a treaty with Sweden in 1818 the United States Government agreed that the consuls of the two states respectively should be sole judges in disputes between captains and crews of vessels. By convention with France in 1857 they likewise agreed that the consuls of both countries should be permitted to hold real estate, and to have the "police interne des navires à commerce." In Eastern Asia an exclusive jurisdiction, civil and criminal, is always stipulated in cases where United States subjects are interested. Exemption from liability to appear as a witness is often stipulated. The question was raised in France in 1843 by the case of the Spanish consul Solter at Aix, and in America in 1854 by the case of Dillon, the French consul at San Francisco, who, on being arrested by Judge Hoffmann for declining to give evidence in a criminal suit, pulled down his consular flag. So, also, inviolability of national archives is often stipulated. The archives of a French consul in London were once seized by a collector of local taxes and sold by auction, and in 1858 the flag, seal, arms, and record-book of the United States consulate at Manchester were levied on for a private debt of the consul. To the consuls of other nations the United States Government have always accorded the privileges of arresting deserters, and of being themselves amenable only to the Federal and not to the States courts. They also recognize foreign consuls as representative suitors for absent foreigners.

The United States commercial agents, although appointed by the president, receive no *exequatur*. They form a class by themselves, and are distinct from the consular agents, who are simply deputy consuls in districts where there is no principal consul. France is distinguished among nations for an organization of trained consuls who have intimate relations with the diplomatic corps.

See De Militis, *Manuel des Consuls*, London and Berlin, 1837-1843; De Cussy, *Règlements Consulaires des principaux états maritimes de l'Europe et de l'Amérique*, 1851, and *Dictionnaire du diplomate et du Consul*, Leipsic, 1846; Fynn's *British Consul Abroad*; Report of Select Committee on Consular Service (Parl. Papers), 1872; Marten's, *Guide diplomatique*, Leipsic, 1866; and De Clercq, *Guide pratique des consulats*, 1858.

(w. c. s.)

CONSULATE OF THE SEA, a celebrated collection

of maritime customs and ordinances in the Catalan language, published at Barcelona in the latter part of the 15th century. Its proper title is *The Book of the Consulate*, or in Catalan, *Lo Libre de Consolat*. The earliest extant edition of the work, which was printed at Barcelona in 1494, is without a title-page or frontispiece, but it is described by the above-mentioned title in the epistle dedicatory prefixed to the table of contents. The only known copy of this edition is preserved in the National Library in Paris. The epistle dedicatory states that the work is an amended version of the *Book of the Consulate*, compiled by Francis Celelles with the assistance of numerous shipmasters and merchants well versed in maritime affairs. According to a statement made by Capmany in his *Codigo de los Costumbres Maritimas de Barcelona*, published at Madrid in 1791, there was extant to his knowledge in the last century a more ancient edition of the *Book of the Consulate*, printed in semi-Gothic characters, which he believed to be of a date prior to 1484. This is the earliest period to which any historical record of the *Book of the Consulate* being in print can be traced back. There are, however, two Catalan MSS. preserved in the National Library in Paris, the earliest of which, being MS. Espagnol 124, contains the two first treatises which are printed in the *Book of the Consulate* of 1494, and which are the most ancient portion of its contents, written in a hand of the 14th century, on paper of that century. The subsequent parts of this MS. are on paper of the 15th century, but there is no document of a date more recent than 1436. The later of the two MSS., being MS. Espagnol 56, is written throughout on paper of the 15th century, and in a hand of that century, and it purports, from a certificate on the face of the last leaf, to have been executed under the superintendence of Peter Thomas, a notary public, and the scribe of the Consulate of the Sea at Barcelona.

The edition of 1494, which is justly regarded as the *editio princeps* of the *Book of the Consulate*, contains, in the first place, a code of procedure issued by the kings of Aragon for the guidance of the courts of the consuls of the sea, in the second place, a collection of ancient customs of the sea, and thirdly, a body of ordinances for the government of cruisers of war. A colophon at the end of these ordinances informs the readers that "the book commonly called the *Book of the Consulate* ends here;" after which there follows a document known by the title of *The Acceptations*, which purports to record that the previous chapters and ordinances had been approved by the Roman people in the 11th century, and by various princes and peoples in the 12th and 13th centuries. Capmany was the first person to question the authenticity of this document in his *Memorias Historicas sobre la Marina, &c., de Barcelona*, published at Madrid in 1779-92. M. Pardessus and other writers on maritime law have followed up the inquiry in the present century, and have conclusively shown that the document, whatever may have been its origin, has no proper reference to the *Book of the Consulate*, and is, in fact, of no historical value whatsoever. The paging of the edition of 1494 ceases with this document, at the end of which is the printer's colophon, reciting that "the work was completed on 14th July, 1494, at Barcelona, by Pere Posa, priest and printer." The remainder of the volume consists of what may be regarded as an appendix to the original *Book of the Consulate*. This appendix contains various maritime ordinances of the kings of Aragon and of the councillors of the city of Barcelona, ranging over a period from 1340 to 1484. It is printed apparently in the same type with the preceding part of the volume. The original *Book of the Consulate*, coupled with this appendix, constitutes the work which has obtained general circulation in Europe under the title of *The Consulate of the Sea*, and which in the course of the 16th century was translated into the Castilian, the Italian, and the French languages. The Italian translation, printed at Venice in 1549 by Jean Baptista Pedrezano, was the version which obtained the largest circulation in the North of Europe, and led many jurists to suppose the work to have been of Italian origin. In the next following century the work was translated into Dutch by Westervan, and into German by Engelbrecht, and it is also said to have been translated into Latin. An excellent translation into French of "The Customs of the Sea" which are the most valuable portion of the *Book of the Consulate*, has been recently published by M. Pardessus in the second volume of his *Collection des Loix Maritimes*.

under the title of "La compilation connue sous le nom de *consulat de la mer*," whilst an English translation of "The Customs of the Sea," under that title, with the Catalan text, has been published for the first time by Sir Travers Twiss, in the appendix to the *Black Book of the Admiralty*, vol. iii, London, 1874. The introduction to the latter work contains a full account of the two Catalan MSS. in the National library in Paris, and of the various editions of the *Book of the Consulate*. (T. T.)

CONSUMPTION. See PHTHISIS.

CONTEMPT OF COURT is any insult offered to a court of justice, or any defiance or resistance to its authority. "If the contempt be committed in the face of the court, the offender may be instantly apprehended and imprisoned at the discretion of the judges, without any further proof or examination." In other cases, if the judges have reason to believe, from an *affidavit*, that a contempt has been committed, they make a rule calling on the suspected person to show cause why an *attachment* should not issue against him, or in flagrant cases the attachment issues in the first instance. (See ATTACHMENT.) The process of attachment merely brings the accused into the court; he is then required to answer on oath interrogatories administered to him, so that the court may be better informed of the circumstances of the contempt. If he can clear himself on oath he is discharged; if he confesses, the court will punish him by fine or imprisonment, or both, at its discretion. Both in courts of common law and courts of equity many acts are punished as contempts which are properly civil injuries, and the process of contempt enforced against them is, as Blackstone points out, to be looked upon rather as a civil execution for the benefit of the injured party than as a criminal process for a contempt of the authority of the court. Among the offences enumerated in the text-books as the most usual instances of contempt are the following:—(1) Disobedience of inferior judges and magistrates; (2) Wrongdoing by sheriffs, bailiffs, jailers, and other officers in executing the process of the law; (3) Malpractice of attorneys and solicitors; (4) Misbehavior of jurymen in collateral matters relating to the discharge of their duties; (5) Misbehavior of witnesses; (6) Disobedience of parties in a cause to an order of the court, non-payment of costs, non-observance of awards; (7) Those committed by other persons. Among those general contempts some, says Blackstone, "may arise in the face of the court, as by rude and contumelious behavior, by obstinacy, perverseness, or prevarication, by breach of the peace, or any wilful disturbance whatever; and others in the absence of the party, as by disobeying or treating with disrespect the king's writ or the rules and process of the court, by perverting such writ or process to the purposes of private malice, &c., by speaking or writing contemptuously of the court or judges acting in their judicial capacity, by printing false accounts (or even true ones without proper permission) of causes depending in judgment," &c.

The practice of the courts in punishing the last class of contempts is of great importance in these days, inasmuch as it involves the question of the liberty of the press. It will be seen from the following statement that the judges have assumed very extensive and arbitrary powers of interfering with the free discussion by the public of the proceedings in courts of justice.

A judgment prepared by Lord Chief-justice Wilmot in the case of an application for an attachment against J. Almon in 1765, for publishing a pamphlet libelling the Queen's Bench, is, although it never was delivered in court, constantly referred to as authoritative by later judges and writers. The chief-justice said that the offence of libelling judges in their judicial capacity is the most proper case for an attachment, for the "arraignment of the justice of the judges is arraignment of the king's justice; it is an impeachment of his wisdom and goodness in the choice of his judges, and excites in the minds of the people a general dissatisfaction with all judicial determinations, and indisposes their minds to obey them. To be impartial, and to be universally thought so, are both absolutely necessary for the giving justice that free, open, and uninterrupted current which it has for many ages found all over this kingdom, and which so eminently distinguishes and exalts it above all nations upon the earth." Again, "the constitution has provided very apt and proper remedies for correcting and rectifying the involuntary mistakes of judges, and for punishing and removing them for any perversion

of justice. But if their authority is to be trampled on by pamphleteers and news-writers, and the people are to be told that the power given to the judges for their protection is prostituted to their destruction, the court may retain its power some little time, but I am sure it will eventually lose all its authority." In several cases the judges have declared that while their administration of justice may be discussed fairly and *bona fide*, it is not open to a journalist to impute corruption. A recent writer (Shortt, *Law relating to Works of Literature*) states the law to be that the temperate and respectful discussion of judicial determination is not prohibited, but mere invective and abuse, and still more the imputation of false, corrupt, and dishonest motives, is punishable. In an information granted in 1783 against the corporation of Yarmouth for having entered upon their books an order "stating that the assembly were sensible that Mr. W. (against whom an action had been brought for malicious prosecution, and a verdict for £3000 returned, which the court refused to disturb) was actuated by motives of public justice, of preserving the rights of the corporation to their admiralty jurisdiction, and of supporting the honor and credit of the chief magistrate," Mr. Justice Buller said, "The judge and jury who tried the case, confirmed by the Court of Common Pleas, have said that instead of his having been actuated by motives of public justice, or by any motives which should influence the actions of an honest man, he had been actuated by malice. These opinions are not reconcilable; if the one be right the other must be wrong. It is therefore a direct insinuation that the court had judged wrong in all they have done in this case, and is therefore clearly a libel on the administration of justice." Many of the doctrines expressed in the above extracts go beyond the practice, if not the strict law of later times. The tendency has been to restrict the process of contempt to cases in which judges are insulted or defied in the discharge of their duties, or in which matters relating to a pending cause are publicly discussed. Bribes or menaces offered to the judges have been punished as contempts. In a recent case a judge of assize having ordered the court to be cleared on account of some disturbance, the high sheriff issued a placard protesting against "this unlawful proceeding," "and prohibiting his officers from aiding and abetting any attempt to bar out the public from free access to the court." The lord chief justice of England, sitting in the other court, summoned the sheriff before him and fined him £500 for the contempt, and £500 more for persisting in addressing the grand jury in court, after he had been ordered to desist.

The difference between pending and decided cases has been frequently recognized by the courts. What would be a fair comment in a decided case may tend to influence the mind of the judge or the jury in a case waiting to be heard, and will accordingly be punished as a contempt. This is distinctly laid down in the case of *Tichborne v. Mostyn*, where the publisher of a newspaper was held to have committed a contempt by printing in his paper extracts from affidavits in a pending suit, with comments upon them. In the case of the *Queen v. Castro*, it was held that after a true bill has been found, and the indictment removed into the Court of Queen's Bench, and a day fixed for trial, the case is pending; and it is a contempt of court to address public meetings, alleging that the defendant is not guilty, that there is a conspiracy against the defendant, and that he cannot have a fair trial; and the court will order the parties to answer for their contempt, and fine or imprison them at discretion. In another case the publication of a winding-up petition, containing charges of fraud, before the hearing of the petition was held to be a contempt of court. The courts may, if they choose, prohibit any publication of their proceedings while the litigation is pending. It is now the invariable rule of the English press to refrain from expressing an opinion on matters relating to any pending suit. On the other hand, the discussion of decided cases shares in the license now allowed to the expression of opinion on all public affairs in England.

The Scotch and colonial courts exercise the same power of committing for contempt as the English. It has been held in a case arising under the County Court Act, that inferior courts of record have only power over contempts committed *facie curiæ*. The county court judge has no power of proceeding against a person for a contempt committed out of court.

The proper punishment of contempt is by fine or imprisonment at the discretion of the court. In a recent case it was held that no person can be punished for contempt, unless the specific offence charged against him is distinctly stated, and an opportunity given him of answering it. When a barrister had been suspended from practice by the supreme court of Nova Scotia for addressing a letter to the chief justice which was a contempt of court, the Privy Council on appeal discharged the order, as substituting a penalty and mode of punishment which was not the appropriate and fitting punishment for the offence. The letter was written by the defendant in his individual capacity of suitor, and had no connection with his professional status or character.

Blackstone notices the exceptional character of the punishment provided for this offence. "It cannot have escaped the attention of the reader," he says, "that this method of making the defendant answer upon oath to a criminal charge is not agreeable to the genius of the common law in any other instance." There can be no doubt that the discretionary power of judges to punish summarily by fine or imprisonment offences committed against their own dignity is liable to abuse, and careful as English judges are in enforcing it, a trial and conviction in the ordinary manner would probably be more satisfactory. The offence is by no means clearly defined, but it will be generally agreed that it is desirable to prevent and punish insulting expressions and disorderly conduct in courts of justice, as well as any such publications as may really tend to prejudice a pending cause. A judge may safely be intrusted with the power of keeping order in his court, but contempts committed elsewhere should be proceeded against like other offences.

A similar power of punishing for contempt is exercised by the two Houses of Parliament. The question was discussed in the case of *Burdett v. Abbott*, where Lord Ellenborough said, "Can the High Court of Parliament, or either of the two Houses of which it consists, be deemed not to possess intrinsically that authority of punishing summarily for contempts which is acknowledged to belong, and is duly exercised as belonging, to every superior court of law of less dignity doubtless than itself?" It was at one time held that the "privilege of committing for contempt is inherent in every deliberative body invested with authority by the constitution;" and that accordingly it extended to colonial assemblies. This opinion has been overruled by subsequent decisions. Baron Parke, in the case of *Kielley v. Carson*, says that the power of punishment for contempt attaches to bodies having judicial functions, and is an incident of those functions, except only in the case of the House of Commons, whose authority in this respect rests upon ancient usage. The Legislative Assembly of Victoria is entitled by enactment to the privileges, immunities, and powers held, and enjoyed, and exercised by the English House of Commons. Where a legislative assembly has the power of committing for contempt, the punishment lasts only till the end of the current session. "Though the party should deserve the severest censure," says Lord Denman, "yet his offence being committed the day before a prorogation, if the House ordered his imprisonment but for a week, every court in Westminster Hall, and every judge in all the courts would be bound to discharge him by *habeas corpus*." See **PRIVILEGE.** (E. R.)

**CONTI, PRINCE OF**, the title assumed by a younger branch of the House of Condé. Armand de Bourbon, prince of Conti (1629-1666), one of the princes of the blood who took part in the wars of the Fronde, was son of Henry, prince of Condé, and brother of the Great Condé. Originally destined for the church on account of the weakness of his health and the deformity of his person, he received several rich benefices, and studied at the Sorbonne, but did not enter into orders. Wanting in strength of character, he was throughout life the follower of his sister, the duchess of Longueville, whose influence over him was such as to give rise to scandal. He was induced by her to join the old Fronde, and was appointed commander-in-chief of its forces during the siege of Paris (1648); but he contented himself with riding every day at their head through the streets, never failing to leave them as they passed out of the gates. At the end of the contest the whole Condé family came into political agreement, and Conti shared his brother's imprisonment (1650). After his release his engagement to be married to the profligate Mlle. de Chevreuse was broken off by the

prince of Condé, who had been won over to the court party by extravagant promises. In Condé's second rebellion Conti was concerned; but when the former fled to Spain, he made his peace with the court, married Mazarin's niece, and obtained the government of Guienne, together with the command in Catalonia, in which latter capacity he was not distinguished. He followed his sister in her conversion, entering into all her enthusiastic views, and maintaining constant correspondence with her. He wrote *Du devoir des grands et des devoirs des gouverneurs de province*; *Lettres sur la grace*; and *Traité de la comédie et des spectacles selon la tradition de l'Eglise*. (See the numerous *Mémoires* of the time and the *Lettres de Mme. de Stovigné*.) His second son, François Louis, prince of Conti (1664-1709), fought with much distinction in several campaigns; and, being distinguished by information, wit, attractive manners, and never-failing affability, he enjoyed, heartless as he was, a wonderful popularity. But this very popularity, together with a sneer he had incautiously uttered against the king, caused his banishment to Chantilly. In 1697 he was elected king of Poland, but on reaching that country he found the throne in the possession of the elector of Saxony, and at once retired without making any attempt to dispossess his rival. (See the *Mémoires de Saint-Simon*, and Desormeaux, *Histoire de la Maison de Bourbon*.) Louis François, prince of Conti (1717-1776), the grandson of François, was a brave and popular general. He was engaged in the war caused by the claims of Maria Theresa to the imperial throne; he commanded the army which crossed the Alps into Italy and defeated the Sardinians in 1744; and he also served in Germany and Flanders in 1745 and 1746. Not, however, being allowed to take part in the Seven Years' War, he supported the Parliament of Paris against the court, and earned the nickname of "the Advocate." His son was the last of the house of Conti.

**CONTRABAND** (Low Latin, *contrabanum*) means, according to Ducange, "merces *banno* interdicta," and was originally applied to a prohibited domestic trade in time of peace, such as that in salt. The term does not occur in the *Guidon de la Mer*, or in Grotius, and is first used to denote a prohibited neutral trade with a belligerent in the Treaty of Southampton (17th September, 1625) between Charles I. and the States-General of Holland. That treaty declared that all provisions (*munitions de bouche*), provisions of war, ships, arms, sails, &c., silver, iron, &c., carried to Spanish ports, would along with the carrier ships and their crews be good prize. It was partly from the general use of such treaty-stipulations with neutrals, and partly from the custom of belligerents at the beginning of a war to issue declarations which they formally intimated to neutrals, and which forbade all trade in certain articles with the ports of their enemies, that the international law of contraband grew up. An example of the latter mode of proceeding is the "Placaart" issued in 1599 by the States-General, which, like the Berlin Decrees, completely interdicted all trade with Spain. The Treaty of Southampton itself was followed by two proclamations, which assume a belligerent right to place restrictions on neutral commerce, and which go the length of authorizing private ships to capture neutral bottoms carrying contraband. The practice of contraband is of course much older than the name. Thus in the Code of Justinian (iv. 41, 42) Marcian prohibits the sale to *barbari alienigenæ* of oil, wine, several specified kinds of arms, and generally of iron. So also the Decretals, Gregory IX. (v. 6-12), and the Bull "In Cena Domini," c. 7, denounced excommunication against such as should supply Saracens with arms. It is in the 17th century that the military policy and commercial interests of the various European nations begin to be indicated in their treaties relating to contraband. Opinion varied so much with the political situation, that it is difficult to extract from these treaties the prevailing custom even of a single nation. At first provisions, that is, corn, &c., seem generally to have been excluded from the list, and in 1674 a great English lawyer, Sir Leoline Jenkins, told Charles II. that nothing ought to be deemed contraband "but what is directly and immediately subservient to the use of war, except it be in the case of besieged places" (which raises the distinct question of blockade), or of a "general certification by Spain to all the world." The definition of the French Ordinance de la Marine of 1681 is also limited to munitions of war, and even to such as have "la forme d'un instrument

pouvant servir directement à l'usage de la guerre." On the other hand, the early writers on contraband, such as Dr. Zouch (*De Jure Fœdali*, 1634) and Albericus Gentilis (*Advocationes Hispanicas*), in discussing the question "An res amicorum ad hostes transeuntes interciperi liceat?" seem to assume that the belligerent has, apart from treaty, a right indefinitely to vary the list of articles constituting munitions of war, and it is clear that the test of "immediate subserviency" must vary with the character of the hostilities, the resources of the combatants, and the actual position of the conflict. In 1543 the English envoy, Sadler, challenged the Scotch fish trade to France as a species of "aid," a word often used in the older treaties of alliance, but which can scarcely have been intended to cover the case of habitual trade; and in 1589 Queen Elizabeth successfully justified the capture of a fleet of sixty vessels belonging to the Hanse confederation, and carrying corn and naval munitions to Spain.<sup>1</sup> In all these cases some ordinance, placarta, or treaty was appealed to, but these documents were of course liable to *ex post facto* interpretation, and such interpretations were acquiesced in from necessity or from motives of policy. A powerful neutral, dissatisfied with the decision of the captor's prize court, might issue letters of reprisal. This was done by England when a cargo of tobacco, bound for Holland, was condemned in Spain on the ground that by its use "the consumption of victuals might be prolonged." The general principle, before the writings of Grotius permanently affected the public law of Europe, was, therefore, that the private right of neutral merchants to free trade must yield to the public right of the belligerent to put such limits on neutral trade as were reasonably necessary in the conduct of war,—that right being exercised in a public and legal manner. After the Peace of Westphalia, the grand pensionary of Holland, John de Witt, contended strongly for the extension of neutral rights, and in 1662 by treaty with France the Dutch adopted the definition of contraband in the 12th and 13th articles of the Treaty of the Pyrenees between France and Spain (1659), which included munitions of war, and specially excluded almost everything in the nature of ordinary provisions. For some time England maintained (as in her treaty of Whitehall with Sweden, 1661) the doctrine that money, ships, and provisions were to be deemed contraband, but in her Treaty of Breda with Holland (1667), and her Treaty of St. Germain-en-Laye with France (1677), she practically adopted the rule of the Pyrenees, with this extension, that the neutral trade might take place even between two enemy ports, provided neither was blockaded. This explains the singular agreement made by England and Holland in 1689 for a wholesale blockade of the ports, harbors, and roadsteads of France. The treaties of the 18th century proceeded for the most part on the Treaty of Utrecht, "which embodied the French doctrine of contraband" (Hall, *Rights and Duties of Neutrals* 1874). As, however, some powers never contracted with each other on the subject, and as the treaties made were for limited periods, and were often broken by the outbreak of war, there was plenty of room for controversy and for the enforcement of national opinions. The classical division of contraband by Grotius was as follows: "Sunt res quæ in bello tantum usum habent, ut arma; sunt quæ in bello nullum habent usum, ut quæ voluptati inserviunt; sunt quæ et in bello et extra bellum usum habent, ut pecuniæ, commeatus, naves, et quæ navibus adsunt." The only difficulty arises in connection with the third class, of which Grotius says that the state of the war must be considered, and that "if seizure is necessary for defence, the necessity confers a right of arresting the goods" (*De Jure Belli et Pacis*, III. 1. 5). A leading question in the 18th century was whether naval stores should be deemed contraband, the Baltic powers (supported by the writings of Heineccius and Valin) inclining to the affirmative, while Bynkershoek (*Quæst. Jur. Pub.* i. 10, 1737) and Lampredi (*Del. Commercio dei Popoli Neutrali in Tempo di Guerra*, § 70) maintained, in conformity with the 20th article of the Treaty of Utrecht, that goods, though possibly of warlike use, were not contraband, if not worked into the form of an instrument of war. Other authors, as Vattel (*Droit des Gens*, iii. 7, 112) and Heineccius (*De navibus ob vecturam veteriarum mercium commissis*, *Comm.* xiv.), attached great value to the fact of urgent need among the enemy—"si hostis laboret inopiâ"—and were prepared on this ground even to include

provisions as contraband. The first armed neutrality of 1780, alarmed by the growing naval power of Great Britain, declared that only munitions of war and sulphur should be contraband. (This is the *kriegs-contrebande* of German jurists. See Lord Grenville's *Letters of Sulpicius Ward*.)<sup>2</sup> In 1793 both England and France made large seizures of provisions, the former pretending that there was a chance of reducing France by famine, and the French executive having assumed the direction of the whole corn trade of their country. Both sides were wrong, and were nobly rebuked by the counter declaration of the Danish minister, Count Bernstorff, in which he explained that a neutral was neither a party nor a judge, and could take no notice of a reciprocity of injuries. The United States also energetically protested against the notion that provisions, not destined to a blockaded port, could in any circumstances be contraband,—a position inconsistent with the modern American doctrine that an actual *military* destination even of luxuries will impress on the cargo a contraband character. The second armed neutrality of 1800 took up the same position as the first; and in 1803 England and Russia agreed that money, horses, ships, and manufactured articles for naval use were to be confiscated, naval stores, the produce of either country, being brought in for pre-emption. The only existing treaties of England on this subject are those with Portugal in 1820 (munitions of war, sulphur, horses, money, and naval stores) and with Brazil in 1827 (munitions of war and naval stores). Throughout the French wars, however, the law administered by Lord Stowell and others in the English prize court was much harsher than the treaty obligations of the nation. The circumstances which Lord Stowell considered favorable to a cargo were these:—1. Its being the product of the neutral country, and therefore a natural export; 2. Its being in an unmanufactured state, as hemp or iron; 3. Its destination to a commercial not a military port ("Jonge Margaretha," 1 *Rob. Adm. Rep.*). Among modern jurists Ortolan (*Diplomatie de la Mer*, ii. 190) and Heffter (*Le Droit International*, § 160), as quoted by Hall, agree that contraband cannot be limited to munitions of war, but must extend to raw materials and merchandise, if clearly destined for actual and immediate military use. Ortolan expressly excludes provisions under all circumstances, but the tendency of modern decision is to bring all articles to the test proposed by Mr. Dana, the editor of Wheaton,—“the right of the belligerent to prevent certain things from getting into the military use of the enemy,”—a principle which is obviously independent of the innocent or fraudulent intention of the owner of the cargo. Mr. Hall proposes a classification of contraband goods, not being munitions of war, based on their more or less intimate connection with military operations. Among these he includes horses, saltpetre, sulphur, materials of naval construction, such as timber, cordage, pitch (stated by the British Government during the Crimean war to be contraband), marine engines, &c., and coal, if its immediate destination be military. Thus in the Franco-German war, 1870, vessels laden with coal were forbidden to sail from English ports to the French fleet in the North Sea. France, on the other hand, still holds by the decision in the case of "Il Volante" (an Austrian ship laden with *bois de construction* from Lisbon to Messina, and captured in 1807 by the French cruiser "Etoile de Bonaparte"), that ship's timber and naval stores are not contraband. Provisions of very various kinds, biscuits, cheese, wine, corn, have both in England and America been held contraband (The "Commercen," 1 *Wheaton's Reports*).<sup>3</sup> A ship, available for war, and sent to an enemy's port with instructions either to sell or charter, has been condemned in England. The general subject of ships, however, belongs to the subject Neutrality. With regard to clothing, money, and unwrought metals, there are no recent decisions, but the rule would probably be applied that they may become contraband in certain circumstances. The ordinary penalty of carrying contraband is confiscation of cargo, but where the capture is only justified by special circumstances, or, as it is sometimes expressed,

<sup>1</sup> *Essay on Contraband*, London, 1801; Lord Liverpool's *Discourse on the conduct of the Government of Great Britain in respect to Neutral Nations*, London, 1801.

<sup>2</sup> The "Commercen" was a Swedish vessel, carrying English provisions to a Spanish port for delivery to the British commissariat in the Peninsular War. Sweden and Spain were British allies in the war with France, but neutral in the war with the United States, and there was no alliance between France and the States. The particular cargo was therefore (unjustly) condemned as enemy's goods but doctrines were laid down as to contraband.

<sup>3</sup> Continental jurists called this an attempt to starve Spain out.

where the contraband is "conditional," and where the cargo is ordinary neutral produce, and there is perfect *bona fides* of the owner, the ship is merely carried in for pre-emption, which means the owner's value plus 10 per cent, with indemnity for freight and expenses of detention. Anciently, in cases of absolute contraband, both ship and cargo were forfeited; it is said Russia still does this. The right of pre-emption (*droit d'achat*) is stated by Lord Stowell to apply to all cargoes whatever bound for an enemy's port; and it is settled that any attempt at fraud, as false papers, or a concealed destination, will disentitle the owners to compensation. The same circumstances occurring in the case of a cargo of absolute contraband, even where the ship does not belong to the owner of the contraband, may forfeit the ship.

It will be remembered that the blockade runners of the American civil war raised very nice questions on this point. It was impossible to prove that these vessels after leaving Nassau were not going to Matamoras in Mexico, for they had only a floating intention of "running." The question, therefore, which came before the Supreme Court of the United States in the "Bermuda" and "Peterhoff" cases was whether the interposition of a neutral port between the neutral point of departure and the belligerent destination did protect the cargo which was admitted to be contraband. There could be little doubt that the goods went straight through Texas to the Confederate States. But in several cases these cargoes were not condemned. The "Peterhoff's" cargo was army boots, artillery harness, regulation blankets, chloroform, and quinine.

Where the shipowner is innocent and does not own the cargo, he merely loses his freight and expenses. Contraband articles also involve innocent parts of a cargo in confiscation when both belong to one owner. The United States and Prussia are the only powers that have chosen the bold plan of entirely renouncing by treaty between themselves the right of confiscation, for which they have substituted an unlimited right of stoppage and detention and appropriation, subject to full compensation. This is an arrangement which may probably become more common, and will of course much weaken the effects of the law of contraband. It is impossible to prevent the seizure of private property in war, but it has been suggested that the value should be at once paid over by the captor's government to the neutral government for distribution. There is only one case in which a return cargo has been confiscated on the ground that the outward cargo was contraband, with fraudulent papers and fraudulent destination; the voyage was a long one,—to the East Indies. Where a neutral vessel carries despatches to a belligerent, as the ship has become a quasi-servant of the enemy, the captor generally not only seizes the papers but confiscates the ship. Despatches from or to accredited diplomatic agents or consuls residing in a neutral country do not fall under this rule, the neutral having an interest in their safe transmission. But ignorance of the contents of despatches addressed to military officials, or unaccredited agents, will not excuse their carriage. Even where the despatches have been received through force or imposition, the English prize court holds that the carrier is liable, because his suspicions ought to have been roused. A very difficult question rose in the American civil war with regard to the searching of mail bags. If the right were renounced absolutely, all belligerent despatches would choose this safe route. It was arranged that all British mails, certified to be such, should on capture be forwarded unopened. The carriage of persons in the service of a belligerent also leads to confiscation of the ship, if it amount to an intentional assistance of the belligerent. The persons carried may be mere civilians, and the port of destination neutral. The most common case is the carriage of soldiers. The exception to this rule is the case of transport of diplomatic agents, which is generally recognized as lawful, but which in the Trent affair the United States Government repudiated.

Besides the works mentioned the following may be consulted:—Twiss, *On the Rights and Duties of Nations in time of War*; Phillimore, *Commentaries on International Law*, iii, where the literature of the subject is fully noticed; Wheaton's *Elements of International Law*; *Neutrality Laws Commissioners' Report*, State Papers, 71, 1871. (w. c. s.)

CONTRACT is a bargain or agreement enforceable by law. The law of contract occupies so large a space in all

civilized systems of law, that only a few of its more leading principles can be conveniently stated here. There is a general harmony in the jurisprudence of modern nations on this subject which is not to be found in other departments of law. The following definitions are taken from the Indian Contract Act, 1872:—

- a. When one person signifies to another his willingness to do or abstain from doing anything with a view to obtaining the assent of that other to such act or abstinence, he is said to make a proposal.
- b. When the person to whom the proposal is made signifies his assent thereto, the proposal is said to be accepted. A proposal when accepted becomes a promise.
- c. The person making the proposal is called the promiser, the person accepting the proposal the promisee.
- d. When at the desire of the promiser, the promisee or any other person has done or abstained from doing, or does or abstains from doing, or promises to do or abstain from doing something, such act or abstinence or promise is called the consideration for the promise.
- e. Every promise and every set of promises forming the consideration for each other is an agreement.
- f. Promises which form the consideration or part of the consideration for each other are called reciprocal promises.
- g. An agreement not enforceable by law is said to be void.
- h. An agreement enforceable by law is a contract.
- i. An agreement which is enforceable by law at the option of one or more of the parties thereto, but not at the option of the other or others, is a voidable contract.
- j. A contract which ceases to be enforceable by law becomes void when it ceases to be enforceable.

These definitions, with some changes of expression in the direction of greater precision, are in effect the same as those which are found in English law books. The phrase "void contract," which would be a contradiction in the Indian definitions, is frequently used in English law.

The exchange of proposals and acceptances by correspondence gives rise to some peculiar difficulties. An offer or proposal may be revoked any time before acceptance; and it is revoked when notice to that effect is given to the promiser. So much is clear and free from difficulty. But when letters containing proposals or acceptances are delayed or misdirected, it is not very easy to say whether there has been a contract or not. When A wrote to B, "I offer you 800 tods of wether fleeces, &c," "receiving your answer in course of post," but misdirected the letter, which arrived late, and B's answer accepting the offer not arriving at the expected time, A sold the goods to some one else, it was held that as the delay was caused by A's fault, it must be taken as against him that the answer did not arrive in course of post (*Adams v. Lindsell*, 1 B. and Ald. 681). In cases following this some of the judges seem to be inclined to hold that a proposer is bound by an acceptance being posted to him whether it reaches him or not, and others that he is not bound unless he actually receives the acceptance. An acceptance of a proposal must be unqualified, otherwise there is no contract; the introduction of a new condition by the acceptor, or a reference to something still to be done, prevents the contract from being completed. To constitute a contract the terms must be certain; e. g., an agreement to take a house, "if it were put into thorough repair, and the drawing-rooms handsomely decorated according to present style," has been rejected as too vague. A contract of course may be concluded by mere conduct, without the exchange of a single word, and multitudes of contracts in small matters of constant occurrence are so concluded. These are called *implied contracts*—a phrase, however, which covers two very different things—(1) a real contract which may be inferred as a fact from the conduct of the parties, and (2) a quasi contract, in which the law will treat the parties as if they had made a contract.

Certain classes of persons are under peculiar disabilities in matters of contract, viz., infants, lunatics, and married women. 1. As a general rule at common-law contracts made by an infant (a person under twenty-one years) are voidable, unless they are in some way for his benefit, and in particular for "necessaries." By the Infants' Relief Act, 1874, contracts for repayment of money lent to infants, or for payment of goods other than "necessaries," are made absolutely void; and no action can be brought, even if they are ratified after full age and for a new consideration. The question what are necessaries is to be decided by the court and jury on the circumstances of the case, including par-

ticularly the rank in life of the infant. The protection of infants has been extended by the Court of Chancery to "expectant heirs" as they are called, i. e., persons who borrow money on the credit of their expectations. The principle is a survival from the times when usury was considered wrongful, and the preservation of great families a public duty, and is utterly indefensible on any other considerations. 2. A married woman, being in the eye of the law merged in her husband, cannot bind herself by contract. 3. Contracts made by a lunatic are voidable, except where his state of mind was not known to the other contracting party. The principle is extended to drunkenness. For further information as to such disabilities see under the respective headings. The general rule as to corporations is that they can only make binding contracts under their common seal, excepting in cases of "convenience almost amounting to necessity" (see CORPORATIONS).

Of the technical terms mentioned above the most important, and certainly the most characteristic, of English law is *consideration*. A consideration is essential to the validity of every contract unless it be made in writing under seal. The meaning of the word is quite accurately expressed by a phrase used in one of the earliest cases on the subject—it is strictly a *quid pro quo*. Something, whether it be in the nature of an act or a forbearance, must move from one of the parties in order to support a promise made by the other. A mere promise by A to give something to B cannot be enforced unless there is some consideration "moving from B." Such a promise the early lawyers called a nude or naked promise—in imitation of the phrase in Roman law, *nudum pactum*, which does not, however, mean a promise unsupported by a consideration, but a contract destitute of certain essential legal formalities. But while every contract requires a consideration, it is held that the court will not inquire into the adequacy thereof; any consideration will do. Inadequacy of consideration, however, may be important where a contract is to be set aside on the ground of fraud.

Modern English law requires no formalities to make a contract enforceable, unless in certain special cases. The ancient rule both in early English and Roman law made certain formalities essential, unless in certain special cases. The ancient rule is thus the modern exception. The exceptions to the general rule in English law are the following:—

1. Contracts within the Statute of Frauds, 29 Car. II. c. 3.—The fourth section of this important Act specifies certain classes of contracts in which "no action shall be brought" unless the agreement upon which such action shall be brought, or some memorandum or note thereof, shall be in writing and signed by the party to be charged therewith, or some other person thereunto by him unlawfully authorized. Such contracts are—(1) any special promise by an executor or administrator to answer damages out of his own estate; (2) any promise to answer for the debt, default, or miscarriage of another person; (3) any agreement made on consideration of marriage; (4) any contract or sale of lands, tenements, or hereditaments, or any interest in or concerning them; (5) any agreement that is not to be performed within the space of one year from the making thereof. The seventeenth section enacts that no contract for the sale of any goods, wares, or merchandise for the price of £10 sterling or upwards shall be allowed to be good, except the buyer shall first accept part of the goods so sold, and actually receive the same, or shall give something in earnest to bind the bargain or in part payment; or unless some memorandum or note in writing of the said bargain be made and signed by the parties to be charged, or their authorized agents. The difference between the two sections should be noted. Contracts under the 17th section are simply void; contracts under the 4th are not void, but they are not enforceable. The 4th section is a law of procedure, and therefore a contract of the kind specified therein validly made in a foreign country could not be enforced in England, whereas a valid contract made abroad, which would be wholly void if made in England, under the 17th section, might be enforced in England. And again, money paid under an agreement made unenforceable by section 4 could not be recovered back.

2. Contracts of corporations, already alluded to.

3. Negotiable instruments, which must, of course, be in writing.

4. Other cases in which writing is required are transfer of ships, assignments of copyright, and ratification of debts barred by the Statute of Limitations.

To contracts made by deed (i. e., under seal) the law

attributes certain qualities which do not belong to simple contracts, i. e., contracts whether verbal or in writing without seal. The peculiar properties of a deed are thus described:—"It works a merger; it operates by way of estoppel; it requires no consideration to support it; it will in some cases bind the heir of the covenantor or obligor; it can only be discharged by an instrument under seal, by the judgment of a court of competent authority, or by Act of Parliament." The language of the law-books is that from the solemnity of a deed the law itself will imply the existence of a consideration, a formula designed to bring the exceptional case of deeds within the general legal theory of consideration, and by no means to be accepted as an historical explanation. The subordinate agreements in a deed are termed covenants. The formal definition, as given in Platt on *Covenants*, is "an agreement between two or more persons by an instrument in writing sealed and delivered, whereby some of the parties engage, or one of them engages with the other or others of them, that some act hath or hath not been already done, or for the performance or non-performance of some specified duty." See DEED.

An agreement is said to be void for impossibility when the thing contemplated is in itself impossible, as contrary to the course of nature, and when it is by construction of law impossible, e. g., to create a new manor. But when the thing is not in itself impossible, but is or becomes impossible in fact, an unconditional agreement is not thereby void. Thus a contract to load a full cargo of guano at a certain island does not become void by the fact that there is not enough guano on the island to make a full cargo. In a recent case (*Thorn v. Lord Mayor of London*) a contractor, who had undertaken to build a bridge according to specifications supplied by defendant, found it impossible to execute part of the work according to specification, and it had to be executed in another way. It was held that there was no condition that the plans should be reasonably practicable, and the plaintiff was not allowed to recover for work executed in an impossible attempt to comply with the specifications. In another case, a contractor bound himself under penalties to finish some buildings within a certain time, with any alterations and additions required by the defendants, and no extension of time was to be allowed for such alterations, unless expressly granted by defendants. It was held that the contractor could not excuse himself for non-completion within the proper time by showing that the alterations and additions made it impossible.

Besides the contracts which are void through defect of form or want of capacity in the parties, there is a large class of agreements which the law refuses to recognize on account of the character of the contemplated action. These may be reduced to three main divisions—*illegal* contracts, when the thing to be done is forbidden by law; *immoral* contracts, when the consideration belongs to the indefinite class of things recognized as immoral; and contracts *against public policy*, i. e., certain wide and more or less indefinite principles of government. In some cases, the act of agreement is in itself a criminal offence, for which see CONSPIRACY. An agreement to commit an offence, as to burn a house, or kill a man, or an agreement to do a civil injury to another, would be illegal. Promises made in consideration of illicit cohabitation in the future are void as immoral; if the consideration is illicit cohabitation in the past, it is of course no consideration, and a promise founded upon it will be void unless expressed in a deed. Of agreements which are void as being against public policy, the most important class is that of contracts in restraint of trade. The leading authority on this subject is the case of *Mitchell v. Reynolds* (1 *Smith's Leading Cases*). The law, it seems, is so jealous of the freedom of the trader, that it will not allow him to part with it on any consideration. "It is the privilege of a trader in a free country, in all matters not contrary to law, to regulate his own mode of carrying it on according to his own discretion and choice. If the law has regulated or restrained his mode of doing this, the law must be obeyed. But no power short of the general law ought to restrain his free discretion." It has been suggested that the rule dates from a time when a covenant by a man not to exercise his own trade meant a covenant not to exercise any trade at all,—every man being obliged to confine himself to the trade to which he had been apprenticed. At any rate, it is difficult to reconcile

this protection of the individual will, carried to the point of absolutely limiting its exercise in one class of cases, with modern principles as to freedom of trade and contract. And the law itself breaks in upon its own theory by admitting that contracts which are only in *partial* restraint of trade may be good. A contract not to carry on the business of an ironmonger would be bad; but a contract made by the seller of an ironmonger's business not to compete with the buyer would be good. It is held that to make such a promise binding, it must be founded on a valuable consideration, must not be unlimited as to the area over which the restriction is to extend, and must not otherwise go beyond what is reasonably necessary for the protection of the other party. On the whole, it would be simpler to leave individuals to make what contracts they please in this as in other matters. The public policy which disallows contracts in restraint of marriage depends on a different set of considerations. A contract not to marry at all is void; in one case it is described as a contract to omit a moral duty, and tending to depopulation, "the greatest of all political sins." But apparently a contract by a widow not to marry is not void. The whole doctrine of public policy appears to have grown up out of the efforts of judges to counteract the admission of wagers in the common law as legal contracts. In their desire to avoid enforcing them in particular cases, they developed a theory of state interests of startling wideness and originality. A wager about the death of Napoleon I. was held void because it gave one party an interest in keeping the king's enemy alive, and the other an interest in putting him to death. (See Pollock on *Contracts*, p. 252.)

Contracts may be vitiated by mistake, misrepresentation, fraud, undue influence, &c. Mistake, to avoid a contract, must be such that there was no real agreement at all, or that the real agreement was erroneously expressed; and money paid under a mistake as to fact may be recovered. The general rule is that relief will be given against mistake as to fact, but not against mistake in law. Contracts induced by fraud, misrepresentation, &c., are in general not void but voidable at the instance of the party injured or imposed upon.

The common law did not permit the benefit of contracts to be assigned so as to give the assignee a right of action in his own name—a right which was, however, recognized in equity. By the Judicature Act, 1873, section 6, a legal right is created in the assignee when the assignment is absolute and in writing, and notice in writing given to the debtor.

The only remedy for breach of contract given by the common law was an action for the sum certain due by the defaulter, or for damages, to be ascertained by a jury. The mere payment of damages would in many cases not be a complete satisfaction to the other party, and the Court of Chancery accordingly gave in certain cases decrees for the specific performance of the contract.

The best English works on Contract are those by Addison, Chitty, and S. Martin Leake. The *Principles of Contract at Law and in Equity*, by F. Pollock, is a recent work of great merit. (E. R.)

CONVERSANO, an episcopal city of Italy, in the province of Terra di Bari, and 20 miles south-east of the city of Bari, with about 10,000 inhabitants. It has a castle, a cathedral, several convents, a diocesan seminary, a hospital, and a foundling asylum. Some trade is carried on in wine, oil, almonds, and cotton.

CONVEYANCING, the art of preparing writings to effect the transference or conveyance from one person to another of any piece of property or valuable right. It is sometimes applied in a restricted sense to the cumbrous forms which the feudal system has rendered necessary for the transference and tenure of landed property. When left to shape itself by individual practice, without legislative intervention, there were several causes rendering such conveyancing cumbrous and complex. The theory of the feudal tenures and hierarchy remaining unchanged throughout the social revolution which had virtually abolished superiority and vassalage, and brought land out of feudality into ordinary commerce, it became necessary to retain the feudal ceremonies of the Middle Ages, and to adapt them by fictions and explanations to modern exigencies. Hence, many years have not yet passed since, in Scotland, when a field was bought and sold, a party of men assembled on it, and went through the old form of symbolic investiture

by the delivery of so much earth and stone from the superior bailiff to the vassal's attorney, who took instruments and had the whole recorded at length by a notary of the empire. In England, from the want of the general system of registration known in Scotland, the complexities of conveyancing had become so inextricable, that one of the most approved forms of transference was a fictitious suit and judgment of possession called a fine and recovery. To these innate sources of complexity must be added the timidity of conveyancers, who, afraid to commit themselves by attempting to abbreviate or reconstruct the forms which they find in existence, repeat them with additions from time to time as new circumstances must be provided for. Hence, to keep conveyancing within rational bounds, the legislature must interfere from time to time to sweep away excrescences, and provide brief and simple forms. This, however, is a task which cannot be easily accomplished, since it requires the very highest legal skill to adjust simple forms to all exigencies, and anticipate the various shapes in which property may fall to be dealt with. This service has been on various occasions performed by distinguished lawyers; and, while it is productive of the greatest benefits to society, it is one of the public services least susceptible of popular appreciation. In 1834 the Act abolishing fines and recoveries created a reform in this kind in the conveyancing of England, and a series of statutes passed in 1847 purified and simplified the conveyancing of Scotland.

An attempt was made in 1862 to simplify the practice of conveyancing by two Acts—one entitled an Act to Facilitate the Proof of Title to and Conveyance of Real Estate, and the other the Declaration of Title Act, 1862. The former (called also the Land Registry Act) provided for the registration of real estates and of the title thereto. The latter was intended to enable persons having interests in land to obtain a declaration of their title by which they could give an indefeasible title to any person purchasing from them. Both statutes have failed; of the latter a standard book of practice says, "it is deemed unnecessary to detail its provisions." A commission, reporting in 1868, attributed the failure of the Registry Act to the principle of registering indefeasible titles only. The "Act aimed at a standard of certainty and perfection of title beyond what is ordinarily required in conveyancing transactions, and hence as a natural consequence instead of facilitating it was found in practice to impede the transfer of land." Another attempt has been made by the Land Transfer Act of 1875, which allows the registration of a possessory, as well as of an absolute, title. It is the opinion of an eminent conveyancer that the statute will probably achieve a success greater than that achieved by its predecessors, but less than that which would be commensurate with the ability and labor with which it has been framed.

Conveyancing, which in Scotland forms part of the ordinary business of a solicitor, is in England almost a profession by itself. It is to a large extent undertaken by barristers who devote themselves specially to the work. There is also a class of conveyancers, qualified to be called to the bar, but not called, who practice under annual certificates.

An Act was passed in 1868 to consolidate the statutes relating to the constitution and completion of titles to heritable property in Scotland, and to make certain changes on the law of Scotland relating to heritable rights, and an Amendment Act was passed in the following year. In 1874 the Conveyancing (Scotland) Act was passed, having for its object to amend the law relating to land rights and conveyancing, and to simplify the law.

CONVOCAATION, an assembly of the spirituality of the realm of England, which is summoned by the metropolitan archbishops of Canterbury and of York respectively, within their ecclesiastical provinces, pursuant to a royal writ, whenever the Parliament of the realm is summoned, and which is also continued or discharged, as the case may be, whenever the Parliament is prorogued or dissolved. This assembly of the spirituality, which is at present summoned only in pursuance of a writ from the Crown, differs in its constitution and purpose in the purport for which it is summoned from an ordinary provincial council, such as the two metropolitan archbishops of England have also been in the habit of summoning from time to time; for whereas the ordinary provincial councils of the metropolitans have comprised

Constitution and purpose.



only the bishops of their respective provinces, with whom, however, the deans and the abbots and other governing dignitaries of the church have been on occasions associated, the Convocations of the two provinces have always comprised a definite number of representatives of the clergy of the chapters and of the beneficed clergy of the several dioceses. Further, whereas the purport of an ordinary provincial council is to consult on matters which concern the faith or the peace of the church as a religious body, the Convocations are called together to treat of matters which concern the Crown, and the security and defence of the Church of England, and the tranquillity, public good, and defence of the realm itself. All these subjects are specified as probable matters for deliberation in the royal writs, under which the archbishops are commanded to call together their respective Convocations. These assemblies would thus appear to be integral parts of the body politic of the realm of England; but when and how they originated, and when and how they became so incorporated in it is not historically clear. This much is known from authentic records, that the present constitution of the Convocation of the prelates and clergy of the province of Canterbury was recognized as early as in the eleventh year of the reign of Edward I. (1233) as its normal constitution; and that in extorting that recognition from the Crown, which the clergy accomplished by refusing to attend unless summoned in lawful manner (*debito modo*) through their metropolitan, the clergy of the province of Canterbury taught the laity the possibility of maintaining the freedom of the nation against the encroachments of the royal power. It had been a provision of the Anglo-Saxon period, the origin of which is generally referred to the Council of Cloveshoo (747), that the possessions of the church should be exempt from taxation by the secular power, and that it should be left to the benevolence of the clergy to grant such subsidies to the Crown from the endowments of their churches as they should agree to in their own assemblies. It may be inferred, however, from the language of the various writs issued by the Crown for the collection of the "aids" voted by the *Commune Concilium* of the realm in the reign of Henry III., that the clergy were unable to maintain the exemption of church property from being taxed to those "aids" during that king's reign; and it was not until some years had elapsed of the reign of Edward I. that the spirituality succeeded in vindicating their constitutional privilege of voting in their own assemblies their free gifts or "benevolences," and in insisting on the Crown observing the lawful form of convoking those assemblies through the metropolitan of each province.

The form of the royal writ, which it is customary to issue in the present day to the metropolitan of each province, is identical in its purport with the writ issued by the Crown in 1233 to the metropolitan of the province of Canterbury, after the clergy of that province had refused to meet at Northampton in the previous year, because they had not been summoned in lawful manner; whilst the mandates issued by the metropolitans in pursuance of the royal writs, and the citations issued by the bishops in pursuance of the mandates of their respective metropolitans, are identical in their purport and form with those used in summoning the Convocation of 1233, which met at the New Temple in the City of London, and voted a "benevolence" to the Crown, as having been convoked in lawful manner. The existing constitution of the Convocation of the province of Canterbury—and the same observation will apply to that of the province of York—in respect of its comprising representatives of the chapters and of the beneficed clergy, in addition to the bishops and other dignitaries of the church, would thus appear to be of even more ancient date than the existing constitution of the Parliament of the realm; for the council of the realm, to which representatives of the counties and of the boroughs were for the first time summoned to the same place with the barons, to meet the king at Shrewsbury in the same year (1233) in which the Convocation of the province of Canterbury was summoned to the New Temple, differed in several important particulars from the Parliament of the realm, as at present constituted, although it is sometimes styled the Parliament of Shrewsbury, or of Acton Burnell. It was, in fact, an extraordinary council, to which the prelates, who were a constituent part of the *Commune Concilium* of the realm were not summoned, its object being

to try David, the brother of Llewelyn, prince of Wales, who had surrendered himself a prisoner, on a charge of high treason against the Crown of England. The barons alone appear to have tried and condemned the prisoner, as far as may be inferred from the language of the annalists, although the commons may have been allowed a consultative voice. At all events the commons agreed with the barons in voting an "aid" of a thirtieth to support the king's expedition into Wales, and the issuing of the ordinance known as the "Statutum de Mercatoribus" concluded the business for which the council was summoned. The settled constitution of Parliament as it exists in the present day was not completed until 1295 (23 Edward I.), when the representatives of the commons were summoned to the same place with the barons, and the clergy as a body were also convened with the laity, under a novel clause known as the "præmunientes" clause, which was inserted in the writs issued by the Crown directly to the bishops.

From this period down to the eleventh year of the reign of Edward III. there were continual contests between the spirituality of the realm and the Crown,—the spirituality contending for their constitutional right to vote their subsidies in their provincial Convocations; the Crown, on the other hand, insisting on the immediate attendance of the clergy in Parliament. The resistance of the clergy to the innovation of the "præmunientes" clause had so far prevailed in the reign of Edward II. that the Crown consented to summon the clergy to Parliament through their metropolitans, and a special form of provincial writ was for that purpose framed; but the clergy protested against this writ, and the struggle was maintained between the spirituality and the Crown until 1337 (11 Edward III.), when the Crown reverted to the ancient practice of commanding the metropolitans to call together their clergy in their provincial assemblies, where their subsidies were voted in the manner as accustomed before the "præmunientes" clause was introduced. The "præmunientes" clause, however, was continued in the Parliamentary writs issued to the several bishops of both provinces, whilst the bishops were permitted to neglect at their pleasure the execution of the writs. It is a moot question, in which of the two Houses of Parliament the representatives of the chapters and of the beneficed clergy sat, when summoned to Parliament, and whether they had a deliberative vote, or only a consultative voice. According to the "Modus tenendi Parliamentum" the proctors of the clergy sat and voted in the Lower House of Parliament. But the authority of that treatise has been impugned by many writers, because the introductory paragraph announces it to be a description of the manner of holding a Parliament in the time of King Edward, the son of Ethelred, and of William the Conqueror and his successors. The treatise itself, however, is not a mere imposture, as Dr. Hody has contended in his *History of English Councils and Convocations*. It is found in several MSS. of the 14th century, and the Parliamentary writs and records of the reign of Edward II. warrant us in regarding it as a treatise framed after the actual constitution of Parliament in the reign of that king.<sup>1</sup> This treatise contains a chapter entitled "De Auxilio Regi," in which it is explicitly stated that the proctors of the clergy sat in the Lower House, and voted as members of the Commons on all questions which required the consent of Parliament. "Ideo oportet, quod omnia que affirmari vel infirmari, concedi vel negari, vel fieri debent per Parliamentum, per communitatem Parliamenti concedi debent, que est ex tribus gradibus sive generibus Parliamenti, scilicet ex procuratoribus cleri, militibus comitatum, civibus et burgensibus qui representant totam communitatem; et non de magnatibus, quia quilibet eorum est pro sua propria persona ad Parliamentum, et pro nulla alia." This view is borne out by the language of the petition of the Lower House itself in the Convocation of 1547 (1 Edward VI.), that "according to the ancient custom of this realm and the tenor of the king's writs for the summoning of the Parliament, which be now, and ever have been, directed to the bishops of every diocese, the clergy of the Lower House of Convocation may be adjoined and associated with the Lower House of Parliament" (Cardwell's *Synodalia*, p.

Contest between spirituality and Crown.

The clergy's place in parliament.

Constitution older than that of parliament.

the beneficed clergy, in addition to the bishops and other dignitaries of the church, would thus appear to be of even more ancient date than the existing constitution of the Parliament of the realm; for the council of the realm, to which representatives of the counties and of the boroughs were for the first time summoned to the same place with the barons, to meet the king at Shrewsbury in the same year (1233) in which the Convocation of the province of Canterbury was summoned to the New Temple, differed in several important particulars from the Parliament of the realm, as at present constituted, although it is sometimes styled the Parliament of Shrewsbury, or of Acton Burnell. It was, in fact, an extraordinary council, to which the prelates, who were a constituent part of the *Commune Concilium* of the realm were not summoned, its object being

<sup>1</sup> Sir Thomas Duffus Hardy, who edited this treatise for the Record Commissioners in 1846, places it somewhere between 1294 and 1327.

421). The weight of evidence would thus seem to be in favor of the view that the proctors of the clergy, when summoned to Parliament under the "premunientes" clause, sat and voted in the Lower House of Parliament, which is not altogether irreconcilable with the statement in Lord Coke's Fourth Institute, that the proctors of the clergy never had a voice in Parliament, "because they were no lords of Parliament." The reason alleged in this passage of the Fourth Institute is clearly inadequate as regards the Lower House, inasmuch as the magnates were excluded from it; but if the compiler of the Fourth Institute had in view the Upper House he is justified in saying that the proctors of the clergy did not vote in that House.

It has been matter of controversy between divines and lawyers, whether the Convocations of the two provinces are properly to be regarded as high courts of the spirituality of the realm of England, or as ecclesiastical councils of their respective metropolitans. The divines prefer to regard them as provincial councils, although perhaps in so doing they unconsciously depreciate them. It may be admitted that there is nothing in the constitution of either Convocation which is inconsistent with its being a provincial council *sui generis*, as the constituent elements of provincial councils vary indefinitely according to the custom of different national churches,—for instance the parochial clergy, whose presence by their representatives is a remarkable feature of the Convocation of the two provinces, have been allowed to appear by their representatives in more than one provincial council of the ancient Gallican Church; but the Convocations of the province of Canterbury and of York, as summoned in pursuance of a royal writ, are assuredly something more than ecclesiastical councils of their respective metropolitans. There is the high authority of Lord Coke for regarding the Convocations of the two provinces as courts of the spirituality, and the Upper House of Convocation is by statute (24 Henry VIII. ch. 12) constituted the high court of appeal in matters in which the Crown is a party in any cause before an ecclesiastical court. Perhaps the true solution of the controversy will be found in distinguishing the Upper House of Convocation from the Lower House, and just as the Upper House of Parliament is the High Court of Parliament which exercises the judicial functions of the Parliament, so the Upper House of Convocation is the High Court of Convocation, the Lower House having the right to make presentments to the Upper House in like manner as the Lower House of Parliament has the right to prefer impeachments before the Upper House of Parliament, but not to take part in adjudicating upon them. There is, indeed, an instance on record of a kind of cumulative vote of the Lower House of Convocation in 1640, when it added its voice to that of the Upper House in suspending a member of the Upper House (the bishop of Gloucester) from his office and benefice; but this was rather a question touching the privileges of the two houses in a business which they considered to have brought scandal on the proceedings of the Convocation, the bishop of Gloucester having refused to conform himself to a resolution of both Houses in a matter of subscription to certain new canons. This, however, is not a precedent of a safe period. There is, indeed, another point of view from which the Convocation appears to have all the attributes of a high court of the metropolitan, inasmuch as he metropolitan, when he presides, or his commissary in the absence of the metropolitan, has the coercive power of an ecclesiastical judge in respect of the members of the Convocation: he directs absolutely the course of business; he may pronounce the members contumacious and punish their contumacy by suspension from office, or by sequestration of benefice, and at his pleasure may remit the penalties, and upon submission absolve the offender. He may further suspend the sittings of Convocation when he sees fit, and may continue them to such times as he thinks proper; and a schedule, or written sentence of continuation and prorogation at the termination of each session, is signed by the archbishop or his commissary, in which he is described as "judicially sitting." A curious argument has been raised in modern times upon the wording of certain ancient schedules in which it is recited that the archbishop has continued and prorogued the Convocation to a certain day "cum consensu confratrum suorum." It has been contended that these recitals are not consistent with the claim

Authority of the metropolitan.

of the metropolitan to prorogue the Convocation at his pleasure. But this argument is founded on a total misconception of the object of these recitals, which was to save the legal right of the metropolitan to pronounce the bishops and clergy contumacious, if they should not attend on the day to which the Convocation was continued. Of strict right the members of Convocation were not liable to be pronounced in contempt, unless they had been cited in lawful manner to attend upon the archbishop on a given day; but if they were consenting parties to the continuation of the sittings of the Convocation to a future day, and their consent was recorded in the instrument of continuation, which is read aloud before it is signed by the metropolitan, they would thereby be perempted of all excuse for non-attendance on the plea that they had not been duly cited. Such we conceive to be the true meaning of this clause, which is rarely found in the older schedules, but occurs frequently in the schedules of the most turbulent period of the history of Convocation, namely, during the reign of Queen Anne. It was probably inserted in those schedules *ex majori cautela*, after an ancient precedent with which the registrar of the Convocation was familiar. This much, however, is certain, that the phrase does not occur in any schedule of prorogation, which is not also a schedule of continuation of the sittings of Convocation to a further day.

The history of the Convocation of the province of Canterbury, as at present constituted, is full of stirring incidents, and it resolves itself readily into five periods. The first period, by which is meant the first period which dates from an epoch of authentic history, is the period of its greatest freedom, but not of its greatest activity. It extends from the reign of Edward I. (1283) to that of Henry VIII. The second period is the period of its greatest activity and of its greatest usefulness, and it extends from the twenty-fifth year of the reign of Henry VIII. to the reign of Charles II. The third period extends from the fifteenth year of the reign of Charles II. (1664) to the reign of George I. This was a period of turbulent activity and little usefulness, and the anarchy of the Lower House of Convocation during this period has created a strong prejudice against the revival of Convocation in the mind of the laity. The fourth period extends from the third year of the reign of George I. (1716) to the fifteenth year of the reign of Queen Victoria. This was a period of torpid inactivity, during which it was customary for Convocation to be summoned and to meet *pro forma*, and to be continued and prorogued indefinitely. The fifth period may be considered to have commenced in the fifteenth year of the reign of Queen Victoria (1852), and it would be premature to pronounce an opinion upon its character. It has not hitherto had to pass through any severe ordeal of political strife.

During the first of the five periods above mentioned, it would appear from the records preserved at Lambeth and at York that the metropolitans frequently convened congregations (so-called) of their clergy without the authority of a royal writ, which were constituted precisely as the Convocations were constituted, when the metropolitans were commanded to call their clergy together pursuant to a writ from the Crown. As soon, however, as King Henry VIII. had obtained from the clergy their acknowledgment of the supremacy of the Crown in all ecclesiastical causes, he constrained the spirituality to declare, by what has been termed the Act of Submission on behalf of the clergy, that the Convocation "is, always has been, and ought to be summoned by authority of a royal writ;" and this declaration was embodied in a statute of the realm (25 Henry VIII. c. 19), which further enacted that the Convocation "should thenceforth make no provincial canons, constitutions, or ordinances without the royal assent and license." The spirituality was thus more closely incorporated than heretofore in the body politic of the realm, seeing that no deliberations on its part can take place unless the Crown has previously granted its license for such deliberations. It had been already provided during this period by 8 Henry VI. c. 1, that the prelates and other clergy, with their servants and attendants, when called to the Convocation pursuant to the king's writ, should enjoy the same liberty and defence in coming, tarrying, and returning as the magnates and the commons of the realm enjoy when summoned to the king's Parliament.

Five characteristic periods.

First period.

Second period.

The second period, which dates from 1533 to 1664, has been distinguished by four important assemblies of the spirituality of the realm in pursuance of a royal writ—the two first of which occurred in the reign of Edward VI., the third in the reign of Queen Elizabeth, and the fourth in the reign of Charles II. The two earliest of these Convocations were summoned to complete the work of the reformation of the Church of England, which had been commenced by Henry VIII.; the third was called together to reconstruct that work, which had been marred on the accession of Mary, the consort of Philip II. of Spain; whilst the fourth was summoned to re-establish the Church of England, the framework of which had been demolished during the great rebellion. On all of these occasions the Convocations worked hand in hand with the Parliament of the realm under a license and with the assent of the Crown. Meanwhile the Convocation of 1603 had framed a body of canons for the governance of the clergy. Another Convocation requires a passing notice, in which certain canons were drawn up in 1640, but by reason of an irregularity in the proceedings of this Convocation (chiefly, on the ground that its sessions were continued for some time after the Parliament of the realm had been dissolved), its canons are not held to have any binding obligation on the clergy. The Convocations had up to this time maintained their liberty of voting the subsidies of the clergy in the form of "benevolences," separate and apart from the "aids" granted by the laity in Parliament, and one of the objections taken to the proceedings of the Convocation of 1640 was that it had continued to sit and to vote its subsidies to the Crown after the Parliament itself had been dissolved. It is not, therefore, surprising on the restoration of the monarchy in 1661 that the spirituality was not anxious to retain the liberty of taxing itself apart from the laity, seeing that its ancient liberty was likely to prove of questionable advantage to it. It voted, however, a benevolence to the Crown on the occasion of its first assembling in 1661 after the restoration of King Charles II., and it continued so to do until 1664,

Sheldonian compact.

when an arrangement was made between Archbishop Sheldon and Lord Chancellor Hyde, under which the spirituality silently waived its long asserted right of voting its own subsidies to the Crown, and submitted itself thenceforth to be assessed to the "aids" directly granted to the Crown by Parliament. An Act was accordingly passed by the Parliament in the following year (16 and 17 Car. II. c. 1), entitled An Act to grant a Royal Aid unto the King's Majesty, to which aid the clergy were assessed by the commissioners named in the statute without any objection raised on their part or behalf, there being a proviso that in so contributing the clergy should be relieved of the liability to pay two subsidies out of four, which had been voted by them in the Convocation of a previous year. There was also a further proviso inserted in the same Act, that "nothing therein contained shall be drawn into example to the prejudice of the ancient rights belonging to the lords spiritual and temporal, or clergy of this realm," &c., which Mr. Hallam considers to be a saving of the rights of the clergy to tax themselves, if they think fit (*Constitutional History*, ed. 1842, ii. p. 395). But the spirituality has never reasserted its ancient liberty of self-taxation. In consequence of this practical renunciation of their separate status, as regards their liability to taxation, the clergy have assumed and enjoyed in common with the laity the right of voting at the election of members of the House of Commons, in virtue of their ecclesiastical freeholds, and this right has been recognized by subsequent statutes, such for instance as 10 Anne c. 23, and 18 George II. c. 18. According to a note of Speaker Onslow's, appended to Burnet's *History of his Own Times* (Oxford ed. vol. iv. p. 308), the matter was first settled by a private agreement between Sheldon and Clarendon, and tacitly assented to by the clergy. Onslow says, "Gibson, bishop of London, said to me that it was the greatest alteration in the constitution ever made without an express law."

The most important and the last work of the Convocation during this second period of its activity was the revision of the Book of Common Prayer, which was completed in the latter

part of 1661. The revised book, after it had been sanctioned by the Convocation of the province of York, was presented to the Crown for its approval. The Crown having approved the book, sent it forthwith to the Upper House of Parliament, with a recommendation that the book, as reviewed by the Convocation, should be appointed by an Act of Uniformity; and accordingly the two Houses of Parliament after a conference accepted the revised book, and enacted that it should be the book which should be appointed to be used in all places of public worship in the realm. It was believed for some considerable time that the original book which had been attached to the Act of Uniformity on this occasion had been lost from the archives of the House of Lords. It was, indeed, missing for some time, but in consequence of a more careful search having been instituted in 1870 by Dr. A. P. Stanley, the dean of Westminster, the original book has been discovered detached from the Act of Uniformity in the library of the House of Lords, and a fac-simile of the book with the MS. revision was made under the authority of the lords of the treasury for the use of the royal commissioners on ritual in 1871.

The Revolution in 1688 is the most important epoch in the third period of the history of the synodical proceedings of the spirituality, when the Convocation of Canterbury, having met in 1689 in pursuance of a royal writ, obtained a license under the great seal to prepare certain alterations in the liturgy and in the canons, and to deliberate on the reformation of the ecclesiastical courts. A feeling, however, of panic seems to have come over the Lower House, which took up a position of violent antagonism to the Upper House. This circumstance led to the prorogation of the Convocation and to its subsequent discharge without any practical fruit resulting from the king's license. Ten years elapsed during which the Convocation was prorogued from time to time without any meeting of its members for business being allowed. The next Convocation which was permitted to meet for business, in 1700, was marked by great turbulence and insubordination on the part of the members of the Lower House, who refused to recognize the authority of the archbishop to prorogue their sessions. This controversy was kept up until the discharge of the Convocation took place concurrently with the dissolution of the Parliament in the autumn of that year. The proceedings of the Lower House in this Convocation were disfigured by excesses which were clearly violations of the constitutional order of the Convocation. The Lower House refused to take notice of the archbishop's schedule of prorogation, and adjourned itself by its own authority, and upon the demise of the Crown it disputed the fact of its sessions having expired, and as Parliament was to continue for a short time, prayed that its sessions might be continued as a part of the Parliament under the "præmunientes" clause. The next Convocation was summoned in the first year of Queen Anne, when the Lower House, under the leadership of Dean Aldrich, its prolocutor, challenged the right of the archbishop to prorogue it, and presented a petition to the queen, praying Her Majesty to call the question into her own presence. The question was thereupon examined by the Queen's Council, when the right of the president to prorogue both Houses of Convocation by a schedule of prorogation was held to be proved, and further, that it could not be altered except by an Act of Parliament. This decision of the Queen's Council is of great importance in its bearing upon the constitution of the Convocation as a part of the body politic of the realm, and is in striking contrast to a legal opinion which was circulated in print in 1855 with the names of two eminent lawyers subscribed to it, to the effect that the Convocation has the power of altering its own constitution, provided only that it has the license of the Crown to make a canon to that effect, and such canon is subsequently approved by the Crown. During the remaining years of the reign of Queen Anne the two Houses of Convocation were engaged either in internecine strife, or in censoring sermons or books, as teaching latitudinarian or heretical doctrines; and, when it had been assembled concurrently with Parliament on the accession of King George I., a great breach was before long created between the two Houses by the Bangorian controversy.

Third period.

Claim of Lower House to sit independently

Dr. Hoadly, bishop of Bangor, having preached a sermon before the king, in the Royal Chapel

Bangorian controversy.

<sup>1</sup> It had always been the practice, when the clergy voted their subsidies in their Convocation, for Parliament to authorize the collection of each subsidy by the same commissioners who collected the parliamentary aid.

at St. James's Palace in 1717, against the principles and practice of the non-jurors, which had been printed by the king's command, the Lower House, which was offended by the sermon and had also been offended by a treatise on the same subject published by Dr. Hoadly in the previous year, lost no time in representing the sermon to the Upper House, and in calling for its condemnation. A controversy thereupon arose between the two Houses which was kept up with untiring energy by the Lower House, until the Convocation was prorogued in 1717 in pursuance of a royal writ; from which time until 1861 no license from the Crown has been granted to Convocation to proceed to business. During this period, which may be regarded as

**Fourth period.**

the fourth distinguishing period in the history of the Convocation of the Church of England, it was usual for a few members of the Convocation to meet when first summoned with every new Parliament, in pursuance of the royal writ, for the Lower House to elect a prolocutor, and for both Houses to vote an address to the Crown, after which the Convocation was prorogued from time to time, pursuant to royal writs, and ultimately discharged when the Parliament was dissolved. There were, however, several occasions between 1717 and 1741 when the Convocation of the province of Canterbury transacted certain matters, by way of consultation, which did not require any license from the Crown, and there was a short period in its session of 1741 when there was a probability of its being allowed to resume its deliberative functions, as the Lower House had consented to obey the president's schedule of prorogation; but the Lower House having declined to receive a communication from the Upper House, the Convocation was forthwith prorogued, from which time until the middle of the present century the Convocation was not permitted by the Crown to enjoy any opportunity even for consultation. The spirituality at last aroused itself from its long repose in 1852, and on this occasion the Upper House took the lead. The active

**Fifth period.**

spirit of the movement was Samuel, bishop of Oxford, but the master mind was Henry, bishop of Exeter. On the Convocation assembling several petitions were presented to both Houses, praying them to take steps to procure from the Crown the necessary license for their meeting for the despatch of business, and an address to the Upper House was brought up from the Lower House, calling the attention of the Upper House to the reasonableness of the prayer of the various petitions. After some discussion the Upper House, influenced mainly by the argument of Henry, bishop of Exeter, consented to receive the address of the Lower House, and the Convocation was thereupon prorogued, shortly after which it was discharged concurrently with the dissolution of

**Revival of activity.**

Parliament. On the assembling of the next Convocation of the province of Canterbury, no royal writ of exoneration having been sent by the Crown to the metropolitan, the sessions of the Convocation were continued for several days; and from this time forth Convocation may be considered to have resumed its action as a consultative body, whilst it has also been permitted on more than one occasion to exercise its functions as a deliberative body. Its first action as a deliberative body commenced in 1861, in pursuance of a license from the Crown granted to it upon its prayer, to amend the twenty-ninth of the canons of 1603 on the subject of sponsors at baptism. Its deliberations, however, on this subject have not yet been brought to a final conclusion. Both Houses came to an agreement as to the form of a canon to be substituted in place of the existing canon, and the Convocation of the province of York having consented to the amended canon, it was submitted to the Crown for its approval pursuant to the terms of the royal license, under which the new canon could only acquire the validity of law by its confirmation under letters patent of the Crown. On this occasion, however, the new canon appeared to Her Majesty's Government to exceed in its terms the royal license, and to be likely to cause greater perplexity to the clergy than the existing canon. It was accordingly sent back to the Convocation in 1865 for further amendment. The Upper House thereupon made a further amendment in the proposed form of canon, and sent it down to the Lower House for its concurrence, but the Lower House, in the Convocation of 1867, resolved to defer the consideration of the further amendment of the canon, until a committee, which has been appointed to consider the whole body of

the canons of 1603, shall have made its report. This is a proceeding which cannot be considered of good augury to the Convocation as a deliberative body, seeing that the license of the Crown to amend the particular canon was granted to Convocation at its own request. The proceedings of the Convocation on the second occasion have been of more favorable augury. A royal license was granted to the Convocation of 1865 in response to an address on its part to the Crown, authorizing it to make a new canon in the place of the thirty-sixth, and to amend the thirty-seventh and the thirty-eighth canons so as to be in harmony with the new canon, and also to amend the fortieth canon; and certain alterations and amendments in those canons having been accordingly made by the Convocation of the province of Canterbury, and agreed to by the Convocation of the province of York under a similar license from the Crown, the royal assent was given to the amended canons in the Convocation of 1866. On this occasion the Convocations acted with becoming promptness and decision, as there was a pressing emergency for their co-operation with the Parliament in relieving the clergy from certain subscriptions and oaths, and in altering the forms of declarations to be made by them on their admission to office or benefice (28 and 29 Vict. c. 122). With regard to the twenty-ninth canon there was no corresponding emergency, and it may be said of it as of other canons which have been abrogated by custom—"ubi consuetudo loquitur, lex manet sopita." It appears, however, that the report of the committee of the Lower House on the subject of an amended code of canons ecclesiastical was laid on the table of the Upper House in the session of 1874, but no further action has been taken upon it.

The order of convening the Convocation of the province of Canterbury is as follows. A writ issues from the Crown, addressed to the metropolitan archbishop of Canterbury, commanding him "by reason of certain difficult and urgent affairs concerning us, the security and defence of our Church of England, and the peace and tranquillity, public good, and defence of our kingdom, and our subjects of the same, to call together with all convenient speed, and in lawful manner, the several bishops of the province of Canterbury, and deans of the cathedral churches, and also the archdeacons, chapters, and colleges, and the whole clergy of every diocese of the said province, to appear before the said metropolitan in the cathedral church of St. Paul, London, on a certain day, or elsewhere, as shall seem most expedient, to treat of, agree to, and conclude upon the premises and other things, which to them shall then at the same place be more clearly explained on our behalf." In case the metropolitan see of Canterbury should be vacant, the writ of the Crown is addressed to the dean and chapter of the metropolitan church of Canterbury in similar terms, as being the guardians of the spiritualities of the see during a vacancy. Thereupon the metropolitan, or, as the case may be, the dean and chapter of the metropolitan church, issue a mandate to the bishop of London, as dean of the province, and if the bishopric of London should be vacant, then to the bishop of Winchester as subdean, which embodies the royal writ, and directs the bishop to cause all the bishops of the province to be cited, and through them the deans of the cathedral and collegiate churches, and the archdeacons and other dignitaries of churches, and each chapter by one, and the clergy of each diocese by two sufficient proctors, to appear before the metropolitan or his commissary, or, as the case may be, before the dean and chapter of the metropolitan church or their commissary in the chapter-house of the cathedral church of St. Paul, London, if that place be named in the mandate, or elsewhere, with continuation and prorogation of days next following, if that should be necessary, to treat upon arduous and weighty affairs, which shall concern the state and welfare, public good, and defence of this kingdom and the subjects thereof, to be then and there seriously laid before them, and to give their good counsel and assistance on the said affairs, and to consent to such things as shall happen to be wholesomely ordered and appointed by their common advisement, for the honor of God and the good of the church.

The provincial dean, or the subdean, as the case may be, thereupon issues a citation to the several bishops of the province, which embodies the mandate of the metropolitan or of the dean and chapter of the metropolitan church, as the case may be, and admonishes them to appear, and to cite and admonish their clergy, as specified in the metropolitan mandate, to appear at the time and place mentioned in the mandate. The bishops thereupon either summon directly the clergy of their respective dioceses to appear before them or their commissaries to elect two proctors, or they send a citation to their archde-

Amended canons of 1866.

Order of convening Convocation.

cons, according to the custom of the diocese, directing them to summon the clergy of their respective archdeaconries to elect a proctor. The practice of each diocese in this matter is the law of the Convocation, and the practice varies indefinitely as regards the election of proctors to represent the beneficed clergy. As regards the deans, the bishops send special writs to them to appear in person, and to cause their chapters to appear severally by one proctor. Writs also go to every archdeacon, and on the day named in the royal writ, which is always the day next following that named in the writ to summon the Parliament, the Convocation assembles in the place named in the archbishop's mandate. Thereupon, after the Litany has been sung or said, and a Latin sermon preached by a preacher appointed by the metropolitan, the clergy are præconized or summoned by name to appear before the metropolitan or his commissary; after which the clergy of the Lower House are directed to withdraw and elect a prolocutor, to be presented to the metropolitan for his approbation. The Convocation thus constituted resolves itself at its next meeting into two Houses, and it is in a fit state to proceed to business. The regular forms of proceeding have been carefully kept up in the Convocation of the province of Canterbury, which consists of 20 bishops, exclusive of the metropolitan, 24 deans, 56 archdeacons, 23 proctors for the chapter clergy, and 42 proctors for the beneficed clergy.

On the other hand, the proceedings of the Convocation of the province of York have been less regular, and no prolocutor of the Lower House of the Convocation appears to have been appointed since 1661, until the recent resuscitation of the Convocation as a consultative body. Its constitution differs slightly from that of the Convocation of the province of Canterbury, as each archdeaconry is represented by two proctors, precisely as in Parliament formerly under the *Premunientes* clause. It consists of 6 bishops, including the bishop of Sodor and Man and exclusive of the metropolitan, 6 deans, 15 archdeacons, 6 proctors of the chapter clergy, and 30 proctors for the beneficed clergy. There are some anomalies in the diocesan returns of the two Convocations, but in all such matters the *consuetudo* of the diocese is the governing rule.

*Bibliography.*—Wilkins, *Concilia Magna Britannia et Hibernia*, 4 vols. folio, 1737; Gibson, *Codex Juris Ecclesiastici Anglicani*, 2 vols. folio, 1713; Johnson, *A Collection of all the Ecclesiastical Laws, Canons, and Constitutions of the English Church*, 2 vols. 8vo, 1720; Gibson, *Synodus Anglicana*, 8vo, 1702, re-edited by Dr. Edward Cardwell, 8vo, 1854; Shower, *A Letter to a Convocation Man concerning the Rights, Powers, and Privileges of that Body*, 4to, 1697; Wake, *The Authority of Christian Princes over their Ecclesiastical Synods asserted, occasioned by a late Pamphlet intitled A Letter to a Convocation Man*, 8vo, 1697; Atterbury, *The Rights, Powers, and Privileges of an English Convocation stated and vindicated in answer to a late Book of Dr. Wake's*, 8vo, 1700; Burnet, *Reflections on a Book intitled The Rights, Powers, and Privileges of an English Convocation stated and vindicated*, 4to, 1700; Kennet, *Ecclesiastical Synods and Parliamentary Convocations of the Church of England historically stated and justly vindicated from the Misrepresentation of Mr. Atterbury*, 8vo, 1701; Atterbury, *The Power of the Lower House of Convocation to adjourn itself*, 4to, 701; Gibson, *The Right of the Archbishop to continue or prorogue the whole Convocation*, 4to, 1701; Kennet, *The Case of the Premunientes*, 4to, 1701; Hooper, *The Narrative of the Lower House vindicated from the Exceptions of a Letter, intitled The Right of the Archbishop to continue or prorogue the Convocation*, 4to, 1702; Atterbury, *The Case of the Schedule stated*, 4to, 1702; Gibson, *The Schedule Revisined or the Right of the Archbishop to continue or prorogue the whole Convocation, cleared from the Exception of a late Vindication of the Narrative of the Lower House, and of a Book intitled The Case of the Schedule Stated*, 4to, 1702; Hody, *A History of the English Councils and Convocations, and of the Clergy's sitting in Parliament*, 8vo, 1702; Wake, *The State of the Church and Clergy of England in their Councils, Synods, Convocations, Conventions, and other Public Assemblies, occasioned by a book intitled The Rights, Powers, and Privileges of an English Convocation*, fol., 1703; Burnet, *History of his own Time*, 2 vols. folio, 1734; re-edited by Dr. Martin J. Routh, 6 vols. 8vo, 1833; Hallam, *Constitutional History of England*, 3 vols. 8vo, 1832; Cardwell, *Documentary Annals of the Reformed Church of England*, 2 vols., 1839; Cardwell, *A History of Conferences and other Proceedings connected with the revision of the Common Prayer*, 8vo, 1841; Cardwell, *Synodalia, a Collection of Articles of Religion, Canon, and Proceedings of Convocation in the Province of Canterbury*, 2 vols., 8vo, 1842; Lathbury, *A History of the Convocation of the Church of England*, second edition, 8vo, 1858; Trevor, *The Convocation of the Two Provinces*, 8vo, 1852; Pearce, *The Law relating to Convocations of the Clergy*, 8vo, 1848; *Synodalia*, a journal of Convocation, commenced in 1852, 8vo; *The Chronicle of Convocation*, being a record of the proceedings of the Convocation of Canterbury, commenced in 1863, 8vo. (T. T.)

CONWAY, or ABERCONWAY, a town of Carnarvonshire, in North Wales, at the mouth of the Conway, four miles

south of Llandudno and forty-five miles west of Chester by railway. It is situated on the western bank of the river, and is inclosed by a lofty wall, which approaches the form of a triangle, and is a mile in circumference. The style of this ancient and highly interesting wall is Saracenic; it is fenced with twenty-one round towers, now somewhat dilapidated, and entered by three principal gateways with two strong towers. The south-eastern angle is occupied by the castle, one of the noblest of the old fortresses in England. It was built in 1284 by Edward I. to secure his possession of North Wales, and was the residence of Richard II. in 1389. During the war of the Commonwealth it was held for Charles I. by Archbishop Williams, but was taken by General Mytton in 1646. In the following reign it was dismantled by its new proprietor, Earl Conway, and remains a ruin. The building is oblong in form; it is strengthened with eight massive drum towers; and part of the interior is occupied by a great hall, known as Llewelyn's, 130 feet long. The town contains some curious old houses of the Elizabethan period, a town-hall where the petty sessions are held, and St. Mary's church. The Parliamentary borough of Conway (which with Carnarvon and four others returns in conjunction a member to Parliament) extends beyond the walls of the town, and over to the right bank of the river, occupying a total area of 3312 acres. Population of town, 1862; of borough, 2620.

CONYBEARE, JOHN (1692-1755), a learned English divine, was born at Pinhoe, near Exeter, January 31, 1692. At the age of sixteen he entered Exeter College, Oxford, of which he was elected in 1710 probationary fellow. He graduated B. A. in 1713, and M. A. in 1716, and in the latter year was ordained priest. After holding a country curacy for about a year he returned to Oxford, and became tutor in his college. Ere long he made himself favorably known by the publication of two well-reasoned sermons on "Miracles," and on the "Mysteries of the Christian Religion," and was appointed one of the preachers to the king at Whitehall. He took his degree of D. D. in January, 1729, and in 1730 he was chosen master of Exeter College. By this time he had increased his reputation by several additional sermons, and in 1732 he published his great work, *A Defence of Revealed Religion*. This was written in reply to Matthew Tindal's *Christianity as Old as the Creation*, which had appeared two years before. It became very popular, and reached a third edition in 1733. It was characterized by Bishop Warburton as one of the best-reasoned books in the world. Soon after its publication Conybeare was appointed dean of Christ Church, Oxford, and this post he held till 1750, when he succeeded Dr. Butler in the see of Bristol. He died at Bath July 13, 1755. A selection of his sermons, in two volumes, was published after his death.

CONYBEARE, WILLIAM DANIEL (1787-1857), dean of Llandaff, an eminent geologist, born in London, June 7, 1787, was a grandson of Bishop Conybeare. He received his early education at Westminster School, and in 1805 went to Christ Church College, Oxford, where in 1808 he took his degree of B. A., as first-class in classics and second in mathematics, and that of M. A. three years later. Early attracted to the study of geology, he became one of the first members of the Geological Society, of which he was afterwards fellow, and to whose *Transactions* he contributed many important memoirs. His first paper was communicated in 1814. In his researches he was often associated with Buckland and Phillips. In 1821 he distinguished himself greatly by the first discovery and description of a skeleton of the plesiosaurus,—his account (partly conjectural reconstruction) being minutely confirmed by subsequent discoveries. Among his most important memoirs is that on the south-western coal district of England, written in conjunction with Dr. Buckland, and published in 1824. His principal work, however, is the *Outlines of the Geology of England and Wales*, written in co-operation with W. Phillips, and forming at the time of its appearance (1822) the best manual on the subject. Conybeare was a fellow of the Royal Society and a corresponding member of the Institute of France. He was appointed Bampton Lecturer in 1839, and was instituted to the deanery of Llandaff in 1845. The loss of his eldest son, W. J. Conybeare, joint author with Mr. Howson of the *Life and Letters of St. Paul*, preyed on his mind and hastened his end. He died at Ichenstoke, near Portsmouth, a few months after his son, August 12, 1857.

COOK, CAPTAIN JAMES (1728-1779), the celebrated navigator, was born on October 28, 1728, at the village of Marton, Yorkshire, where his father was first an agricultural laborer and then a farm bailiff. At thirteen years of age he was apprenticed to a haberdasher at Straiths, near Whitby, but having quarrelled with his master, he went as an apprentice on board a collier belonging to the port, and was soon afterwards appointed mate.

Early in the year 1755 Cook joined the royal navy. Having distinguished himself, he was, on the recommendation of Sir Hugh Palliser, his commander, appointed master successively of the sloop "Grampus," of the "Garland," and the "Mercury," in the last of which he served in the St. Lawrence, and was present at the capture of Quebec. He was employed also in sounding and surveying the river, and he published a chart of the channel from Quebec to the sea. In 1762 he was present at the recapture of Newfoundland; early in the following year he was employed in surveying the coasts of Newfoundland; and in 1764 he was appointed marine surveyor of Newfoundland and Labrador. While in this capacity, Cook published in the *Philosophical Transactions* an observation of a solar eclipse made at one of the Burgeo Islands, near Cape Ray, which added considerably to his reputation.

About this time the spirit for geographical discovery, which had gradually declined since the beginning of the 17th century, began to revive; and Cook was appointed to conduct an expedition which was then projected for the purpose of making observations on the impending transit of Venus, and prosecuting geographical researches in the South Pacific Ocean. For this purpose he received a commission as lieutenant, and set sail in the "Endeavor," a vessel of 370 tons, accompanied by several men of science, including Sir Joseph Banks. On the 13th April, 1769, he reached Otaheite or Tahiti, where he erected an observatory, and succeeded in making the necessary astronomical observations. From Otaheite Cook sailed in quest of the great continent then supposed to exist in the South Pacific, and reached the islands of New Zealand, which had remained a *terra incognita* since the time of their first discovery. His attempts to penetrate to the interior, however, were thwarted by the continued hostility of the natives; and he had to content himself with a voyage of six months' duration round the coast, in which he traced the existence of a narrow channel dividing New Zealand into two large islands. From New Zealand he proceeded to Australia (then called New Holland), and on April 28 came in sight of Botany Bay. On account of the hostility of the natives his discoveries here also were confined to the coast, of which he took possession in the name of Great Britain. The prosecution of this voyage was attended with dangers which, on several occasions, threatened the entire loss of the ship and crew. From Australia Cook sailed to New Guinea, and thence to Batavia, where his ship, greatly shattered and disabled, had to put in for repairs.

Arriving in England on June 11, 1771, Cook was immediately raised by the king to the rank of captain. Shortly after his return, the existence of a great southern continent began to be matter of renewed speculation, and Cook was again appointed to lead an exploratory expedition. For this purpose he was placed in command of the "Resolution," a ship of 462 tons burden, and a smaller ship called the "Adventure," with a complement in all of 193 men. Setting sail from Plymouth, July 13, 1772, he reached Madeira on the 29th of the same month, and after touching at the Cape of Good Hope, he explored the specified latitudes, but without discovering land. Satisfied that no land existed within the limits of his researches, he abandoned the investigation on the 17th January, 1773, and sailed for New Zealand. After wintering among the Society Islands, he set out to make further explorations to the eastward; and afterwards, steering northward, he navigated the southern tropic from Easter Island to the New Hebrides, and discovered the island named by him New Caledonia. After a third attempt he gave up all hope of finding land and returned to England (July 30, 1774). He was immediately raised to the rank of post-captain, appointed captain of Greenwich Hospital, and soon afterwards unanimously elected a member of the Royal Society, from which he received the Copley gold medal for the best experimental paper which had appeared during the year.

The attention of Government having been turned to the discovery of a north-west passage in the Arctic regions, Cook volunteered to conduct the expedition, and his offer was gladly accepted. Two ships, the "Resolution" and the "Discovery," were speedily equipped and placed under his care. Cook's instructions were to sail first into the Pacific through the chain of the newly-discovered islands which he had recently visited, and on reaching New Albion to proceed northward as far as latitude 66° and then to endeavor to find a passage to the Atlantic. Several ships were at the same time fitted out to attempt a passage on the other side from the Atlantic to the Pacific Ocean. Setting sail from the Nore, June 25, 1776, he cruised for a considerable time in the South Pacific, discovering several small islands; and in the spring of 1777, judging it too far advanced in the season for attempting the navigation of the northern seas, he bore away to the Friendly Islands. Here he continued for several months, and only set sail for the north in January, 1778. On his passage from the Friendly Islands, he discovered a group which he named the Sandwich Islands, after the earl of Sandwich, who had taken great interest in the expedition. After circumnavigating these, and laying down their position on a chart, Cook reached the coast of America in March, 1778; and following the coast-line northward, penetrated into the bay afterwards known as Cook's Inlet. Disappointed of a passage in this direction, he sailed for Behring's Straits, where again he found the passage intercepted by an impenetrable wall of ice. Returning to winter at the Sandwich Islands, he discovered Mowee (Maui) and Owhyhee or Hawaii, where he met his tragical death. During the night of the 13th February, 1779, one of the "Discovery's" boats was stolen by the natives, and Cook, in order to recover it, proceeded to put in force his usual expedient of seizing the person of the king until reparation should be made. Having landed on the following day, a scuffle ensued with the natives, which compelled the party of marines who attended him to retreat to their boats. Cook was the last to retire, and as he was nearing the shore he received a blow from behind which felled him to the ground. He rose immediately, and vigorously resisted the crowds that pressed upon him; but as the boats' crews were able to render him no assistance, he was soon overpowered (14th February, 1779).

As a navigator, the merits of Captain Cook were of the very highest order. His commanding personal presence, his sagacity, decision, and perseverance enabled him to overcome all difficulties, while his humanity and sympathetic kindness rendered him a favorite with his crew. His valuable researches into the nature and use of anti-scorbutic medicines proved of the greatest utility. The account of his first voyage was published under the care of Dr. Hawkesworth, but his second was chronicled directly by himself. A narrative of his third voyage was published from his notes by Lieutenant King. Distinguished honors were paid to his memory both at home and by foreign courts, and a suitable pension was settled upon his widow.

COOK'S ISLANDS, or the HERVEY ARCHIPELAGO, a considerable cluster of islands in the South Pacific, lying between the Friendly Islands and the Society Islands, in 160° W. long. and about 20° S. lat. They were discovered by Captain Cook in 1777, and in 1823 became the scene of the remarkable missionary labors of John Williams. The most important members of the group, which has a total area of about 300 square miles, are Mangleia, Raratonga, Aitutake, and Atiu. They are almost destitute of drinking-water, but abound in cocoa-palms, bread-fruit trees, and plantains. The inhabitants belong to the Malay race, and display great industry and skill in various manufactures. Their houses are well built, and have a pleasant appearance with their white walls of coral lime. The population of Raratonga is estimated at 2000, of Mangleia at 2300, of Aitutake at 1550, and of Atiu at 1200 or 1500.

COOKERY. In the condition in which man finds most of the natural substances used as food they are difficult of digestion. By the application of heat he can change the character of his food, and make it more palatable and more easily digestible. The application of heat to animal and vegetable substances for the purpose of attaining these objects constitutes the science and art of cookery. Innumerable discussions have taken place among scientific men as to the natural food of man. Too much importance

is, perhaps, attached to meat, but it is now generally accepted that a mixed animal and vegetable diet is best.

If we take a common vegetable food, such, for instance, as the potato, we find that in 1000 parts we have 760 of water, 200 parts of starch, and some mineral salts and albuminous compounds. In cooking, the starch-cells absorb water, and the greater number of them burst. This disintegration of the starch-cells is preparatory and necessary to more important changes. The starch in all vegetable substances must undergo a similar change before it can mix with the various fluids developed in the mouth and the walls of the alimentary canal. Some of these fluids, such as the saliva and pancreatic fluid, change the starch into dextrin and then into glucose or grape sugar, and this change appears necessary before the carbon and hydrogen can be oxidized. Without the preliminary operation of cooking this change would in all cases be imperfect and often impossible; and the thorough cooking of all starchy foods is of the utmost importance. When this is imperfectly done the albuminoid envelope which incloses the starch granule has to be dissolved by the gastric juice, which is often difficult and even impossible. Much indigestion probably arises from the imperfect cooking of starchy foods.

The chief constituents of animal food are albumen, fibrin, and fat, with mineral salts and juices. The flavor of meat is due to the oemazone, and some methods of cooking, such as roasting and broiling, appear to increase this flavor. Albumen and fibrin form about one-fifth of the meat. The former always coagulates by heat, and the expansion of the juices tends to separate the solid fibres, and this separation depends very much on the methods of cooking. Albumen is as constant a constituent of all animal food as starch is of vegetable, but these bodies differ greatly in their chemical composition and in the changes which they undergo in the stomach. Albumen is taken into the system as an insoluble substance, but in contact with the gastric fluid it becomes soluble—a condition necessary for every kind of food before it can nourish the body.

**Broiling.**—The earliest method of cooking was probably burying seeds and flesh in hot ashes, a kind of broiling on all the surfaces at the same time, which when properly done is the most delicate kind of cooking. Broiling is now done over a clear uniform charcoal fire extending at least 2 inches beyond the edges of the gridiron, which should slightly incline towards the cook. It is usual to rub the bars with a piece of suet for meat, and chalk for fish, to prevent the thing broiled being marked with the bars of the gridiron. In this kind of cookery the object is to coagulate as quickly as possible all the albumen on the surface, and seal up the pores of the meat so as to keep in all the juices and flavor. It is, therefore, necessary to thoroughly warm the gridiron before putting on the meat, or the heat of the fire is conducted away while the juices and flavor of the meat run into the fire. Broiling is a simple kind of cookery, and one well suited to invalids and persons of delicate appetites. There is no other way in which small quantities of meat can be so well and so quickly cooked, and for persons who dine alone it is the most convenient method of cookery. Broiling cannot be well done in front of an open fire, because one side of the meat is exposed to a current of cold air. A pair of tongs should be used instead of a fork for turning all broiled meat and fish.

**Roasting.**—Two conditions are necessary for good roasting—a clear bright fire and frequent basting. Next to boiling or stewing it is the most economical method of cooking. The meat at first should be placed close to a brisk fire for five minutes to coagulate the albumen. It should then be drawn back a short distance and roasted slowly. If a meat screen be used it should be placed before the fire to be moderately heated before the meat is put to roast. The centre of gravity of the fire should be a little above the centre of gravity of the joint. No kitchen can be complete without an open range, for it is almost impossible to have a properly roasted joint in closed kitchens. The heat radiated from a good open fire quickly coagulates the albumen on the surface, and thus to a large extent prevents that which is fluid in the interior from solidifying. The connective tissue which unites the fibres is gradually converted into gelatine, and rendered easily soluble. The fibrin and albumen appear to undergo a higher oxidation and are more readily dissolved. The fat cells are gradually broken, and the liquid fat unites to a

small extent with the chloride of sodium and the tribasic phosphate of sodium contained in the serum of the blood. It is easily seen that roasting by coagulating the external albumen keeps together the most valuable parts of the meat, till they have gradually and slowly undergone the desired change. This surface coagulation is not sufficient to prevent the free access of the oxygen of the surrounding air. The empyreumatic oils generated on the surface are neither wholesome nor agreeable, and these are perhaps better removed by roasting than any other method except broiling. The chief object is to retain as much as possible all the rapid juicy properties of the meat, so that at the first cut the gravy flows out of a rich reddish color, and this can only be accomplished by a quick coagulation of the surface albumen. The time for roasting varies slightly with the kind of meat and the size of the joint. As a rule beef and mutton require a quarter of an hour to the pound; veal and pork about 17 minutes to the pound. To tell whether the joint is done, press the fleshy part with a spoon; if the meat yield easily it is done. With poultry or game the flesh of the leg may be tried in the same way. Some attach importance to occasional jets of steam drawing to the fire. Roasting, when well done (and the way to do it can only be learned by careful practice), is a wholesome method of cooking.

**Baking** meat is in many respects objectionable, and should never be done if any other method is available. The gradual disuse of open grates for roasting has led to a practice of first baking and then browning before the fire. This method completely reverses the true order of cooking by beginning with the lowest temperature and finishing with the highest. Baked meat has never the delicate flavor of roast meat, nor is it so digestible. The vapors given off by the charring of the surface cannot freely escape, and the meat is cooked in an atmosphere charged with empyreumatic oil. A brick or earthenware oven is preferable to iron, because the porous nature of the bricks absorbs a good deal of the vapor. When potatoes are baked with meat, they should always be first parboiled, because they take a longer time to bake, and the moisture rising from the potatoes retards the process of baking, and makes the meat sodden. A baked meat pie, though not always very digestible, is far less objectionable than plain baked meat. In the case of a meat pie the surfaces of the meat are protected by a bad conductor of heat from that charring of the surface which generates empyreumatic vapors, and the fat and gravy, gradually rising in temperature, assist the cooking, and such cooking more nearly resembles stewing than baking. The process may go on for a long time after the removal of the meat from the oven, if surrounded with flannel or some bad conductor of heat. The Cornish pasty is the best example of this kind of cooking. Meat, fish, game, parboiled vegetables, apples, or anything that fancy suggests, are surrounded with a thick flour and water crust and slowly baked. When removed from the oven, and packed in layers of flannel, the pastry will keep hot for hours. When baked dishes contain eggs, it should be remembered that the albumen becomes harder and more insoluble, according to the time occupied in cooking. About the same time is required for baking as roasting.

**Boiling** is one of the easiest methods of cooking, but a successful result depends on a number of conditions which, though they appear trifling, are nevertheless necessary. The fire must be watched so as properly to regulate the heat. The saucepan should be scrupulously clean and have a closely-fitting lid, and be large enough to hold sufficient water to well cover and surround the meat, and all scum should be removed as it comes to the surface; the addition of small quantities of cold water will assist the rising of the scum. For all cooking purposes clean rain water is to be preferred. Among cooks a great difference of opinion exists as to whether meat should be put into cold water and gradually brought to the boiling point, or should be put into boiling water. This, like many other unsettled questions in cookery, is best decided by careful scientific experiment and observation. If a piece of meat be put into water at a temperature of 60°, and gradually raised to 212°, the meat is undergoing a gradual loss of its soluble and nutritious properties, which are dissolved in the water. From the surface to the interior the albumen is partially dissolved out of the meat, the fibres become hard and stringy, and the thinner the piece of meat the greater the loss of all those sapid constituents which make boiled

meat savory, juicy and palatable. To put meat into cold water is clearly the best method for making soups and broth; it is the French method of preparing the *pot au feu*; but the meat at the end of the operation has lost much of that juicy sapid property which makes boiled meat so acceptable. The practice of soaking fresh meat in cold water before cooking is for the same reasons highly objectionable; if necessary, wipe it with a clean cloth. But in the case of salted, smoked, and dried meats soaking for several hours is indispensable, and the water should be occasionally changed. The other method of boiling meat has the authority of the late Baron Liebig, who recommends putting the meat into water when in a state of ebullition, and after five minutes the saucepan is to be drawn aside, and the contents kept at a temperature of 162° (50° below boiling). The effect of boiling water is to coagulate the albumen on the surface of the meat, which prevents, but not entirely, the juices passing into the water, and meat thus boiled has more flavor and has lost much less in weight. To obtain well-flavored boiled meat the idea of soups or broth must be a secondary consideration. It is, however, impossible to cook a piece of meat in water without extracting some of its juices and nutriment, and the liquor should in both cases be made into a soup.

*Stewing.*—When meat is slowly cooked in a close vessel it is said to be stewed; this method is generally adopted in the preparation of made dishes. Different kinds of meat may be used, or only one kind according to taste. The better the meat the better the stew; but by carefully stewing the coarsest and roughest parts will become soft, tender, and digestible, which would not be possible by any other kind of cooking. The only objection to stewing is the length of time; but a dinner may be prepared in this way the day before it is required. Odd pieces of meat and trimmings and bones can often be purchased cheaply, and may be turned into good food by stewing. Bones, although containing little meat, contain from 39 to 49 per cent. of gelatine. The large bones should be broken into small pieces, and allowed to simmer until every piece is white and dry. Gelatine is largely used both in the form of jellies and soups. It is said by some authorities to be comparatively valueless as a food, but more recent investigations seem to prove that gelatine, although not of the same food value as albumen, leaves the body as urea, and must therefore have taken part in nutrition. Lean meat, free from blood, is best for stewing, and, when cut into convenient pieces, it should be slightly browned in a little butter or dripping. Constant attention is necessary during this process to prevent burning. The meat should be covered with salt water, or, better, a little stock, and set aside to simmer for four or five hours, according to the nature of the material. When vegetables are used, these should also be slightly browned and added at intervals, so as not materially to lower the temperature. Stews may be thickened by the addition of pearl barley, sago, rice, potatoes, oatmeal, flour, &c., and flavored with herbs and condiments according to taste. Although stewing is usually done in a stewpan or saucepan with a closely-fitting cover, a good stone jar, with a well-fitting lid, is preferable in the homes of working people. This is better than a metal saucepan, and can be more easily kept clean; it retains the heat longer, and can be placed in the oven or covered with hot ashes. The common red jar is not suitable; it does not stand the heat so well as a grey jar; and the red glaze inside often gives way in the presence of salt. The lid of a vessel used for stewing should be removed as little as possible. An occasional shake will prevent the meat sticking. At the end of the operation all the fat should be carefully removed.

*Frying.*—Lard, oil, butter, or dripping may be used for frying. There are two methods of frying—the dry method, as in frying a pancake, and the wet method, as when the thing fried is immersed in a bath of hot fat. In the former case a frying pan is used, in the other a frying kettle or stewpan. It is usual for most cooks to have a wire frying basket; the things to be fried are placed in the basket and immersed at the proper temperature in the hot fat. The fat should gradually rise in temperature over a slow fire till it attains nearly 400° Fahr. Great care is required to fry properly. If the temperature is too low the things immersed in the fat are not fried, but soddened; if, on the other hand, the temperature is too high, they are charred. The temperature of the fat varies slightly with the nature

of things to be fried. Fish, cutlets, croquets, rissoles, and fritters are well fried at a temperature of 380° Fahr. Potatoes, chops, and white bait are better fried at a temperature of 400° Fahr. Care must be taken not to lower the temperature too much by introducing too many things. The most successful frying is when the fat rises two or three degrees during the frying. Fried things should be of a golden brown color, crisp, and free from fat. When fat or oil has been used for fish it must be kept for fish. It is customary first to use fat for croquets, rissoles, fritters, and other delicate things, and then to take it for fish. Everything fried in fat should be placed on bibulous paper to absorb any fat on the surfaces. (J. C. B.)

COOLIE, or COOLY, a word applied to designate an Asiatic laborer not belonging to the skilled or artisan class. Its derivation is far from certain. Dr. Engelbert Kämpfer, in his *History of Japan* (London, 1727, describes as "coolies" the dock laborers, or, as they are called in England, "lumpers," who unloaded the Dutch merchant ships at Nagasaki. At Canton to this day a laborer in any European factory is known as a "coolie;" and though some have thought that the word may be of Chinese origin, as a matter of fact it is through Europeans that the natives of the Celestial Empire first became acquainted with the term. Of late the word is almost exclusively used to designate those natives of India and China who leave their native country under contracts of service to work as field-hands or laborers in foreign plantations and elsewhere.

The organization, partly official and partly voluntary, by means of which these Eastern laborers are collected, engaged, and conveyed to their respective destinations, has within recent times developed itself into a regular trade. The French, Portuguese, and Spanish nations prosecute this trade to a certain extent, and one or two South American republics also take part in it; but the great bulk of the traffic is now undoubtedly British.

Coolie emigration is the direct offspring of the discontinuance of slavery. When slave labor was no longer available, the colonists who had used it were placed in an awkward dilemma. White men were physically incapable of field work on tropical plantations, and free negroes could not be induced to engage in it. In these circumstances there were but two alternatives open to the planters. Either they must abandon their estates, or they must import labor from other countries than those which had been drained and devastated by the slave trade. There were many considerations that pointed to India and China as the fields most likely to yield that supply of workers on getting which the very existence of the West Indies depended. Those great Asiatic empires were over-peopled; their rigid forms of civilization, which had rooted them to the soil, were gradually being loosened by the impact of European commerce; and their reluctance to leave their native shores was removed by tempting offers made to them.

*Chinese Coolies.*—The first public recognition of the traffic was in 1844, when the British colony of Guiana made provision for the encouragement of Chinese emigration. About the same time the Peruvian planters, who since their separation from the mother country had restricted slavery within the narrowest limits, also looked to China as being likely to furnish an efficient substitute for the negro bondsman. Agents armed with consular commissions from Peru began to appear in Chinese ports, where they collected and sent away ship-loads of coolies. Each one was bound to serve the Peruvian planter to whom he might be assigned for seven or eight years, at fixed wages, generally about 17s. a month,—food, clothes, and lodging being provided. Cuba, profiting by the example of Peru, also engaged in the traffic. In 1847, therefore, two ships went from Amoy to Havana, one with 350, the other with 629 coolies on board. From 1847 to 1856 the trade went on briskly without attracting much notice. Gradually, however, ugly reports as to the treatment the coolies received, both on their voyage to and after their arrival in Peru and Cuba, began to come to Europe and Asia. Still more painful rumors were set afloat regarding the thievish devices used to induce Chinese emigrants to leave their native land. It was said they were kidnapped, or tempted to engage under false pretences. It was declared that the transport ships were badly equipped and overcrowded, and that on their voyages they reproduced all the horrors of the "middle passage" in the old African slave



trade. Those who were safely landed in Cuba or Peru were sold by auction in the open market to the highest bidders, who thus purchased them, holding them virtually as slaves for seven years instead of for life. Brutal as was the treatment to which these poor wretches were exposed on the plantations, it was merciful compared with that which fell to the lot of those who, contrary to their agreements, had been sent to labor in the foul guano pits of the Chincha Islands. Here they were forced to toil in gangs, each under an overseer, armed with a cowhide lash 5 feet long and 1½ inches thick. It was claimed as a merit that up to four o'clock each afternoon this weapon "was not much used." After that hour, however, the weaker coolies had their flagging energies stimulated by cuts of the whip, and remonstrance and entreaty were "punished by a flogging little short of murder." This horrible treatment speedily aroused attention; and a memorial was presented to the British Government by shipmasters engaged in the Chincha Islands guano trade. Even the United States skippers declared they "never saw or heard of slavery approaching that of the middle island of the Chinchas in misery." In 1860 it was calculated that of the 4000 coolies who since the traffic began had been fraudulently consigned to the guano pits of Peru, not one had survived. Some had poisoned themselves with opium; others deliberately contrived that they should be buried alive under falling masses of guano; many jumped off the cliffs and drowned themselves in the sea. When these atrocities came to light in 1854, the British governor of Hong Kong issued a proclamation forbidding British subjects or vessels to engage in the transport of coolies to the Chinchas. Technically this was *ultra vires* on his part. But in the following year Parliament confirmed his humane policy by passing the Chinese Passengers Act (18 and 19 Vict. c. 104), which put an end to the more abominable phase of the traffic. After that no British ship was allowed to sail on more than a week's voyage with more than twenty coolies on board, unless her master had complied with certain very stringent regulations.

The consequence of this was that the business of shipping coolies for Peru was transferred to the Portuguese settlement of Macao. There the Peruvian and Cuban "labor-agents" established depôts, which they unblushingly called "barracoons," the very term used in the West African slave trade. In these places coolies were "received," or in plain words, imprisoned and kept under close guard until a sufficient number were collected for export. Some of these were decoyed by fraudulent promises of profitable employment. Others were kidnapped by piratical junks hired to scour the neighboring coasts. Many were bought from leaders of turbulent native factions, only too glad to sell the prisoners they captured whilst waging their internecine wars. The procurador or registrar-general of Macao went through the form of certifying the contracts; but his inspection was therefore practically useless. After the war of 1856-57 this masked slave trade pushed its agencies into Wampoa and Canton. In April, 1859, however, the whole mercantile community of the latter port rose up in indignation against it, and transmitted such strong representations to the British embassy in China, that steps were taken to mitigate the evil. New regulations were from time to time passed by the Portuguese authorities for the purpose of minimizing the horrors of the Macao trade. They seem, however, to have been systematically evaded, and to have been practically inoperative. In 1868 the governor of Macao attempted to put in force humane regulations, but without success, as was proved by the trial of a Chinaman, Kwok-a-Sing, on the 29th of March, 1871, before Chief-Justice Smale of Hong-Kong. The prisoner had been an emigrant on board the French ship "Nouvelle Pénelope," which sailed in October, 1871, from Macao with 300 coolies. They mutinied on the voyage, and killed the master and seven of the crew. Kwok-a-Sing was acquitted when tried for being an accessory to this crime. In the course of his trial, however, it was proved that though some of the mutineers were hardened criminals who had shipped as coolies merely for the purpose of raising a mutiny and plundering the ship, upwards of one-third of the emigrants on board had been kidnapped and were feloniously held in bondage. Commenting on this case, the British consul said the benevolent regulations of the Macao Government looked well on paper, but in practice they were capable of being

evaded to an extent that made the coolie traffic "simply a slave trade, and a disgrace to any Christian Government that permits its perpetration within its jurisdiction." At Canton and Hong-Kong the coolie trade was put under various regulations, which in the latter port worked well only when the profits of "head-money" were ruined. In March, 1866, the representatives of the Governments of France, England, and China drew up a convention for the regulation of the Canton trade, which had an unfortunate effect. It left head-money, the source of most of the abuses, comparatively untouched. It enacted that every coolie must at the end of a five years' engagement have his return passage-money paid to him. The West Indian colonies at once objected to this. They wanted permanent not temporary settlers. They could not afford to burden the coolie's expensive contract with return passage-money, so they declined to accept emigrants on these terms. Thus a legalized coolie trade between the West Indies and China was extinguished.

*Indian Coolies.*—With reference to the Indian coolie trade it is scarcely possible to say when it began. Before the end of last century Tamil laborers from Southern India were wont to emigrate to the Straits settlements, and they also flocked to Tenasserim from the other side of the Bay of Bengal after the conquest had produced a demand for labor. Ceylon also obtained workers from Southern India, and the extent of the emigration may be estimated by the fact that, taking a period of ten years ending 1869, about 65,000 emigrants, of whom 50,000 were adult males, landed annually in the island, and some 48,000 returned each year to their homes. In Penang it is calculated that 25,000 souls out of a population of 150,000 are Indian coolies. It is in domestic and agricultural service that they are employed in the Straits settlements, and more recently large numbers of coolies have been induced to work in the tea-gardens of Assam. On the other hand, in Burmah, they work as dock laborers and porters. In Mauritius, again, the first regularly recorded attempt at organizing coolie emigration from India took place in 1834, when forty coolies were imported. Between 1834 and 1837 about 7000 laborers must have been shipped from Calcutta, and about 100 from Bombay, to Mauritius, but it was not till 1836 that the colonial Government determined to put the trade under official regulations. In 1837 an emigration law was passed for Calcutta, but it also applied to all territories of the East India Company, providing that a "permit" must be got from the Government for every shipment of coolies, that all contracts should terminate in five years, that a return passage should be guaranteed, and that the terms of his contract should be carefully explained to each coolie. As regards the emigrant ships they were allowed to carry one coolie for every ton and a half of burthen—a rule now extended to one coolie for every two tons burthen. Then as now the Indian Government watched the depopulation of labor from their dominions with jealous and anxious care, and when in 1838 it was found that upwards of 25,000 natives had, up to that year, gone from all parts of India to Mauritius, the Government became a little alarmed at the dimensions the traffic was assuming. Brougham and the old anti-slavery party denounced the trade as a revival of slavery, and the Presidency Government suspended it in order to investigate its alleged abuses. The nature of these may be guessed when it is said that the inquiry condemned the fraudulent methods of recruiting them in vogue, and the brutal treatment coolies often received from ship captains and masters. It was not till 1842 that steps were taken to formally reopen the coolie trade between Mauritius and India. A regulating Act was passed, the most important provisos of which were the appointment of authorized emigration agents at Indian ports, and a prohibition against contracts being signed till the coolie had been forty-eight hours on shore in the colony for which he was bound. At first the term was for one year, and the wages were five rupees a month, food, clothing, and medical attendance being found. Return passages were also guaranteed. In 1844 coolie emigration to the West Indies was sanctioned by the Indian Government. Jamaica, Trinidad, and Demerara were permitted to import coolies under the Mauritius rules, slightly modified,—one of the most important differences being that 12 per cent. of the emigrants to the West Indies were to be women. None of the colonial codes, however, seem to have carried out this modification. In 1847 Ceylon suffered by the political accident of having a

separate Government. Her supply of labor was cut off, as the Indian Government prohibited all emigration save to the West Indies and Mauritius. The unfair prohibition was withdrawn, on the Ceylon Government adopting certain protective regulations in favor of the emigrants, and ever since the coolie trade with the island has gone on pretty smoothly. In 1851 the Indian Government agreed to relieve Mauritius of the obligation to provide return passages save for the destitute and the sick. In 1853 Lord Dalhousie's Government extended the term qualifying the West Indian coolie for return from five to ten years' service. In 1857 the colonial Governments proposed to commute the coolie's claim for a return passage, by giving him its value in land; but Lord Canning's Government viewed the suggestion with great jealousy, saying there must be some guarantee that in arranging the commutation the coolie was not swindled. In 1859 voluntary commutation was agreed to by the Indian authorities. Since then many changes have taken place, but, generally speaking, the Indian coolie trade is now regulated by two Acts—those of 1864 and 1869, of which the main provisions are as follows:—

Resident colonial emigration agents are appointed for the different ports. They appoint sub-agents or remitting parties, who must bear licenses from the Protector of Emigrants at Calcutta. It is their business to beat up the country for coolies when there is a demand for them. The intending emigrants, when collected, must be taken by the agents before the resident magistrate of the district, who registers each one. A copy or certificate of registration is given to each coolie, stating particulars as to age, sex, name, caste, and former occupation. Of these documents duplicates are transmitted to the colonial emigration agent. When this formality has been complied with, the coolie is then sent on to the *dépôt* and examined there by the colonial agent and surgeons. If physically unfit for the work for which he is wanted, of course he is summarily rejected. Each coolie ship must undergo rigorous sanitary inspection, and carry a surgeon, who reports on all the deaths and cases of sickness that occur during the passage. The contract which the coolie signs with the emigration agent binds him to serve not more than for 7½ hours a day for five years, as an agricultural laborer, on the estate to which he may be sent by the authorities at the port of debarkation. The wage in money is to be that which from time to time is paid to unindentured laborers in the colony. (In Demerara the Indian coolie earns 1s. 2d. a day,—women about 1s., and children 6d. each.) The coolie also is provided with a house, garden, and medical attendance,—rations and clothing being subject to the special arrangements affecting wages; while at the end of ten years' service they are entitled to a free return passage to India.

As to the treatment of the coolie in the colonies when he arrives, of course there is much dispute. Statistics indicate that it cannot have been very considerate. From 1834 to 1872 Demerara, Trinidad, Jamaica, St. Vincent, and Grenada imported 161,539 coolies, of whom 16,938 have returned home, and 48,548 are dead, leaving 96,053 in those colonies. As far as official rules can protect him a great deal is done by the Government. When he lands he is subjected to an examination by the immigration agent-general and an officer of health. Those not fit for agricultural labor are set aside, and those that are fit are allotted to different plantations in accordance with the demand made for them. Family life is respected, and children under fifteen years of age must not be parted from their parents. After their five years' indenture is ended, they are at liberty to re-engage on an independent footing, a bounty of about £11 being given to those who re-contract for another term of similar duration. How these apparently equitable provisions work became a matter of dispute in the case of Demerara and Mauritius; and serious complaints were made in 1869 with reference to the former colony by Mr. G. W. des Vœux, a stipendiary magistrate, who had spent five years in the country. Commissioners were therefore despatched to inquire into the matter. They suggested certain reforms for the purpose of guarding the indentured laborer against the possibility of ill-treatment, and the powers of the immigration agent-general, or protector of immigrants, were enlarged so as to enable him to inspect estates more regularly, frequently, and efficiently. The medical officers of plantations, too, were made civil servants, and relieved from their dependence on the planters for their salaries. The question of re-engagements was also dealt with by the reforming ordinance of 1868 in a provision enacting that the manager of every estate should,

at the half-yearly visit of the agent-general, produce before him every coolie who had completed his term of service, or would complete it in the course of the next six months. To each coolie in this position a certificate or a provisional certificate of exemption from labor must be handed, and not till then may the manager or any employer negotiate with him for re-indenture.

The case of Mauritius was more serious. It had long been suspected that the colony had been indulging in a course of legislation, the tendency of which, says Mr. Geoghegan, the under-secretary to the department of agriculture in the Government of India, was "towards reducing the Indian laborer to a more complete state of dependence upon the planter, and towards driving him into indentures, a free labor market being both directly and indirectly discouraged." In 1871, acting on a petition presented by M. Adolph de Plevitz, a resident in the colony, who loudly denounced this injustice, the governor, Sir Arthur Gordon, appointed a police inquiry commission to investigate the matter; and thereafter a royal commission was appointed at the request of the planters, and its report was presented to the Imperial Parliament in 1875. The investigation showed that the treatment experienced by the coolies was extremely unsatisfactory, and that in many respects they were too much in the power of the planters.

With reference to the treatment of the coolie in foreign colonies it is more difficult to obtain the necessary information. In Cuba the Chinese laborers were subjected to such scandalous ill-usage that the Spanish Government was forced to interfere, especially when it was found the Chinese were beginning to take part with the insurgents. In 1871 a royal decree was issued suspending the importation of coolies to the colony, and giving power to the Government to give return passages to all who had finished their contracts and were not willing to re-engage. The decree, however, has been ignored. It is well known that rather than enter into another contract the Chinaman will leave the island. But then the Cubans desire him to remain so that a permanent laboring class may be created.

In many of the French colonies Indian laborers are imported, there being a convention between the Governments of France and India which admits of this being done. There, it is feared, the coolie is the victim of abuses and oppression which, happening as they do in foreign dominions, are not easily redressed. In Cayenne there is reason to believe the mortality amongst the coolies who labor in the gold mines is abnormally high; it is said that more than half the Indians imported "cannot be accounted for." In Réunion, Guadeloupe, and Martinique they are said to be systematically overworked; and according to Mr. Geoghegan there seems to be a disposition in Réunion to prevent their having free access to the British consul when they have occasion to claim his protection. (R. WL.)

COOMASSIE, or KUMASSI, the capital of Ashantee, in Guinea, West Africa, in 6° 34' 50" N. lat. and 2° 12' W. long., and 130 miles N.N.W. of Cape Coast Castle, is situated on a low rocky eminence, from which it extends across a valley to the hill opposite, and occupies an area of about 1½ miles in length and over 3½ miles in circumference. It lies in the midst of a thick and jungly forest, and is nearly surrounded by a pestilential swamp. The town was founded in the middle of the 18th century by Sy Tutu. At the time of its capture by the British (February 4, 1874) it consisted of numerous streets, some of which were broad and regular; the main avenue was 70 yards in width. The houses were painted red and white, and had alcoves and stuccoed façades. The king's palace, a handsome building, was blown up on the destruction and evacuation of the town by Wolsley's forces (February 6). About 300 yards from the site of the palace is the grove into which the bodies of some thousand criminals and victims of the rites of Ashantee superstitions were yearly cast. Coomassie has a considerable trade with Central Africa. Bowditch estimated its population at 18,000. See ASHANTEE, vol. ii. p. 594.

COOPER, ABRAHAM (1787-1868), an animal and battle painter, was the son of a tobacconist, and was born in London, in 1787. At the age of thirteen he became an employé at Astley's amphitheatre, and was afterwards groom in the service of Sir Henry Meux. When he was twenty-two, wishing to possess a portrait of a favorite horse under his care, he bought a manual of painting, learned something of the use of oil-colors, and painted the picture

on a canvas hung against the stable wall. His master bought it and encouraged him to continue in his efforts. He accordingly began to copy prints of horses, and was introduced by Davis, the equestrian, to Benjamin Marshall, the animal painter, who took him into his studio, and seems to have introduced him to the *Sporting Magazine*, an illustrated periodical to which he was himself a contributor. In 1814 he exhibited his Tam O'Shanter, and in 1816 he won a prize of £100 for his Battle of Ligny. In 1817 he exhibited his Battle of Marston Moor and was made Associate of the Academy, and in 1820 he was elected Academician. He died in 1868. Cooper, although ill educated, was a clever and conscientious artist; his coloring was somewhat flat and dead, but he was a skilful draughtsman and a master of equine portraiture and anatomy, and had some antiquarian knowledge. He had a special fondness for Cavalier and Roundhead work, and his best pictures are those in which he has reproduced the subjects of that period.

COOPER, ANTHONY ASHLEY. See SHAFTESBURY.

COOPER, SIR ASTLEY PASTON (1768-1841), a celebrated surgeon, was born at the village of Brooke, in Norfolk, August 23, 1768. His father, Dr. Cooper, was a clergyman of the Church of England; his mother was the author of several novels. At the age of sixteen he was sent to London and placed under Mr. Cline, surgeon to St. Thomas's Hospital. From the first he devoted himself to the study of anatomy, and had the privilege of attending the lectures of John Hunter. In 1787 he was appointed demonstrator of anatomy at St. Thomas's Hospital. In 1791 he delivered part of the course of lectures on anatomy and surgery at St. Thomas's Hospital. In this year he married; and in the spring of 1792 he visited Paris. In the latter year he was also appointed professor of anatomy to Surgeon's Hall,—a situation which he again filled in 1794 and 1795. In 1800 he was appointed surgeon to Guy's Hospital, on the death of his uncle, William Cooper. In 1802 he received the Copley medal for two papers read before the Royal Society of London on the destruction of the membrana tympani; and in 1805 he was elected a fellow of that society. Having taken an active part in the formation of the Medico-Chirurgical Society, he published in the first volume of its *Transactions* an account of an unsuccessful attempt to tie the carotid artery. Another of his remarkable attempts was to tie the aorta. In 1804 he brought out the first, and in 1807 the second, part of his great work on Hernia—the operation for which, on account of the defective knowledge of the local anatomy, was then frequently unsuccessful. So greatly did this work add to his reputation, that in 1813 his annual professional income rose to £21,000 sterling. He was soon after appointed professor of comparative anatomy to the Royal College of Surgeons. In 1820 he removed a steatomatous tumor from the head of George IV. About six months afterwards he accepted a baronetcy, which, as he had no son, was to descend to his nephew and adopted son, Astley Cooper; in 1827 he was elected President of the Royal College of Surgeons; and in 1830 vice-president of the Royal Society. He was also chosen member of the French Institute; the degree of D.C.L. was conferred on him by Oxford, and that of LL.D. by Edinburgh; and he was appointed sergeant-surgeon to the king. He died on the 12th February, 1841, at the age of seventy-three. He was interred, by his own desire, beneath the chapel of Guy's Hospital; and a statue by Bailey was erected to his memory in St. Paul's Cathedral.

His chief works are *Medical Records and Researches* (1798); *On Hernia* (1804-7); *Dislocations and Fractures* (1822); *Treatise on the Anatomy and Diseases of the Breast* (1829-40); *Anatomy of the Thyroid Gland* (1832). See *Life of Sir A. Cooper*, by B. Cooper.

COOPER, CHARLES HENRY (1808-1866), the historian of Cambridge, was born at Great Marlow, 20th March, 1808, being descended from a family formerly settled at Bray, Berkshire. He received his education at a private school in Reading. In 1826 he fixed his residence at Cambridge, and in 1836 was elected coroner of the borough. Four years later he was admitted a solicitor, and in course of time he acquired an extensive practice, but his taste and inclination ultimately led him to devote almost the whole of his time to literary research, and especially the elucidation of the history of the University of Cambridge. In 1849

he resigned the office of borough coroner on being elected to the town-clerkship, which he retained till his death on March 21, 1866. His earliest production, *A New Guide to the University and Town of Cambridge*, was published anonymously in 1831. *The Annals of Cambridge* followed, in 4 vols. 8vo, 1842-52, containing a chronological history of the university and town from the earliest period to the year 1849. His most important work, the *Athenæ Cantabrigienses*, a companion work to the famous *Athenæ Oxonienses* of Anthony à Wood, contains biographical memoirs of the authors and other men of eminence who were educated at the university of Cambridge. The work has not been completed; only two volumes have been published (in 1858 and 1861), embracing the period between 1500 and 1609. Cooper's other works are *The Memorials of Cambridge*, 3 vols. 1858-66, and a *Memoir of Margaret, Countess of Richmond and Derby*, 1874, a posthumous publication. He was a constant contributor to *Notes and Queries*, the *Gentleman's Magazine*, and other antiquarian publications, and left an immense collection of MS. materials for a biographical history of Great Britain and Ireland.

COOPER, JAMES FENIMORE (1789-1851), an American novelist, was born at Burlington, New Jersey, on the 15th September, 1789. Reared in the wild country round the Otego Lake, on the yet unsettled estates of his father, a judge and member of Congress, he was sent to school at Albany and at New Haven, and entered Yale College in his thirteenth year, remaining for some time the youngest student on the rolls. Three years afterwards he joined the United States navy; but after making a voyage or two in a merchant vessel, to perfect himself in seamanship, and obtaining his lieutenantcy, he married and resigned his commission (1811). He settled for a while at Westchester, the "Neutral Ground" of his earliest American romance, and produced anonymously (1819) his first book, *Precussion*, a novel of the fashionable school. This was followed (1821) by *The Spy*, which was very successful at the date of issue; *The Pioneers*, the first of the "Leatherstocking" series; and *The Pilot* (1823), a bold and dashing sea-story. The next was *Lionel Lincoln* (1825), a feeble and unattractive work; and this was succeeded in 1826 by the famous *Last of the Mohicans*, a book that is often quoted as its author's masterpiece. Quitting America for Europe he published at Paris *The Prairie* (1826), the best of his books in nearly all respects, and *The Red Rover*, by no means his worst.

At this period the unequal and uncertain talent of Cooper would seem to have been at its best. These excellent novels were, however, succeeded by one very inferior, *The Wept of Wish-ton-Wish* (1827); by *The Notions of a Travelling Bachelor* (1828), an uninteresting book; and by *The Waterwitch* (1830), one of the poorest of his many sea-stories. In 1830 he entered the lists as a party writer, defending in series of letters to the *National*, a Parisian journal, the United States against a string of charges brought against them by the *Révue Britannique*; and for the rest of his life he continued skirmishing in print, sometimes for the national interest, sometimes for that of the individual, and not infrequently for both at once. This opportunity of making a political confession of faith appears not only to have fortified him in his own convictions, but to have inspired him with the idea of imposing them on the public through the medium of his art. His next three novels, *The Bravo* (1831), *The Heidenmauer* (1832), and *The Headman of Berne* (1833), were designed to exalt the people at the expense of the aristocracy. Of these the first is by no means a bad story, but the others are among the duller ever written; all were widely read on both sides of the Atlantic.

In 1833, Cooper returned to America, and immediately published *A Letter to My Countrymen*, in which he gave his own version of the controversy he had been engaged in, and passed some sharp censure on his compatriots for their share in it. This attack he followed up with *The Monikins* and *The American Democrat* (1835); with several sets of notes on his travels and experiences in Europe, among which may be remarked his *England* (1837), in three volumes, a burst of vanity and ill-temper; and with *Homeward Bound*, and *Home as Found* (1838), noticeable as containing a highly idealized portrait of himself. All these books tended to increase the ill-feeling between author and public; the press was virulent and scandalous in its comments, and Cooper plunged at once into a series of actions for libel. Victorious in all of them he returned to his old

occupation with something of his old vigor and success. A *Naval History of the United States* (1839), supplemented (1846) by a set of *Lives of Distinguished American Naval Officers*, was succeeded by *The Pathfinder*, a good "Leatherstocking" novel; by *Mercedes of Castile*, and *The Deer-slayer* (1841); by *The Two Admirals*, and by *Wing and Wing* (1842); by *Wyandotté*, the *History of a Pocket Handkerchief*, and *Ned Myers* (1843); and by *Afloat and Ashore* and *Miles Walkingford* (1844). From pure fiction, however, he turned again to the combination of art and controversy in which he had achieved distinction, and in the three *Littlepage Stories* (1845-6) he fought with a great deal of vigor. His next novel was *The Crater, or Vulcan's Peak* (1847), in which he attempted to introduce supernatural machinery with indifferent success; and this was succeeded by *Oak Openings and Jack Tier* (1848), the latter a curious *risarcimento* of *The Red Rover*; by *The Sea Lions* (1849); and finally by *The Ways of the Hour* (1850), another novel with a purpose, and his last book. He died of dropsy at Cooperstown, New York, in his sixty-second year.

Cooper was certainly one of the most popular authors that have ever written. His stories have been translated into nearly all the languages of Europe and into some of those of Asia, and are even now found worthy the honors of a cheap reprint. Balzac admired him greatly, but with discrimination; Victor Hugo pronounced him greater than the great master of modern romance, and this verdict was echoed by a multitude of inferior readers, who were satisfied with no title for their favorite less than that of "the American Scott." As a satirist and observer he is simply the "Cooper who's written six volumes to prove he's as good as a Lord" of Lowell's clever portrait; his enormous vanity and his irritability find vent in a sort of dull violence, which is exceedingly tiresome. It is only as a novelist that he deserves consideration. His qualities are not those of the great masters of fiction; but he had an inexhaustible imagination, some faculty for simple combination of incident, a homely tragic force which is very genuine and effective, and up to a certain point a fine narrative power. His literary training was inadequate; his vocabulary is limited and his style awkward and pretentious; and he had a fondness for moralizing tritely and obviously, which mars his best passages. In point of conception, each of his three-and-thirty novels is either absolutely good or is possessed of a certain amount of merit; but hitches occur in all, so that every one of them is remarkable rather in its episodes than as a whole. Nothing can be more vividly told than the escape of the Yankee man-of-war through the shoals and from the English cruisers in *The Pilot*, but there are few things flatter in the range of fiction than the other incidents of the novel. It is therefore with some show of reason that *The Last of the Mohicans*, which as a chain of brilliantly narrated episodes is certainly the least faulty in this matter of sustained excellence of execution, should be held to be the best of his works.

The personages of his drama are rather to be accounted as so much painted cloth and cardboard, than as anything approaching the nature of men and women. As a creator of aught but romantic incident, indeed, Cooper's claims to renown must rest on the fine figure of the Leatherstocking, and, in a less degree, on that of his friend and companion, the Big Serpent. The latter has many and obvious merits, not the least of which is the pathos shed about him in his last incarnation as the Indian John of *The Pioneers*. Natty Bumppo, however, is a creation of no common unity and consistency. There are lapses and flaws, and Natty is made to say things which only Cooper, in his most verbosely didactic vein, could have uttered. But on the whole the impression left is good and true. In the dignity and simplicity of the old backwoodsman there is something almost Hebraic. With his naïve vanity and strong reverent piety, his valiant wariness, his discriminating cruelty, his fine natural sense of right and wrong, his rough limpid honesty, his kindly humor, his picturesque dialect, and his rare skill in woodcraft, he has all the breadth and roundness of a type and all the eccentricities and peculiarities of a portrait.

See Griswold, *Prose Writers of America*, Philadelphia, 1847: *Eclectic Magazine*, 1851; J. R. Lowell, *Fable for Critics*; and *AMERICAN LITERATURE*, vol. 1., p. 636. (W. E. H.)

COOPERAGE, the art of making casks, barrels, and other rounded vessels, the sides of which are composed of

separate staves, held together by hoops surrounding them. The art is one of great antiquity, being mentioned by Pliny, who ascribes its invention to the inhabitants of the Alpine valleys. The cask or barrel form is at once the strongest, tightest, and most convenient form into which wood can be fashioned as a vessel for storing either liquid or solid substances, and the manufacture has attained great precision and perfection. The trade is one in which there are numerous subdivisions, the chief of which are tight or wet and dry or slack cask manufacture. To these may be added white cooperage, a department which embraces the construction of wooden tubs, pails, churns, and other even-staved vessels. Of all departments, the manufacture of tight casks or barrels for holding liquids is that which demands the greatest care, experience, and skill; as, in addition to perfect tightness when filled with liquid, the vessels must bear the strain of transportation to great distances, and in many cases they have to resist considerable internal pressure when they contain fermenting liquors. Cooperage is still most commonly pursued as a handicraft with the tools and appliances which have been employed from the earliest times; but many expedients of the greatest ingenuity and efficiency have been introduced for performing the numerous operations by mechanical means. Tight casks are generally made of well-seasoned oak of the best quality, free from twists and warping. Whether accomplished by hand or machinery the following are the essential operations. 1st. The preparation of the staves is the most important and difficult task of the cooper, inasmuch as a cask being a double conoid, having its greatest diameter (technically the bulge or belly) in its centre, each stave must be accurately curved to form a segment of the whole. The taper from the centre to the extremities must be curved; in cross section it must be double concave, and the joints, or edges, must be so bevelled that when bent into position they shall form a true plane through the central axis of the vessel. 2d. Trussing consists of setting the separate staves properly bevelled and jointed, upright in a frame in order to receive trussing hoops at both ends, which serve to keep them together for the permanent hooping. The lower ends of the staves are set together in a frame and a hoop passed round them. A rope is then carried round the upper part and gradually tightened till the joints are brought quite close, when a hoop is dropped over and the rope removed. 3d. Chiming and crozing consists in finishing the two ends for receiving the heads. The chime is the bevel formed on the extremity of the staves, and the croze consists of the groove into which the ends or heads fit. 4th. Hooping, and 5th. Preparing heads or ends, are the other operations to be noticed. For wet casks hoops are generally made of iron, although wooden hoops also are employed. The heads, when made of two or more pieces, are joined by means of dowel pins, and after being cut to the proper size they are chamfered or bevelled at the edges to fit into the croze grooves. Drawings and descriptions of a very elaborate and complete series of machines made by Messrs. Allen, Ransome & Co. of Chelsea, from the designs of Mr. John Richard, for performing these various operations, will be found in *Engineering* (vol. xxi., January-June, 1876).

The quantity of tight casks required in certain industries is incalculable. On the continent of Europe they are in most extensive demand in the wine-producing districts. In Great Britain, brewers and distillers must have enormous stocks, and both in Great Britain and in the United States the mineral oil and petroleum trade employ vast quantities. Slack barrels are almost as extensively employed in connection with chemical industries and the fruit and fish trades. In America slack barrels are the form most generally adopted for packing almost all kinds of dry goods for storing and transport, and the flour, rosin, fruit, and other products sent to Europe are almost invariably inclosed in such vessels.

CO-OPERATION, a term in social economics, which, though of generic significance in the science of industry and trade, has a specific and technical sense, implying the association of any number of individuals or societies for mutual profit, whether in the purchase and distribution of commodities for consumption, or in the production of commodities, or in the borrowing and lending of capital among workmen.

The most powerful co-operative force in the industrial system is what economists have termed "the division of

labor," but that is in reality also a union and graduation of labor towards productive ends, and has its counterpart in the multifarious divisions of capital in its application to the maintenance and extension of industry.

Co-operation, as technically understood, occupies a middle position between the doctrines of the communists and socialists (see COMMUNISM) on the one hand, and the private property and freedom of individual labor and enterprise on the other. It takes its departure from communism at a very definite and significant point. While the latter would extinguish the motive of individual gain and possession in the sentiment of a universal happiness or good, and remodel all the existing rights, laws, and arrangements of society on a basis deemed consonant to this end, co-operation seeks, in consistency with the fundamental institutes of society as hitherto developed, to ameliorate the social condition by a concurrence of increasing numbers of associates in a common interest.

The co-operative societies, springing from this idea, though attended with the most varied fortune, have greatly increased in number and in amount of business in recent years. The form, particular objects, and organic rules of these associations are by no means uniform. But, as we find them in the principal countries of Europe, they may be divided into three general classes:—1. Societies of consumption, the object of which is to buy and sell to members alone, or to members and non-members under differing conditions, the necessities of life or the raw materials of their industry; 2. Societies of production, the object of which is to sell the collective or individual work of the members; 3. Societies of credit or banking, the object of which is to open accounts of credit with their members, and advance them loans for industrial purposes. There are numerous modifications of the principle, such as friendly societies, burial societies, societies of workmen which undertake the execution of work by contract, arrangements of private firms by which the workmen share in the profits of the employers, and building societies, now rife in most large towns, the object of which is to enable members to become owners of dwelling houses. But the above three categories define the distinguishing characteristics of the co-operative society proper; and it is somewhat remarkable that the three kinds of association have attained marked success in three different European countries. England stands at the head in societies of consumption; France, in societies of production; Germany, in societies of credit. With reference to this variety of result it may be observed that the social equality resulting from the great Revolution, in connection with the character of much of the manufacturing industry of France, has given that country a larger number of artisans who work in their own houses, and have a passion for independence in their handicraft, than is to be found in any other country. On the other hand, the masses of operatives in the factories and other great works of England, while retaining their position as wage-earners, have put forth most energy and attained their highest co-operative success in societies for the purchase, and in some degree the production, of their own immediate necessities of life. The less abundant capital, and the want of banks and other institutions of credit in the smaller towns and remoter parts of Germany, may explain in some measure the notable development of societies of credit in that country. But no account of the phenomena in Germany would be satisfactory without placing at the head of influences the personal agency of one man—M. Schulze, of Delitzsch (a town of only 6000 inhabitants)—who had the sagacity to perceive that societies of credit were the necessary foundation of the co-operative system, and who reasoned out principles, planned, and labored with a skill, disinterestedness, and perseverance, which have crowned his idea with remarkable success.

The Credit Society of M. Schulze is practically a bank, but a bank organized on principles specially adapted to the working classes within certain limits of transaction, to which it is strictly confined. The members of the society must be men of "self-help," able to work and in regular employment, and they must hold each one equal share of the stock-capital of the society, which may be paid up in full, or by regular instalment. Dividends are only paid to the members who have paid in full, the profits due on the partly-paid shares being added to these till they reach their full amount. It follows from the principle of the society—

"in proportion to the chance of gain the risk of loss"—that when the share-capital has to be called upon to liquidate the debts, it is the capital actually paid in that loses. Equality of shares and equality of advantages and risks are thus attained. But in addition to the share-capital there is a reserve fund formed out of entrance fees and a percentage of the net profits. The order of liability for deficits in the balance sheets is thus (1) reserve fund, (2) paid-in capital, and (3) private property of the members—the final principle being that of unlimited liability. Every member is responsible for the debts of the society, and the society for the debts of every member. It is obvious that a company thus constituted, and composed of the most saving and industrious workmen of a town or district, offers a solid security, and consequently the share-capital is supplemented by loans for given periods of time, debentures, and savings deposits, the last having to be guarded by conditions as to notice of withdrawal. At the beginning of a society the paid-up share-capital may not be more than the proportion of 10 to 90 of borrowed funds, but it has to be brought up as rapidly as possible to 25 per cent., and should reach a maximum of 50 per cent. The share-capital, as originally fixed, has also to be increased as the business, and the amount of funds necessary for its transaction, increase; so that the amount of each share has thus to be supplemented *plus* the increase of business *minus* the increase of members. By these means the society is protected from too small a share-capital for its liabilities, and from the temptation of appropriating large dividends out of the surplus profit, accruing from borrowed funds. Another peculiarity of the German "credit union" is that it makes advances of the funds of which it is possessed to its own members only. The two great ends to be secured being the minimum of risk and the maximum of responsibility, the first is promoted by advancing money only for industrial purposes, within due limits, among borrowers whose requirements and circumstances are or may be thoroughly known to the society, and the second by the fact that every member of the society is unlimitedly liable for any errors or losses that may arise in the administration. The advances are made in the usual forms of promissory notes with the indorsement of sureties, ordinary bills of exchange, and occasionally mortgages over real property in current accounts. Advances are not made for longer periods than the society can itself borrow; partial repayment at dates is sometimes conditioned within the period of advance; and the interest charged follows the public money-market rate. It is thus that M. Schulze, through a series of skilful regulations beyond our space to follow, solved the problem, which vexed and puzzled the socialists of a past generation, of bringing capital direct to the workman or "immediate producer."

When the little "credit union" of Delitzsch was fully organized in 1852, popular opinion was so well prepared and enlightened on the subject by M. Schulze's efforts in the Prussian Parliament and on the platform, that similar societies were rapidly organized in other parts of the country. While each society had full powers of self-regulation, they were all much on the Delitzsch model, and a general affiliation was brought about for mutual counsel and encouragement. M. Schulze then applied in the legislature for corporate rights and legal status to the associations, and after tedious labors obtained them. In 1865 he established a central credit bank at Berlin, by which the societies, while depending mainly on local credit supplies, might have access, in case of need, to the general loan market. The "credit unions," though now numerous, are only a section of the co-operative movement in Germany. The law of the Prussian Parliament granting corporate rights to loan and credit associations extends the same privileges to "raw material and store unions," "unions for the production and sale of finished wares on a common account," "unions for the purchase of the necessities of life wholesale and the selling of them retail," and "unions for providing their members with dwelling-houses."

The history of the co-operative movement in France is much too extensive to be traced here. But it may be observed that the French co-operators have discovered, at various periods, a strong leaning to the opinion that, while they supply the labor, the state is under obligation to supply in whole or in part the capital and other means of labor; and under this idea co-operation merges very nearly

into communism. *L'état! c'est moi,*" said Louis XIV., and in the days of democracy the same idea not unnaturally suggests itself to an overwhelming majority of the people. This was precisely the argument which the late M. Lasalle, following the French socialists, used against Schulze and the economists in Germany. "Society," he in effect argued, "consists of 96 *prolétaires* and 4 capitalists. There is the state! The *prolétaires* have no capital, can save nothing, have nothing to save from. But the state, of which they are 96 out of 100, can come forward, cover the *prolétaires* with its credit, and give a new departure to the production and distribution of wealth. Capital in its personal accumulation is merely the spawn of ages of slavery, craft, and plunder." The discussion of this question had been exhausted in France more than once. Bastiat and Proudhon had quite recently fought it out between them. But there were also practical experiments and illustrations. On the revolution of February, 1848, the French state recognized to some extent its duty to the *prolétaires*, organized national workshops, and voted 8,000,000 francs for the use of fifty-six co-operative societies. Three-fourths of these societies perished after a brief period. The state lost its money, and the members did themselves no good. Only a remnant, by organizing themselves on sounder principles, survived. The "*Société des Tourners en Chaises,*" which refused assistance from the state, and declined the principle of equality of wages, is flourishing to this day. The Society of *Maçons, of Piano Makers, of "Ouvriers Lunettiers,"* and others, have established a strong position, beginning with small capital, and increasing it to large amounts. In Lyons there are the "*Société des Tisseurs,*" of 1800 members, and others; at St. Étienne the "*Association des Rubanniers,*" of 1200 members, said to have half a million sterling of capital. The "society of production," of which there are at least forty examples in Paris alone, is found in nearly all the French provinces, and has proved the capacity of workmen by union to carve out business for themselves and be their own masters, while, in many cases, employing other workmen or auxiliaries at wages, who have no share in the profits. There are also in France more examples, probably, than in any other country, of workmen sharing in the profits of the firms by which they are employed, under arrangements offered and regulated by the employers or capitalists themselves.

Of the "society of consumption" there are innumerable examples in the United Kingdom, the chief being the Rochdale, Leeds, and Halifax societies, embracing nearly the whole working population of a large manufacturing district, and carrying out their operations, from the wholesale and retail stores to dairies, flour-mills, and other auxiliary branches, including libraries and newsrooms. The supply associations in London organized by members of the Government civil service have also attained much importance; but, as these trade with the public, and divide large profits among privileged holders of shares, it has been questioned whether they can be properly regarded as co-operative societies. Nearly every town of the kingdom has a "co-operative store;" and when these are numerous in a district they usually affiliate, and open a common wholesale department in Liverpool, Glasgow, or some other emporium. The advantages in many cases may not be great, and after a brief existence the societies not unfrequently wind up. But when properly conducted and supported, they secure wholesome commodities, encourage among their members ready-money payments, and as the goods are sold at a fair margin of profit, there is every quarter or half year a dividend at the rate of 5 to 10 or more per cent. to the members on their share-capital, and a bonus to non-members on the amount of their purchases. One of the indirect advantages of the co-operative store, when established in a community, is its influence as a formidable rival on private grocers and dealers.

The most signal instances of failure of the co-operative principle in the United Kingdom have occurred in the sphere of "production," where France has given many successful examples. The united coal-miners of South Yorkshire purchased the Shirland Collieries in 1874 at a price of £70,000, of which they paid down £31,000, raising the remainder of the purchase-money in debenture bonds. The working and proprietary company thus formed has never been able to pay the interest due on its bonds, and the collieries have now passed into other hands for £11,000 with the liabilities attaching to them, and the whole cap-

ital of the workmen has been lost. The purchase of collieries at a period when the coal trade and wages of mining labor were in a state of inflation, followed sharply by successive collapses, may account for this unfortunate result. The engineering factory at Ouseburn, bought up and worked for a time by operatives, is again, after a stoppage, re-established on a co-operative basis. But the failure of co-operative production has been recently illustrated in another form. In 1865 Messrs. Briggs & Co., proprietors of the Whitwood and Methley Junction Collieries, entered into a permanent contract with their workmen, whereby the latter were to receive, in addition to the current rate of wages, one-half of the profits above 10 per cent. for the redemption of capital invested. As long as there were profits, and the rate of wages presented no difficulty, this answered well enough; but when the tide turned, and there were no profits, but only loss unless wages were reduced, the situation was wholly altered in the estimate of the workmen, and the compact was broken up in 1874 on the demand of the men themselves, who said they would prefer to be simply members of the "Miners' Union."

The numerous cotton factories in Lancashire, on a basis of small joint-stock shares, yielding in some cases large dividends, might almost be considered as great an example of co-operative production as any effort of the kind in France. The operatives have a large stake and much advantage in those factories; but since the spinner or weaver does not necessarily work in the factory of which he has a small proprietary share, these joint-stock establishments are probably to be regarded more as investments of the savings of the operatives than as co-operative societies. The co-operative idea, as would probably be held by its most staunch propounders, requires identity of purpose and interest, with community of advantages and risks, though not necessarily absolute equality or uniformity of individual relations, among the co-operators. When the association passes into a mere investment and trading company, the idea would seem to be lost.

The co-operative system in the United Kingdom has attained such magnitude as well as variety of development that our literature on the subject cannot be deemed so complete as would be desirable. Mr. G. J. Holyoake, than whom probably no one in England has more command of the subject, is engaged on a *History of Co-operation*, the first volume of which has been published. Valuable information on co-operative societies occurs in official documents; see, for example, the appendix of the *Eleventh and Final Report of Royal Commission on Trade Unions*, 1869. (2. 80.)

COORG, a province of Southern India, near the centre of the Western Ghats, between 11° 56' and 12° 45' N. lat. and 75° 25' and 76° 13' E. long., is bounded by Mysore, Malabar, and South Kanara, and has an area of 2000 square miles. It is a mountainous district, presenting throughout a series of wooded hills and deep valleys; the lowest elevations are 3000 feet above sea-level. The loftiest peak, Tandiamamol, has an altitude of 5781 feet; Pushpagiri, another peak, is 5682 feet high. The principal river is the Cauvery, or Kaveri, which rises on the eastern side of the Western Ghats, and with its tributaries drains the greater part of Coorg. Besides these there are several large streams that take their rise in Coorg. In the rainy season, which lasts during the continuance of the south-west monsoon, or from June to the end of September, the rivers flow with violence and great rapidity. In July and August the rainfall is excessive, and the month of November is often showery. The yearly rainfall may exceed 160 inches; in the dense jungle tract it reaches from 120 to 150; in the bamboo district from 60 to 100 inches. The climate, though humid, is on the whole healthy; it is believed to have been rendered hotter and drier of late years by the clearing of forest land. Coorg has an average temperature of about 60° Fahr., the extremes being 52° and 82°. The hottest season is in April and May. In the direction of Mysore the whole country is thickly wooded; but to the westward the forests are more open. The flora of the jungle includes *Michelia* (Chumpak), *Mesua* (Iron-wood), *Diospyros* (Ebony and other species), *Cedrela Toona* (White cedar), *Chickrassia tubularis* (Red cedar), *Calophyllum angustifolium* (Poon spar), *Camarium strictum* (Black Dammar tree), *Artocarpus*, *Dipterocarpus*, *Garcinia*, *Euonymus*, *Cinnamomum iners*, *Myrtica Vaccinium*, *Myrtaceae*, *Melastomaceae*, *Rubus* (three species) and a rose. In the undergrowth are found cardamom, areca

plantain, cane, wild pepper, tree and other ferns, and arums. In the forest of the less thickly-wooded bamboo country in the west of Coorg the trees most common are the *Dalbergia latifolia* (Black wood), *Pterocarpus Marsupium* (Kino tree), *Terminalia coriacea* (Mutti), *Lagerstrœmia parviflora* (Bentack), *Conocarpus latifolius* (Dindul), *Bassia latifolia*, *Butea frondosa*, *Nauclaea parviflora*, and several acacias, with which, in the eastern part of the district, teak and sandalwood occur. Among the fauna may be mentioned the elephant, tiger, tiger-cat, cheetah or hunting leopard, wild dog, elk, bison, wild boar, several species of deer, hares, monkeys, the buceros and various other birds, the cobra di capello, and a few alligators. The most interesting antiquities of Coorg are the earth redoubts (*kumsidags*), which are from 15 to 25 feet high, and provided with a ditch 10 feet deep by 8 or 10 feet wide. Their linear extent is reckoned at between 500 and 600 miles. The exports of Coorg are mainly rice, coffee, and cardamoms; and the only important manufacture is a kind of coarse blanket. Fruits of many descriptions, especially oranges, are produced in abundance, and are of excellent quality. The Coorgs, of whom the Kodagas are the chief tribe, constitute thirteen castes. They are of Dravidian origin, and retain the devil-worship of their ancestors; they speak a dialect of Canarese. They are a well-formed, bold and active, but ignorant and superstitious race. The strange institution of polyandry prevalent among them, according to which the wives of the brothers of a family are common property, appears to have arisen from the necessity of counteracting the exterminating influence of wars by making the brothers of the slain the rightful husbands of their widows. The principal towns of Coorg are Merkara, the capital, Fraserpett, Somwarpett, Periapattam, and Verajenderpetta. In 1872 Coorg contained 510 villages, and its population numbered 168,312.

Previous to its annexation to British India, Coorg was governed by a line of rajahs of the Nair caste of Hindus, mentioned in history as early as the year 1583. The ascendancy of the last family of these rulers dates from the year 1632. Its princes retained their independence till the year 1773, when Hyder Ali, who had long sought the subjugation of the country, took advantage of a dispute about the succession to seize upon the sovereignty, and imprisoned the rajah. The latter subsequently effected his escape from captivity, and drove the armies of Tippoo Sultan out of Coorg; and in the war against Tippoo in the year 1791 he proved a useful auxiliary to the British. On the defeat of Tippoo a treaty was entered into between the East India Company and Viraraja of Coorg, who dying in 1807, left the throne to his daughter Devammaji. Lingaraja, her uncle, who now usurped the throne, was succeeded in 1820 by his son, Viraraja. This monarch's misgovernment and oppression of Coorg brought upon him at length the armed interference of Lord William Bentinck; in April, 1834, he was deposed by General Fraser, and his dominions were annexed to British Territory. Since then the revenue has improved, cultivation has been extended, and the general prosperity of the country has steadily increased.

COOT, a well-known British water-fowl, the *Fulica atra* of Linneus, belonging to the family *Rallidae* or Rails. The word Coot, in some parts of England pronounced Cute, or Scute, is of uncertain origin, but perhaps cognate with Scout and Scoter—both names of aquatic birds—a possibility which seems to be more likely since the name "Macreus," by which the Coot is known in the south of France, being in the north of that country applied to the Scoter (*Aedemia nigra*), shows that, though belonging to very different families, there is in popular estimation some connection between the two birds.<sup>1</sup> The Latin *Fulica* (in polite French, *Foulique*) is probably allied to *fuligo*, and has reference to the bird's dark color.<sup>2</sup> The Coot breeds abundantly in many of the larger inland waters of the northern parts of the Old World, in winter commonly resorting, and often in great numbers, to the mouth of rivers or shallow bays of the sea, where it becomes a general object of pursuit by gunners whether for sport or gain. At other times of the year it is comparatively unmolested, and being very prolific its abundance is easily understood. The nest is a large mass of flags, reeds, or sedge, piled together among rushes in the water or on the margin, and not unfrequently contains as many as ten eggs.

<sup>1</sup> It is owing to this interchange of their names that Yarrell in his *British Birds* refers M. Victor Hugo's description of the "chasse aux Macreuses" to the Scoter instead of the Coot.

<sup>2</sup> Hence also we have *Fulix* or *Fulgula* applied to a Duck of dingy appearance, and thus forming another parallel case.

The young, when first hatched, are beautiful little creatures, clothed in jet-black down, with their heads of a bright orange-scarlet, varied with purplish-blue. This brilliant coloring is soon lost, and they begin to assume the almost uniform sooty-black plumage which is worn for the rest of their life; but a characteristic of the adult is a bare patch or callosity on the forehead, which being nearly white gives rise to the epithet "bald" often prefixed to the bird's name. The Coot is about 18 inches in length, and will sometimes weigh over 2 lb. Though its wings appear to be short in proportion to its size, and it seems to rise with difficulty from the water, it is capable of long-sustained and rather rapid flight, which is performed with the legs stretched out behind the stumpy tail. It swims buoyantly, and looks a much larger bird in the water than it really is. It dives with ease, and when wounded is said frequently to clutch the weeds at the bottom with a grasp so firm as not even to be loosened by death. It does not often come on dry land, but when there, marches leisurely and not without a certain degree of grace. The feet of the Coot are very remarkable, the toes being fringed by a lobed membrane, which must be of considerable assistance in swimming as well as in walking over the ooze—acting as they do like mud-boards.

In England the sport of Coot-shooting is pursued to some extent on the broads and back-waters of the eastern counties—in Southampton Water, Christchurch Bay, and at Slapton Lay—and is often conducted battue-fashion by a number of guns. But even in these cases the numbers killed in a day seldom reach more than a few hundreds, and come very short of those that fall in the officially-organized *chasses* of the lakes near the coast of Languedoc and Provence, of which an excellent description is given by the Vicomte Louis de Dax.<sup>3</sup> The flesh of the Coot is very variously regarded as food. To prepare the bird for the table, the feathers should be stripped, and the down, which is very close, thick, and hard to pluck, be rubbed with powdered resin; the body is then to be dipped in boiling water, which, dissolving the resin, causes it to mix with the down, and then both can be removed together with tolerable ease. After this the bird should be left to soak for the night in cold spring-water, which will make it look as white and delicate as a chicken. Without this process the skin after roasting is found to be very oily, with a fishy flavor, and if the skin be taken off, the flesh becomes dry and good for nothing (Hawker's *Instructions to Young Sportsmen*; Hele's *Notes about Aldbrough*).

The Coot is found throughout the Palearctic Region from Iceland to Japan, and in most other parts of the world is represented by nearly allied species, having almost the same habits. An African species (*F. cristata*), easily distinguished by a red caruncle on its forehead, is of rare appearance in the south of Europe. The Australian and North American species (*F. Australis* and *F. Americana*) have very great resemblance to our own bird; but in South America half a dozen or more additional species are found which range to Patagonia, and vary much in size, one (*F. gigantea*) being of considerable magnitude. The remains of a very large species (*F. newtoni*) have been discovered in Mauritius, where it must have been a contemporary of the Dodo, but like that bird is now extinct. (A. N.)

COOTE, SIR EYRE (1726–1783), a celebrated general, born at Limerick in 1726, was the son of a clergyman. He served against the Pretender in 1745, and in 1754 sailed for India to join the army of Clive. In 1760, having attained the rank of colonel for his services at Plassy and Calcutta, he was sent to the Carnatic, where he took Wandewash and defeated Lally. For these exploits he received on his return to England a jewelled sword from the East India Company, and a vote of thanks from the House of Commons. In 1769 he was appointed to the chief command in Madras; but in the next year, having quarrelled with the governor, he returned to England. He was made Knight of the Bath, colonel of the 7th Foot, and governor of Fort St. George. In 1780 he returned to Calcutta as commander-in-chief in Bengal and member of the supreme council. Soon after he was sent by Warren Hastings into the Carnatic, where Hyder Ali was seriously threatening the British possessions; and on the 1st July, 1781, he won a decided victory at Ponto Novo, which

<sup>3</sup> "La Volée aux Macreuses." *Nouveaux Souvenirs de Chasse et de Pêche dans le midi de la France*, pp. 53–65 (Paris: 1860).

checked the advance of his antagonist. But there was a serious deficiency of supplies, and in the next year Coote returned to Calcutta. Notwithstanding his feeble health, he again set sail in the spring of 1783 for Madras. His ship was pursued by the French, and this annoyance, acting upon his broken constitution and now extremely irritable temper, brought on a third fit of apoplexy, causing his death on the 28th April, 1783. A monument was erected to his memory in Westminster Abbey.

A very flattering account of Coote is given by Wilks in his *Historical Sketches of Mysore*, 1810; see also Mill's *British India*.

COPAIBA. See BALSAM, vol. iii. p. 253.

COPAL, a hard lustrous resin, varying in hue from an almost colorless transparent mass to a bright yellowish brown, having a conchoidal fracture, and, when dissolved in alcohol, spirit of turpentine, or any other suitable menstruum, forming one of the most valuable varnishes. Like many other commercial substances, copal is obtained from a variety of sources; the term is not uniformly applied or restricted to the products of any particular region or series of plants, but is vaguely used for resins which, though very similar in their physical properties, differ somewhat in their constitution, and are altogether distinct as to their source. Thus the resin obtained from *Trachylobium Hornemannianum* is known in commerce as Zanzibar copal, or gum animé. Madagascar copal is the produce of *T. verrucosum*. From *Gnibourtia copalifera* is obtained Sierra Leone copal, and another variety of the same resin is found in a fossil state on the west coast of Africa, probably the produce of a tree now extinct. From Brazil and other South American countries, again, copal is obtained which is yielded by *Trachylobium Martianum*, *Hymenoclea Courbaril*, and various other species, while the dammar resins and the piney varnish of India are occasionally classed and spoken of as copal. Of the varieties above enumerated by far the most important in a commercial point of view is the Zanzibar or East African copal, yielded by *Trachylobium Hornemannianum*. The resin is found in two distinct conditions:—1st, raw or recent, called by the inhabitants of the coast sandarusisa miti or chakazi, the latter name being corrupted by Zanzibar traders into "jackass" copal; and 2d, ripe or true copal, the sandarusi inti of the natives. The raw copal, which is obtained direct from the trees, or found at their roots or near the surface of the ground, is not regarded by the natives as of much value, and does not enter into European commerce. It is sent to India and China, where it is manufactured into a coarse kind of varnish. The true or fossil copal is found embedded in the earth over a wide belt of the mainland coast of Zanzibar, on tracts where not a single tree is now visible. The copal is not found at a greater depth in the ground than 4 feet, and it is seldom the diggers go deeper than about 3 feet. It occurs in pieces varying from the size of small pebbles up to masses of several ounces in weight, and occasionally lumps weighing 4 or 5 lb have been obtained; and it is said that one piece of 35 lb weight has been found. After garbling and freeing from foreign matter, the resin is submitted to various chemical operations for the purposes of clearing the "goose-skin," the name given to the peculiar pitted-like surface possessed by fossil copal. The goose-skin was formerly supposed to be caused by the impression of the small stones and sand of the soil into which the soft resin fell in its raw condition; but Dr. Kirk states that the copal when first dug up has no trace of the goose-skin on it. He believes the appearance to arise from an oxidation of the surface taking place to a certain depth after exposure to the air, or to be caused by some molecular change which renders the skin more brittle than the inner mass. The copal digging is conducted by the natives in a careless and desultory manner, and the whole trade is, as usual in dealings with untutored tribes, surrounded with many difficulties. It is believed that the supply is practically inexhaustible, and with proper organization the trade would be a permanent source of support to a larger community than at present inhabits the copal-yielding regions. A large proportion of the resin is sent to the European market by way of Bombay; but considerable quantities are also shipped direct to Hamburg and to British ports. The amount annually exported is subject to great fluctuations, which equally affect the market value of the product. During the year 1872-73 the

imports into Bombay were 966 cwts., and probably at least an equal quantity went in other directions. The following analysis of Zanzibar and Madagascar copal is given by Filhol:—

	Zanzibar.	Madagascar.
Carbon.....	79.70	79.80
Hydrogen.....	10.40	9.42
Oxygen.....	9.90	10.78

COPAN, a village of Central America, in the republic of Honduras, famous for the remarkable ruins in its neighborhood. It is situated not far from the frontier of Guatemala, on the right bank of the Rio Copan, a tributary of the Motagua, about thirty miles east of Chiquimula, in 14° 45' N. lat. and 90° 52' W. long. The ruins occupy a rectangular area of about 1600 feet in length and 900 feet in breadth, and the outer walls appear to be about 25 feet thick at the bottom. The principal building is an immense terrace with a perpendicular front towards the river, extending a distance of 624 feet, and attaining a height of about 70 feet above the soil. It has been calculated that this single structure must have required upwards of 26,000,000 cubic feet of stone. Numerous obelisks and statues are still standing, covered in bewildering profusion with grotesque sculpturings, which in many cases can only have been ornamental, but in others belong pretty evidently to some hieroglyphical system of symbols. The presence of what appear to be altars in front of several of the figures gives reason to suppose that they were worshipped as deities. That these erections were the work of a people of considerable artistic and engineering skill is abundantly evident; but not the slightest datum is afforded by tradition for any conjecture in regard to their origin. An identification at one time attempted with the city which offered so brave a resistance to Hernando de Chaves in 1530 is now considered as unsatisfactory. The ruins unfortunately are exposed not only to the destructive influences of nature, but also to the attacks of an ignorant populace; and according to Dr. Bernouilli, who visited the spot in 1870, the dangers from the latter source are rapidly increasing as the little hamlet, which now contains a church and a cabildo, has become the centre of the surrounding district.

A very complete résumé of the various descriptions of Copan will be found in Baneroff's *Native Races of the Pacific States of North America*, vol. iv., 1875, his most important authorities being Palacios's *Carta dirigida al rey* (a 16th century account, published at Albany in 1860); the report of Col. Juan Galindo in 1635; Stephens, *Incidents of Travel in Central America*, 1841; Catherwood, *Views of Ancient Monuments in Central America*, 1844. Among those who have visited the ruins in more recent years are M. César Daly, Abbé Brasseur de Bourbourg, Mr. Harcourt, and Mr. Ellerly.

COPENHAGEN (Danish, *Kjøbenhavn*; Latin, *Hafnia* or *Havnia*), the capital of Denmark, is situated at the southern extremity of the Sound, at that part about 20 miles broad, 180 miles north-east of Hamburg, in 56° 40' 52" N. lat. and 12° 35' 46" E. long. The main portion of the city is built on low-lying ground on the east coast of the island of Seeland between the sea and a series of freshwater lakes, known respectively as St. Jørgens Sø, Pebling Sø, and Sortedams Sø; a southern and smaller portion, distinguished as Christianshavn, occupies the northern part of the island of Amager or Amak. An excellent harbor is furnished by the natural channel between the two islands; and communication from one division to the other is afforded by two bridges—the Langebro and the Knippelsbro, the latter of which, an iron structure erected in 1868, has replaced the wooden drawbridge built by Christian IV. in 1620. The older city, including both the Seeland and Amager portions, was formerly surrounded by a complete line of ramparts and moats; but since 1863 these defenses are being gradually demolished and filled up, to make way for new streets and squares. Towards the sea the city will be still protected by the citadel of Frederikshavn and several minor forts. Outside of the line of the ramparts, which had a circuit of about five miles, there have sprung up several extensive suburbs,—Oesterbro, Nørrebro, and Vesterbro (East Bridge, North Bridge, and West Bridge) in the Seeland portion, and Amagerbro to the south of Christianshavn; and with these suburbs the city occupies an area of 3200 acres. In the intramural city there are numerous public squares of considerable extent:—Amalienborg Place, or Frederick's Place, a handsome octagon formed by four palaces of uniform size and design, and



having in the centre an equestrian statue of Frederick V., erected in 1768 at the cost of the former Asiatic Company; Kongens Nytorv (the king's new market, formerly called Hollandsaa), an irregular square, the largest in the city, with an equestrian statue of Christian V. in the centre, remarkable only for its size; the Gammeltoiv and Nytorv (old and new markets), forming one oblong area; and the Slotplads, on which stand the Christiansborg Palace, the chapel royal, the exchange, and the chancery buildings. A long street called Gothers Gade divides the Seeland portion of the intramural city into two nearly equal halves.

**Public Buildings.**—The citadel already mentioned is a regular polygon with five bastions, and is connected with the city by an esplanade. It was founded by Frederick III. about 1662–63, and has become associated as a state prison with the names of Griffenfeld, Struensee, and Brandt.

The royal palace of Christiansborg, originally built by Christian VI., but afterwards destroyed by fire in 1794, has since been rebuilt on an extensive scale. It occupies the site of the old castle of Bishop Absolon, which was restored at great expense by Frederick IV., and is famous in history for its Blaataarn, or Blue Tower, long used as a state prison. Over the principal entrance are two bas-reliefs by Thorwaldsen, representing Minerva and Prometheus, Hercules and Hebe, Jupiter and Nemesis, and Æsculapius and Hygeia. The Riddersal (knights' hall) is a magnificent apartment, 120 feet long, 44 feet high, and 50 feet wide, with a gallery supported by Corinthian columns. In the great entrance hall is the Triumphal March of Alexander into Babylon by Thorwaldsen. In the upper part of the building is the Royal Gallery of Paintings, enriched by many valuable specimens of the Flemish, Dutch, and Italian schools. The palace also contains the council chamber and the apartments in which both Houses of the Parliament hold their sittings. The large exterior court on the west side forms a riding ground, and is inclosed on both sides by regular outbuildings with piazzas, containing the court, theatre, stables, and riding-house. In connection with the palace is the royal library, with about 550,000 volumes and 30,000 manuscripts; and the chapel, adorned with works by Thorwaldsen and Bissen.

The palace of Rosenborg, supposed to have been planned by Inigo Jones, was erected in 1604. It is an irregular building in the Gothic style, with a high pointed roof, and flanked by four towers of unequal dimensions. It contains the coin and medal cabinet, a fine collection of Venetian glass, the famous silver drinking-horn of Oldenburg, the regalia, and other objects of interest as illustrating the history of Denmark. The Riddersal, a spacious room, is covered with tapestry representing the various battles of Christian V., and has at one end a massive silver throne. The gardens, formerly much more extensive, are open to the public, and afford an agreeable promenade.

The palace of Charlottenborg, on the Kongens Nytorv, which takes its name from Charlotte, the wife of Christian V., is a huge desolate-looking building, built in 1672. Frederick V. made a grant of it to the Academy of Arts, which holds its annual exhibition of paintings and sculpture within its walls, in April and May.

The four palaces on the Amalienborg were built for the residence of four noble families; but on the destruction of Christiansborg in 1794 they became the residence of the king and court, and so continued till the death of Christian VIII. in 1848. At present (1877) one of the four is inhabited by the king, the second by the crown prince, and the third by the queen-dowager, while the fourth is occupied by the foreign office and the principal court of justice or *Højeste Ret*.

Prindsens Palais to the west of Christiansborg, once the residence of Christian V. and Frederick VI. when crown prince, now contains the Royal Museum of Art, the Ethnographical Museum, and the Royal Museum of Northern Antiquities. The last named was founded in 1807, and under the management of Mr. Worsaae has become the richest collection of Scandinavian antiquities in the world. The chancery buildings, immediately adjoining the Christiansborg, and united to it by a corridor, consist of a large main building erected by Frederick IV., and of three others since added. Here are deposited the privy archives of the state and of the royal family. The town-hall and court-

house, in the Slotsholm or Castle Island (built 1805–15), contains the municipal council chamber, the police and criminal courts, and other public offices. The exchange, also on the Castle Island, is surmounted by a remarkable spire, formed of four dragons, with their heads directed to the four points of the compass, and their bodies entwining each other till their tails come to a point at the top.

The Thorwaldsen Museum, built 1837–46 in a combination of the Egyptian and Etruscan styles, is 230 feet in length, 125 feet in breadth, and 46 feet high, and consists of two stories. In the centre is an open court, 116 feet long and 50 feet broad, containing the artist's tomb. The exterior walls are decorated with groups of figures of colored stucco, illustrative of events connected with the formation of the museum. Over the principal entrance is the Chariot of Victory drawn by four Horses, executed in bronze from a model by Bissen. The front hall, corridors, and apartments are painted in the Pompeian style, with brilliant colors and with great artistic skill. The museum contains about 300 of Thorwaldsen's works; and in one apartment is his sitting-room furniture arranged as it was found at the time of his death in 1844.

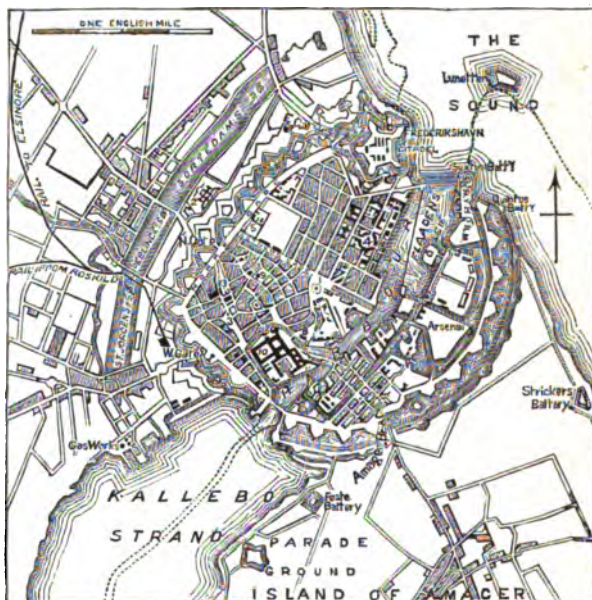

Plan of Copenhagen.

- |                            |                                     |
|----------------------------|-------------------------------------|
| 1. Kongens Nytorv.         | 8. Holmens Kirke.                   |
| 2. Communal Hospital.      | 9. Trinity Church.                  |
| 3. Gammel-og-Nytorv.       | 10. Royal Castle of Christiansborg. |
| 4. Frederick's Place.      | 11. Ministerium.                    |
| 5. Rosenborg Palace.       | 12. Thorwaldsen Museum.             |
| 6. Church of St. Peter.    | 13. University.                     |
| 7. Cathedral (Frue Kirke). | 14. Theatre.                        |

**Educational Buildings.**—At the head of the educational institutions is the university, which, with its library and zoological museum, occupies a series of buildings forming a large quadrangle next Frue Kirke. It was founded by Christian I. in 1479; but its present constitution dates from 1788. There are five faculties,—a theological, juridical, medical, philosophical, and mathematical—with thirty-four professors; and the average number of students is about 1000. In 1851 an English, and in 1852 an Anglo-Saxon, lectureship was established. All the professors are bound to give a series of lectures open to the public free of charge. The university possesses considerable endowments and has several foundations for the assistance of poor students; the "regent's charity," for instance, founded by Christian, affords free residence and a small allowance to 100 bursars. In connection with the university are the observatory, the chemical laboratory in Ny Vester Gade, the surgical academy in Bred Gade, founded in 1786, and the botanic garden. The university library, formerly lodged in Trinity Church, but now in a special building erected in 1863, has been incorporated with the former Classen Library, collected by the famous merchants of that

name, and now contains about 200,000 volumes, besides about 4000 manuscripts, which include Rask's valuable Oriental collection and the Arne-Magnean series of Scandinavian documents. It shares with the royal library, which has 550,000 volumes and 30,000 MSS., the right of receiving a copy of every book published in Denmark. Among the other educational institutions may be mentioned the polytechnic school, founded in 1829; the veterinary and agricultural college, established by Abildgaard in 1778, and adopted by the state in 1778; the military academy, and the school of navigation.

Among the literary and scientific associations may be mentioned the Danish Royal Society, founded in 1742, for the advancement of the sciences of mathematics, astronomy, natural philosophy, &c., by the publication of papers and essays; the Royal Antiquarian Society, founded in 1825, for diffusing a knowledge of Northern and Icelandic archaeology, and stimulated by the efforts of such men as Thomsen, Raape, Finn Magnussen, and Petersen; the Society for the Promotion of Danish Literature, for the publication of works chiefly connected with the history of Danish literature; the Natural Philosophy Society; the Royal Agricultural Society; the Danish Church History Society; the Industrial Association, founded in 1838, the Royal Geographical Society, established in 1876; and several musical and other societies. The Academy of Arts was founded by Frederick V. in 1754, for the instruction of artists, and for disseminating a taste for the fine arts among manufacturers and operatives. Attached to it are schools for the study of architecture, ornamental drawing, and modelling. An Art Union was founded in 1826, and a musical conservatorium in 1870, under the direction of the composers Gade and Hartman.

**Churches.**—The principal church or cathedral, the Frue Kirke (Church of our Lady), was almost entirely destroyed in the bombardment of 1807, but was completely restored in 1811-29. The works of Thorwaldsen, by which it is adorned, constitute its chief attraction. In the pediment is a group in *terra cotta* of sixteen figures, representing John the Baptist preaching in the wilderness; over the entrance within the portico is a bas-relief of Christ's entrance into Jerusalem; on one side of the entrance is a statue of Moses by Bissen, and on the other a statue of David by Jerichan. In a niche behind the altar stands a colossal marble statue of our Saviour, and marble statues of the twelve apostles adorn both sides of the church. Nearly opposite the Frue Kirke is St. Peter's Church, built in a quasi-Gothic style, with a spire 260 feet high, and appropriated since 1585 as a parish church for the German residents in Copenhagen. The round tower of Trinity Church is 115 feet high, and is considered to be unique in Europe. It was constructed from a plan of Tycho Brahe's favorite disciple Longomontanus, and was formerly used as an observatory. It is ascended by a broad inclined spiral way, up which Peter the Great is said to have driven in a carriage and four. The Church of our Saviour in Christianshavn, dedicated in 1696, has a curious steeple 300 feet high, ascended by an external spiral staircase. The lower part of the altar is composed of Italian marble, with a representation of Christ's suffering in the garden of Gethsemane; and the organ is considered the finest in Copenhagen. The Marble Church, intended to have been an edifice of great extent and magnificence, was commenced in the reign of Frederick V., but after twenty years was left unfinished. The Holmens Kirke, or church for the royal navy, originally erected as an anchor-smithy by Frederick II., but consecrated by Christian IV., is remarkable for a chapel containing the tombs of the great admirals Niels Juel and Tordenskjold. The churches above mentioned belong to the national Lutheran Church; the most important of those belonging to other denominations are the Reformed church, founded in 1688, and rebuilt in 1731, the Catholic church of St. Ansgarius, consecrated in 1842, and the Jewish synagogue in Krystalgade, which dates from 1853.

Of the monastic buildings of mediæval Copenhagen various traces are preserved in the present nomenclature of the streets. The Franciscan establishment gives its name to the Graabrødretorv or Grey Friar's market; and St. Clara's Monastery, the largest of all, which was founded by Queen Christina, is still commemorated by the Klareboder or Clara buildings, near the present post-office. The Duebrødre Kloster occupied the site of the hospital of the Holy Ghost.

**Hospitals.**—Among the hospitals of Copenhagen the most important are Frederick's Hospital, erected in 1752-57 by Frederick V., with accommodation for 600 patients; the Communal Hospital, erected in 1859-63, on the eastern side of the Sortedamssø, with room for 850; the General Hospital in Amalia Street, founded in 1769; the Garrison Hospital, in Rigens Gade or Empire Street, established in 1816 by Frederick VI.; a children's hospital in the same street dating from 1849; and a maternity hospital with a school of midwifery. The lunatic asylum for Copenhagen is situated at Roskilde. Of the numerous benevolent institutions in the city it is sufficient to mention Barton Hospital, dedicated by its founder, Christian I., to the Holy Ghost, with accommodation for 508 inmates; Abel Kathrine's Buildings for 24 poor women; the Copenhagen Invalids' Home, erected in 1857-59; an orphan asylum, dating from 1727; a blind asylum, erected in 1811 by a private society; a deaf and dumb asylum, founded in 1807; and an asylum for imbeciles, established in 1855. The Jewish community has several important institutions of its own. After the cholera epidemic of 1853 the medical association built several ranges of workmen's houses, and their example has been followed by various private capitalists, among whom may be mentioned the Classen trustees, whose buildings occupy an open site on the western outskirts of the city.

**Theatres.**—The principal theatre is the Royal, on Kongens Nytorv, a beautiful edifice of modern erection on the site of a former building of the same name which dates from 1748. Statues of Holberg and Oehlenschläger, the former by Stein, and the latter by Bissen, keep watch on either side of the entrance, and the front is crowned by a group by King, representing Apollo and Pegasus and the fountain of Hippocrene. The royal court theatre is elegantly fitted up, and can accommodate about 800 spectators. The Vesterbro Theatre, outside the western gate, is seated for about 1400 persons. The casino, built in 1846, is used as a theatre, and is capable of containing about 2300 spectators; while the small saloon in the same building, seated for from 600 to 700 persons, is usually let for concerts and similar entertainments. The Tivoli Gardens, immediately beyond the western gate, form the favorite place of resort in the summer evenings. The amusements include concerts, pantomimes, gymnastic feats, and other performances. A freemasons' lodge was founded in 1870, the building being erected after the designs of Tvede.

In the neighborhood of the city there are numerous places of public resort,—the most important being Frederiksberg, with its royal palace, its park, and its zoological gardens, about a mile and a half from the old west gate, and the Dyrehave about six miles to the north, with its fine forest of beech and oak.

**Trade.**—Copenhagen is becoming more and more the commercial centre of Denmark; its local industries and its foreign trade are both making rapid advances. At the commencement of 1872, 500 merchant vessels of about 51,000 tons burden belonged to the port. The harbor is large and commodious, and by the aid of canals, large vessels can come almost to the centre of the town. The entrance is commanded by the powerful batteries of Trekroner, Provesten, and Sextus. The principal imports are timber, pitch, and tar, chiefly from Norway and Sweden; flax, hemp, masts, sailcloth, and cordage from Russia; tobacco from America; wines and brandy from France; coal, earthenware, iron, steel, and salt from England; and West India produce. The principal exports are corn, rape-seed, butter, cheese, beef, pork, horses, cattle, wool, hides, skins, bones, and grain-spirits.

There are extensive cloth and calico factories, foundries, and iron-works, as well as breweries, distilleries, tanneries, sugar-refineries, lime-works, and tobacco-factories. Piano-fortes, clocks, watches, surgical and mathematical instruments, and porcelain are among its other productions. The royal China factory is celebrated for its models of Thorwaldsen's works in biscuit China. Among institutions for the furthering of commerce, the most important besides the Exchange are the National Bank, with a capital of £2,190,000, the Private Bank, the Industrial, the Agricultural, and the Commercial. A large Industrial Exhibition was held in 1872; and the building, which is situated at the western side of the town near the railway station, is intended to be permanent. The population of Copenhagen in 1769 was 92,571; in 1801, 100,975; in 1834, 119,222;

in 1840, 120,812; in 1845, 126,787; in 1850, 129,695; in 1860, 165,143; and in 1870, 184,291. In the last year the number of females was 96,965, and that of males 89,326; there were 3145 Jews, 1092 Catholics, 220 Baptists, and 172 Mormons. Including the suburbs, the population in 1876 was estimated at 233,000.

*History.*—The first mention of Copenhagen in Danish history belongs to the year 1027, when the kings of Norway and Sweden took advantage of the absence of Canute in England to attack his kingdom. It is called merely the Høfn or Haven; and it was still only a fishing village about the middle of the 13th century, when Valdemar I. presented that part of the island to Axel Hvide, renowned in Danish history as Absalon, bishop of Roskilde, and afterwards archbishop of Lund. In 1185, or shortly after, this prelate erected a castle on the spot where the Christiansborg palace now stands, and the building was called after him Axel-huus. The settlement gradually became a great resort for merchants, and thus acquired the name which, in a corrupted form, it still bears, of Kaupmannshöfn, Kjöbmannshavn, or Portus Mercatorum, as it is translated by Saxo Grammaticus. Bishop Absolon bestowed the castle and village, with the lands of Amager, on the sea of Roskilde; and Bishop Eriandesen granted the little community municipal rights and privileges, which were confirmed and augmented in 1284 by King Eric Glypping. Meanwhile its prosperity was checked by an attack by the people of Lübeck, in 1248, and by another on the part of Prince Yarimar of Riga in 1259. In 1306 it managed to repel the Norwegians, but in 1362, and again in 1368, it was captured by the opponents of Valdemar Atterdag. In the following century a new enemy appeared in the Hanseatic League, which was jealous of its rivalry, but their invasion was frustrated by Queen Philippa. Various attempts were made by successive kings to obtain the town from the sea of Roskilde, as the most suitable for the Royal residence; but it was not till 1443 that the transferece was effected, and Copenhagen became the capital of the kingdom. From 1523 to 1524 it held out for Christian II. against Frederick I.; and it was only after a year's siege that it yielded in 1536 to Christian III. From 1658 to 1660 it was unsuccessfully beleaguered by Charles Gustavus of Sweden; and in the following year it was rewarded by various privileges for its gallant defence. In 1660 it gave its name to the treaty which concluded the Swedish war of Frederick III. In 1700 it was bombarded by the united fleets of England, Holland, and Sweden; in 1728 a conflagration destroyed 1640 houses and five churches; another in 1794 consumed the Christiansborg; and a third in 1795 laid waste 943 houses, the church of St. Nicolas, and the Town House. In 1801 the Danish fleet was destroyed in the roadstead by the English under Nelson; and in 1807 the city was bombarded by the British army under Lord Cathcart, and saw the destruction of the university buildings, its principal church, and numerous other edifices. In 1853 it lost 4100 of its population from cholera.

**COPERNICUS, or KOPERNIK, NICOLAUS** (1473-1543), was born on the 19th February, 1473, at Thorn in Prussia, where his father, a native of Cracow, had settled as a wholesale trader. His mother, Barbel Watzelrode, was the daughter of a well-to-do merchant. The education of Nicolaus, whose father died early, was undertaken by his uncle Lukas Watzelrode, subsequently (1489) bishop of Ermeland. After a course of instruction at the school in Thorn, he entered the university of Cracow in 1491, and during four years studied mathematical science under Albert Brudzewski, devoting his spare time to painting. At the age of twenty-three he repaired to Bologna, and attended the lectures of Dominic Maria Novarra, professor of astronomy there. He next spent some years at Padua, where, in addition to mathematics and astronomy, he applied himself to medicine, in which, in 1499, he took the degree of doctor. In 1500 he was at Rome, enjoying the friendship of the astronomer Regiomontanus, and fulfilling with distinction the duties of a chair of mathematics. Copernicus had already been for some time a member of the chapter of Frauenburg, at which place he appears to have taken up his abode in 1503. His time was now engaged in clerical work, in giving gratuitous medical aid to the poor, and, though with but a slender stock of instruments, in the prosecution of his favorite studies. The house which he occupied at Allenstein is still to be seen, with the perforations which he made in the walls of his chamber in order to observe the passage of the stars across the meridian; also the remains of an hydraulic machine, similar to that at Marly, which he constructed for the purpose of raising the water of a rivulet for the supply of Frauenburg.

By his bishop and fellow-canons Copernicus was employed in defending their rights and privileges against the

encroachments of the Teutonic knights; and when sent as a deputy to the diet of Grodno, he busied himself in considering the means of improving the corrupt coinage, and wrote a paper on that subject, which was placed among the archives of the diet. Copernicus sought by a comparative study of the various astronomical systems of the ancients to evolve from them a single system, at once simple and consistent. According to the hypothesis of the ancient Egyptians, Mercury and Venus revolved round the sun, which itself, with Mars, Jupiter, and Saturn, moved round the earth. Apollonius of Perga chose the sun as the common centre of all the planetary motions, but held that, like the moon, it turned round about the earth. The principal Pythagorean philosophers, on the other hand, regarded the sun as the centre of the universe, about which the earth performed a circuit. Nicetas, Heraclides, and others assigned a central position to the earth, but supposed it to have a motion of rotation round its axis, which produced the phenomena of the rising and setting of the stars, and the alternations of day and night. Philolaus removed the earth from the centre of his system, and conceived it to have not only an axial rotation, but also an independent annual revolution round the sun. From the various ill-founded and unshapely theories of his predecessors Copernicus obtained the material for erecting a solid and imposing structure—the system with which his name is connected. This was expounded in a treatise entitled *De Orbium Cœlestium Revolutionibus Libri VI.*, the preparation of which occupied its author from about 1507 to 1530. This work Copernicus long delayed bringing before the world, being content to defer for a while the popular outcry against himself, which, as a setter-forth of truths hitherto unknown to science and as an impugner of the rights of time-honored dogmatism, he must be prepared to endure. At length, however, yielding to the importunities of his friends, he permitted the publication of the book, which he dedicated to Pope Paul III.; in order, as he says, that he might not be accused of seeking to shun the judgment of enlightened men, and that the authority of his Holiness, if he approved of it, might protect him from the baleful tooth of calumny.

The work was printed at Nuremberg, under the superintendance of Rheticus, one of the disciples of Copernicus. The impression had just been completed, when Copernicus, who had all his life enjoyed perfect health, was attacked with dysentery, followed almost immediately by a paralysis of the right side, with loss of memory, and obscuration of the understanding. For some time he lingered, and on the day of his death, only a few hours before he expired, a copy of his work sent by Rheticus arrived, and was placed in his hands. He touched it, and seemed conscious what it was; but after regarding it for an instant, he relapsed into a state of insensibility, which soon terminated in death. He died on the 24th May, 1543, at the age of seventy. His tomb, which is not distinguished from that of the other canons of Frauenburg, was in 1581 adorned with a Latin epitaph by the Polish Bishop Cromer. In 1830 a statue of Copernicus, by Thorwaldsen, was placed in the Casimir Palace at Warsaw; and in 1853 another monument to him, by Tieck, was erected at Thorn.

The first formal exposition of the theories of Copernicus in contradistinction to the notions which had hitherto prevailed, was a letter published by Rheticus, and entitled *Ad. Clar. V. d. Schonerum de Libris Revolutionum eruditiss. Viri et Mathematici excellentiss. Rev. Doctoris Nicolai Copernici Torunensis, Canonici Warmienseis, per quemdam juvenem Mathematicæ studiosum, Narratio prima*. Dantsie, 1540, 4to; reprinted with a eulogium, at Basel, 1541, 8vo. The works of Copernicus are—1. *De Orbium Cœlestium Revolutionibus Libri VI.*, Nuremberg, 1543, small folio; reprinted at Basel in 1566, with the letter of Rheticus, and also included in the *Astronomia Instaurata* of Nicolas Muler, Amsterdam, 1617 and 1640, 4to; 2. A treatise on trigonometry, with table of sines, entitled *De Lateribus et Angulis Triangulorum*, Wittenberg, 1542, 4to; 3. *Theophylactici Scholastici Simocætte Epistolæ morales, rurales, et amatoris cum versione Latina*. In 1521, Copernicus presented to the states of his provinces his work on money; and there are several manuscript treatises of his in the library of the bishopric of Warmia.

The life of Copernicus has been treated of by the following authors:—Gassendi (Paris, 1654); Sniadeski (Warsaw, 1803); Westphal (Constantine, 1822); Percy (Paris, 1824); Czynski (Paris, 1846); Szyrma (Lond., 1846); Prowe (Thorn, 1852-55-60-65); Saule (Warsaw, 1855); and Domenico Berti, in *Copernico e le Vicende del Sistema Copernicano in Italia* (Rome 1876). See *Астрономы*.

COPIAPO, an inland town of Chili, capital of the province of Atacama, is situated on a stream of the same name about 35 miles from the sea, in  $27^{\circ} 38' S. lat., 70^{\circ} 23' W. long.$  The streets of the town, which was founded in 1784 by Count José de Manso, are straight and wide, with side pavements; but the houses are low and of timber, excepting in the streets Chafarillo and Atacama, where they are built with more elegance and of more solid material. The principal square is 408 feet on each side, with flowers and shrubs in the centre surrounded by rows of shady pepper trees; while at the western end of the town is an avenue 52 feet broad and half a mile long with four rows of willow trees. Copiapo is connected by rail with the port of Caldera, 50 miles westward, and with the surrounding great mining districts, to which it owes its importance. From its situation in one of the driest regions of America, water is scarce, and the stream Copiapo is all utilized before it reaches the sea. Population, 12,000.

COPLEY, JOHN SINGLETON (1737-1815), historical painter, was born of Irish parents at Boston, Massachusetts. He was self-educated, and commenced his career as a portrait-painter in his native city. The germ of his reputation in England was a little picture of a boy and squirrel, exhibited at the Society of Arts in 1760. In 1774 he went to Rome, and thence in 1775 came to England. In 1777 he was admitted Associate of the Royal Academy; in 1783 he was made Academician on the exhibition of his most famous picture, the Death of Chatham, popularized immediately by Bartolozzi's elaborate engraving; and in 1790 he was commissioned to paint a portrait picture of the defence of Gibraltar. The Death of Major Pierson, now in the national collection, also deserves mention. Copley's numerous other works are little esteemed, being feeble and lifeless in drawing, and cold and dull in color. His powers appear to greatest advantage in his portraits. He was the father of Lord Chancellor Lyndhurst. See LYNDHURST.

COPPER is a metal which has been known to and used by the human race from the most remote periods. Its alloy with tin (bronze) was the first metallic compound in common use by mankind, and so extensive and characteristic was its employment at an early stage in pre-historic times that the epoch is known in archeological chronology as the Bronze Age. Metallic relics of that age in the form of arms, ornaments, and domestic implements are still very abundant. By the Greeks and Romans both the metal and its alloys were indifferently known as *χαλκός* and *æs*. As, according to Pliny, the Roman supply was chiefly drawn from Cyprus, it came to be termed *æs cyprium*, which was gradually shortened to *cyprium*, and corrupted into *cuprum*, whence comes our copper, the French *cuivre*, and the German *kupfer*.

Copper (chemically, *Cuprum*, Cu) is a brilliant metal of a peculiar red color, in which respect it differs from all others excepting, perhaps, titanium. The atomic weight of copper is 63.5, and its specific gravity varies between 8.91 and 8.95, according to the treatment to which it may have been subjected. It takes a brilliant polish, is in a high degree malleable and ductile, and in tenacity it only falls short of iron, exceeding in that quality both silver and gold. By different authorities its melting point is stated at from  $1000^{\circ} C.$  to  $1398^{\circ} C.$  In electric conductivity it stands next to silver; the conducting power of silver being equal to 100, that of perfectly pure copper is given by Matthiessen as 96.4 at  $13^{\circ} C.$  On solidifying from its molten condition it expands. Copper is not affected by exposure in dry air, but in a moist atmosphere it becomes coated with green carbonate. When heated or rubbed it emits a peculiar disagreeable odor.

Copper, according to Walchner, is as widely distributed in nature as iron, and occurs in all soils, and ferruginous mineral waters and ores. It has been discovered in seaweed; in the blood of certain Cephalopoda and Ascidia, and of a species of *Limulus*; in straw, hay, eggs, cheese, meat, and other food-stuffs; in the liver and kidneys, and, in traces, in the blood of man and other animals; it has also been shown by Church to exist to the extent of 5.9 per cent. in turacin, the coloring-matter of the wing-feathers of the *Turaco*. The ores containing copper in sufficient proportion to render its extraction economically practicable are numerous. It occurs not unfrequently native, sometimes in very great masses, as on the south shores of Lake Superior, where pieces of 150 tons weight have sometimes been obtained. Native copper most frequently occurs in

masses of irregular form in rocky fissures, and often crystallized. The principal ores of copper are *Cuprite*, *Melaconite*, *Malachite*, *Chessylite*, *Atacamite*, *Chrysocolla*, *Chalcoite*, *Chalcopyrite*, *Erubescite*, and *Tetrahedrite*. Cuprite, or red oxide of copper,  $Cu_2O$ , is a mineral which crystallizes in the cubic system, and contains 88.78 of metal. It occurs in most cupriferous mines, but never by itself in large quantities. Melaconite, or black oxide of copper,  $CuO$ , contains, when pure, 79.85 of the metal. It was formerly largely worked in the Lake Superior region, and is abundant in some of the mines of Tennessee and the Mississippi valley. Malachite, or green carbonate of copper,  $CuCO_3 \cdot Cu(OH)_2$ , is a beautiful and valuable ore containing about 56 per cent. of the metal; it is obtained in very large quantities from South Australia, Siberia, and other localities. Frequently intermixed with the green carbonate is the blue carbonate of copper, chessylite or azurite,  $2CuCO_3 \cdot Cu(OH)_2$ , an ore containing when pure 55.16 per cent. of the metal. It was formerly characteristic of Chessy, near Lyons. Atacamite is a hydrated oxychloride of copper, occurring chiefly in Chili and Peru; it crystallizes in the rhombic system. Chrysocolla is a hydrated silicate of copper,  $CuSiO_3 \cdot 2H_2O$ , containing in the pure state 30 per cent. of the metal; it is an abundant ore in Chili, Wisconsin, and Missouri. The sulphur compounds of copper are, however, the most valuable in an economical point of view. Chalcoite, redruthite, copper-glance, or vitreous copper, is a sulphide,  $Cu_2S$ , containing very nearly 80 per cent. of copper. Copper pyrites, or chalcopyrite, a sulphide of copper and iron,  $CuFeS_2$ , crystallizes in the pyramidal system and contains 34.6 per cent. of copper when pure; but many of the ores, such as those worked specially by wet processes on account of the presence of a large proportion of sulphide of iron, contain less than 5 per cent. of copper. Cornish ores are almost entirely pyritous; and indeed it is from such ores that by far the largest proportion of copper is extracted throughout the world. In Cornwall copper lodes usually run east and west. They occur both in the *killas* or clay-slate, and in the *granosa* or granite. Erubescite, bornite, or horseflesh ore is a sulphide of copper and iron much richer in copper than the ordinary pyrites, and containing 56 or 57 or, according to the formula  $FeCu_3S_5$ , 62.5 per cent. of copper. Tetrahedrite, fahlerz, or grey copper, a sulphide crystallizing in the cubical system, contains from 30 to 48 per cent. of copper, with arsenic, antimony, iron, and sometimes zinc, silver, or mercury. The numerous other compounds of copper have more interest from a mineralogical than from a metallurgical point of view.

Copper is obtained from its ores by two principal methods, which may be denominated—(1) the pyro-metallurgical or dry method, and (2) the hydro-metallurgical or wet method; and a small proportion of metallic copper is procured by (3) the electro-metallurgical method.

The methods of working vary according to the nature of the ores treated and local circumstances. The dry method, or ordinary smelting, cannot be profitably practised with ores containing less than 4 per cent. of copper, for which and for still poorer ores the wet process is preferred.

SMELTING.—In Great Britain ordinary copper smelting is almost entirely centred at Swansea in Wales, although it is also practised in Lancashire. The processes there employed for extracting copper are technically known as the "English method," in contradistinction to numerous other modified processes adopted at Continental and other foreign smelting centres. The following is an outline of the English method as conducted at Swansea.

The ores are divided by the smelter into two general classes—those containing sulphur, and those having little or no sulphur. The former are subdivided according as they contain much silica, iron pyrites, tin, arsenic, &c., or a larger or smaller quantity of copper. The object of this classification of ores in the yard is to enable the operative smelter to make up a constant working mixture, having the following characters:—

1. The copper present is not under 9 nor above 14 per cent.; if under the former it would be unprofitably poor; if over the latter, the slags would have a tendency to retain copper, creating a loss.
2. After being calcined for an ordinary length of time, it will fuse easily without the necessity of adding flux, giving a clean and easily fused slag.
3. The mat or coarse metal obtained from fusion contains as nearly as possible 30 per cent. of copper.

4. The mixture does not contain ores having impurities calculated to make the copper of too low a quality.

There is no definite or fixed rule to guide the smelter in these classifications, except a practised eye in distinguishing the character of ores, and the report of the assayer.

I. *Calcination of the Ores.*—The mixture of ores being selected according to these rules, it is carried to hoppers on the top of a large reverberatory furnace, termed the calcining furnace, and is then let down into the hearth, where, after drying a little, it is spread equally over the bottom, and covered to a depth of from 6 to 8 inches. The quantity of ore put in varies, according to the size of the furnace, from 3 tons to 4 tons. The fire of the furnace is kept low at first; after two or three hours the ore on the surface becomes visibly red, and the heat is gradually increased to a yellow red; but this heat penetrates to the depth of only about 2 inches, consequently the ore has to be stirred and turned over by means of long iron paddles every hour, so as to expose a new surface to the action of the air and fire. The calcination lasts generally from twelve to twenty-four hours, the length of time being dependent on the proportions of silica and sulphide of iron in the charge. Calcining furnaces are now very commonly provided with Siemens regenerators and heated with gas. The following changes take place:—the sulphur is partly burned off, forming sulphurous and sulphuric acids, and partly volatilized in the free state; arsenic is volatilized and oxidized; and part of the copper and iron lose sulphur and combine with oxygen, forming oxides.

When the ore is sufficiently calcined, it is let down into the *cubs* or vaults beneath, by openings in the floor. Water is added to the hot ore in the cubs to prevent dust and assist further oxidation; the ore is then removed to a yard, and there stored up, ready for the fusing furnace. The following analysis of ore, before and after calcining, will give an idea of the changes that have taken place:—

Before Calcination.	After Calcination.
Copper..... 12.3	Copper..... 12.2
Iron..... 32.7	Iron..... 22.7
Sulphur..... 31.0	Oxide of Iron..... 18.5
Silica..... 24.0	Sulphur..... 16.2
	Silica..... 30.4
	100.0

II. *Fusion of Calcined Ores.*—The next operation is the fusing of the calcined ore, which is done in a reverberatory furnace, termed an ore-fusing furnace, fitted also with a hopper on the top for charging it. The charge consists of

- From 25 to 30 cwt. of calcined ore;
- From 7 to 9 cwt. of sharp or metal slag from operation IV.;
- From 2 to 3 cwt. cobbling.<sup>1</sup>

When the charge is let down into the furnace it is spread equally over the bottom, the doors are all closed, every air-hole is stopped with clay, and the heat of the furnace increased as rapidly as possible.

After about five hours' firing, when the furnace has reached a white heat, the door-plate is removed, and a long iron rake passed through the contents to make sure that the whole is perfectly fused. This being the case, the workman begins the operation of *skimming*, that is, drawing off the slag, which floats on the surface of the mat, and removing it at the front door. When the surface is skimmed, the common practice is to let down a second charge of ore, and to fuse and skim in the same manner, before tapping the furnace to let out the metal or mat, which is generally tapped into large pits of water, and so granulated. These pits are from 6 to 8 feet deep, and from 4 to 5 feet square, and into them a perforated box is lowered, which receives the charge of metal, and is raised by a crane or pulley. The metal is then removed to a yard for the next operation. This mat is termed granulated *coarse* metal. In many cases the coarse metal is first run into moulds and subsequently crushed for the next operation.

The average composition of good coarse metal is given by Le Play as

Copper.....	33.7
Sulphur.....	29.2
Iron.....	33.6
Foreign metals.....	2.0
Slag, mechanically mixed.....	1.1
	99.6

<sup>1</sup> Cobbling is the name given to broken pieces of old bricks and bottoms of furnaces that have absorbed copper.

That of the slag or scoria is

Silica, mixed and combined.....	60.5
Protoxide of iron.....	28.5
Alumina, Lime, &c.....	11.0
	100.0

III. *Calcination of Coarse Metal.*—This operation is performed in the same manner as the calcination of the ore. The charge of metal, which is about 4 tons, covers the bottom of the hearth to the depth of 4 inches or so. It is put in through the hoppers fitted upon the top of the furnace, as described for the ore. The coarse metal being easily fused, great care is required not to raise the heat of the furnace too high, otherwise the metal will cake, and by adhering to the bricks will prove prejudicial both to the calcination and to the furnace. When the charge is let into the furnace, it is slowly brought to a visible red, which during the next fourteen hours is gradually increased to a bright red heat. This temperature is continued until the charge has been altogether twenty-four hours in the furnace, when it is let down through the bottom into the cubs, and water is thrown upon it.

The following analyses give an average result of the changes effected in this operation:—

Metal put into Calciner.	Metal after Calcination.
Copper..... 32	Copper..... 33
Iron..... 39	Iron..... 38
Sulphur..... 25	Sulphur..... 13
Other materials and loss..... 4	Oxygen, &c..... 16
	100

IV. *Fusion of Calcined Coarse Metal.*—In this operation the charge for an ordinary-sized furnace of 8 feet by 13 feet is—

- 25 cwt. of calcined metal;
- 5 to 7 cwt. slag from the roaster and refinery furnaces;
- 2 to 3 cwt. of cobbling.

In this mixture the oxide of iron is in excess in relation to the silica, and it is therefore much more easily fused than the ore; but the reactions which take place are similar: the silica and oxide of iron combine to form slag, which floats upon the surface of the mat and has to be skimmed off, after which the mat is tapped out into sand-moulds. Two charges are generally fused before the metal is tapped out. This mat is termed *blue metal* from its being of a slate-blue color; the scoria is termed *sharp slag*, from its containing an excess of oxide of iron, and being consequently used as a flux for fusing the ore in operation II.

The following is the composition of good blue metal and sharp slag:—

Blue Metal.	Sharp Slag.
Copper..... 58.8	Oxide of iron..... 53
Sulphur..... 20.5	Oxide of copper..... 2
Iron..... 12.6	Silica, &c..... 45
Insoluble..... 4.2	
Oxygen and loss..... 3.9	100
	100.0

Should there be no ores such as carbonates or oxides on hand to smelt, the blue metal, instead of being tapped into sand-beds as described, is run into pits of water in the same manner as coarse metal, and subjected to another calcination and fusion.

When oxides and carbonates, such as the Australian ores, are on hand, they are generally fused with the calcined coarse metal, by which means a double advantage is obtained; the excess of oxide of iron in the calcined metal fluxes the silica of the ore which has little iron, and the copper in the ore is converted into cupric sulphide, a condition necessary for reduction by the present method of smelting. The produce of this fusion is a mat termed *pimpled* or *white* metal, from its having small rough granules on the surface of the ingots. The average composition of this metal is—

Copper.....	78
Sulphur.....	18
Iron.....	2
Silica.....	2
	100

The composition of the slag from this operation is very variable; it always contains copper, and has to be remelted. V. *Roasting.*—This operation has been often identified with calcining, from which, however, it is distinct. The roasting differs from the fusing furnace by having a large

opening in the side for putting in the charge, and it is furnished with more air-holes in the bridge. The charge for an ordinary-sized furnace is 3 tons. When the metal is brought to fusion, the air-holes of the furnace are all opened, and a free current is allowed to pass over the surface of the fused mass: the heat of the fire is then regulated so as to keep the charge in a sort of semi-fluid state. This is continued for about twenty-four hours, during which a great portion of the sulphur is driven off, and the iron, by uniting with silica and other matters, forms scoria, which is from time to time skimmed off. When all the impurities are removed, and the mat or regulus acquires the composition of sulphide of copper,  $\text{Cu}_2\text{S}$ , then (except when the regulus has been very rich) begins another operation termed the second roasting, or roasting proper, requiring other twenty-four hours. In this last roasting, when the air-holes are opened, a brisk effervescence ensues over the surface of the fluid mass.

The chemical reactions which give rise to this effervescence may be explained thus. The oxygen of the air combines in the first place with a portion of the sulphur, forming sulphurous acid. A portion of the copper is also oxidized, to form the sub-oxide, and instantly reacts upon another portion of the sulphide, reducing the metal. The reactions are chemically represented thus:—

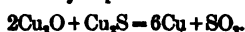

The process is a very beautiful one, and exhibits a nice adaptation of principles to practice. The sponge regulus has a specific gravity of 5, the reduced copper of about 8; so that the copper sinks to the bottom, where it is protected, and a new surface of regulus becomes exposed to the action of the air.

If the ore be pure, or if no select copper be required, the operation of roasting is continued until the whole of the copper is reduced; when it is tapped out into sand-moulds, forming *coarse copper*, *bed copper*, *pimpled copper*, or *blistered copper*, according to quality. The term *coarse copper* is applied occasionally to all these kinds except the blistered. If the ingot sets with contraction and exhibits a smooth hollow surface, it is termed *bed*, and generally indicates the presence of other metals, as tin. When the surface of the ingot is covered with pimples, it is termed *pimpled copper*, and indicates the presence of sulphur. When covered with large scales of oxide of copper, it is termed *blistered*; but this is only when the copper is good and ready for refining. The following analysis of blister copper is given by Le Play:—

Copper .....	98.4
Iron .....	.7
Nickel, Cobalt, and Manganese .....	.3
Tin and Arsenic .....	.4
Sulphur .....	.2
	100.0

To make select copper, the roasting is carried on until about one-fourth of the copper in the regulus is reduced; the furnace is then tapped, and the reduced metal is obtained at the bottom of the first and second ingots, or pigs, as *copper bottoms*, which contain most of the metallic impurities. The regulus is collected and again roasted, which produces the purest metal the ordinary process of smelting can give; it is termed *best selected*.

**VI. Refining.**—In this operation, the remainder of the sulphur and foreign metals present in the copper is removed, and the metal is brought into a condition fit for the market. The refining furnace is similar in general form to a roasting furnace, except that the bottom inclines gradually down from all sides towards a deep part, or well, which is near the end door. It has also a large door on one side, but neither opening in the roof nor side tap-hole. Siemens's regenerative furnace has been very generally introduced for refinery purposes. When the copper is to be finally ladled out of the furnace the deep part, or well, allows of the ladle being dipped into the metal till the last portions are quite baled out. From 6 to 8 tons of copper from the roasting furnace are put into the refining furnace, the doors and air holes of which are closed, and the heat is raised until the metal is in fusion, when the air-holes are opened. A short roasting is generally required, which is done in the manner above described, and the scoria which collects is carefully skimmed off. The separation of impurities is facilitated by occasionally stirring the metal with a rake.

Some refiners throw pieces of green wood upon the surface, under the impression that it assists the escape of sulphur. The roasting is continued until a ladleful of the metal taken out sets with contraction. If the metal be very coarse, it will set with a surface having a frothy appearance; if finer, it sets with expansion, first round the edge, then swelling towards the centre, forming a little mound or cone, and occasionally boiling over and throwing up jets of metal, forming a miniature volcano. When the setting of the metal in the ladle is favorable, the charge is ready for the operation of *poling*. A quantity of charcoal or anthracite coal is first thrown upon the metal to prevent oxidation by the air, and then the end of a large pole of green wood, generally of birch or oak, is inserted into the melted copper, and kept pressed down to the bottom of the metal, which spurts and boils violently. This operation, it will be at once apparent, consists in the reduction of an oxide or suboxide. Since oxide of copper dissolves in metallic copper, as a salt dissolves in water and makes it brittle, to put pieces of wood or charcoal upon the surface would not remove the oxygen; hence the necessity of poling, in order to bring the carbonaceous matters into contact with the dissolved oxide. As the poling proceeds the refiner takes from time to time small samples called assays, which he hammers and breaks for examination. When the copper reaches the proper "pitch" the assay bends without breaking, and if cut and broken the fracture is fibrous, and presents a silky lustre. When this pitch is attained the pole is withdrawn, and a quantity of charcoal thrown upon the surface; and, if the copper is for rolling or hammering, a little lead is added to the charges to insure toughness.

In making what is termed best selected copper, the refining is performed in the manner described, but no lead is added. This quality of copper is used for the manufacture of fine alloys, such as the best brass or Muntz's yellow metal. Copper a little over-poled is generally preferred for these purposes.

When the copper is brought to the proper pitch by the refining operation it is ladled out into moulds. The following are the forms in which British smelted copper is usually cast:—

Cake, 19 × 12½ × 1½ inches,	weight 1 owt. 1 qr.
Tile, 19 × 12½ × 1½ "	" 1 qr. 3 lb.
Ingot, 11 × 3½ × 1½ "	" 14 to 16 lb.

During the ladling out the refiner takes an assay at short intervals, as the metal is liable to get out of pitch, or become *dry*, as under-poled copper is termed, in which case poling has to be resumed. So much depends upon refining, that the best copper by a defect in this operation will be rendered unmarketable.

A great variety of improvements in copper-smelting have been proposed and patented, one or two of which have been usefully applied. Several modifications of the various processes are also adopted to suit the quality of the ores and the kind of copper to be produced. These are all suggested by the experience of the smelters in dealing with the materials at their disposal.

**WET PROCESSES.**—Several methods of extracting copper by the wet way have been more or less in practice at various periods; but it is only of recent years that one of these has been established on a scale of great commercial extent and importance. From a very early time it has been known that the water which drained from mines containing pyritous copper ores, and which from the oxidation of the sulphide of copper contained some proportion of cupric sulphate, yielded metallic copper by precipitation in the presence of malleable or cast iron. The copper obtained in this way is known as cementation copper, and from the Spanish and Portuguese pyrites mines a considerable amount of metallic copper has long been so precipitated. The process now very extensively adopted for treating Spanish and Portuguese pyrites, and some ores of similar composition from other countries, is that patented by Mr. William Henderson in 1859. Mr. Henderson's process is in several essential particulars the same as one patented in 1842 by Mr. William Longmaid, which, however, was chiefly designed for the production of sulphate of soda, copper being only a by-product. There can be no doubt that Mr. Henderson is the practical originator of the wet process, which in Great Britain now occupies a most important position among metallurgical industries.

The ores treated by the Henderson process are remark

ably constant in character, and the following may be taken as representing their average composition:—

Sulphur.....	49-00
Iron.....	43-55
Copper.....	3-20
Lead.....	0-93
Arsenic.....	0-47
Zinc.....	0-35
Lime, with traces of silver, gold, &c.....	2-50
	100-00

The pyrites is first employed by alkali manufacturers and other consumers of sulphuric acid as a source of that substance, in burning for which the ore loses about 30 per cent. of its weight. It is this burnt pyrites which forms the raw material of the process. The various stages it undergoes are briefly as under.

I. *Grinding*.—The burnt ore, as received from the acid burners, is first mixed with about 15 per cent. of common salt, and ground to a fine powder by passing it between a pair of heavy cast-iron rolls. As the amount of sulphur left in the burnt ore is apt to vary, it is necessary to ascertain its proportion in each parcel of burnt pyrites. When the sulphur falls short of the proportion necessary for effecting the decomposition which follows, a sufficient quantity of "green" or unburned pyrites is added to produce a proper balance. If, on the other hand, the sulphur has been insufficiently extracted, "dead" roasted are is added.

II. *Calcination*.—This operation is accomplished by several kinds of furnaces, that used by the Tharsis Sulphur and Copper Company being a large muffle or close furnace. By others a patent furnace with a revolving hearth and mechanical stirring arrangement has been adopted with good results, and some use open reverberatory furnaces heated by gas from Siemens's generators. During the roasting the mixture is frequently stirred, and, in the case of hand-worked furnaces, turned with long rables, and the completion of the operation is ascertained by test assays. When the copper has been brought into a soluble condition, the charge is raked out of the furnace and permitted to cool under a screen at its mouth. By the calcination the sulphur in the compound is first oxidized, sulphate of sodium is formed, and at the same time the chlorine from the sodium chloride unites with the copper to form cupric chloride. A small proportion of cuprous chloride is also formed, and special precautions have to be taken to prevent the extensive formation of this compound, which is dissolved only with difficulty. The hydrochloric acid and other gaseous products evolved during the calcination are condensed as "tower liquor" in ordinary condensing towers, and the product is used in the subsequent process of lixiviation.

III. *Lixiviation*.—The calcined ore is conveyed to tightly-caulked wooden tanks, in which it receives repeated washings with hot water, tower liquor, and dilute hydrochloric acid, till all the soluble copper is thereby extracted. The product of the later washings is pumped or drawn up by a modification of Giffard's injector, to serve as a first liquor for subsequent charges of the lixiviating tanks, and no solution under a definite strength is permitted to pass on to the next stage in the process. The insoluble residue in the tanks consists of "purple ore," an almost pure ferric oxide, largely used in "fettling" blast furnaces, and for smelting purposes; besides which it is available as jeweller's rouge.

IV. *Precipitation*.—The precipitation of metallic copper from the solution of its chloride is accomplished in large tanks by means of metallic iron in the same way that cementation copper is obtained from solutions of the sulphate. The solution is run into the tanks, in which there are miscellaneous heaps of old malleable iron; the chlorine combined with the copper unites with the iron, and metallic copper in a state of fine division is thrown down. The completion of the precipitation is ascertained by dipping a bright steel knife into the solution in the tank, and when no deposit of copper covers the steel the liquor is run off and a new charge conveyed into the tank. The tanks are drained periodically for removing the precipitate, which is first roughly separated from small pieces of iron, after which it is more thoroughly freed from iron, &c., by washing in water in a rocking sieve apparatus. The precipitate so obtained should contain 80 per cent. of metallic copper, which is either smelted directly for blister copper,

or may be fused with the white metal of the ordinary smelting process, and subsequently roasted.

It has been found possible to extract in this process with profit the small proportions of lead, silver, and gold which Spanish pyrites is known to contain. Two processes are in operation for this purpose—one devised by Mr. F. Claudet and the other by Mr. W. Henderson, the original patentees of the wet process. The liquors from the first three washings contain practically all these metals, and they alone are treated. Mr. Claudet precipitates them from the solution by means of iodide of potassium. Mr. Henderson dilutes his solutions to from 20° to 25° Twaddell, and adds a very weak solution of a lead salt, such as the acetate, by which he obtains a cream-colored precipitate containing about 53 per cent. of lead, 5 or 6 per cent. of silver, and 3 oz. of gold to each ton of the precipitate.

The importance of the wet process may be estimated from the fact that although it originated only in 1860, already 14,000 tons of copper are annually produced by it in Great Britain alone, out of an annual production for the whole world estimated at from 126,000 to 130,000 tons.

ALLOYS OF COPPER.—Copper unites with facility with almost all other metals, and a large number of its compounds are of the highest importance in the arts. Indeed copper is much more important and valuable as a constituent element in numerous alloys than it is as pure metal. The principal alloys in which it forms a leading ingredient are—1st, brass; 2d, bronze; and 3d, German or nickel silver; and under these several heads their respective applications and qualities will be found. These alloys are each much diversified as regards the relative proportions of the various metals which enter into their constitution, and these differences similarly modify the appearance and physical properties of the compounds. In this way for practical purposes they may be regarded as a great number of separate metals, each possessed of distinct qualities which fit it for special industrial uses. The following tables, compiled from various authorities, represent the analysis of typical examples of the several alloys:—

TABLE A.—Composition of Brass or Copper and Zinc Alloys.

	Copper.	Zinc.	Tin.	Iron.	Lead.
Roman coin—Titus.....	96-06	2-71	...	0-85	...
Tombac or Talmi gold.....	86-40	12-20	1-10	0-30	...
Statue of Minerva in Paris.....	83-00	14-00	2-00	...	1-00
English brass.....	70-29	29-26	0-17	...	0-28
Aich metal.....	60-20	38-10	...	1-60	...
Rothorn's sterro-metal.....	54-00	40-50	...	5-50	...
Ship-nails, bad.....	52-73	41-18	...	...	4-72
" good.....	62-62	24-64	2-64	...	8-69

Muntz's metal, or yellow sheathing, consists of 60 parts of copper and 40 of zinc, but the copper may vary from 50 to 63 per cent. and the zinc from 50 down to 37.

TABLE B.—Composition of Bronzes.

	Copper.	Tin.	Zinc.	Lead.	Iron.
Roman Coin—Domitian...	98-92	1-08	...	...	...
" Diocletian..	95-84	2-23	...	1-93	...
" Maxentius..	89-72	5-85	...	5-43	...
" Justinian..	84-53	6-82	...	8-65	...
Ancient Arrowhead.....	70-30	24-53	...	5-20	...
Common bell metal.....	79-90	20-03	...	...	...
Bronze statue, Thorwaldsen's shepherd...}	88-77	9-25	1-28	0-71	...
Bell of the 12th century...	76-10	22-30	1-60	trace.	1-60
Chinese gong.....	80-50	19-50	...	...	...
Japanese bell metal.....	60-50	18-15	6-10	12-20	3-05
Locomotive bearings.....	73-00	9-50	9-00	7-00	0-42
" piston.....	89-00	2-40	9-00	...	...
Speculum.....	65-15	32-78	...	...	...

Aluminium bronzes are composed of pure copper with from 2½ up to 10 per cent. of aluminium. Phosphor bronze, according to the purposes for which it is intended, contains from 3 to 15 per cent. of tin and from ½ to 2½ per cent. of phosphorus. Small proportions of other metals, among which are silver, nickel, cobalt, antimony, and bismuth, with sulphur, frequently enter into the composition of bronzes.

TABLE C.—Composition of Nickel Silver.

	Copper.	Nickel.	Iron.	Zinc.	Tin.	Cadmium.
Chinese Packfong.....	40.40	31.60	2.60	25.40	...	...
Parisian metal for spoons, forks, etc....	69.80	19.80	...	5.50	...	4.7
English nickel silver for plating.....	63.84	19.17	trace	17.01	...	...
English nickel silver for plating (another kind).....	62.63	10.85	trace	26.05	...	...

**SALTS OF COPPER.**—Several salts of copper possess considerable industrial value, chiefly for the formation of blue and green pigments, in dyeing and calico printing, and for the deposition of metallic copper by electro-metallurgy, &c. The principal salts of copper are the acetate, the carbonate, and the sulphate.

**Acetate of Copper or Verdigris.**—This salt is found in commerce in the two forms of basic and neutral acetate. The principal seat of the manufacture of the basic acetate is Montpellier in France, where the marc and other refuse of grapes, after the expression of the juice for wine-making, is employed as a source of the acetic acid necessary. Sheets of copper are placed among this refuse, and these soon become coated with a deposit of verdigris, which has only to be scraped off, kneaded up with water, and pressed into cakes. The neutral salt is prepared from basic acetate by dissolving it in pyroligneous acid (wood vinegar) and evaporating the solution to the crystallizing point. It is also formed by the double decomposition of the acetates of lead and calcium with sulphate of copper. Verdigris is much used as a pigment both in oil and water-color painting and in dyeing, and as a basis of compound pigments.

**Carbonate of Copper** in an impure condition forms a valuable series of pigments called *verditer*, *Bremen blue*, or *Bremen green*, possessing various shades of mingled green and blue according to the nature of the compounds with which the carbonate is mixed. The basis of these pigments is prepared by an elaborate and tedious process from the oxychloride of copper.

**Sulphate of Copper**,  $\text{CuSO}_4 \cdot 5\text{H}_2\text{O}$ , called also blue stone, or Roman vitriol, is, on the large scale, prepared direct from the cementation water from pyrites mines by evaporation to the crystallizing point. It is also prepared by the oxidation of sulphide of copper in a furnace at a comparatively low heat, and by the direct action of sulphuric acid on metallic copper, as well as by various other processes. The sulphate of copper is very largely used as a basis for the preparation of other copper compounds, in electro-metallurgy, in calico-printing, and in the American amalgamation method of extracting silver from its ores. In medicine it is employed as an emetic. On its use in the manufacture of chlorine, see vol. v. pp. 425 and 590.

Of pigments other than those above mentioned having a copper basis, there may be enumerated the native carbonate, mountain or mineral green; Brunswick green, an oxychloride obtained by moistening copper foil exposed to the atmosphere with hydrochloric acid or solution of ammonium chloride; Scheele's green ( $\text{Cu}_2\text{As}_2\text{O}_6$ ), an arsenite of copper; and Schweinfurt green, an aceto-arsenite of copper. Casselmann's green, a pigment discovered in 1865, is a compound of cupric sulphate with potassium or sodium acetate. While it almost rivals Schweinfurt green in brilliancy, it possesses the advantage of being entirely free from arsenic, which renders the latter pigment and Scheele's green so virulently poisonous. At the same time it must be remembered that all copper compounds are poisonous, although the preparations that do not contain arsenic are not so deleterious in their manufacture and applications as are the others. (J. PA.)

**COPPER ASSAYING.**—In the Cornish method of assaying there are five operations,—the fusion for regulus, the roasting of the regulus, fusion for coarse copper, refining, and the cleaning of the slags. (1) The sample of ore is first inspected to ascertain its quality, and is then reduced to powder. If too much sulphur is present it may be expelled by roasting the ore, or by using nitre in the fusion; in some cases it may be requisite to add sulphur in order to obtain a good regulus. A flux is employed consisting usually of lime, borax, fluor-spar, and glass, which form a slag with

the excess of iron in the ore. The button of regulus obtained must be such that it separates easily from the slag without breaking. (2) The regulus ground to a fine powder is next roasted for from 20 to 30 minutes, the heat applied being raised towards the end of the operation; the sulphides of iron and copper are thus converted into oxides. (3) In the fusion for coarse copper a flux of sodium bicarbonate with tartar or borax and nitre is employed; a button of metallic copper is obtained which breaks with a fine-grained and greyish or orange-colored fracture. (4) Refining consists first in the fusion of the button of coarse copper and the oxidation by the air of sulphur and foreign metals present in it; secondly, in the addition of refining flux, with the production of *dry* copper, or copper *at tough pitch*. Commonly a flux of three parts by measure of tartar, two of nitre, and a little salt is melted in the crucible employed for the previous operation, and into it the button of coarse copper is dropped; the surface of the fused copper having become clear of oxides, a little refining flux is now added, and in about a couple of minutes the contents of the crucible are transferred to the mould. (5) The slags from the two last operations are mixed with tartar or charcoal and fused; and the weight of the small prills or shots of copper obtained is ascertained. Assaying by the wet way is usually conducted by treating a weighed sample of the ore with nitric acid, neutralizing with ammonia, and adding standard solution of potassium-cyanide till the blue color of the liquid is discharged, copper-ammonium-cyanide, free ammonium-cyanide, ammonium-formate, and urea being produced. Silver, nickel, cobalt, and zinc may interfere with the estimation of the copper by this method; the first may be removed by adding a little hydrochloric acid; from the three other metals the copper can be freed by precipitating it as sulphide by means of sodium thio-sulphate, the sulphide obtained being decomposed by nitric acid, and the copper estimated by ammonia and potassium cyanide in the usual manner. Before analysis by the wet way it is often advisable to roast the copper ore in order to expel sulphur. Steinbeck's process for determining the amount of copper in poor ores and schists consists in the treatment of the pulverized rock with hydrochloric acid, digestion in the cold, subsequent boiling with nitric acid, precipitation of the copper from the resulting solution by zinc in presence of platinum, and finally the titration of a solution of the precipitated copper. Dr. Haen's method of estimation is based upon the formation of free iodine when excess of potassium iodide is mixed with solution of a copper salt,—the sulphate, for example. Copper is estimated gravimetrically in the metallic state, as in Lucknow's electrolytical process; as cuprous sulphide,  $\text{Cu}_2\text{S}$ , which may be obtained by heating cupric sulphide,  $\text{CuS}$ , in a current of hydrogen, or a mixture of cuprous sulpho-cyanate,  $\text{Cu}_2(\text{CNS})_2$ , with sulphur; and as cupric oxide, prepared by igniting the precipitate of hydrate,  $\text{Cu}(\text{OH})_2$ , formed when potash or soda is added to solutions of cupric salts. Before the blowpipe, copper compounds give with microcosmic salt or borax a green bead, which becomes blue on cooling; when ignited on charcoal in the inner flame with sodium carbonate and cyanide, they afford scales of metallic copper; most of them, also, when heated in the inner, impart to the outer flame a brilliant green coloration.

For further details as to the chemistry of copper see CHEMISTRY, vol. v. pp. 458, 459.

**COPPERAS** (French, *couperose*; Latin, *cupri rosa*, the flower of copper), melanterite, green-vitriol, or ferrous sulphate, is a salt of iron of the composition  $\text{FeSO}_4 \cdot 7\text{H}_2\text{O}$ . It has a bluish-green color and an astringent, inky, and somewhat sweetish taste. It crystallizes in oblique rhombic prisms of the monoclinic system, but generally occurs reniform, botryoidal, incrusting, stalactitic, pulverulent, or massive in nature. It is readily dissolved by water, but is insoluble in alcohol. On exposure to the air it effloresces slightly, and if moist becomes coated with a basic ferric sulphate having, according to Berzelius, the formula  $2\text{Fe}_2\text{O}_3 \cdot \text{SO}_3$ , or  $\text{Fe}_2(\text{SO}_4)_3 \cdot 5\text{Fe}_2\text{O}_3$ . If precipitated from its aqueous solution by alcohol, copperas does not readily absorb oxygen. When heated to  $114^\circ \text{C}$ . it loses six molecules of water, but the last molecule is not given up at a temperature of  $280^\circ \text{C}$ . Copperas is frequently found in metaliferous mines, being produced by the oxidation of marcasite and iron pyrites,  $\text{FeS}_2$ , in a damp atmosphere. The oxidation of the pyrites of coal to ferrous sulphate tends to promote the disintegration of the coal; occasionally, in



the presence of shale, it gives rise to the formation of finely-crystallized "feather-alum,"  $\text{FeAl}_2(\text{SO}_4)_4 \cdot 24\text{H}_2\text{O}$ . Copperas is manufactured, with alum, by the oxidation of the iron pyrites contained in aluminous schists, such as those of the Coal-measures of Renfrew and Lanark (see ALUM, vol. i. p. 568). It may also be prepared by Spence's method of heating ground puddling-furnace slag, tap-cinder, or Cleveland or black-band ironstone with sulphuric acid. A factory for making copperas from the pyritous nodules of the clay of the Island of Sheppey is said to have been established at Queenborough by Matthias Falconer, a Brabanter, in 1597.

Copperas is used in dyeing and tanning, in the manufacture of ink, Prussian blue, and Nordhausen sulphuric acid or fuming oil of vitriol, in medicine as an astringent and tonic, and in analytical chemistry. In the 13th century it was in request for sheep-dressing. When calcined it yields first a white salt,  $\text{FeSO}_4 \cdot \text{H}_2\text{O}$ , the *ferris sulphas essiccata* of pharmacy, and finally brownish-red ferric oxide or colcothar of vitriol (*colcothar vitrioli*, *caput mortuum*, or *crocus Martis*), employed as a paint and polishing-powder. Colcothar may also be prepared by calcining a mixture of 100 parts by weight of copperas with 42 of common salt, and washing out the resulting sodium sulphate. Jeweller's rouge or plate-powder is the washed and calcined precipitate of ferric oxide obtained by adding solution of sodium carbonate to solution of copperas.

**COPROLITES** (from *κόπρος*, dung, *λίθος*, stone), the fossilized excrements of extinct animals. The discovery of their true nature was made by Dr. William Buckland, who observed that certain convoluted bodies occurring in the Lias of Gloucestershire had the form which would have been produced by their passage in the soft state through the intestines of reptiles or fishes. These bodies had long been known as "fossil fir cones" and "bezoar stones." Buckland's conjecture that they were of faecal origin, and similar to the *album græcum* or excrement of hyenas, was confirmed by Dr. Prout, who on analysis found they consisted essentially of calcium phosphate and carbonate, and not unfrequently contained fragments of unaltered bone. The name "coprolites" was accordingly given to them by Buckland, who subsequently expressed his belief that they might be found useful in agriculture on account of the calcium phosphate they contained. The Liassic coprolites are described by Buckland as resembling oblong pebbles, or kidney potatoes; they are mostly 2 to 4 inches long, and from 1 to 2 inches in diameter, but those of the larger Ichthyosauri are of much greater dimensions. In color they vary from ash-grey to black, and their fracture is conchoidal. Internally they are found to consist of a lamina twisted upon itself, and externally they generally exhibit a tortuous structure, produced, before the cloaca was reached, by the spiral valve of a compressed small intestine (as in skates, sharks, and dog-fishes); the surface shows also vascular impressions and corrugations due to the same cause. Often the bones, teeth, and scales of fishes are to be found dispersed through the coprolites, and sometimes the bones of small Ichthyosauri, which were apparently a prey to the larger marine saurians. Coprolites have been found at Lyme Regis, enclosed by the ribs of Ichthyosauri, and in the remains of several species of fish; also in the abdominal cavities of a species of fossil fish, *Macropoma Mantelli*, from the chalk of Lewes. Professor Jäger has described coprolites from the alum-slate of Gaildorf in Würtemberg, assigned by him to the Keuper formation; and the fish-coprolites of Burdighouse and of Newcastle-under-Lyme are of Carboniferous age. The so-called "beetle-stones" of the coal-formation of Newhaven, near Leith, which have mostly a coprolitic nucleus, have been applied to various ornamental purposes by lapidaries. The name "cololites" (from *κόλον*, the large intestine, *λίθος*, stone) was given by Agassiz to fossil worm-like bodies, found in the lithographic slate of Solenhofen, which he determined to be either the petrified intestines or contents of the intestines of fishes. The bone-bed of Axmouth in Devonshire and Westbury and Aust in Gloucestershire, in the Penarth or Rhetic series of strata, contains the scales, teeth, and bones of saurians and fishes, together with abundance of coprolites; but neither there nor at Lyme Regis is there a sufficient quantity of phosphatic material to render the working of it for agricultural purposes remunerative.

The term coprolites has been made to include all kinds of phosphatic nodules employed as manures, such, for

example, as those obtained from the Coralline and the Red Crag of Suffolk. At the base of the Red Crag in that county is a bed, 3 to 18 inches thick, containing rolled fossil bones, cetacean and fish teeth, and shells of the Crag period, with nodules or pebbles of phosphatic matter derived from the London Clay, and often investing fossils from that formation. These are distinguishable from the grey Chalk coprolites by their brownish ferruginous color and smooth appearance. When ground they give a yellowish-red powder. These nodules were at first taken by Professor Henslow for coprolites; they were afterwards termed by Buckland "pseudo-coprolites." "The nodules, having been imbued with phosphatic matter from their matrix in the London Clay, were dislodged," says Buckland, "by the waters of the seas of the first period, and accumulated by myriads at the bottom of those shallow seas where is now the coast of Suffolk. Here they were long rolled together with the bones of large mammalia, fishes, and with the shells of molluscan creatures that lived in shells. From the bottom of this sea they have been raised to form the dry lands along the shores of Suffolk, whence they are now extracted as articles of commercial value, being ground to powder in the mills of Mr. Laws, at Deptford, to supply our farms with a valuable substitute for guano, under the accepted name of coprolite manure. The phosphatic nodules occurring throughout the Red Crag of Suffolk are regarded by Mr. Prestwich as derived from the Coralline Crag. The Suffolk beds have been worked since 1846; and immense quantities of coprolite have also been obtained from Essex, Norfolk, and Cambridgeshire. The Cambridgeshire coprolites are believed to be derived from deposits of Gault age; they are obtained by washing from a stratum about a foot thick, resting on the Gault, at the base of the Chalk Marl, and probably homotaxeous with the Chloritic Marl. An acre yields on an average 300 tons of phosphatic nodules, value £750. About £140 per acre is paid for the lease of the land, which after two years is restored to its owners re-soiled and levelled. Plicatulae have been found attached to these coprolites, showing that they were already hard bodies when lying at the bottom of the Chalk ocean. The Cambridgeshire coprolites are either amorphous or finger-shaped; the coprolites from the Greensand are of a black or dark brown color; while those from the Gault are greenish-white on the surface, brownish-black internally. Samples of Cambridgeshire and Suffolk coprolite have been found by Voelcker to give on analysis phosphoric acid equivalent to about 55 and 52.5 per cent. of tribasic calcium phosphate respectively (*Journ. R. Agric. Soc. Eng.*, vol. xxi. p. 358, 1860). The following analysis of a saurio-coprolite from Lyme Regis is given by Herapath (*ibid.* vol. xii. p. 91):—

Water.....	3.976
Organic matter.....	2.001
Calcium sulphate.....	3.026
Calcium carbonate.....	28.121
Calcium fluoride.....	not determined.
Calcium and magnesium phosphate.....	58.996
Magnesium carbonate.....	0.423
Aluminic phosphate.....	1.276
Ferric phosphate.....	6.182
Silica.....	0.733
	98.734

An ichthyo-coprolite from Tenby was found to contain 15.4 per cent. of phosphoric anhydride. The pseudo-coprolites of the Suffolk Crag have been estimated by Herapath to be as rich in phosphates as the true ichthyo-coprolites and saurio-coprolites of other formations, the proportion of  $\text{P}_2\text{O}_5$  contained varying between 12.5 and 37.25 per cent., the average proportion, however, being 32 or 33 per cent.

Coprolite is reduced to powder by powerful mills of peculiar construction, furnished with granite and buhr-stones, before being treated with concentrated sulphuric acid. The acid renders it available as a manure by converting the calcium phosphate,  $\text{Ca}_3\text{P}_2\text{O}_8$ , that it contains into the soluble monocalcic salt,  $\text{CaH}_2\text{P}_2\text{O}_8$ , or "superphosphate." The phosphate thus produced forms an efficacious turnip manure, and is quite equal in value to that produced from any other source. The Chloritic Marl in the Wealden district furnishes much phosphatic material, which has been extensively worked at Froyle. In the vicinity of Farnham it contains a bed of "coprolites" of considerable extent, and 2 to 15 feet in thickness. Specimens of

these from the Dippen Hall pits, analyzed by Messrs. Paine and Way, showed the presence of phosphates equivalent to 55.96 of bone-earth (*Journ. R. Agric. Soc. Eng.*, vol. ix., p. 56). Phosphatic nodules occur also in the Chloritic Marl of the Isle of Wight and Dorsetshire, and at Wroughton, near Swindon. They are found in the Lower Greensand, or Upper Neocomian series, in the Atherfield Clay at Stopham, near Pulborough; occasionally at the junction of the Hythe and Sandgate beds; and in the Folkestone beds, at Farnham. At Woburn, Leighton, Ampthill, Sandy, Upware, Wicken, and Potton, near the base of Upper Neocomian iron-sands, there is a band between 6 inches and 2 feet in thickness containing "coprolites;" these consist of phosphatized wood, bones, casts of shells, and shapeless lumps. The coprolitic stratum of the Speeton Clay, on the coast to the N. of Flamborough Head, is included by Prof. Judd with the Portland beds of that formation. In 1864 two phosphatic deposits, a limestone 3 feet thick, with beds of calcium phosphate, and a shale of half that thickness, were discovered by Mr. Hope Jones in the neighborhood of Cwmgyfen, about sixteen miles from Oswestry. They are at a depth of about 12 feet, in slaty shale containing Llandeilo fossils and contemporaneous felspathic ash and scorias. A specimen of the phosphatic limestone analyzed by Voelcker yielded 34.92 per cent. of tricalcic phosphate, a specimen of the shale 72.15 per cent. (*Report of Brit. Assoc.*, 1865).

Herapath, *Chem. Gas.* 1849, p. 449; Buckland, *Geology and Mineralogy*, 4th ed., 1869; Fisher, *Quart. Journ. Geol. Soc.* 1873, p. 52; Teall, *On the Potton and Wicken Phosphatic Deposits* (Sedgwick Prize Essay for 1873), 1875; Bonney, *Cambridgeshire Geology*, 1876.

COPTOS, the modern *Kobt* or *Koft*, a town of Egypt, a short distance from the right bank of the Nile, about 25 miles north-east of Thebes. It is a place of great antiquity, as is proved by the name of Thothmes III. still extant on a granite pillar, but its ruins for the most part belong to a comparatively late period. After the foundation of the port of Berenice on the Red Sea in 286 B. C., its position on the caravan line raised it to great commercial prosperity; but in 292 A. D., its share in the rebellion against Diocletian led to an almost total devastation. It again appears, however, as a place of importance, and as the seat of a considerable Christian community, though the stream of traffic turned aside to the neighboring Koos. During part of the 7th century it was called Justinianopolis in honor of the Emperor Justinian.

COPTS, the name given to the descendants of the native inhabitants of Egypt after the Mahometan conquest, supposed by some to be descended from the ancient Egyptians or else from the mixed race which inhabited the country under the Roman empire. They are Christians, and are said to comprise less than one fourteenth of the whole population. Although numerous, their numbers continue to dwindle, and they are being gradually, by marriage or conversion, absorbed in the Mussulman population of the country. Their name, Kubi, or Kubti, is supposed to be derived either from *Ægyptos* or *Egypt*, or else from the town of Coptos, or even Iakobital. Although scarcely distinguishable from the other inhabitants, they are said to have large and elongated black eyes, high cheek-bones, the lobe of the ear high, the nose straight and spread at the end, black and curly hair, thick and spread lips, and large chin. In height they are rather under the middle size; they have in general little *embonpoint*, slender limbs, and pale or bronze complexion, and a sullen expression; but they differ considerably, those who have embraced Roman Catholicism resembling more Greeks or Syrians, while the others of the Said retain their primitive type. Their dress is like that of the Mahometans, except that their turban is of a black-greyish or light-brown color, and they often wear a black coat or gown over their other dress. In their general customs they follow the rules of the other inhabitants; the women veil their faces, both in public and at home when male visitors are present. In religion they are followers of the Eutychedian heresy or Jacobite sect, so called from Jacobus Baradaeus, a Syrian, who propagated the doctrine; and in 1840 there were 150,000 of this sect, while 5000 were said to be Roman Catholics, and as many of the Greek faith. The Jacobites are monophysites and monothelites. They have altogether about 130 churches or convents. Their religious orders

are a patriarch, a metropolitan of the Abyssinians, bishops, arch-priests, priests, deacons, and monks. The "patriarch," called "of Alexandria," resides at Cairo, and is generally chosen by lot out of eight or nine monks of the convent of St. Antony in the eastern desert designated as capable of filling the office, but he may be appointed by his predecessor. The metropolitan is appointed by the patriarch, and the twelve bishops are selected by preference from the monks. They generally baptize their children within the year, and some circumcise them about eight years of age; this rite was evidently handed down by their ancestors, as it is represented in Egyptian sculptures of the Pharaonic period. In their schools the Coptic language is taught imperfectly. In their prayers appear to be many repetitions, and they pray in this manner riding or walking. Their churches are divided into five compartments, the most important of which is the chancel (*heykel*). They observe many fasts and festivals, and some perform pilgrimages to Jerusalem. They also abstain from parts of the flesh of the pig and camel, and from that of animals which have been strangled, and from blood. They do not perform military service. In their habits and customs they follow those of the other populations of Egypt; they rarely intermarry with any other sect; in their marriages they employ a go-between, *waket*, and two-thirds of the dowry is settled upon the wife during her life. The marriages take place on Saturday night, and the festivities sometimes are kept up for eight days. At these a singular custom prevails of attaching two cascabels to the wings of two pigeons, whereby the birds fly about till they are giddy, and then placing them in two hollow balls of sugar, each set on a dish; the balls are afterwards broken and the pigeons fly about the room. The preparations for the marriage consist of ablution, a procession of the bride covered with a shawl, attended by musicians, to the house of the bridegroom, stepping over the blood of a slaughtered lamb at the door, the crowning of the bride and bridegroom, and subsequent entertainments, much abridged or even omitted when a widow is married. The etiquette is not to leave the house for a year to pay visits. Divorces are only given for adultery on the part of the wife. The Copts are exceedingly bigoted, prone to be converted to Islamism, sullen, as Ammianus Marcellinus describes the Egyptians, false, faithless, and deceitful, but extremely useful as secretaries and accountants and skilful workmen. In their funeral ceremonies they follow Mussulman customs, but pay special visits on two days of the year to the sepulchres, and give away a slaughtered bullock and other viands. Both in their physical type and in some of their ceremonies they retain a resemblance to their ancestors, the ancient Egyptians.

Seventy years after their conquest by the Mahometans, 640, unsuccessful in revolt, they suffered the persecution of their masters. The monks were branded in the hand, civilians oppressed with heavy taxation, churches demolished, pictures and crosses destroyed, 722-23. A few years later all Copts were so branded. Degrading dresses were imposed upon them, 849-50. Later, under El Hakim, 997, they were compelled to wear heavy crosses and black turbans as an ignominious distinction; churches were destroyed, and many of the Copts converted. In 1301, the blue turban was introduced, but many Copts preferred a change of religion to the adoption of this head-dress. In 1321 a dreadful religious strife, attended by the destruction of churches and mosques and great loss of life, raged at Cairo between the Copts and the Mahometans; but in 1354-55 great numbers embraced Islamism, and they appear to have gradually declined.

The language of the Copts, or so-called Coptic, is that of the last stage of ancient Egyptian civilization, and that in use at the time of the Romans. In the course of centuries the old Egyptian rapidly changed, especially at the time of the 19th dynasty, when foreign conquests and high civilization had introduced into it a number of Semitic words, principally of the Aramesian family. This continued till the time of the 26th dynasty, or about the 7th century B. C., when the old forms had almost died out, and not only a great number of new words but also a difference of structure appeared in the Egyptian, which approached more nearly to the modern Coptic. This continued till the Ptolemies, under whose government a fresh infusion of words (many of them Greek) considerably altered the language, as they displaced the ancient words, and some new gram-

maternal forms appeared; a considerable difference took place in the prefixes and affixes at that period. After the conversion of Egypt to Christianity the old demotic alphabet fell into disuse, and another was substituted—twenty-four letters of the Greek alphabet, to which were added seven others, supposed to be borrowed from the older demotic to represent sounds not found in the Greek. The language was written in this character from the end of the 4th or beginning of the 5th century, in all works relating to Christianity, and in this condition has been handed down to the present day in three different dialects, called the Sahidic or that of Upper Egypt, the Memphitic or that spoken in the neighborhood of Memphis, and the Bashmuri or dialect of the Lake Menzaleh and its environs. Great difference of opinion has prevailed as to the relative antiquity of these dialects, some considering the Memphitic and others the Sahidic to be the most ancient. The Sahidic is softer than the Memphitic, has none of the harder aspirations, and is more intermixed with Greek. It chiefly differs, however, in construction and the use of vowels. The Bashmuri is intermediate between the two, but is softer than the Memphitic, and one great peculiarity is the use of *l* for *r*, which last letter was not known to the ancient Egyptians. The Coptic or Egyptian was in use at the 9th century, but had ceased to be intelligible in Middle Egypt in the 12th. It survived, however, as a spoken dialect till the 17th, an old man who spoke it having died only in 1633. In the Coptic Church, however, it is still in use for the religious services, and is read, although not understood except by an Arabic interpretation or glossary. It is partly studied by the Copts, and an attempt to revive the ancient language was made by the missionary Lieder at Cairo, who founded schools within the last half century. The discovery of the mode of reading hieroglyphs has rehabilitated the Coptic language, and there is no doubt that it is essentially the same as the Egyptian of the time of the Pyramids, and has retained many words of that and succeeding epochs. Like the Egyptian it is intermediate between the Aryan and Semitic languages in its *copia verborum*, and partly resembles the Semitic in its construction, in which, however, it is more closely allied to the African languages than the older Egyptian, while it differs greatly in the *copia verborum* from them. The Psalms and some other portions of the Scriptures had been translated into Coptic as early as Pachomius, 303, and from that time a succession of works, chiefly religious, were compiled in it. The commencement of the knowledge of Coptic in modern Europe is due to Kircher, who published his *Prodromus Coptus* in 1636. He was followed by Blumberg, who compiled a grammar, called *Fundamenta Lingue Coptice*, in 1716. A Copt, named Tuki, bishop of Arsinoe, gave out another, the *Budimenta Lingue Coptice*, in 1778, in Arabic and Latin, but still in a very uncritical condition. Scholz's grammar, edited by Woide in the same year, was a remarkable work for the time; in 1783 Calusius published another grammar; but these chiefly related to the Memphitic dialect, the Sahidic being imperfectly known, and the Bashmuri quite unknown,—the first grammar of the three dialects being that of Tattam in 1830. Another more critical grammar, prepared by Champollion, was edited by Rosellini and Ungarelli, and another by Peyron in 1841, which was succeeded by the work of Schwartz in 1847. The literature chiefly consists of religious works,—the Pentateuch, Psalms, Kings, minor prophets, and book of Daniel, existing in Coptic, and few fragments in Sahidic of the book of Chronicles, and several unedited portions in that dialect. Besides these several of the apocryphal gospels and some Gnostic works, as the *Pistis Sophia*, are found in the same language; the Acts of the Apostles, sermons, homilies, martyrologies, and many liturgical compositions, and Acts of Councils occur. A great mine of this literature is found in the *Catalogus Codicum Copticoorum Manuscriptorum in Museo Borgiano*, 4to, Romæ, 1810, and other sources. A great number of fragmentary inscriptions on calcareous stone or pottery, chiefly found at Elephantine, exist in the different museums of Europe. Altogether the Coptic literature is not interesting to general students beyond the relation it bears to the ancient Egyptian and its connection with exegetical theology.

Clot-Bey, *Aperçu générale sur l'Égypte* (Paris, 1840, pp. 158, 243); Lane, *The Modern Egyptians* (8vo, Lond., 1860, p. 529); Peyron, *Grammatica Lingue Coptice introductio*, 1841; Quatre-

mère, *La langue et la littérature de l'Égypte*, 1808; Pritchard, *Physical History of Mankind*, Lond., 1875, p. 202, foll. (s. v.)

COPYHOLD, in English law, is an ancient form of land tenure, legally defined as a "holding at the will of the lord according to the custom of the manor." Its origin is to be found in the occupation by villani, or non-freemen, of portions of land belonging to the manor of a feudal lord. In the time of the Domesday survey the manor was in part granted to free tenants, in part reserved by the lord himself for his own uses. The estate of the free tenants is the freehold estate of English law; as tenants of the same manor they assembled together in manorial court or court baron, of which they were the judges. The portion of the manor reserved for the lord (the *demesne*, or domain) was cultivated by laborers who were bound to the land (*adscripti glebæ*). They could not leave the manor, and their service was obligatory. These villani, however, were allowed by the lord to cultivate portions of land for their own use. It was a mere occupation at the pleasure of the lord, but in course of time it grew into an occupation by right, recognized first of all by custom, and afterwards by law. This kind of tenure is called by the lawyers *villanagium*, and it probably marks a great advance in the general recognition of the right when the name is applied to lands held on the same conditions not by villeins but by free men. The tenants in villenage were not, like the freeholders, members of the court baron, but they appear to have attended in a humbler capacity, and to have solicited the succession to the land occupied by a deceased father, or the admission of a new tenant who had purchased the good-will, as it might be called, of the holding, paying for such favors certain customary fines or dues. In relation to the tenants in villenage, the court baron was called the customary court. The records of the court constituted the title of the villein tenant, held by copy of the court roll; and the customs of the manor therein recorded formed the real property law applicable to his case. Each manor might have peculiar customs of its own, and as a matter of fact there has been a great variety in the conditions under which copyhold lands are held.

Copyhold had long been established in practice before it was formally recognized by the law. At first it was in fact, as it is now in the fictitious theory of the law, a tenancy at will, for which none of the legal remedies of a freeholder were available. In the reign of Edward IV., however, it was held that a tenant in villenage had an action of trespass against the lord. In this way a species of tenant-right, depending on and strongly supported by popular opinion, was changed into a legal right. The nature of the change is vigorously described by Sir Edward Coke, "As I conjecture in Saxon's sure I am in the Norman's time the copyholders were so far subject to the lord's will, that the lords upon the least occasion (sometimes without any color of reason, only upon discontentment and malice, sometimes again upon sudden fantastic humor, only to make evident to the world the height of their power and authority) would expel out of house and home their poor copyholders, leaving them helpless and remediless by any course of law, and driving them to one by way of petition; but now copyholders stand upon a sure ground; now they weigh not their lord's displeasure and shake at every blast of wind; they eat, drink, sleep securely; only having a special care of the main chance, to perform exactly what duties and services soever their term doth require; then let lord frown the copyholder cares not, knowing himself safe and not within any danger."

While copyhold was thus converted into a legal estate of the same security as any other, it retained and does still retain many incidents characteristic of its historical origin. The life of copyhold assurance, it is said, is custom. Copyhold is necessarily parcel of a manor, and the freehold is said to be in the lord of the manor. The court roll of the manor is the evidence of title and the record of the special law as to fines, quit rents, heriots, &c., prevailing in the manor. When copyhold land is conveyed from one person to another, it is surrendered by the owner to the lord, who by his payment of the customary fine makes a new grant of it to the purchaser. The lord must admit the vendor's nominee, but the form of the conveyance is still that of surrender and re-grant. The lord, as legal owner of the fee-simple of the lands, has a right to all the mines and minerals and to all the growing timber, although the tenant may have planted it himself. Hence it appears

that the existence of copyhold tenures may be traced in some parts of the country by the total absence of timber from such lands, while on freehold lands it grows in abundance. Hence also the popular saying that the "oak grows not except on free land." The copyholder must not commit waste either by cutting down timber, &c., or by neglecting to repair buildings. In such respects the law treats him as a mere lessee,—the real owner being supposed to be the lord. On the other hand, the lord may not enter the land to cut his own timber or open his mines. The limitations of estates usual in respect of other lands, as found in copyhold, become subject of course to the operations of its peculiar conditions as to the relation of lord and tenant. An estate for life, or *pour autre vie* (i. e., for another's life), an estate entail, or in fee-simple, may be carved out of copyhold.

A species of tenure resembling copyhold prevails in some parts of the country under the name of *customary freehold*. The land is held by copy of court-roll, but not by will of the lord. The question has been raised whether the freehold of such lands is in the lord of the manor or in the tenant, and the courts of law have decided in favor of the former. In some instances copyhold for lives alone is recognized, and in such cases the lord of the manor may ultimately, when all the lives have dropped, get back the land into his own hands.

The feudal obligations attaching to copyhold tenure have been found to cause much inconvenience to the tenants, while they are of no great value to the lord. One of the most vexatious of these is the *heriot*, under which name the lord is entitled to seize the tenant's best beast or other chattel in the event of the tenant's death. The custom dates from the time when all the copyholder's property, including the copyholder himself, belonged to the lord, and is supposed to have been fixed by way of analogy to the custom which gave a military tenant's habiliments to his lord in order to equip his successor. Instances have occurred in quite recent times of articles of great value being seized as heriots for the copyhold tenements of their owners. A race horse worth £2000 or £3000 was thus seized. The fine payable on the admission of a new tenant, whether by alienation or succession, is to a certain extent arbitrary, but the courts long ago laid down the rule that it must be reasonable, and anything beyond two years' improved value of the lands they disallowed. The inconvenience caused by these feudal incidents of the tenure has led to a series of statutes, having for their object the conversion of copyhold into freehold.

In 1841 an Act was passed for the commutation of manorial rights in respect of lands of copyhold and customary tenure, and in respect of other lands subject to such rights, and for facilitating the enfranchisement of such land and the improvement of such tenure.

COPYRIGHT is the exclusive right of multiplying for sale copies of works of literature or art, allowed to the author thereof or his assignees. As a recognized form of property it is, compared with others, of very recent origin, being in fact the result of the facility for multiplying copies created by the discovery of printing and kindred arts. Whether it was recognized at all by the common law of England was long a legal question of the first magnitude,—and the reasons for recognizing it, and the extent of the right itself, are not quite clear from controversy even now. The short paragraph in Blackstone may still be read with interest. He thinks that "this species of property, being grounded on labor and invention, is more properly reducible to the head of occupancy than any other, since the right of occupancy itself is supposed by Mr. Locke and many others to be founded on the personal labor of the occupant." But he speaks doubtfully of its existence,—merely mentioning the opposing views, "that on the one hand it hath been thought no other man can have a right to exhibit the author's work without his consent, and that it is urged on the other hand that the right is of too subtle and unsubstantial a nature to become the subject of property at the common law, and only capable of being guarded by positive statutes and special provisions of the magistrate." He notices that the Roman law adjudged that if one man wrote anything on the paper or parchment of another, the writing should belong to the owner of the blank materials, but as to any other property in the works of the understanding the law is silent, and he adds that neither with us in England hath there been (till very

lately) any final determination upon the rights of authors at the common law.

The nature of the right itself, and the reasons why it should be recognized in law, have from the beginning been the subject of bitter dispute. By some it has been described as a monopoly, by others as a kind of property. Each of these words covers certain assumptions from which the most opposite conclusions have been drawn. As a monopoly it is argued that copyright should be looked upon as a doubtful exception to the general law regulating trade, and should at all events be strictly limited in point of duration. As property, on the other hand, it is claimed that it should be perpetual. There would appear to be no harm in describing copyright either as property or monopoly, if care be taken that the words are not used to cover suppressed arguments as to its proper extent and duration. Historically, and in legal definition, there would appear to be no doubt that copyright, as regulated by statute, is a monopoly. The Parliamentary protection of works of art for the period of fourteen years by the 8 Anne c. 19 and later statutes appears, as Blackstone points out, to have been suggested by the exception in the Statute of Monopolies, 21 James I. c. 3. The object of that statute was to suppress the royal grants of exclusive right to trade in certain articles, and to reassert in relation to all such monopolies the common law of the land. Certain exceptions were made on grounds of public policy, and among others it was allowed that a royal patent of privilege might be granted for fourteen years "to any inventor of a new manufacture for the sole working or making of the same." Copyright, like patent right, would be covered by the legal definition of a monopoly. It is a mere right to prevent other people from manufacturing certain articles. But objections to monopolies in general do not apply to this particular class of cases, in which the author of a new work in literature or art has the right of preventing others from manufacturing copies thereof and selling them to the public. The rights of persons licensed to sell spirits, to hold theatrical exhibitions, &c., are also of the nature of monopolies, and may be defended on special grounds of public policy. The monopoly of authors and inventors rests on the general sentiment underlying all civilized law, that a man should be protected in the enjoyment of the fruits of his own labor.

The first Copyright Act in England is 8 Anne c. 19. The preamble states that printers, booksellers, and other persons were frequently in the habit of printing, reprinting, and publishing "books and other writings without the consent of the authors or proprietors of such books and writings, to their very great detriment, and too often to the ruin of them and their families." "For preventing, therefore, such practices for the future, and for the encouragement of learned men to compose and write useful books, it is enacted that the author of any book or books already printed, who hath not transferred to any other the copy or copies of such book or books in order to print or reprint the same, shall have the sole right and liberty of printing such book or books for the term of one-and-twenty years, and that the author of any book or books already composed, and not printed and published, or that shall hereafter be composed, and his assignee, or assignees, shall have the sole liberty of printing and reprinting such book or books for the term of fourteen years, to commence from the day of first publishing the same, and no longer." The penalty for offences against the Act was declared to be the forfeiture of the illicit copies to the true proprietor, and the fine of one penny per sheet, half to the Crown, and half to any person suing for the same. "After the expiration of the said term of fourteen years the sole right of printing or disposing of copies shall return to the authors thereof, if they are then living, or their representatives, for another term of fourteen years." The last provision points to a particular view of the nature of copyright, to which we shall call attention further on. To secure the benefit of the Act registration at Stationers' Hall was necessary. In section 4 is contained the provision that if any person thought the price of a book "too high and unreasonable," he might complain to the archbishop of Canterbury, the lord chancellor, the bishop of London, the chiefs of the three courts at Westminster, and the vice-chancellors of the two universities in England, and to the lord president lord justice general, lord chief baron of the Exchequer, and the rector of the college of Edinburgh in Scotland.

who may fix a reasonable price. Nine copies of each book were to be provided for the royal library, the libraries of the universities of Oxford and Cambridge, the four Scotch universities, Stion College, and the faculty of advocates at Edinburgh. The copyright of the universities was not to be prejudiced by the Act.

It was believed for a long time that this statute had not interfered with the rights of authors at common law. Ownership of literary property at common law appears to have been recognized in some earlier statutes. The Licensing Act, 13 and 14 Car. II. c. 33, prohibited the printing of any work without the consent of the owner on pain of forfeiture, &c. This Act expired in 1679, and attempts to renew it were unsuccessful. The records of the Stationers' Company show that the purchase and sale of copyrights had become an established usage, and the loss of the protection, incidentally afforded by the Licensing Act, was felt as a serious grievance, which ultimately led to the statute of Anne. That statute, as the judges in *Millar v. Taylor* pointed out, speaks of the ownership of literary property as a known thing. One of the petitions in support of the proposed legislation in 1709 states that by common law a bookseller can recover no more costs than he can prove damages. "Besides," it continues, "the defendant is always a pauper, and so the plaintiff must lose his costs of suit. No man of substance has been known to offend in this particular; nor will any ever appear in it." Therefore the confiscation of counterfeit properties is prayed for. And many cases are recorded in which the courts protected copyrights not falling within the periods laid down by the Act. Thus in 1735 the master of the Rolls restrained the printing of an edition of the *Whole Duty of Man*, published in 1657. In 1739 an injunction was granted by Lord Hardwicke against the publication of *Paradise Lost*, at the instance of persons claiming under an assignment from Milton in 1667. The question, however, was raised in the case of *Millar v. Taylor* (4 Burrow, 2303) in 1769, in which the plaintiff, who had purchased the copyright of Thomson's *Seasons* in 1729, claimed damages for an unlicensed publication thereof by the defendant in 1763. The jury found that before the statute it was usual to purchase from authors the perpetual copyright of their works. Three judges, among whom was Lord Mansfield, decided in favor of the common law right; one was of the contrary opinion. The majority thought that the Act of Anne was not intended to destroy copyright at common law, but merely to protect it more efficiently during the limited periods. *Millar v. Taylor*, however, was speedily overruled by the case of *Donaldson v. Beckett* in the House of Lords in 1774. The judges were called upon to state their opinions. A majority (seven to four) were of opinion that the author and his assigns had at common law the sole right of publication in perpetuity. A majority (six to five) were of opinion that this common law right had been taken away by the statute of Anne, and a term of years substituted for the perpetuity. Lord Mansfield did not deliver an opinion, as it was unusual for a peer to support his own judgment on an appeal to the Lords. Lord Camden argued against the existence of a common law right, and on his motion, seconded by the lord chancellor, the decree of the court below was reversed. The decision appears to have taken the trade by surprise. Many booksellers had purchased copyrights not protected by the statute, and they now petitioned Parliament to be relieved from the consequences of the decision in *Donaldson v. Beckett*. A bill for this purpose actually passed the House of Commons, but Lord Camden's influence succeeded in defeating it in the House of Lords. The university copyrights were, however, protected in perpetuity by an Act passed in 1775. The arguments in the cases above mentioned raised the fundamental question whether there can be any property in literary works, and are really arguments for and against the desirability of recognizing the rights on general principles. Lord Camden was the great opponent of copyright, both as a legislator and as a judge. His sentiments may be judged by his answer to the plea that copyright was a reward to men of genius:—"Glory is the reward of science, and those who deserve it scorn all meaner views. I speak not of the scribblers for bread who tease the press with their wretched productions. Fourteen years are too long a privilege for their perishable trash. It was not for gain that Bacon, Newton, Milton, and Locke instructed and delighted the world. When the bookseller offered Milton five pounds for his *Paradise Lost*, he did not

reject it and commit his poem to the flames, nor did he accept the miserable pittance as the reward of his labor; he knew that the real price of his work was immortality, and that posterity would pay it."

The battle of copyright at this time appears to have been fought mainly in the interests of the booksellers, and more particularly of the London booksellers. One member presented petitions from the country booksellers, another from the booksellers of Glasgow against the Booksellers' Copyright Bill. Burke supported the bill, and Fox opposed it. In both Houses the opponents of the bill denounced the booksellers vehemently. Speaking of the Stationers' Company, Lord Camden said, "In 1681 we find a by-law for the protection of their own company and their copyrights, which then consisted of all the literature of the kingdom; for they had contrived to get all the copies into their own hands." Again, owner was the term applied to every holder of copies, and the word author does not occur once in all their entries. "All our learning will be locked up in the hands of the Tonsons and Lintons of the age, who will set that price upon it their avarice chooses to demand, till the public become their slaves as much as their hackney compilers now are. Instead of salesmen the booksellers of late years have forestalled the market, and become engrossers." In the discussions which preceded the last Copyright Act, the interests of the authors are more prominent, but there are still curious traces of the ancient hostility to booksellers. The proceedings both in *Donaldson v. Beckett* and in the Booksellers' Copyright Bill are recorded at considerable length in the *Parliamentary History*, vol. xvii.

By the 41 Geo. III. c. 107 the penalty for infringement of copyright was increased to threepence per sheet, in addition to the forfeiture of the book. The proprietor was to have an action on the case against any person in the United Kingdom, or British dominions in Europe, who should print, reprint, or import without the consent of the proprietor, first had in writing, signed in the presence of two or more credible witnesses, any book or books, or who knowing them to be printed, &c., without the proprietor's consent should sell, publish, or expose them for sale; the proprietor to have his damages as assessed by the jury, and double costs of suit. A second period of fourteen years was confirmed to the author, should he still be alive at the end of the first. Further, it was forbidden to import into the United Kingdom for sale books first composed, written, or printed and published within the United Kingdom, and reprinted elsewhere. Another change was made by the Act 54 Geo. III. c. 156, which in substitution for the two periods of fourteen years gave to the author and his assignees copyright for the full term of twenty-eight years from the date of the first publication, "and also, if the author be living at the end of that period, for the residue of his natural life."

The Copyright Act now in force is the 5 and 6 Vict. c. 45, which repealed the previous Acts on the same subject. The principal clause is the following (§ 3):—"That the copyright in every book which shall after the passing of this Act be published in the lifetime of its author shall endure for the natural life of such author, and for the further term of seven years, commencing at the time of his death, and shall be the property of such author and his assignees; provided always that if the said term of seven years shall expire before the end of forty-two years from the first publication of such book the copyright shall in that case endure for such period of forty-two years; and that the copyright of every book which shall be published after the death of its author shall endure for the term of forty-two years from the first publication thereof, and shall be the property of the proprietor of the author's manuscript from which such book shall be first published and his assigns. The benefit of the enlarged period is extended to subsisting copyrights, unless they are the property of an assignee who has acquired them by purchase, in which case the period of copyright will be extended only if the author or his personal representative agree with the proprietor to accept the benefit of the Act. By section 5 the judicial committee of the Privy Council may license the republication of books which the proprietor of the copyright thereof refuses to publish after the death of the author. The sixth section provides for the delivery within certain times of copies of all books published after the passing of

Existing  
law of  
copyright.

the Act, and of all subsequent editions thereof, at the British Museum. And a copy of every book and its subsequent editions must be sent on demand to the following libraries:—The Bodleian at Oxford, the public library at Cambridge, the Library of the Faculty of Advocates in Edinburgh, and that of Trinity College, Dublin. The other libraries entitled to this privilege under the old Acts had been deprived thereof by an Act passed in 1836, and grants from the treasury, calculated on the annual average value of the books they had received, were ordered to be paid to them as compensation. A book of registry is ordered to be kept at Stationers' Hall for the registration of copyrights, to be open to inspection on payment of one shilling for every entry which shall be searched for or inspected. And the officer of Stationers' Hall shall give a certified copy of any entry when required, on payment of five shillings; and such certified copies shall be received in evidence in the courts as *prima facie* proof of proprietorship or assignment of copyright or license as therein expressed, and, in the case of dramatic or musical pieces, of the right of representation or performance. False entries shall be punished as misdemeanors. The entry is to record the title of the book, the time of its publication, and the name and place of abode of the publisher and proprietor of copyright. Without making such entry no proprietor can bring an action for infringement of his copyright, but the entry is not otherwise to affect the copyright itself. Any person deeming himself aggrieved by an entry in the registry may complain to one of the superior courts, which will order it to be expunged or varied if necessary. A proprietor may bring an action on the case for infringement of his copyright, and the defendant in such an action must give notice of the objections to the plaintiff's title on which he means to rely. No person except the proprietor of the copyright is allowed to import into the British dominions for sale or hire any book first composed or written or printed and published in the United Kingdom, and reprinted elsewhere, under penalty of forfeiture and a fine of £10. The proprietor of any encyclopaedia, review, magazine, periodical work, or work published in a series of books or parts, who shall have employed any person to compose the same, or any volumes, parts, essays, articles, or portions thereof, for publication on the terms that the copyright therein shall belong to such proprietor, shall enjoy the term of copyright granted by the Act.<sup>1</sup> But the proprietor may not publish separately any article or review without the author's consent, nor may the author unless he has reserved the right of separate publication. Where neither party has reserved the right they may publish by agreement, but the author at the end of twenty-eight years may publish separately. Proprietors of periodical works shall be entitled to all the benefits of registration under the Act, on entering in the registry the title, the date of first publication of the first volume or part, and the names of proprietor and publisher. The interpretation clause of the Act defines a book to be every volume, part, or division of a volume, pamphlet sheet of letter-press, sheet of music, map, chart, or plan separately published. The Act is not to prejudice the rights of the universities and the colleges of Eton, Westminster, and Winchester.

The Copyright Act was the result of a Parliamentary movement conducted by Mr. Sergeant Talfourd and afterwards by Lord Mahon. Talfourd's bill of 1841 proposed to extend copyright to a period of sixty years after the author's death. The proposer based his claim on the same grounds as other property rights,—which would of course, as Macaulay pointed out, go to justify a perpetual copyright. He refused to accept any shorter term than sixty years. He was answered by Macaulay in a speech full of brilliant illustration and superficial argument. If copyright is to be regarded, as Macaulay regarded it, as a mere bounty to authors,—a tax imposed upon the public for the encouragement of people to write books,—his opposition to an extended term is not only justified, but capable of being applied to the existence of the right for any period whatever. The system of bounty, or of taxation for the special benefit of any class of citizens, is condemned by the principles of political economy and the practice of modern legislation. But if copyright is defended on the same principles which protect the acquisitions of the individual in other lines of activity, the reasoning of Macaulay and

the opponents of perpetuity is altogether wide of the mark. The use of the phrase perpetual copyright has caused much confusion. A perpetual copyright is precisely the same sort of right, in respect of duration, as a fee-simple in land, or an investment in consolidated bank annuities. When Macaulay therefore says, "Even if I believed in a natural right of property independent of utility and anterior to legislation, I should still deny that this right could survive the original proprietors," his argument applies equally to property in land and in bank annuities. The original purchaser of a bank annuity acquires a right to the receipt of a certain sum every year for ever, and such right he may assign or bequeath to anybody he chooses. The writer of a book, if the law recognized a perpetual copyright, would acquire an exclusive right to the profits of its publication for ever, and might assign or bequeath that right as he chose. In both cases the right survives the owner—if indeed such a phrase can properly be used at all. Again, Macaulay points out that a copyright fifty years after one's death is at the present moment comparatively worthless:—"An advantage to be enjoyed half a century after we are dead, by somebody, we know not whom, perhaps by somebody unborn, by somebody utterly unconnected with us, is really no motive at all to action." No doubt there is a point in the future at which a right coming into existence would for us now living be virtually worth nothing. But this is true of all rights, and not merely of the rights called copyright; and this reasoning would justify the cutting off at some point in the future of all individual rights of property whatever. The present value of a right to rent, a right to annuities, and a copyright—to arise a hundred years hence—is probably next to nothing. There may be good reasons for saying now that no such perpetuity of right ought to be recognized, that the state ought to pass a law to take for itself all profits arising out of land, and all annuities from the public funds, from and after the year 1977. The injury done to the present owners would be precisely of the same sort and extent as in the case of a copyright being cut short a hundred years hence. Macaulay asks, "Would a copyright for sixty years have roused Dr. Johnson to any vigorous effort, or sustained his spirits under depressing circumstances?" A sixty years' copyright, or a perpetual copyright, would have been to Dr. Johnson in his last days of the same value as a sixty years' lease or a fee-simple respectively of property yielding the same amount of income. Again, says Macaulay, the property would be certain to leave the author's family; the monopoly would fall into the hands of a bookseller. The same thing may be said of all property that is assignable; and if there is any good reason for preventing the assignment of property in certain circumstances, whether by a law of entail or otherwise, that reason may be urged in the case of copyright with the same force, and only with the same force, as in the case of land. The old animus against the bookseller is still apparent in such objections as the last.

A former Copyright Act, as we have already noticed, gave the author two periods of fourteen years, the second to be conditional on his surviving the first. The object of this enactment is evidently to prevent the copyright from falling into the hands of a bookseller. The legislature appears to have deemed authors incapable of managing their own affairs. To prevent them from being made the victims of unscrupulous publishers they put it out of their power to assign the entire copyright, by making the second period a mere contingency. It was forgotten that future profits have a present money value, and that if an author sells his copyright for its fair market value, as he surely may be left to do, he reaps the advantage of the entire period of copyright as completely as if he remained the owner to the end. From this point of view the condition attached to the second period was a positive hardship to the author, inasmuch as it gave him an uncertain instead of a certain interest. It is the difference between an assignable annuity for a certain period of twenty-eight years, and two assignable annuities for fourteen years—the second only to come into existence if the original annuitant survives the first period. The same fallacy lurks under Talfourd's complaint that as copyright is usually drawing towards an end at the close of the author's life, it is taken away at the very time when it might be useful to him in providing for his family. But if the period fixed is otherwise a fair period, the

<sup>1</sup> Such articles must be paid for, in order to vest copyright in the proprietor of the periodical.

future of the author's family is an irrelevant consideration. He has, by supposition, the full property rights to which he is entitled, and he may sell them or otherwise deal with them as he pleases, and he will make provision for his family as other men do for theirs. Nothing short of a strict Entail Act can keep copyright, any more than other property, in his or his family's possession. The attempt to do this by making the latter portion of the period conditional has disappeared from legislation, but the same fallacy remains in the objections urged against long terms of copyright. What would be a fair term may depend on a variety of considerations, but the chance or certainty of copyrights becoming publishers' property is certainly not one of them.

Macaulay's speech convinced the House of Commons, and Talfourd's bill was defeated. Lord Mahon's bill in 1842 reduced the proposed period to twenty-five years after death; Macaulay proposed forty-two as the fixed number in all cases. It was at Macaulay's suggestion that the clause against the possible suppression of books by the owners of copyright was introduced. Under a longer period of copyright the danger apprehended might possibly become a real one; at present we are not aware of any complaint having been made to the judicial committee under this section.

The preceding narrative records the changes in the law of copyright in books only. In the meantime the principle had been extended to other forms of mental work. The 8 Geo. II. c. 18 is an Act "for the encouragement of the arts of designing, engraving, and etching historical and other prints by vesting the properties thereof in the inventors and engravers during the time therein mentioned." It gave to every person who should "invent and design, engrave, etch, or work in mezzotint or chiaro-oscuro, or from his own works and invention should cause to be designed and engraved, etched, or worked in mezzotint or chiaro-oscuro, any historical or other print or prints, which shall be truly engraved with the name of the proprietor on each plate and printed on every such print or prints," a copyright for fourteen years—the period fixed by the statute of Anne,—and inflicts a penalty on those who engrave, &c., as aforesaid, without the consent of the proprietor. The 7 Geo. III. c. 38 extended the protection to those who should engrave, &c., any print taken from any picture, drawing, model, or sculpture, either ancient or modern, in like manner as if such print had been graven or drawn from the original design of such graver, etcher, or draughtsman; and in both cases the period is fixed at twenty-eight instead of fourteen years. Ten years later a further remedy was provided by giving a special action on the case against persons infringing the copyright. By the 38 Geo. III. c. 71 the sole right of making models and casts was vested in the original proprietor for the period of fourteen years.

**Stage right.** Stage right was first protected by the 3 and 4 Will. IV. c. 15, which provided that the author (or his assignee) of any tragedy, comedy, play, opera, farce, or other dramatic piece or entertainment composed, or which should thereafter be composed, and not printed or published by the author, should have as his own property the sole liberty of representing or causing to be represented at any place of dramatic entertainment in the British dominions any such production, and should be deemed the proprietor thereof; and that the author of any such production printed and published within the ten years preceding the passing of the Act, or which should thereafter be so published, should have sole liberty of representation for twenty-eight years from the passing of the Act, or the first publication respectively, and further during the natural life of the author if he survived that period.

The publication of lectures without consent of the authors or their assignees is prohibited by 5 and 6 Will. IV. c. 65. This Act excepts from its provisions—(1) lectures of which notice has not been given two days before their delivery to two justices of the peace living within five miles of the place of delivery, and (2) lectures delivered in universities and other public institutions. Sermons by clergy of the Established Church are believed to fall within this exception.

**Music.** Musical compositions are protected by a section of the Copyright Act 5 and 6 Vict. c. 45 above mentioned. The increased period of copyright fixed by that Act is extended to the right of representing dramatic pieces and musical compositions—the first

public representation or performance being the equivalent of the first publication of a book. In such cases the right of representation is not conveyed by the assignment of the copyright only.

Lithographs, hitherto a doubtful subject, were brought within the provisions relating to prints and engravings by a clause of the 15 and 16 Vict. c. 12.

Lithographs.

Lastly, in 1862, an Act was passed, 25 and 26 Vict. c. 68, by which the author of every original painting, drawing, and photograph, and his assigns, obtained the exclusive right of copying, engraving, reproducing, and multiplying it, and the design thereof, for the term of the natural life of the author and seven years after his death. The Acts relating to copyright of designs will be noticed below.

Copies of painting.

We may now notice a few of the more important principles developed and applied by courts of justice in administering the law of copyright. One of them is that there can be no copyright in any but innocent publications. Books of an immoral or irreligious tendency have been repeatedly decided to be incapable of being made the subject of copyright. In a case (*Lawrence v. Smith*) before Lord Eldon, an injunction had been obtained against a pirated publication of the plaintiff's *Lectures on Physiology, Zoology, and the Natural History of Man*, which the judge refused to continue, "recollecting that the immortality of the soul is one of the doctrines of the Scriptures, and considering that the law does not give protection to those who contradict the Scriptures." The same judge refused in 1822 to restrain a piracy of Lord Byron's *Cain*, and *Don Juan* was refused protection in 1823. It would appear from a recent case, arising out of a different subject matter,<sup>1</sup> that the courts are still disposed to enforce these principles. To refuse copyright in such cases is futile as a mode of punishment or repression, inasmuch as it directly opens up a wider circulation to the objectionable works. When the authorship of a book is misrepresented with intent to deceive the public, copyright will not be recognized.

Immoral publications.

The writer of private letters sent to another person may in general restrain their publication. It was urged in some of the cases that the sender had abandoned his property in the letter by the act of sending; but this was denied by Lord Hardwicke, who held that at most the receiver only might take some kind of joint property in the letter along with the author. Judge Story, in the American case of *Folsom v. Marsh*, states the law as follows:—"The author of any letter or letters, and his representatives, whether they are literary letters or letters of business, possess the sole and exclusive copyright therein; and no person, neither those to whom they are addressed, nor other persons, have any right or authority to publish the same upon their own account or for their own benefit." But there may be special occasions justifying such publication.

Private letters.

A kind of property in unpublished works, not created by the copyright Acts, has been recognized by the courts. The leading case on the subject is *Prince Albert v. Strange* (2 *De Gea and Smale's Reports*). Copies of etchings by the Queen and Prince Albert, which had been lithographed for private circulation, fell into the hands of the defendant, a London publisher, who proposed to exhibit them, and issued a catalogue entitled *A Descriptive Catalogue of the Royal Victoria and Albert Gallery of Etchings*. The Court of Chancery restrained the publication of the catalogue, holding that property in mechanical works, or works of art, does certainly subsist, and is invaded, before publication, not only by copying but by description or catalogue.

Unpublished works.

The question what is a piracy against copyright has been the subject of much discussion in the courts. It was decided under the statute of Anne that a repetition from memory was not a publication so as to be an infringement of copyright. In the recent case of *Reade v. Comquest* the same view was taken. The defendant had "dramatized" the plaintiff's novel, and the piece was performed at his theatre. This was held to be no breach of copyright; but the circulation

What constitutes piracy.

<sup>1</sup> *Cowan v. Milbourn, Law Reports, 2 Exchequer 230*, in which it was held that a contract to let a room for lectures might be broken by the lessor on finding that the proposed lectures were of an irreligious, blasphemous, and illegal character.

of copies of a drama, so taken from a copyright novel, whether gratuitously or for sale, is not allowed. Then again it is often a difficult question to decide whether the alleged piratical copyright does more than make that fair use of the original author's materials which the law permits. It is not every act of borrowing literary matter from another which is piracy, and the difficulty is to draw the line between what is fair and what is unfair. Lord Eldon put the question thus,—whether the second publication is a legitimate use of the other in the fair exercise of a mental operation deserving the character of an original work. Another test proposed is “whether you find on the part of the defendant an *animus furandi*—an intention to take for the purpose of saving himself labor.” No one, it has been said, has a right to take, whether with or without acknowledgment, a material and substantial portion of another's work, his arguments, his illustrations, his authorities, for the purpose of making or improving a rival publication. When the materials are open to all, an author may acquire a copyright in his selection or arrangement of them. Several cases have arisen on this point between the publishers of rival directories. Here it has been held that the subsequent compiler is bound to do for himself what the original compiler had done. When the materials are thus *in medio*, as the phrase is, it is considered a fair test of piracy to examine whether the mistakes of both works are the same. If they are, piracy will be inferred. Translations stand to each other in the same relation as books constructed of materials in common. The *animus furandi*, mentioned above as a test of piracy, does not imply deliberate intention to steal; it may be quite compatible with ignorance even of the copyright work. This is shown by the case of *Reade v. Lacy*. The plaintiff wrote a drama called *Gold*, and founded on it a novel called *Never too Late to Mend*. The defendant dramatized the novel,—his play reproducing scenes and incidents which appeared in the original play. The vice-chancellor, presuming that the defendant had a right to dramatize the novel, found that the second play was an infringement of the copyright in the first. Abridgments of original works appear to be favored by the courts—when the act of abridgment is itself an act of the understanding, “employed in carrying a large work into a smaller compass, and rendering it less expensive.” Lord Hatherly, however, in *Tinsley v. Lacy*, incidentally expressed his disapproval of this feeling,—holding that the courts had gone far enough in this direction, and that it was difficult to acquiesce in the reason sometimes given that the compiler of an abridgment is a benefactor to mankind by assisting in the diffusion of knowledge. A mere selection or compilation, so as to bring the materials into smaller space, will not be a *bona fide* abridgment; “there must be real substantial condensation, and intellectual labor, and judgment bestowed thereon” (Justice Story). A publication professing to be *A Christmas Ghost Story, Reoriginated from the Original by Charles Dickens, Esq., and Analytically Condensed expressly for this Work*, was found to be an invasion of Mr. Dickens's copyright in the original. In the case of a musical composition Lord Lyndhurst held that it is piracy when the appropriated music, though adapted to a different purpose, may still be recognized by the ear. The quasi-copyright in names of books, periodicals, &c., is founded on the desirability of preventing one person from putting off on the public his own productions as those of another. The name of a journal is a species of trade-mark on which the law recognizes what it calls a “species of property.” The *Wonderful Magazine* is invaded by a publication calling itself the *Wonderful Magazine, New Series Improved*. *Bell's Life in London* is pirated by a paper calling itself the *Penny Bell's Life*. So the proprietors of the *London Journal* got an injunction against the *Daily London Journal*, which was projected by the person from whom they had bought their own paper, and who had covenanted with them not to publish any *weekly* journal of a similar nature. A song published under the title of *Minnie*, sung by Madame Anna Thillon and Miss Dolby at Monsieur Jullien's concerts, was invaded by a song to the same air published as *Minnie Dale, Sung at Jullien's Concerts by Madame Anna Thillon*.

Relation of copyright and stage-right.

Dramatic and musical compositions, it should be observed, stand on this peculiar footing, that they may be the subject of two entirely distinct rights. As writings they come within the gen-

eral Copyright Act, and the unauthorized multiplication of copies is a piracy of the usual sort. This was decided to be so even in the case of musical compositions under the Act of Anne. The Copyright Act now includes a “sheet of music” in its definition of a book. Separate from the copyright thus existing in dramatic or musical compositions is the right of representing them on the stage; this was the right created by 3 and 4 Will. IV. c. 15, above mentioned in the case of dramatic pieces. The Copyright Act, 5 and 6 Vict. c. 45, extended this right to musical compositions, and made the period in both cases the same as that fixed for copyright. And the Act expressly provides (meeting a contrary decision in the courts), that the assignment of copyright of dramatic and musical pieces shall not include the right of representation unless that is expressly mentioned. The 3 and 4 Will. IV. c. 15 prohibited representation “at any place of public entertainment,” a phrase which has been omitted in the later Act, and it may perhaps be inferred that the restriction is now more general and would extend to any unauthorized representation anywhere. A question has also been raised whether, to obtain the benefit of the Act, a musical piece must be of a dramatic character. The dramatization of a novel—i. e., the acting of a drama constructed out of materials derived from a novel—is not an infringement of the copyright in the novel, but to publish a drama so constructed has been held to be a breach of copyright (*Tinsley v. Lacy*, where defendant had published two plays founded on two of Miss Braddon's novels, and reproducing the incidents and in many cases the language of the original). Where two persons dramatize the same novel, what, it may be asked, are their respective rights? In *Toole v. Young* (9 Q. B., 523) this point actually arose. A. the author of a published novel, dramatized it and assigned the drama to the plaintiff, but it was never printed, published, or represented upon the stage. B, ignorant of A's drama, also dramatized the novel and assigned his drama to the defendant, who represented it on the stage. It was held that any one might dramatize A's published novel, and that the representation of B's drama was not a representation of A's drama. This case may be compared with *Reade v. Lacy* mentioned above.

For preventing the importation of pirated copies of books the commissioners of customs are required to make out a list of books on which copyright subsists, and of which they have received notice from the owner or his agent, and such lists are to be exposed at the ports of the United Kingdom. If notice is not sent the importation of books will not be interfered with. If any one wrongfully causes a book to be entered on the custom lists, any one injured thereby may apply to a judge in chambers to have the entry expunged.

Importation of pirated works.

Newspapers stand at present on a somewhat peculiar footing with reference to the law of copyright. Their position was put in issue in the case of *Cox v. the Land and Water Journal Company* (*Law Reports*, 9 Eq. 324), in which the plaintiff sought to restrain the defendant from publishing a “List of Hounds” taken from plaintiff's paper—the *Field*. It was argued that there was no copyright in a newspaper article, or, if there were, that it was lost by non-registration. Vice-Chancellor Malins held that a newspaper is not within the copyright Acts, that therefore the rules as to non-registration do not apply, and that the proprietor of a paper acquires such a property (not copyright) in every article for which he pays under the 18th section of the Act, or by the general rules of property, as will entitle him to prohibit any other person from publishing the same thing in any other newspaper. The substantial justice of this decision is beyond impeachment, but as a matter of law it is by no means satisfactory. The right to prohibit publication is copyright and nothing else, and it is difficult to see how it can be enjoyed at all outside the Copyright Act, or how, if it is acquired in virtue of compliance with any of the provisions of the Act, it can avoid forfeiture as a penalty for non-registration. It is highly improbable that this decision would be confirmed, should the question ever come before a higher court. The property of a newspaper, i. e., the good-will of printing and publishing it, and the exclusive right to its title, are not rights of the same nature as copyright.

Newspapers.

A special kind of perpetual copyright in various publi-



Crown and  
university  
copyrights.

cations has for various reasons been recognized by the law (1) in the Crown and (2) in the universities and colleges. The various copyright Acts, including the last, except from their provisions the copyrights vested in the two English and the four Scotch universities, Trinity College, Dublin, and the colleges of Eton, Westminster, and Winchester. Crown copyrights are saved by the general principle which exempts Crown rights from the operation of statutes unless they are expressly mentioned. Among the books in which the Crown has claimed copyright are the English translation of the Bible, the Book of Common Prayer, statutes, orders of Privy Council, proclamations, almanacs, Lilly's Latin Grammar, year books, and law reports. The copyright in the Bible is rested by some on the king's position as head of the church; Lord Lyndhurst rested it on his duties as the chief executive officer of the state charged with the publication of authorized manuals of religion. The right of printing the Bible and the Book of Common Prayer is vested in the queen's printer and the universities of Oxford and Cambridge. These copyrights do not extend to prohibit independent translations from the original. The obsolete copyright of the Crown in Lilly's Latin Grammar was founded on the fact of its having been drawn up at the king's expense. The universities have a joint right (with the Crown's patentees) of printing Acts of Parliament. Law reports were decided to be the property of the Crown in the reign of Charles II.; by Act of Parliament they were forbidden to be published without license from the chancellor and the chiefs of the three courts, and this form of license remained in use after the Act had expired. The courts still maintain their right to restrain the publication of reports of their proceedings, but on quite other grounds than those pertaining to the law of copyright. University and college copyrights are made perpetual by an Act of George III., but only on condition of the books being printed at their printing-presses and for their own benefit.

The rights of foreigners under the copyright Acts produced an extraordinary conflict of judicial opinion in the English courts. A foreigner who during residence in the British dominions should publish a work was admitted to have a copyright therein. The question was whether residence at the time of publication was necessary. In *Cocks v. Purday*, the Court of Common Pleas held that it was not. In *Boosey v. Davidson*, the Court of Queen's Bench, following the decision of the Court of Common Pleas in *Cocks v. Purday*, held that a foreign author might have copyright in works first published in England, although he was abroad at the time of publication. But the Court of Exchequer, in *Boosey v. Purday*, refused to follow these decisions, holding that the legislature intended only to protect its own subjects,—whether subjects by birth or by residence. The question came before the House of Lords on appeal in the case of *Boosey v. Jeffreys*, in which the Court of Exchequer had taken the same line. The judges having been consulted were found to be divided in opinion. Six of them held that a foreigner resident abroad might acquire copyright by publishing first in England. Four maintained the contrary. The views of the minority were affirmed by the House of Lords (Lord Chancellor Cranworth and Lords Brougham and St. Leonards). The lord chancellor's opinion was founded upon "the general doctrine that a British senate would legislate for British subjects, properly so called, or for such persons who might obtain that character for a time by being resident in this country, and therefore under allegiance to the Crown, and under the protection of the laws of England." Lord Brougham said that

"The statute of Anne had been passed for the purpose of encouraging learned men, and with that view that Act had given them the exclusive right in their publications for twenty-one years. This, however, was clear, they had no copyright at common law, for if they had there would have been no necessity for the passing of that statute. It could scarcely be said that the legislature had decided a century and a half since that an Act was to be passed to create a monopoly in literary works solely for the benefit of foreigners. In the present case he was clearly of opinion that the copyright did not exist, and therefore that foreign law should not prevail over British law where there was such diversity between the two."

Against the authority of this case, however, must be

set the opinion of two of the greatest lawyers who have occupied the woolsack in this generation—Lord Cairns and Lord Westbury. In the case of *Routledge v. Low* (*Law Reports*, 3 House of Lords, 100) Lord Cairns said,

"The aim of the legislature is to increase the common stock of the literature of the country; and if that stock can be increased by the publication for the first time here of a new and valuable work composed by an alien who has never been in the country, I see nothing in the wording of the Act which prevents, nothing in the policy of the Act which should prevent, and everything in the professed object of the Act and in its wide and general provisions which should entitle such a person to the protection of the Act, in return and compensation for the addition he has made to the literature of the country."

And Lord Westbury said in the same case,

"The case of *Jeffreys v. Boosey* is a decision which is attached to and depends on the particular statute of which it was the exponent, and as that statute has been repealed and is now replaced by another Act, with different enactments expressed in different language, the case of *Jeffreys v. Boosey* is not a binding authority in the exposition of this later statute. The Act appears to have been dictated by a wise and liberal spirit, and in the same spirit it should be interpreted, adhering of course to the settled rules of legal construction. The preamble is, in my opinion, quite inconsistent with the conclusion that the protection given by the statute was intended to be confined to the works of British authors. The real condition of obtaining its advantages is the first publication by the author of his work in the United Kingdom. Nothing renders necessary his bodily presence here at the time, and I find it impossible to discover any reason why it should be required, or what it can add to the merit of the first publication. If the intrinsic merits of the reasoning on which *Jeffreys v. Boosey* was decided be considered, I must frankly admit that it by no means commands my assent."

These conclusions appear to follow also from the recent Naturalization Act of 1870, which enacts that real and personal property of every description may be taken, acquired, held, and disposed of by an alien in the same manner in all respects as by a natural-born British subject. As the latter can acquire copyright by first publication without residence in England, and as copyright is personal property, it would seem that an alien also must have copyright without the necessity of residence. It is quite clear, at all events, that residence in any part of the British dominions—not merely the United Kingdom—is sufficient but the first publication must be in the United Kingdom. But the copyright once created extends to the whole of the British dominions.

Colonial copyright, however, is subject to a special Act, the 10 and 11 Vict. c. 95. Under English copyright books of the United Kingdom were protected in the colonies, and copies of them printed or reprinted elsewhere could not be imported into the colonies. At the same time books published in the colonies are not, as we have just mentioned, within the protection of the Copyright Act. By the Colonial Copyright Act, 10 and 11 Vict. c. 95, it is now enacted that when the legislative authority in any British possession makes proper provision by Act or ordinance for the protection of the rights of British authors, the crown may, by Order in Council, suspend the prohibition against the importation, &c., of foreign reprints of English copyright books, so far as such colony is concerned, and the local Act shall thereupon come into operation. The following colonies have taken advantage of the Act:—New Brunswick, Nova Scotia, Prince Edward's Island, Bermuda, Bahamas, Barbadoes, Canada, St. Lucia, St. Vincent, British Guiana, Mauritius, Jamaica, Newfoundland, Granada, St. Christopher, Antigua, Nevis, Cape of Good Hope, Natal (Shortt).

In 1875 an Act was passed to give effect to an Act of the Parliament of the Dominion of Canada respecting copyright. An Order in Council in 1868 had suspended the prohibition against the importation of foreign reprints of English books into Canada, and the Parliament had passed a Bill on the subject of copyright as to which doubts had arisen whether it was not repugnant to the Order in Council. Her Majesty in Council is therefore authorized to assent to the Canadian Bill (which is printed as a Schedule to the Act); and it is also enacted that, after the Bill comes into operation, if an English copyright book becomes entitled to Canadian copyright, no Canadian reprints thereof shall be imported into the United Kingdom, unless by the owner of the copyright. The following points

in the Canadian Act are worth noting. Any person printing or publishing an unprinted manuscript without the consent of the author or legal proprietor shall be liable in damages (§ 3). Any person domiciled in Canada, or in any part of the British Possessions, or being a citizen of any country having an international copyright treaty with the United Kingdom, who is the author of any book, map, &c., &c.,—shall have the sole right and liberty of printing, reprinting, publishing, &c., for the term of twenty-eight years. The work must be printed and published, or reprinted or republished in Canada, whether before or after its publication elsewhere; and the Canadian privilege is not to be continued after the copyright has ceased elsewhere. And “no immoral or licentious, or irreligious, or treasonable, or seditious literary scientific or artistic work” shall be the subject of copyright (§ 4). A further period of fourteen years will be continued to the author or his widow and children. An “interim copyright” pending publication may be obtained by depositing in the office of the minister of agriculture (who keeps the register of copyrights) a copy of the title of the work; and works printed first in a series of articles in a periodical, but intended to be published as books, may have the benefit of this interim copyright. If a copyright work becomes out of print, the owner may be notified of the Act through the minister of agriculture, who, if he does not apply a remedy, may license a new edition, subject to a royalty to the owner. Anonymous books may be entered in the name of the first publisher.

Books published in a colony stand on the same footing, so far as the United Kingdom is concerned, as books published in a foreign country. Their protection in England depends on the International Copyright Acts.

The International Copyright Acts were passed in order to give foreign authors the same sort of privilege as is accorded to English authors, on the basis of reciprocity. The principal Act is the 7 and 8 Vict. c. 12, repealing an earlier Act, 1 and 2 Vict. c. 59, and amended by 15 Vict. c. 12.

Her Majesty may, by Order in Council, grant the privilege of copyright to the authors of books, &c., first published in any foreign country to be named in such order—provided always that “due protection has been secured by the foreign power, so named in such Order in Council, for the benefit of parties interested in works first published in the dominions of Her Majesty similar to those comprised in such order.” Different provisos may be fixed for different countries and different classes of works protected. No right of property shall be recognized in any book, &c., first published out of Her Majesty’s dominions, save such as is created by this Act. Hence British as well as foreign authors first publishing abroad, have no protection in England unless there is a convention between England and the country in which they publish under the International Copyright Act. Thus in *Boucicault v. Delafeld*,<sup>1</sup> the plaintiff had first performed a drama in New York, and afterwards registered it in England on the first day of its performance there, and now sought to have its unauthorized representation restrained. The court refused, holding that the Act 7 and 8 Vict. c. 12, § 19 says in effect that if “any person, British subject or not, chooses to deprive this country of the first representation of his work, then he may get the benefit of copyright if he can, under any arrangement which may have been come to between this country and the country which he so favors with his representation.” If there is no such treaty or arrangement, then this country has nothing more to say to him. The publication in the British dominions of unauthorized translations of works published abroad may be prohibited by the authors for a period of five years, except in the case of political articles in the newspapers, &c. Copyright in foreign works of art, prints, articles of sculpture, &c., may also be protected under the conditions applicable to copyright in the same subjects in England. The right of representing in England dramatic pieces, &c., first performed abroad, may also be recognized in the same way. The authors of dramatic pieces first performed abroad may also acquire (under the 15 Vict. c. 12) the right to prevent the representation of any unauthorized translation of such dramatic pieces for a period not exceeding five years from the date of first

publication or representation of an authorized translation. Section 6 of this Act contains the important exception that “nothing herein contained shall be so construed as to prevent fair imitations or adaptations to the English stage of any dramatic piece or musical composition published in any foreign country.” This clause has given great dissatisfaction, and it has been virtually repealed by 38 Vict. c. 12.<sup>2</sup> The right to prevent translations of foreign books or dramatic pieces is subject to certain conditions enumerated in section 8—requiring registration, publication of an authorized translation within a certain time, &c. The Act requires, it seems, that the translation should give the English people the means of knowing the original as accurately as is possible by means of an English version; and in a recent case, where the authors of *Frou Frou* had authorized a free English version with many changes of names, &c., and considerable omissions, it was held not to be a sufficient compliance with the statute.<sup>3</sup> The judge pronounced it to be an imitation or adaptation only, and said that if a true translation had been published first, the plaintiff might then have acted the “version,” and nobody else would have been allowed to act anything like it.

In all these cases, it must be remembered, the Crown can grant copyright to foreign productions, only on condition that a convention securing reciprocal rights is concluded with the foreign power in question, in terms of the International Copyright Act. The countries with which conventions have been concluded are the following:—Prussia, Saxony, and other German states, in 1846 and 1847; France, 1852; Belgium, 1855; Spain, 1857; Sardinia; and Hesse Darmstadt, 1862.

An Association to Protect the Rights of Authors has recently been formed with the object of calling attention to the more glaring defects of the existing laws of copyright. The chief points noticed by this association are the loss of rights by first production out of the United Kingdom; the loss by dramatization of novels; the unfair conditions of stage-right in translations of foreign plays, and especially the hardship of the “fair adaptation” clause; the loss caused by the inefficient prohibition of pirated copies in Canada since the International Copyright Act was passed, and the absence of an international copyright treaty with the United States. Of these defects the “adaptation clause” has been repealed since the association was formed, and the Act already noticed was passed in 1875 to give effect to a new Copyright Act of the Canadian Parliament. In 1876 a royal commission was appointed to consider the whole question of home, colonial, and international copyright.

The question of international copyright between England and the United States has for some time been the subject of active discussion among the authors and publishers of both countries. The chief opposition to a convention proceeds from various sections of the publishing trade in America. An interesting statement of the various groups of opinion on this subject in the United States, and of the attempts to frame a satisfactory International Copyright Act, will be found in an article by Dr. C. E. Appleton in the *Fortnightly Review* for February, 1877. At present a sort of customary copyright in English books is recognized by certain leading firms. When one of them has, by arrangement with the author, obtained the advance sheets of an English work, there is a tacit understanding that the others are not to reprint that particular work; but this arrangement, it appears, “is practically confined to those who are able to retaliate when the trade courtesy is violated.” These great publishers have a monopoly of the English trade, and those who would gladly become their competitors, the booksellers of the Middle and Western States, would, according to Dr. Appleton, oppose any International Copyright Act which did not aid them to break down that monopoly. Some of the resolutions of a meet-

<sup>1</sup> The state of the law, as it is left by this Act, is worth noticing. By the 15 Vict. c. 12, the Queen may, by Order in Council, grant stage-right to foreign dramatists as mentioned above, and the enactments in force for protecting domestic stage rights are available for them; but nothing in the Act is to prevent fair imitations or adaptations to the English stage of foreign plays, &c. Now comes the Act of 1875, which says that in case of any such order the Queen may direct that the said section 6 shall not apply, and thereupon the 15 Vict. c. 12 “shall take effect with respect to such dramatic pieces, and to the translations thereof as if the said sixth section of the said Act were hereby repealed.” So that the Queen may repeal the sixth section in any particular case so far as to remove the question of “fair adaptations and imitations” to the common law.

<sup>2</sup> *Wood v. Chart* (*Law Reports*, 10 Equity 204).

<sup>1</sup> The same question was decided in the same way in the recent case (*Nov.*, 1874) of the same plaintiff against Mr. Chatterton for representing “Shaughraun,” a play first brought out by plaintiff in America.

ing of the opponents of International Copyright at Philadelphia in January, 1872, are worth quoting:—

1. That thought, unless expressed, is the property of the thinker; when given to the world it is as light, free to all.
2. As property it can only demand the protection of the municipal law of the country to which the thinker is subject.
3. The author of any country, by becoming a citizen of this, and assuming and performing the duties thereof, can have the same protection that an American author has.
4. The trading of privileges to foreign authors, for privileges to be granted to Americans, is not just, because the interests of others than theirs are sacrificed thereby.
5. Because the good of the whole people, and the safety of our republican institutions, demand that books shall not be made too costly for the multitude by giving the power to foreign authors to fix their price here as well as abroad.

Manufacturing designs.

Copyright of designs applicable to manufactures is protected by the 5 and 6 Vict. c. 100, and subsequent Acts amending the same. Before designs in general were protected, the copyright in designs for the manufacture of linens, cottons, calicoes, and muslins had been recognized. The 5 and 6 Vict. c. 100, § 3, enacts "with regard to any new and original design, whether such design be applicable to the ornamenting of any article of manufacture, or of any substance, artificial or natural or partly artificial and partly natural, and whether for the pattern, for the shape or configuration, or for the ornament thereof, and by whatever means the same may be applicable, whether by printing, painting, &c., the proprietor shall have the sole right of applying such design, for the terms specified in the Act, which vary according to the class of manufacture in question." By 6 and 7 Vict. c. 65, copyright for three years was granted for designs "having reference to some purpose of utility, so far as design shall be for the shape or configuration of such article." Registration in both cases is necessary. The period of protection varies from nine months to five years, and in certain cases an extended period may be granted by the Board of Trade. Cases under these Acts are more nearly allied to patents than to copyright.

**COPYRIGHT IN FOREIGN STATES.—France.—**France. Copyright in France is recognized in the most ample manner. Two distinct rights are secured by law—1st, the right of reproduction of literary works, musical compositions, and works of art; and 2d, the right of representation of dramatic works and musical compositions. The period is for the life of the author and fifty years after his death. After the author's death the surviving consort has the usufructuary enjoyment of the rights which the author has not disposed of in his lifetime or by will, subject to reduction for the benefit of the author's protected heirs if any. The author may dispose of his rights in the most absolute manner in the forms and within the limits of the Code Napoléon. Piracy is a crime punishable by fine of not less than 100 nor more than 2000 francs; in the case of a seller from 25 to 500 francs. The pirated edition will be confiscated. Piracy also forms the ground for a civil action of damages to the amount of the injury sustained—the produce of the confiscation, if any, to go towards payment of the indemnity (Penal Code, Art. 425-429). The piracy on French territory of works published in a foreign country is, by a decree of 28th March, 1852, brought within the above provisions. "However, when a convention has been concluded with any state this treaty modifies the effects of the decree of 28th March, in so far as its provisions may be in opposition to the said decree; the prescriptions of the new convention become the special law of the parties, and the rights of the authors and artists of that state are regulated in France by the intervening convention" (*Résumé of the Rights of Literary and Artistic Property in France*, Longman & Co.).

The following statements regarding copyright in other European countries are abridged from Copinger's *Law of Copyright* (London; Stevens & Haynes, 1870):—

Other European countries.

**Prussia.**—Copyright endures for the author's life, and his heirs have a term of thirty years from his decease. When a copyright is assigned without any special stipulation, the publisher cannot issue more than one edition without the author's written permission. He may issue a reprint, on paying the author half the sum paid for the first issue.

**Austria**, by treaty with Sardinia, Tuscany, and the Papal States, gives copyright for thirty years after author's death.

**Holland and Belgium.**—Copyright formerly perpetual, now limited to the life of the author and twenty years thereafter.

**Denmark and Sweden.**—Copyright formerly perpetual, now limited to thirty years in the former and twenty in the latter; if the publication is allowed to lapse, copyright falls to the state.

**Spain.**—The period is the author's life and fifty years thereafter.

**Russia.**—The author's life and twenty-five years, and ten years more if an edition is published within five years of the end of the first term.

**Germany.**—Period fixed in 1837 at ten years; but copyright for longer periods was granted for voluminous and costly works, and for the works of German poets. Among others the works of Schiller, Goethe, Wieland, &c., were protected for a period of twenty years from the date of the decree in each case. In 1845 the period was extended in all cases to the author's life and thirty years after.

**Greece.**—Copyright is for fifteen years from publication.

**United States.**—The first legislation on the subject of literary property in the United States appears at the close of the Revolution.

In 1783 laws were passed by Connecticut and Massachusetts securing to authors for specified periods the exclusive property in their literary productions, and prescribing penalties for its violation. Similar laws were passed by Virginia in 1785, by New York in 1786, and by other States. Under this system it was necessary for authors, in order to enjoy the benefits of protection in States other than that in which they resided, to copyright their works in each State having such laws. Authors' rights therefore depended on the legislation in the several States, as there was no national law relating to copyright. In order to afford to literary property, as well as to useful inventions and discoveries, adequate protection throughout the United States by a general law, the Federal Constitution, which came into force in 1789, empowered Congress "to promote the progress of science and useful arts by securing for limited times to authors and inventors the exclusive right to their respective writings and discoveries." Pursuant to this provision the first copyright law of the United States was passed, May 31, 1790, entitled "An Act for the Encouragement of Learning by securing the Copies of Maps, Charts, and Books to the Authors and Proprietors of such Copies during the times therein mentioned." This statute gave to authors, who were citizens or residents of the United States, their heirs and assigns, copyrights in maps, charts, and books for fourteen years, and provided for a second term of the same duration, if the author should be living at the expiration of the first. The penalty prescribed for publishing, importing, or selling a book in violation of the Act was forfeiture of copies to the author or proprietor, "who shall forthwith destroy the same," and the payment of 50 cents for every sheet found in possession of the offender, one-half to go to the author or proprietor, and the other half to the United States. The Act also provided a remedy against the unauthorized publication of manuscripts belonging to citizens or residents of the United States. In 1802 the provisions of the Act of 1790 were extended to the "arts of designing, engraving, and etching historical and other prints." In 1831 the several Acts relating to copyrights were amended and consolidated by a general law, which extended the term of protection from fourteen to twenty-eight years, with provision for a renewal for fourteen years to the author, his widow or children. Musical compositions were now for the first time expressly provided for, being placed upon the same footing as books. In 1856 was passed the first statute for giving to dramatists the exclusive right of representing their plays in public, and in 1865 photographs and negatives were declared subjects of copyright in the same manner as books, engravings, &c. All statutes relating to copyright were repealed by the general law of 1870, which, with an amendment passed in 1874, now regulates the entire subject. This law may be found in the revised statutes of the United States of 1873, and the amendment in the statutes at large of 1873-74. The term of protection is the same as that under the Act of 1831. To the subjects of copyright protected by previous statutes were added paintings, drawings, chromos, statues, statuary, and models or designs intended to be perfected as works of the fine arts.

Every author or owner, native or foreign, of an unpublished literary composition or work of art has exclusive property therein at common law. Before publication he

may make of it any use which does not interfere with the rights of others. When the work is published the owner's common law rights are lost. The author or proprietor of a manuscript, if a citizen or resident of the United States, has also a statutory remedy for damages against its unlicensed publication.

In 1834 was contested in the Supreme Court of the United States the same question which had been so elaborately argued in the English case of *Millar v. Taylor*, decided by the Court of King's Bench in 1769, and finally settled by the House of Lords five years later in *Donaldson v. Becket*, viz., whether copyright in published works exists by the common law, and is therefore of unlimited duration, or is created by and wholly governed by statute. The Supreme Court, following the authority of the House of Lords, held that there was no copyright after publication except for the limited term given by the statute. Of the seven judges four concurred in this conclusion, two delivered elaborate dissenting opinions, and one was absent. This judgment has since continued to be the supreme law.

The policy of the American Government in relation to foreign authors has been far less liberal than that of England. No special arrangement for international copyright, such as subsists between Great Britain and many Continental countries, has been entered into between the United States and any foreign Government. While a foreigner in the United States is entitled to common law protection for his unpublished works, his rights after publication are determined wholly by statute. The question concerning the status of a foreign author under the copyright laws, as well as of a citizen who derives title from a foreigner, is freed from much of the doubt and difficulty that have surrounded it in the English courts. While Parliament from the reign of Anne to the present time has legislated for the benefit of "authors," leaving to the courts to determine whether that general language is applicable to all authors or is limited to those of Great Britain, the American Congress, in all its legislation for the encouragement of literature, from the Act of 1790 to that of 1870, has extended protection only to such author as may be a "citizen of the United States or resident therein." Thus by express words is a foreigner excluded from the benefits of the statute. This language has nevertheless given rise to some discussion as to who may be regarded as a "resident." That word has been judicially construed to mean any person domiciled in the United States with the intention of making there his permanent abode. Neither naturalization nor a formal declaration of such intention is required. No definite period of time and no specific acts are indicated as necessary to constitute such residence. The question is to be determined by the intention of the person at the time of recording his title, while his abode is in the United States, and by his acts so far as they indicate what that intention was. If at that time he intended to remain there and make the country his place of permanent abode, his home, he becomes during the continuance of that intention a resident within the meaning of the Act, though he may afterwards change his mind and return to his native land. How long such intention shall continue the courts have not determined; but if it exists *bona fide* at the time of recording the title, valid copyright vests, and will not be defeated by any subsequent acts or change of mind on the part of the claimant. On the other hand, if a foreign author should come to the United States intending to stay temporarily, although with that intention he should actually remain a year or ten years, he would be a mere sojourner, and would not acquire a residence within the meaning of the Act. To determine thus the intention in the mind of a person will in many cases be attended with difficulty and even with fraud. It is a question of fact for the jury, whose finding will determine the law. In case of a work composed jointly by a foreign and a native author, and copyrighted by either one or both, the copyright in the part contributed by the foreign author, if it could be distinguished, would not be valid. The assignee—although a citizen—of a foreign author, can acquire no more rights under the statute than the latter has.

There is, however, nothing in the statute to prevent a citizen or resident from acquiring copyright in certain works of art which he has purchased from a foreign author. By section 4952 copyright is vested in "any citizen of the United States, or resident therein, who shall be the author, inventor, designer, or proprietor of a book, map, chart,

dramatic or musical composition, engraving, cut, print, photograph, or negative thereof, or of a painting, drawing, chromo, statue, statuary, and of models or designs intended to be perfected as works of the fine arts." Under this section any "proprietor," who is a citizen or resident, might acquire copyright in a work purchased from a foreign author. But a subsequent section, 4971, declares that nothing in the Act "shall be construed to prohibit the printing, publishing, importation, or sale of any book, map, chart, dramatic or musical composition, print, cut, engraving, or photograph, composed or made by any person not a citizen of the United States nor resident therein." This language clearly disqualifies a foreigner, or any one deriving title from him, from acquiring in the United States copyright in the works mentioned. But no mention is made of paintings, drawings, chromos, statues, statuary, models, or designs which are included in the previous section. Whether this omission is intentional or otherwise cannot be determined from the Act, but in the absence of any judicial or legislative light on this point, the only sound interpretation would seem to be that if a citizen or resident of the United States, having purchased from a foreign author any work of art of these classes, should take the requisite steps to secure copyright therein, his title would be valid. A citizen of the United States may acquire copyright while temporarily resident in a foreign country.

The same liberal construction given to the word "book" by the English courts has been accepted in the United States. A brief literary composition on a single sheet may be copyrighted as a book. There is no special provision concerning copyright in an encyclopaedia, review, magazine, or periodical as is prescribed by sections 18 and 19 of the 5 and 6 Vict. c. 45. Such works are protected in the same manner as books. In the absence of special agreement to the contrary, the copyright of an article contributed to a magazine or other periodical would doubtless remain with the author for all purposes which would not deprive the purchaser of any advantage arising from its publication in the magazine. The right of subsequent publication in book form would belong to the author and not to the owner of the periodical. Such publication might be made at any time after the issue of the magazine, provided the circulation of the latter was not thereby injured. In practice newspapers are not copyrighted; hence any uncopyrighted article first published in a newspaper becomes *publica jure*, and valid copyright could not be subsequently obtained for it. But either the entire newspaper or any article published in it may be copyrighted by a compliance with the general statutory provisions relating to books. Authors may reserve the right to dramatize or to translate their own works, by printing a notice to that effect in the book. The copyright law does not protect a title independently of the book; but a title may be registered as a trade mark, or its unlawful use may be restrained on the general principles of equity. Nor is there any provision in the copyright law, as in England, for the protection of designs for industrial products. The statute of 1874 prescribes that the words "engraving," "cut," and "print" shall be applied only to pictorial illustrations or works connected with the fine arts, and that no prints or labels designed to be used for any other articles of manufacture shall be entered under the copyright law, but must be registered in the patent office.

The statute now in force grants to authors, and their executors, administrators, or assigns, copyright for twenty-eight years from the time of recording the title. At the expiration of that period the author or his widow or children may obtain an additional term of fourteen years. In order to secure copyright every applicant is required to perform three acts:—1st, before publication to transmit to the librarian of Congress in Washington a printed copy of the title of the book, map, chart, dramatic or musical composition, engraving, cut, print, or photograph, or a description of the painting, drawing, chromo, statue, statuary, model, or design; 2d, within ten days after publication to send to the same official two copies of such book or other article, or in the case of a painting, drawing, statue, model, or design a photograph thereof; 3d, to print on the title page, or the page next following, of every copy of a book, or in the case of a map, chart, musical composition, print, cut, engraving, photograph, painting, drawing, chromo, statue, statuary, model, or design to inscribe upon some visible portion of it, or upon the substance upon which it

<sup>1</sup>[By Act of Congress, March 4, 1891, copyright in the United States is extended to subjects of reciprocating foreign governments on condition of the manufacture of the copyrighted thing in the United States, except the private importation of two copies of the foreign work for use and not sale.—Am. Ed.]

is mounted, the notice of entry for copyright in the form prescribed. Two forms are prescribed, either of which may be used:—1. "Entered, according to Act of Congress, in the year , by , in the office of the Librarian of Congress at Washington;" 2. "Copyright 18 . . by . ." The year when the copyright was entered and the name of the person, persons, or firm by whom entered are to be given. Compliance with all these conditions is essential to valid copyright. Until they are performed an action at law for infringement cannot be maintained. But equity will protect the copyright as soon as the title is recorded, and before the performance of the other two requisites. When the right is perfected an action at law may be maintained for any infringement after the recording of the title. A penalty of \$25 is further prescribed for failure to deliver to the librarian of Congress, within ten days after publication, two copies of the best edition of the book, or description or photograph of the other articles above mentioned, and a copy of every subsequent edition containing substantial changes. A penalty of \$100 is imposed upon any person who causes notice of copyright to be inserted in a book, or impressed upon any other article for which a copyright has not been obtained. The fee for securing copyright is 50 cents, to be paid to the librarian for recording the title. A copy of such record may be obtained for 50 cents. The librarian receives \$1 for recording and certifying an assignment, and \$1 for every copy of an assignment furnished. Another essential condition to valid copyright is publication, and the work must be first published in the United States; but a contemporaneous publication abroad will not prejudice the author's rights. The production must also be original and innocent in character. Copyright will not vest in an unpublished work. But the statute provides that every person who shall print or publish any manuscript, without the consent of the author or proprietor, if the latter is a citizen or resident of the United States, shall be liable for damages. There is nothing in the Act to exclude a resident assignee of a foreign author from the benefits of this provision.

Copyrights pass to heirs and are assignable in law by any instrument of writing. Every assignment must be recorded in the office of the librarian of Congress within sixty days after its execution, in default of which it becomes void as against any subsequent purchaser or mortgagee for a valuable consideration without notice.

The existing statute provides that if any person without due authority shall print, publish or import a copyrighted book, or knowing it to be so printed, published, or imported shall sell or offer it for sale, he shall forfeit every copy to the proprietor and pay such damages as may be recovered in a civil action. In case of piracy of a map, chart, musical composition, print, cut, engraving, photograph, or chromo, the offender is made liable to forfeit the plates and every sheet copied or printed, and to pay \$1 for every sheet found in his possession either printing, printed, copied, published, imported, or exposed for sale. For every pirated copy of a painting, statue, or statutory found in his possession, or which he has sold or offered for sale, the offender must pay \$10. The injured person may obtain from a court of equity an injunction against the publication and sale of the pirated work, and may recover at law the damages sustained by such publication. All actions at law and suits in equity under the copyright statutes must be brought in the circuit or district courts of the United States, except in the District of Columbia or any territory where the proper tribunal is the Supreme Court. Appeal lies to the Supreme Court of the United States. All actions for forfeitures or penalties must be brought within two years after the cause of action has arisen. Redress for the invasion of common law rights in unpublished works must be sought in a State court, unless the parties to the controversy are citizens of different States, in which case the courts of the United States have jurisdiction.

**Stage right in the United States.**—Until 1856 there was no statute giving to Dramatists control over the public representation of their plays. This want was met by the Act of August 18 of that year, which was passed expressly to confer upon the author or owner of a dramatic composition the sole liberty of performing, or causing it to be performed, in public; and any one infringing this right was made liable to damages in a sum not less than \$100 for the first and \$50 for every subsequent unauthorized performance. The

provisions of this Act have been held to apply only to cases in which copyright was secured under the Act of 1831; and as the benefits of that law were by express words limited to citizens or resident authors, foreign dramatists acquired no rights by the statute of 1856. The Act of 1870 gives to dramatists, besides the exclusive right of publishing in print, the sole liberty of representing their dramatic compositions on the stage, and declares that any person who publicly represents a copyrighted dramatic composition, without authority, shall be liable to damages in a sum not less than \$100 for the first and \$50 for each subsequent performance. This right is secured by copyrighting the dramatic composition as a book and endures for the same term as does the copyright in the book. The Act must be construed as giving the sole liberty of representation only in cases where the exclusive right of publication has been secured. In other words, the copyright in the printed production is made to include the right of public representation. As the former can be acquired only by citizens and residents, foreign dramatists and their assignees, as under the Act of 1856, are excluded from the benefits of the statutes. There is no statutory provision, as in England, giving to either native or foreign dramatists the exclusive right to represent their manuscript plays. While foreign dramatists are entitled to no statutory protection whatever, their manuscript plays are protected by the common law. In this respect the rights of native and foreign dramatists are the same. Such protection ceases when the play is published. When published in print the owner's rights are lost, unless, in the case of a citizen, protected by statute. Whether the authorized public performance of a manuscript play, unprotected by statutory copyright, is such a publication as will give to any one, without license from the owner, the right either to represent it on the stage or to publish it in print, is a question which is not determined by statute, as in England, but is left entirely to the courts. It has been much discussed in several leading cases since 1860; and its importance is enhanced by the fact that many, if not most, of the dramas which American managers are expected and even required to provide for an exacting public and a critical press are from the pens of English and French playwrights. It is well settled that the public performance of a manuscript drama is not such a publication as will invalidate a copyright subsequently obtained by the author; and that no one, without leave, may publish in print, or publicly represent the play, if obtained by stenography, the use of writing, or in any other way than through the memory of one or more persons who have witnessed its lawful representation. The theory has been advanced, and has received some judicial approval, that the owner of an uncopyrighted manuscript play cannot lawfully prevent another from publicly representing it, when the latter has obtained a copy through the memory of any person who has witnessed the authorized performance. This doctrine is supported by a single case decided in the Supreme Court of Massachusetts in 1860. Its soundness has been questioned by high authority, and there is little doubt that when the direct issue shall be presented for judicial determination such unlicensed use of the play will be held to be piracy. It may be regarded as conceded that the courts would not hesitate to declare unauthorized publication in print to be an invasion of the owner's rights.

Property in unpublished musical compositions, lectures, sermons, works of arts, &c., are governed by the same principles that apply in the case of dramatic productions. There is no statute, as in England, regulating the author's rights in manuscript lectures. The writer of an unpublished letter, whether possessing literary value or not, may prevent at common law its unauthorized publication by the receiver, unless publication is necessary to protect the latter against injurious representations made by the former.

(E. R.—E. S. DR.)

COQUEREL, ATHANASE JOSUÉ (1820–1875), son of A. L. C. Coquerel, noticed below, a minister of the French Protestant Church, was born at Amsterdam in 1820. At an early age he succeeded his father as editor of *Le Lien*, and he held this post till 1852. In that year he took part in establishing the *Nouvelle Revue de Théologie*, which had the distinction of being the first periodical organ of scientific theology published in France. Meanwhile he had gained a high reputation as an eloquent and earnest preacher, and especially as the advocate of religious freedom in opposition to the imposition of tests. Advancing beyond his father's

doctrinal position, his teaching became more and more offensive to the old orthodox party; and on the appearance (1864) of his article on Benan's *Vie de Jésus*, in the *Nouvelle Revue de Théologie*, the storm of suspicion and dislike which had long been gathering burst on his head, and he was forbidden by the Paris Consistory to continue his ministerial functions. He received an address of regretful sympathy from the consistory of Anduze, and a provision was voted for him by the Protestant Liberal Union, to enable him to continue his preaching. This he did with much earnestness and success till within a few weeks of his death. Coquerel received the cross of the Legion of Honor in 1862. He died at Paris, July 25, 1875.

Coquerel's principal writings are—*Jean Calas et sa famille* (1858); *Des Beaux-Arts en Italie* (of which an English translation was published in 1859); *La Saint Barthélemy* (1860); *Précis de l'église réformée* (1862); *Le Catholicisme et le Protestantisme considérés dans leur origine et leur développement* (1864); *Libres études*, and *La conscience et la foi* (1867).

COQUEREL, ATHANASE LAURENT CHARLES (1795–1868), French Protestant divine, president of the Presbyterian Council of Paris, was born in that city August 27, 1795. He received his early education from his aunt, Helen Maria Williams, an Englishwoman, who at the close of the 18th century made herself a reputation by various translations and by her *Letters from France*. He completed his theological studies at the Protestant faculty of Montauban, and in 1816 was ordained pastor. During the following twelve years he resided in Holland, and preached with acceptance before Calvinistic congregations at Amsterdam, Leyden, and Utrecht. In 1830, at the suggestion of Cuvier, who then filled the office of minister of Protestant worship, Coquerel was called to Paris; and there he spent the rest of his life. Ardently attached to liberal ideas, he was not content with advocating them from the pulpit, but resolved to speak also through the press. In the first year of his Paris life he therefore established a periodical entitled *Le Protestant*, which was continued till December, 1833. In the course of this year he was chosen a member of the consistory. In January, 1834, appeared the first number of the *Libre Examen*, under the joint editorship of Coquerel and Artaud, which was carried on till July, 1836. Coquerel rapidly acquired the reputation of a great pulpit orator, and the liberal views which he announced with fearless freedom brought him more and more into antagonism with the rigid Calvinists. He took a warm interest in all matters of education, and distinguished himself so much by his defence of the university of Paris against a sharp attack, that in 1835 he was chosen a member of the Legion of Honor. Pained by the doctrinal divergencies which separated the Protestants of France, and longing to bring about a real union, he originated, in 1841, a periodical entitled *Le Lien*, of which such union was the avowed object. The same year appeared his *Réponse to the Leben Jesu* of Strauss. After the revolution of February, 1848, Coquerel was elected a member of the National Assembly, where he sat as a moderate republican, subsequently becoming a member of the Legislative Assembly. He supported the first ministry of Louis Napoleon, and gave his vote in favor of the expedition to Rome and the restoration of the temporal power of the Pope. After the *coup d'état* of December 2, 1851, he confined himself to the duties of his pastorate, which he had not ceased to discharge. He was one of the most prolific of French sermon-writers, as well as one of the most famous orators of his day, and retained his popularity to the last. He died at Paris, January 10, 1868.

A large collection of his sermons was published in 8 vols. between 1819 and 1852. And in addition to the works already named, he was author of *Biographie sacrée* (1825–1826); *Histoire saints et analyses de la Bible* (1839); *Orthodoxie moderne* (1842); *Christologie* (1858), &c. These works have had a large circulation, and most of them have been translated into English, German, and Dutch.

COQUES, or COCK, GONZALEZ (1614–1684), the son of Peeter Willemsen Cock, a respectable Flemish citizen, and not, as his name might imply, a Spaniard, was born at Antwerp. At the age of twelve he entered the house of Peeter, the son of "Hell" Brueghel, an obscure portrait painter, and at the expiration of his time as an apprentice, became a journeyman in the workshop of David Ryckaert

the second, under whom he made accurate studies of still life. At twenty-six he matriculated in the guild of St. Luke; he then married Ryckaert's daughter, and in 1668 joined the literary and dramatic club known as the "Borrijkerkamer." After having been made president of his guild in 1665, and in 1671 painter in ordinary to Count Monterey, governor-general of the Low Countries, he married again in 1674, and died full of honors in his native place. Coques chose his vocation as a boy when he took lessons from the last of the Brueghels. He was trained to the execution of portraits. One of his canvases in the gallery of the Hague represents a suite of rooms hung with pictures, in which the artist himself may be seen at a table with his wife and two children, surrounded by masterpieces composed and signed by several contemporaries. Partnership in painting was common among the small masters of the Antwerp school, and it has been truly said of Coques that he employed Arthois for landscapes, Ghering and Van Ehrenberg for architectural backgrounds, Steenwijk the younger for rooms, and Peeter Gysels for still life and flowers; but the model upon which Coques formed himself was Van Dyck, whose sparkling touch and refined manner he imitated with great success. He never ventured beyond the "cabinet," but in this limited field the family groups of his middle time are full of life, brilliant from the sheen of costly dress and sparkling play of light and shade, combined with finished execution and enamelled surface. The finest examples of Coques are in England. Three of his family pieces are in the collection of Sir Richard Wallace, a fourth in Buckingham Palace, a fifth and sixth in the galleries of Mr. Labouchere and Mr. Walter of Bearwood, a seventh in the collection of Mr. Robarts, an eighth in the National Gallery. Three portraits of the Elector Palatine Frederick and his wife Elizabeth, and David Teniers, the painter, are in the Ellesmere collection. The finest specimen abroad is Coques's Family, in the Dresden Museum.

CORA, an ancient city of Italy, about seven miles south-east of Rome by the Appian Way. Various traditions about its origin are found in the Roman writers; but all agree in acknowledging its great antiquity, and for a long period it ranked as one of the most important cities of Latium. After being lost sight of in history for about twelve hundred years it reappears in the 13th century, and under the name of Cori it continues to the present day, a town of from 5000 to 6000 inhabitants. Situated on a hill that rises above the Pontine marshes, and divided by an olive grove into two portions, Cori presents a fine appearance from the plain. Besides the walls erected in the 15th century by Ladislao of Naples, it preserves important remains of its earlier and perhaps its earliest defences, constructed of large polygonal blocks; part of a temple, usually distinguished by the name of Hercules, is incorporated in the church of St. Pietro; two Corinthian columns of admirable execution mark the site of the temple of Castor and Pollux; numerous minor antiquities are scattered about the town, and the ravine outside the gateway leading to Ninfa is spanned by the Ponte della Catena, built of massive blocks of tufa.

See for further details Nibby, *Dintorni di Roma*; Giovanni Antolini, *Il tempio d'Ercole in Cori*, Milan, 1828.

CORALS (CORALLARIA). Under the general name of "Coral-Animals" are included all those members of the *Actinozoa* which have the power of secreting hard structures of the nature of a skeleton. Whether this skeleton be continuous or discontinuous, of conspicuous dimensions or simply of microscopic spicula, it constitutes what is known properly as the "coral" or "corallum;" and the animals which produce it are the so-called "Coralligenous Zoophytes" (*Actinozoa Coralligena*). The class of the *Actinozoa* is one of the primary divisions of the sub-kingdom of the *Celenterata*, or Radiated Animals; and those forms of the class which secrete a corallum belong to the orders of the *Zoantharia*, *Rugosa*, and *Alyonaria*. No corallum is ever produced in the order *Ctenophora*, and many members of the *Zoantharia* are either destitute of a skeleton or have but an imperfect one, whilst the corallum of the *Alyonaria* is also often rudimentary. The *Ctenophora*, therefore, will be wholly omitted here; and only those members of the *Zoantharia* and *Alyonaria* in which a well-developed corallum is present, will be considered at any length,—the soft-bodied forms requiring no notice except in so far as

they serve to elucidate the peculiarities of the Coralligenous groups.

The class of the *Actinosea* comprises those Cœlenterate animals in which the space included within the body-walls is divided into an inner "gastric" cavity or stomach and an outer "perivisceral" cavity. The gastric sac is short and is open below, so that the perivisceral cavity freely communicates with the outer world through the mouth, and the two cavities become practically one. The perivisceral cavity, in turn, is divided into a series of compartments by the development of a series of vertical membranous plates (the "mesenteries"), which are arranged in a radiating manner between the walls of the gastric sac and the wall of the body. The reproductive organs are not external, but are attached to the faces of the mesenteries, and shed their contents into the body-cavity. The ova reach the external medium either through the mouth or through the ends of the tentacles.

The class of the *Actinosea* is divided into four orders, viz., the *Zoantharia* (Sea-Anemones, *Madreporaria*, &c.), the *Rugosa* (*Cyathophyllum*, *Zaphrentis*, &c.), the *Alcyonaria* (Red Coral, Sea-Pens, Sea-Shrubs, Organ-pipe Corals, &c.), and the *Aenophora* (*Beroë*, *Pleurobrachia*, Venus's Girdle, &c.).

#### ORDER I.—ZOANTHARIA (*Hexacoralla*).

The members of this order are distinguished by the fact that the intermesenteric chambers and tentacles are generally and fundamentally six in number, or some multiple of six, however largely they may be subsequently increased, whilst the tentacles are simple, rounded, or conical, not fringed with lateral processes. The corallum may be wholly absent (*Actinidae*), spicular (*Zoanthidae*), in the form of an internal axis or "sclerobasis" (*Antipathidae*), or "sclerodermic," with a distinct wall, and generally distinct septa (as in the *Madrepores*, and the "Stone-corals" generally). According to the nature of the skeletal structure the *Zoantharia* are divided into the three groups of the *malacodermata*, *sclerobasica*, and *sclerodermata*.

*Zoantharia malacodermata*.—In this section are the animals commonly known as Sea-Anemones, in which there is either no skeleton at all (*Actinidae*), or simply a discontinuous pseudo-skeleton composed of minute adventitious spicules scattered through the integuments (*Zoanthidae*). Though possessing nothing that would ordinarily be termed a "coral," it may be well to insert here a general description of the anatomy of the Sea-Anemones, as they are readily accessible for study, and may be regarded as being fundamentally identical in the structure of their soft parts with the coralligenous *Zoantharia*, as well (probably) as with the extinct *Rugosa*.

The true Sea-Anemones (*Actinia*, *Tealia*, *Actinoloba*, *Sagartia*, &c.) are under ordinary circumstances simple animals, but some closely allied forms (*Zoanthus* and *Palythoa*) form compound growths or colonies, which are produced by budding, and consist of numerous polypes united by a fleshy base or cœnosarc. In the simple forms the body is generally a short cylinder or truncated cone (the "column"), usually of a fleshy or leathery consistence, and capable of undergoing great variations in shape. The lower extremity of the column usually forms a flattened discoidal area (the "base"), whereby the animal attaches itself at will to foreign bodies. The base, however, may be wholly non-adherent, pointed (*Ilyanthus*), thin, distensible, and imperforate (*Edwardia*), or swollen, rounded, and pierced with a distinct orifice (*Peachia* and *Cerianthus*). The upper surface of the column constitutes a circular flattened area (the "disc"), which carries the tentacles round its margin, and is perforated centrally by the aperture of the mouth.

In size the Sea-Anemones vary from less than a sixth of an inch up to 2 feet in diameter; and their habits of life are very various. Generally they attach themselves by the muscular base to foreign bodies, in rock-pools, at low-water mark, or extending to considerable depths. Others, again (such as *Peachia*, *Haloampia*, and *Edwardia*), live more or less completely buried in the sand; *Cerianthus* has the same habit, and further protects the body by the secretion of a loose, membranous, non-adherent tube; whilst *Archænaectis* is free-swimming and pelagic.

The integuments of the Sea-Anemones consist of an outer layer ("ectoderm"), an inner layer ("endoderm"), and a

more or less largely developed intermediate layer ("mesoderm"), each of which may in turn be differentiated into successive more or less distinguishable strata. The ectoderm is composed of an exterior stratum of ciliated epithelial cells, a granular stratum crowded with "thread-cells," and a stratum of pigment to which the brilliant coloration so characteristic of these animals is due. The peripheral epithelial cells are constantly being thrown off from the surface as a viscid mucus, which may entangle foreign bodies and form a species of investing tube. In other cases (*Tealia*, *Bunodes*), the surface is studded with adhesive vesicular warts, by means of which the integument obtains an adventitious coat of fragments of shell, grains of sand, and small pieces of stone. The mesoderm is essentially composed of two layers of muscular fibres, those of the outer layer having a circular direction, whilst those of the inner layer are longitudinal in the column and become radial in the base and disc. The endoderm is likewise double in its composition, its inner stratum being formed of ciliated epithelial cells.

The "thread-cells" (cnidæ or nematocysts), which are so abundantly developed in the integument of the Sea-Anemones, are microscopic organs of offence and defence. Though differing very much in size and in the details of structure in different species, the thread-cells consist essentially of an elastic double-walled sac, one extremity of which is invaginated and carries a long, often serrated or spinose filament, which lies coiled up in the interior of the

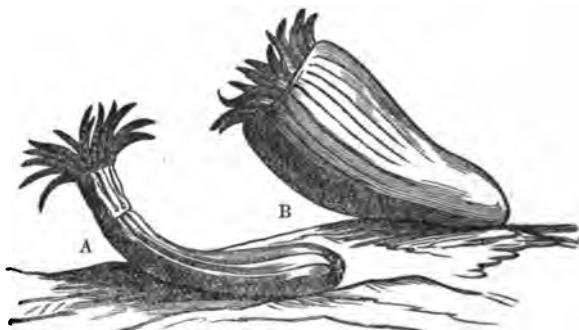

FIG. 1.—Sea Anemones.

A, *Edwardia callimorpha*, Gosse. B, *Ilyanthus Mitchellii*, Gosse, of the natural size. (After Gosse.)

sac. On the slightest pressure the sac is instantaneously everted, and the lasso-like thread in its interior is shot forth with the rapidity of lightning, having the power of penetrating any soft body with which it may come in contact, and apparently inflicting an envenomed puncture.

The organs of prehension of the Sea-Anemones are the "tentacles" (*tentacula*). These are hollow, smooth, conical or filiform organs, arranged around the margin of the disc in one or more successive circles. The walls of the tentacles are formed of the general integuments of the body, and each communicates inferiorly with an intermesenteric chamber, and is thus filled with fluid derived from the general cavity of the body. They are capable of extension and retraction, and their extremities are commonly perforated, though sometimes swollen and impervious (*Corynaectis*, *Caryophyllia*). They are abundantly furnished with thread-cells, and are, therefore, organs of touch as well as of prehension. Except in some cases, where one or more tentacles may be aborted, the number of the tentacles seems to be primitively six, and remains some multiple of this during life,—the number of these organs being increased by the development of successive cycles arranged in concentric and alternating circles. The primitive cycle consists of six tentacles, the second cycle also of six, the third cycle of twelve, the fourth cycle of twenty-four, the fifth of forty-eight, and so on, the number of each cycle being invariably double that of the preceding cycle, except in the case of the second cycle. Though it has been generally accepted that the number of the tentacles is primitively six in the *Zoantharia* (hence often called *Hexactinia*), and that their increase is as above stated, grave doubts have of late arisen as to the correctness of this view. According to Lacaze-Duthiers, the primitive tentacles are first two in

number, then four, then six, then eight, and finally twelve (in the *Actiniae*). According, also, to competent observers (Gosse, Fischer, and others) the adult Sea-Anemones by no means invariably possess tentacles which are a multiple of six, or even of five. On the contrary, various species have tentacles which are a multiple of eight, whilst in others the numerical arrangement of the tentacles seems to belong to an indeterminate type. Though showing a marked radiate arrangement, it will be subsequently shown, in speaking of the mesenteries, that even the tentacles occasionally show distinct traces of bilateral symmetry.

Internal to the circle of tentacles, the upper surface of the disc exhibits a more or less conspicuous flattened area ("peristomal space"), which is destitute of appendages, but is marked with converging lines ("radii"), which start from the bases of the tentacles and meet round the mouth, and which represent the upper attached edges of the mesenteries. In the centre of the peristomal space, often at the summit of a kind of proboscis, is placed the opening of the oval or fissure-like mouth. The angles of the mouth are furnished with grooves ("gonidial grooves"), which serve as channels for the conveyance of the ova to the exterior. The mouth opens by the intervention of a short corrugated and folded gullet into a membranous stomach, with thin muscular walls, usually descending about one-third of the distance towards the base. The stomach, when distended, is of a globular form, and it opens inferiorly directly into the general cavity of the body, by a wide patulous opening. When not in use, the walls of the stomach are in contact; its sides exhibit the downward continuation of the oral

margin, which looks inwards towards the centre of the visceral chamber, being ultimately continued to the centre of the base. Between the primary mesenteries are developed other shorter laminae, which agree with the preceding in being attached externally along their whole length to the column-wall, but which do not extend sufficiently far inwards to reach the walls of the stomach. According to their width these are known as "secondary" and "tertiary" mesenteries. The primitive number of the primary mesenteries is normally six, and the development of the remaining mesenteries is effected by the same law as governs the development of the tentacles. Thus the second cycle of mesenteries agrees with the first in being six in number, the third cycle is twelve, the fourth twenty-four, the fifth forty-eight, and so on. In some Sea-Anemones only twelve mesenteries are developed (*Peachia*), but ordinarily the number of these organs present in the adult is much greater. As already indicated with regard to the tentacles, it cannot be regarded as certain that the hexamer arrangement of the mesenteries, which is so conspicuous a feature in many of the *Zoantharia*, is by any means universal in the order, or even in the *Zoantharia malacodermata* in particular. Many of the adult forms, at any rate, appear to invariably possess mesenteries which are not a multiple of six in number. According to the researches of Rütiken and Schneider, the mesenteries are invariably of three orders in the *Actiniae*, each individual mesentery being double, and the smallest number of each order that was observed being six of the first cycle, six of the second, and twelve of the third order.

It is chiefly to the star-like disposition of the mesenteries and tentacles that the Sea-Anemones owe their conspicuous radial symmetry; but indications are not wanting of true bilaterality. Thus a single tentacle may be of a different color from, or a larger size than the others; the two radii of the disc which correspond with the gonidial grooves and run to the angles of the mouth are often more conspicuous than the other radii; the mouth itself runs fore-and-aft, and divides the body into a right and left half; there may be only a single mouth-angle and gonidial groove (*Actinoloba*); and lastly, two of the mesenteries, corresponding with the opposite mouth angles, are commonly developed before the rest. Even more conspicuous traces of bilateral symmetry which will be subsequently alluded to, are recognizable in many corals.

The entire body-cavity, with the intermesenteric chambers and tentacular diverticula, is filled with a transparent fluid ("chylaqueous fluid"), which is to be regarded as the representative of the blood. It consists of sea-water mixed with the products of digestion, containing albumen in solution along with numerous floating corpuscles, representing the "blood-corpuscles" of the higher animals. There are no proper circulating organs, but a free circulation of the chylaqueous fluid through all parts of the body is effected by means of the richly ciliated endoderm which lines all parts of the somatic cavity.

No distinct respiratory organs are present, as a rule, the function of respiration being discharged by the ciliated endoderm, as well as by the currents in the external water maintained by the cilia covering the tentacles. In some species, however, which live half-buried in the sand, there are found lobed and frilled organs attached to or beside the tentacles, and these have been conjectured to be branchial (Verrill). In the *Zoanthidae*, also, there are found curious paired organs covered with cilia, and attached to the primary mesenteries a little below the stomach; and these may probably be regarded as gills (Dana).

The free edges of the mesenteries below the stomach are thickened, and constitute a puckered and convoluted marginal cord ("craspedum"), which is richly furnished with thread-cells. Also attached to the free edges of the mesenteries are sometimes found the organs known as "acontia." These are long thread-like filaments, which are only attached by one end to the mesentery, and are crowded with thread-cells. The acontia seem to be undoubtedly organs of offence and defence, as they can, on irritation, be rapidly shot forth from the mouth, as well as from certain minute orifices in the body-wall (cinclides) which appear to be specially intended for their emission.

Specialized organs of the senses are either wanting in the Sea-Anemones, or only present in a rudimentary condition.

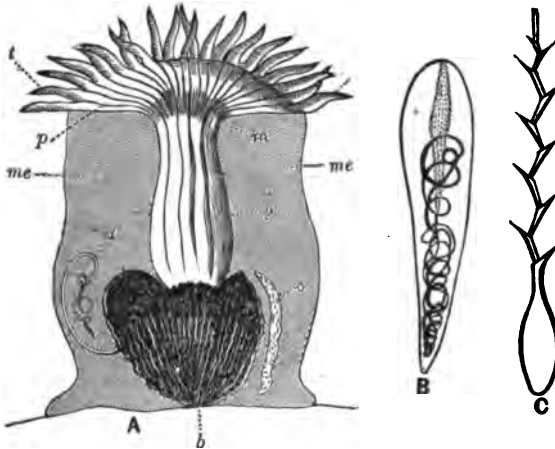

FIG. 2.—Morphology of the Actinidae.

A, Ideal representation of a Sea-Anemone, vertically bisected; *t*, tentacles; *p*, peristomal space; *m*, mouth; *s*, stomach; *b*, interior of the general body-cavity, below the stomach, showing the free edges of the mesenteries; *me*, one of the mesenteries; *o*, ovary; *a*, acantium. B, Thread-cell of *Caryophylla Smithii* (after Gosse), greatly enlarged. C, Thread-cell of *Tealia crassicornis* (after Gosse), with the filament everted, greatly enlarged.

gonidial grooves. In some forms, a layer of colored fat-cells is developed in the walls of the stomach towards its upper portion, and this is conjectured by Mr. Gosse to represent the liver. No other distinct alimentary organs exist, and indigestible matters are got rid of through the mouth.

The general cavity of the body ("somatic cavity") freely communicates with the external medium through the stomachic sac and mouth, and is bounded externally by the integuments, and lined by the endoderm. The space thus formed is subdivided into a series of chambers or compartments by a number of radiating vertical membranous laminae, to which the name of "mesenteries" is given. The mesenteries are essentially double, each being composed of an inward reduplication of the muscular mesoderm, covered by the endoderm, and they vary greatly in width. The first-formed and widest mesenteries ("primary mesenteries") are attached by the whole of their outer edges to the column-wall, by their upper edges to the disc from its margin to the mouth, and by their lower edges to the base from the circumference to the centre. The inner edges of the primary mesenteries are attached to the sides of the stomach, from the mouth almost to its inferior opening; but below this point they present a free, curved



**Tactile sensibility**, though well developed, is generally diffused over the surface, residing more particularly in the tentacles. Organs of hearing are wholly unknown. As regards the sense of sight, many species possess round the margins of the disc a series of brightly-colored bead-like bodies ("marginal spherules," "bourses marginales," or "chromatophores"), which are said to be furnished with nervous filaments, and which may with great probability be regarded as imperfect organs of vision. The condition of the nervous system is still a matter of great obscurity, and its very existence has generally been considered as doubtful. According, however, to recent researches (Duncan), it would appear that a plexiform arrangement of nerve fibres can be detected in the base of *Actinia*, a similar nervous apparatus probably existing in the disc as well.

The reproductive organs are in the form of thickened bands, of an orange or pink color, enclosed in the mesenteries near their free edges, and the ovaries and testes are similar to one another in form and structure, differing only in their contents. As a rule, the sexes appear to be distinct, but in some forms they are united in the same individual. The reproductive elements escape into the body-cavity by dehiscence of the reproductive glands, but the precise manner in which the ova of the dioecious species are fertilized has not been determined. In addition to true sexual reproduction, increase is sometimes effected, non-sexually, by gemmation or fission. Gemmation is rare amongst the Sea-Anemones, the new polypes being budded forth from the sides of the parents close to the base, and being finally detached as independent animals. Fission is not by any means so rare, and may either take place by a longitudinal cleavage of the original polype into two wholly or partially independent individuals (*Antheus* and *Actinia*), or by the separation of portions of the margins of the base of the parent, and by the development of these into new polypes (*Actinoloba Sagartia*).

As regards their development, the fecundated ovum becomes converted into an ovate, ciliated, actively locomotive embryo ("planula"), with a double wall enclosing a central cavity. A depression next appears at one extremity, indicating the future mouth, and the embryo passes into the "gastrula" stage, by the opening up of a communication between its central cavity and the exterior medium, or by invagination on itself, it being still uncertain which of these modes is employed. The gastrula now fixes itself by one extremity to some foreign body, and the primitive mesenteries and tentacles are developed. These are originally six in number; but according to Lacaze-Duthiers the first and second cycles (twelve in all) are developed by passing successively through the numbers two, four, six, and eight. The remaining cycles of tentacles and mesenteries are rapidly added, until the animal attains the full number of these organs proper to the adult.

As to the geographical distribution of the *Zoantharia malaecodermata* little need be said, as the members of this group, taken as a whole, are cosmopolitan in their range. They are, however, pre-eminently characteristic of the littoral and laminarian zones, only very few forms, and these not typical Sea-Anemones, extending to depths of over 500 fathoms (*Palythoa*), and one genus (*Arachnactis*) being pelagic. As to their distribution in time, nothing at all can be said, as from the soft nature of their bodies, they have left no traces of their past existence.

The *Zoantharia malaecodermata* may be divided into the following three families:—

**FAM. I. ACTINIDÆ.**—Polypes essentially simple, the base forming a flattened sucker by means of which the animal adheres at pleasure to foreign bodies. No corallum. (*Actinia*, *Sagartia*, *Bwodes*, *Tealia*, *Bolocera*, *Antheus*, *Phymactis*, *Adamania*, *Cancrisocia*, *Corynactis*, &c.)

**FAM. II. ILYANTHIDÆ.**—Polypes simple, destitute of an adherent base, free and pelagic, or living buried to the lips in mud or sand. No corallum, but occasionally a membranous epidermic tube of investment. (*Ilyanthus*, *Paachia*, *Edwardia*, *Cerianthus*, *Halecampa*.)

**FAM. III. ZOANTHIDÆ.**—Polypes adherent, united by a creeping or crust-like coenosarc, rarely solitary, and never capable of locomotion. No true corallum, but generally a pseudo-skeleton formed by adventitious particles of sand or stone imbedded in the ectoderm. (*Zoanthus*, *Episocanthus*, *Palythoa*.)

*Zoantharia sclerobasica*.—The "Black Corals," or *Anti-*

*pathida*, which comprise this group, are always composite, consisting of a number of polypes united together by a thin fleshy coenosarc, which is spread over and supported by a simple or commonly branched horny axis, or "sclerobase." The tissues are not furnished with calcareous secretions, and the polypes have in general six simple tentacles.

The *Antipathides* form colonies which are attached by the base to some foreign object, and are generally more or less branched and plant-like. The colony consists of a thin fleshy crust or coenosarc, in which the minute polypes are imbedded at intervals. The polypes are furnished with six simple conical tentacles each, though in the genus *Gerardia* as many as twenty-four of these organs may be present. The soft tissues appear to be wholly destitute of calcareous secretions of any kind, such as are found in the *Gorgonida*. The entire coenosarc, with its imbedded polypes, is supported by a horny corallum, which is generally black in color, and forms an axis or stem covered by the soft parts. The corallum is secreted by the coenosarc, and is wholly external to the polypes, for which reason it constitutes what is technically called a "sclerobasis" or "sclerobasic corallum" ("foot-secretion" of Mr. Dana), in contradistinction to the true tissue secretions of so many other *Actinozoa*. In some instances (*Cirrhopathes*) the sclerobasis is simple and unbranched, and may attain a length of several feet; but it is more commonly branched in a more or less plant-like and complicated manner (*Antipathes*, *Arachnopathes*, *Rhipidopathes*). The surface of the corallum may be smooth (*Leipathes*); but it is more commonly covered with minute spines (*Antipathes*), being thus readily distinguished from the grooved or striated sclerobasis of the *Gorgonida*. In composition the corallum is horny.



FIG. 3.—Portion of the colony of *Antipathes anguina*, Edw. and H., in its living condition, enlarged. (After Dana.)

The *Antipathides* constitute the only known family of the *Zoantharia sclerobasica*, as most naturalists are now agreed that the "Glass-rope Zoophytes" (*Hyalonemada*), with their twisted siliceous axis, are truly referable to the sponges. As regards their distribution in space, the *Antipathides* are principally inhabitants of warm seas, and are, therefore, most abundant in the neighborhood of the equator. Several species are known from the Mediterranean; they have been found at various points in the North Atlantic; and they have even been recorded from the coasts of Greenland. They occur in depths of from 10 feet up to several hundred fathoms. As regards their distribution in time, the *Antipathides* are not known to have come into existence during the Paleozoic or Mesozoic period. They appear for the first time in the Miocene Tertiary, where they are represented by a single species (*Leipathes vetusta*).

*Zoantharia sclerodermata* (*Madreporaria*).—This group includes the majority of the coralligenous zoophytes of recent seas. They may be simple, consisting of a single polype only, or composite, consisting of many polypes united by a fleshy coenosarc. They always possess a corallum, which is partially or wholly developed within the tissues of the polypes themselves ("sclerodermic"), which does not consist simply of scattered spicules, and in which the parts are so very generally disposed in multiples of six as to justify the name of *Hexacoralla* applied to the group.

The anatomy of the soft parts of the simple *Zoantharia sclerodermata* may be considered as practically identical with that of the Sea-Anemones; and the compound forms may be regarded as being essentially composed of a number of actinoid polypes united by a common flesh or coenosarc. It will, therefore, be unnecessary to treat here of more than the leading peculiarities of the hard parts, or "corallum," from which these organisms derive their common name of "corals."

An ordinary simple coral of this group may, then, be regarded as being essentially a Sea-Anemone, in which a

more or less complicated skeleton has been developed. As in the Sea-Anemones, the animal possesses a column, a base, and a disc, the margin of the disc supporting the tentacles, and its centre being perforated by the aperture of the mouth. The mouth, often more or less probosciform, opens into a stomachal sac, the walls of which are connected with the parietes of the body by vertical folds of the mesoderm and endoderm ("mesenteries"), and which communicates freely below with the general cavity of the body. Within the mesenteries are contained the reproductive



Fig. 4.—*Caryophyllia borealis*, Fleming, a simple sclerodermatous coral, twice the natural size. (After Sir Wyville Thomson.)

organs; and the disc, with its tentacles and dependent gastric sac, is permanently soft and capable of retraction and expansion. Below the stomach the soft tissues of the animal are strengthened and supported by a more or less perfect calcareous skeleton or corallum. This is composed of calcareous matter ("sclerenchyma") deposited by and in the tissues themselves, and the corallum is therefore *within* the polype, and is said to be "sclerodermic." It is thus a

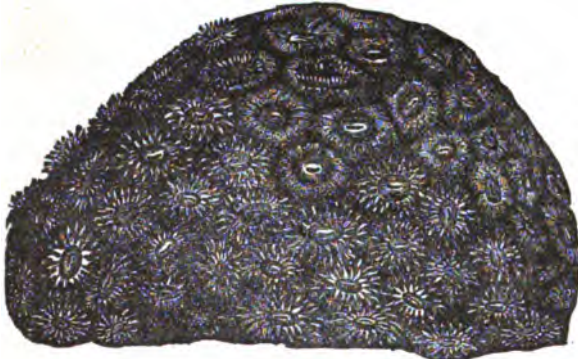

Fig. 5.—*Astraea pallida*, Dana, a compound sclerodermatous coral, in its living condition. (After Dana.)

true "tissue-secretion," and differs very conspicuously from the "sclerobasis" of other *Actinosea* ("foot-secretion" of Dana), which is secreted by the cenosarc, and is not formed by a calcification of the soft parts of the polypes themselves. A typical simple corallum may be regarded as a cone, sometimes extremely depressed, sometimes so elongated as to be almost a cylinder, with an outer wall and an internal included space. The wall of the cone is known as the "theca," and it may be very imperfect, or it may be covered externally more or less completely with a secondary calcareous investment (the "epitheca"). The theca encloses a space which is known as the "visceral chamber," is variously subdivided inferiorly, and superiorly presents itself as a shallower or deeper cup-shaped depression (the "calice"). The centre of the calice is hollowed

out for the reception and protection of the stomach-sac of the polype, but the theca generally rises round its margins nearly to the level of the disc. Below the calice the visceral chamber is divided into a series of vertical compartments (the "interseptal loculi") by a series of upright partitions or "septa," which spring from the inner surface of the theca and are directed inwards towards the centre. The septa are of different breadths. Some of them are much wider than the others, and often extend far enough inwards to meet in the centre of the visceral chamber. These are the "primary septa;" but there are others which fall short of the centre by a greater or less distance, and these are known as the "secondary" and "tertiary" septa, according to their width. The centre of the visceral chamber may or may not be occupied by a variously-formed structure known as the "columella." In its most typical form the columella is a calcareous rod, which extends from the bottom of the visceral chamber to the floor of the calice, projecting upwards into the latter, and having the primary septa usually closely connected with it. The continuity of the interseptal loculi is often more or less broken up by the development of incomplete more or less horizontal plates, the "dissepiments," which stretch from one septum to another; or the septa may be connected by numerous delicate cross-bars ("synapticulae").

The above expresses the general features of the structure of a simple sclerodermic corallum, and it is easy to see that this structure owes its peculiarities to the fact that it has been produced by the calcification of the lower portion of a polype similar in its anatomy to an ordinary Sea-Anemone. Thus, the "theca" of the corallum corresponds to the column-wall of the polype, in the interior of which it is secreted. The "septa," again, are developed within the mesenteries of the living animal, with which they correspond, and, like the mesenteries, they are "primary," "secondary," or "tertiary," according as they reach the centre or fall short of it by a greater or less distance. It is to be recollected, however, that it is only the inferior portion of the polype which is thus hardened with carbonate of lime. The tentacular disc and mouth are placed at a level higher than the upper margin of the theca, and the digestive sac occupies the calice; whilst the whole of the space comprised within the theca is lined by the endoderm, and its outer surface is covered by the ectoderm.

Whilst the simple corallum is the skeleton of a single polype, the compound sclerodermic corallum is the aggregate skeleton composed by a colony of such polypes, and it varies in form according to the form and nature of the colony by which it is produced. Such a colony consists in general of a number of polypes united together by a common flesh or "cenosarc," and corresponding elements are found in the corallum. Thus a compound coral consists generally of certain portions which are secreted by the individual polypes of the colony, and are known as the "corallites," and of a common calcareous basis or tissue, which unites the various corallites into a whole, is secreted by the cenosarc, and is known as the "cenenchyma." The latter element of a compound corallum is, however, by no means always present, the entire structure often consisting simply of the skeletons of the individual polypes ("corallites") united with one another directly and in different ways.

The compound coralla are, of course, primitively simple, and they become composite either by budding or by cleavage of the original polype. The principal methods in which this increase is effected in the *Zoantharia sclerodermata* are the following:—

1. *Lateral Gemmation*.—In this method of increase the original polype throws out buds from some point on its sides between the base and the circle of tentacles. The bud is at first simply a protuberance of the ectoderm and endoderm of the parent, containing in its interior a diverticulum of the somatic cavity; but a mouth and tentacles are developed at its distal extremity, mesenteries and septa appear in its interior, and it gradually assumes all the characters of the polype from which it was budded forth. Lateral or parietal gemmation generally gives rise to dendroid or arborescent boralla, as in the genera *Madrepora*, *Dendrophyllia*, *Cladocora*, *Oculina*, *Lophohelia*, &c., but the precise form of the resulting colony depends on the way in which the buds are given off, regularly or irregularly, singly or in numbers together, alternately or at opposite points, and also on the continuance or arrest of the growth of the parent. In other cases, where the parietal buds are given

off from the edge of the calice ("marginal gemmation"), the resulting corallum may become massive by the soldering together of the separate corallites, as occurs in the genus *Astrosmia*, where the parent corallite continues to grow side by side with its buds.

2. *Basal Gemmation*.—In this mode of growth the original polype gives forth from its base a rudimentary coenosarc from which new buds are thrown up. Sometimes the coenosarc has the form of rootlike prolongations from which the buds are developed at intervals. More commonly, the coenosarc forms a more or less extensive horizontal expansion. The resulting form of corallum varies, being sometimes fasciculate, but more commonly massive or encrusting; and in all cases the youngest corallites are those which occupy the circumference of the mass. Good examples of the process of basilar gemmation are to be found in *Rhizangia*, *Astrangia*, &c.

3. *Calicular Gemmation*.—This consists in the production of buds from the calcine disk of the parent polype, which may or may not continue to grow thereafter. This mode of increase, though known to occur in forms like *Isastraea*, and some of the *Montlivaltia* and *Thecomitella*, is very rare amongst the *Zoantharia sclerodermata*, and it may be doubted whether in certain cases it should not rather be regarded as a species of fission. Calicular gemmation, however, is seen in characteristic form amongst many Rugose corals, in treating of which it will be noticed at length.

4. *Fission*.—This consists in a process of spontaneous division or cleavage of the original polype into two individuals. This is usually effected by means of "oral cleavage," the calcine disk of the parent polype becoming divided into two portions by a groove, which gradually deepens till the original mass is converted into two halves. The proximal extremity of the parent always remains undivided, and, according to Dana, the primitive mouth and stomach are appropriated by one of the halves produced by the fission, whilst a new mouth and stomach are developed in the other half. The form of corallum produced by fission varies in different cases. Sometimes the corallum becomes "caespitose" or tufted, consisting of a number of short diverging pairs of branches, each pair produced by the cleavage of a single corallite (e.g., *Caulastraea*). In other cases the corallum becomes "massive," the corallites produced by fission remaining permanently connected with one another. In other cases, again, the secondary corallites do not become perfectly separated from one another, their calices remaining more or less completely continuous—often so much so as to give rise to one long calcine groove, with a long line of septa on each side, or to an aggregation of such grooves. By this "serial" growth the corallum becomes "gyrate" or "meandrine;" and excellent examples may be found in the genera *Madrina*, *Diploria*, *Latimadrina*, *Rhipidogyra*, *Phytogyra*, &c.

Finally it should be noticed that, though the above mentioned modes of growth may be conveniently distinguished from one another, they are nevertheless not unfrequently combined in the same individual. Thus, lateral may be combined with basal gemmation, and gemmation is commonly found accompanying fission.

It is next necessary to consider the different structures which compose the sclerodermic corallum in greater detail.

The general form of the corallum varies so much that it is scarcely possible to make any statements on this subject except of an entirely general nature. The simplest corallum is most commonly cylindrical, conical, or turbinate (*Caryophyllia*, *Turbinoidea*, *Balanophyllia*, &c.), but it may be more or less compressed (*Flabellum*), discoidal (some species of *Fungia*), or concavo-convex. It may be rooted by its base to some foreign object, or it may be wholly free. The compound coralla are of the most varied shape. Commonly they are arborescent or dendroid (*Madrepora*, *Dendrophyllia*, *Lophohelia*, &c.); at other times they grow in clusters of branches springing from a common base (*Mussa*, *Caulastraea*, and many species of *Porites*, *Madrepora*, &c.), the colony being "caespitose," and convex on its distal aspect; others are "fasciculate," or composed of numerous cylindrical corallites placed parallel with one another, or slightly diverging from the base (e.g., *Culamophyllia*); others are massive and "astreaform," composed of polygonal corallites united with one another, and forming rounded, globular, hemispherical, or irregular masses (as in the typical *Astræidae*); others are "foliaceous" (species of *Madrepora*, *Pocillopora*, *Manopora*, &c.); others, finally, are "encrusting" (e.g., some of the species of *Manopora*, *Agaricia*, &c.).

The "wall" ("muraille," "eigentliche Wand") is the proper outer investment of the visceral chamber, whether we consider a simple corallum or take a single corallite in a compound corallum. The hard structures which are placed on the inside of the wall are the "endotheca,"

whilst those which are developed exteriorly to the wall constitute what is collectively known as the "exotheca." The condition of the wall varies greatly in different groups of the *Zoantharia*, being thick, compact, and impervious in some (*Aporosa*), and at other times more or less incomplete and pierced by larger or smaller apertures (*Perforata*). The surface of the wall may be smooth, or it may be marked with vertical ridges (costæ), or by transverse striae or annulations of growth. Though often very distinctly recognizable, the wall may become so united with the coenenchyma as to be no longer determinable, or its place may be more or less completely taken by the epitheca.

The "epitheca" is a secondary calcareous investment, which is very commonly developed in both simple and compound coralla, and is probably an integumentary secretion. In the simple coralla it is placed outside the proper wall, to which it may be closely applied, or from which it may be separated by the costæ. It may be extremely thin, or very dense; and in the latter case its development is generally at the expense of the wall, which becomes so thin as to be often irrecognizable. It varies also in its extent, sometimes covering only the basal region of the coral, and at other times extending to the margin of the calice. It is generally marked with concentric striae and vertical ridges, often with accretions of growth, and it may give off spines or root-like processes of attachment. In the compound corals it is not unusual to find a well-developed epitheca enclosing the entire corallum below and on the sides, whilst each individual corallite is furnished with its own wall.

The external surface of the corallum often exhibits more or less prominent vertical ridges, which are known as the "costæ." The costæ in a general way correspond with the septa in number and arrangement, and they usually appear, therefore, as so many prolongations of the septa outside the wall. It does not appear, however, that this is due to the septa being really continued through the wall so as to form the costæ, but these structures would really seem to have an entirely independent origin. The projection of the costæ from the wall is generally proportionate to the development of the septa to which they correspond, and there are great differences in different cases as to their size and distance apart. They may be ornamented with spines or tubercles, and they may be united by transverse plates ("exothecal dissepiments"), which run horizontally across the intercostal spaces. Sometimes the costæ, instead of corresponding with the septa, are placed opposite the interseptal loculi, and are thus seen to be really independent of the septa. In compound coralla the costæ are often wanting when the corallites are amalgamated by their walls. In other cases the costæ are greatly developed, and serve by their coalescence to unite the various corallites into a single colony.

The "calice" is the generally cup-shaped depression which is seen at the upper end of a corallum or of a single corallite of a compound mass, and which lodges the gastric sac of the animal in its living condition.

The "margin" of the calice is formed by the wall, and its "floor" is occupied by the septa, the interseptal loculi, and the central structures of the corallum. Though in general more or less cup-shaped and depressed, the calice may be prominent, and the septa may be produced beyond it ("exsert"). The outline of the calice is very different in different cases, though typically more or less circular; its depth is also extraordinarily variable; and its plane varies much in the angle which it forms with the axis of the corallum. The "septæ" ("cloisons," "Längscheide-wände"), as previously noticed, are the vertical plates which radiate from the wall towards the centre and divide the visceral chamber into a series of vertical chambers or compartments ("interseptal loculi"). The septa correspond with the mesenteries of the living animal, within which they are developed, and the tentacles correspond each with an interseptal space. In their most rudimentary condition the septa appear simply as rows of spines or tubercles, but they in general present themselves as calcareous laminae, which can usually be shown to consist each of two closely apposed plates (in *Dausmia* of three), though often so thin and delicate as to appear single. When fully developed, a septum may be regarded as a somewhat triangular lamina, the base of which projects freely into the calice, whilst its outer margin is attached to the internal surface of the wall, and its inner margin is directed towards the centre of the

visceral chamber extending from the bottom of the coral to the floor of the calice, and being either free or united with certain other structures, to be spoken of hereafter. The free edges of the septa are usually thin, and they may be plain or ornamented with spines, serrations, or granules. The parietal or attached edges of the septa are usually the thickest, but occasionally the septum widens out in the middle or centrally. The sides of the septa, looking into the interseptal loculi, may be smooth or may be ornamented with ridges, striae, papillae, or granules. The septa may be compact and imperforate, or they may be more or less porous and cribriform. Usually the various septa are quite independent of each other, but occasionally some of the smallest and latest-formed septa may become inclined towards, and coalescent with, the larger and older septa.

The number of septa varies, but in none of the *Zoantharia sclerodermata*, in which septa are developed at all, are there found less than six septa in the adult corallum. Sometimes this number is permanently retained; sometimes twelve septa are present; most commonly the septa of the adult are over twelve in number. When there are more than six septa then their breadth varies, according as the mesenteries vary, and they thus become "primary," "secondary," and "tertiary." The chief facts which it is important to know about the development and arrangement of the septa are the following, taking the generally received views on this subject. At first six septa make their appearance simultaneously. These are the *primary septa*, and they may not be further added to. In other cases six additional and smaller *secondary septa*, are next produced, one bisecting each of the six interseptal loculi between the primary septa; and this condition may also be permanently retained (*Alveopora*). In other cases twelve additional septa are produced in the now existing

If a fifth cycle of septa be formed, then there are 90 septa, in six systems of sixteen septa each. Six cycles give 192 septa, and seven cycles produce 384; but it is far from common for these higher cycles to be completely developed.

The rule amongst the *Zoantharia sclerodermata* is that the septa are arranged in six systems, and are therefore, however numerous, some multiple of six; but this rule is not of universal application, and the typical hexamerous arrangement may be departed from altogether. Thus, certain forms have the primary septa four, five, eight, or ten in number, and, therefore, have the septa of the adult arranged in a corresponding number of systems. It should be added that the researches of Lacaze-Duthiers have given rise to some doubt as to the above being truly the method in which the septa are successively developed. According to this observer the septa are developed before the wall (contrary to the received opinion), and are primitively twelve in number; but it seems clear that though this may be the case in the species examined by the French naturalist, it cannot be true of all the *Zoantharia sclerodermata*.

Between the internal edges of the septa and the axis of the visceral chamber, there may exist a series of laminar processes to which the name of "*pali*" is given. The pali vary in number and size, and they may be developed internal to several orders of the septa, forming so many "crowns." They are united by their outer edges with the inner edges of the septa, whilst their internal edges are free, or are united with the columella (if present).

The axis of the visceral chamber may be vacant and unoccupied; but it is very commonly filled by the structure known as the "*columella*." The true or "essential" columella is an axial rod of a lamellar, compact, or fasciculate structure, extending from the bottom of the visceral chamber to the floor of the calice, into which it projects, and formed independently of the septa. The septa may or may not be, some of them, attached by their inner ends to the columella, or there may be pali attached to it. A "parietal" or "septal" columella may be formed by the coalescence in different ways of the inner edges of the septa, which divide and inoculate so as to form a spongy or cellular central structure. In other cases a "pseudo-columella" may be produced by the twisting together of the inner ends of a certain number of the septa.

The continuity of the interseptal loculi is liable to be more or less interfered with by the development of the endotheal structures known as the dissepiments, syntacticulae, and tabulae. The "*dissepiments*" ("*traverses*") are incomplete, approximately horizontal plates, which stretch between adjacent septa, and break up the interseptal loculi into secondary compartments or cells. They may be absent, or rudimentary, or they may be so greatly developed as to render a greater or less portion of the corallum completely "*vesicular*" in the vicinity of the wall more especially.

The "*tabulae*" ("*planchers*" "*Boden*") may be regarded as highly developed dissepiments, and like them are approximately horizontal, as a rule at any rate. They differ from the dissepiments in cutting across the interseptal loculi at the same level. When completely developed they extend right across the visceral chamber, and divide it into a series of stories placed one above the other, the only living portion of the corallum being that above the last formed tabula. They may, however, be present only in the central portion of the corallum, or they may spring from the wall, but not extend across the visceral chamber. Tabulae may exist in conjunction with well-developed septa (*Alveopora*), or the septa may be rudimentary or absent (*Halysites*, *Favosites*).

The "*syntacticulae*" are transverse calcareous bars which stretch across the interseptal loculi, like a kind of trellis-work. They are formed by papillae developed on the opposite faces of adjacent septa, coalescing with one another in the middle of the interseptal loculi. In other cases they may be so greatly developed as to constitute elongated ridges between the septa. They are characteristic of the *Fungidae*.

In compound coralla the various corallites of the colony are often united together by a common calcareous tissue, which is known as the "*Ctenenchyma*," and which varies very much in texture, being sometimes loose and spongy (e. g., *Madreporidae*), at other times dense and compact (e. g., *Oculinidae*). In other cases the ctenenchyma is

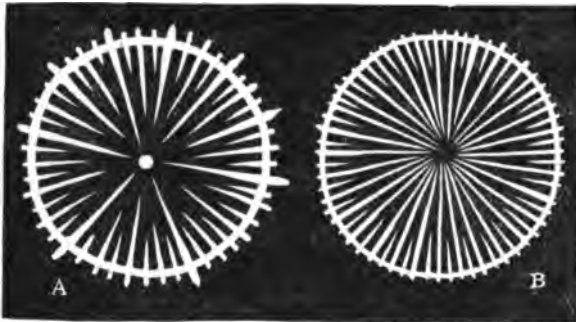

FIG. 6.—Diagram of the arrangement of the septa in the *Zoantharia sclerodermata* and *Rugosa*.

A, transverse section of a simple sclerodermatous corallum (*Turbinolia*), showing the septa, costae, and columella. B, transverse section of a simple Rugose coral (*Cyathophyllum*), showing the septa, wall, and costae.

twelve interseptal loculi, one to each loculus, and these are the *tertiary septa*. In a corallum in which this last state of things was permanent, we should, therefore, find twenty-four septa in all, belonging to three orders or cycles, six septa of the *first order*, six of the *second order*, and twelve of the *third order*. Such a corallum has obviously twenty-four interseptal loculi, and we should imagine that the next order of septa (if developed at all) ought to consist of twenty-four septa, bisecting these loculi. This is not the case, however, and any further orders of septa that may be produced are always twelve in number. If, therefore, a *fourth order* of septa be developed, it consists of twelve shorter septa intercalated in alternate interseptal loculi; whilst the loculi still vacant are filled by the development of twelve additional septa of the *fifth order*; the twenty-four septa thus produced collectively constituting the *fourth cycle*. The septa between each pair of primary septa constitute a *system*; and in the instance just taken there are forty-eight septa in all, arranged in five orders according to the time of their development, but only constituting four cycles of equally sized septa, and forming six systems of eight septa each. Each system contains the following orders:—

1st, 4th, 3d, 5th, 2d, 5th, 3d, 4th,—1st, &c.

absent or rudimentary (*Astroidea*, *Turbinolidae*), and the corallites are then united together in different ways. In some of the arborescent and fasciculate coralla the corallites are only united with one another at the points where they are budded out; but in other cases (*Syringopora*, for example) they may be united by horizontal outgrowths. Sometimes the corallites are simply in contact with one another, or their walls may be fused together, in which case there is a great tendency for the calices to become polygonal by mutual pressure. In other cases, again, the corallites are united together by the great development and coalescence of the costae.

The *Zoantharia sclerodermata* were divided by Milne-Edwards and Jules Haime into the four great sections of the *Aporosa*, *Perforata*, *Tabulata*, and *Tubulosa*. The first two of these groups constitute large, important, and natural divisions, whilst the two latter are of doubtful affinities and uncertain value.

(1.) The *APOROSA* are characterized by the fact that the calcareous tissue of the corallum is more or less compact and imperforate; the septa are well developed, and usually constitute complete lamellae; while the walls are generally quite complete, and, as a rule, are not pierced by any apertures. Dissepiments or synapticulae are usually present, but tabulae are rarely developed. This section includes the most highly developed of existing corals, and it is subdivided by Milne-Edwards and Haime into six families:

a. *Turbinolidae*.—Corallum simple or compound, but never possessing a coenenchyma; septa well developed, usually regularly granulated on the two sides, but their free edges not denticulated; interseptal loculi open and free from dissepiments or synapticulae; costae well marked and straight; wall imperforate. The principal genera of this family are *Bathycaethus*, *Brachycyathus*, *Trochocyathus*, *Leptocyathus*, *Theocyathus*, *Discoeyathus*, *Cycloeyathus*, *Paracyathus*, *Deltocyathus*, *Placocyathus*, *Turbinolia*, *Sphenotrochus*, *Platyrochus*, *Ceratotrochus*, *Discotrochus*, *Placotrochus*, *Blastotrochus*, *Rhisotrochus*, *Oncotrochus*, *Desmophyllum*, and *Flabellum*.

b. *Pseudoturbinolidae*.—Corallum simple, resembling that of the preceding in most respects, but having the septa composed of three laminae each, which are free internally, but are united externally by a single costa. The only genus of this group is the extinct *Dasmia*.

c. *Oculinidae*.—Corallum compound; coenenchyma abundant, compact, its surface smooth or striated, but not echinulate; walls imperforate, the lower part of the corallites becoming filled up in advancing age; dissepiments scanty; no synapticulae; occasionally tabulae. The principal genera of this family are *Oculina*, *Cyathohelia*, *Astrohelia*, *Synhelia*, *Lophohelia*, *Amphihelia*, *Diplohelia*, *Azohelia*, *Cryptohelia*, *Endohelia*, *Stylaster*, *Stylophora*, *Dendracis*, *Orbicella*, *Pocillopora*, and *Seriatopora* (?).

d. *Astracidae*.—Corallum simple or compound, usually increasing by fission; walls perfect and imperforate; coenenchyma absent, or if present lax; interseptal dissepiments abundantly developed; no synapticulae nor tabulae. The principal genera of this family are *Placosmia*, *Trochasmilia*, *Parasmilia*, *Eumilia*, *Thecosmilia*, *Barysmilia*, *Diplectanum*, *Montivallia*, *Dendrogyra*, *Rhipidogyra*, *Pachygyra*, *Stylina*, *Astrocamia*, *Stephanocamia*, *Phyllocamia*, *Dichocamia*, *Heterocamia*, *Sarcinula*, *Caryophyllia*, *Lophophyllia*, *Rhabdophyllia*, *Oladophyllia*, *Symphyllia*, *Oulophyllia*, *Oulomorphyllia*, *Eunomia*, *Latimeandra*, *Meandrina*, *Diploria*, *Lepidaria*, *Mavicina*, *Oladocora*, *Favia*, *Goniocora*, *Mussa*, *Pleurocora*, *Astraea*, *Oulastraea*, *Leptastraea*, *Solenastraea*, *Prionastraea*, *Siderastraea*, *Septastraea*, *Isastraea*, *Synastraea*, *Thamnastraea*, *Goniastrea*, *Astroidea*, *Angia*, *Oryptangia*, *Rhisangia*, *Astrangia*, *Phyllangia*, *Oulangia*, *Echinopora*, *Battersbyia*, and *Heterophyllia*.

e. *Pseudosungidae*.—Corallum compound, the basal plate or wall perforated (as in the *Fungidae*), but the corallites without synapticulae and with interseptal dissepiments (as in the *Astracidae*). The only genus of this family is *Merulina*.

f. *Fungidae*.—Corallum simple or compound, usually discoidal or laminar; the calices shallow and open at its sides in the simple forms, confluent and not circumscribed in the compound forms; septa complete, coalescent with the costae, imperforate, their edges dentate, and their sides echinulate or furnished with synapticulae; wall basal, generally perforated; no dissepiments, nor tabulae. The chief genera of this family are *Cycloclitella*, *Fungia*, *Ctenactis*, *Micrabacia*, *Anabacia*, *Cryptobacia*, *Cycloseris*, *Trochoseris*, *Cyathoseris*, *Comoseris*, *Protoseris*, *Lophoseris*, *Agaricia*, *Pachyseris*, *Leptoseris*, and *Phyllastraea*.

(2.) The *PERFORATA* are distinguished by the fact that the calcareous tissue of the corallum is more or less porous, loosely aggregated, spongy, or reticulate, the walls in all being perforated with more or fewer apertures. The septa are generally well developed, but may be represented only by trabeculae. The visceral chamber is usually more or less completely open

from top to bottom, but there may be imperfect dissepiments, and in some cases well-developed tabulae are present. The section *Perforata* comprises the following families:

a. *Eupsammidae*.—Corallum simple or compound; septa well developed, lamellar, for the most part perforated; a spongy columella is present; walls perforated, granular, sub-costulate, often thickened with age. Septa numerous, those of the last cycle bent towards those of the penultimate cycle, so as to produce the appearance of a six or twelve-branched star; interseptal loculi open, or only with a few dissepiments; costae rudimentary. The chief genera of this family are *Eupsammia*, *Endopachys*, *Balanophyllia*, *Heteropsammia*, *Lobopsammia*, *Carpopsammia*, *Stereopsammia*, *Stephanophyllia*, and *Dendrophyllia*.

b. *Madreporidae*.—Corallum compound, increasing by gemination; coenenchyma abundant, spongy, and reticulate; walls porous, not distinct from the coenenchyma; septa often well developed; no synapticulae, and, generally speaking, no dissepiments, but occasionally tabulae. (The diagnosis of this family may require amendment for the reception of the *Favositidae* proper.) The chief genera of this family are *Madrepora*, *Explanaria*, *Aströpore*, *Turbinaria*, *Palmacia*, *Alveopora*, *Favositopora*, and *Columnopora* (?).

c. *Poritidae*.—Corallum wholly composed of reticulate sclerenchyma; septa well developed, but only composed of styliform processes, which by their junction form a kind of irregular lattice-work. Walls reticulate, not distinct from the sclerenchyma; a few dissepiments, but no tabulae. The principal genera of this family are *Porites*, *Litharza*, *Coccinarza*, *Rhodarza*, *Porarza*, *Protarza*, *Microsolenia*, *Goniopora*, *Montipora*, and *Psammocora*.

(3.) The *TABULATA* constitute a group founded by Milne-Edwards and Haime for the reception of a number of corals essentially characterized by the rudimentary condition or absence of septa, conjoined with the presence of well-developed tabulae dividing the visceral chamber into so many distinct stories. Recent researches, however, by Agassiz, Verrill, Lindstrom, Duncan, Dollfus, Moseley, and others, have clearly shown that the old order *Tabulata* is a heterogeneous assem-

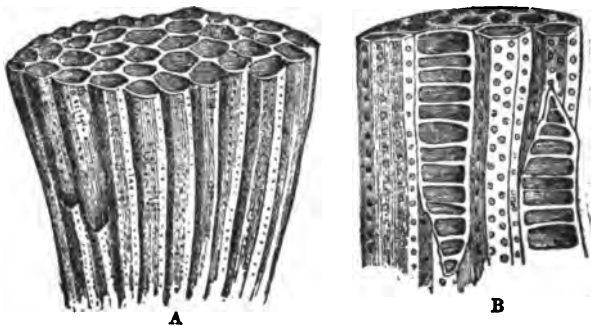

FIG. 7.—"Tabulate" Corals.

A, Portion of the corallum of *Favosites Fucosa*, Goldfuss, of the natural size. B, Portion of four corallites of *Favosites Gallandiae*, Lamarck, enlarged, showing the tabulae and the mural pores.

blage, comprising forms of very different zoological affinities, and that it must be broken up and redistributed, or greatly restricted. It has been unequivocally shown, in fact, that the presence of tabulae cannot, of itself, be regarded as a point of high classificatory value, since these structures occur in forms in other respects no way related to each other. Thus, tabulae occur in *Pocillopora*, *Cyathophora*, and occasionally in *Lophohelia* amongst the *Aporosa*, in *Alveopora* and *Favositopora* amongst the *Perforata*, in *Heliopora* amongst the *Alcyonaria*, in the great majority of the *Rugosa*, and in certain of the *Polyzoa* (e.g., *Radiopora* and *Heterodictya*). It has also been shown that some of the so-called "tabulate corals" are not *Acinosozoa* at all, but that they belong to the Molluscan order of the *Polyzoa*; and good authorities believe that this is the true position of a very large number of the forms previously included under this head. The whole of this subject is at present under investigation, and the ultimate results of the inquiry are uncertain. It will, therefore, be sufficient here to indicate the views which are now generally entertained as to the true affinities of the principal forms included by Milne-Edwards and Haime amongst the *Tabulata*.

The affinities of the great and important reef-building genus, *Millepora*, are still not absolutely settled. By Professor Louis Agassiz it was taken out of the true corals and placed amongst the *Hydrozoa*, and the most recent re-

searches of Mr. Mosely upon the living animal appear to corroborate this view. According to this observer, the spongy corallum is composed of calcareous trabeculae disposed in layers concentric with the surface of the mass, and there is the unique feature that these layers are penetrated by a series of ramifying and anastomosing canals, which communicate with the calicular cavities. There are two kinds of calices in the species examined, large and small, the former being surrounded each by a ring of the latter. The polypes, or zoïda, are of two kinds, the larger ones, occupying the large calices, having a mouth and from four to six knobbed tentacles. The smaller zoïda are more slender, have no mouth, and have from five to twenty tentacles. Mr. Mosely appears to consider that the structure of *Millepora*, as examined by him, is *Hydrozoan*; but a recent investigation carried out, on the other hand, by Major-General Nelson and Professor Martin Duncan leads these authors to the opinion that *Millepora* is really *Alcyonarian*, and therefore truly referable to the *Actinosoa*.

The genus *Heliopora* has recently been examined by Mosely in its living condition, and it has been shown to be *Alcyonarian* and not *Zoantharian*. With *Heliopora* must unquestionably be placed the extinct genera *Heliolites*, *Plasmopora*, *Lyellia*, and *Polytremacia*, all of which have an essentially tubular and tabulate coenenchyma, the corallites having tabulae and more or less distinct pseudo-septa. These, therefore, must also be removed to the *Alcyonaria*. The genus *Pocillopora*, as shown by Verrill, is a true *Zoantharian*, belonging to the *Aporosa*, and apparently referable to the *Oculinida*. *Seriatopora*, though still imperfectly known, may with great probability be placed in the immediate neighborhood of *Pocillopora*; and *Rhabdopora* and *Trachypora* may be provisionally grouped along with it. The genus *Azopora*, with its great columella, its reticulate sclerenchyma, and its want of septa, is in an extremely uncertain position, but may possibly be *Alcyonarian*.

There remain four groups of the *Tabulata*, which are in themselves well marked, but which are still in a doubtful position. The first of these is the group of the *Favositidae* (comprising *Favosites*, *Emmonesia*, *Michelina*, *Koninkia*, *Seriatopora*, *Alveolites*, &c.), in which the septa are rudimentary or absent, the tabulae are extremely well developed, and the walls are perforated more or less freely with mural pores. Their septa (when present at all) may be only pseudo-septa, like those of the genus *Heliopora*, and these forms may perhaps be *Alcyonaria*. In their perforated walls, however, they closely resemble the recent genera *Alveopora* and *Favositopora*, and their true affinities would thus seem to be rather with the *Madreporida* in the *Zoantharia perforata*. This view is further supported by the occurrence of genera like *Colosmopora*, in which the perforated walls and tabulate corallites are associated with comparatively well-developed septa. Another group is that of the *Chaetidae* (comprising *Chaetetes*, *Monticulipora*, *Dania*, *Constellaria*, &c., and probably *Fistulipora*, *Callopora*, and some allied forms), in which the walls of the corallites are imperforate, the tabulae are well developed, and there are no traces of septa. This group is in a most uncertain position, it being an open question whether it should be referred to the *Alcyonaria*, the *Polyzoa*, or the *Hydrozoa*, or whether it can be retained in the *Zoantharia*. Though often associated with the *Favositidae*, it seems certain that there is little true relationship between the two groups; and the most probable view is perhaps the one which refers the *Chaetidae* to the *Alcyonaria*. The genus *Labechia* has not been examined in sufficient detail to render its reference to this group at all certain. A third group is that of the *Thecidae*, comprising the single genus *Thecia*, in which the corallites have no true wall, but the coasts are greatly developed, and are so filled up as to constitute a dense coenenchyma. The affinities of this group are quite uncertain, though it may be regarded with some probability as belonging to the *Alcyonaria*. Lastly, there is a fourth group, comprising the genera *Halyrites*, *Syringopora*, *Chonostegites*, and *Thecostegites*, with probably *Fletcheria* and *Beasmonia*, in which there are rudimentary septa (typically twelve in number), well developed tabulae, and imperforate walls. In *Syringopora*, though the walls are compact, the visceral chambers of contiguous corallites are placed in communication by means of tubular connecting processes, and there is thus a decided approach to the structure of the *Favositidae* on the one hand, whilst, on the other hand, the genus in some respects is nearly allied to *Aulopora*. The other genera of this group have no communication between their corallites. If any forms can be retained to constitute a "tabulate" order of the *Zoantharia*, it would seem to be these; but it is not possible at present to come to any decided conclusion on this point.

(4.) The *TUBULOSA* constitute a small group, including principally the genera *Aulopora* and *Pyrgia*, to which perhaps *Cladochonus* and *Stomatopora* should be added. The corallum in this group is simple (*Pyrgia*) or compound (*Aulopora*), the corallites in the latter case being united by a creeping and branched coenenchyma. The Thecae are trumpet-shaped tubular, or pyriform, without tabulae, and having the septa indicated by mere striae on the inner surface of the wall. The affinities of this group are very doubtful, and it seems questionable if it can be retained in the *Zoantharia*. In some respects the forms included under this head show points of relation-

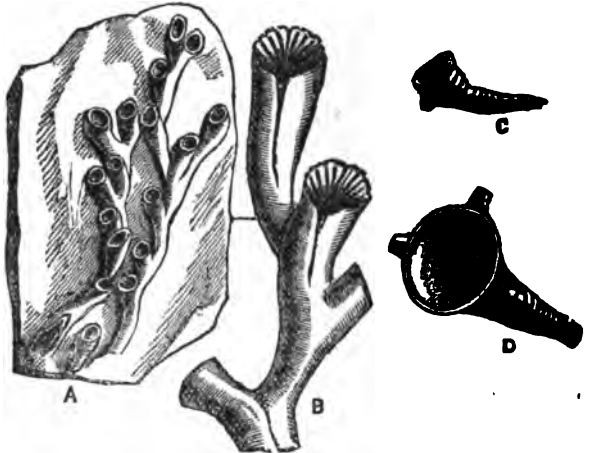

FIG. 8.—Tubulosa.

A, Portion of the corallum of *Aulopora tubiformis*, Goldfuss, of the natural size. B, Two corallites of the same, enlarged, showing the septal striae. C, *Pyrgia Michelini*, Edw. and H., of the natural size. D, The same, slightly enlarged, showing the interior of the calice.

ship with the Cyclostomatous *Polyzoa*, such as *Alecto*; but it seems more probable that they are really *Actinosoa*, and perhaps referable to the *Alcyonaria*.

As regards their distribution in space, the *Zoantharia sclerodermata* are, like the other members of the *Actinosoa*, exclusively marine. They are very widely distributed over the globe, occurring in all seas except the coldest, but attaining their maximum development in warm regions. They may conveniently be regarded under two heads—the one comprising the "solitary" corals, whether simple or compound, the other comprising the "reef-building" corals. The former do not constitute the great aggregations of coral which are known as "reefs," and though some of the compound forms may, as individuals, attain a large size, they are destitute of the loose cellular coenenchyma of so many of the reef-builders, and thus do not tend to increase indefinitely in dimensions. The solitary corals, further, are essentially and principally deep-sea forms, only rarely found in the littoral zone, or at extreme low water, abounding most in depths of from 10 to 200 fathoms, and extending their range even to depths of from 500 to over 1500 fathoms. They may, as already remarked, be either simple or compound, and amongst the more important recent genera which are solely, or chiefly, deep-water forms, may be mentioned *Caryophyllia* (rarely found in the littoral zone), *Balanophyllia*, *Flabellum*, *Sphenotrochus*, *Paracyatrus*, *Desmophyllum*, *Lobosamnia*, *Thecosamnia*, *Dendrophyllia*, *Allopora*, *Oculina*, *Lophohelia*, and *Amphihelia*.

#### Coral Reefs.

The "reef-building" corals are essentially shallow-water forms, flourishing between extreme low-water mark and depths of from 20 to 25 fathoms. By their continued growth and aggregation they give rise to the great banks of coral which are known as "coral-reefs," the compound species often possessing a lax cellular coenenchyma, enabling them to increase almost indefinitely in size. In other cases they increase rapidly by spontaneous fission. Amongst the more important reef-building corals of the present day may be mentioned the *Astræidae* generally (*Astræa*, *Mæandrina*, *Diploria*, *Astrangia*, *Cladocora*, &c.), the *Madreporida* (*Madrepore*, &c.), the *Poritidae* (*Porites*, *Goniopora*, *Montipora*, &c.), many of the *Oculinida* (*Orbicella*, *Styaster*, *Pocillopora*, &c.), the majority of the *Fungidae* (two species of *Fungia* inhabit deep water), and the *Millepores*. Though principally formed by corals belonging to the *Zoantharia sclerodermata*, the growth of coral-reefs is further contributed to by various *Alcyonoid* corals (*Heliopora Tubipora*, and numerous forms belonging to the *Gorgonidae*), and by the calcareous algae (*Nullipores* and *Corallines*).

The distribution of the reef-building corals seems to depend mainly upon the mean winter temperature of the sea, and they are confined to seas in which the temperature of the water during the winter does not sink on an average below 66° or 68° Fahr. The seas thus limited may be said to be comprised within a distance of about 1800 miles on either side of the equator. Even within these limits, however, apparently owing to the influence of Arctic currents, no coral-reefs are found on the western coasts of Africa and South America. The metropolis of the reef-building corals may be said to be the central Pacific Ocean, with its numerous islands and masses of continental land; but reefs are also found more or less largely developed in the Indian Ocean, the Persian Gulf, the Red Sea, the coasts of Zanzibar, Madagascar, and Mauritius, the Gulf of Panama, the coast of Brazil, around the West Indian Islands and the shore of Florida, and around the Bermudas. According to the classification of Darwin, which is essentially the same as that adopted by other authorities, coral-reefs may be separated into three principal groups, viz.: Fringing-reefs, Barrier-reefs, and Atolls. *Fringing-reefs* are shallow-water reefs, found in the immediate neighborhood of land, either surrounding islands or skirting the shores of continents. These shore-reefs have no channel of any great depth of water intervening between them and the land, and the soundings on their sea-ward margin indicate that they repose upon a gently-sloping surface. *Barrier-reefs*, like the preceding, may either encircle islands or skirt continents. They are distinguished from Fringing-reefs by the fact that they are placed at a much greater distance from the land, that there intervenes a channel of comparatively deep water between them and the shore, and that soundings taken close to their seaward margin indicate profound depths of water outside them. The Barrier-reefs which surround islands are termed "encircling Barrier-reefs," and they occasionally form a complete ring, though more usually discontinuous and broken at intervals. The Barrier-reefs which skirt continents attain a greater size. As an example of these may be taken the succession of reefs which form the great "barrier" on the north-east coast of Australia. These run, with occasional breaches in their continuity, for a distance of over 1000 miles, their average distance from the shore being between 20 and 30 miles, the depth of the inner channel being from 10 to 60 fathoms, and the sea outside being sometimes over 2000 feet in depth.

*Atolls* are ring-shaped reefs usually oval or circular in form, which enclose a central expanse of water or lagoon, without any land. Occasionally (as in Whitsunday Island) the entire circle of the Atoll may have been raised above the water. More commonly the ring is not complete, but is breached by one or more openings, which are always placed on the leeward side of the Atoll, or on the side most completely sheltered from the prevailing winds. In their structure Atolls are identical with "encircling Barrier-reefs," from which they differ only in the fact that the lagoon which they enclose does not contain an island in its centre.

Many coral-reefs are constantly submerged below the sea, and are not laid bare even at extreme low water; others are exposed to view by the recession of the tide, and are covered at high water; others, again, are partially raised above the level of the highest tides, and thus constitute dry land. If we examine a reef of the last class—say a portion of an Atoll or an encircling Barrier-reef—the following are the general phenomena which may be noticed. The general form of the reef is approximately triangular, as seen in section, with a steep and abrupt seaward face, and a long and gentle slope towards the inner lagoon or channel. The extreme outer margin of the reef is the only portion of the whole which is composed of actually living coral, and this part is not exposed to view even at extreme low water. Soundings outside this line always indicate a more or less considerable depth of water, and the outer margin of the reef is usually exposed to the beating of a tremendous surf, in which the coral-polypes find their most congenial home. Immediately inside the line of breakers is a broader or narrower platform of dead coral and coral-rock, which is only laid bare at low water, and which may be bounded internally by a ledge of brecciated coral-rock only reached by the waves at high water. Finally, the inner portion of the reef rises to the height of a few feet

above the level of high water, and constitutes dry land. It is composed of blocks of coral more or less completely cemented together by the percolation of water holding carbonate of lime in solution, along with blown sand derived from the disintegration of the coral. The land generally bears a luxuriant vegetation, and slopes with a prolonged and gentle inclination to the inner lagoon. The beach of the Atoll is covered with coral-sand, and with fragments of coral, which are often cemented together by the percolation of water so as to form compact oolitic or brecciated limestones. The bottom of the inner lagoon usually supports many living corals, along with accumulations of fine chalky mud, apparently largely formed from the excreta of animals, which, like the *Scari* and *Holothurians*, feed upon the living corals. Outside the reef, at depths greater than 25 fathoms, the bottom seems to be covered with coral-sand and dead coral.

The general method of formation of a coral-reef becomes readily intelligible on a consideration of the conditions which are requisite for the existence and welfare of the coral-polypes. The reef-building corals, in the first place, flourish most vigorously in depths up to 10 fathoms, and

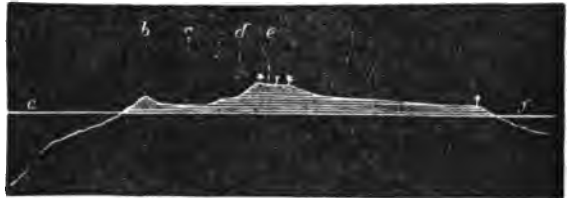

FIG. 9.—Section of Keeling Atoll. (After Darwin.)

a, Level of the sea at low water; b, outer edge of that flat part of the reef which dries at low water; c, flat of coral-rock, covered at high water; d, low projecting ledge of brecciated coral-rock, washed by the waves at high water; e, slope of loose fragments reached by the sea only during gales (the upper part, which is from 6 to 12 feet high, is clothed with vegetation; the surface of the islet slopes gently to the lagoon); f, level of the lagoon at low water.

appear to be incapable of existing at all at depths exceeding 25, or at the utmost 30 fathoms. It follows from this that no coral-reef can begin to be formed on a sea-bottom covered by more than 30 fathoms of water. In the case, however, of Atolls and Barrier-reefs, we have reefs rising out of profound depths, soundings on their seaward margin indicating depths of from 100 up to more than 1000 fathoms, at points not far removed from the actual edge of the reef. Originally it was believed that the reef had been raised from these great depths to the surface by the exertions of the polypes themselves; but the extremely limited bathymetrical range of these animals renders this view wholly untenable. The true explanation of this problem was first afforded by the masterly researches of Mr. Darwin, who showed that the production of Barrier-reefs and Atolls is really to be ascribed to the subsidence by slow degrees of the foundations on which they rest. Thus a Fringing-reef surrounding an island may be formed in depths of from 10 to 15 fathoms, and may grow till it reaches the level of low water. If, now, such a reef be supposed to sink gradually beneath the sea by a sufficiently slow subsidence, the upward growth of the corals will neutralize the downward movement of the land, so that the reef will appear to be stationary, whilst it is really growing upwards. Whilst the reef will remain to all appearance unaffected in its form, position, and size, the island which it surrounds will gradually diminish in size as the subsidence goes on, and a wide and deep channel will be formed between it and the reef. If the depression should be continued still further, the island will be reduced to a mere peak in the centre of a lagoon, and the reef, from a "Fringing-reef," will have become converted into an "encircling Barrier-reef." Simultaneously, we should find that there is now deep water all around the reef, on its outer margins; for the coral-polypes grow principally in a vertical direction, so that the width of the reef can be little or not at all greater than the width of its original base. If the depression of the land be still further continued, the central island will ultimately disappear altogether, and the reef will become an oval or circular ring, usually more or less incomplete, and perhaps 30, 40, or 50 miles in diameter, enclosing a central expanse of water or lagoon. It is

thus seen that Fringing-reefs, Barrier-reefs, and Atolls are different stages of the same thing, the latter being produced out of the former by the progressive subsidence of the land. In order, however, that this process should be carried out, it is necessary that the rate of subsidence should not be more rapid than the rate of upward growth of the corals. If it should be so, then the reef is carried down into deep water, and becomes submerged, as is the case, for example, with the great Chagos Bank. In accordance with Mr. Darwin's theory on this subject, it is found that Barrier-reefs and Atolls do not occur in the immediate vicinity of active volcanoes—regions where geology teaches us that the land is either stationary, or is undergoing slow upheaval. On the other hand, the existence of Fringing-reefs is only possible where the land is either slowly rising,

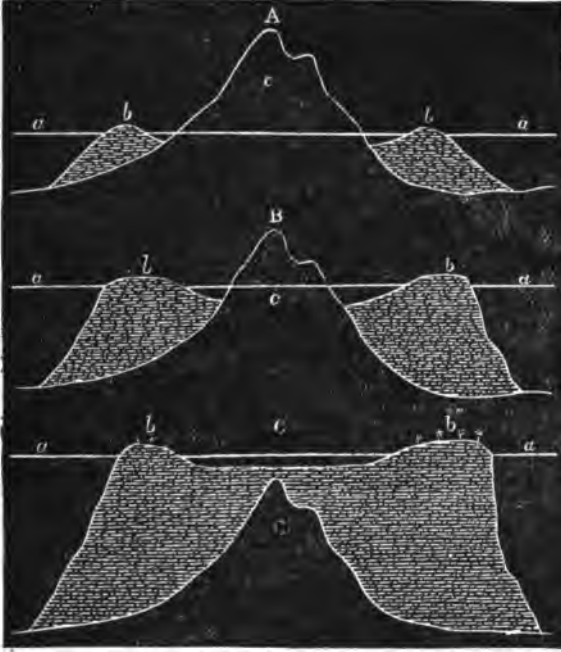

FIG. 10.—Diagrams illustrating the mode of Formation of the different kinds of Coral-reefs.

A, Ideal section of a fringing-reef surrounding an island; B, Ideal section of the same, after the land has considerably subsided, and the fringing-reef has been converted into an encircling barrier-reef; C, Ideal section of the same, when the subsidence has been so far continued as to bury the island under the ocean, and the barrier-reef has been converted into an atoll. a, sea-level; b, coral-reef; c, land.

or is stationary; and, as a matter of fact, Fringing-reefs are often found to be conjoined with upraised strata of post-Tertiary age. As regards their upward limits of growth, again, the coral-polypes cannot exist on levels higher than extreme low water, exposure to the sun, even for a short period, proving generally, if not invariably, fatal. The coral-polypes, therefore, can raise the reef to the level of extreme low water, but no further; and it is to the denuding power of the ocean that the elevation of the reef above this level is due. The breakers which fall upon the outer edge of the reef detach masses of dead coral, often of very large size, and these become gradually accumulated at particular spots, till they rise above the level of high water. The detached masses, thus heaped up, become compacted together by the finer sediment of the reef, and agglutinated by the percolation through them of water holding carbonate of lime in solution, till they become ultimately converted into a hard compact limestone. The new land produced in this way is protected from destruction by the vital activity of the living corals, which occupy a fringe at the outermost margin of the reef just below the level of extreme low water, and which by their continual growth preserve the inner parts of the reef from the waves.

Another condition very essential to the welfare of the coral-polypes is an abundant supply of pure and properly aerated water. They flourish, therefore, in their highest

vigor at the extreme outer edge of the reef, and on its windward side, where they are exposed to the constant beating of the surge; and hence it is that the growth of the reef is principally carried on at these points. Mud and sediment are, on the other hand, very injurious to corals, and they rarely occur, therefore, on sandy or muddy bottoms. It is for this reason, also, as much probably as from the pernicious effect of an intermixture of fresh water, that openings in coral-reefs are always found to exist at points opposite the mouths of rivers. It has been shown, however, by experiment, that corals will flourish on a sandy bottom provided the water is free from sediment in suspension.

As regards the distribution in time of the *Zoantharia sclerodermata*, the distinction which obtains at the present day between the solitary and the reef-building corals is found to have subsisted in the past, so far as any rate as the Tertiary and Secondary periods are concerned. Thus the solitary and essentially deep-sea forms are represented in the Kainozoic and Mesozoic deposits by forms such as *Sphenotrochus*, *Flabellum*, *Balanophyllia*, *Turbinolia*, *Leptocyathus*, *Trochocyathus*, *Paracyathus*, *Oculina*, *Diplohelia*, *Astrohelia*, *Stephanophyllia*, *Stereosammia*, *Parasmilia*, *Trochomilia*, *Thecosmilia*, *Montlivaltia*, *Dendrophyllia*, &c. On the other hand, the reef-building and essentially shallow-water forms are represented by such genera as *Madrepora*, *Axopora*, *Porites*, *Litharza*, *Solenastrea*, *Isastrea*, *Septastrea*, *Dendracis*, *Astrocamia*, *Stylocamnia*, &c.

Taken as a whole, the *Zoantharia sclerodermata* have attained their maximum of development at the present day, being largely represented in the Tertiary and Secondary periods, but having their place to a great extent usurped in the Palaeozoic period by the Rugose Corals. The *Aporosa* are only represented with certainty in the Palaeozoic series by the two remarkable genera *Battersbyia* and *Heterophyllia*, which form an aberrant group of the *Astridae* (*Palastridae*), and of which the former is Devonian, whilst the latter is Carboniferous. The Silurian genus *Palaocyclus* was formerly regarded as belonging to the *Fungidae*, but it is a genuine Rugose Coral. The genus *Dumocanella*, of the Upper Silurian, may perhaps belong to the *Turbinolidae*, and this may very probably be the true position of some of the corals referred to the genus *Petraia*, of the Silurian and Devonian. The genus *Columnaria* (*Favistella*) may perhaps also be referred to the *Astridae*. In the Permian rocks no *Aporosa* are known to have existed, the whole of this formation, as well as the greater portion of the Trias, being singularly destitute of remains of corals. Towards the summit of the Triassic series, however, in the St. Cassian beds, we find a great development of the *Aporosa*, which are now represented by a number of *Astridae*, belonging to well-known Secondary types, such as *Montlivaltia*, *Thecosmilia*, *Cladophyllia*, *Rhabdophyllia*, *Goniocora*, *Isastrea*, *Thamnastraea*, *Elysiastrea*, *Latimeandra*, and *Astrocamia*. In the succeeding formation of the Lias the *Astridae* are represented by all the genera just mentioned, along with others such as *Septastrea*, *Stylostraea*, *Cyathocamnia*, *Oppelismilia*, and *Lepidophyllia*, whilst the *Turbinolidae* are now represented for the first time (*Theocyathus*). In the great series of the Oolites, we still find an enormous preponderance of forms belonging to the *Astridae*, the principal genera of this period being *Isastrea*, *Thamnastraea*, *Septastrea*, *Glaucastrea*, *Convezastrea*, *Haliastrea*, *Pleurosmilia*, *Peplasmilia*, *Blastosmilia*, *Aplasmilia*, *Stylosmilia*, *Thecosmilia*, *Astrocamia*, *Strophocamnia*, *Rhabdophyllia*, *Cladophyllia*, *Calamophyllia*, *Beryphyllia*, *Stylina*, *Goniocora*, *Latimeandra*, *Cyathophora*, *Montlivaltia*, *Rhipidogyra*, *Pachygyra*, *Dendrogyra*, *Phyogyra*, *Favia*, &c. The *Turbinolidae* are represented in the Oolites by genera such as *Discoocyathus*, *Trochocyathus*, and *Theocyathus*; the *Oculinids* appear under forms such as *Stylophora*, *Eukelia*, *Enallohelia*, *Psammohelia*, &c.; whilst the *Fungidae* are largely represented by species of *Comoseris*, *Protoseris*, *Dimorphoseris*, *Orosieris*, *Anabacia*, *Genabacia*, &c. In the Cretaceous period the proportions of the different families of the *Aporosa* are much the same as in the Oolitic. The *Astridae* are still by far the most numerous, the principal Cretaceous genera being *Thamnastraea*, *Synastraea*, *Goniastrea*, *Isastrea*, *Haliastrea*, *Cyathastrea*, *Barysmilia*, *Trochomilia*, *Placosmilia*, *Parasmilia*, *Peplasmilia*, *Diploctenium*, *Phyllocamnia*, *Cryptocamnia*, *Astrocamia*, *Stylocamnia*, *Centrocamnia*, *Pleurococa*, *Cladocera*, *Hyandrophora*, *Caryophyllia*, *Brachyphyllia*, *Favia*, *Cyathophora*, *Meandrina*, *Latimeandra*, *Diploria*, *Leptoria*, *Stelloria*, *Rhipidogyra*, *Eugyra*, *Pachygyra*, *Montlivaltia*, *Rhizangia*, &c. The *Turbinolidae* are represented by species of *Trochocyathus*, *Leptocyathus*, *Brachygyathus*, *Cycloogyathus*, *Smilostrochus*, *Stylostrochus*, *Oncostrochus*, &c.; and the *Pseudoturbinolidae* by the genus *Darmia*. Amongst the *Oculinids* we meet with such genera as *Synhelia* and *Diblasus*; and the family of the *Fungidae* is well represented by species of *Cyclolites*, *Micrabocia*, *Cycloseris*, *Podoseris*, *Cyathoseris*, *Trochoseris*, *Orosieris*, and *Turbinoseris*. The Cretaceous corals are not separated from those of the Eocene period by any break similar in extent to



that which separates the coral-fauna of the later Palaeozoic rocks from that of the younger Mesozoic; but there is nevertheless a considerable difference observable. The *Astræidæ* are no longer so abundant, and are represented by genera such as *Solenastræa*, *Astræa*, *Heliastrea*, *Montivallia*, *Stephanocoenia*, *Phyllocania*, *Astrocania*, *Stylocania*, *Paramilia*, *Calosmia*, *Cylicosmia*, *Rhizangia*, *Dasyphyllia*, *Circophyllia*, *Latimoandra*, *Hydnophora*, &c. The *Turbinolidæ* are greatly developed, and are represented by numerous genera, such as *Turbinolia*, *Trochocyathus*, *Leptocyathus*, *Paracyathus*, *Flabellum*, *Platytrochus*, *Discotrochus*, *Sphenotrochus*, &c. The *Pseudoturbinolidæ* are represented by the genus *Dasmia*, which dies out here. Amongst the *Oculinidæ*, we meet with the genus *Oculina* itself, along with species of *Diplokelia*, *Stylophora*, &c. Lastly, the *Fungidæ* are represented by forms such as *Cyathoseris*, *Trochoseris*, and *Cyclolites*. In deposits of Miocene age, the *Astræidæ* are represented by the genera *Astræa*, *Prionastræa*, *Plasiastrea*, *Solenastræa*, *Septastræa*, *Astrocania*, *Caryophyllia*, *Lithophyllia*, *Montivallia*, *Hydnophora*, *Cladocora*, *Trochosmia*, *Diploctenium*, *Rhizangia*, *Phyllangia*, *Cryptangia*, *Cladangia*, &c. Amongst the Miocene *Turbinolidæ* are the genera *Trochocyathus*, *Deltocyathus*, *Acanthocyathus*, *Sphenotrochus*, *Ceratotrochus*, *Desmophyllum*, and *Flabellum*; whilst the *Oculinidæ* are represented by species of *Oculina*, *Diplokelia*, *Astrokelia*, and *Stylophora*, and for the first time *Pocillopora*. The *Fungidæ*, finally, are poorly represented by the genus *Cyclolites*. The Pliocene deposits have hitherto yielded a small number of corals, belonging to solitary forms, the *Astræidæ* being represented by *Caryophyllia*, *Cryptangia*, &c., the *Oculinidæ* by *Oculina* itself, and the *Turbinolidæ* by forms such as *Flabellum*, *Sphenotrochus*, and *Paracyathus*.

The geological history of the great group of the *Perforata* is shorter and less perfectly known than that of the *Aporosa*. Leaving out of sight forms of uncertain affinities, the *Perforata* are but represented in the great pile of Palaeozoic deposits by some two or three genera, and they are absent or very poorly represented in all the lower Mesozoic sediments. In the Cretaceous periods they for the first time begin to be more abundant, though sparsely developed, and it is not till the commencement of the Tertiary period that this group assumes anything like its present proportions. In the vast series of Silurian deposits the *Perforata* corals are only represented by two undoubted genera, namely, the *Protaræa* of the Lower Silurian, which belongs to the *Poritidæ*, and is nearly allied to the genus *Litharæa*, and the singular *Caloelytis* of the Upper Silurian. The Lower Silurian genus *Columnopora* may perhaps be referred to the *Madreporida*; and if the *Favositidæ* were ultimately referred to the same family, then we should have to admit a very considerable development of the *Perforata* in Upper Silurian times. In the succeeding period of the Devonian, rich as it is in corals, no certain representative of the *Perforata* is known. The genus *Pleurodictyum* has been referred here, but is apparently founded upon casts of *Favosites*. In the great coralliferous deposits of the Carboniferous, again, no representative of the group is known, save the single genus *Palaecia*, which appears to be a *Madreporacean*. In the Permian rocks, the Trias, and the Lias, no single example of a *Perforata* coral has hitherto been brought to light, and the group is represented in the Oolitic series by the single genus *Microsolena*, an aberrant member of the *Poritidæ*. In the Cretaceous series the *Perforata* corals are represented by members of all the existing families, *Stephanophyllia* amongst the *Eupsammidæ*, *Porites* amongst the *Poritidæ*, and *Actinacia* amongst the *Madreporida*. In the Eocene rocks a much more striking development of the *Perforata* takes place. The *Eupsammidæ* are now represented by *Eupsammia*, *Stereosammia*, *Lobosammia*, *Endopachys*, *Balanophyllia*, *Stephanophyllia*, *Dendrophyllia*, &c. The *Madreporida* appear under such forms as *Madrepora*, *Alveopora*, *Astrapora*, and *Dendroactis*; and the *Poritidæ* are represented by such genera as *Porites* and *Litharæa*. In the Miocene period the *Eupsammidæ* are represented by *Balanophyllia*, *Stephanophyllia*, *Dendrophyllia*, *Eupsammia*, &c., the *Madreporida* by *Madrepora* and *Turbinaria*, and the *Poritidæ* by *Porites* and *Rhodaræa*. In the Pliocene period the *Perforata* appear to be principally represented by *Eupsammidæ*, such as *Balanophyllia*, *Stephanophyllia*, *Dendrophyllia*, and *Carpocammia*.

In discussing the geological distribution of the *Tabulate* Corals, it will be convenient to consider the group as a merely provisional assemblage of forms, which cannot at present be finally systematised. The genus *Heliopora* and its allies *Heliolites*, *Plasmopora*, &c., have been shown to be *Alcyonaria*, and will be considered under that head. Here, therefore, the order *Tabulata* will be taken as temporarily including the groups of the *Milleporidæ* (*Millepora*, *Azopora*), the *Thecidæ* (*Thecia*), the *Favositidæ* (*Favosites* and its allies), the *Chatetidæ* (*Chatetes* and its allies), and the *Halysitidæ* (*Halysites*, *Syringopora*, &c.). Accepting the order in this provisional aspect, it will be found that the *Tabulata* are mainly, indeed almost exclusively, confined to the Palaeozoic period. The *Milleporidæ*, however, belong to the Tertiary and recent periods; *Koninckia* is Cretaceous, whilst *Michelina* and some of the *Chatetidæ* have been

stated to occur in the Oolitic series, though this determination is not free from doubt. The family of the *Thecidæ*, including the single genus *Thecia*, is exclusively Upper Silurian. Amongst the *Favositidæ*, the type-genus *Favosites* is Silurian, Devonian, and Carboniferous, attaining its maximum of development in the Devonian; *Emmonsia* has nearly the same range as *Favosites*; *Michelina* is found in the Devonian and Carboniferous, and is doubtfully quoted from the Oolites; *Striatopora* belongs to the Upper Silurian and Devonian; *Alveolites* is abundant in the Silurian and Devonian, and disappears in the Carboniferous; *Rameria* is Devonian, and *Koninckia* is known only from the White Chalk. Of the *Chatetidæ*, *Chatetes*, *Monticulipora*, and *Stenopora* are three imperfectly separated and closely allied groups, which are represented, collectively or separately, in all the Palaeozoic formations from the Lower Silurian to the Permian inclusive, and forms very similar, if not identical (*Heteropora*, *Neuropora*) occur in deposits of Mesozoic age. The genera *Dania* and *Constellaria* are closely allied to the preceding, and are Silurian. *Laboechia* may be temporarily placed here also, and is likewise Silurian. *Pistulipora* and *Callopora* are nearly related to the preceding and to one another (if not identical), and they range from the Silurian to the Carboniferous. Lastly, *Beaumontia* is Carboniferous. Amongst the *Halysitidæ*, the type-genus *Halysites* is Silurian; *Syringopora* ranges from the Silurian to the Carboniferous, attaining its maximum in the Devonian, whilst the single genus *Fletcheria*, though typically Silurian, is said to be represented by a species in the Trias (Muschelkalk). Lastly, the aberrant family of the *Milleporidæ* does not seem to have come into existence till the Eocene Tertiary, where it is represented by the genus *Millepora*. The remarkable genus *Azopora* also dates its first appearance from the Eocene. There remain some other so-called *Tabulate* corals which have not been noticed in the above summary, but they are not of sufficient importance to require special mention.

The small group of the *Tubulosa* is confined exclusively to the Palaeozoic period. The type-genus *Aulopora* is found in the Lower and Upper Silurian, the Devonian, and the Carboniferous, attaining its maximum in the Devonian. The genus *Pyrgia* is only known as occurring in the Carboniferous rocks.

Regarding the geological history of the *Zoantharia sclerodermata* in a summary form, it will be seen that the Palaeozoic period is characterized by the exclusive possession of the *Tubulosa*, the great development of the *Tabulata*, and the very small number of *Aporosa* and *Perforata*, the place of these latter groups being taken by the *Tabulate* and *Rugosa* corals. The Mesozoic period is characterized by the great development of the *Aporosa*, and, towards its close, of the *Perforata*, though in a less degree, whilst the *Tubulosa* are wholly gone, and the *Tabulata*, along with the *Rugosa* corals, have very nearly disappeared. Finally, the Kainozoic period is characterized by the greatly increased development of the *Perforata*, the *Aporosa* being proportionately diminished, though still remaining in great force, and the great recent group of the *Milleporidæ* (*Tabulata*?) now for the first time making its appearance.

## ORDER II.—RUGOSA.

The members of this order agree with the *Zoantharia sclerodermata* in possessing a well-developed sclerodermic corallum, with a true theca, and generally presenting both tabulae and septa combined. The septa, however, are generally (though apparently not always) some multiple of four, and there is commonly a single predominant septum, or a vacant space (fossula) representing such a septum. Some of the *Rugosa* are simple, others are compound, but the latter are destitute of a true coenenchyma.

As there are only two living genera which agree with the *Rugosa* in the tetrameral arrangement of their septa, and as it is doubtful whether we are justified in positively asserting on this ground that these genera really are *Rugosa*, this great order of *Actinosea* requires to be considered simply as regards the hard skeleton or corallum which alone has been preserved to us in a fossil condition. The corallum of the *Rugosa* is in most essential respects identical in structure with that of the *Hexacoralla*, differing principally in the numerical law of the septa and in the common conjunction of tabulae with the septa. It is very difficult to entertain any doubt but that the corallum of the *Rugosa* was secreted in a manner precisely similar to that of the existing *Zoantharia sclerodermata*, and that it bore essentially, if not precisely, similar relations to the soft parts of the animal which produced it. Thus, in both groups alike the corallum may be simple or compound; in both alike the simple form of corallum consists of an outer wall or "theca" inclosing a central space or "visceral chamber," which is divided into compartments by a series of radiating lamellae, or "septae;" in both alike the structures known as "dissepiments," "tabulae," and "columella"

may be developed; in both alike the compound corallum may be regarded as essentially formed by an aggregation of "corallites," similar in their fundamental structure to the simple corallum. With these striking and substantial points of agreement there are, nevertheless, not a few respects in which the *Rugosa* differ from the *Zoantharia sclerodermata*, and these will be best discussed by briefly considering the different parts of the *Rugosa* corallum in succession.

The form of the corallum, when simple, is usually more or less conical, turbinate, cono-cylindrical, or cylindrical, but it may be discoidal (*Palaeocyclus*, *Microcyclus*, &c.); or even everted (some species of *Ptychophyllum*), or sometimes prismatic (*Goniophyllum*), whilst it is often irregularly

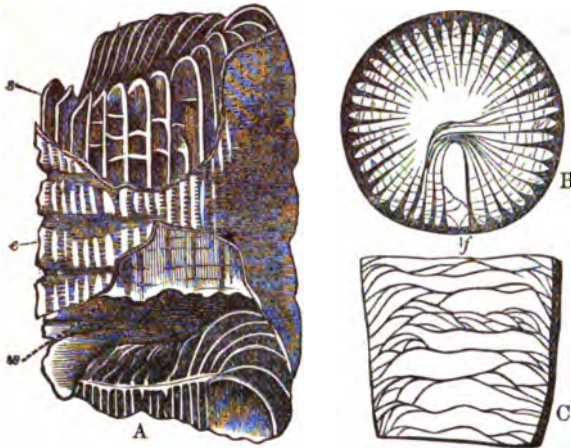

FIG. 11.—Morphology of the *Rugosa*.

A, Fragment of *Zophrentis gigantea*, Lesueur, showing the septa (s) with the sparse dissepiments crossing the interseptal loculi, the epitheca (e), and the thin proper wall (w). B, Transverse section of *Zophrentis Guerangeri*, Edw. and H., showing the septa and dissepiments, the central area occupied solely by the tabulae, and the fossula (f) formed by the confluence of a certain number of the septa. C, Longitudinal section of the last, showing the arrangement of the tabulae. (A is after Edwards and Haime; B and C are after James Thomson.)

thickened by accretions of growth. The compound coralla necessarily vary much in form, being massive, fasciculate, &c., according to the method in which new corallites are produced. The principal modes in which the corallum becomes compound amongst the *Rugosa* are the following:—

(1) *Simple calicular gemmation*.—In this process the original corallite, after growing for a certain length of time, sends up a single bud from its calicine disc, which usually is continued in the same axis as that of its parent. The primitive calice may or may not be more or less completely obliterated by the gradual growth and extension of the epitheca over it, and the secondary bud may or may not produce a tertiary bud in the same manner in which it was itself produced. Not uncommonly several buds may be produced successively, each from the oral disc of its predecessor, till the aged corallum comes to consist of a series of short turbinate cups or inverted cones, superimposed one upon the other, the younger upon the older. This singular mode of gemmation is seen in various species of *Heliophyllum*, *Cystiphyllum*, &c.; and it cannot possibly be regarded as being merely accidental; whilst it may not improbably be regarded as an advanced form of the physiological process by which "accretions of growth" are produced. (2) *Compound calicular gemmation*.—In this process, the primitive corallite throws up from its calicine disc two or more buds, which, after reaching a certain size, in most cases repeat the process. The resulting form of corallum differs in different cases. In such forms as *Cyathophyllum truncatum* and *C. paracida*, the parent corallite is destroyed by its buds, and these are in turn destroyed by the buds which they put forth, all the corallites remaining more or less separate, and the entire corallum assuming the form of an inverted pyramidal mass, the base of which is formed by the primitive corallite. In other cases, as in *Cyathophyllum regium*, the corallites become intimately united by their walls, and the corallum becomes massive and astriform. In other cases, again, the corallum becomes fasciculate, the budding corallites not being killed by their buds, but continuing to grow upwards side by side with them, as is seen in some of the species of *Cyathophyllum*, *Lonsdaleia*, *Endophyllum*, &c. (3) *Parietal Gemmation*.—This process consists in the production of buds from the sides of the corallites at some point between the base and the margin of the calice. It does not differ in its

nature or results from the same process as seen in the *Zoantharia sclerodermata*, and it generally gives rise to a loosely fasciculate corallum, as is well seen in various forms of *Diphyphyllum*, *Lithostrotion*, &c. (4) *Basal gemmation*.—This process consists in the formation of buds by an extension of the substance of the original polype from the margin of its base; but it is doubtful if this mode of increase occurs at all amongst the true *Rugosa* corals. (5) *Fission*.—Increase by spontaneous cleavage or fission is also of rare occurrence amongst the *Rugosa*, though it undoubtedly occurs occasionally, as in some species of *Diphyphyllum*.

However they may be produced, the corallites of the compound coralla of the *Rugosa* are never connected together by a true coenenchyma. When the corallites are in close contact, so that the corallum becomes massive, there is often fusion of the adjoining walls, but this is not necessarily the case. At other times the walls are wanting, and the corallites are united together by the extension and confluence of their septa (*Phillipastraea Syringophyllum*, *Smithia*, &c.), or by costae and vesicular dissepiments (*Pachyphyllum*). In other cases the corallites are united by exothecal outgrowths (as in *Eridophyllum*).

The wall is usually well developed, and is not perforate. It is, however, often wanting altogether (as in *Chonaxia*, *Phillipastraea*, *Smithia*, &c.), or very feebly represented. In many cases also there is a more or less strongly developed accessory wall, or internal mural investment ("muraille interne"), which is placed concentrically within the true wall, and thus divides the visceral chamber into a central and a circumferential space. This accessory wall may be present along with a well developed true wall (as in *Acerularia* and *Cytophyllum*), or the accessory wall alone may be present, the true wall may be absent, and the corallites may be united with one another by the amalgamation of their septa and dissepiments (as in *Pachyphyllum*, *Chonaxia*, &c.).

The epitheca is usually well developed in the *Rugosa*, though sometimes very thin. It is closely applied as a rule to the true wall, and when thickened, the latter may be very feebly developed. In the compound coralla there is often a general epitheca inclosing the corallites basally and laterally. We may, perhaps, also regard as being of an epithelial nature the extraordinary opercular structures which have been fully described by Lindström as occurring in certain *Rugosa* corals, such as *Goniophyllum*, *Calceola*, and *Rhisophyllum*. In these forms the calice is closed completely by a calcareous plate or operculum which is single in *Calceola*, but composed of four pieces in *Goniophyllum*, and which must be supposed to have been capable of erection and retraction,—the corallum thus becoming like a bivalve shell. Indeed, the genus *Calceola* was long supposed to be referable to the *Brachiopoda*. It seems probable that some other *Rugosa* corals, more normal in their characters than the above-mentioned forms, were likewise provided with an operculum. Similar structures are observable in some Tabulate corals (as in certain species of *Favosites*), where the calices become closed in progress of growth by a false operculum; and analogous structures have been recognized in certain living corals (*Primnoa* and *Paramuricea*). Though not strictly epithelial, we may also consider in this connection the remarkable root-like processes ("radioform prolongations") which are so characteristic of many of the *Rugosa* (e.g., *Omphyma*, *Goniophyllum*, *Rhisophyllum*, *Pholidophyllum*, *Ptychophyllum*, &c.). These processes may attain a length of several inches, and they consist of a process of the epitheca and wall, inclosing a diverticulum of the visceral chamber, and in some cases subdivided by dissepiments. In the simple species (such as *Omphyma*) they serve to attach the corallum to foreign objects; but similar processes occur in various compound forms (*Eridophyllum*, &c.), and serve to unite the various corallities with one another, being thus of the same nature and function as the tubular connecting processes of the Tabulate genus *Syringopora*.

The epitheca of the *Rugosa* corals is usually marked with numerous fine encircling striae, and with longitudinal lines, grooves, or ridges. The latter, however, are usually regarded as not being true costae. They differ, in fact, from the costae of the *Zoantharia sclerodermata* in not being placed opposite the septa, but alternating with these structures, and thus corresponding with the interseptal loculi. Not uncommonly (as in many species of *Zophrentis*, in *Streptelasma*, &c.) there are two of these pseudo-costae, which are pre-eminently developed and run along the dorsal surface of the corallum, the other ridges converging towards this central pair in a pinnate manner. This appearance seems to be due to the fact that the growth of the corallum was effected by the intercalation of successive septa along the sides of the primary septum to which this principal pair of pseudo-costae corresponds. In *Pholidophyllum* the costae are double, and are covered by double longitudinal rows of small imbricated scales of an epithelial nature. In genera in which the wall is absent and the corallites are united together by the confluence of the septa (e.g., in *Pachyphyllum*, *Smithia*,

*Phylloporæa*), it is impossible to determine whether true costae are present or not. True costae are also certainly present in the genus *Holocystia*.

The calice in the *Rugosa* varies greatly in form, shape, depth, &c. It is usually more or less circular, or oval, sometimes semi-circular or subtriangular in outline (*Rhisophyllum*), sometimes quadrilateral (*Goniophyllum*). It may be very shallow, or very deep, and its edges may be completely everted (e.g., in *Psychophyllum patellatum*). It may be at right angles to the axis of the corallum, or it may have any degree of obliquity. In the simple and curved or horn-shaped coralla, it is very common for the calice to be very oblique to the axis of the coral; and in these cases the convex side of the corallum (dorsal side) is the longest, and the concave side (ventral side) is the shortest.

The septa of the *Rugosa* are substantially similar to those of the *Zoantharia sclerodermata* in form and structure, forming, when well developed, a series of vertical calcareous laminae which are primitively double, spring from the inner surface of the wall, and radiate towards the centre of the visceral chamber. They are rarely or never perforate, and they vary much in the extent of their development. Sometimes they are almost wholly aborted, being only recognisable as so many faint striae on the inner surface of the calice (as in the typical examples of *Cyathophyllum*). At other times, they extend inwards only an extremely short distance from the wall, as in the genus *Amplexus*. In other cases, again, they are well developed towards the centre of the corallum, but have no connection with the outer wall, from which they are separated by dissepimental vesicles, as in the genus *Lonsdaleia*. In other instances, finally, they have their normal arrangement, being attached externally to the wall, and extending inwards to, or near to, the centre of the visceral chamber. In rare cases the septa may be all of nearly the same size; more commonly they are markedly different in size. Most of the forms in which the septa are well developed, show a distinct tetrameral arrangement of the septa, though it does not appear possible to assert positively that the primitive and first developed cycle of septa consists of only four elements. In many cases, however, the septa of the adult are a multiple of four, and their quadripartite disposition may be plainly manifested by the fact that four of the septa are pre-eminently developed and form a conspicuous cross (*Stauria*), or by the presence of four calcine depressions which have a similar cruciform arrangement (*Omphysa*). In the typical *Rugosa* the septa, though undoubtedly not simultaneously developed, are nevertheless of only two sizes, a larger and a smaller, alternating regularly with one another; and they cannot, therefore, be distinguished according to their dimensions into a series of regular cycles. The small or secondary septa also may be occasionally absent. The primary or larger septa, be their development what it may, are for the most part equal in size; but, notwithstanding this fact, the corallum often shows a very distinct bilateral symmetry, due apparently to the primitive tetrameral disposition of the septa. This is especially shown in the general existence either of a single septum of larger size than all the others (one of the four primitive septa), or of an extraordinary vacant space, representing this septum, and known as the "septal fossula." The septal fossula usually presents itself as a more or less conspicuous depression or groove in the calice, and its position, though apparently constant in any given form, is variable, being sometimes on the convex side of the corallum in the simple forms, sometimes on the concave side, and rarely situated laterally. In general it is a simple space or deficiency caused by the absence or abortion of one of the four primary septa, and it is seen in transverse sections to be occupied by from one to three short septa. Sometimes it is accompanied by a tubular depression of the tabulae at that point. Sometimes there are two smaller lateral fossulae, directed at right angles to the main depression, and representing two others of the primitive septa. At other times there may be four shallow fossulae arranged in a crucial manner (*Omphysa*), but it is not certain that these correspond with the four primitive septa. Lastly, in the genus *Metriophyllum* the septa are arranged in four groups, which are separated from one another by vacant spaces or fossulae, though in this case also it is not certain that these spaces are homologous with the true septal fossulae of forms like *Zaphrentis*. The precise physiological import of the fossulae is uncertain; but its presence gives rise to an irregularity in the arrangement of the septa which is highly characteristic of the *Rugosa*. Whilst in *Stauria* all four of the primitive septa are pre-eminently developed, only three are thus predominant in *Aniophyllum*, and only one in *Hallia*. The free edges of the septa, where they appear in the calice, are in general plain and smooth, but they may bear granular tubercles (*Palaeocyclus*), or teeth (*Zaphrentis corniculata*, *Heliophyllum*). The sides of the septa are likewise generally smooth, but they may be granulated (*Palaeocyclus*), or they may be adorned with arched and ascending striae (*Heliophyllum*).

The axis of the corallum is very often occupied by a columella, which varies much in structure in different cases. In forms such as *Cyathazonia*, *Lithostrotion*, *Koninckophyllum*, &c., we have a proper or essential columella, which is developed inde-

pendently of the septa, occupies the centre of the visceral chamber, and projects as a solid rod into the floor of the calice. In other cases the columella is composed of twisted lamellae, which isosculate with one another so as to give rise to a vesicular axis, as in *Lonsdaleia* and *Azophyllum*. In other cases, a false columella may be produced by the twisting together of the inner edges of some of the primary septa (as in some species of *Cyathophyllum*). In other cases, finally, the axis of the visceral chamber may be occupied by a series of more or less complicated structures, which may occupy a considerable space, and which have sometimes been regarded as representing a kind of columella (*Clisiophyllum*, *Dibunophyllum*, *Rhodophyllum*, *Cyclophyllum*, &c.). These axial structures, however, can only in a very limited sense be regarded as columellar.

The continuity of the interseptal loculi in the *Rugosa* is generally more or less interfered with by the development of endothecal dissepiments; but in no case are synapticles present. The dissepiments vary greatly in character and amount. Sometimes they are wholly wanting (*Cyathazonia* and some species of *Amplexus*); at other times they may be present in small amount (*Lophophyllum*, some species of *Amplexus*, &c.); at other times they are exceedingly abundant. In the species of *Cyathophyllum*, in *Lithostrotion*, in *Koninckophyllum*, and in other forms, the dissepiments are so largely developed towards the circumference of the visceral chamber as to give rise to a dense peripheral zone of vesicular tissue. In longitudinal sections of the corallum this vesicular tissue is seen to be composed of very minute lenticular cells arranged in oblique rows directed upwards and outwards. In other forms, such as *Cosmophyllum*, *Lonsdaleia*, &c., a similar zone of vesicular tissue exists, but the cells which enter into its composition are of very large size. In the genus *Heliophyllum*, and in certain other forms, there are found singular dissepimental structures, which are attached to the sides of the septa, but do not extend completely across the interseptal loculi. The structures in question constitute a series of plates which are attached by their bases to the sides of the septa, projecting freely into the interseptal loculi, and directed inwards and upwards in an arched manner from the interior of the wall towards the centre of the visceral chamber. These arched ridges are placed at corresponding points on the opposite side of each septum; they consequently appear on the free edges of the septa within the calice as so many spines, and they communicate to cross-sections of the septa a characteristic cross-banded appearance. In the *Cyathophyllide*, again, the entire visceral chamber is filled with a vesicular tissue of convex and inclined cells, which may be regarded as formed partly by dissepiments and partly by tabulae.

Tabulae are in general well developed amongst the *Rugosa* corals, and coexist with well developed septa. In some genera (such as *Amplexus* and *Zaphrentis*) the tabulae are "complete," that is to say, they pass completely across the visceral chamber from side to side, thus dividing it into a succession of distinct stories, of which only the uppermost is occupied by the living tissues of the animal. In a greater number of cases (e.g., *Cyathophyllum*, *Lithostrotion*, *Lonsdaleia*, *Heliophyllum*, &c.), the tabulae are "incomplete," that is to say, they do not extend across the visceral chamber, but are confined to a larger or smaller central area. The central tabulate area may or may not be pierced by a columella; and the septa may either be prolonged across the upper surfaces of the tabulae to the centre of the corallum, or they may fall short of the centre, and thus leave a larger or smaller area of the tabulae free to view, and conspicuously visible in the floor of the calice. The tabulae may be well developed, approximately horizontal, remote plates, as is usually the case in *Zaphrentis* and *Amplexus*, or they may anastomose in various ways, and become so intimately connected with one another as to give rise to a species of vesicular tissue.

As regards the affinities of the *Rugosa* corals, doubts have of late years been expressed as to their systematic position and relationships. By Professor Louis Agassiz the entire order of the *Rugosa* was transferred from the *Actinozoa* to the *Hydrozoa*, but upon insufficient evidence. It had been observed by Agassiz that the living animal of *Millepora* was apparently a hydroid, closely allied to *Hydractinia*, and it was upon the strength of this observation alone that the distinguished American naturalist proposed this sweeping change. The following considerations show, however, that this change cannot be accepted. (1) *Millepora* is not a *Rugosa* coral, but belongs to the so-called Tabulate corals, of which it constitutes a very aberrant member. Even, therefore, were it satisfactorily proved that the genus *Millepora* is a true *Hydrozoön*, as to which naturalists are not yet agreed, this would not affect the classification of the *Rugosa*, which are very distinct in their structure from the *Tabulata*, and have no affinities with them further than is implied by the fact that tabulae are present in both. (2) It has been shown that the group of the *Tabulata* itself contains both true *Zoantharia* and true *Alcyonaria*, so that the hydroid character of *Millepora*, if admitted, would not so much as cause the removal of the *Tabulata* to the *Hydrozoa*. (3) It has further been shown that tabulae are present in certain forms which are unquestionably *Actinozoa*, as shown by an examination of the living ani-

mal (*Pocillopora* and *Lophohelia*). It is evident, therefore, that the presence of tabulae in itself should have no weight in determining the systematic position of any given form, unless at the same time the structure of the living animal be known. (4) Apart from the close similarity between the corallum of the *Rugosa* and that of the recent *Zoantharia sclerodermata*, the *Rugosa* corals are provided, almost invariably, with structures which, so far as we know, are absolutely irreconcilable with the belief in their Hydrozoal affinities. They possess, namely, in almost all cases, well developed *septa*, which, if they do not absolutely imply the existence of *mesenteries* in the living animal, are, at any rate, wholly unknown as occurring amongst the recent *Hydrozoa*. We may, therefore, safely accept the conclusion of Verrill, Pourtales, Claus, Duncan, Milne-Edwards, and other distinguished authorities, that Agassiz has failed to bring forward sufficient evidence in favor of his view that the *Rugosa* are referable to the *Hydrozoa*.

More lately Dr. Lindström has endeavored to show that the *Rugosa* cannot be placed amongst the *Actinosa*, but "must form a class of their own in the great division of the Radiated Animals." The chief grounds upon which this conclusion is reached are "the compact imperforate structure of the calyx and septa (the septa originating from four primary ones), the absence of costae, the strange septal fossae in the bottom of the calyx, the processes resembling rootlets, the transverse floors or tabulae in the interior, which often have a cellular or vesicular structure," and the occasional presence of an operculum. It is obvious, however, that none of the above-mentioned peculiarities are of such fundamental importance as to justify us in overlooking the substantial identity of structure which subsists between the corallum of the *Rugosa* and that of the Aporose section of the *Zoantharia sclerodermata*. The wall and septa are often compact amongst the latter; the septa have a tetrameral arrangement in the unquestionable living *Actinosa*, *Haplophyllia* and *Gygnia*; the septal fossula is not always recognizable amongst the *Rugosa*; the presence of rootlets and the nature of the costae are points of secondary importance; tabulae are present in undoubted corals belonging to the *Zoantharia sclerodermata*; and the occasional presence in some abnormal forms of an operculum would no more justify us in removing the *Rugosa* from the *Actinosa* than we should be warranted for the same reason in removing the living *Primnoa* from the *Alcyonaria*. Upon the whole, then, there appears to be little danger in accepting the conclusion reached by Professor Verrill, one of the most distinguished of living authorities on the subject, that there can no longer be any reasonable doubt but that the coralla of the great majority of the *Rugosa* were made by "true polypes essentially similar to those of the existing corals." Indeed, if any great change in our classification is to be made, it would seem rather to be in the direction of more closely approximating the *Rugosa* to the *Zoantharia sclerodermata*. The tetrameral arrangement of the septa is by no means always very conspicuous amongst the *Rugosa*, and it seems not unlikely that too high a classificatory value has been attached to it. Leaving this out of account, the affinities of the typical *Rugosa* with the *Aporosa* are very close, and it may be doubted if it would not be proper to establish a more intimate union between these groups. At the same time, it must not be overlooked, as pointed out by Moseley, that the *Rugosa* have certain affinities with the *Alcyonaria*, and especially with singular recent *Heliopora*. Great stress, however, can hardly be laid upon the existence of paired opercular structures in *Goniophyllum* and in the existing Alcyonarian genus *Primnoa*, since *Goniophyllum*, if a *Rugosa* coral at all, must be referred to the *Cystiphyllidae*, a family in which all the more characteristic features of the *Rugosa* organization have disappeared.

The divisions of the *Rugosa* recognised and founded by Milne-Edwards and Jules Haime, and subsequently generally adopted, are the following:—

Fam. I. STAVRIIDÆ.—The wall is well developed; the septa lamellar, extending without interruption from the bottom to the top of the visceral chamber, and showing a conspicuous quaternary arrangement. The interseptal loculi are crossed by endothelial dissepiments, and there is a central tabulate area. Of the five genera which form the family, *Stavria* has a compound corallum, astriform in shape, and increasing by calicular gemination; there is no columella; and the four primitive septa form a conspicuous cross. *Holocystis* is also composite and astriform,—the corallites being united by well developed costae, and a styliform columella being present. Of the simple genera, the Permian *Polycalia* and the Tertiary *Conosmilia* are closely

allied to one another; but the third, *Metriophyllum*, is so aberrant that it may require to be placed in a separate family, as its septa are arranged in four distinct groups, separated from one another by four distinct fossulae.

Fam. II. CYATHAXONIDÆ.—In this family the corallum is simple, with a deep calice; the septa are well developed, and extend from the bottom of the visceral chamber to the floor of the calice; the interseptal loculi are completely open, and there are neither dissepiments nor tabulae. Though exhibiting a quaternary arrangement, the four primary septa are not conspicuously developed above the others. This family makes an exceedingly close approach to the Aporose group of the *Turbidolites*, from which it is separated by the tetrameral arrangement of the septa. Of the genera of the family, *Cyathaxonia* is Palaeozoic, whilst *Haplophyllia* and *Gygnia* are recent. No Secondary or Tertiary forms are as yet known.

Fam. III. CYATHOPHYLLIDÆ.—In this family the corallum is simple or compound; and the septa are always more or less interrupted, and do not extend as complete lamellae from the bottom to the top of the visceral chamber, being more or less imperfect either internally or externally. The four primitive septa are not pre-eminently developed, so as to give rise to a conspicuous cross. The interseptal loculi are generally more or less interrupted by the development of dissepiments, and tabulae are invariably present. The family of the *Cyathophyllidae* is divided by Milne-Edwards and Haime into the two tribes of the *Zaphrentinae* and the *Cyathophyllinae*.

a. *Zaphrentinae*.—In this tribe the corallum is simple and free; a well-developed septal fossula is present, which may be formed by a tubular inflexion of the tabulae on one side, or may be replaced by a cristiform process. The septa usually fall short of the centre of the visceral chamber, and, from the presence of a septal fossula, are invariably more or less irregular in their arrangement. The tabulae are complete, and pass from one side of the visceral chamber to the other; while dissepiments are poorly developed, and there is usually nothing of the nature of a columella. The *Zaphrentinae* are exclusively Palaeozoic, and the principal genera of the family are *Zaphrentis*, *Amplexus*, *Menophyllum*, *Lophophyllum*, *Anisophyllum*, *Baryphyllum*, *Hadrophyllum*, *Microcycelus*, *Combophyllum*, *Trochophyllum*, *Aulacophyllum*, *Hallia*, and *Streptelasma*.

b. *Cyathophyllinae*.—In this family the septa do not exhibit the irregularity which is so conspicuous in the *Zaphrentinae*, but are more or less regularly radiate in their arrangement. In some cases, the septa may be equally divided into four groups by four shallow fossae in the calice. A true columella may be present or absent, or there may be a pseudo-columella formed by the twisting together of the inner edges of the septa. A more or less well-developed zone of vesicular tissue, formed by endothelial dissepiments, is usually found on the exterior of the visceral chamber; and the tabulae are not complete, but occupy a more or less extensively developed central area. The corallum may be simple or compound. All the *Cyathophyllidae* are Palaeozoic, and the principal genera are *Cyathophyllum*, *Campophyllum*, *Omphyma*, *Pachyphyllum*, *Onophyllum*, *Psychophyllum*, *Heliophyllum*, *Palaeocylus*, *Oliotriphyllum*, *Dibunophyllum*, *Aspidophyllum*, *Rhodophyllum*, *Aulophyllum*, *Cyclophyllum*, *Acerularia*, *Svombodes*, *Phillipsastrum*, *Smithia*, *Endophyllum*, *Spongophyllum*, *Syringophyllum*, *Eridophyllum*, *Diphyllum*, *Lithostrotion*, *Lonsdaleia*, *Chonacis*, *Azophyllum*, *Konicophyllum*, &c.

Fam. IV. CYSTIPHYLLIDÆ.—The corallum in this family is simple, or rarely compound; the septa are rudimentary, and are generally only recognisable as so many vertical striae within the calice. The outer wall is complete, but the entire visceral chamber is filled with small convex vesicles, sometimes arranged in infundibuliform layers, and formed by the dissepiments and tabulae in combination. A distinct septal fossula may or may not be present. The entire family is Palaeozoic, and the only undoubted genus *Cystiphyllum* itself. In their internal structure, however, the singular operculate corals of the genera *Goniophyllum*, *Rhisophyllum*, and *Calceola* present striking affinities with the *Cystiphyllidae*, whilst a species of the genus *Cystiphyllum* (*C. prismaticum*) has been described by Lindström as being furnished with an operculum. We may, therefore, with great probability, refer the above mentioned abnormal genera to this family of the *Rugosa*. It should be borne in mind that the *Cystiphyllidae*, with or without *Goniophyllum* and its allies, are such abnormal forms that it is difficult to assert positively that they belong to the *Rugosa*, and it remains possible that they should be separated to form a special group.

As regards their geological distribution, the *Rugosa* corals have a vast development in the seas of the Palaeozoic period, where they seem to take the place, to a large extent at any rate, of the Aporose section of the *Zoantharia sclerodermata*. In the Secondary period only one genus (*Holocystis*) of the *Rugosa* is known, and but one is known in the Tertiary rocks (*Conosmilia*), whilst the only two living genera which could be referred here are the *Haplophyllia* of Florida and the *Gygnia* of the Mediterranean.

In the Silurian period the *Rugosa* are very largely developed, especially in the upper division. The principal genera of this period are—*Cyathophyllum*, *Zaphrentis*, *Cyatiphyllum*, *Streptactasma*, *Acerularia*, *Strombodes*, *Omphyma*, *Palaeocyclus*, *Diphyphyllum*, *Amplexus*, *Ptychophyllum*, *Stauria*, *Syringophyllum*, *Goniophyllum*, *Rhizophyllum*, and *Pholidophyllum*. [The Lower Silurian *Columnaris* with complete septa (*Favistella*) are probably Aporose corals; *Columnopora* is perhaps one of the *Perforata*; and *Petraia* and *Duncanella* are in a somewhat dubious position.] In deposits of Devonian age, Rugose corals are exceedingly abundant, the principal genera of this period being *Cyathophyllum*, *Heliophyllum*, *Diphyphyllum*, *Eridophyllum*, *Campophyllum*, *Endophyllum*, *Pachyphyllum*, *Phillipsastræa*, *Acerularia*, *Smithia*, *Spongophyllum*, *Blotrophyllum*, *Zaphrentis*, *Baryphyllum*, *Aulacophyllum*, *Antiochyllum*, *Trochophyllum*, *Combophyllum*, *Hædorphyllum*, *Microcyclus*, *Hallia*, *Metricophyllum*, and *Amplexus*. In the Carboniferous period the Rugose corals still remain very abundantly represented by forms belonging to such genera as *Cyathophyllum*, *Lithostroton*, *Diphyphyllum*, *Lonsdaleia*, *Azophyllum*, *Chitiochyllum*, *Cyclophyllum*, *Rhodophyllum*, *Zaphrentis*, *Amplexus*, *Lophophyllum*, *Menophyllum*, *Campophyllum*, *Phillipsastræa*, &c. In the Permian rocks, which so far have proved to be extremely uncoralliferous, no examples of the *Rugosa* are known save the genus *Polycaelia*, so far at any rate as Britain is concerned. In the great series of the Secondary formations no *Rugosa* are as yet known save two species of the single genus *Holocystis* of the Lower Cretaceous. In the great series of the Tertiary deposits, again, there has hitherto been discovered only a single Rugose genus, the *Conosmilia* of the later Tertiaries of Australia.

### ORDER III.—ALCYONARIA (*Octocoralla*.)

The members of this order are *Actinosea* in which the polypes possess eight tentacles, which are fringed on their sides with lateral pinnae, or papillae. As in the *Zoantharia*, the mouth opens into a tubular stomach, which in turn communicates freely with the body-cavity, and the stomach is connected with the body-wall by means of a series of vertical membranous laminae or mesenteries. The mesenteries, however, are only eight in number, and are not paired, one of the tentacles corresponding with and opening into each inter-mesenteric chamber. As a general rule a corallum is secreted, though this may be wanting, and its nature differs in different cases. In some forms (*Alcyonium*, *Xenia*, &c.) the corallum is sclerodermic, and consists of variously-formed spicules of lime scattered in the soft tissues. In others (*Tubipora*) the corallum is external and sclerodermic, with true thecae, but without septa or tabulae, and formed of fused spicules, detached structures of the same nature existing in the soft parts. In others (*Heliopora*) the corallum is external and sclerodermic, with true thecae provided with septa and tabulae. In others, finally (*Gorgonia*, *Corallium*, *Pennatula*, &c.), there is double corallum, the one consisting of a calcareous or horny sclerobasis, over which the soft parts are spread, the other consisting of sclerodermic spicules scattered in the integuments. With the exception of the single genus *Haimenia*, which is possibly not a mature form, all the *Alcyonaria* are composite. The tubular polypes are united by a cœnosarc, and their body-cavities are placed in communication by means of canals which ramify through the cœnosarc, and permit of a free circulation of nutrient fluids. The form of the colony varies greatly in different cases, being usually more or less branched, arborescent, or lobate, but being at other times massive, incrusting, creeping, linear, &c. None of them possess the power of independent locomotion, most being rooted to foreign objects in their adult condition, but some being simply sunk in the mud, and a few floating freely in the sea. Many of them exhibit the most brilliant coloration, due in many instances to the brightly-colored spicules disseminated in their tissues. In some, lastly, it has been shown that the colony normally consists of two kinds of polypes, one sexual, the other sexless and permanently rudimentary. The *Alcyonaria* may be briefly discussed under the five following families:—

**Fam. I. ALCYONIDÆ.**—The members of this family are all fixed to foreign objects, and are more or less fleshy in their consistence, owing to the fact that the corallum consists simply of sclerodermic spicules scattered in the integuments, and there is no sclerobasis. The spicules are of various forms, but principally fusiform, and they are scattered through the cœnosarc and the soft tissues generally, but are often specially aggregated at the bases of the tentacles and along the tentacles themselves. The spicules may be present in very small numbers (as in some

species of *Spoggodæ*), but they may be present in such numbers as to render the surface rough and prickly (as in *Nephtya*, *Parasolenium*, and the typical species of *Spoggodæ*). The actinosoma may form lobate masses within which the polypes can be retracted at will (*Alcyonium*), or more or less branched and having the polypes non-retractile (*Xenia*). Others form membranous crusts, attached to foreign bodies, the polypes being sometimes retractile (*Anthelia*), sometimes non-retractile (*Sympodium*). Others form a creeping colony of slender stolons, sending up polypes at different points, the lower portion of the colony being so thickened by spicular secretions as to constitute a kind of tubular corallum into which the polypes can withdraw (*Cornularia*). In the genus *Sarcophyton*, lastly, it has recently been shown (Mosely) that the colony, like that of many of the *Pennatulidæ*, is dimorphic, consisting partly of sexually perfect polypes, and partly of soûids which are destitute of generative organs and of tentacles. The soûids, however, have a stomach and mouth, and are connected with the perfect polypes by a canal-system.

**Fam. II. TUBIPORIDÆ.**—This forms a very small family, including only the various species of the "Organ-pipe corals" (*Tubipora*), and often included with the preceding, to which it is closely related. In the common *Tubipora musica*, which may be taken as the type of the family, there is a very well developed sclerodermic corallum, with true thecae enclosing the polypes, but without septa. The corallum is bright red in color, and is composed of tubular, cylindrical thecae, usually growing regularly side by side, but at a little distance from one another, and united at intervals by horizontal epithelial expansions, which represent external tabulae. There are no septa, nor internal tabulae; and Dr. Perceval Wright has shown that the tubes are really composed of fused spicules. The polypes are green, with eight pinnate tentacles studded with lenticular spicules. The polypes when alarmed retract themselves within their tubes, the upper portion of the tube, as shown by Dr. Wright, being composed of fusiform warty spicules which are

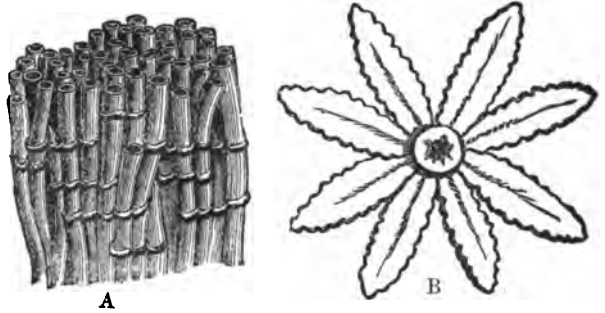

FIG. 12.—Tubiporidae.

A, Portion of the corallum of *Tubipora musica*, of the natural size, showing the tubular corallites and the exothecal tabulae. B, Polype of the same, greatly enlarged, showing the mouth and tentacles.

loose, and thus allow this part to be pulled into the lower dense portion of the theca. The mouth is placed between the bases of the tentacles, with a slightly elevated lip, and leads into a small stomach-sac. There are eight mesenteries, within which the reproductive organs are contained. The exothecal expansions, by which the tubes are united, appear to be produced periodically as horizontal extensions from the mouths of the tubes.

**Fam. III. PENNATULIDÆ.**—The "Sea-pens" and "Sea-rods" are compound *Alcyonaria*, but instead of being rooted to some foreign object, they possess a fleshy, usually columnar or rod-like base, which is non-polypiferous, and is plunged in the sand and mud of the sea-bottom. The upper portion of the colony carries the polypes, and varies much in shape. Sometimes the polypes are borne on long lateral pinnae, which give the upper portion of the actinosoma a feather-like appearance (*Pennatula*); whilst at other times there are similar but much shorter pinnae (*Virgularia*). In *Veretillum* the upper portion of the colony is short and clubshaped, and carries the polypes all around its circumference, and the same is the case in *Cophobelemnon*. In *Pavonaria* the polypes are non-retractile, and are disposed on one side of the slender actinosoma; whilst in *Renilla* the polypes are also unilaterial, but the polypiferous surface is thin and reniform. In *Umbellularia*, the polypes are carried in a cluster at the top of the actinosoma. The corallum in the *Pennatulidæ* is usually two-fold, consisting on the one hand of a slender, styliform, horny, or calcareous axis (sclerobasis) concealed within the cœnosarc, which it serves to support, and, on the other hand, of small calcareous spicules scattered amongst the softest tissues. In some cases the sclerobasis is rudimentary. The *Pennatulidæ* often possess the power of phosphorescence in a high degree, and they possess the same system of cœnosarc canals as is characteristic of the *Alcyonaria* generally. The polypes have eight

pinnately-fringed tentacles, and eight mesenteric folds. In many cases, as originally shown by Kölliker, the colony consists of two classes of zooids, the one composed of sexually mature polypes, the other, more numerous, composed of sexless polypes, in which the tentacles are not developed.

Fam. IV. GORGONIDÆ.—The "Sea-shrubs" possess a more or less branched œcosarc, which is permanently rooted to some foreign object, and is provided with a grooved or sulcate branched sclerobasis, with which are associated true tissue-secretions in the form of variously shaped sclerodermic spicules ("sclerites"). As regards their soft parts, the *Gorgoniidæ* do not differ from the other *Alcyonaria*, the polypes possessing eight fringed tentacles, with eight mesenteries, united by a canal system, which ramifies through a fleshy œcosarc. The œcosarc, however, is always closely applied to, and supported by, a more or less branched sclerobasis, over which it forms a thin fleshy expansion ("cortex"), and the polypes are capable of complete retraction within the œcosarc. The soft tissues are also abundantly supplied with true sclerodermic secretions in the form of calcareous spicules of very various shapes, and often of very brilliant colors, which are in many instances so characteristic in their form that they can be employed as a ground of generic distinction. The spicules ("sclerites") are usually buried in the soft tissues, but they may project beyond the surface of the œcosarc in such numbers as to render the integument rough and scoriaceous (*Muricea*). The sclerobasis varies greatly both in texture and form. Sometimes it resembles that of the *Antipathidæ* in being corneous and unjointed, but its surface is always striate or grooved, whereas in the "Black Corals" it is smooth or echinulate. Its form is usually more or less branched, dendroid, or minutely arborescent (as in *Primnoa*, *Muricea*, *Gorgonia*, *Leptogorgia*, &c.), or it may be in the shape of a regularly reticulate flabelliform expansion (*Rhipidogorgia*). In the genus *Isis* the sclerobasis is branched and articulated, composed of alternating calcareous and horny joints, and hav-



FIG. 13.—Pennatulidæ.

Colony of *Veretillum cymosorum*, Linn., of the natural size, with the polypes protruded.

and densely calcareous. It is of a red or pink color, and finely grooved upon its surface; and it is really composed of fused spicules, and thus differs very materially from the true sclerodermic corallum. The calcareous axis is covered with a bright red œcosarc or cortex, which is studded by the apertures for the polypes. The polypes are milk-white in color, with eight pinnately-fringed tentacles, and completely retractile within the fleshy bark. The polypes are further placed in direct communication by means of anastomosing canals channelled out of the œcosarc and filled with a nutrient fluid. It has been shown by Lacaze-Duthiers that the colonies of *Corallium* are sometimes composed of male polypes, sometimes of female, or occasionally all the polypes of some branches of a colony may be of one sex, and all the polypes of other branches of the opposite sex, whilst in some instances polypes occur which are hermaphrodite and combine in themselves the organs of both sexes.

Fam. V. HELIOPORIDÆ.—An examination of the living *Heliopora* in its fresh state has recently induced Mr. Mosely to found

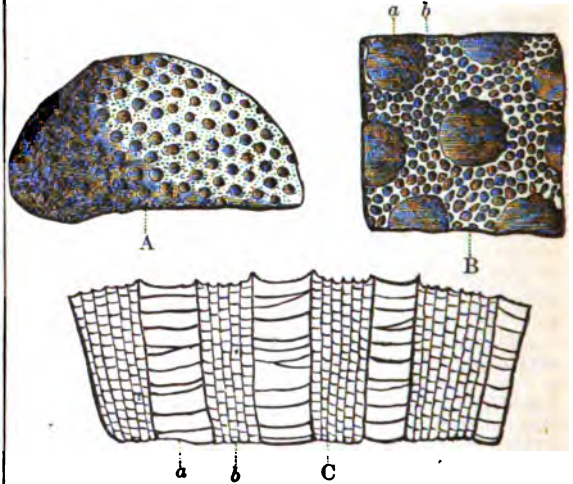

FIG. 15.

A, Small colony of *Heliolites megastoma*, M'Coy, of the natural size. B, Small portion of the surface of the same, magnified, showing the calices (a) and œconenchymal tubuli (b). C, Vertical section of the same, enlarged, showing the tabulate corallites and the tabulate tubes of the œconenchyma.

this family for the reception of the existing genus *Heliopora* and a number of extinct forms previously placed amongst the *Tabulata*. In *Heliopora* there exists a well-developed sclerodermic corallum, of a composite nature, and composed of corallites united by well-developed tabulæ, and having their walls folded in such a manner as to give rise to a variable number (generally twelve) of septal laminae. The œconenchyma is composed of slender tubes, of smaller size than the true corallites and packed closely side by side. The œconenchymal tubuli are destitute of septa, but, like the corallites, are crossed by regular transverse tubulæ. The sclerenchyma is not composed of fused spicules, as in *Corallium* and *Tubipora*, but of fibrocrystalline calcareous tissue, as in the *Zoantharia sclerodermata*. The soft parts occupy only the parts of the corallum above the uppermost tabulæ, and therefore only a surface-layer of the colony is actually alive. The polypes are completely retractile, with pinnately-fringed tentacles, which are introverted in retraction. There are also eight lobed mesenteries, but these in no way correspond with the septa, the latter being twelve in number. The septa are thus seen to be pseudo-septa, and they cannot be regarded as homologous with the septa of the *Zoantharia sclerodermata*. The œconenchymal tubes are occupied by sacs lined by the endoderm, which are closed externally but communicate freely with the somatic cavities of the polypes by means of transverse canals. Mr. Mosely suggests, with great probability, that the sacs lining the œconenchymal tubes are really of the nature of aborted polypes. (A similar suggestion was put forth by the present writer with regard to the œconenchymal tubuli of *Heliolites* and its allies, upon other grounds. (*Trans. Roy. Soc. Edin.*, vol. xvii. p. 248.)

The investigations and discoveries of Mr. Mosely with regard to *Heliopora* are of special interest, as settling the true position of a number of fossil corals, which had previously been placed in the Tabulate division of the *Zoantharia sclerodermata*, but which must now be referred to the *Alcyonaria*. The discovery, also, of tabulæ combined with a genuine sclerodermic corallum in an undoubted *Alcyonarian* further raises a question as to the true affinities not only of the *Tabulata* generally, but also of



FIG. 14.—Red Coral (*Corallium rubrum*), of the natural size, and a portion enlarged.

ing the new branches produced from the calcareous nodes. In *Melithæa* and *Mopsea*, again, the corallum is likewise branched and articulated; but the joints are alternately hard and soft; the hard joints being composed of fused calcareous spicules, and the flexible joints of horny matter intermixed with calcareous spicules and connective tissue, whilst the new branches are developed from the corneous segments. Lastly, in Red Coral (*Corallium*) the sclerobasis is unjointed, more or less branched,

the *Rugosa*; whilst the discovery of septa which do not correspond with the mesenteries of the living animal will produce important results in the study of the fossil corals generally. Without entering into any of these questions here, there can be no doubt but that the extinct genus *Heliolites* and its allies are so closely related to *Heliopora* as to necessitate their being placed in the *Aleyonaria* as members of the family *Helioporidae*. In the genus *Heliolites* there is a well-developed sclerodermic corallum, the corallites being tubular, regularly tabulate, and usually with well-developed septa, whilst the coenenchyma is composed of tabulate, geometric tubuli, smaller than the corallites and without septa. In the genus *Plasmopora* the corallum is very similar to that of *Heliolites*, differing chiefly in the fact that the coenenchyma is more vesicular, and the tubuli are not so distinct. *Propora*, again, can hardly be separated from *Plasmopora*, its chief distinction being that the calices are exsert. *Lycellia*, also, is closely related to *Heliolites*. *Polytremacia*, also, differs from *Heliolites* chiefly in its granular surface, and it is hardly separable from *Heliopora* except by the fact that its septa are more developed. Finally, there are various extinct genera, such as *Fistulipora*, *Callopora*, &c., which have very close relationship to *Heliolites*, though they are destitute of septa, and which very probably will have to be ultimately associated in the same group.

With regard to the *distribution in space* of the *Aleyonaria*, it is sufficient to say that they are very widely spread over the globe, occurring in all seas from the warmest to the coldest, and at almost all depths. The *Aleyonida* are for the most part inhabitants of shallow water, but the *Pennatulidæ* are represented up to almost the greatest depths yet sounded by the dredge. The *Gorgonidæ* are principally shallow-water forms, and attain their maximum of development in the seas of the tropics, abounding on coral-reefs, to the beauty of which they greatly contribute. The red coral of commerce (*Corallium rubrum*) is a Mediterranean species, and occurs principally at depths of from 5 to 6 fathoms, though extending its range up to 120 fathoms or more. It is very largely sought after, and obtains a high price for ornamental purposes. The "coral fishery" is carried on by means of machines of different construction, which are dragged over the sea-bottom, and which usually injure more of the coral than they actually bring to the surface. Hence many valuable coral-beds have been completely exhausted, and the industry has no longer the importance that it formerly possessed. The "organ-pipe corals" (*Tubipora*) are confined to the warm seas of the "coral-reef region;" and the genus *Heliopora*, the only living representative of the family *Helioporidæ*, is confined to the Pacific and Indian Oceans.

As regards their *distribution in time*, none of the *Aleyonaria*, except the *Helioporidæ*, can be said to be known with certainty in deposits of Paleozoic age. The genus *Protovirgularia* was founded by McCoy for the reception of a Silurian fossil which he believed to be allied to the living *Virgularia*, but it appears to be certainly not of this nature and is probably a graptolite. The family of the *Helioporidæ* is well represented in the Paleozoic period; the genus *Heliolites* being Silurian and Devonian, *Propora* and *Lycellia* being Silurian, and *Plasmopora* Silurian, and doubtfully Devonian. If *Callopora* and *Fistulipora* be referred to this group, then we may also consider that we have Carboniferous and Permian representatives of it. The genus *Polytremacia*, again, is confined to the Cretaceous period. The family of the *Gorgonidæ* is not known to be represented with certainty earlier than the Eocene Tertiary, two genera (*Mopsea* and *Websteria*) being found in the London clay. The genus *Corallium* has been doubtfully quoted from the Upper Oolites and Upper Cretaceous, and undoubtedly occurs as early as the Miocene. The Miocene deposits have also yielded species of *Inia*, *Gorgonia*, *Gorgonella*, and *Melithæa*. The family of the *Pennatulidæ* is not represented earlier than the latest Secondary or the earlier Tertiary deposits. The genus *Pavonaria* is said to occur in the Pliocene Limestone of France, whilst *Graphularia* (and perhaps *Virgularia*) is found in the Eocene. The Miocene Tertiary has also yielded species of *Virgularia*, *Graphularia*, and *Oculographula*. The family of the *Tubiporida* has not been recognized at all in a fossil condition. Lastly, the past existence of the *Aleyonida* has only been recognized with any certainty in the Pliocene deposits, the Red and White Crags having yielded a species of *Aleyonium*.

**BIBLIOGRAPHY.**—Amongst the more important works and memoirs which may be consulted by the student of recent and fossil corals may be mentioned the following:—Agassiz, Louis,

*Contributions to the Natural History of the United States*, vols. iii. and iv., on "Acalaphæ;" De Blainville, *Manuel d'Actinologie et de Zoophytologie*, 1837; Bronn, *Die Klassen und Ordnungen des Thierreichs (Strahlenthiere)*, vol. ii. parts 1-6, 1859-68; Cuvier, *Règne Animal*, 3d ed. vol. iii., "Zoophytes;" Dana, *Rep. of Wilkes's Expl. Exped.*, "Zoophytes," 1848; also *Corals and Coral Islands*, 1872; Edwards and Haime, *Histoire Naturelle des Coralliaires, ou Polyptes proprement dits*, 1857-60; also by the same, "Recherches sur la Structure et Classification des Polyptiers récents et fossiles," in *Ann. Sc. Nat.*, 1848-52; Ehrenberg, *Beiträge zur Physiologischen Kenntniss der Corallen-thiere im Allgemeinen, und besonders des Rothen Meeres*, Berl., 1834; Ellis, *Essay towards a Natural History of the Corallines*, &c., 1765; Ellis and Solander, *The Natural History of many Curious and Uncommon Zoophytes*, 1786; Gosse, *Actinologia Britannica, A History of the British Sea-Anemones and Madreporæ*, 1860; Greene, *Manual of the Calenterata*, 1861; Johnston, *History of British Zoophytes*, 2d ed., 1847; Külliker, *Icones Histiologicæ, Abth. ii., die Bindesubstanzen der Calenteraten*, 1865; Lacaze-Duthiers, *Histoire Naturelle du Corail*, also "Développement des Coralliaires," in *Archives de Zool. Expérimentale*, 1872-73; Lamarck, *Hist. Nat. des Animaux sans Vert.*, 2d ed., 1836-39; Lamouroux, *Exposition Méthodique des genres de l'ordre des Polyptiers*, 1821; also *Histoire des Polyptiers flexibles*, 1816; Leuckart, *Ueber die Morphologie der wirbellosen Thiere*, 1848; Pourtales, "Deep-Sea Corals," No. 4 of the *Illustr. Catalogue of the Mus. of Comp. Zoology*, 1871; Quoy and Gaimard, *Voyage de l'Estrolobe*, also *Voyage de l'Uranie*; Rapp, *Ueber die Polypten im Allgemeinen und die Actinien insbesondere*, 1829. There are also numerous works and memoirs not above referred to by Alexander Agassiz, Louis Agassiz, Allan, Asbjörnson, Brandt, Busch, Claus, Cobbold, Costa, Dalyell, Dana, Darwin, Duncan, Fischer, E. Forbes, Frey and Leuckart, Gosse, Gray, Haime, Hollar, Johnston, Leidy, Lütken, Michelin, Milne-Edwards, Mobius, Mosely, Oersted, Philippi, Pourtales, Quatrefages, Quoy and Gaimard, Rathke, Rütiken, Sars, Schmäder, Schneider, Stimpson, Teale, Verrill, Willemoes-Suhm, Percival Wright, Strethill Wright, and others.

As regards *Coral-reefs*, the following may be consulted:—Dana, *Corals and Coral Islands*, 1872, and "Zoophytes" in *Report of Wilkes's Expl. Exped.*, 1848; Darwin, *On the Structure and Distribution of Coral-reefs*, 1st ed. 1842, 2d. ed. 1874; Chamisso and Von Kotzebue, *Entdeckungs-Reise in die Südpole*, 1815; Ehrenberg, *Ueber die Natur und Bildung der Corallen-inseln und Corallenbänke im Rothen Meere*, Berlin, 1834; also works or papers by Beechey, Couchouy, Flinders, Foster, Jukes, Quoy and Gaimard, Semper, &c.

As regards the *Rugosa* and *Fossil Corals* generally, the following may be consulted:—Bronn, *Lethæa Geognostica*, 1851-1856; De Fromental, *Introduction à l'étude des Polyptiers Fossiles*, 1858-61; D'Orbigny, *Cours Élémentaire de Paléontologie*, 1849; Duncan, *British Fossil Corals, Supplement*, in the *Monographs of the Palæontographical Society (Tertiary and Secondary Corals)*, also *Reports of the British Association*, 1868, 1869, 1871; Dybowski, *Monographie der Zoantharia Sclerodermata Rugosa aus der Silurformation Estlands*, &c., 1873; Edwards and Haime, *Histoire Naturelle des Coralliaires*, 1857-60, also *British Fossil Corals, Monographie of the Palæontographical Society*; Geinitz, *Grundriss der Versteinerungskunde*, 1846; Kunth, *Beiträge zur Kenntniss Fossiler Korallen*, 1870; Michelin, *Iconographie Zoophytologique*, 1840-47; Münster, *Beiträge zur Petrefaktenkunde*, 1840; Pictet, *Traité de Paléontologie*, 2d ed., 1853; Owen, *Palæontology*, 2d ed., 1861; Quenstedt, *Handbuch der Petrefaktenkunde*; Reuss, *Die Fossilen Polyptarien des Wiener Tertiär-beckens*, 1847. In addition to the above, descriptions of various *Rugosa* or other fossil corals are to be found in palæontological and geological treatises, such as—Billings, *Palæozoic Fossils of Canada*, vol. i., 1861-65; De Koninck, *Animaux Fossiles du Terrain Carbonifère de Belgique*, 1842-71; Eichwald, *Lethæa Rossica*, 1855; Goldfuss, *Petrefakten Deutschlands*, 1826-33; Hall, *Palæontology of New York*, 1847, *Geology of Iowa*, 1858, and various *Reports on the State Cabinet*; Hisinger, *Lethæa Suecica*, 1837; Lonsdale in *Siluria*, and Appendix to Murch., Vern., and Keys., *Russia in Europe*; McCoy, *British Palæozoic Fossils*, 1851, *Contributions to British Palæontology*, 1854; *Synopsis of the Carboniferous Fossils of Ireland*, 1844; Meek and Worthen, *Geological Survey of Illinois*, 1866-73; Pander, *Beiträge zur Geognosie des Russischen Reiches*, 1830; Phillips, *Geology of Yorkshire*, vol. ii., 1836, and *Palæozoic Fossils of Cornwall, Devon, &c.*, 1841; Portlock, *Report on the Geology of Londonderry*, &c., 1843; Rømer, *Die Silurische Fauna des Westlichen Tennessee*, 1860; Salter, *Catalogue of Cambrian and Silurian Fossils in the Geological Museum of Cambridge University*, 1873; Sowerby, *Mineral Conchology*, 1822, &c. In addition to the above there are various works and memoirs, wholly or in part occupied with lists or descriptions of fossil corals, and not referred to in the foregoing, by Billings, Bronn, Castelnau, Dale-Owen, Dana, De Koninck, D'Orbigny, Duncan, Dybowski, Edwards (Milne), Eichwald, Fischer von Waldheim, Fougt, Fromental, Haime, Hall, Howse, Keyserling, King, Kunth, Kutorga, Lamarck, Leuckart, Lind-

ström, Linné, Lonsdale, Ludwig, M'Coy, Morren, Morris, Nicholson, Phillips, Reuss, Roemer, Rominger, Safford, Salter, Schlotheim, Schmidt, Schweigger, Steininger, Thomson (James), Tornquist, Verril, Wahlberg, Whitfield, Wright (Dr. Thomas), Zaphrinesque, &c. (M. A. N.)

**INDUSTRIAL USES OF CORALS.**—Beyond their general utility and value as sources of lime, none of the corals present any special feature of industrial importance, excepting the red or precious coral (*Corallium rubrum*) of the Mediterranean Sea. It, however, is and has been from remote times very highly prized for jewelry, personal ornamentation, and decorative purposes generally. About the beginning of the Christian era a great trade was carried on in coral between the Mediterranean and India, where it was highly esteemed as a substance endowed with mysterious sacred properties. It is remarked by Pliny that, previous to the existence of the Indian demand, the Gauls were in the habit of using it for the ornamentation of their weapons of war and helmets; but in his day, so great was the Eastern demand, that it was very rarely seen even in the regions which produced it. Among the Romans branches of coral were hung around children's necks to preserve them from danger, and the substance had many medicinal virtues attributed to it. A belief in its potency as a charm continued to be entertained throughout mediæval times; and even to the present day in Italy it is worn as a preservative from the evil eye, and by females as a cure for sterility.

The precious coral is found widespread on the borders and around the islands of the Mediterranean Sea. The beds are generally from 2 to 10 miles from the land, and in water of about 30 up to 130 fathoms deep; but it finds its most favorable conditions in 80 fathoms water. The most important fisheries extend along the coasts of Tunis, Algeria, and Morocco; but red coral is also obtained in the vicinity of Naples, near Leghorn and Genoa, and on the coasts of Sardinia, Corsica, Catalonia, and Provence. It is said that it attains greater perfection in the east than in the south, and that it is rarely found in a western and never in a northern aspect. It is found attached to rocks embedded in a muddy sea bottom, in which it flourishes more than in a clear or sandy bed. In color it varies through all shades of red, from a deep crimson to a delicate rose pink or flesh color, fine tints of which are very rare and highly prized. It is also sometimes obtained of a milk white color.

From the Middle Ages downwards the securing of the right to the coral fisheries on the African coasts was an object of considerable rivalry among the Mediterranean communities of Europe. Previous to the 16th century they were controlled by the Italian republics. For a short period the Tunisian fisheries were secured by Charles V. to Spain; but the monopoly soon fell into the hands of the French, who held the right till the Revolutionary Government in 1793 threw the trade open. For a short period (about 1806) the British Government controlled the fisheries, and now they are again in the hands of French authorities. Previous to the French Revolution much of the coral trade centred in Marseilles; but since that period, both the procuring of the raw material and the working of it up into the various forms in which it is used have become peculiarly Italian industries, centring largely in Naples, Rome, and Genoa. Although foreign crafts have to pay heavy dues for the right to fish on the Algerian coasts, the great majority of the vessels and crews belong to Torre del Greco. Two classes of boats engage in the pursuit,—a large size of from 12 to 14 tons, manned by ten or twelve hands, and a small size of 3 or 4 tons, with a crew of five or six. The large boats, dredging from March to October, collect from 650 to 850 lbs. of coral, and the small, working throughout the year, collect from 390 to 500 lbs. The Algerian reefs are divided into ten portions, of which only one is fished annually,—ten years being considered sufficient for the proper growth of the coral. No reliable estimates of the amount and value of coral obtained annually exist; but in 1873 the Algerian fisheries alone, employing 311 vessels, manned by 3150 sailors, yielded raw coral valued at £113,000.

The range of value of the various qualities of coral, according to color and size, is exceedingly wide, and notwithstanding the steady Oriental demand its price is considerably affected by the fluctuations of fashion. While the price of the finest tints of rose pink may range from

£80 to £120 per oz., ordinary red-colored small pieces sell for about £2 per oz., and the small fragments called *collette*, used for children's necklaces, cost about 6s. per oz. In China large spheres of good colored coral command high prices, being in great requisition for the button of office worn by the mandarins. It also finds a ready market throughout India and in Central Asia; and with the negroes of Central Africa and of America it is a favorite ornamental substance.

**CORAM, THOMAS (1668-1751)**, an English philanthropist, began life as a seaman, and rose to the position of merchant captain. He settled at Taunton, Massachusetts, for several years engaging there in farming and boat-building, and in 1703 returned to England. His acquaintance with the destitute East End of London, and the miserable condition of the children there, inspired him with the idea of providing a refuge for such of them as had no legal protector; and after seventeen years of unwearied exertion, he obtained in 1739 a royal charter authorizing the establishment of his hospital for foundling infants. It was opened in Hatton Garden, on 17th October, 1740, with twenty inmates. For fifteen years it was supported by voluntary contributions; but in 1756 it was endowed with a Parliamentary grant of £10,000 for the support of all that might be sent to it. Children were brought, however, in such numbers, and so few (not one-third, it is said) survived infancy, that the grant was stopped, and the charity, which had been removed to Guildford Street, was from that time only administered under careful restrictions. Coram's later years were spent in watching over the interests of the hospital; he was also one of the promoters of the settlement of Georgia and Nova Scotia; and his name is honorably connected with various other charities. In carrying out his philanthropic schemes he spent nearly all his private means; and an annuity of £170 was raised for him by public subscription.

**CORAY, ADAMANTIUS (1748-1833)**, a Greek scholar, was the son of a merchant of Smyrna. His grandfather, Professor Rysius, had left a library to whoever of his grandsons should distinguish himself most at school in the study of ancient Greek. Adamantius won the prize, and a strong interest in literature was thence awakened in him. For a time, however, he devoted himself to commerce, carrying on the management of his father's business affairs in Amsterdam. But in 1779 his father's warehouse in Smyrna was destroyed by fire; and Coray was left free to follow his tastes. Two or three years after he removed to Montpellier, where he remained for six years, studying medicine, and supporting himself by translating German and English medical works into French. In 1788 he settled in Paris, where he died forty-five years later, at the age of eighty-five.

Coray's chief works are his editions of Greek authors contained in his *Bibliothèque hellénique* and his *supplément*; and his editions of the *Characters* of Theophrastus, of the *De Aire, Aquæ, et Lociis* of Hippocrates, and of the *Æthiopia* of Heliodorus, elaborately annotated. See Βίος Ἀδαμαντίου Κοραΐ (Paris, 1833); and Ἀπέθνησμα ἐπιστολῶν Ἀδαμαντίου Κοραΐ (Athens, 1839).

**CORBEIL**, a town of France at the head of an arrondissement in the department of Seine-et-Oise, is situated at the confluence of the Essonne with the Seine, about 18 miles S. S. E. of Paris. A bridge across the larger river unites the main part of the town with a suburb on the other side, and a continuous line of houses leads to the village of Essonnes. The church of St. Spire was rebuilt in the 15th century; St. Jean-en-Pisle belonged to the Templars, and dates from the 13th; and the corn-market was erected in 1780 by Viel. The industrial establishments in the town and neighborhood include more than forty flour-mills, and several print-works, cotton-factories, and paper-mills.

From the 10th to the 12th century Corbeil was the chief town of a powerful countship; and it continued for a long time to be an important military post in connection with the commissariat of Paris. Of the numerous sieges to which it has been exposed, the most important are those by the duke of Burgundy in 1418, by the Huguenots in 1562, and by Alexander Farnese in 1590. The population of Corbeil proper in 1872 was 6016, and that of Essonnes, 551.

**CORCYRA.** See CORFU.

**CORDAY D'ARMANS, MARIE-ANNE-CHARLOTTE**, born in 1768, at St. Saturnin near Sées in Normandy, was



descended from a noble family, and numbered among her ancestors the dramatist Corneille. She was educated in a convent, and then sent to live with an aunt at Caen. Here she saw hardly any one but her relative, and passed her lonely hours in reading the works of the *philosophes*, especially Voltaire and the Abbé Raynal. Another of her favorite authors was Plutarch, from whose pages she doubtless imbibed the idea of classic heroism and civic virtue which prompted the act that has made her name famous. On the outbreak of the Revolution she began to study current politics, chiefly through the medium of the papers issued by the party afterwards known as the Girondins. On the downfall of this party, on May 31, 1793, many of the leaders took refuge in Normandy, and proposed to make Caen the headquarters of an army of volunteers, at the head of whom Wimpfenn, the commandant of Cherbourg, was to have marched upon Paris. Charlotte attended their meetings, and heard them speak; but we have no reason to believe that she saw any of them privately, till the day when she went to ask for introductions to friends of theirs in Paris. She saw that their efforts in Normandy were doomed to fail. She had heard of Marat as a tyrant and the chief agent in their overthrow, and she had conceived the idea of going alone to Paris and assassinating him,—doubtless thinking that this would break up the party of the Terrorists and be the signal of a counter-revolution. Apparently she had thought of going to Paris in April, before the fall of the Girondins, for she had then procured a passport which she used in July. It contained the usual description of the bearer, and ran thus: "Laissez passer la citoyenne Marie, &c., Corday, âgée de 24 ans, taille de 5 pieds 1 pouce, cheveux et sourcils châtain, yeux gris, front élevé, nez long, bouche moyenne, menton rond fourchu, visage ovale." Arrived in Paris she first attended to some business for a friend at Caen, and then she wrote to Marat:—"Citizen, I have just arrived from Caen. Your love for your native place doubtless makes you desirous of learning the events which have occurred in that part of the republic. I shall call at your residence in about an hour; have the goodness to receive me, and to give me a brief interview. I will put you in a condition to render great service to France." On calling she was refused admittance, and wrote again, promising to reveal important secrets, and appealing to Marat's sympathy on the ground that she herself was persecuted by the enemies of the republic. She was again refused an audience, and it was only when she called a third time (July 15) that Marat, hearing her voice in the antechamber, consented to see her. He lay in a bathing tub, wrapped in towels, for he was suffering from a horrible disease which had almost reduced him to a state of putrefaction. Our only source of information as to what followed is Charlotte's own confession. She spoke to Marat of what was passing at Caen, and his only comment on her narrative was that all the men she had mentioned should be guillotined in a few days. As he spoke she drew from her bosom a dinner knife (which she had bought the day before for two francs) and plunged it into his left side. It pierced the lung and the aorta. He cried out, "A moi, ma chère amie!" and expired. Two women rushed in, and prevented Charlotte from escaping. A crowd collected round the house, and it was with difficulty that she was escorted to the prison of the Abbaye. On being brought before the Revolutionary Tribunal she gloried in her act, and when the indictment against her was read, and the president asked her what she had to say in reply, her answer was, "Nothing, except that I have succeeded." Her advocate, Chaveau Lagarde, put forward the plea of insanity, but of course he could not sustain it. She was sentenced to death, and calmly thanked her counsel for his efforts on her behalf, adding, however, that the only defence worthy of her was an avowal of the act. She was then conducted to the Conciergerie, where at her own desire her portrait (now in the museum of Versailles) was painted by the artist Hauer. She preserved her perfect calmness to the last. There was a momentary shudder when she saw the guillotine, but she recovered immediately, and placed herself in position under the fatal blade without assistance from any one. The knife fell, and one of the executioners held up her head by the hair, and had the brutality to strike it with his fist. Many believed they saw the dead face blush,—probably an effect of the red stormy sunset. It was the 17th of July, 1793. It is difficult to analyze the character of Charlotte Corday, we know so little of her; but there was in it

much that was noble and exalted. Her mind had been formed by her studies on a pagan type. To Barbaroux and the Girondins of Caen, she wrote from her prison, anticipating happiness "with Brutus in the Elysian Fields" after her death, and with this letter she sent a simple loving farewell to her father, revealing a tender side to her character that otherwise we could hardly have looked for in such a woman.

Every writer on the Revolution has dwelt at more or less length on Charlotte Corday. Many of the current versions of her life are very incorrect and even absurd. Of biographies we may mention that of Couet de Girenville, published in 1796, that of Alphonse Esquiros which attempts a defence of Marat, and Adolphe Huard's *Mémoires sur Charlotte Corday*, 1866. Her letters and her address to the French people were printed at Caen in 1863 under the title of *Œuvres politiques de Charlotte Corday*. Lamartine in his *Histoire des Girondins* has an eloquent eulogy, which ends by styling her "l'ange de l'assassination." She has even less appropriately been called the "Jeanne d'Arc de la Révolution."

CORDELIERS, the name given to the Franciscans in France, from the cords which they wore round their waists; and also the name of a notorious club of the time of the French Revolution, so called because it met in a Franciscan chapel. Early in 1790 this club was thoroughly organized under the presidency of Danton. Among its other members were Marat and Camille Desmoulins, and the latter edited a paper expressing its views, under the name of *Le Vieux Cordelier*.

CORDERIUS, the Latinized form of name used by MATHURIN CORDIER (1478-1564), the author of the well-known *Colloquia*, a native of Normandy. He possessed special tact and liking for teaching children, and taught first at Paris, where Calvin was among his scholars, and, after a number of changes, finally at Geneva. He wrote several books for children; the most famous is his *Colloquia*, which has passed through innumerable editions, being used in schools for three centuries after his time.

He also wrote *Principia Latine Loquendi Scribendique, selectæ ex Epistolis Ciceronis; De Corrupti Sermonis apud Gallos Emendatione et Latini Loquendi Ratione; De Quantitate Syllabarum; Conciones Sacra Gallis; Remonstrances et exhortations au roi et aux grands de son royaume* (Geneva, 1561).

CORDOVA (Latin, *Corduba*; French, *Cordoue*), a city of Spain, capital of a province of its own name in Andalusia, is situated on the southern declivity of the Sierra Morena and the right bank of the Guadalquivir, 75 miles north-east of Seville, and not far from one of the junctions on the railway system of Spain. Its walls, erected on Roman foundations, and principally Moorish in their superstructure, enclose a very large area; but much of the space is occupied by garden-ground cleared from the ruins of ancient buildings. The streets are for the most part so narrow and crooked that it would be much more descriptive to speak of them as lanes; and with the exception of those in the Plaza Mayor, the houses are greatly dilapidated. As every building, however, is profusely covered with whitewash, there is little difference on the surface between the oldest and the most modern specimens. The southern suburb communicates with the town by means of a bridge of sixteen arches across the river, exhibiting the usual combination of Roman and Moorish masonry, and dominated at the one end by an elevated statue of the patron saint, St. Raphael, whose effigy is to be seen in various other quarters of the city. The most important of the public buildings are the cathedral, the old monastic establishments, the churches, the bishop's palace, the lyceum, the city hall, the hospitals, and the colleges. The old royal palace (Alcazar) is in ruins,—only one wing being sufficiently entire to serve the purpose of a prison. The cathedral, which throws all the other churches into insignificance, was originally built as a mosque by Abderrahman I. on the site, it is believed, of a Roman temple. The exterior, with the straight lines of its square buttress towers, has a heavy and somewhat ungainly appearance; but the interior is one of the most beautiful specimens of Moorish architecture in Europe. Passing through a grand courtyard about 500 feet in length, shady with palm, and cypress, and orange-trees, and fresh with the full flow of fountains, the visitor enters a magnificent and bewildering labyrinth of pillars. Porphyry and jasper and marbles of many a tint are boldly combined in a matchless mosaic. Part have come from the spoils of Nîmes or Narbonne

part from Seville or Tarragona, some from the older ruins of Carthage, and others as a present to Abderrahman from Leo of Byzantium. Of different heights, they have been adjusted to their present standard of 12 feet by being either sunk into the soil or lengthened by the addition of Corinthian capitals. Twelve hundred was the number of the columns in the original building; but many have been destroyed, and, according to some accounts, less than 700 remain. They divide the area of the building, which measures 395 feet from east to west by 356 feet from north to south, longitudinally into nineteen and transversely into twenty-nine aisles—each row supporting a tier of open Moorish arches, which in its turn gives the basis for a second pier with its pillars resting on the keystones of the tier beneath. The full height of the ceiling is thus about 35 feet. The Moorish character of the building was unfortunately impaired in the 16th century by the formation in the interior of a *crucero* or high altar and choir, in the Roman style, by the addition of numerous chapels along the sides of the vast quadrangle, and by the erection of a modern tower in room of the old muezzin. The *crucero* in itself is no disgrace to the architect Herman Ruiz, but every lover of art must sympathize with the rebuke administered by Charles V. to the cathedral authorities: "You have built here what could have been built as well anywhere else; and you have destroyed what was unique in the world." Magnificent, indeed, as the cathedral still is, it is almost impossible to realize what the mosque must have been when the worshippers thronged through its nineteen gateways of bronze, and its 4700 lamps, fed with perfumed oil, shed at once light and fragrance through its brilliant

men of noble rank among the colonists, the city obtained the title of *Patricia*; and to this day the Cordovese pride themselves on the purity and antiquity of their descent. The city was the usual residence of the proctor of the province of Bætica, and the seat of one of the four provincial assises. In the wars between Cæsar and the sons of Pompey, Corduba espoused the cause of the latter. After the battle of Munda, it fell into the hands of Cæsar, who avenged the obstinacy of its resistance by putting 20,000 of the inhabitants to the sword; but in the time of Strabo it still ranked as the largest city of Spain. Under the Goths Corduba maintained its importance; and in the person of Hosius, its bishop, it furnished a president for the Council of Nice. Under the Moors it was at first an appanage of the caliphate of Damascus, but it soon became the capital of the Moorish dominions in Spain. At the death of Abderrahman, it is said, perhaps with Arabic exaggeration, to have contained within its walls 200,000 houses, 600 mosques, 900 baths, and numerous public libraries; whilst on the bank of the Guadalquivir, under the power of that monarch, there were eight cities, 300 towns, and 12,000 populous villages. In the beginning of the 13th century the Moorish empire became dismembered, and fell an easy prey to St. Ferdinand of Castile in 1236. Since that period Cordova has gradually declined; and in modern times it has never recovered the assault of the French under Dupont in 1808, who stormed and afterwards pillaged the town. In the Roman period Cordova was the birthplace of Lucan and the two Senecas; and in modern times it numbers among its celebrities Avicenna, Averroes, Juan de Mena, Ambrosio Morales, Cespedes the painter, and Luis de Gongora. It also gives its name to the famous captain Gonzalo de Cordova.

CORDOVA, or CORDOBA, the chief town of a province of the same name in the Argentine Republic, 246 miles by rail from Rosario, in 31° 24' S. lat. and 64° 9' W. long.

It lies in the very heart of the country, and occupies the bottom of a considerable depression to the south of the River Primero. The streets, which cut each other at right angles, are for the most part unpaved, but are furnished with side paths of brick; and the houses are almost all of one story. The cathedral of St. Peter, built by the Italian Jesuit Primoli, ranks among the finest churches in South America, though the interior hardly corresponds to the promise of the outside; and the church of the convent of Santa Catalina is also worthy of notice. The educational institutions are of great and increasing importance, including a university established in the Colegio San Carlos, or old Jesuit monastery, which was built by the same architect as the cathedral; an ecclesiastical seminary, supported by the Government; a national observatory, instituted in 1871; and an academy of sciences. The *cabildo* or Government-house (adorned with a pillared portico), an orphan asylum, two hospitals, and several convents complete the list of the public edifices. The population in 1869 numbered about 28,500, consisting of half-breeds of various degrees, with a considerable predominance of the Spanish type. Since the opening of the railway to Rosario in 1870, the trade of the city, always of some importance, has begun to develop. The exports are mainly hides and wool, and the imports miscellaneous manufactures. Cordova was founded by Cabrera in 1573, and made the capital of the province of Tucuman by Philip V.; its main importance arose from its being the centre of the Jesuit missions of South America and the principal seat of learning on the continent. The revolutionary wars for a time destroyed its prosperity; but latterly it has much recovered. In 1871 it was the seat of a national exhibition.

CORDOVA, a town of Mexico with about 6500 inhabitants, in the province of Vera Cruz, and 57 miles inland from the city of that name. It is situated in a very fertile district near the volcano of Orizava, and trades in tobacco, coffee, sugar, and cotton. Its streets are well paved and regularly laid out; the most of its houses are built of stone, and the cathedral, which occupies one side of a large central square, is a fine edifice, with a highly ornamented interior. The neighborhood abounds in antiquarian remains, and at Amatlan de los Reyes especially there are traces of a temple and a cave, with fragments of carving and pottery.

COREA, a kingdom of Eastern Asia, the greater part of which occupies a peninsula stretching south from the northern portion of the Chinese empire. It is bounded on the N. by the elevated plains of Manchuria, E. by the Sea of Japan, S. by the strait to which it gives its name, and W. by the

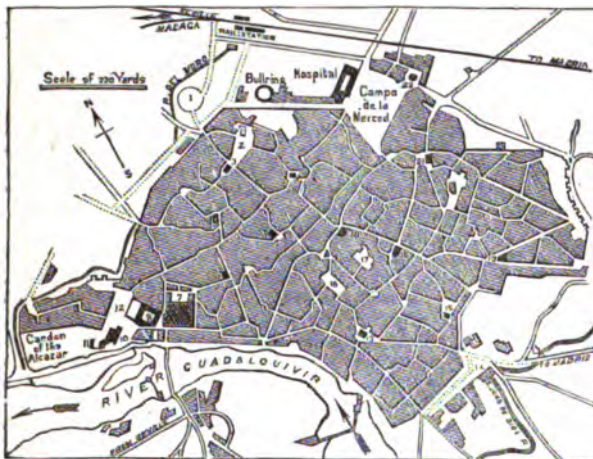

Plan of Cordova.

- |                             |                            |
|-----------------------------|----------------------------|
| 1. Paseo de la Victoria.    | 12. Campo Santo.           |
| 2. F. de S. Martin.         | 13. S. Pedro.              |
| 3. S. Nicolas de Villa.     | 14. Campo S. Anton.        |
| 4. S. Juan.                 | 15. Sta. Maria Magdalena.  |
| 5. Compania.                | 16. Plaza de la Corredera. |
| 6. S. Hippolito.            | 17. Jardin de S. Pablo.    |
| 7. Cathedral.               | 18. S. Andres.             |
| 8. Bishop's Palace.         | 19. S. Lorenzo.            |
| 9. Triunfo and St. Raphael. | 20. S. Pablo.              |
| 10. Alcazar Nuevo.          | 21. Sta. Marina.           |
| 11. Alcazar Viejo.          | 22. Malmuerta Tower.       |

aisles. Of the exquisite elaboration bestowed on the more sacred portions abundant proof is afforded by the small heptagonal chapel of the Mihrab, roofed with a single shell-like block of snow-white marble, and inlaid with Byzantine mosaics of glass and gold.

Cordova was celebrated in the time of the Moors for its silversmiths, who are said to have come originally from Damascus; and it exported a peculiar kind of leather which took its name from the city, whence we have still the word "cordwainer." These industries, however, disappeared with the race that introduced them. In modern times, especially since the opening of the railway to Cadiz and Seville, its industry has developed in various directions, and flax, linen, silk, and woollens are now manufactured. Population, 42,000.

Corduba, probably of Carthaginian origin, was occupied by Marcus Marcellus in 152 B. C., and shortly afterwards became the first Roman colony in Spain. From the large number of

Yellow Sea, and extends from about 34° to 42° 25' N. lat., and from 124° 35' to 130° 50' E. long. The natives assert that it has a length of 3000 lys, or about 1000 English miles, and a breadth of 1300 lys, or about 460 miles; but this is undoubtedly an exaggeration, and the total area is probably a little more than 79,400 square miles, or about 2½ times the size of Scotland.

The eastern coast trends south-west from the confines of Russian Manchuria to the neighborhood of the 39th parallel of latitude, and then, changing its direction to the south-east, it forms an extensive gulf, named Broughton Bay in honor of a navigator of the 18th century. With this exception it presents no remarkable irregularity of line; but even such superficial surveys as have already been effected show that it affords a considerable number of bays and harbors. Of these the most important are Lazaref, Pingai, and Chosan. The first, called Virginia Bay on the French maps, is situated in 39° 25' N. lat., has an area of about 86 square miles, is well protected, and furnishes excellent anchoring ground. The second in 36° 36' is comparatively small, but completely sheltered by a conical island. The third in 35° 2' is large enough to shelter merchant vessels of all sizes and even ships of war below the rank of frigates. Throughout its whole extent the eastern shore presents mainly a succession of steep but not very lofty cliffs, sinking at intervals into irregular dunes, or into stretches of almost level sand. The south and west coasts, on the other hand, are much more varied with inlet and promontory, estuary and peninsula; and the neighboring sea is occupied by a multitude of islands and rocks. Of these islands the largest is Quelpart, with a length of 46 miles and a breadth of about 20; but of greater importance to the navigator is the Port Hamilton group, on account of the excellent harbor to which it partly owes its name.

**Mountains.**—Corea is eminently a mountainous country, and the general appearance of the surface is compared by a French missionary to that of the sea under a strong gale. The principal range winds through the peninsula from north to south. From the northern frontier, till it reaches 37° of north latitude, it keeps pretty close to the eastern coast; but from that point it trends westward, and runs obliquely across the southern extremity of the country, leaving the contour of the coast to be defined by a subordinate range. Of individual summits the highest known to Europeans are Hien-fung and Tao-kwang in the Pepi Shan Mountains, to the north of Broughton Bay; and these attain no greater elevation than 8114 and 6310 feet respectively. Another of special mark, called Sedlovaya or the Saddle, by the Russian navigators, is situated in 38° 10' 30" N. lat. The country to the west of the main ridge is occupied by irregular spurs; and throughout its whole extent there is no district that can properly be described as a plain.

**Rivers.**—Corea is well furnished with rivers and streams. In the north the boundary line is mainly marked by two of considerable size, the Ya-lu-kiang and the Mi-kiang. The former, known to the Chinese as the Aye-kiang, and to the Coreans as Am-no-kang, or the river of the Green Duck, receives numerous affluents in the early part of its course, flows first north-west and then south-west, and falls into the Yellow Sea by three distinct mouths. Its most important tributary, the Tong-kia-ula, comes from the Shan-ain Mountains in Manchuria, and forms its junction about 40° 50' N. lat. The Mi-kiang, called by the Coreans Tu-man-kang, has a very much shorter course than the Ya-lu-kiang, but owing to the number of its tributaries, it attains no mean proportions before it reaches the eastern sea in 42° 19' 5" N. lat. and 130° 38' 51" E. long. At its mouth it is about half a mile wide, and at Hung-chung 300 yards, with a depth of about 20 feet in the middle. Its current is about 1½ knots an hour. Of the numerous streams that find their way to the Sea of Japan none require special mention till we come to the Nak-tong-kang, which rises in the eastern slopes of the main chain, and after flowing almost directly south, reaches the strait of Corea in 34° 50' N. lat. Among those of the western coast three at least are of considerable magnitude—the Keum-tang, the Hang-kang, on which Seoul, the capital of the

kingdom, is situated, and the Tai-tang-kang, which flows past the city of Pieng-iang.

**Climate and Agriculture.**—The temperature of Corea, though much more equable than that of the neighboring continent, is higher in winter and lower in summer than under the same latitudes in Europe. Such advantages as it actually has over the climate of Northern China are mainly due to the effects of the south-west monsoon. In the north the rivers remain frozen for several months in the year, and even in the furthest south the snow lies for a considerable period. In latitude 35° the lowest reading of the thermometer observed by the French missionaries was 5° Fahr.; in 37° or 38° they often found it 13° below zero. The principal articles of cultivation are rice, wheat, millet, rye, tobacco, cotton, hemp, and ginseng; and of these several afford a good return. The potato, which was recently introduced, is under a Government interdict, and

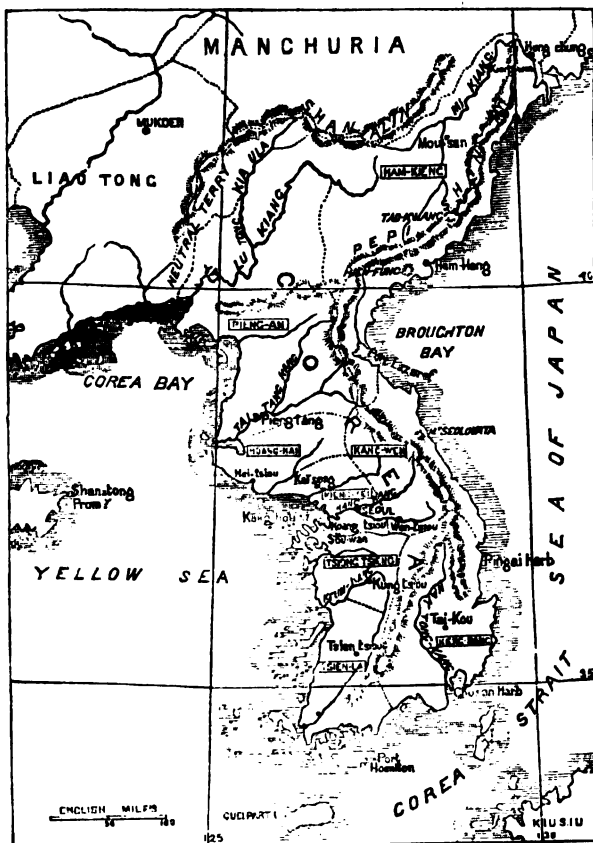

Sketch Map of Corea.

is only to be found in outlying districts; though its general use might do much to prevent the recurrence of the famines with which the country is ever and anon visited. Almost all the fruits of central Europe are to be obtained; but their quality is greatly deteriorated by the humidity of the climate. Water-melons and the fruit of the *Diospyros Lotus* (called kam by the natives) are mentioned as the best.

**Minerals.**—Corea has the reputation of being richly furnished with mineral resources; gold, silver, copper, iron, and coal are all said to be common. Gold-mining, however, is strictly prohibited; the permission at one time granted to work the silver ore at Sioun-heng-fu was shortly afterwards withdrawn; the copper mines are neglected, and Japanese copper imported; and the general use of coal is confined to certain districts.

**Animals.**—Of the wild animals the most remarkable are a small species of tiger, the bear, and the wild boar; and of the domestic kinds the principal are cattle, horses of diminutive proportions but considerable strength, swine, and dogs. The last are a favorite article of food. The king alone has the right of rearing sheep and goats, which

are kept for the purpose of being sacrificed in religious ceremonials.

*Political Divisions and Towns.*—The kingdom of Corea is divided into eight provinces, of which three, Ham-kieng, Kang-wen, and Kieng-sang, lie along the eastern side of the Peninsula, while the others, Pieng-an, Hoang-nai, Kieng-kei, Taiong-tsieng, and Taien-la, face the Yellow Sea. Ham-kieng and Pieng-an are the two that border on Manchuria. The former contains fourteen walled towns, among which may be mentioned Ham-heng, the provincial capital, Kieng-wen, and Mou-san; and the latter, with its centre at Pieng-ang, possesses an equal number. The chief town of Kang-wen is Wen-tsiou, situated in the heart of the country to the east of the River Hang-kang; that of Kieng-sang is Tai-kou, near a tributary of the Nak-tong-kang; of Hoang-hai, Hai-tsiou on the western coast. Hang-ang, Seoul, or Seyool, the chief town of Kieng-kei, is also the capital of the kingdom and the permanent residence of the court; it is situated on the Hang-kang, and surrounded with high and thick walls, 9975 paces in circuit. The chief towns of the two remaining provinces are respectively Kong-tsiou near the River Keum-kang, and Tien-tsiou, at the foot of the range of mountains that traverse the province.

The king of Corea, though a vassal of the Chinese empire, is within his own country an absolute monarch, with power of life and death over the noblest of the land. He is the object of almost divine honors; it is sacrilege to utter the name which he receives from his suzerain, and that by which he is known in history is only bestowed upon him after his death by his successor. To touch his person with a weapon of iron is high treason; and so rigidly is this rule enforced that Tieng-tsong-tai-oung suffered an abscess to put an end to his life in 1800 rather than submit to the contact of the lancet. Every horseman must dismount as he passes the palace, and whoever enters the presence-chamber must fall prostrate before the throne. Should the ignoble body of a subject be touched by the royal hands, the honor thus conferred must be ever after commemorated by a badge. In consequence of such punctilious etiquette, personal access to the king is exceedingly difficult; but as, according to theory, his ear ought always to be open to the complaints of his people, an appeal to his authority is nominally permitted. He is expected to provide for the poor of his realm, and there are always a large number of pensioners on the royal bounty. The princes of the blood are most jealously excluded from power, and their interference in the slightest degree in a matter of politics is regarded as treason. The nobles, however, have within the present century extended their influence, and infringed on the royal prerogative. The palaces are poor buildings, but an extensive harem and a large body of eunuchs are maintained.

The government is practically in the hands of the three principal ministers of the king, who are called respectively *seug-ai-tsieng* or admirable councillor, *tooa-ai-tsieng* or councillor of the left, and *ou-ai-tsieng* or councillor of the right. They are nominally assisted by six *pan-tso* or judges, each of whom has his own *tsam-pan* or substitute and *tsam-ai* or adviser. The *ni-tso*, the first of these judges' departments, has charge of the public offices and employments; the *ho-tso* takes the census, apportiones the taxes, and looks after the mints; the *niei-tso* supervises religious and official ceremonial; the *pieng-tso* is the department of war; the *kieng-tso* administers the criminal courts; and the *kong-tso* has the oversight of public works, commerce, &c. In the palace there are three *sug-tsi*, or functionaries charged to put on record day by day all the royal words and actions. The eight provinces of the kingdom are each administered by a governor, dependent on the ministerial council; and each of the 332 districts into which the provinces are subdivided is under a separate mandarin. Military commanders have the chief authority in the four fortified towns of Kang-hoa, Sou-wen, Koang-tsiou, and Sioung-to or Kai-seng. Theoretically every one of these posts is open to any Corean who has acquired the necessary degree in the public examinations; but actually they are almost all appropriated by the nobles. A postal system is maintained along the principal highways, the horses being kept by the Government, and the grooms and riders holding almost the position of royal serfs. The army nominally includes every individual capable of bearing arms who does not belong to the nobility; but only a small por-

tion of the men are brought under discipline. The military mandarins, though chosen from the nobles, are in far less estimation than the civil functionaries of corresponding rank. The salaries of the governors and other high officials are large; but as the term is only two years, and the custom of the country is for a person in office to support all his relatives, it is seldom that the position proves genuinely lucrative. In addition to the various regular officials already mentioned there are a number of *ea*, or *anaik-sa*, who are despatched by the king, armed with absolute power, to visit the provinces at irregular intervals and secretly observe the condition of affairs. Corruption, however, universally and openly prevails, and the supervision even of these irresponsible emissaries affords little protection against injustice. The mandarin is for ordinary civil cases the absolute judge within his district; but if the matter is very important it may be referred to the provincial governor, or even ultimately to the king himself. Criminal cases are decided by the military mandarin, and the final appeal is to the great court of the capital, which consists of two parts—the *po-tseug* which collects the evidence, and the *ieug-tso* which passes the sentence. Public functionaries and culprits accused of treason or rebellion are tried by a special court called the *keum-pou*, the members of which are named directly by the king. In a case of high treason the whole family of the guilty person is involved in his fate. A large portion of the real administrative power lies in the hands of the subaltern officials of the civil and military mandarins, who are distinguished by M. Dallet as "pretorians" and "satellites." The former compose a formidable hereditary class, which rarely intermarries with the rest of the community; the latter are recruited from the lower ranks of society. Torture is freely employed in judicial proceedings; and the unhappy victim may either have the bones of his legs dislocated or bent, his calves reduced to rags by blows from a heavy plank, the flesh of his thighs cut through by the continuous friction of a rough cord, or his whole body agonized by a prolonged suspension by the arms. Decapitation is the usual form of execution both in civil and military cases.

The language of Corea belongs to the Turanian family, and agrees with the other Turanian tongues in all the main grammatical features. It is written alphabetically, by means of fourteen consonants corresponding to the European *k, l, n, r, t, m* (or *b*), *p* (or *b*), *s, ng* or nasal *n, ts, th, kh, th, ph* (i. e., *p* aspirated, not *f*), and *h*, and eleven vowels, which go to the composition of thirteen diphthongs. The letters appear either in an ordinary or a cursive form. Every line is written from the top to the bottom of the page, syllable by syllable. The vocabulary is greatly mingled with Chinese words, but these undergo the regular Corean declension. The noun has nine cases, including the nominative. Adjectives proper there are none, the nouns and verbs supplying their place. For the names of the numerals above 90, such as 100, 1000, &c., recourse is had to the Chinese. The verb possesses, besides the simple affirmative, a conditional, an interrogative, an honorific, a causative, and several other forms, but it has no distinctive inflections for number or person. The honorific form is employed in speaking of dignitaries, and indeed the verb must slightly vary according to the status of the person addressed.

The study of their native language is greatly neglected by the Coreans, and the educated classes regularly employ Chinese both in literature and social intercourse. The annals of the kingdom, the laws, scientific treatises, public inscriptions, and even shop-signs are all written in the foreign language; at the same time the Corean pronunciation is so peculiar as to be unintelligible in the ears of the inhabitants of the empire. That at one time there was an extensive native literature there seems no doubt; but it is now represented only by a few poetic collections, popular romances, and nursery tales,—to which, indeed, must be added a number of works composed by the missionaries, who have encouraged the preservation and cultivation of the national language. There is an official translation of the sacred books of Confucianism, in which it is criminal to change a single word without the order of the Government; and a sibylline book, prohibited by the authorities, circulates secretly among the people. On the capture of Kang-hoa in 1866, Admiral Roze found a library of 3000 or 4000 books finely covered

with green and crimson silk, and arranged and preserved with great care. One volume particularly attracted M. Kidel's attention; it consisted of a number of marble tablets, united by gilt copper hinges; each tablet was protected by a cushion of scarlet silk, and the letters were in gold incrustated on the marble.

**Education.**—As in China, so in Corea, learning is ostensibly in high estimation, and all public officials must pass certain examinations. The student is left perfectly free to follow any system and receive instruction from any teacher whatever,—the examiners, who are appointed by the Government, taking account of nothing but results. The most important examinations are held once a year in the capital, and candidates flock thither from all the provinces. After the examination is over, those who have passed put on the robes of their new title, and proceed on horseback with sound of music to visit the chief dignitaries of the state, the examiners, &c. Then follows a burlesque initiation which, though not enforced by law, is rendered imperative by custom. The novice has his face stained with ink and besprinkled with flour, and is otherwise subjected to whimsical insults. There are three separate degrees, that of the *teho-si*, that of the *tsin-sa*, and that of the *keup-tchiesi*—the last or highest being obtainable at once without the previous possession of the others. The *tsin-sa* are destined to fill administrative posts in the province, the *keup-tchiesi* the higher positions about the capital and the palace. The military degree, which is also known as the *keup-tchiesi*, involves but little literary culture, and is sought only by the poorer nobles. The whole system is in a state of great decay, and the purchasing of degrees or of doctoral theses is far from uncommon. Besides the possessors of the above-mentioned degrees there is a special class of scholars, known as the middle class, who devote themselves from father to son to the study of various special branches necessary in public employ:—the interpreters, who are trained either in Chinese, Manchu (Honhak), or Mongolian; the *koang-sang-kam*, or school of sciences, devoted to astronomy, geocopy, and auspicious; the *ei-sa*, or school of medicine, including a branch for the royal service and another for the public; the *sa-tsa-koan*, or school of recorders, employed in the preservation of the archives and the drawing up of official reports for Peking; the *to-hoo-si*, intrusted with the preparation of maps, and the execution of the portrait of the king, which after his death is added to the royal gallery; the *nioul-hak*, or school of law, which deals mainly with the penal code; the *kies-sa*, from which clerks are obtained for the financial and public works department; and the *ham-nou-koan*, which is intrusted with the management of the Government hydraulic clock.

**Religion.**—Buddhism, according to native tradition, was introduced into Corea in the 4th century of our era, and under the dynasty of Korio it became the official religion. On the establishment, however, of the Tsi-taien in the 14th century it gave place to the doctrine of Confucius, which continues to the present day as the established creed. In its main features the Confucianism of Corea is identical with the Chinese system; but it is accompanied and intermingled with various popular superstitions. Worship is offered not only to the Sia-tsik, or patron of the kingdom, but also to the Siang-tiei, whom some regard as a supreme divinity, and others identify with the sky. To the latter public sacrifices, consisting of pigs, sheep, and goats, are offered for the purpose of preventing or obtaining rain, removing epidemic diseases, or otherwise interfering with the course of natural events. The Sia-tsik is hardly known in the provinces; but in the capital his temple is the most sacred of all. Among the educated classes the only form of religion in real force is the worship of their ancestors, and consequently the greatest importance is attached to all the ceremonial details of funerals, mourning, and tombs. In every district there is a temple of Confucius called *kiang-hio*, with an extensive domain attached; and if the revenue is not sufficient to maintain the necessary expenses, the treasury of the district must supply the deficit. There still exist several of the large pagodas erected during the period of the official status of Buddhism; they are built in the Chinese style, and are frequently remarkable for the beauty of their situation. Except in the province of Kieng-sang the Buddhist monks, or bonzes, retain no influence; they have but little learning, and their numbers are diminishing. The belief in evil spirits is common among the Coreans; their action is frequently controlled by the propitious

or unpropitious character of times and seasons, and almost every event is the sign of fortune or mishap. The serpent is the object of superstitious respect; and, instead of killing it, the Corean feeds it as regularly as his domestic animals. Of first importance for the happiness of a family is the preservation of the ancestral fire, and every housewife has all the anxiety and responsibility of a Vestal Virgin. The number of astrologers and fortune-tellers throughout the country is extraordinary. The blind are reputed to be endowed with special prophetic aptitude, and, as a natural consequence, a large proportion of those who are deprived of sight make gain of their affliction. In the capital these seers are formed into a regular corporation legally recognized, and their services are in great request for the recovery of secrets, the foretelling of the future, and the exorcising of devils. In this latter operation they trust principally to noise as a means of frightening the spirits, whom they ultimately catch in a bottle and carry off in triumph.

**Manners and Customs.**—Women hold a very low position in Corean estimation, and count for little in the sight of the law. Not only are they destitute of all political and social influence, but they are not held personally responsible for their actions, and live in a state of lifelong pupilage. At the same time they enjoy a considerable amount of freedom, and it is only among the upper classes that they are kept in seclusion. Marriage is altogether an affair of etiquette; the terms are settled by the heads of the families, and the bride and bridegroom have no opportunity of seeing each other till they meet on the marriage platform, and bow to each other as man and wife. After marriage there is little social intercourse between the pair, both men and women keeping company with their own sex. Among the lower classes second marriages are equally permissible to both sexes; but among the nobles the second marriage of a widow is considered so reprehensible that the offspring of such a union is branded as illegitimate. Polygamy is not permitted, but concubinage is a recognized institution. Strong affection for their children is one of the better characteristics of the Coreans, and infanticide and exposure are almost unknown. Adoption is a common expedient to prevent the extinction of a family, and the choice of the child is regulated by a rigid etiquette. Filial piety is in the highest estimation, and the conduct of a son towards his father is guided by innumerable rules. If he meets him on the way, he must do him humblest obeisance; if he writes to him, he must employ the most respectful forms in the language; if the father is sick, the son must attend him; if the father is in prison, the son must be at hand without; if the father is exiled, the son must accompany him on his journey. On the death of his father the eldest son becomes the head of the family, responsible for all the duties of a father towards his brothers and sisters, who receive no share in the patrimony, but merely dowries and donations on marriage, &c. Between the various members of a family, even after they have separated from the domestic hearth, there remains the greatest intimacy and affection, and the slightest connection of blood is recognized as a bond of attachment.

**Industry and Trade.**—The industrial arts are but slightly developed, the peasant himself in most cases supplying by his own labor the greater part of his needs. The one manufacture in which the Corean ranks really high is that of paper, a material employed as in Japan in a great variety of ways. Trade is mainly carried on by means of markets or fairs, but transactions are hampered by the deficiency of the currency. Only one kind of coin, a small piece of copper known as a "sapeke," is recognized, and even this is not in use in the northern provinces, where barter alone is in vogue. The roads of the country offer but few facilities for traffic; wheeled vehicles are unknown, and much of the transport of goods is effected by portage. Except at the capital there is hardly, over any of the numerous streams, a structure worthy to be called a bridge. Foreign commerce there is none, unless the fair which is held annually for several days at Pien-men on the occasion of the passage of the ambassadors, or that which takes place every two years at Hung-chung, is to be counted an exception. The Chinese or Japanese ships are allowed to fish for trepang along the coast of Pieng-an and for herring on that of Hoang-hai; but they are prohibited, not only from landing, but from holding any communication with the Coreans at sea.

**Dwellings and Dress.**—The houses of the Coreans are

of one story, flimsily constructed of wood, clay, and rice-straw, usually covered with thatch and badly provided with windows. Lamentable accounts are given of the general poverty of the common people. Their houses are only about ten or twelve feet square; the floor is the bare earth, covered in rare instances with mats of poor quality; no chairs are in use, people squatting on the floor; and there is nothing worthy of the name of a bed. The ordinary shoe or sandal is formed of straw, and leaves the great toe exposed; but stockings are worn by all. Wide pantaloons and a long vest are the principal articles of attire,—the well-to-do wearing also a large overcoat, which the peasant uses on gala occasions only. The national hat is composed of a framework of bamboos covered with an open kind of haircloth; it protects neither from rain, cold, nor sun, and is altogether very inconvenient. The principal material of the wearing apparel is cotton cloth, rough in texture, and of its natural color; but a rude kind of silk fabric is not uncommon among the wealthier classes.

*History.*—Corea, or Chosen, as it is called by the natives, appears for the first time in Chinese history in 1122 B. C., as affording an asylum to the refugee viscount of Ke; and since that period it has been claimed as an integral part of the Chinese empire. Neither at that time, nor for centuries afterwards, does it seem to have formed a political unity,—various states, as Hwuy, Shin-han, Pih-tse, and Sin-lo being mentioned in the Chinese records. In the first century of our era three of these states stand out as important:—Kao-li in the north and north-east, Pih-tse in the west, and Sin-lo in the south. Out of the civil wars which fill the next ten hundred years Sin-lo emerges predominant; but in the 11th century the king of Kao-li, known as Wang-kian, or Wang the founder, united the whole peninsula under his sway, and established the dynasty which has given its name to the country. The fall of the Mongolian dynasty in China brought about a similar revolution in Corea; and in 1392 Tai-tso or Li-tan became the founder of the present dynasty of Tai-tsen, and the author of the system of administration still in force. The Chinese at that time imposed on the Coreans the use of their chronology and calendar.

Under Siang-siong, who held the throne from 1506 to 1544, the Coreans carried on a war with Japan, but in 1597 the great Japanese monarch Taiko-sama retaliated by a remarkable invasion. According to the journal of O-o-gawutsi, a Japanese general who took part in the expedition, the force consisted of 163,000 horsemen; three-fourths of the country was occupied and several of the oldest cities destroyed, in spite of the fact that two Chinese kings appeared to assist the Coreans with a force of 100,000 horsemen. The death of Taiko-sama in 1598 led the Japanese to abandon their conquest; and in 1615 peace was definitely signed, but only on conditions of great hardship for the Coreans. A tribute was exacted and the fort of Fusan-kai was retained; and the Korean king till 1790 had to send an embassy to Japan to announce his accession. When the Manchu dynasty ascended the throne of China, the Coreans defended the Mings; but being defeated by the new power, they had in 1637 formally to recognise the Manchu sovereignty, and to pay henceforward a heavy annual tribute. Since 1636 there has been no war with China or with Japan; and the Coreans have maintained in regard to every other nation the most absolute isolation. The ambassadors sent annually to Peking have been the means of conveying some little knowledge of Western nations to their countrymen; but the result has rather been to make them more exclusive. It is recorded in a Korean work that Tsiang-tou-wen-i saw a European named Jean Niouk in the Chinese capital, and obtained from him books, pistols, telescopes, and other curiosities; and Ricci's *Tien-tou-sir-si*, or *True principles about God*, are mentioned by Ni-siou-sipong, a Korean author. In 1784 Ni-tak-tso having had his attention aroused by some Chinese work on the Christian religion thus introduced, requested his friend Seng-houng-i, soon after sent with the embassy, to make inquiry about the subject. The result was the formation of a Christian sect, which speedily attracted the attention of the Roman Catholic mission, whose agents succeeded, in spite of the jealous watch of the Korean authorities, in making their way into the country. Persecution soon broke out, and has continued at intervals ever since. In 1831 a vicar apostolic was appointed by the Pope, and repeated efforts were made to effect a firm footing; but in 1866 the last Europeans were expelled. To avenge the murder of the French missionaries, Admiral Rose undertook an expedition in the end of that year. He destroyed the city of Kang-hoa, with its important military establishments, but obtained no concessions from the Government. Several American vessels having been burned by the Coreans, the United States in 1867 despatched Commander Schufeldt to remonstrate with the native authorities, but he returned as he went. Nothing further was done till 1870, when a force under Admiral Rodgers proceeded up the river towards the capital, with the intention of communicating directly with the Government. It was met

by a determined resistance on the part of the Coreans, and though the American vessels were secure against the native artillery, and American guns soon silenced the forts, the admiral was constrained by political difficulties to bring his expedition to a close. In 1875 a convention was arranged by the Coreans with Moriyama, the Japanese ambassador; but its terms were soon infringed and an attack was made on the gunboat "Unyokan." The Japanese Government accordingly despatched Karoda as high commissioner, who succeeded in concluding a treaty with important concessions to Japan. The Japanese are now entitled to send a permanent resident to the capital; three ports are opened to Japanese trade; Korean ports may be entered by Japanese vessels in distress; and Japanese mariners are free to survey the Korean coast.

*Literature.*—The European literature about Corea is comparatively scanty; of all the works that have yet been published, that which gives the completest account is M. Dallet's *L'Église de la Corée* (1874), based mainly on the reports of the members of the Roman Catholic mission. The earliest source of information is the narrative of H. Hamel, a Dutchman, who was shipwrecked on the coast of the Island of Quelpart in 1654, and spent thirteen years in captivity; it is contained in the collections of Astley, Pinkerton, &c. Brief notices will be found in B. Hall's *Account of a Voyage to the West Coast of Corea*, 1818; Macleod, *Voyage of H. M. S. Alceste*, 1819; A. Young, *Remarks on Corea*, 1865; A. Williamson, *Journeys to North China*, 1870; and *Fortnightly Review*, 1875. Professor Pfismaier of Vienna, the Japanese scholar, has published a German translation of the Japanese account of the campaign of 1597, in the *Denkschriften d. k. Akad. d. Wissenschaften*, 1876, and promises *Darlegungen aus der Geschichte und Geographie Coreas*. A French translation of the journal of Kwei-lin, Chinese ambassador to Corea in 1866, appears in the *Revue de Géog.*, 1877. For the language see *A Translation of a Comparative Vocabulary of Chinese, Korean, and Japanese*, by W. H. Medhurst, Batavia, 1835. A grammar and vocabulary by W. F. Meyers, secretary of the English Legation at Peking, and a dictionary compiled by the French missionaries are to be published.

(H. A. W.)

CORELLI, ARCANGELO (1653–1713), a celebrated violin player and composer for that instrument, was born at Fusignano near Imola. Of his life little is known. His master on the violin was Bassani. Matteo Simonelli, the well-known singer of the Pope's chapel, taught him composition. His talent as a player on the violin seems to have been acknowledged at an early period, but his first decided success he gained in Paris at the age of nineteen. To this success he owed his European reputation. From Paris Corelli went to Germany and settled at Munich, where he remained for nearly nine years, much admired at court and in the city. In 1681 he returned to Rome, and contracted a close friendship with Cardinal Ottoboni, who made him the conductor of his private chapel. With the exception of a visit to Naples by invitation of the king, Corelli remained in Rome till his death in 1713. His life was quiet and wholly devoted to his art. The style of execution introduced by him and preserved by his pupils, such as Geminiani, Locatelli, and many others, has been of vital importance for the development of violin-playing. In the same sense it may be said that his compositions for the instrument mark an epoch in the history of chamber music; for his influence was not confined to his own country. Even the great Sebastian Bach submitted to it. Musical society in Rome owed much to Corelli. He was received in the highest circles of the aristocracy, and arranged and for a long time presided at the celebrated Monday concerts in the palace of Cardinal Ottoboni. Corelli died possessed of a considerable sum of money and a valuable collection of pictures, the only luxury he had indulged in. Both he left to his benefactor and friend, who, however, generously made over the first part of the legacy to Corelli's relatives. The composer's bust, placed on his grave at the expense of the Count Palatine Philip William, and under the supervision of Cardinal Ottoboni, is at present in the Museo Capitolino. Corelli's compositions are distinguished by a beautiful flow of melody and by a masterly treatment of the accompanying parts, which he is justly said to have liberated from the strict rules of counterpoint. Six collections of concerti, sonatas, and minor pieces for violin, with accompaniment of other instruments, besides several concerted pieces for strings, are authentically ascribed to this composer. The most important of these is the *XII. Sوناتa a Violino e Violone o Cimbalo* (Rome, 1700).

CORENZIO, BELIBARDO (c. 1558–1643), a Greek, studied at Venice under Tintoretto, and then settled at Naples, where he became famous for unscrupulous conduct as a

man and rapid execution as an artist. Though careless in composition and a mannerist in style, he possessed an acknowledged fertility of invention and readiness of hand; and these qualities, allied to a certain breadth of conception, seem in the eyes of his contemporaries to have atoned for many defects. When Guido Reni came in 1621 to Naples to paint in the chapel of St. Januarius, Corenzio suborned an assassin to take his life. The hired bravo killed Guido's assistant, and effectually frightened Reni, who prudently withdrew to Rome. Corenzio, however, only suffered temporary imprisonment, and lived long enough to supplant Ribera in the good graces of Don Pedro di Toledo, viceroy of Naples, who made him his court painter. Corenzio vainly endeavored to fill Guido's place in the chapel of St. Januarius. His work was adjudged to have been under the mark and inferior to that of Fabrizio Santafede and Carracciolo. Yet the numerous frescoes which he left in Neapolitan churches and palaces, and the large wall paintings which still cover the cupola of the church of Monte-Casino are evidence of uncommon facility, and show that Corenzio was not greatly inferior to the *fa prestos* of his time. His florid style, indeed, seems well in keeping with the overlaid architecture and full-blown decorative ornament peculiar to the Jesuit builders of the 17th century. Corenzio died, it is said, at the age of eighty-five by a fall from a scaffolding.

CORFU, the ancient *Corcyra*, an island of Greece, in the Ionian Sea, off the coast of Albania or Epirus, from which it is separated by a strait varying in breadth from less than two to about fifteen miles. In shape it is not unlike the sickle or *drepans*, to which it was compared by the ancients, —the hollow side, with the town and harbor of Corfu in the centre, being turned towards the Albanian coast. Its extreme length is about forty miles and its greatest breadth about twenty. The area is estimated at 227 square miles, and the population is about 72,500. Two high and well-defined ranges divide the island into three districts, of which the northern is mountainous, the central undulating, and the southern low-lying. The most important of the two ranges is that of San Salvador, probably the ancient *Istona*, which stretches east and west from Cape St. Angelo to Cape St. Stefano, and attains its greatest elevation of 3300 feet in the summit from which it takes its name. The second culminates in the mountain of Santi Deca, or Santa Decca, as it is called by misinterpretation of the Greek designation of *Άγιος Δέκα*, or the Ten Saints. The whole island, composed as it is of various limestone formations, presents great diversity of surface, and the prospects from the more elevated spots are magnificent.

*Vegetation and Agriculture.*—Travellers generally agree that, with the exception, perhaps, of Crete, Corfu is the most beautiful of all the Greek isles, but resident foreigners complain of the monotonous color of the olive, whose greyish-green is little relieved by the cypress and pine, or the mulberry and *jajubier*. This lack of variety, which is the more to be regretted as the island is adapted for the oak, the plane, the Spanish chestnut, and the walnut, is mainly due to the fact that the government of Venice at one time gave premiums for planting olive-trees, partly to encourage the produce of oil, and partly to discourage the raising of wheat. Once planted, the olive has suited the people. Single trees of first quality yield sometimes as much as 2 gallons of oil, and this with little trouble or expense beyond the collecting and pressing of the fallen fruit. As the trees are allowed to grow unrestrained, they are generally much larger and more wide-spreading than those in Provence or Tuscany, and some are not less than three centuries old. It is worthy of remark that Homer names, as adorning the garden of Alcinoüs, seven plants only—the wild olive, the oil olive, the pear, pomegranate, apple, fig, and vine. Of these the apple and pear are now very inferior in Corfu; the others thrive well, and are accompanied by all the fruit-trees known in Southern Europe, with addition of the Japanese medlar (or loquat) and, in some spots, of the banana. When undisturbed by cultivation, the myrtle, arbutus, bay, and ilex form a rich brushwood, and the minor *flora* of the island is extensive.

Corfiot proprietors in general display little taste for the country, and their absenteeism is probably increased by the "*colonia perpetua*," by which the landlord grants a lease to the tenant and his heirs for ever, in return for a rent, payable in kind, and fixed at a certain proportion of the produce. Of old, a tenant thus obtaining half the

produce to himself was held to be co-owner of the soil to the extent of one-fourth; and if he had three-fourths of the crop, his ownership came to one-half. Such a tenant could not be expelled but for non-payment, bad culture, or the transfer of his lease without the landlord's consent. Attempts have been made to prohibit so embarrassing a system; but as it is preferred by the agriculturists, the existing laws permit it. The portion of the olive crop due to the landlord, whether by *colonia* or ordinary lease, is paid, not according to the actual harvest, but in keeping with the estimates of valuers mutually appointed, who, just before the fruit is ripe, calculate how much each tree will probably yield. The large old fiefs (*baronie*) in Corfu, as in the other islands, have left their traces in the form of quit-rents (known in Scotland by the name of feu-duties), generally equal to one-tenth of the produce. But they have been much subdivided, and the vassals may by law redeem them.

The Corfiot peasantry are reputed the idlest of all the Ionians. The olive receives little or no culture from them, and the vineries alone are labored by the broad heart-shaped hoe. The vintage, which begins on the festival of Santa Croce, or the 26th of September (O. S.), is neither a pretty nor a lively scene, and little care is taken in the various operations. None of the Corfu wines are prized.

Cottagers cultivate no gardens for themselves; they purchase their vegetables in the Corfu market, and a considerable sum goes annually to buy in Apulia the garlic and onions so largely used by the people.

The capital (noticed below) is the only city or town of much extent in the island; but there are a number of villages, such as Benizze, Gasturi, Ipsco, Glypho, with populations varying from 300 to 1000.

Corfu contains very few and unimportant remains of antiquity. The site of the ancient city of Kerkyra is well ascertained, about 1½ miles to the south-east of Corfu, upon the narrow piece of ground between the sea-lake of Caliohiopulo and the Bay of Castrades, in each of which it had a port. Under the hill of Ascension are the remains of a temple, popularly called of Neptune, a very simple Doric structure, which still in its mutilated state presents some peculiarities of architecture. Of Cassiopo, the only other city of ancient importance, the name is still preserved by the village of Cassopo, and there are some rude remains of buildings on the site; but the temple of Zeus Cassius for which it was celebrated has totally disappeared. Throughout the island there are numerous monasteries and other buildings of Venetian erection, of which the best known are Paleocastrizza, San Salvador, and Pelleka.

The ancient Corcyreans delighted to identify their island with the Homeric *Scheria*—the kingdom of Alcinoüs and his Phæacian subjects; but the first authentic event in the history of Corcyra is its colonisation in 734 B. C. by the Corinthians, and the expulsion of the previous Cretan and Liburnian settlers. So prosperous was the new community that in a short time it rivalled the mother country, and in 695 B. C., in a sea-fight which is remarkable as the first on record, destroyed the fleet which had been sent to compel its allegiance. Not long afterwards, however, it was forced to recognize Corinthian supremacy by the tyrant Periander, the son of Cypselus. At a subsequent period its dissensions with the parent state brought on the Peloponnesian war, during which it repelled several attempts of the Lacedæmonians. After various vicissitudes it fell into the hands of Pyrrhus, king of Epirus, and on his death it was seized by the Illyrian pirates. Under the Romans, who obtained possession in 229 B. C., it became an important naval station, and so continued till the fall of the Eastern Empire. In 1081 Robert Guiscard, the Norman, captured Corfu, and in 1086 he died at Cassopo. It was again conquered by his nephew Roger of Sicily in 1146; but it was recovered by Manuel Comnenus in 1152. In 1192 Richard I. of England landed at Corfu on his voyage from Palestine; and the forces of the fifth crusade were welcomed to the island after the capture of Zara. The Genoese corsair, Leon Vetrano, who had made himself master of what was then regarded as a Venetian possession, was defeated and executed, and the Venetian senate in 1206 sent a colony of ten noble families to secure its occupancy. Through the rest of the 13th and most of the 14th century, Corfu and the other Ionian Islands were a prey by turns to corsairs, and to Greek and Neapolitan claimants; and it was not till 1386 that the Corfiots voluntarily placed themselves under Venice, which in 1401, on the payment of 30,000 ducats, had its right to the island recognised by Ladislaus, king of Naples. Barbarossa ravaged Corfu in 1537, and Selim II. did much the same in 1570. In 1571 the great fleet which was about to become illustrious through the battle of Lepanto, was reviewed at Corfu by the generalissimo, Don John of Austria. The last and great-

est struggle for the possession of the city and island was in 1716, when the forces of Aohmet III. were defeated by the Venetians under Count Schulenburg, already famous for his crossing of the Oder and his share in the battle of Malplaquet. The peace of Campo Formio gave the Ionian Islands to the French, but in 1799 they were forced to capitulate to a Russo-Turkish fleet. By the treaty of Paris, 1815, the republic of the Ionian Islands was revived, and placed under the protectorate of Great Britain, Corfu being the chief island of the group. In 1864 that protectorate was resigned in favor of the kingdom of Greece, and Corfu now forms one of the nomarchies of that country, along with the neighboring islands of Meriera, Fano, Salmastraki, Paxo, Antipaxo, and Leukadia.

*Literature*.—Baron Theotoky, *Détails sur Corfou*; Mustoxidi, *Notizie per servire alla storia Corcirese*, 1804; J. P. Bellare, *Précis des opérations générales de la division française du Levant*, 1805; Jarvis, *History of Corfu*, 1852; Alb Mousson, *Ein Besuch auf Korfu im Sept.*, 1858, Zurich, 1859; Ansted's *The Ionian Islands*, 1863; Tuokermann's *Greeks of To-day*, 1874.

CORFU, the capital of the above island, stands on the broad part of a peninsula, whose termination in the citadel is cut from it by an artificial fosse formed in a natural gully, with a salt-water ditch at the bottom. Seen from the water, or from a height, it is picturesque in masses, but in detail it is not to be praised for either beauty or comfort. Having grown up within fortifications, where every foot of ground was precious, there is nothing spacious about it except the handsome esplanade between the town and the citadel. Indeed, it is still, in spite of recent improvements, a perfect labyrinth of narrow, tortuous, up-and-down streets, accommodating themselves to the irregularities of the ground, few of them fit for wheel carriages. The palace, built by Sir Thomas Maitland, is a large structure of white Maltese stone, but the exterior has no architectural merits, although internally its apartments are very stately. In several parts of the town may be found houses of the Venetian time, with some traces of past splendor, but they are few, and are giving place to structures in the modern and more convenient French style. Of the thirty-seven Greek churches the most important are the cathedral, dedicated to Our Lady of the Cave (*η Παναγία Σπηλιώτισσα*); St. Spiridion's, with the tomb of the patron saint of the island; and the suburban church of St. Jason and St. Sospater, reputed the oldest in the island. The city is the seat of a Greek and a Roman Catholic bishop; and it possesses a gymnasium, a theatre, an agricultural and industrial society, and a library and museum preserved in the buildings formerly devoted to the university, which was founded by Lord Guildford in 1823, but disestablished on the cessation of the English protectorate. There are three suburbs of some importance—Castrades, Manduchio, and San Rocco. The old fortifications of the town, being so extensive as to require a force of from 10,000 to 20,000 troops to man them, were in great part thrown down by the English, and a simpler plan adopted, limiting the defences to the island of Vido and the old citadel. Population about 25,000.

CORIANDER, the fruit, improperly called seed, of an Umbelliferous plant (*Coriandrum sativum*), a native of the south of Europe and Asia Minor, but naturalized and cultivated in the south of England. The plant produces a stem rising about a foot in height, with bipinnate leaves and flowers in pink or whitish umbels. The fruit is globular and externally smooth, having five indistinct ridges, and the mericarps, or half-fruits, do not readily separate from each other. It is used in medicine as an aromatic and carminative, and on account of its pleasant and pungent flavor it is a favorite ingredient in hot curries and sauces. The fruit is also used in confectionery, and as a flavoring ingredient in various *liqueurs*. The essential oil on which its aroma depends is obtained from it by distillation. The tender leaves and shoots of the young plant are used in soups and salads.

CORIGLIANO, a town of Italy, in the province of Calabria Citeriore and the district of Rossano, situated on a river of the same name, about four miles from the coast, on a steep hill, which is surmounted by an ancient castle and fringed at the foot by orange and lemon plantations. It is supplied with water by an extensive aqueduct, and carries on the manufacture of liquorice and a trade in timber. Population about 10,000.

CORINGA, a seaport town of British India, in the collectorate of Godavery and presidency of Madras, is situated in 82° 19' E. long. and 16° 49' N. lat., on the estuary of a branch of the Godavery River. The harbor

is protected from the swell of the sea by the southward projection of Point Godavery, and affords a shelter to vessels during the south-west monsoon. Across its entrance is a bar, which shows a depth of about 15 feet at spring tides. The repairing and building of small coasting ships is a staple industry of Coringa. The chief exports are teak, salt, and piece-goods; the imports are silk, paper, and copper. In 1787 a gale from the north-east occasioned an inundation which swept away the greater part of the town with its inhabitants; and in 1832 another storm desolated the place, carrying vessels into the fields and leaving them aground. Of Europeans the French, who still hold the neighboring settlement of Yanaco, were the first to establish themselves at Coringa. In 1759 the English took possession of the town, and erected a factory five miles to the south of it.

CORINNA, a Greek poetess, born at Tanagra in Bœotia, of interest for the influence which she exerted on Pindar. The fragmentary traditions which have been preserved represent her now as the poet's friend and instructress, and again as his rival and competitor. By her he is said to have been advised to adorn his poems with the Greek myths, and then when he employed them too lavishly, to have been warned that they ought to "be sown by the hand and not poured forth from the sack." She also blamed him for having used an Attic idiom in one of his lyrics. The victory which she gained in the poetic contest with her friend in the public games at Thebes is ascribed by Pausanias to her beauty and the free use she made of the local Bœotian dialect; and the story goes that Pindar gave expression to the same opinion by calling her in the heat of his chagrin a "Bœotian swine," with allusion to a common Greek proverb. By the Greeks she was esteemed as the first of the nine lyrical muses. The fragments of her poetry have been collected by Ursinus, Wolf, Schneider, and Bergk.

See Leopold Schmidt, *Pindar's Leben und Dichtungen*, 1862.

CORINTH (now corrupted into Gortho) was originally called Ephyre, but the name *Κόρινθος* is as old as Homer. This most populous and thriving of Greek cities was situated at the southern end of the isthmus which connects Peloponnesus with the mainland of Hellas. The citadel, Acrocorinthus, occupied the summit of a precipitous rock, 1886 feet in height, which is in fact an offshoot from the Oneion, a mountain range skirting the northern shore of Achaia, but which appears, especially when viewed from the north, to be detached. From this height the view includes the Geranean range at the opposite end of the isthmus, and the higher mountains of Northern Greece behind it, while in the foreground lies to the left the Corinthian Gulf stretching westward, and the Saronic Gulf to the east, together with the strip of flat land which divides the one of these from the other. Another narrow plain stretches along the southern shore of the Corinthian Gulf in the direction of Sicyon, and was proverbial in ancient times for the value of its agricultural produce. The city of Corinth lay not at the foot of the hill on which the citadel stood, but on a ledge or shelf of that hill at a height of about 200 English feet. A lofty wall—according to Strabo, 85 stadia (about ten miles) in length—inclosed both city and citadel, and two walls, each 12 stadia in length, inclosed the road to the harbor of Lechæum on the Corinthian Gulf; Schœnus and Cenchræ, the two harbors belonging to the city on the Saronic Gulf, lay at a greater distance.

From its position Corinth enjoyed in prehistoric times two advantages especially important in the infancy of navigation. On the long gulf which stretched from Corinth westwards, called in early times after Crissa, the port of Delphi, and later after Corinth itself, vessels could sail for about 100 miles without losing sight of land and between fertile shores. And secondly, the natives of Corinth were skilful in dragging vessels of all kinds across from sea to sea, thus saving them the dangers of the perilous voyage round the Peloponnesus. That the Phœnicians did not overlook these advantages we know from the many traces of Phœnician occupation remaining in later times, especially the worship of the Phœnician Athene, Aphrodite, Urania (the Sidonian Astarte), and Melicertes (the Tyrian Melkarth).

The important *cultus*, at the isthmus, of Poseidon, the great divinity of the Ionians, proves the earliest Greek



inhabitants of Corinth to have been Ionian, but Thucydides states that it was under Æolian princes. The earliest of these of whom we hear is Sisyphus, according to one legend lover of Medea, according to another grandfather of Bellerophon, the great local hero who tamed the winged horse Pegasus, and slew the monstrous Chimæra. The character of mingled greed and cunning, ascribed to Sisyphus, is doubtless intended to embody the qualities which distinguished the people of the commercial city from their rural neighbors. This was in the age preceding the Trojan War. On the return of the Heraclidæ the Dorian invaders, after subduing the rest of Peloponnesus, attacked Corinth, and having mastered it proceeded against Megara and Athens. Corinth fell into the hands of a descendant of Hercules, named Aletes (the wanderer), and was reconstituted on Dorian principles, but not, it would appear, with the same rigidity as Argos, Sicyon, and other cities, for we find eight tribes instead of the usual three, and it is certain that the aristocracy of the city did not disdain to lead in trade, and resembled rather the nobility of Venice than the pure-blooded warrior-caste of other Dorian cities. The most wealthy family was that of the Bacchiadæ, the descendants of Aletes, who furnished first a succession of kings, and afterwards yearly prytaneis who ruled with kingly power. It was about 657 B. C. that Cypselus, a Bacchiad on his mother's side, succeeded in overthrowing this oligarchy and, by the aid of the commons, establishing his power at Corinth so firmly that he could even forego the foreign body-guard and the external supports of the Greek tyrant. His son and successor, Periander, was sometimes reckoned among the wise men of Greece, and probably did more than any other man to shape the colonial and mercantile policy of the city. Under him Corinth reached the summit of prosperity, but Periander's family was destroyed by internal dissensions, and his nephew Psammethichus was after a brief reign put down by the Spartans about 584 B. C.

It was in the period between Aletes and Psammethichus that lay the golden days of Corinth. Then were made a series of splendid discoveries and inventions, which increased the trade and multiplied the resources of the city, and enabled it to found the numerous colonies which were the basis at once of its wealth, its power, and its policy. To begin with the loftier arts. Arion graced the court of Periander, and secured for Corinth the honor of the invention of the dithyramb; Eumelus and Enmolpus, both Corinthians, were among the earliest and the most celebrated of the cyclic poets. Corinthian architecture was renowned until the later time when a light and ornate style of building took its origin and its name from the city. Corinthian pottery was early celebrated, and it is said that the art of ornamenting earthenware was improved at Corinth by Butades, Eucheir, and Euphrastus. Even painting was either introduced into Greece, or was much improved by the Corinthians Aridices, Euphrastus, and Cleantes. Still it was in the useful rather than the ornamental and imaginative arts that Corinth most excelled. There the trireme was invented, and the machinery for the transport of ships carried to the highest perfection, while Corinthian bronzes, tables, coffers, and objects of luxury were renowned on all shores of the Ægean and Adriatic. One of the most remarkable of these pieces of handiwork was the well-known chest of Cypselus, still preserved at Olympia in the time of Pausanias, made of cedar and inlaid with a multitude of figures in gold and ivory, a miracle of archaic art.

The wealth and prosperity of the city caused its rulers to plan early a scheme of colonization. Professor Ernst Curtius has given reasons for supposing that at the time of the Lelantian war, of which Thucydides speaks, between Chalcis and Eretria in Eubœa, Corinth was, together with Samos, a firm ally of the former city, and that it was in company with the Chalcidians that the Corinthians made their first attempts at colonization. That these attempts were, through a series of years, made almost constantly in a western rather than an eastern direction was due to the position of Ægina, which island lay right in the track of travellers from Corinth to Asia Minor or the Euxine,—the Æginetans having maintained a constant hostility to the Corinthians from the earliest time, until their island was finally conquered by the Athenians, who had received for the war a detachment of ships sent from Corinth. It was in the 8th century that the two greatest colonies, Corcyra and Syracuse, were founded. Syracuse remained, even in

the time of her greatest prosperity, a grateful and dutiful daughter, but Corcyra very soon after its foundation was engaged in hostilities with the mother-city, and, though reduced to obedience in the time of Periander, finally ousted Corinthian commerce from the northern part of the Adriatic, and maintained undivided supremacy over the cities of Dyrrhachium and Apollonia. But south of the straits of Sybota, which divided the southern point of Corcyra from the mainland, Corinth was supreme. To her the towns of Achaia, Phocis, and Locri, on both sides of the Corinthian Gulf, looked as their head; she ruled all the rich country watered by the Achelous, which region, indeed, became in time almost more Corinthian than the isthmus itself, while all the Dorian cities of Sicily and Southern Italy looked to the navy of Corinth to keep up their connection with the mother country.

It is said that Corinth adhered in a special manner to the customs of Phœnicia as regards colonies, at any rate the city was in this respect successful beyond the rest of Greece. Expeditions were directed to some promising point on the Illyrian or Acarnanian coast, the approval of the Delphic oracle was secured, and volunteers were invited from all parts of Greece. At the head of the colony was placed some cadet of the Bacchiadæ, or another great family, and some of the mercantile nobility accompanied it, retaining in the new home much of the oligarchical predominance which they had enjoyed at home. It was probably the preservation of this aristocratic tinge which made the union closer between colony and mother city, so that the Corinthian envoys could boast (Thucydides, i. 38) that Corinth was of all cities the most popular with her colonies; and, with the exception of Corcyra, few of the new settlements gave the mother city any trouble. Alone among cities Corinth imposed on all her colonies a uniform coinage, the different issues of which are so similar in appearance that it has been doubted if Corinth did not keep in her own hands all minting of silver.

After Psammethichus had been put down, a timocracy was instituted, with hierarchy of grades. Corinth set an early example in that system of political classification according to revenue which was afterwards adopted in Rome and other cities. At the same time, it is clear that in so commercial a city an organization of this kind would not produce an exclusive land-owning aristocracy.

It was about the middle of the 5th century B. C. that Corinth started upon a more restless and aggressive career. At that time her very existence was threatened by the growing greatness of Athens, which city had gained the mastery of Megara and predominant power among the cities of Achaia. Soon after the beginning of the Peloponnesian war, an Athenian fleet under Tolmides appeared in the Corinthian Gulf, and seizing upon Naupactus, and expelling thence the Locrian colonists whom Corinth had stationed there to defend her interests, established in that city a colony of Messanian fugitives, in order to cut the communications of Corinth close to their base. Hence the bitter and vindictive animosity felt by the Corinthians towards Athens, which caused them, after that city had surrendered to Lysander, to urge upon the Spartans its total destruction. No sooner, however, was the Spartan supremacy undisputed, than a party among the Corinthians, whether seduced by Persian gold, or following notions of supposed expediency, began to cabal with Athens and Argos against the Lacedæmonians, with whom the aristocracy of the city still sided. Hence bitter dissensions and many calamities to the Corinthians, whose city was more than once the battle-field of parties, as well as of the Argive and Lacedæmonian troops. The events of the war hence arising, and called Corinthian, belong to the history of Greece. The city, weakened by sedition, fell easily into the hands of Philip II. of Macedon, whose successor, the fifth Philip, called it, in virtue of its splendid position, one of the three fetters of Greece. As the chief city of the Achæan League during the latter part of its existence, Corinth claimed a share in the 2d century in the latest glories of Greece. There Flaminius proclaimed the liberties of Greece; and as the ally of Rome, Corinth reached a high point of wealth and splendor. But that alliance was broken off, and the result was the total destruction of the city by Mummius in 146 B. C., and the sale of its inhabitants into slavery. The richness of the city at this period in all the accumulated results of Greek science and art was immense, as we know from the statements of Polybius, an eye-witness

The Romans secured a vast spoil of statues, pictures, and furniture, of which a part was purchased by Attalus of Pergamum, a part sent in many ships to Rome, and much also destroyed in mere wantonness. Notwithstanding, the place remained a quarry whence in after ages were dug innumerable treasures of art. The Corinthian territory was given to Sicyon, and the site lay waste until the time of Julius Cæsar. The great dictator settled there a colony of needy Greeks and Roman freedmen, which he called after himself *Laus Julia*, and made the seat of government of *Achaia*. Between the new Corinth and the old the site was the only bond of connection, yet the historic splendors of the place seem to have mastered the minds of the new inhabitants, who before long began to resume all the local customs, and to claim the past glory of the city as their own. Latin, however, as we know from coins, remained the official language, and the *dumviri* were usually the freedmen of the emperors or of Roman nobles.

The new city, from its position, soon acquired a great trade with Ephesus, Thessalonica, and other cities. For this reason it attracted St. Paul, who visited it more than once, and spent many months there in converse with Aquila and Priscilla, and in preaching in the synagogue. Hence were written the two Epistles to the Thessalonians, and here was founded a church which claimed for a long period the deepest anxieties of the apostle and after his death of Clement,—the temptations to sensual indulgence and antinomian heresies being here stronger than in most of the Greek cities.

Unfortunately, it is only of this second Corinth that we possess detailed descriptions. It was visited both by Strabo and Pausanias. From the former we learn that the summit of the *Acrocorinthus* bore a little temple of Aphrodite, and that just below the summit gushed out the fountain *Peirene*, which once more rose to the surface down in the lower city. Just below this fountain were the remains of a marble building, supposed to have been the remains of the palace of the monarch *Sisyphus*. From the account of Pausanias (ii. ch. 1-4) we may gain a clear notion of the topography of the city and the isthmus. In the midst of the city was the market-place, commanded by a lofty statue of *Pallas* made of bronze, and surrounded by many temples, among others those of the Ephesian *Artemis* and of *Fortune*, and by statues standing in the open air. Hence three principal roads led in various directions. The first passed westwards towards Sicyon, leading by a temple of *Apollo*, the *Odeum*, and the tomb of the children of *Medea*, *Mercurius* and *Pheres*, whom a local legend asserted to have perished at the hands of the Corinthians, after they had brought their poisoned gifts to *Glaucus*. A little further on was the temple of *Athene Chalinitis* (the bridler), so called because she bridled for *Bellerophon* the unruly *Pegasus*; the statue of the goddess was of wood and doubtless ancient, a fact which proves that the sack by *Mummius* cannot have been so complete as might have been imagined. Near this temple was a theatre, probably a work of Roman times, and a temple of the Roman *Jupiter Capitolinus*.

The second road led north towards the harbor of *Lechæum* and the Corinthian Gulf. It first passed *Propylæa*, surmounted by two gilt quadrigæ driven by *Phaethon* and *Helios*, and next the grotto where issued afresh the same fountain *Peirene* which rises near the summit of the *Acrocorinthus*, and filled a large basin with sweet water, used by the inhabitants for drinking, and as a bath in which to dip the vessels of Corinthian bronze while still red-hot, a process which was supposed to make their fineness unapproachable. The water-supply of the city was unrivalled, yet the emperor *Hadrian* constructed an aqueduct all the way from the *Stymphalian Lake*, a work, if we may believe *Pausanias*, of vain ostentation.

The third road led eastwards, first to the fashionable suburb of the city, a cypress-grove called *Craneion*. This quarter is well described in *Becker's Charicles*. It abounded with the life which distinguished Corinth from other cities, crowds of travellers, seeking both gain and pleasure, with the lively booths which offered the former, and the crowds of female slaves who ministered to the latter. Here was the tomb of *Lais*, to whom her fellow-citizens paid almost divine honors, and here, strangely, the monument of the great cynic, *Diogenes of Sinope*, who had passed his life in the midst of this gay and dissolute company. On the *Craneion* the road divided into two branches. Of these

the more southerly ran to the harbor of *Cenchree*, a roadstead fenced on both sides by promontories stretching out to sea, but not much assisted by art; while the more important *Lechæum*, on the other side of the isthmus, was almost entirely artificial. The more northerly branch of the road led to the little harbor of *Schoenus*, and the world-renowned spot where were celebrated every second year the *Isthmian Games*. These games were held in honor in early times of *Melicertes*, in later times of *Poseidon*, and close by were temples of both deities. That of *Poseidon* was not large; it contained statues of *Poseidon*, *Amphitrite*, and *Thalassa*, and in front was a crowd of statues of the victors in the games. The shrine of *Melicertes* stood under a pine; it was circular, and contained, as we know from coins, a statue of the divinity reclining on the back of a dolphin. *Melicertes* (also called *Palæmon*) had also a subterranean chapel where the most solemn oaths were administered, and it was said that perjurers seldom left the spot unpunished. Close to the temples was the stadium of the games made of white marble, and not far from it the road on which triremes were transported from sea to sea. There were also traces of a canal which, projected by *Alexander the Great*, resolved on by *Julius Cæsar*, commenced by *Nero*, was never dug more than a few hundred yards inland from the Corinthian Gulf.

In the Middle Ages Corinth suffered many disasters. It was sacked by *Alaric*, and at a later period was most bitterly contended for by the Turks and the Venetians. During the Middle Ages the city occupied the hill of *Acrocorinthus* itself, not the ledge at its base, but it has now resumed its earlier position. The modern town is small and wretched, and retains few remains of antiquity. The most remarkable among these are seven columns of an exceedingly ancient temple of the Doric order, and some traces of the Roman amphitheatre.

The best authorities on the subject are—*Ernst Curtius, Peloponnesos*, vol. ii. p. 514, and a dissertation in the *Hermes*, vol. i.; *Barth, Corinthiorum Commercii et Meroatura Historia Particula*, Berlin, 1843; *Dr. William Smith's article* in his *Dictionary of Ancient Geography*. The autonomous coins afford valuable data for the history of the Corinthian league, and the coins of Roman times offer representations of many of the most interesting objects of the later city. (p. 6.)

**CORINTHIANS, EPISTLES TO THE.** These two letters of St. Paul occupy a unique position among the Pauline epistles. They are remarkable as being in their primary aspect historical rather than doctrinal, while, at the same time, all the fundamental doctrines of Christianity, as connected with the miraculous facts on which they rest, are suggestively implied. These epistles, too, together with those to the Galatians and to the Romans, have been admitted as genuine writings of St. Paul, even by the most audacious critical assailants of the New Testament canon. The external testimony to them is early and complete, and the internal evidence of authorship and age makes it impossible to doubt the genuineness and authenticity of these remarkable documents. There are, perhaps, no other epistles in the New Testament in which there is so much of "local coloring," or so many temporal and local allusions. These letters throw great light both upon the early circumstances of the Christian Church and upon the character of the great missionary to the Gentiles; and whilst they are very full of what was due to the special occasions on which they were written, the universal applicability of the Christian principles laid down in them must be patent to every thoughtful student. *Stier* speaks of the Epistles to the Corinthians as being "a pathology and *materia medica* for all that are designed to be physicians of the church in a larger or lesser circle;" and *Bleek* remarks on the first epistle, that it "serves as a type and pattern in dealing with the multifarious tendencies, relations, and disorders of the Christian church, almost all of which have their counterpart in the Corinthian Church, and are continually repeated with various modifications at various times."

The history of the two epistles seems to be this. Paul's first visit to Corinth and his long and eventful sojourn there are mentioned in *Acts xviii. 1-18*. After his departure from the rich and luxurious capital of *Achaia*, evils which, we can perceive, were very likely to spring up in such a place began to appear in the Christian community. The Hellenic tendency to philosophical speculation and to fac-

toos partisanship, and the sensuality and licentiousness which had made the word *corinthianise* a synonym for self-indulgence and wantonness, because roots of bitterness, strife, and immorality. The presence of Apollos (Acts xviii. 27, 28) was doubtless advantageous, and St. Paul evidently alludes to a successful prosecution of evangelistic work by the learned Alexandrian, when he says "I planted, Apollos watered" (1 Cor. iii. 6). Yet it would seem that envious comparisons had been made between the simpler preaching of the Apostle Paul and the probably more philosophical and refined style of Apollos, so that some of the Corinthian Christians began to regard Apollos as their leader, rather than Paul, who had first preached the gospel unto them. The reluctance of Apollos to return to Corinth, at the time when Paul wrote what we know as the first epistle (1 Cor. xvi. 12), can best be accounted for by a consciousness on his part of the rivalry which had arisen between the two factions; and the manner in which Paul urged, and Apollos declined, the mission of the latter to Corinth may be viewed as equally creditable to the magnanimity of the older teacher and to the modesty and prudence of the younger. But a far more dangerous division of the church existed than that between those who favored Paul and those who preferred Apollos. In the Epistles to the Corinthians we have indications of the antagonism and envy of a Judaizing section, who may have been encouraged by emissaries from Palestine, like those complained of in Galat. ii. 4 (comp. Acts xv. 1, 24). These Judaizers would make much of the fact that Paul was not one of the original twelve apostles; and they seem to have endeavored to undermine his authority, by depreciating his position as a teacher, and by deriding his personal qualifications. Nor were dissensions and tendencies to split up into parties the only evils that infested the Corinthian Churches. Paul, when at Ephesus on his third missionary journey, heard of these "contentions" from the members of a Christian household, who were either resident at Corinth or connected with the place (1 Cor. i. 11); but he heard of something worse still, and more glaringly inconsistent with the Christian profession. Licentiousness was common among them, and a grievous case of incest had taken place (1 Cor. v. 1, &c.), which called for the severest censure and punishment. That the apostle had been awake to the peculiar dangers of the Corinthian Christians in respect of the licentiousness and luxury for which Corinth was noted, appears from the fact that he had previously written a letter which has not come down to us (1 Cor. v. 9), exhorting the Christians to avoid intercourse with fornicators. Alford conjectures that this letter may have also contained some instructions as to the collection (1 Cor. xvi. 1), and an announcement of an intended plan of visiting them, which he afterwards abandoned, perhaps on purpose to see what effect would be produced by the letter known to us as the first epistle, which was in reality a second one.

A good opportunity was presented for communicating with the Corinthians by the arrival of Stephanas, Fortunatus, and Achaicus (1 Cor. xvi. 17, &c.), who probably brought a letter from Corinth (1 Cor. vii. 1, &c.), requesting instructions on divers points to which St. Paul replies in the first of our two epistles. This letter from Corinth (as Paley points out) seems to have made little or no mention of the disorders and divisions which the apostle rebukes. These came to the apostle's ears by private report and not in an official communication. We have here a satisfactory explanation of the varied contents of our first epistle. After an introduction which is graceful, conciliatory, and affectionate (1 Cor. i. 1-9), the writer alludes to the indications of party spirit and dissension which had been reported to him, and, while he very earnestly vindicates the claim of the gospel to be a revelation of divine wisdom, deprecates the tendency to overrate human eloquence and intellect (i. 10-iv. 16). He tells them that he is sending Timotheus to remind them of his teaching, and that he intends himself to come soon (iv. 17-21). He then rebukes their licentiousness and their litigiousness (v., vi.), and afterwards proceeds to answer the several inquiries which had been put before him by the Corinthian letter, viz., questions concerning marriage, questions concerning meat offered to idols, and questions concerning spiritual gifts (vii.-xiv.). With his replies to particular points he blends a spirited defence of his own authority and conduct (ix.), and serious exhortations as to the behavior of women in the Christian assemblies, and the manner in which Christians should

partake of the Lord's Supper (x., xi.). One doctrinal subject is treated of directly in the epistle. Some among the Corinthians had denied the resurrection of the dead. The apostle shows that the fact of the resurrection of Jesus Christ from the dead is the basis of Christian teaching and the spring of Christian hope (xv.). He then makes reference to the collection which he was making for the brethren at Jerusalem, speaks of his own plans, sends greetings from the churches of Asia, and concludes with solemnity and tenderness (xvi.).

The subscribed note to this epistle, which asserts that it was written from Philippi, is a palpable error, possibly grounded upon a misapprehension of xvi. 5. The letter was evidently written from Ephesus, some time before Pentecost, and after winter (xvi. 6, 8), and, not improbably, near the season of the Jewish feast of the Passover (v. 7, 8), in the year 57 A. D. Whether Timothy was the bearer of the letter or not seems doubtful (xvi. 10); and it is more probable that the three messengers from Corinth, already mentioned as having brought a letter for St. Paul, returned with his reply. But Timothy and Erastus were sent together into Macedonia, and Erastus (comp. Rom. xvi. 23 and 2 Tim. iv. 20) may have been returning to his home in Corinth. Then occurred the notable disturbance at Ephesus recorded in Acts xix. 23, &c. Paul left Asia for Macedonia (Acts xx. 1), and our second epistle to the Corinthians may have been written either at Philippi or at Thessalonica, at a time when Timothy had rejoined him (2 Cor. i. 1).

It has been a frequent remark of commentators that there is no letter among those written by St. Paul so full of personal feeling as the Second Epistle to the Corinthians. The "tumultuous conflict of feeling," "the labyrinth of conflicting emotions," by which the writer was agitated, is reflected in the rapid transitions and confused eagerness, as we may term it, of his style. We can trace a twofold current of emotion,—one, of relief and gratitude because he had heard from Titus (2 Cor. vii. 7) better tidings than he had expected of the effect produced by his former letter, and the other, of righteous indignation against those persons at Corinth, who were trying to undermine his influence and misrepresent his work. We may also perceive indications of mental dejection, and references to bodily suffering which add much to the personal interest of the letter. It has been conjectured that, besides "the trouble in Asia" (i. 8) and his daily anxieties about "all the churches" for which he felt himself responsible (xi. 28), the apostle was suffering about this time from an attack of that painful and chronic malady which he calls "a stake in the flesh" (xii. 7). Titus had been sent to Corinth as a special messenger some time after the despatch of the letter from Ephesus, and was expected by Paul at Troas, but did not rejoin him until he had come into Macedonia. The news that the greater part of the Corinthian church were loyal to their old teacher, and had attended to his injunctions in the matter of the offender mentioned in 1 Cor. v., and had "sorrowed unto repentance" (2 Cor. vii. 10, 11), was very consolatory to him; but it is plain that Titus must have also informed Paul of very distinct and virulent opposition to him on the part of certain teachers and a faction of the Corinthians attached to them. Hence the indignant strain which especially appears in the latter part of the epistle, where irony and remonstrance and pathos are so wonderfully blended, and where the desire to vindicate his authority, to substantiate his personal claims to the respect and affection of the church, and to expose the mischief which was being done by the false teachers, causes him to review his own toils and infirmities in the touching picture of his work which we have in xi. 21-xii. 21. The epistle (so far as it admits of analysis) may be roughly divided into three portions, viz.—(1) a very earnest description of his own interest in and relation to the Corinthian churches, and of the impression produced on his mind by what Titus reported (i.-vii.); (2) some exhortations to liberality in respect of the collection which was going on in Macedonia and Achaia for the brethren at Jerusalem (viii., ix.); a vindication of his apostolic authority against the calumnies and misrepresentations of those who were endeavoring to subvert it (x.-xiii.). The epistle was taken to Corinth by Titus, who was quite ready to undertake a second journey (viii. 17), and with him went two other brethren (ib. 18, 22), who were selected "messengers of the churches," in charge of the contributions to the collection already men-

tioned. It has been noticed that this letter was "addressed not to Corinth only but to all the churches in the whole province of Achaia, including Athens and Cenchræ, and perhaps also Sicyon, Argos, Megara, Patrae, and other neighboring towns, all of which probably shared more or less in the agitation which affected the Christian community at Corinth" (Howson).

We may here mention the conjecture of Bleek that between our 1 Corinthians and 2 Corinthians another letter intervened, which Titus took with him on his first mission, and that this is the letter which is referred to in 2 Cor. ii. 3, vii. 8 as one of unusual severity. If this conjecture, which is a plausible one, be admitted, there must have been four letters from the Apostle Paul to the Corinthians, two of which have not been preserved. At any rate our 2d epistle is one in which all the affection and eagerness of the apostle culminate, and it gives to us, more than any other of his letters which have come down to us, an idea of the intensity of the zeal and sympathy with which he labored in the cause of the gospel. "What an admirable epistle," wrote George Herbert, "is the second to the Corinthians! how full of affections; he joys, he sorrows, he grieves, and he glories; never was there such care of a flock expressed save in the great Shepherd of the fold, who first shed tears over Jerusalem, and then blood."

There are three special points in connection with the Epistles to the Corinthians on which a few further remarks must be made. One is the question whether a visit to Corinth, which is not mentioned in the Acts, yet seems alluded to in several passages of the epistles (2 Cor. xii. 14, xiii. 1, 2, and comp. ii. 1, xii. 21), took place. The opponents of this view rely principally on the *argumentum a silentio* (which in this case, however, is a very weak one, when we consider the evidently compendious nature of St. Luke's narrative in the Acts), and on the expression "a second benefit," in 2 Cor. i. 15, 16. But this expression seems to refer to St. Paul's intention to pay a double visit to Corinth, one in going to, and a second in returning from, Macedonia. The advocates of the unrecorded visit urge, first, that the language about the "third" visit cannot reasonably be explained by saying that it was the third time St. Paul intended to come; and, secondly, that it is very natural to suppose that the apostle would have found some opportunity for at least a short visit during his three years' residence at Ephesus. This visit appears to have been a very painful one, during which St. Paul must have had sad forebodings of the evils which he rebukes in our first epistle; but it must have been a brief one, and the language of 1 Cor. xvi. 7 might possibly allude to the hurried nature of a former visit.

Another disputed point, and one which it is perhaps impossible to determine, is, What was the nature of the "Christine" party at Corinth? Were they a separate faction at all? if so, were they a Judaizing faction or a philosophizing one? Some hold that 1 Cor. i. 12 does not oblige us to believe in the existence of distinct parties or factions in the church, but only of certain tendencies. The indications throughout the epistles are, at any rate, sufficient to show that a strong antagonism existed between a Judaizing faction and a more liberal, less formal, and less scrupulous body of professed Christians, some of whom adhered to Paul as their recognized leader, while others preferred Apollos. We can quite understand how the Judaizing party would seize on the name and position of Peter, or Cephas (and it is noticeable that the Hebrew designation is preferred), as a rallying point, where they could oppose the claims of Paul and Apollos. But who were those who boasted that they were peculiarly Christ's? Some (as Howson, Alford, Stanley) think it probable they were an extreme section of the Judaizers. Others (as Neander and Olshausen) consider that they may have been "philosophical" Greeks who, "with arrogant self-will," professed to belong to no party, and renounced all "apostolic" intervention, perhaps modelling for themselves a peculiar form of Christian doctrine by means of some collection of memorable sayings and actions of Christ.

A third point which calls for brief notice is the "gift of tongues," of which so much is said in the first of our two epistles. It is quite what we should expect that a gift which ministered rather to individual notoriety than to general edification should have been abused and overrated in a Greek community like that at Corinth. It does not

seem probable, nor is there evidence forthcoming to show, that the "gift of tongues" was used for purposes of instruction. It was a mystical condition rather than a linguistic faculty,—an ecstatic utterance connected with a peculiar state of religious emotion. Stanley compares Montanist utterances, the prophets of Cevennes, Wesleyan paroxysms, and Irvingite manifestations as phenomena which, "however inferior to the manifestations of Apostolic times, have their origin in the same mysterious phase of human life and human nature."

The evidential value of the epistles to the Corinthians is very great. For we have in them indisputable historical and biographical data which in various ways imply and establish all the fundamental facts which concern the origin of the Christian church, and indicate the process of which we have a more direct narrative in the Acts, whereby Christianity was extended beyond the range of Jewish influences and prejudices, and its principles brought into contact with "the culture and vices of the ancient classical world."

There are not many special writers on these epistles. Among the Germans may be mentioned Osiander, Heydenreich, Billroth. But the book in which English readers will find the most complete and specific treatment of the subject is that by Dean Stanley. He divides the epistles into sections, and appends paraphrases of their contents. There are important notes on the allusions to the Eucharist in 1 Cor., on the miracles and organization of the apostolic age, and on the gifts of tongues and of prophecy. He adds a short dissertation on the relation of the epistles to the gospel history. In Conybeare and Howson's *Life and Epistles of St. Paul* there is a very instructive review of the condition of the primitive church, with special reference to spiritual gifts, ordinances, divisions, &c. (ch. xiii.), and the whole history of the period during which the Epistles to the Corinthians were written is admirably treated. The Armenian epistles from the Corinthians to St. Paul, and from St. Paul to the Corinthians, are apocryphal. They may be seen in Stanley's book. Paley's *Horn Paulinus* and Birks's *Horn Apostolica* contain interesting examples of undesigned coincidences between the epistles and the narrative in the Acts. Birks thinks that the Sothenes mentioned in 1 Cor. i. 1, whose name never occurs in the other epistles, may be identified with the ruler of the synagogue mentioned in Acts xviii. 17. A full discussion on "the thorn in the flesh" will be found in an interesting note of Professor Lightfoot on Gal. iv. 13. (w. a. a.)

CORIOLANUS, CAIUS (or CNEIUS) MARCIUS, a Roman patrician, said in the legend to have belonged to the 5th century B. C., and to have been a descendant of King Ancus Marcius. Brought up by his proud but patriotic mother Veturia (or, as Plutarch calls her, Volumentia), Coriolanus developed into the foremost warrior of his time, and it was from his prowess at the siege of Corioli, when he took the town single-handed, that he received his cognomen. But his hatred of the plebs lost him the consulship, and when he ventured to advise that the people, who were suffering from a dearth of corn, should not be relieved from the supplies obtained from Sicily unless they would consent to the abolition of their tribunes, he was condemned to banishment. Obtaining the command of the Volscian army, he advanced against his native city. In vain the first men of Rome prayed for moderate terms. He would agree to nothing less than the restoration to the Volscians of all their land, and their admission among the Roman citizens. At last his mother, his wife, Volumentia, and his children, accompanied by a company of Roman matrons of the highest birth, came to the Volscian camp, and by their tears and entreaties prevailed. He led back the Volscian army, and, according to one account, paid with his life the penalty of his tenderness. Niebuhr has shown that several important parts of the legend are probably historical.

CORIOLI, an ancient Latin city, celebrated as giving a surname to C. Marcius Coriolanus. It is first mentioned in Roman story as falling into the hands of the Volsci, and being retaken from them by the Romans, 493 B. C. It was never a large or important place, and seems to have dropped out of existence before the close of the 5th century B. C. The site of Corioli is now unknown. Nibbey and Gell have quite conjecturally assigned it to the hill called Monte Giove, about nineteen miles from Rome on the way to Antium, while others, with as little ground, have suggested a hill four miles nearer Antium.

CORK (perhaps from *cortex*, bark) is the outer layer of the bark of an evergreen species of oak (*Quercus Suber*). The tree reaches the height of about thirty feet, growing

in the south of Europe and on the North African coasts generally; but it is principally cultivated in Spain and Portugal. The outer layer of bark in the cork oak by annual additions from within gradually becomes a thick soft homogeneous mass, possessing those compressible and elastic properties upon which the economic value of the material chiefly depends. The first stripping of cork from young trees takes place when they are from fifteen to twenty years of age. The yield, which is rough, unequal, and woody in texture is called virgin cork, and is useful only as a tanning substance, or for forming rustic work in ferrieries, conservatories, etc. Subsequently the bark is removed every eight or ten years, the quality of the cork improving with each successive stripping; and the trees continue to live and thrive under the operation for 150 years and upwards. The produce of the second barking is still so coarse in texture that it is only fit for making floats for nets and for similar applications. The operation of stripping the trees takes place during the months of July and August. Two cuts are made round the stem,—one a little above the ground, and the other immediately under the spring of the main branches. Between these three or four longitudinal incisions are then made, the utmost care being taken not to injure the inner bark. The cork is thereafter removed in the sections into which it has been cut, by inserting under it the wedge-shaped handle of the implement used in making the incisions. After the outer surface has been scraped and cleaned, the pieces are flattened by heating them over a fire and submitting them to pressure on a flat surface. In the heating operation the surface is charred, and thereby the pores are closed up, and what is termed "nerve" is given to the material. In this state the cork is ready for manufacture or exportation.

Cork possesses a combination of properties which peculiarly fits it for many and diverse uses, for some of which it alone is found applicable. The leading purpose for which it is used is for forming bungs and stoppers for bottles and other vessels containing liquids. Its compressibility, elasticity, and practical imperviousness to both air and water so fit it for this purpose that the term cork is even more applied to the function than to the substance. Its specific lightness, combined with strength and durability, recommends it above all other substances for forming life-buoys, belts, and jackets, and in the construction of life-boats, and other apparatus for saving from drowning. On account of its lightness, softness, and non-conducting properties it is used for hat-linings and the soles of shoes, the latter being a very ancient application of cork. It is also used in making artificial limbs, for lining entomological cases, for pommels in leather-dressing, and as a medium for making architectural models. Chips and cuttings are ground up and mixed with India-rubber to form kamptulicon floor-cloth, a preparation now, however, almost superseded by linoleum, which consists chiefly of a mixture of boiled linseed oil and ground cork applied over a canvas backing. The inner bark of the cork tree is a valuable tanning material.

Certain of the properties and uses of cork were known to the ancient Greeks and Romans, and the latter, we find by Horace (*Odes*, iii. 8), used it as a stopper for wine vessels:—

"Corticem adstrictum pice dimovebit  
Amphoræ."

It appears, however, that cork was not generally used for stopping bottles till so recent a period as near the end of the 17th century, and bottles themselves were not employed for storing liquids till the 15th century. Many substitutes have been proposed for cork as a stoppering agent; but except in the case of aerated liquids none of these has recommended itself in practice. For aerated water bottles several successful devices have recently been introduced. The most simple of these is an India-rubber ball pressed upwards into the narrow of the bottle neck by the force of the gas contained in the water; and in another system a glass ball is similarly pressed against an India-rubber collar inserted in the neck of the bottle.

The cutting of corks by machinery has been found to be a matter of much difficulty, owing to the liability of the cutting edges becoming blunt, and the necessity of keeping them very sharp. Many machines have been proposed, but the work is still almost entirely done by hand labor. Messrs. Crawhall & Campbell of Glasgow have recently

introduced a machine which appears to be at once simple, expeditious, and efficient. The apparatus cuts corks and bungs of any diameter up to 3½ inches, either parallel or tapered, and an expert workman can turn off about 6 gross of corks per hour.

CORK, a maritime county in the south-west of Ireland, province of Munster, bounded on the S. by the Atlantic, E. by Waterford and Tipperary, N. by Limerick, and W. by Kerry. It is the largest county in Ireland, and contains an area of 1,849,686 acres, or 2890 square miles. The outline of the county is irregular; its sea margin is for the most part bold and rocky, and is intersected by the Bays of Bantry, Dunmanus, and Roaring Water. The southern part of the coast projects several headlands into the ocean, and its south-eastern side is indented by Cork Harbor, and Ballycotton and Youghal Bays.

The surface of the country is undulating. It consists of low rounded ridges, with corresponding valleys, running east and west, except in the western portion of the country, which is more mountainous. Those valleys are drained by the Blackwater, the Lee, and the Bandon River. The most elevated part of the county is in connection with the Boghra Mountains, the highest of which, Cahorbanagher, reaches 2239 feet. North of the Blackwater the county is comparatively level, being a portion of the great plain which occupies a large part of the centre of Ireland. Of the principal rivers the Blackwater has its source in the county of Limerick. The Lee originates in Goughanbarra Lake, and the Bandon River rises in the Cullinagh Lake. There are also some smaller streams which flow directly into the sea, the more important of these being in the south-west portion of the county. No lakes of any magnitude occur, the largest being Inchigeelagh, which is an expansion of the River Lee between Macroom and its source. Of the total area 14,368 acres are covered with water. The scenery of the western parts of the county is bold and rugged. In the central and eastern parts, especially in the valleys, it is green and sheltered, and in some spots well wooded.

*Geology and Minerals.*—With reference to the geology of the county, the hills are principally composed of Old Red Sandstone, which is the lowest formation that occurs. In the western and mountainous districts these rocks consist of purple and green-colored sandstones and grits—"Glengariff grits"—which are several thousand feet thick. In the central and eastern districts the same rocks occur in the form of brownish purple sandstone and shales—"brounstones." The veins are highly contorted, and form anticlinal axes, and they exhibit change in various degrees. They are locally extensively used as building stones, and are usually split along their cleavage planes. These Old Red Sandstones have afforded no traces of fossils in this county. Upon the "brounstones," the highest member of the Old Red Sandstones, the "Yellow Sandstones" occur. They have a thickness of about 800 feet, and afford fossil plants, shells, and crustaceans. To the Yellow Sandstone succeeds the base of the Carboniferous group. These consist of black slaty rock—"Carboniferous slabs." In the eastern parts of the county these strata rise about 900 feet thick; westwards they increase greatly, being at the Old Head of Kinsale about 6500 feet in thickness. They have at their base grey gritty beds of varying thickness—the "Coomhola grits." Both members of the series are fossiliferous, and the Carboniferous slates have been extensively worked in many localities for roofing. They are, however, much inferior to the Bangor slates.

The principal valleys in the county of Cork, except in the case of the Bandon River, are in their lower parts occupied by Carboniferous limestone, overlying the Carboniferous slate and occurring at synclinal troughs. The limestones are commonly light grey in color and of great thickness. For the most part they are very pure carbonate of lime, thick-bedded and compact. Some are used as marbles, but their most extensive application is as building stones, which are durable and of good color. In the neighborhood of the city of Cork (Little Island), near the centre of the synclinal trough, a brecciated red limestone is worked, being polished as a marble. It is known as "Red Cork Marble." In some localities near the city of Cork the limestone is dolomitic, and is extensively quarried for the manufacture of magnesia. Some portions of the limestones are very fossiliferous. Near Mallow it is thin-bedded and contains nodules of schist. Succeeding

the limestone, which represents the scar limestone and Yoredale series of England, are shales and flags, equivalents of the millstone grits, on which lie the coal measures south of Kanturk. The coal is anthracite, very irregular in thickness, and highly inclined. The strata are much contorted and crushed, the coal frequently occurring in "pockets." Several seams are known, some of which are worked. These coals have only a local sale, being used principally for lime-burning.

In the south-west part of the county igneous rocks are partially developed. Copper pyrites was formerly extensively mined in the south-west of the county, especially at Berehaven or Allihies,—the rocks more prolific in copper being the Yellow Sandstone series. Little is now being done at those or other copper mines in the county.

Lead also occurs in small veins, but not in sufficient quantity to be worked. Near Glandore manganese, mostly in the form of psilomelane, has been largely worked, but is now abandoned.

Clay which is used for brick-making occurs near Youghal, where there are extensive potteries. Bricks are also made from the silty clay deposited by the River Lee on small islands in the Douglas Channel.

**Climate.**—The climate is moist and warm, the prevailing winds being from the west and south-west. The rainfall in the city is about 40 inches *per annum*,—that of the whole county being somewhat higher, about 44 inches. The mean average annual temperature is about 52° Fahr. The snow-fall during the winter is usually slight, and snow rarely remains long on the ground except in sheltered places. The thermal spring of Mallow was formerly in considerable repute; it is situated in a basin on the banks of the Blackwater, rising from the base of a limestone hill. It has been long celebrated for the cure of pulmonary, chlorotic, stomach, and urinary complaints, in the cure of which its waters are said to be very efficacious. The temperature of the water, 72° Fahr., is nearly invariable. The climate of Mallow is soft and agreeable. The chief places for sea-bathing are Blackrock, Passage, Monkstown, and Queenstown in the vicinity of Cork; Kinsale, Ballycotton, and Youghal are also much frequented by invalids during the summer months.

**Fisheries.**—The Kinsale fishery, now established about fifteen years, promises to be the most remunerative of the industrial resources of the south of Ireland. The mackerel fishery in 1875 commenced as usual about the middle of March, and lasted to the second week in June, at which time over £185,000 worth of fish was caught and purchased from the fishermen. In 1876 there were engaged in the trade 383 boats from Cornwall, the Isle of Man, Howth, Arklow, and Kinsale, the proportion from the last-named place numbering 60. There were also twenty-two hulks in the harbor used as icehouses, on the deck of which the fish was packed for the English markets. Eight Norwegian barks laden with ice arrived. These, with eleven steamers especially chartered for the fish trade, fifteen Jersey trading cutters for conveying fish, and three Cork tugs, comprised the staff of the local trade. The fishing boats are supplied with trains of nets, 2½ miles in length and 8 feet in depth. They start early in the morning for the fishing grounds, and at sunset let down the nets. They are floated with small pieces of cork, and the bottom of the nets is sunk by heavy ropes. They are allowed to drift all night, and the mackerel are caught by running their heads into the meshes of the net. They are purchased by the fish-buyers, packed in boxes containing 120 each, and immediately forwarded per steamer to Bristol, Milford, and Holyhead, for Birmingham, London, Manchester, and Liverpool. The fishery extends from Cape Clear nearly to Cork Harbor. Hake, cod, and haddock, which were formerly taken in great abundance here, seem to have in a great measure left the coast.

**Agriculture.**—The soils of the county exhibit no great variety. They may be reduced in number to four:—the calcareous in the limestone districts; the deep mellow loams found in districts remote from limestone, and generally occurring in the less elevated parts of the grey and red sandstone districts; the light shallow soils, and the moor land or peat soil, the usual substratum of which is coarse retentive clay.

In a district of such extent and variety of surface, the state of agriculture must be liable to much variation. The more populous parts near the sea, and in the vicinity of the great lines of communication, exhibit very favorable specimens of agricultural improvement.

No advancement has recently been made in the extent of land placed under tillage, and the principal crops raised are oats, potatoes, and turnips. In 1876 the total area under tillage amounted to 430,541 acres, of which 157,365 were under corn crops, 127,208 under green crops, and 145,870 grass under rotation. The corn and green crops were thus distributed in the two years 1873 and 1876 respectively:—

Acreage.	Oats.	Wheat.	Barley, &c.	Potatoes.	Turnips.
1873.....	116,990	19,133	25,470	68,338	40,476
1876.....	117,330	18,043	21,990	71,958	39,528

Dairies are extensive, and the character of the Cork butter stands high in the English and foreign markets. Cork possesses the largest number of live-stock of any county in Ireland, except in sheep and asses, in the former of which it is exceeded by Galway, and in the latter by Tipperary. The numbers of live-stock in the years 1873 and 1876 were as follows:—

Horses and Mules.	Asses.	Cattle.	Sheep.	Pigs.	Goats.	Poultry.
1873...54,044	8168	372,412	342,697	136,661	23,526	971,821
1876...53,425	9312	365,729	322,349	170,048	25,102	1,135,951

The total value of the land, exclusive of the city of Cork, according to the return of 1875, was £1,059,994, and the average value per acre 11s. 7½d.—that of all Munster being 11s. 2½d. The county in the same year was divided among 5889 separate proprietors, of whom 3091 possessed less than one acre, being a much larger proportion of small owners than in the rest of Munster. The average size of the holdings amounted to 309½ acres—that of all Munster being 37½. Eighteen proprietors owned upwards of 10,000 acres each, and held a total of one-fifth of the whole county. The principal proprietors were the earl of Bantry, 69,500 acres; duke of Devonshire, 32,650; Sir George C. Colthurst (Ardrum), 31,260; countess of Kingston (Mitchelstown), 24,421; earl of Kenmare, 22,700; earl of Cork and Orrery, 20,165; Sir H. W. Becher (Ballygiblin), 18,933; earl of Egmont (Lohort Castle), 16,766; R. H. E. White (Glengariff), 16,175; and Lord Fermoy, 15,543. Of waste ground there was estimated to be 15,360 acres.

**Administration.**—The county is divided into east and west ridings (the county of the city is in the east riding); it is subdivided into 33 baronies, containing 261 parishes, which form the diocese of Cork, Cloyne, Ross, and part of Ardferit. Since the disestablishment of the Irish Church, that body has under the diocesan scheme reduced the number of parishes by amalgamation to ninety-five.

The Cork military district has barracks at Cork (head-quarters), Kinsale, Fermoy, Ballincollig, Queenstown, Spike Island, Camden and Carlisle Forts at the entrance to the harbor (lately fortified with all the improvements of modern science), Bandon, Youghal, and Buttevant. The constabulary force of the county consists of 674 men in the east and west ridings, two inspectors, and seventeen sub-inspectors; the officers have their headquarters at Cork and Bandon. The poor-law unions are Bandon, Bantry, Castletown, Clonakilty, Cork, Dunmanway, Fermoy, Kanturk, Kinsale, Macroom, Mallow, Midleton, Millstreet, Mitchelstown, Skibbereen, Skull, and Youghal.

**Population.**—The number of inhabitants in this county has greatly decreased within the last thirty years. At the last census (1871) there was a population of 517,076 persons (males, 256,062; females, 261,014); in 1861 it was 544,818 and in 1851, 649,308, showing a decrease between 1851 and 1871 of about 20 per cent., while that of all Munster was 25 per cent. The estimated population of the county for 1875 was 507,016. The principal towns are Cork, population 102,526; Queenstown, 10,340; Fermoy, 7388; Kinsale, 7050; Bandon, 6131; Youghal, 6081; Mallow, 4165; Skibbereen, 3695; and Midleton, 3603.

During the five years ending 1875, the average number of emigrants per annum amounted to 7110, and the total number from 1851 was 301,573, the largest proportion of any Irish county. Of late years, however, the exodus has considerably abated.

The prevailing religion of the inhabitants is the Roman Catholic. In 1871 there were 517,076 Catholics to 49,455 Protestants (40,493 Episcopalians, and 8962 of various denominations)—the proportion of Protestants to the whole population amounting to little more than 9½ per cent., while that of all Munster was 6½.

The number of persons in 1871 of five years and upwards who could read and write was 219,074; 47,091 could read

but could not write, and 183,114 could neither read nor write; 11,628 were returned as able to speak Erse only.

**Representation.**—Previous to the Union the county returned twenty-six members to the Irish Parliament. At that time, however, the representation was reduced to eight—two for the county, two for Cork city, and one each for the boroughs of Mallow, Bandon, Youghal, and Kinsale.

**History.**—According to Ptolemy, the districts now known by the names of the county of Cork and Desmond were anciently inhabited by the Coriandi, Udise or Vodii, Velabori, and Uterni, which Dr. Smith considers to be a corruption of the name Iberi. Before the arrival of Strongbow Cork was a kingdom of itself, governed by the MacCarthys; but in 1172 Dermot MacCarthy, who had sworn fealty to Henry II., threw off his allegiance, and attacked the English under Raymond le Gros, thereby forfeiting the crown. What formed his kingdom was granted by Henry II. to Robert Fitzstephen and Milo de Cogan, with the exceptions of the city of Cork and the adjoining cantred belonging to the Ostmens of the same city, which were retained by the king. It was made shire ground by King John in 1210, who appointed sheriffs and other local officers for its government. For many years, however, the royal writs were of little efficacy in many parts of it, as the great families still virtually commanded the allegiance of the inhabitants.

Fitzstephen's share of the grant descended through the female line to the Barrys and Roches, whilst that of De Cogan became vested in Maurice Fitzgerald, growing into an extent of territory and consequent power far exceeding any ever possessed by the MacCarthys. Whilst making a show of attachment to the English, the Fitzgeralds intrigued with the foreign Roman Catholic powers (who projected the conquest of Ireland during the reign of Queen Elizabeth), and ultimately broke out into open rebellion. After being utterly defeated, Gerald, the fifteenth and last earl of Desmond, when a fugitive in the wilds of Kerry, was slain by an obscure individual named Kelley. Against this earl of Desmond an act of attainder was passed in 1583, and the Fitzgeralds of Desmond, after having maintained their power and possessions for upwards of 300 years, were reduced to utter ruin; their strong castles were seized, and their vast estates, to the extent of no less than 574,628 acres, confiscated by the Crown. These were again transferred to English settlers, called undertakers or planters, who were bound not to convey any part of the lands to the native Irish, or to intermarry with or maintain any of them. Sir Walter Raleigh obtained 40,000 acres, which afterwards passed to the family of Boyle, earl of Cork; Arthur Robins, 18,000; Hugh Worth, 12,000; Fane Beecher, 12,000; Arthur Hyde, 12,000; Sir Warham St. Leger, 6000; Sir Thomas Norris, 6000; Hugh Cuske, 6000; Thomas Say, 5800; Sir Richard Beacom, 1600; and Edmund Spenser, the poet, 3028. This attempt to set aside or extirpate the native population failed. The Irish outbade the English settlers, and were therefore, at least for a time, found to be more profitable tenants, so that ultimately they re-occupied nearly all the lands as tenants under the English undertakers. In 1602 a large portion of the estates of Sir Walter Raleigh and Fane Beecher were purchased by the earl of Cork, who had them colonized with English settlers; and by founding or rebuilding the towns of Bandon, Clonskilly, Baltimore, Youghal, and afterwards those of Middleton, Castlemartyr, Charleville, and Doneraile, which were incorporated and made parliamentary boroughs, the family of Boyle became possessed of nearly the entire political power of the county. In 1641 and the following years the sons of the earl of Cork, more especially Lord Broghill, rendered good service to the Parliamentary cause, and obtained considerable military renown. The course of events led to the forfeiture of the estates of Lords Muskerry and Roche, and afterwards of those of the earl of Clancarty, Viscount Kenmare, Sir Richard Nagle, and others, to the extent of 250,000 acres. Since that period no events of equal importance have occurred in this county.

**Antiquities.**—The earlier antiquities of the county are rude monuments of the Pagan era, such as stone circles, druids' altars, "raths" or circular mounds of earth, and stone pillars. There are two so-called druids' altars, the most perfect at Castlemartyr, near Cloyne, and certain pillar stones scattered through the county, with straight marks cut on the edges called Ogham inscriptions, the interpretation of which is still a subject of much controversy.

The remains of the old ecclesiastical buildings are in a very ruinous condition, being used as burial-places by the county people. The principal is Kilerua, founded by Cormack M'Carthy about 1465, some of the tombs of whose descendants are still in the chancel; the steeple is still nearly perfect, and chapter-house, cloister, dormitory, and kitchen can be seen. Timoleague, situated on a romantic spot on a rising ground at the extreme end of Courtmacsherry Bay, contains some tombs of interest, and is still in fair condition. Buttevant Abbey contains some tombs of the Barrys and other distinguished families. All these were the property of the Franciscans. There are two round towers in the county, one in a fine state of preservation opposite Cloyne Cathedral, the other at Kinneigh. From

the chapter seal of Ross, which is dated 1661, and seems to have been a copy of a much earlier one, there is a good representation of a round tower and stone roofed church, with St. Fachnan, to whom the church is dedicated, standing by, with a book in one hand and a cross in the other. Of Mounre Abbey, near Mallow, once a preceptory of the Knights Templars, and Tracton Abbey, which once sent a prior to Parliament, the very ruins have perished.

Of the castles, Lohort, built in the reign of king John, is by far the oldest, and in its architectural features the most interesting; it is still quite perfect and kept in excellent repair by the owner, the earl of Eglmont. Blarney Castle, built by Cormack M'Carthy about 1449, has a world-wide reputation, to which Millikin's song, "The Groves of Blarney," in no small degree contributed; it is also bound up with the civil history of the county and the war of the great rebellion. Castles Mahon and Macroom have been incorporated into the residences of the earls of Bandon and Bantry. The walls of Mallow Castle attest its former strength and extent, as also the castle of Kibolane. The castles of Kilerua and Dripay are still in good condition. (R. C.)

CORK, a city and port, is a 'bounty in itself, 138 miles south-west of Dublin direct and 165 by rail, and 11 miles north-west of the port of Queenstown, in 51° 53' 39" N. lat. and 8° 20' W. long. Until lately it ranked as the second city in Ireland, but of late Belfast has far surpassed it in population, wealth, and commerce. The original site of the city seems to have been located in the vicinity of the cathedral, which was founded by St. Fin-Barre about 622. In the 9th century this place was frequently pillaged by the Northmen or Danes. According to the *Annals of the Four Masters*, a fleet burned Cork in 821; in 846 the Danes appear to have been in possession of the city, for a hosting was made to demolish their fortress; and in 1012 a great fleet of foreigners burned Cork. The Danes then appear to have founded the new city on the banks of the River Lee for the purpose of trade. The city was anciently surrounded with a wall, and we find in the city council book an order for its reparation so late as the year 1748. In the beginning of the 18th century the ground on which the principal part of the present city is built consisted of numerous islands intersected by canals or connected by drawbridges, through which small vessels could pass at high tide. The river now consists of the north and south branches. Both are lined with fine quays of cut limestone, the north spanned by four and the south by as many more bridges. The principal streets are St. Patrick Street, Grand Parade, South Mall, and Great George Street. There are 517 streets, roads, lanes, and public passages in the borough, measuring 54½ miles. St. Patrick's Bridge is an elegant structure, commenced in 1859.

**Churches.**—There are eight Protestant parish churches, including the cathedral. St. Luke's has lately been separated from St. Ann de Shandon. There are three Roman Catholic parish churches, and the church of St. Patrick. The Franciscan, Dominican, Augustinian, Carmelite, and St. Vincent de Paul orders have also their respective churches; there are besides three convents and two monasteries. The principal church is the new Protestant cathedral, the foundation-stone of which was laid 12th January, 1865. It succeeds a rather mean building, the foundation-stone of which was laid in 1735 on the site of a very ancient cathedral which suffered during the siege of Cork in September, 1689-90. This building is in the Early French style, and when completed will cost near £100,000. The tower and spires now being erected are the gift of two merchant princes of Cork—Mr. William Crawford and Mr. Francis Wise—and will cost £30,000. The entire cathedral is due to the indefatigable exertions and munificence of Dr. John Gregg, Bishop of Cork, Cloyne, and Ross. The other Protestant churches are extremely poor externally, except St. Nicholas and St. Luke's; the latter is a neat structure on the high ground north-east of the city. The Roman Catholic cathedral is being restored to suit the fine Gothic steeple which adjoins it. The other Roman Catholic churches, St. Mary, St. Peter and Paul, St. Patrick, Holy Trinity, and St. Vincent de Paul, are magnificent structures, and rank amongst the finest modern ecclesiastical edifices in Ireland. There are also the Presbyterian, a Baptist, an Independent, and two Wesleyan Methodist places of worship, as well as a Friends' meeting-house.

**Public Buildings.**—The court-house is an elegant Grecian structure with a Corinthian portico about 30 feet in height. The Corn Exchange, Savings Bank, Provincial Bank, and Bank of Ireland are handsome buildings of cut limestone.

The custom-house is built at the juncture of the two branches of the River Lee, and commands the river. The Commercial Buildings, Chamber of Commerce, and Hibernian, National, and Munster Banks all possess some architectural merit.

*Educational, Scientific, and Charitable Institutions.*—The Queen's College, built on the site of an old feudal castle, is a fine structure, in the Tudor-Gothic style. It was opened 1849, and now possesses a library of about 22,000 volumes, a good museum, and a laboratory furnished with all the apparatus necessary for the advancement of modern scientific inquiry. The Model School has a daily attendance of about 381 pupils; Christian Brothers, 1870 pupils; Sisters of Charity, 750 pupils; Presentation Nuns, 1650 pupils; Sisters of Mercy, 600 pupils; Presentation Brothers, 1200 pupils. There are also the several parochial and industrial schools which are well attended. Under the auspices of the National Board is the Cork Agricultural School, about two miles from the city, for the purpose of educating pupils exclusively in agricultural science.

The Cork Library, which was founded 1790, contains a valuable collection of books in every department of literature. The Royal Cork Institution, established by a royal charter in 1807, in addition to an extensive library of

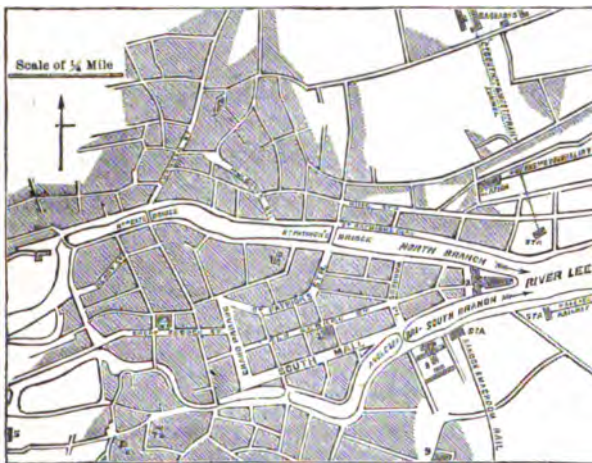

Plan of Cork.

- |                                    |                     |
|------------------------------------|---------------------|
| 1. School of Design and<br>Museum. | 5. Queen's College. |
| 2. Custom House.                   | 6. Cathedral.       |
| 3. Theatre.                        | 7. Barracks.        |
| 4. Court House.                    | 8. Corn Exchange.   |
|                                    | 9. Blind Asylum.    |

works chiefly scientific and historical, and a rare collection of Oriental MSS., possesses a valuable collection of minerals classified for examination. The fine collection of casts from the antique presented by the Pope to King George IV., which are now the property of the institution, are used by the pupils of the Cork School of Art. There are numerous literary and scientific societies, and the Cork Cuvierian and Archaeological Society, which publishes a monthly report of its proceedings. There also are young men's societies presided over by the clergy of the different religious denominations.

The North and South Infirmary and Fever Hospital are supported by public grants, and hospitals have been established and supported by private benevolence for almost every form of human suffering. The Cork District Lunatic Asylum occupies a fine position on the brow of a hill in the western suburb. It contains a daily average of 730 patients; the recoveries are computed at about 43·3 per cent. The Cork Union Workhouse contains a daily average of 2000 inmates, about one-half of whom are daily under hospital treatment. The buildings, out-offices, &c., occupy about 18 acres of land; the annual income from taxation is £40,000.

The city water-works were erected under local Acts of 1852-56 at a cost of £100,000. They supply the city with 5,000,000 gallons of water daily, also 625 hydrants and 166 public fountains; the extent of main pipes is 59 miles, of service pipes, about 66. Since the passing of the Inter-mural Burial Act the corporation of Cork has estab-

lished a new cemetery (St. Fin-Barre's) about a mile west of the city, at a cost of £12,000. It is already adorned with some handsome and costly monuments. St. Joseph's cemetery, founded by Father Matthew in 1830 on the site of the old Botanic Gardens of the Cork Institution, is also beautifully planted and much used.

*Trade.*—The Cork Butter Exchange may be considered as the centre of the most important branch of manufacture, not only in the county but in the entire province of Munster. Stafford in his letters mentions the exportation of corn and butter from Cork in 1633 to Spain. The present market dates from 1769, from which time there exists an unbroken series of accounts. The largest number of firkins of butter on record that passed through the market was that of the year ending 14th April, 1876. The number amounted to 431,796 firkins, representing a marketable value of nearly £1,700,000. The season 1859-60 approached it very closely (431,462), which was accounted for by the gold fever then at its height in Australia, Cork being the only market capable of meeting the demand, supplying a kind of butter suited to bear a long voyage; its preparation is a *spécialité*, the system of classification by branding being carried out under the inspection of an expert. Each firkin contains on an average 74 lbs. Wheat and corn are extensively imported into Cork, the facilities for discharging vessels of great burden being lately increased by deepening the channels of the river and erecting jetties along the Marina. For the year ending 31st December, 1875, there were 620,240 quarters of wheat and 289,275 quarters of corn discharged in the port of Cork (a quarter is about 480 lbs). There are three distilleries and four breweries in the city, which manufacture largely for home consumption and exportation. The tanning trade is also extensively carried on. An extensive flax-mill has been lately established, and a manufactory for chemical manure, which produces about 10,000 tons annually. A large traffic is also carried on in the exportation of cattle (for which special steamers are sometimes run twice a week), eggs, feathers, and fish, particularly salmon, for which the River Lee is celebrated. The registered tonnage of vessels at the port in 1876 was 34,801. The number and tonnage of vessels entering the port, employed in the cross channel and coasting trade, reached 2644 vessels and 667,316 tons; in the British colonial trade, 62 vessels of 27,641 tons; in the foreign trade, 637 vessels, tonnage 161,739. The custom duties of the port average about £288,641.

*Municipality.*—The city, which is represented in Parliament by two members, is presided over by a mayor, a high sheriff, fourteen aldermen, and forty-one town councillors. It has from time to time received several charters; the oldest, a copy of which only remains, is preserved in the Library of the British Museum (*Hart*, No. 441). The principal charter is that of James I. The council books of the corporation from 1610 to 1800 have just been published. Cork holds a conspicuous place in the annals of Ireland, as will be seen by reference to the calendar of state papers, lately published under the master of the rolls. On 28th September, 1689-90, the city surrendered to the earl of Marlborough after five days' siege, when the duke of Grafton was mortally wounded, The Irish were in possession of the city and Elizabeth Fort adjoining, which capitulated after being attacked with the muskets of a few soldiers, who fired into it from the steeple of the cathedral of Cork, which was directly opposite. The principal subsequent events of any moment will be found recorded in the council books above mentioned.

*Population.*—The decrease in the population of the county has not extended to the city in the same proportion. In 1851 the inhabitants of the municipal borough, within an area of 2266 acres, numbered 85,745; in 1861, 80,121, and in 1871, 78,642 (males, 36,847; females, 41,795), showing a decrease within twenty years of about 8½ per cent., that of the county being 20 per cent. The Parliamentary borough, which has an area extending to 46,086 acres, contained 102,526 inhabitants in 1871. Of the population in the municipal borough 66,716 were Catholics and 11,926 Protestants. The proportion of Protestants, of whom 9196 were Presbyterians and 1028 Episcopalians, is equal to 15½ per cent. of the whole population, considerably higher than in the county. (R. C.)



CORK, EARLS OF. See BOYLE, vol. iv. p. 166.

CORLEONE, a town of Sicily, in the province of Palermo, about 23 miles south of the city of that name, on the slope of a hill near the head waters of the Belici. It is well built and has two castles, one in ruins and the other used as a prison, and several good churches, of which the chief was restored in 1392. The town was one of the Saracen settlements in Sicily, and the castles are believed to be of Saracen erection; the inhabitants are principally descendants of a Lombard colony, introduced in 1227 by Frederick II., and traces of the Lombard dialect are still observable. A fair trade is carried on with Palermo. The population, including the suburb of S. Niccolo, exceeds 16,000.

CORMENIN, LOUIS MARIE DE LA HAYE, VISCOUNT DE (1788-1868), a French jurist and political pamphleteer, was born at Paris, January 6, 1788. His father and his grandfather both held the rank of lieutenant-general of the admiralty. In consequence of the suppression of the colleges he received his early education at a private school at Paris, and afterwards studied in the school of law. At the age of twenty he was received advocate, and about the same time he gained some reputation as a writer of piquant and delicate poems. In 1810 he received from Napoleon I. the appointment of auditor to the council of state; and after the restoration of the Bourbons he became master of requests. During the period of his connection with the council he devoted himself zealously to the study of administrative law, and acquired those stores of exact knowledge which afterwards furnished the material for his principal work as a jurist. He was selected to prepare some of the most important reports of the council. Among his separate publications at this time are noted,—*Du Conseil d'Etat envisagé comme conseil et comme juridiction dans notre monarchie constitutionnelle* (1818), and *De la responsabilité des agents du gouvernement*. In the former he claimed, for the protection of the rights of private persons in the administration of justice, the institution of a special court whose members should be irremovable, the right of oral defence, and publicity of trial. In 1822 appeared his *Questions de droit administratif*, in which he for the first time brought together and gave scientific shape to the scattered elements of administrative law. These he arranged and stated clearly in the form of aphorisms, with logical deductions, establishing them by proofs drawn from the archives of the council of state. This is recognized as his most important work as a jurist, and has become the chief authority on its subject. It has passed through five editions, the fifth, which was published in 1840, being thoroughly revised. In 1828 Cormenin entered the Chamber of Deputies as member for Orleans, took his seat in the Left Centre, and began a vigorous opposition to the Government of Charles X. As he was not gifted with the qualifications of the orator, he seldom appeared at the tribune; but in the various committees he defended all forms of popular liberties, and at the same time delivered, in a series of powerful pamphlets, under the pseudonym of "Timon," the most formidable blows against tyranny and all political and administrative abuses. The ministerialists named him "l'homme du contentieux." After the revolution of July, 1830, Cormenin was one of the 221 who signed the protest against the elevation of the Orleans dynasty to the throne; and he resigned both his office in the council of state and his seat in the chamber. He was, however, soon re-elected deputy, and now voted with the extreme Left. The discussions on the budget in 1831 gave rise to the publication of his famous series of *Lettres sur la liste civile*, which in ten years ran through twenty-five editions. In the following year he had the distinction of being elected by four arrondissements; he took his seat for Belley. In 1834 he was elected by two arrondissements, and sat for Joigny, which he represented till 1846. In this year he lost his seat in consequence of the popular prejudice aroused against him by his trenchant pamphlet *Oui et non* (1845) against attacks on religious liberty, and a second entitled *Feu! Feu!* (1846), written in reply to those who demanded a retraction of the former. In this he re-asserted his principles still more relentlessly. Sixty thousand copies were rapidly sold. One inevitable penalty which he had to suffer for these incisive manifestoes was exclusion from the French Academy and the Academy of Moral and Political Sciences. Cormenin was an earnest advocate of universal suffrage before the revolution of February, 1848,

and had remorselessly exposed the corrupt practices at elections in his pamphlet—*Ordre du jour sur la corruption électorale*. After the revolution he was elected by four departments to the constituent assembly, and became one of its vice-presidents. He was also member and president of the constitutional commission, and for some time took a leading part in drawing up the republican constitution. But the disputes which broke out among the members led him to resign the presidency. He was soon after named member of the council of state and president of the *comité du contentieux*. It was at this period that he published two pamphlets—*Sur l'indépendance de l'Italie*. After the *coup d'état* of December 2, 1851, Cormenin, who had undertaken the defence of Prince Louis Napoleon after his attempt at Strasburg accepted a place in the new council of state of the empire. Four years later, by imperial ordinance, he was made a member of the Institute. One of the most characteristic works of Cormenin, not yet mentioned, is the *Livre des orateurs*, a series of brilliant studies of the principal parliamentary orators of the restoration and the monarchy of July, the first edition of which appeared in 1838, and the eighteenth in 1860. In 1846 he published his *Entretiens de village*, which procured him the Montyon prize, and of which six editions were called for the same year. His last work was *La droit de tonnage en Algérie* (1860). Cormenin was distinguished also as a practical philanthropist, and is said to have established more charitable institutions than any layman of his time in France. He was admitted to the Legion of Honor in 1821, and was promoted commander in 1865. He died at Paris, May 6, 1868.

CORMONTAIGNE, LOUIS DE (1696-1752), a French military engineer, was born at Strasburg. He was present as a volunteer at the sieges of Friburg and Landau, and in 1715 he entered the Engineers. From 1733 to 1745 he took part in several of the most important sieges in the Polish and Austrian wars. Having gained the rank of *maréchal de camp* he received charge of the line of fortifications from Calais to the Rhone; and he built new defences at Strasburg, Metz, and Thionville, at which last place he died.

With the exception of the *Architecture militaire*, printed at the Hague in 1741, and reprinted at Paris in 1809 as the *Mémorial pour la fortification permanente et passagère*, and extracts published and used as text-books, the works of Cormontaigne remained in MS. till the beginning of the present century. First published at Berlin in 1803, the *Mémorial pour l'attaque des places* was printed at Paris in 1806, as also was the *Mémoire pour la défense des places*. All three treatises were republished, with a preface, by Bousmard in 1809.

CORMORANT—from the Latin *corvus marinus*,<sup>1</sup> through the French (in some *patois* of which it is still "cor marin," and in certain Italian dialects "corvo marin" or "corvo marino")—a large sea-fowl belonging to the genus *Phalacrocorax*<sup>2</sup> (*Carbo*, *Haliæus*, and *Græculus* of some ornithologists), and that group of the Linnæan Order *Anseres*, now partly generally recognized by Illiger's term *Staganopodes*, of which it with its allies forms a Family *Phalacrocoracidae*.

The Cormorant (*P. carbo*) frequents almost all the sea-coast of Europe, and breeds in societies at various stations, most generally on steep cliffs, but occasionally on rocky islands as well as on trees. The nest consists of a large mass of sea-weed, and, with the ground immediately surrounding it, generally looks as though bespattered with whitewash, from the excrement of the bird, which lives entirely on fish. The eggs, from four to six in number, are small, and have a thick, soft, calcareous shell, bluish-white when first laid, but soon becoming discolored. The young are hatched blind, and covered with an inky-black skin. They remain for some time in the squab condition, and are then highly esteemed for food by the northern islanders, their flesh being said to taste as well as a roasted hare's. Their first plumage is of a sombre brownish black above, and more or less white beneath. They take two or three years to assume the fully adult dress, which is deep black, glossed above with bronze, and varied in the breeding-season with white on the cheeks and flanks, besides being adorned by filamentary feathers on the head, and further set off by a bright yellow gape. The old Cormorant looks

<sup>1</sup> Some authors, following Cælius, derive the word from *corvus vorans* and spell it Corvorant but doubtless wrongly.

<sup>2</sup> So spelt since the days of Gessner; but possibly *Phalacrocorax* would be more correct.

as big as a Goose, but is really much smaller; its flesh is quite uneatable.

Taken when young from the nest, this bird is easily tamed and can be trained to fish for its keeper, as was of old time commonly done in England, where the Master of the Cormorants was one of the officers of the royal household. Now-a-days the practice is nearly disused, though a few gentlemen still follow it for their diversion. When taken out to furnish sport, a strap is fastened round the bird's neck so as, without impeding its breath, to hinder it from swallowing its captures.<sup>1</sup> Arrived at the waterside, it is cast off. It at once dives and darts along the bottom as swiftly as an arrow in quest of its prey, rapidly scanning every hole or pool. A fish is generally seized within a few seconds of its being sighted, and as each is taken the bird rises to the surface with its capture in its bill. It does not take much longer to dispose of the prize in the dilatable skin of the throat so far as the strap will allow, and the pursuit is recommenced until the bird's gular pouch, capacious as it is, will hold no more. It then returns to its keeper, who has been anxiously watching and encouraging its movements, and a little manipulation of its neck effects the delivery of the booty. It may then be let loose again, or, if considered to have done its work, it is fed and restored to its perch. The activity the bird displays under water is almost incredible to those who have not seen its performances, and in a shallow river scarcely a fish escapes its keen eyes and sudden turns, except by taking refuge under a stone or root, or in the mud that may be stirred up during the operation, and so avoiding observation.<sup>2</sup>

Nearly allied to the Cormorant, and having much the same habits is the Shag, or Green Cormorant of some writers (*P. graculus*). The shag (which name in many parts of the world is used in a generic sense) is, however, about one-fourth smaller in linear dimensions, is much more glossy in plumage, and its nuptial embellishment is a nodding plume instead of the white patches of the Cormorant. The easiest diagnostic on examination will be found to be the number of tail-feathers, which in the former are fourteen and in the Shag twelve. The latter, too, is more marine in the localities it frequents, scarcely ever entering fresh or indeed inland waters.

In the south of Europe a still smaller species (*P. pygmaeus*) is found. This is almost entirely a fresh-water bird, and is not uncommon on the lower Danube. Other species, to the number perhaps of thirty or more, have been discriminated from other parts of the world, but all have a great general similarity to one another. New Zealand and the west coast of Northern America are particularly rich in birds of this genus, and the species found there are the most beautifully decorated of any. All, however, are remarkable for their curiously-formed feet, the four toes of each being connected by a web, for their long stiff tails, and for the absence, in the adult, of any exterior nostrils. When gorged, or when the state of the tide precludes fishing, they are fond of sitting on an elevated perch, often with extended wings, and in this attitude they will remain motionless for a considerable time, as though hanging themselves out to dry, but hardly, as the fishermen report, sleeping the while. It was perhaps this peculiarity that struck the observation of Milton, and prompted his well-known similitude of Satan to a Cormorant (*Parad. Lost*, iv. 194); but when not thus behaving they themselves provoke the more homely comparison of a row of black bottles. Their voracity is proverbial. (A. N.)

**CORN LAWS.** Legislation on corn was early applied both to the home and foreign trade in this essential produce. Roads were so bad, and the chain of home trade so feeble, that there was often scarcity of grain in one part, and plenty in another part of the same kingdom. Export by sea or river to some foreign market was in many cases more easy than the carriage of corn from one market to another within the country. The frequency of local dearths, and the diversity and fluctuation of prices, were thus extreme. It was out of this general situation that the first corn laws arose, and they appear to have been wholly directed towards lowering the price of corn. Exportation was prohibited, and home merchandise in grain was in no

<sup>1</sup> It was formerly the custom, as we learn from Willughby, to carry the Cormorant hooded till its services were required, by which means it was kept quiet. At the present time its bearer wears a wire-mask to protect his eyes and face from the bird's beak.

<sup>2</sup> See Capt. Salvin's chapters on "Fishing with Cormorants," appended to his and Mr. Freeman's *Falconry* (London: 1859).

repute or toleration. As long as the rent of land, including the extensive domains of the Crown, was paid in kind, the sovereign, the barons, and other landholders had little interest in the price of corn different from that of other classes of people, the only demand for corn being for consumption, and not for re-sale or export. But as rents of land came to be paid in money, the interest of the farmer to be distinguished by a remove from that of the landowner, the difference between town and country to be developed, and the business of society to be more complex, the ruling powers of the state were likely to be actuated by other views; and hence the force which corn legislation afterwards assumed in favor of what was deemed the agricultural interest. But during four centuries after the Conquest the corn law of England simply was that export of corn was prohibited, save in years of extreme plenty under forms of state license, and that producers carried their surplus grain into the nearest market town, and sold it there for what it would bring among those who wanted it to consume; and the same rule prevailed in the principal countries of the Continent. This policy, though, as one may argue from its long continuance, probably not felt to be acutely oppressive, was of no avail in removing the evils against which it was directed. On the contrary it prolonged and aggravated them. The prohibition of export discouraged agricultural improvement, and in so much diminished the security and liberality even of domestic supply; while the intolerance of any home dealing or merchandise in corn prevented the growth of a commercial and financial interest strong enough to improve the means of transport by which the plenty of one part of the same country could have come to the aid of the scarcity in another.

Apart from this general feudal germ of legislation on corn, the history of the British corn laws, as they have come down to recent times, may be said to have begun with the statute in the reign of Henry VI., 1436, by which exportation was permitted without state license, when the price of wheat or other corn fell below certain prices. The reason given in the preamble of the statute was that the previous state of the law had compelled farmers to sell their corn at low prices, which was no doubt true, but which also showed the important turn of the tide that had then set in. McCulloch, in his elaborate article in the *Commercial Dictionary*, to which reference may be made for the most authentic details on this subject, says that the fluctuation of the prices of corn in that age was so great, and beyond all present conception, that "it is not easy to determine whether the exportation price of 6s. 8d. for wheat" [12s. 10d. in present money per quarter] "was above or below the medium price." But while the medium price of the kingdom must be held to be unascertainable in a remote time, when the medium price in any principal market town of England did not agree with that of another for any year or series of years, one may readily perceive that the cultivators of the wheat lands in the south-eastern counties of England, for example, who could frequently have sold their produce in that age to Dutch merchants to better advantage than in their own market towns, or even in London, but were prohibited to export abroad, and yet had no means of distributing their supplies at home so as to realize the highest medium price in England, must have felt aggrieved, and that their barons and knights of the shire would have a common interest in making a strong effort to rectify the injustice in Parliament. This object appears to have been in some measure accomplished by this statute, and twenty-seven years afterwards (1463) a decided step was taken towards securing to agriculturists a monopoly of the home market by a statute prohibitory of importation from abroad. Foreign import was to be permitted only at and above the point of prices where the export of domestic produce was prohibited. The landed interest had now adopted the idea of sustaining and equalizing the value of corn, and promoting their own industry and gains, which for four centuries, under various modifications of plan, and great changes of social and political condition, were to maintain a firm place in the legislation and policy of England. But there were many reasons why this idea, when carried into practice, should not have the results anticipated from it.

The import of grain from abroad, even in time of dearth and high prices at home, could not be considerable as long as the policy of neighboring countries was to prohibit export; nor could the export of native corn, even with the

English  
corn laws,  
1436-  
1602.

Dutch and other European ports open to such supplies, be effective save in limited maritime districts, as long as the internal corn trade was suppressed, not only by want of roads, but by legal interdict. The regulation of liberty of export and import by rates of price, moreover, had the same practical objection as the various sliding-scales, bounties, and other legislative expedients down to 1846, viz., that they failed, probably more in that age than in later times, to create a permanent market, and aimed only at a casual trade. When foreign supplies were needed, they were often not to be found; and when there was an excess of corn in the country a profitable outlet was both difficult and uncertain. It would appear, indeed, that during the Wars of the Roses the statutes of Henry VI. and Edward IV. had become obsolete; for a law regulating export prices in identical terms of the law of 1436 was re-enacted in the reign of Philip and Mary (1554). In the preceding reign of Edward VI., as well as in the succeeding long reign of Elizabeth, there were unceasing complaints of the decay of tillage, the dearth of corn, and the privations of the laboring classes; and these complaints were met by the same kind of measures—by statutes encouraging tillage, forbidding the enlargement of farms, imposing severe restrictions on storing and buying and selling of grain, and by renewed attempts to regulate export and import according to prices. In 1562 the price at which export might take place was raised to 10s. per quarter for wheat, and 6s. 8d. for barley and malt. This only lasted a few years, and in 1570 the export of wheat and barley was permitted from particular districts on payment of a duty of 1s. 8d. per quarter, although still liable to prohibition by the Government or local authority, while it was entirely prohibited under the old regulations from other districts. Only at the close of Elizabeth's reign (1603) did a spark of new light appear in a further statute, which removed the futile provisions in favor of tillage and against enlargement of pastoral farms, and rested the whole policy for promoting an equable supply of corn, while encouraging agriculture, on an allowed export of wheat and other grain at a duty of 2s. and 1s. 4d. when the price of wheat was not more than 20s., and of barley and malt 12s. per quarter. The import of corn appears to have been much lost sight of from the period of the statute of 1463. The internal state of England, as well as the policy of other countries of Europe, was unfavorable to any regular import of grain, though many parts of the kingdom were often suffering from dearth of corn. It is obvious that this legislation, carried over more than a century and a half, failed of its purpose, and that it neither promoted agriculture, nor increased the supply of bread. So great a variance and conflict between the intention of statutes and the actual course of affairs might be deemed inexplicable, but for an explanation which a close economic study of the circumstances of the times affords.

Besides the general reasons of the failure already indicated, there were three special causes in active operation, which, though not seen at the period, have become distinct enough since. (1.) A comparatively free export of wool had been permitted in England from time immemorial. It was subject neither to conditions of price nor to duties in the times under consideration, was easier of transport and much less liable to damage than corn, and, under the extending manufactures of France and the Low Countries, was sure of a foreign as well as a domestic market. Here was one description of rural produce on which there was the least embargo, and on which some reliance could be placed that it would in all circumstances bring a fair value; while corn, the prime rural produce, was subject as a commodity of merchandise to every difficulty, internally and externally, which meddling legislation and popular prejudice could impose. The numerous statutes enjoining tillage and discouraging pastoral farms—or in other words requiring that agriculturists should turn from what was profitable to what was unprofitable—had consequently no substantial effect, save in the many individual instances in which the effect may have been injurious. (2.) The value of the standard money of the kingdom had been undergoing great depreciation from two opposite quarters at once. The pound sterling of England was reduced in weight of pure metal from £1, 18s. 9d. in 1436, the date of the first of the corn statutes, to 4s. 7½d. in 1551, as far as can be estimated in present money, and to £1, 0s. 6½d. under the restoration of the coinage in the following year. At the same time the greater abundance of silver, which now

began to be experienced in Europe from the discovery of the South American mines, was steadily reducing the intrinsic value of the metal. Hence a general rise of prices remarked by Hume and other historians; and hence also it followed that a price of corn fixed for export or import at one period became always at another period more or less restrictive of export than had been designed. (3.) The wages of labor would have followed the advance in the prices of commodities had they been left free, but they were kept down by statute to the three or four pence per day at which they stood, when the pound sterling contained one-fourth more silver, and silver itself was much more valuable,—a refinement of cruelty, for which an excuse is hardly to be found in the prevailing ignorance of principles of political economy, great as that was. The feudal system was breaking up; a wage-earning population was rapidly increasing both in the farms and in the towns; but the spirit of feudalism remained, and the iron collar of serfdom was riveted round the necks of the laborers by these statutes many generations after they had become nominally freemen.<sup>1</sup> The result was chronic privation and discontent among the common people, by which all the conditions of agriculture and trade in corn were further straitened and barbarized; and an age, in some high respects among the most brilliant in the annals of England, was marked by an enormous increase of pauperism, and by the introduction of the merciful but wasteful remedy of the Poor Laws.

The corn legislation of Elizabeth remained without change during the reign of James, the 1660-1778. civil war, and the Commonwealth. But on the restoration of Charles II. in 1660, the question was resumed, and an Act was passed of a more prohibitory character. Export and import of corn, while nominally permitted, were alike subjected to heavy duties—the need of the Exchequer being the paramount consideration, while the agriculturists were no doubt pleased with the complete command secured to them in the home market. This Act was followed by such high prices of corn, and so little advantage to the revenue, that Parliament in 1663 reduced the duties on import to 9 per cent. *ad valorem*, while at the same time raising the price at which export ceased to 48s., and reducing the duty on export from 20s. to 5s. 4d. per quarter. In a few years this was found to be too much free-trade for the agricultural liking, and in 1670 prohibitory duties were re-imposed on import when the home price was under 53s. 4d., and a duty of 8s. between that price and 80s., with the usual make-weight in favor of home supply, that export should be prohibited when the price was 53s. 4d. and upwards. But complaints of the decline of agriculture continued to be as rife under this Act as under the others, till on the accession of William and Mary, the landed interest, taking advantage of the Revolution as they had taken advantage of the Restoration to promote their own interests, took the new and surprising step of enacting a bounty on the export of grain, which continued to infect the corn laws of the kingdom, varied, on one occasion at least, with the further complication of bounties on import, until a comparatively recent period. The duties on export being abolished, while the heavy duties on import were maintained, this is probably the most one-sided form which the British corn laws ever assumed, but it was attended with none of the advantages anticipated. The prices of corn fell, instead of rising. There had occurred at the period of the Revolution a depreciation of the money of the realm, analogous in one respect to that which marked the first era of the corn statutes (1436-1551), and forming one of the greatest difficulties which the Government of William had to encounter. The coin of the realm was greatly debased, and as rapidly as the mint sent out money of standard weight and purity, it was melted down, and disappeared from the circulation. The influx of silver from South America to Europe had spent its action on prices before the middle of the century; the precious metals had again hardened in value; and for forty years before the Revolution the price of corn had been steadily falling in money price. The

<sup>1</sup> Mr. McCulloch, to whose researches on this subject every subsequent writer must be much indebted, found from a comparison of the prices of corn and wages of labor in the reign of Henry VII. and the latter part of the reign of Elizabeth, that in the former period a laborer could earn a quarter of wheat in 20, a quarter of rye in 12, and a quarter of barley in 9 days; whereas, in the latter period, to earn a quarter of wheat required 46, a quarter of rye 32, and a quarter of barley 29 days' labor. See the article CORN LAWS in 8th edition of this work.

liberty of exporting wool had also now been cut down before the English manufactures were able to take up the home supply, and agriculturists were consequently forced to extend their tillage. When the current coin of the kingdom became wholly debased by clipping and other knaveries, there ensued both irregularity and inflation of nominal prices, and the producers and consumers of corn found themselves equally ill at ease. The farmers complained that the home-market for their produce was unremunerative and unsatisfactory; the masses of the people complained with no less reason that the money wages of labor could not purchase them the usual necessities of life. Lord Macaulay, in his *History of England*, says of this period, with little exaggeration, that "the price of the necessities of life, of shoes, of ale, of oatmeal, rose fast. The laborer found that the bit of metal which, when he received it, was called a shilling, would hardly, when he purchased a pot of beer or a loaf of rye bread, go as far as sixpence." The state of agriculture could not be prosperous under these conditions. But when the Government of William surmounted the difficulty of the coinage, as they did surmount it, under the guidance of Sir Isaac Newton, with remarkable statesmanship, it necessarily followed that prices, so far from rising, declined, because, as one reason, they were now denominated in a solid metallic value. The rise of prices of corn attending the first years of the export bounty was consequently of very brief duration. The average price of wheat in the Winchester market, which in the ten years 1690-99 was £2, 10s., fell in the ten years 1716-25 to £1, 5s. 4d., and in the ten years 1746-55 to £1, 1s. 2½d. These figures are enough to dispel much illusion as to the effect of promoting particular branches of industry by legislative and fiscal protection. The system of corn law established in the reign of William and Mary was probably the most perfect to be conceived for advancing the agricultural interest of any country. Every stroke of the legislature seemed complete to this end. Yet it wholly failed of its purpose, because no industrial interest whatever can by any artificial means prosper, save in harmonious connection with the progress of other interests. If the price of wheat again rose in 1750-60 and 1760-70 to £1, 19s. 3½d. and £2, 11s. 3½d., it was simply because many causes had meanwhile been at work, as invariably happens in such economic developments, the operation of which no statutes could embrace, either to control or to prevent. Between the reign of William and Mary and that of George III., the question of bounty on export of grain had, in the general progress of the country, fallen into the background, while that of the heavy embargoes on import had come to the front. Therefore it is that Burke's Act of 1773, as a deliberate attempt to bring the corn laws into some degree of reason and order, is worthy of special mention. This statute permitted the import of foreign wheat at a nominal duty of 6d. when the home price was 48s. per quarter, and it stopped both the liberty to export and the bounty on export together when the home price was 44s. per quarter. There was probably an error in stopping export and cutting off bounty on export at the same point of price. But apart from this passing blemish, the statute of 1773 was worthy of the genius of Burke, and it would have been well for the country to have imbibed more fully its spirit and principles.

Few questions have been more discussed or more differently interpreted than the elaborate system of corn laws dating from the reign of William and Mary. Even so careful an observer as Malthus was of opinion that the bounty on export had enlarged the area of subsistence. But a bounty on export is obviously liable to the same objection as a heavy duty on foreign import. It fails to create a natural, and therefore permanent, market for the favored produce. The foreigner is induced at the expense of the exporting state to take the commodity at less cost than it can be produced. A bounty on export consequently never adjusts itself to the real conditions either at home or abroad. That the bounty on export of corn had large operation is sufficiently attested by the fact that, in the years from 1740 to 1751, bounties were paid out of the Exchequer to the amount of £1,615,000, and in 1749 alone they amounted to £324,000. But the trade thus forced was of no permanence, and the British exports of corn, which reached a maximum of 1,667,778 quarters in 1749-50, had fallen to 600,000 quarters in 1760, and continued to decrease.

Burke's Act lasted long enough to introduce a regular im-

port of foreign grain, varying with the abundance 1791-1800. or scarcity of the home harvest, yet establishing in the end a systematic preponderance of imports over exports. The period, moreover, was marked by great agricultural improvements, by extensive reclamation of waste lands, and by an increased home produce of wheat, in the twenty years from 1773 to 1793, of nearly 2,000,000 quarters. Nor had the course of prices been unsatisfactory. The average price of British wheat in the twenty years was £2, 6s. 3d., and in only three years of the twenty was the price a fraction under £2. But the ideas in favor of greater freedom of trade, of which the Act of 1773 was an indication, and of which another memorable example was given in Pitt's Commercial Treaty with France, were overwhelmed in the extraordinary excitement caused by the French Revolution, and all the old corn law policy was destined to have a sudden revival. The landowners and farmers complained that an import of foreign grain at a nominal duty of 6d., when the price of wheat was only 48s., deprived them of the ascending scale of prices when it seemed due; and on this instigation an Act was passed in 1791, whereby the price at which importation could proceed at the nominal duty of 6d. was raised to 54s., with a duty of 2s. 6d. from 54s. to 50s., and at 50s. and under 50s. a prohibitory duty of 24s. 3d. The bounty on export was maintained by this Act, but exportation was allowed without bounty till the price reached 46s.; and the permission accorded by the statute of 1773 to import foreign corn at any price, to be re-exported duty free, was modified by a warehouse duty of 2s. 6d., in addition to the duties on import payable at the time of sale, when the corn, instead of being re-exported, happened to be sold for home consumption. The legislative vigilance in this statute to prevent foreign bread from reaching the home consumer is remarkable. There were deficient home harvests for some years after 1791, particularly in 1795 and 1797, and Parliament was forced to the new expedient of granting high bounties on importation. At this period the country was involved in a great war; all the customary commercial relations were violently disturbed; freight, insurance, and other charges on import and export were multiplied fivefold; heavier and heavier taxes were imposed; and the capital resources of the kingdom were poured with a prodigality without precedent into the war channels. The consequence was that the price of corn, as of all other commodities, rose greatly; and the Bank of England having stopped paying in specie in 1797, this raised nominal prices still more under the liberal use of bank paper in loans and discounts, and the difference that began to be established in the actual value of Bank of England notes and their legal par in bullion.

The average price of British wheat rose to £5, 19s. 6d. in 1801. So unusual a value must have led to a large extension of the area under wheat, and to much corn-growing on land that after great outlay was ill prepared for it. In the following years there were agricultural complaints; and in 1804, though in 1803 the average price of wheat had been as high as £2, 18s. 10d., an Act was passed, so much more severe than any previous statute, that its object would appear to have been to keep the price of corn somewhere approaching the high range of 1801. A prohibitory duty of 24s. 3d. was imposed on the import of foreign wheat when the home price was 63s. or less; and the price at which the bounty was paid on export was lowered to 40s., while the price at which export might proceed without bounty was raised to 54s. Judging from the prices that ruled during the remaining period of the French wars, this statute would appear to have been effective for its end, though, under all the varied action of the times on a rise of prices, it would be difficult to assign its proper place in the general effect. The average price of wheat rose to £4, 9s. 9d. in 1805, and the bank paper price in 1812 was as high even as £6, 6s. 6d. The bullion prices from 1809 to 1813 ranged from 86s. 6d. to 100s. 3d. But it was foreseen that when the wars ended a serious reaction would ensue, and that the rents of land, and the general condition of agriculture, under the warlike, protective, and monetary stimulation they had received, would be imperilled. In the brief peace of 1814 the average bullion price of British wheat fell to 55s. 8d. All the means of select committees of inquiry on agricultural distress, and new modifications of the corn laws, were again brought into requisition. The first idea broached in Parliament was to raise the duties on foreign imports, as well as the prices at which they were to

be leviable, and to abolish the bounty on export, while permitting freedom of export whatever the home price might be. The latter part of the scheme was passed into law in the session of 1814; but the irritation of the manufacturing districts against the new scale of import duties was too great to be resisted. In the subsequent session an Act was passed, after much opposition, fixing 80s. (14s. more than during the wars) as the price at which import of wheat was to become free of duty.

This Act of 1815 was intended to keep the price of wheat in the British markets at about 80s. per quarter; but the era of war and great expenditure of money raised by public loans had ended, the ports of the Continent were again open to some measure of trade and to the equalizing effect of trade upon prices, the Bank of England and other banks of issue had to begin the uphill course of a resumption of specie payments, the nation had to begin to feel the whole naked weight of the war debt, and the idea of the protectors of a high price of corn was proved by the event to be an utter hallucination. The corn statutes of the next twenty years, though occupying an enormous amount of time and attention in the Houses of Parliament, may be briefly treated, for they are simply a record of the impotence of legislation to maintain the price of a commodity at a high point when all the natural economic causes in operation are opposed to it. In 1822 a statute was passed reducing the limit of prices at which importation could proceed to 70s. for wheat, 35s. for barley, 25s. for oats; but behind this apparent relaxation was a new scale of import duties, by which foreign grain was subject to heavy three-month duties up to a price of 85s.—17s. when wheat was 70s., 12s. when between 70s. and 80s., and 10s. when 85s., showing the grasping spirit of the would-be monopolizers of the home supply of corn, and their reluctance to believe in a lower range of value for corn as for all other commodities. This Act never operated, for the reason that with the exception in some few instances of barley, prices never were so high as its projectors had contemplated. The corn trade had passed rapidly beyond reach of the statutes by which it was to be so painfully controlled; and as there were occasional seasons of scarcity, particularly in oats, the king in council was authorized for several years to override the statutes, and do whatever the public interests might require.

In 1827, Canning introduced a new system of duties, under which there would have been a fixed duty of 1s. per quarter when the price of wheat was at or above 70s., and an increased duty of 2s. for every shilling the price fell below 69s.; but though Canning's resolutions were adopted by a large majority in the House of Commons, his death and the consequent change of ministers involved the failure of his scheme of corn duties. In the following year Mr. Charles Grant introduced another scale of import duties on corn, by which the duty was to be 23s. when the price was 64s., 16s. 8d. when the price was 69s., and only 1s. when the price was 73s. or above 73s. per quarter; and this became law the same year. This sliding scale was more objectionable, as a basis of foreign corn trade, than that of Canning, though not following so closely shilling by shilling the variation of prices, because of the abrupt leaps it made in the amount of duties leviable. For example, a merchant who ordered a shipment of foreign wheat when the home price was 70s. and rising to 73s., instead of having a duty of 1s. to pay, should on a backward drop of the home price to 69s. have 16s. 8d. of duty to pay. The result was to introduce wide and incalculable elements of speculation into all transactions in foreign corn. The prices during most part of this period were under the range at which import was practically prohibited. The average price of British wheat was 96s. 11d. in 1817, but from that point there was in succeeding years a rapid and progressive decline, varied only by the results of the domestic harvests, till in 1835 the average price of wheat was 39s. 4d., of barley 29s. 11d., and oats 22s. The import of foreign grain in these years consisted principally of a speculative trade, under a privilege of warehousing accorded in the statute of 1773, and extended in subsequent Acts, by which the grain might be sold for home consumption on payment of the duties, or re-exported free, as suited the interest of the holders.

The Act of 1822 admitted corn of the British possessions in North America under a favored scale of duties, and in 1825 a temporary Act was passed, allowing the import of

wheat from these provinces at a fixed duty of 5s. per quarter, irrespective of the home price, which, if maintained, would have given some stability to the trade with Canada. The idea of a fixed duty on all foreign grain, however, appears to have grown in favor from about this period. It was included in the programme of import duty reforms of the Whig Government in 1841, and fell with its propounders in the general election of that year. Sir Robert Peel, on succeeding to office, and commencing his remarkable career as a free-trade statesman, introduced and carried in 1842 a new sliding scale of duties somewhat better adjusted to the current values. But public opinion by this time had penetrated the imprudence of the whole system; and the prime minister, convinced, as he confessed, by the arguments of Cobden and the Anti-Corn Law League, and stimulated into action by the failure of the potato crop in Ireland, put an effectual end to the history of the corn laws by the famous Act 9 and 10 Vict. c. 22. It was provided under this measure that the maximum duty on foreign wheat was to be immediately reduced to 10s. per quarter when the price was under 48s., to 5s. on barley when the price was under 26s., and to 4s. on oats when the price was under 18s., with lower duties as prices rose above these figures; but the conclusive part of the enactment was that in three years—on 1st of February, 1849—these duties were to cease, and all foreign corn to be admitted at a duty of 1s. per quarter, and all foreign meal and flour at a duty of 4½d. per cwt.—the same nominal imposts which were conceded to grain and flour of British possessions abroad from the date of the Act. Moreover, in 1860, even these nominal duties were abolished in a Customs Duties Act, and since that time corn and other provisions have been admitted into the United Kingdom free of all fiscal charge.

As has been remarked above more than once the distribution of corn supplies in the kingdom was much impeded by laws directed against all dealing in corn as an article of ordinary merchandise, apart from questions of foreign import or export. The theory was that when corn was plentiful in any district it should be consumed at what it would bring, without much respect to whether the next harvest might be equally abundant, or to what the immediate wants of an adjoining province of the same country might be. The first statute on the subject appears to have been passed in the reign of Edward VI., though the general policy had prevailed before that time both in popular prejudice and in the feudal custom; and by this statute any one who bought corn to sell it again was made liable to two months' imprisonment with forfeit of the corn. A second offence was punished by six months' imprisonment and forfeit of double the value of the corn, and the third by the pillory, and utter ruin. Severe as this statute was, liberty was given by it to transport corn from one part of the country under license to men of approved probity, which implied that there was to be some buying of corn to sell it again and elsewhere. Practically, "engrossing" came to be considered buying wholesale to sell again wholesale. "Fore-stalling" was different, and the statutes were directed against a class of dealers who went forward and bought or contracted for corn and other provisions, and spread false rumors in derogation of the public and open markets appointed by law, to which our ancestors appear to have attached much importance, and probably in these times not without reason. The statute of Edward VI. was modified by many subsequent enactments, particularly by the statute of 1663, by which it was declared that there could be no "engrossing of corn when the price did not exceed 48s. per quarter," and which Adam Smith recognized, though it adhered to the variable and unsatisfactory element of price, as having contributed more to the progress of agriculture than any previous law in the statute book. In 1773 these injurious statutes were abolished, but the penal character of "engrossing" and "forestalling" had a root in the common law of England, as well as in the popular prejudice, which kept the evil alive to a later period. As the public enlightenment increased the judges were at no loss to give interpretations of the common law consistent with public policy. Subsequent to the Act of 1773, for example, one Waddington was convicted and punished for engrossing hops; but though this was deemed a sound and proper judgment at the time, yet it was soon afterwards overthrown in other cases, on the ground that buying wholesale to sell wholesale was not in "restraint of trade" as the former

Engrossing  
and fore-  
stalling.

judges had assumed. Popular antipathy to corn-dealers and corn-dealing survived to still more recent times; but meal riots, and violent interference with the storing or movement of grain, may be said to have wholly disappeared from the United Kingdom since the repeal of the corn laws of 1846.

**Foreign corn laws.** Freedom of export of corn from customs duties has become the general rule of nearly all foreign countries. The opening of so great a market as the United Kingdom for corn free of import duty, from every quarter alike, was calculated in itself to have considerable influence in dispelling the ancient prejudice against a free export of grain. It is somewhat curious to remark that Spain, which has not been forward in adopting modern ideas of trade, saw the advantage to her various splendid wheat-producing provinces of freedom of export of wheat as early as 1820, and three years afterwards extended this freedom to all "fruits of the soil" in Spain, which has since remained the policy of the country. But heavy duties on the import of cereal produce continue to be levied there, and must fall with very different effects on various parts of a kingdom in which the physical difficulties of interior transport are so great, and so little has hitherto been done to overcome them. Rice imported into any part of Spain is subject to a duty of 75s. per ton, wheat to 25s., dry pulse to 25s., oats to 21s. 8d., and barley, rye, and maize to 18s. 9d. per ton. The cereal produce of Portugal is exported free of duty, but on the import of wheat and flour by sea, there are duties at the rate of 6 rees per kilo on wheat and 8 rees on flour; inland, or through "dry ports," the duty is 2 rees on wheat and 4 rees on flour. Export and import of grain in France were prohibited down to the period of the repeal of the British corn laws, save when prices were below certain limits in the one case and above certain other limits in the other. But export of grain and flour from France has for many years been free of duty. On the import of grain and flour, on the other hand, France not only levies duties, but makes a distinction between countries within and beyond Europe. The duty on grain imported into France from countries outside of Europe is 60 centimes, and on flour 1*l.* 20*c.*, per 100 kilos, and from countries in Europe on grain 3*l.* 60*c.*, and on flour 4*l.* 20*c.*, per 100 kilos. These duties on import have accompanying drawbacks on export when the grain has been converted into flour, or the flour into biscuits. In Belgium the export and import of grain are alike free of duty, and, as far as we have ascertained, this remark applies also to flour and other manufactures of grain. The policy of the Netherlands, which was formerly favorable to import and export of grain from the advantages possessed by Rotterdam and Amsterdam as international entrepôts, has undergone some change in recent times. For some years prior to 1845 there was a moderate sliding scale of import duties on grain in Holland, and this gave place, on the ravages of the potato disease which fell on many parts of that country with only less severity than in Ireland, to a low fixed duty which proved satisfactory in its operation. At the present time the import duties on grain, beans, pulse, &c., are 1*½* 50 guilders (2*s.* 6*d.*) per hectolitre, or 2*½* Winchester bushels, and on bread, biscuit, flour, 40*c.* (8*d.*) per 100 lbs; these exhibit, more especially in the case of raw grain, a considerable increase on the duties which were deemed sufficient and expedient about the period of the repeal of the English corn laws. In Italy there are no duties on the export of grain, which, though extremely irregular in one season as compared with another, shows a remarkable progressive increase within the last fifteen years. Flour does not figure largely in the list of Italian exports, and for this there may be some reason in the peculiar tax which the Italian Government levies on the milling of all grain, whether of domestic or foreign produce, and which can hardly be compensated even by drawbacks on export as long as the domestic industry of flour-making is cramped by a severe excise. This is the more worthy of being remarked, because the commerce of Italy includes a great portion of the very best qualities of wheat from the Black Sea; and in her flour, and macaroni, and vermicelli preparations, so highly prized in her domestic consumption, she has a basis of what might become a considerable foreign trade. The duties on import of

grain and flour in Italy are not high—75*c.* on wheat and other grain per 100 kilos, and 1*½* 25*c.* on flour and 75*c.* on bran for the same quantity. The franc and centime being received in the Italian custom-houses in the paper-money of the country, is of lower value than the franc and centime in France, though of the same denomination in metallic coinage. From Austria and Austria-Hungary the export of grain is also free of duty; and in the internal corn trade of the Austrian empire, important measures of improvement now pending are likely to be accomplished.

The great countries, famous for a production of raw materials much beyond their own means of consumption, are favorable, of course, to the utmost freedom of export. The empire of China itself was never unwilling to sell to foreigners tea, for which there was no domestic use. The United States promote transit and export of corn, internally and externally, with all the intelligence and resources of a civilized people. If the shareholders in railways and canals and steamboat lines in the United States were consulted, they would probably say that this policy of freedom of export had been promoted beyond due bounds of equity. But on the other hand, the protective and prohibitive tariff of the United States on necessary supplies to agriculturists must be held to be equivalent to an embargo on the export of American corn, as well as cotton, tobacco, and other raw products of the soil. The same remark applies to Russia, which, while expediting her export of raw produce with help of borrowed capital, as much as possible, maintains a high tariff against foreign commodities, and lays the foundation even of her conquests in the interior of Asia, by decreeing that nothing shall be sold within her territories but what is of Russian manufacture or Russian merchandise.

The facility with which the soundest views of the efficacy of freedom of trade in corn, as a permanent policy, may be called in question under circumstances of extremity, was shown in the course of the recent famine in Bengal. A cry arose in India for a prohibition of the export of rice, and was supported by some of the most enlightened organs of public opinion at home. The governor-general, Lord Northbrook, who had taken a different view of the situation, was subjected to severe rebuke; but the more the reasons were examined the more clear it became that the wisdom was on his part and the imprudence on the other. Mauritius, for example, almost wholly tilled not only by subjects of Great Britain but by natives of India, would have been reduced by prohibition of export to almost as great starvation as the poor people in the districts where the harvest had failed. The rice of India, moreover, exported to Europe, was of a quality seldom or never used by the common people of India, and its arrest could have been of the slightest possible utility in relieving the famished districts. Besides the whole internal trade and movement of rice in India had to be taken into consideration. There was extreme scarcity in several provinces of Bengal, but there was the usual abundance in many other parts of India. A decree prohibiting export would have stopped the customary movement of rice in Hindustan, diminished the supplies in all the central markets, and both aggravated the calamity and put difficulties in the way of its being overcome. The sound policy was to allow scope to all effective demand for rice in India according to the ordinary course of trade, and as there were some tens of thousands of people in a certain quarter of India who had no effective demand to offer, to bring the help of the Government to their relief. This was the policy pursued, and the result was that the famine in Bengal was relieved, as no famine in India had been before, with the least avoidable disturbance of the markets on which India is dependent for the sale of her surplus produce. (p. 80.)

**CORN TRADE.** The effect of the opening of the ports of the United Kingdom freely to the agricultural produce of all parts of the world has been to extend the foreign trade in corn, both more rapidly in point of time and more largely in measure than could have been pre-conceived. This result was promoted by the more liberal policy which began at the same time to be generally adopted with respect to the export and import of grain, and by the active efforts of the great corn-producing countries not only to extend their cultivation but to increase the facilities of

transport both inland and seawards. The consequence is that a commodity which, though of the first necessity, had long been the most difficult to move under the prevailing laws and conditions of trade, has become one of the principal articles of commerce. It is carried as far as any other article of merchandise, and yet is greater in bulk and in difficulty of transport than any other principal commodity with which it may be compared in value. It may be said, indeed, that if the immense imports of foreign grain into the United Kingdom, during the last thirty years, could have been foreseen when the British corn laws were repealed, the most ardent believer in the creative and compensatory resources of free trade could scarcely have reconciled the figures with anything short of an overwhelming decline of British agriculture. Yet the home production and trade of corn have not less ground during this period, while agricultural improvement has made more progress, and the total value of the products of the soil been more signally increased than in any previous thirty years that could be named. We propose in this notice to show the progress of the foreign trade in corn, and the changes in the principal sources of foreign supply since 1846, as well as the effect of this unlimited competition on British agriculture and on the home trade in corn, and then to add some information as to the relation of home and foreign supply, expenses of transport, and other incidents of the trade in various principal centres.

*Quantities and Sources of Foreign Supply of Corn in 1841-45 and 1871-75.*—The following are the average annual quantities of corn and flour imported into the United Kingdom in the five years preceding 1846, by the various countries which were then importers:—

	Wheat.	Barley.	Oats.	Wheat Meal and Flour.
	Qrs.	Qrs.	Qrs.	Cwts.
<b>NORTHERN EUROPE.</b>				
Russia.....	145,601	7,188	99,660	13
Sweden.....	3,423	13,410	52,259	—
Norway.....	2	252	847	302
Denmark.....	95,435	298,191	54,450	949
Prussia.....	634,124	120,877	45,879	2581
Germany.....	108,449	63,306	68,195	2809
Holland.....	14,784	1,448	42,339	101
Belgium.....	2,145	1,287	1,529	3
<b>SOUTHERN EUROPE.</b>				
France.....	110,636	19,060	3,575	35,523
Portugal.....	1,049	111	—	75
Spain.....	24,018	1,455	—	28
Italy.....	199,445	488	117	870
<b>MEDITERRANEAN.</b>				
Malta.....	25,782	4,716	—	1
Morea and Greek Islands.....	2,999	—	—	—
Turkey.....	8,958	4,968	1	—
Egypt.....	15,867	1,276	—	—
Palestine.....	196	—	—	—
Tunis.....	—	120	—	—
<b>TRANSATLANTIC.</b>				
British N. America.....	27,342	2,555	8,183	437,920
United States.....	23,105	—	1,062	202,134
Peru and Chili.....	3,705	—	—	—
River Plate.....	568	—	—	509
<b>OTHER COUNTRIES.</b>				
Australia.....	8,656	—	—	97
East Indies.....	1,211	3	1	10,405
Channel Islands.....	1,905	1,118	185	386
Cape of Good Hope.....	51	—	—	3
Average annual imp't.	1,544,467	451,849	373,191	694,899
Average annual duty-paid home consumption.....	1,298,776	440,958	333,678	571,997

The most cursory observation of these figures will disclose results surprising to the present generation. It is to be remarked, for example, that down to 1846 Prussia and other countries of Germany supplied more than one-half the whole import of wheat into the United Kingdom, that the little country of Denmark had greatly more traffic in export of grain to British ports than the whole Russian

1 Compiled from the parliamentary returns of "Revenue, Population, and Commerce," Sessions 1843-47.

empire, and that the transatlantic trade in wheat and flour or other corn with the United Kingdom, apart from Canada, had barely begun to exist. Nor can it fail to be noticed how widespread the commerce in corn had become even in these circumstances, and that it was usual to send cargoes of wheat and flour to England from places so distant as Chili and La Plata, and Australia and the East Indies.

The statistics of the corn trade have become much more voluminous since 1846, and it is necessary to give some distinction to wheat and wheat flour, and the sources of their supply. It has also followed from the great trade in foreign grain that the measure should be weight, and not quantity in local bushels or quarters. The Board of Trade for many years has thus given its returns of wheat and other raw grain, as well as meal and flour, in cwts. The cwt. would be equal to two bushels of 56 lb, but the weight of a bushel being usually 61 lb, the quarter (or eight bushels) is 448 lb. The following are the average annual quantities of corn and flour imported into the United Kingdom in the five years 1871-75:—

	Wheat. Cwts.	Wheat Meal and Flour. Cwts.
Russia.....	11,755,591	—
Denmark.....	304,838	—
Germany (Prussia included).....	3,552,050	851,476
France.....	1,149,119	1,691,924
Austrian Territories.....	68,997	—
Turkey and Roumania.....	918,452	—
Egypt.....	1,373,947	—
United States.....	17,653,329	1,236,599
Canada.....	3,235,551	387,238
Chili.....	1,273,399	—
Other Countries.....	2,397,787	1,105,425
Average annual import.....	43,683,069	5,872,661
Average annual re-export.....	490,656	166,579

*Other Grain from all Countries.*

	Barley.	Oats.	Pease.	Beans.	Indian Corn or Maize.
Cwts.....	11,067,067	11,667,679	1,387,021	2,943,249	19,653,428

The import of foreign wheat and flour into the United Kingdom has increased more than sevenfold, and of all foreign grain nearly tenfold, in the thirty years of free trade. The United States, from a small and unsteady commerce in grain, have risen to the first place, not only in wheat and flour, but in Indian corn, of which they contribute two-thirds of the supply. Russia stands second on the list, the great bulk of her export of wheat being now received from the southern ports of the empire. Canada, while scarcely sustaining its former supply of flour, has increased its average annual export of wheat to the United Kingdom from 110,000 cwts. to 3,230,000 cwts. The trade in corn has not only been extended over vast territories in various quarters of the world which thirty years ago were comparatively uncultivated or absolute deserts, but no former exporting country appears to have lost ground. All have shared more or less in the general progress, though a decline in wheat is perceptible from Denmark and other countries on the northern verge of the wheat region, which now require more for home consumption. The increased import of barley, which is not so great as that of wheat, but still remarkable, comes chiefly from Northern Europe and France. It will be observed, from the figures denoting the ratio in which foreign supplies were taken up in the home consumption and the overplus sent to other markets in the two quinquennial periods above compared, that the re-export of foreign grain and flour from the United Kingdom has not increased with the magnitude of the supplies, but on the contrary has much diminished. This result can only be attributed to the organization of the trade, and the intelligence with which this vast movement of grain is directed.

*Effect of Foreign Competition on British Agriculture and Corn-Production.*—The acreage of the various crops, and the numbers of live stock in the United Kingdom, are now given with all desirable accuracy in the annual agricultural returns, for which the country is indebted to a motion in the House of Commons in 1862 by Mr. Caird.<sup>2</sup>

<sup>2</sup> Mr. Caird, afterwards M. P. for Stirling, a landowner and practical agriculturist, travelled through Ireland on a tour of inquiry in the year immediately subsequent to the great failure of the potato

Previous to the adoption of free trade in corn, this information was a subject, not of official inquiry from farm to farm, but of general estimate, which could not but err considerably. There is thus a difficulty in tracing the exact effect of a free and increasing import of foreign grain on the domestic tillage; but the difficulty is not so great as might be supposed, nor is it of much importance in view of the authentic data available during the greater part of the period in question. M'Culloch, in his article on the Corn Trade, in the eighth edition of this work, estimated the acreage under wheat in England in 1852-53 at 3,000,000 acres, in Scotland 350,000 and in Ireland 400,000 acres—or 3,750,000 acres for the three kingdoms. The agricultural returns for 1867 gave 3,640,000 as the total wheat acreage of the United Kingdom. M'Culloch's estimate of the extent under barley in England, viz., 1,000,000 acres, was probably wider of the mark than his estimate of the area of wheat crops. The agricultural returns for 1867 at least gave 2,000,000 acres of barley in England; it must be remembered, however, that in the intervening years British barley had been in increasing demand for malting, and had been commanding higher prices relatively to the prices of wheat. There is a medium authority, between M'Culloch's estimate and the undisputed agricultural returns, in the estimates of Mr. Caird, who had peculiar advantages of ascertaining the acreage under every condition of crop in England as early as 1850. The result of his estimate of the agricultural arrangement in England and the ascertained facts in the returns of 1867 was that, in the interval, there had been a diminution in wheat of 280,000 acres, in oats 450,000, in beans and pease 320,000, and in bare fallow 247,000—in all, under these heads, a diminution of 1,297,000 acres; but, on the other hand, an increase of barley 500,000 acres, of root crops 300,000, and of clover 20,000—in all an increase of 820,000 acres, leaving a net diminution under tillage of 477,000 acres, which may be supposed to have gone into permanent pasture. In Scotland and Ireland the effects on the area of tillage were more marked than in England. The production of wheat fell off in these countries about one-half. The loss in production of wheat in Scotland appears to have been recovered by a nearly equal increase in barley and oats; but in Ireland, besides the decrease in wheat, there was a decline of about one-sixth both in barley and oats. The returns conducted by the registrar-general of Ireland since 1848 show that the estimated yield of corn of all kinds fell from 11,500,000 quarters in 1857 to 8,800,000 quarters in 1866, and of potatoes from 3,500,000 to 3,000,000 tons in these ten years. But in the same period there was a great increase of live stock—120,000 head of cattle, 1,000,000 of sheep, and 278,000 swine. The growth of flax and of various green crops had also been extended; and the number of population depending upon agriculture had been diminished by a constant emigration to England and Scotland and abroad. There can be no doubt that the greatest change under free trade in corn fell upon the agriculture of Ireland; but there is no reason to believe that the total value of the produce of the soil in Ireland lost ground, while it is certain that in the later development it has greatly increased. The annual produce of land is shown in one of Mr. Caird's tables to be £52, 17s. in Ireland, £60, 12s. in England, and £66, 15s. in Scotland, per head of all persons owning, farming, or assisting in the cultivation of farms.

The diminution of tillage in the United Kingdom under unlimited competition with foreign corn is so small as, when closely examined, to become almost imperceptible. For it must be borne in mind that the extension of large towns in these thirty years has occupied in building area alone what would form a considerable county, and has been spreading market gardens over always increasing spaces of what was formerly agricultural land. What has happened is that the poorer class of lands, from which crops of wheat and other corn were systematically taken, have been turned partially into pasture, and in still larger proportion into a more various and profitable culture both of white and green crops, barley in some instances having the preference over crops, and in 1850-51 visited nearly every county in England as the commissioner of the *Times*. He has since pursued the same course of investigation with practised powers of judgment, which have been well verified in the actual results of the corn trade in the United Kingdom. Mr. Caird, at the request of the Statistical Society of London, prepared a paper on "Our Daily Food," which was published; and he contributed a second paper on the same subject, which appeared in the *Journal of the Statistical Society*, March, 1869. Both of these papers contain valuable information.

wheat, and bare fallow in others being economized in favor of the general productive interests of the farms. Nor have the British farmers hesitated to extend greatly their wheat area from time to time, when the state of supply and the rate of prices gave a necessary stimulus. After deficient harvests and higher prices, the acreage under wheat was increased from 3,640,000 in 1867 to 3,951,000 in 1868, the harvest of which latter year was so bountiful that, what with the increased acreage, the larger average crop, and the greater weight per bushel of the finer grain, the total produce of wheat was 16,436,000 quarters of 488 lb as compared with 9,380,000 quarters in 1867. The increase of one harvest, indeed, was equal to one-third of the total annual consumption of home and foreign wheat. The average price, which in May of that year, when it reached its maximum, was 73s. 8d., had fallen in December to 50s. 1d. The acres under wheat in Great Britain have fallen from 3,630,300 in 1874 to 2,994,958 in 1876, but the acres under barley have increased in the same period from 2,287,987 to 2,533,106, and under oats from 2,596,384 to 2,789,583.

If the price of corn under free trade be considered, it will be seen, indeed, how little reason there could be for any material displacement of the domestic production; for though there has been a small decline of the price of wheat, it has been more than met by the increase of the price of barley and oats, to the surprise of those alarmists who forget that corn can nowhere be produced without much cost, that nowhere is the average produce per acre so great as in England and Scotland, and that to its cost of production in the most fertile or distant regions there have to be added freight and other charges, besides the ordinary rate of mercantile profit. This is clearly shown by a comparison of the septennial average prices of grains, returned in the *Gazette* by the tithe commissioners. In the seven years ending Christmas 1846, the prices per imperial bushel were—

Wheat.	Barley.	Oats.	
7s. 0½d.	4s.	2s. 8½d.	... 13s. 9d.

The average *Gazette* prices per imperial bushel in the seven years ending 1875 were—

Wheat.	Barley.	Oats.	
6s. 6½d.	4s. 10d.	3s. 2½d.	... 14s. 7½d.

When the various elements of agricultural improvement are taken into account—amelioration of the soil by drainage and manure, better methods, improved implements, and not least (since this has involved but little capital outlay) the greater economy, speed, and safety with which harvests are gathered, as well as sent to market—the production of wheat in England must be held to be as profitable now as it ever was, though the greater consumption and the rise in the price of barley have made that grain a more remunerative crop than wheat on soils suited to the production of fine quality.

This would not in itself account, however, for what all are cognizant of, viz., a great increase of agricultural prosperity since 1846; and the truth is that the free trade policy, and the general movement with which it was associated, opened an extraordinary demand for other farm produce than corn, of which our agriculturists were not slow to avail themselves. The estimate of live stock in the United Kingdom, antecedent to 1846, did not approach the accuracy to which M'Culloch, by his careful analysis, had reduced the estimate of acreage under corn and its produce. Conjectural enumerations of the various kinds of live stock were current which, on the first agricultural census, were found to have been almost double what could possibly have existed. The agricultural returns will reduce all uncertainty of this kind to a minimum in future. But there has been no uncertainty as to the increasing value of live stock and its produce on farms, or as to the remarkable degree in which this appreciation has tended to modify and enrich the agricultural system of the kingdom during the whole period of free trade. The price of meat, of dairy produce, and of wool, as well as other minor articles in the same category, has increased at least 50 per cent.; nor has there been any sign of abatement in this rise of value, notwithstanding increasing imports of foreign live animals, and of preserved and more or less manufactured produce of foreign live stock. Mr. Caird in 1868 estimated the annual value of home produce of corn consumed at £84,700,000; of the foreign supply of corn consumed at £25,000,000; of home beef and mutton,



£47,200,000, of foreign supply, £6,500,000; of home butter and cheese, £30,100,000; of foreign supply, £8,400,000. And this does not include wool (£8,000,000), green crop not used on farms, and various other considerable articles of domestic farm produce, which have, and always must have, a great superiority in English markets.

*Relation of Home and Foreign Supply.*—Since the home produce of corn stands in the general proportion to foreign supply of 84 to 25, the yield of the domestic harvests continues mainly to regulate price, and in consequence also the amount of import for home consumption. One or two successive inferior harvests in the United Kingdom are accompanied with a rise of price, amounting in extreme cases to 20s. or 25s. per quarter of wheat. These higher prices bring out more extensively the surplus produce of other countries than lower prices would do; but with fairly abundant domestic harvests, and the resulting lower range of prices, the import from abroad does not abruptly cease, but continues fully equal to the supply of the domestic consumption, on an equilibrium of value, which appears to have satisfied on the whole both domestic and foreign producers. According to all the authorities on the subject, the consumption of bread in the United Kingdom does not vary much from one year to another, and certainly does not vary in the ratio of the price of bread. The difference, however, between a 6d. and 9d. quarter loaf is so considerable that it must have some effect in the household economy. In 1868, when the price of bread was at the highest, the average annual consumption of 20,800,000 quarters of wheat in the previous six years fell to 19,780,000 quarters, which is about equal to a fall of 1 per cent. of consumption for ten per cent. rise in price. It is difficult to give any mercantile problems of such magnitude a definite solution, but the necessary consumption of corn in the United Kingdom, under all variations of prices, rests on a solid basis; and given the number of acres under crop, and the average produce per acre in weight, it would not be impossible to determine the amount of corn for which there would be an effective demand in the United Kingdom in any year within calculable ranges of value. The trade has been solving these questions in its own practical way. Many vessels laden with corn, from transatlantic and other distant countries to England, are stopped at Cork or Falmouth for orders from the consignees in England as to what port in Western Europe they shall discharge at. It is necessary to read the markets to the latest points of time; and imports are made into the United Kingdom for re-export as well as home consumption. The great markets for import of corn in Western Europe exhibit little variation owing to the convenience with which supplies may be sent from one port to another; but even in this limited though densely peopled sphere there are elements of disturbance in supply and demand which have to be taken into account. France, for example, has probably the largest wheat area, in proportion to population, of any European country, and yet the average produce of wheat per acre in France is so low—15½ bushels—that a bad harvest makes France a large importer, and an abundant harvest a large exporter, of wheat and flour. An increase of 1 bushel per acre in France is equal to 2,000,000 quarters. Were the average produce of wheat, by any better system of culture, to be increased in France from 15 to 18 bushels—a not immoderate attainment—she would be able alone to supply all the requirements, so far as they have been developed, of the United Kingdom.<sup>1</sup> This surprising effect of the difference of a bushel or two per acre in the average yield of any harvest applies equally to all the large exporting countries, such as Russia or the United States. The latter country was even an importer of wheat from England so late as 1859, but the great extension of agriculture in the

Western States and in California, and the extending practice in the Southern States of raising corn as well as cotton, may be believed to have placed a similar abnormal occurrence at a great distance.

The question naturally arises, How, from such widespread sources and under such immense effects of good or bad harvests in increasing or diminishing supply, the trade is so adjusted as to produce any equable degree of value and steady production of grain? Of this apparent difficulty there are two explanations—first, the regions favorable to the culture of wheat in both hemispheres are so extensive that it seldom, or rather never, occurs that there is a general abundance or general failure of harvests. Nature distributes this inequality so variously that the more the commerce in corn is extended, the less is abundance or scarcity of harvest felt in any one part of the world. And secondly, the large corn-exporting countries, though they may have no market so extensive as the United Kingdom for their surplus produce, have many other markets, not only in Western Europe, but within their own more immediate spheres—the ports of the Black Sea, for example, having the countries of the Mediterranean to supply, and the United States not only the inequalities of production within its own vast area, but parts of Canada, the West Indies, Mexico, and South America.

*Cost of Transport.*—Harbor-dues, freight, and insurance form an important element in the transport of grain. Their amount affects directly the price accruing to the producers, while at the same time they require careful calculation on the part of the merchants or shippers. Where large crops have to be moved, many vessels have to be chartered beforehand, and if the rates fixed in the charters be lower or higher than what turn out to be available rates of freight in the ports, the charterers will experience an advantage or disadvantage in the price of the grain, and the sellers of corn *vice versa*. This difficulty is chiefly felt in the more distant voyages. From Antwerp, for example, the average expense of carrying corn to England is about 1s. to 1s. 6d. per quarter. From Spain, in addition to a difficult inland carriage, the average freight to England is about 4s. per quarter. In the United States, where corn is carried hundreds of miles by railways and canals, and over 3000 miles of sea, the cost of transport bears a large proportion to the price at which the farmers can afford to sell or the merchants to buy—the latter being always ruled by the price to be realized in the great centres where corn, alike of near and distant production, finds a common level of value. At San Francisco, though the question of transport is almost wholly maritime, there is annually much speculation, turning chiefly on rates of freight. The harvests of California and Oregon yield a surplus produce of from 700,000 to 800,000 tons. An immense shipping is thus required at San Francisco every autumn and winter, and the rates of freight to Europe vary as much as from £2, 15s. to £3, 10s. per ton. (R. 80.)

CORNARO, LUIGI (1467–1566), a Venetian nobleman, famous for his treatise on a temperate life. From some dishonesty on the part of his relatives he was deprived of his rank, and induced to retire to Padua, where he acquired the experience in regard to food and regimen which he has detailed in his works. In his youth he lived freely, but after a severe illness at the age of forty, he began under medical advice gradually to reduce his diet. For some time he restricted himself to a daily allowance of 12 oz. of solid food and 14 oz. of wine; later in life he reduced still further his bill of fare, and found he could support his life and strength with no more solid meat than an egg a day. So much habituated did he become to this simple diet, that when he was above seventy years of age the addition by way of experiment of two ounces a day had nearly proved fatal. At the age of eighty-three he wrote his treatise on *The Sure and Certain Method of Attaining a Long and Healthful Life*; and this was followed by three others on the same subject, composed at the ages of eighty-six, ninety-one, and ninety-five respectively. They are written, says Addison (*Spectator*, No. 195), "with such a spirit of cheerfulness, religion, and good sense, as are the natural concomitants of temperance and sobriety." He died at the age of ninety-eight. His case is an evidence that those who have suffered the results of sensual excesses may, not only with safety, but with advantage, adopt the opposite extreme of ascetic abstinence; but it does not show that persons with unimpaired constitutions, living regular lives,

<sup>1</sup> M. de Lavergne, whose valuable work on the *Rural Economy of Great Britain and Ireland* is well known, has given the following explanation: In a letter to Mr. Cahd, of the state of wheat culture in France: "The official returns give a mean yield of 14½ hectolitres per hectare, the actual yield being more above than below the estimate. Eight departments—Le Nord, Oise, Aisne, Somme, Seine-et-Oise, Seine-et-Marne, Seine, and Eure-et-Loire—have a yield equal to the English average; but the forty-five departments which form the southern part of the territory do not yield more than 10 hectolitres to the hectare. This feeble yield is caused in many of the departments by bad cultivation, and in the south by the dryness of the climate in spring. The statistical returns also show 5,148,000 hectares of fallow (say 12,000,000 acres), which is in fact the third of the surface, sown with cereals." The proportion of bare fallow in England is greatly less, and has been undergoing reduction.

would be the better for it. A proof of this is the rarity with which his system has been persisted in, compared with the frequency with which his books have been read.

The first three treatises were published during his life (Padua, 1558), and all four have since been frequently reprinted in the original and other languages. An English translation of the *Sure Method* has gone through more than thirty editions.

CORNEILLE, PIERRE (1606-1684), was born at Rouen, in the Rue de la Pie, on the 6th of June, 1606. The house, which was long preserved, was destroyed a few years ago.

**Parentage.** His father, whose Christian name was the same, was *avocat du roi à la Table de Marbre du Palais*, and also held the position of *maître des eaux et forêts* in the vicomté of Rouen. In this latter office he is said to have shown himself a vigorous magistrate, suppressing brigandage and plunder without regard to his personal safety. He was ennobled in 1637 (it is said not without regard to his son's distinction), and the honor was renewed in favor of his sons Pierre and Thomas in 1669, when a general repeal of the letters of nobility recently granted had taken place. There appears, however, to be no instance on record of the poet himself assuming the "de" of nobility. His mother's name was Marthe le Pesant.

After being educated by the Jesuits of Rouen, Corneille at the age of eighteen was entered as *avocat*, and in 1624 took the oaths, as we are told, four years before the regular time, a dispensation having been procured. He was afterwards appointed advocate to the admiralty and to the "waters and forests," but both these posts must have been of small value, as we find him parting with them in 1650 for the insignificant sum of 6000 livres. No other evidence of any professional employment on his part is forthcoming, though he seems to have discharged certain parochial functions. His first play, *Médée*, was acted in 1629.

**Literary career.** It is said by Fontenelle to have been inspired by personal experiences, and was extremely popular, either because or in spite of its remarkable difference from the popular plays of the day, those of Hardi. In 1632 *Cliandre*, a tragedy, followed; in the following year *La Veuve*, and in 1634 the *Galerie du Palais* and *La Suivante*, all the three last-named plays being comedies. In 1634, also, having been selected as the composer of a Latin elegy to Richelieu on the occasion of the cardinal visiting Rouen, he was introduced to the subject of his verses, and was soon after enrolled among the "five poets." These officers (the others being Colletet, Bois Robert, and De l'Etoile, who in no way merited the title, and Rotrou, who was no unworthy yokefellow even of Corneille) had for tasks the more profitable than dignified occupation of working up Richelieu's ideas into dramatic form. No one could be less suited for such work than Corneille, and he soon incurred his employer's displeasure by altering the plan of the third act of *Les Thuileries*, which had been intrusted to him.

Meanwhile the year 1635 saw the production of two dramas—*La Place Royale*, a comedy of the same stamp as his preceding works, and *Médée*, a grand but unequal tragedy. In the next year the singular extravaganza entitled *L'illusion comique* followed, and was succeeded by the *Cid*. The triumphant success of this, perhaps the most "epoch-making" play in all literature, the jealousy of Richelieu and the Academy, the open attacks of Scudéri and Mairet and others, and the pamphlet-war which followed, are among the best-known incidents in the history of letters. The triumphant verdict of the Academy, when its arbitration was demanded by Richelieu, and not openly repudiated by Corneille, was virtually unimportant; but it is worth remembering that Scudéri, a writer of at least temporary eminence and of some talent, gravely and apparently sincerely asserted and maintained of this great play that the subject was utterly bad, that all the rules of dramatic composition were violated, that the action was badly conducted, the versification constantly faulty, and the beauties as a rule stolen! Corneille himself was awkwardly situated in this dispute. The *esprit bourru* by which he was at all times distinguished, and which he now displayed in his rather arrogant *Excuse à Ariste*, unfitted him for controversy, and it was of vital importance to him that he should not lose the outward marks of favor which Richelieu continued to show him. Perhaps the pleasantest feature in the whole matter is the unshaken and generous admiration with which Rotrou, the only contemporary

whose genius entitled him to criticise Corneille, continued to regard his friend, rival, and in some sense (though Rotrou was the younger of the two) pupil. Finding it impossible to make himself fairly heard in the matter, Corneille (who had retired from his position among the "five poets") withdrew to Rouen and passed nearly three years in quiet there. In 1639, or at the beginning of 1640, appeared *Horace* with a dedication to Richelieu. The good offices of Madame de Combalet, to whom the *Cid* had been dedicated, and perhaps the satisfaction of the cardinal's literary jealousy, had healed what breach there may have been, and indeed the poet was in no position to quarrel with his patron. Richelieu not only allowed him 500 crowns a year, but soon afterwards employed his omnipotence in reconciling the father of the poet's mistress, Marie de Lampérière, to the marriage of the lovers. These were years of considerable importance to Corneille. Not only *Horace* but *Cinna* appeared therein. A brief but very serious illness attacked him, and the death of his father increased his family anxieties by leaving his mother in very indifferent circumstances.

Towards the end of 1640 *Polyeucte* was produced; and in the following year Corneille figured as a contributor to the *Guirlande de Julie*, a famous album which the marquis de Montausier, assisted by all the literary men of the day, offered to his lady love Julie d'Angennes. 1642 saw *La Mort de Pompée* and the memorable comedy of *Le Menteur*, which though adapted from the Spanish stood in relation to French comedy very much as *Le Cid*, which owed to Spain only its subject, stood to French tragedy. The sequel which followed it in 1644 was not popular, but *Rodogune* was a brilliant success. *Théodore*, a tragedy on a somewhat perilous subject, was the first of Corneille's plays which was definitely damned. Some amends may have been made to him by the commission which he received to write verses for the *Triumphes poétiques de Louis XIII.* Soon after (January 22, 1647) the Academy at last (it had twice rejected him on frivolous pleas) admitted the greatest of living French writers. *Heraclius* (1647), *Andromède* (1650), a spectacle rather than a play, *Don Sanche d'Aragon* (1650), and *Nicomède* (1651) were the products of the next few years' work; but in 1653 *Pertharite* was received with decided disfavor, and the poet in disgust resolved, like Ben Jonson, to quit the loathed stage. In this resolution he persevered for six years, during which he worked at a verse translation of the *Imitation of Christ* (finished in 1656), at his three *Discourses on Dramatic Poetry*, and at the *Examens* which are usually printed at the end of his plays. In 1659 Fouquet, the Mæcenas of the time, persuaded him to alter his resolve, and *Cédipe*, a play which became a great favorite with Louis XIV., was the result. It was followed by *La Toison d'Or* (1660), *Sertorius* (1662), and *Sophonisbe* (1663). In this latter year Corneille was included among the list of men of letters pensioned at the proposal of Colbert. He received 2000 livres. *Othon* (1664), *Agésilas* (1666), *Attila* (1667), and *Tite et Bérénice* (1670), were generally considered as proofs of failing powers,—the cruel quatrain of Boileau—

Après l'Agésilas  
Hélas!  
Mais après l'Attila  
Hôlà!

in the case of these two plays, and the unlucky comparison with Racine in the *Bérénice*, telling heavily against them. In 1665 and 1670 some versification of devotional works addressed to the Virgin had appeared. The part which Corneille took in *P. yché* (1671), Molière and Quinault being his coadjutors, showed signs of renewed vigor; but *Pulchérie* (1672) and *Suréna* (1674) were allowed even by his faithful followers to be failures. He lived for ten years after the appearance of *Suréna*, but was almost silent save for the publication, in 1676, of some beautiful verses thanking Louis XIV. for ordering the revival of his plays. He died at his lodging in the Rue d'Argenteuil on the 30th of September, 1684. For nine years (1674-81), and again in 1683, his pension had, for what reason is unknown, been suspended, and he was in great straits. The story goes that at last Boileau, hearing of this, went to the king and offered to resign his own pension if there were not money enough for Corneille, and that Louis sent the aged poet 200 pistoles. He might have said, with a great English

post in like case, "I have no time to spend them." Two days afterwards he was dead.

Corneille was buried in the church of St. Roch, where no monument marked his grave until 1821. He had six children, of whom four survived him. Pierre, the eldest son, a cavalry officer, left posterity in whom the name has continued; Marie, the eldest daughter, was twice married, and by her second husband, M. de Farcy, became the ancestress of Charlotte Corday. Repeated efforts have been made for the benefit of the poet's descendants, Voltaire, Charles X., and the *Comédie Française* having all borne part therein.

The portraits of Corneille (the best and most trustworthy of which is from the burin of Lasne, an engraver of Caen) represent him as a man of serious, almost of stern countenance, and this agrees well enough with such descriptions as we have of his appearance and with the idea of him which we should form from his writings and conduct. His nephew Fontenelle admits that his general address and manner were by no means prepossessing. Others use stronger language, and it seems to be confessed that either from shyness, from pride, or from physical defects of utterance, probably from all three combined, he did not attract strangers. Racine is said to have assured his son that Corneille made verses "cent fois plus beaux" than his own, but that his own greater popularity was owing to the fact that he took some trouble to make himself personally agreeable. Almost all the anecdotes which have been recorded concerning the greatest of French dramatists testify to a rugged and somewhat unamiable self-contentment. "Je n'ai pas le mérite de ce pays-ci," he said of the court. "Je n'en suis pas moins Pierre Corneille," he is said to have replied to his friends whenever they dared to suggest certain shortcomings in his behavior, manner, or speech. "Je suis saoul de gloire et affamé d'argent" was his reply to the compliments of Boileau. Yet tradition is unanimous as to his affection for his family and as to the harmony in which he lived with his brother Thomas who had married Marguerite de Lampérière, younger sister of Marie, and whose household both at Rouen and at Paris was practically one with that of his brother. No story about Corneille is better known than that which tells of the trap between the two houses, and how Pierre, whose facility of versification was much inferior to his brother's, would lift it when hard beset; and call out "Sans-souci, une rime!" Notwithstanding this domestic felicity, an impression is left on the reader of Corneille's biographies that he was by no means a happy man. Melancholy of temperament will partially explain this, but there were other reasons. He appears to have been quite free from envy properly so called, and to have been always ready to acknowledge the excellences of his contemporaries. But, as was the case with a very different man—Goldsmith—praise bestowed on others always made him uncomfortable unless it were accompanied by praise bestowed on himself. As Guizot has excellently said, "Sa jalousie fut celle d'un enfant qui veut qu'un sourire le rassure contre les caresses que reçoit son frère."

Another cause of discomfort must have been the pressure of poverty. His pensions covered but a small part of his long life and were most irregularly paid. The occasional presents of rich men, such as Montauron (who gave him 1000, others say 200, pistoles for the dedication of *Cinna*) and Fouquet (who commissioned *Estimé*), were few and far between, though they have exposed him to reflections which show great ignorance of the manners of the age. Of his professional earnings, the small sum for which, as we have seen, he gave up his offices, and the expression of Fontenelle that he practised "sans goût et sans succès" are sufficient proof. His patrimony and his wife's dowry must have been both trifling. On the other hand, it was during the early and middle part of his career impossible, and during the later part very difficult, for a dramatist to live decently by his pieces. It was not till the middle of the century that the custom of allowing the author two shares in the profits during the first run of the piece was observed, and even then revivals profited him nothing. Thomas Corneille himself, who to his undoubted talents united wonderful facility, untiring industry, and (gift valuable above all others to the playwright) an extraordinary knack of hitting the public fancy, died, notwithstanding his simple tastes, "as poor as Job." We know that Pierre received for two of his later pieces 2000 livres each, and it would seem that this was the utmost he ever did receive.

But if his gains in money were small and insufficient, it must not be supposed that his Popularity-reward in fame was stinted. Corneille, unlike many of the great writers of the world, was not driven to wait for "the next age" to do him justice. The cabal which attacked the *Cid* was a cabal of a purely cliquish character, and had, as we are assured on the amplest evidence, no effect whatever on the judgment of the public. All his subsequent masterpieces were received with the same ungrudging applause, and the rising star of Racine, even in conjunction with the manifest inferiority of the last five or six plays of the author of *Cinna*, with difficulty prevailed against the towering reputation of the latter. The great men of his time—Condé, Turenne, the *maréchal de Grammont*, the knight-errant *duc de Guise*—were his fervent admirers. Nor had he less justice done him by a class from whom less justice might have been expected, the brother men of letters whose criticisms he treated with such scant courtesy. The respectable mediocrity of Chapelain might misapprehend him; the lesser geniuses of Scudéri and Mairêt might feel alarm at his advent; the envious Claverets and D'Aubignac might snarl and scribble. But Balzac did him justice; Rotrou, as we have seen, never failed in generous appreciation; Molière in conversation and in print recognized him as his own master and the foremost of dramatists. We have quoted the informal tributes of Racine; but it should not be forgotten that Racine, in discharge of his duty as respondent at the Academical reception of Thomas Corneille, pronounced upon the memory of Pierre perhaps the noblest and most just tribute of eulogy that ever issued from the lips of a rival. Boileau's testimony is of a more chequered character; yet he seems never to have failed in admiring Corneille whenever his principles would allow him to do so. Of his conduct in the poet's dire necessity we have spoken already, and there is one story of the period of his extreme old age which must not be omitted. Questioned as to the great men of Louis XIV.'s reign, he is said to have replied: "I only know three,—Corneille, Molière, and myself." "And how about Racine?" his auditor ventured to remark. "He was an extremely clever fellow, whom I taught with great difficulty to write verse." It was reserved for the 18th century to exalt Racine above Corneille. Voltaire, who was prompted by his natural benevolence to comment on the latter (the profits went to a relation of the poet), was not altogether fitted by nature to appreciate Corneille, and moreover, as has been ingeniously pointed out, was not a little wearied by the length of his task. His partially unfavorable verdict was endorsed earlier by Vauvenargues, who knew little of poetry, and later by La Harpe, whose critical standpoint has now been universally abandoned. Napoleon I. was a great admirer of Corneille ("s'il vivait je le ferais prince," he said), and under the Empire and the Restoration an approach to a sounder appreciation was made. But it was the glory of the romantic school, or rather of the more catholic study of letters which that school brought about, to restore Corneille to his true rank, that of the greatest writer of France,—perhaps the only one who up to our own times can take rank with the Dantes and Shakespeares of other countries. So long, indeed, as a certain kind of criticism was pursued due appreciation was impossible. When it was thought sufficient to say with Boileau that Corneille excited, not pity or terror, but admiration which was not a tragic passion; or that

"D'un seul nom quelquefois le son dur ou bizarre  
Read un poème entier ou burlesque ou barbare;"

when Voltaire could think it crushing to add to his exposure of the "infamies" of *Théodore*—"après cela comment osons nous condamner les pièces de Lope de Vega et de Shakespeare?" it is obvious that the *Cid* and *Polyeucte*, much more *Don Sancho d'Aragon* and *Rodogune*, were sealed books to the critics.

Almost the first thing which strikes a reader is the singular inequality of this poet. Producing, as he certainly has produced, work which classes him with the greatest names in literature, he has also signed an extraordinary quantity of verse which has not merely the defects of genius, irregularity, extravagance, *biarrêté*, but the faults which we are apt to regard as exclusively belonging to those who lack genius, to wit, the dullness and tediousness of mediocrity. Molière's manner of accounting for this is famous in literary

Style and peculiarities.

history or legend. "My friend Corneille," he said, "has a familiar who inspires him with the finest verses in the world. But sometimes the familiar leaves him to shift for himself, and then he fares very badly." That Corneille was by no means destitute of the critical faculty his *Discourses* and the *Examens* (often admirably acute) of his plays show well enough. But an enemy might certainly contend that a poet's critical faculty should be of the Promethean, not the Epimethean order. The fact seems to be that the form in which Corneille's work was cast, and which by an odd irony of fate he did so much to originate and make popular, was very partially suited to his talents. He could imagine admirable situations, and he could write verses of incomparable grandeur—verses that reverberate again and again in the memory. But he could not, with the patient docility of Racine, labor at strictly proportioning the action of a tragedy, at maintaining a uniform rate of interest in the course of the plot and of excellence in the fashion of the verse. Especially in his later plays a verse and a couplet will crash out with fulgurous brilliancy, and then be succeeded by pages of very second-rate declamation or argument. It was urged against him also by the party of the *Doucereux*, as he called them, that he could not manage, or did not attempt, the great passion of love, and that except in the case of Chimène his principle seemed to be that of one of his own heroines:—

"Laissons, seigneur, laissons les petites ames  
Ce commerce rampant de soupirs et de flammes."  
(Aristie in *Sertorius*.)

There is perhaps some truth in this accusation, however much some of us may be disposed to think that the line just quoted is a fair enough description of the admired ecstasies of Achille and Bajazet. But these are all the defects which can be fairly urged against him; and in a dramatist bound to a less strict service they would hardly have been even remarked. On the English stage the liberty of unrestricted incident and complicated action, the power of multiplying characters and introducing prose scenes, would have exactly suited his somewhat intermittent genius, both by covering defects and by giving greater scope for the exhibition of power.

How great that power is can escape no one. The splendid soliloquies of Medea which, as Voltaire happily says, "announce Corneille," the entire parts of Rodrigue and Chimène, the final speech of Camille in *Horace*, the discovery scene of *Cinna*, the dialogues of Pauline and Sévère in *Polyeucte*, the magnificently-contrasted conception and exhibition of the best and worst forms of feminine dignity in the Cornélie of *Pompée* and the Cléopâtre of *Rodogune*, the singularly fine scene in *Don Sanche d'Aragon*, between the haughtiness of the Spanish nobles and the unshaken dignity of the supposed adventurer Carlos, and the characters of Aristie, Viriate, and Sertorius himself, in the play named after the latter, are not to be surpassed in grandeur of thought, felicity of design, or appropriateness of language. Admiration may or may not properly be excited by tragedy, and until this important question is settled the name of tragedian may be at pleasure given to or withheld from the author of *Rodogune*. But his rank among the greatest of dramatic poets is not a matter of question. For a poet is to be judged by his best things, and the best things of Corneille are second to none.

It was, however, some time before his genius came to perfection. It is undeniable that the first six or seven of his plays are of no very striking intrinsic merit. On the other hand, it requires only a very slight acquaintance with the state of the drama in France at the time to see that these works, poor as they may now seem, must have struck the spectators as something new and surprising. The language and dialogue of *Médée* are on the whole simple and natural, and though the construction is not very artful (the fifth act being as is not unusual in Corneille superfluous and clumsy) it is still passable. The fact that one of the characters jumps on another's back, and the rather promiscuous kissing which takes place, are nothing to the liberties usually taken in contemporary plays. A worse fault is the *σχιζομυθία*, or, to borrow Butler's expression, the Cat and Puss dialogue which abounds. But the common objection to the play at the time was that it was too natural and too devoid of striking incidents. Corneille accordingly, as he tells us, set to work to cure these faults, and produced a truly wonderful work, *Clitandre*. Murders, combats, escapes, and outrages of all kinds are provided; and the language makes *The Rehearsal* no burlesque. One of the heroines rescues herself from a ravisher by blinding him with a hair-pin, and as she

escapes the seducer apostrophizes the blood which trickles from his eye, and the weapon which has wounded it, in a speech forty verses long. This, however, was his only attempt of the kind. His next four pieces were comedies. They are not particularly comic, and they labor under the same defect of construction as *Médée*. But there is claimed for them the introduction of some important improvements, such as the choosing for scenes places well known in actual life (as in the *Galerie du Palais*), and the substitution as a stock comic character of the soubrette in place of the old convenient and grotesque nurse. It is certain, however, that there is more interval between these six plays and *Médée* than between the latter and Corneille's greatest drama. Here first do we find those sudden and magnificent lines which characterize the poet. The title rôle is, however, the only good one, and as a whole the play is heavy. Much the same may be said of its curious successor, *L'illusion comique*. This is not only a play within a play, but in part of it there is actually a third involution, one set of characters beholding another set discharging the parts of yet another. It contains, however, some very fine lines,—in particular, a defence of the stage and some heroics put into the mouth of a braggadocio. We have seen it said of the *Cid* that it is difficult to understand the enthusiasm it excited. But the difficulty can only exist for persons who are insensible to dramatic excellence, or who so strongly object to the forms of the French drama that they cannot relish anything so presented. To relish *Iphigénie* one must in some sort make one's self of the age of its first spectators. But Rodrigue, Chimène, Don Diègue are not of any age but of all time. The conflicting passions of love, honor, duty, are here represented as they never had been on a French stage, and no one who has ever felt either can be indifferent to their representation in the "strong style" which was Corneille's own. Of the many objections urged against the play, perhaps the weightiest is that which condemns the frigid and superfluous part of the *Infanta*. *Horace*, though more skilfully constructed, is perhaps less satisfactory. There is a hardness about the younger Horace which might have been, but is not made, imposing, and Sabine's effect on the action is quite out of proportion to the space she occupies. The splendid declamation of Camille, and the excellent part of the elder Horace, do not altogether atone for these defects. *Cinna* is perhaps generally considered the poet's masterpiece, and it undoubtedly contains the finest single scene in all French tragedy, a scene which may take rank with any other perhaps ever written. The blot on it is certainly the character of Emilie, who is spiteful and thankless, not heroic. *Polyeucte* has sometimes been elevated to the same position. There is, however, a certain coolness about the hero's affection for his wife which somewhat detracts from the merit of his sacrifice; while the Christian part of the matter is scarcely so well treated as in the *Saint Genest* of Rotrou or the *Virgin Martyr* of Massinger. On the other hand, the entire parts of Pauline and Sévère are beyond praise, and the manner in which the former reconciles her duty as a wife with her affection for her lover is an astonishing success. In *Pompée* (for *La Mort de Pompée*, though the more appropriate, was not the original title) the splendid declamation of Cornélie is the chief thing to be remarked. *Le Menteur*, which in its English form is well known to play-goers on this side the Channel, fully deserves the honor which Molière paid to it. Its continuation, notwithstanding the judgment of some French critics, we cannot think so happy. But *Théodore* is perhaps the most surprising of literary anomalies. The central situation, which so greatly shocked Voltaire and indeed all French critics from the date of the piece, does not seem to blame. A virgin martyr who is threatened with loss of honor as a bitterer punishment than loss of life offers points as powerful as they are perilous. But the treatment is thoroughly bad. From the heroine, who is in a phrase of Dryden's "one of the coolest and most insignificant" heroines ever drawn, to the undignified Valens, the termagant Marcelle, and the peevish Placide, there is hardly a good character. Immediately upon this in most printed editions, though older in representation, follows the play which (therein agreeing rather with the author than with his critics) we should rank as his greatest triumph, *Rodogune*. Here there is hardly a weak point. The magnificent and terrible character of Cléopâtre, and the contrasted dispositions of the two princes, of course attract most attention. But the character of Rodogune herself, which has not escaped criticism, comes hardly short of these. *Heracleus*, despite great art and much fine poetry, is injured by the extreme complication of its argument and by the blustering part of Pulchérie. *Andromède*, with the later spectacle piece, the *Toison d'Or*, does not call for comment, and we have already alluded to the chief merit of *Don Sanche*, a play which, however, deserves both admiration and study. *Nicomède*, often considered one of Corneille's best plays, is chiefly remarkable for the curious and unusual character of its hero. Of *Perthrite* it need only be said that no single critic has to our knowledge disputed the justice of its damnation. *Edipe* is certainly unworthy of its subject and its author, but in *Sertorius* we have one of Corneille's finest plays. It is remarkable not only from its many splendid verses and for the nobility of its sentiment,

but from the fact that not one of its characters lacks interest, a commendation not generally to be bestowed on its author's work. Of the last six plays we may say that perhaps only one of them, *Agésilas*, is almost wholly worthless. Its irregular verses make one very glad that they found few imitators. In the others, though the spectator would not be likely to appreciate them, yet the reader will find not a little verse of the brand which only Corneille could impose. Not a few speeches of *Suzanna* and of *Othon* are of a very high order. As to the poet's non-dramatic works, we have already spoken of his extremely interesting critical dissertations. His minor poems and poetical devotions are not likely to be read save from motives of duty or curiosity. The verse translation of à Kempis, indeed, which was in its day immensely popular (it passed through many editions), condemns itself. Yet these, as well as his greater works, deserve honor as the instruments by which Corneille wrought, perhaps, a mightier change in his mother tongue than any one man ever effected. Of him much rather than of Dryden might it be said, *Lateritium invenit, reliquit marmorium*. And in so saying it need not be forgotten that for some purposes brick is better than marble.

The subject of the bibliography of Corneille has been recently treated in the most exhaustive manner by M. E. Pirot in his *Bibliographie Cornélienne* (Paris, 1875). Less elaborate but still ample information may be found in Taschereau's *Vie* and in M. Marty Laveaux's edition of the *Works*. A short but useful list is given in Louandre's edition, vol. i. p. 47. The chief collected editions in the poet's lifetime were those of 1644, 1648, 1652, 1660 (with important corrections), 1664, and 1682. In 1692 T. Corneille published a complete *Théâtre* in 5 vols. 12mo. Numerous editions appeared in the early part of the 18th century, that of 1740 (6 vols. 12mo, Amsterdam) containing the *Œuvres diverses* as well as the plays. Eight editions are recorded between this and that of Voltaire (12 vols. 8vo; Geneva, 1764, 1776, 8 vols. 4to), whose *Commentaires* have often been reprinted separately. In the year IX. (1801) appeared an edition of the *Works* with Voltaire's commentary and criticisms thereon by Palissot (12 vols. 8vo, Paris). Since this the editions have been extremely numerous. Those chiefly to be remarked are the following. Lefevre's (12 vols. 8°, Paris, 1854), well printed and with a useful variorum commentary, lacks bibliographical information and is disfigured by hideous engravings. Louandre's (2 vols. 18mo, Paris, 1853), though entitled *Œuvres des deux Corneilles*, contains only twelve pieces with some miscellaneous works of Pierre. It is, however, very well edited, and good as far as it goes. Of Taschereau's, in the *Bibliothèque Elzévirienne*, only two volumes were published. Lahure's appeared in 5 vols. (1857-62) and 7 vols. (1864-66). The edition of Ch. Marty Laveaux in Regnier's *Grands Ecrivains de la France* (1862-1868), in 12 vols. 8vo, is likely for some time to remain the standard. In appearance and careful editing it leaves nothing to desire, containing the entire works, a lexicon, full bibliographical information, and an album of illustrations of the poet's places of residence, his arms, some title pages of his plays, facsimiles of his writings, &c. Nothing is wanting but variorum comments, which Lefevre's edition supplies. A handy edition of the plays appeared in 1873 (3 vols. 8vo, Paris.) Fontenelle's *Life of His Uncle* is the chief original authority on that subject, but Taschereau's *Histoire de la Vie et des Ouvrages de P. Corneille* (1st ed. 1829, 2d in the *Bibl. Elzévirienne*, 1855) is the standard work. Its information has been corrected and augmented in various later publications, but not materially. Of the exceedingly numerous writings relative to Corneille we can only mention the *Recueil de dissertations sur plusieurs tragédies de Corneille et de Racine* of the Abbé Garnet (Paris, 1740), the criticisms already alluded to of Voltaire, La Harpe, and Palissot, the well-known work of Guizot, *Corneille et son temps*, and the essay of Sainte-Beuve. The best known English criticism, that of Hallam, is inadequate. The translations of separate plays are very numerous, but of the complete *Théâtre* only one version (into Italian) is recorded by the French editors. Fontenelle tells us that his uncle had translations of the *Cid* in every European tongue but Turkish and Slavonic, and M. Pirot's book apprises us that the latter want at any rate is now supplied. Corneille has suffered less than some other writers from the attribution of spurious works. Besides a tragedy, *Sylla*, the chief piece thus assigned is *L'occasion perdue recouverte*, a rather loose tale in verse. Internal evidence by no means fathers it on Corneille, and all external testimony (except a foolish story that the poet composed his devotional works as a penance for its production) ascribes it to a contemporary poet Cantense. It has never been included in Corneille's works. It is curious that a translation of Statius (*Thebaid*, bk. iii.), an author of whom Corneille was extremely fond, though known to have been written, printed, and published, has entirely dropped out of sight. Three verses quoted by Ménage are all we possess.

(G. SA.)

CORNEILLE, THOMAS (1629-1709), was nearly twenty years younger than his brother, the day of his birth being

August 20, 1625. His skill in verse-making seems to have shown itself early, as at the age of fifteen he composed a piece in Latin which was represented by his fellow pupils at the Jesuits' College of Rouen. He soon followed his brother's steps, and his first piece, *Les Engagements du Hasard*, was acted in 1647. From this time forward he produced a constant series of plays, sometimes in collaboration, oftener alone. At his brother's death he succeeded to his vacant chair in the Academy. He then turned his attention to philology, producing a new edition of the *Remarques* of Vaugelas in 1687, and in 1694 a dictionary intended to supplement that of the Academy. A complete translation of Ovid's *Metamorphoses* (he had published six books with the *Heroic Epistles* some years previously) followed in 1697. In 1704 he lost his sight and was constituted a "veteran," a dignity which preserved to him the privileges, while it exempted him from the duties, of an Academician. But he did not allow his misfortune to put a stop to his work, and soon produced a large *Geographical and Historical Dictionary* in 3 vols. folio. This was his last labor. He died on the 8th of December, 1709, aged eighty-four. It has been the custom to speak of Thomas Corneille as of one who, but for the name he bore, would merit no notice. This is by no means the case; on the contrary, he is rather to be commiserated for his connection with a brother who outshone him as he would have outshone almost any one. Of his forty-two plays (this is the utmost number assigned to him) the last edition of his complete works contains only thirty-two, but he wrote several in conjunction with other authors. Two are usually reprinted at the end of his brother's selected works. These are *Ariane* and the *Comte d'Essex*, in the former of which Rachel attained success. But of *Laodice*, *Camma*, *Stilico*, and some other pieces, Pierre Corneille himself said that "he wished he had written them," and he was not wont to speak lightly. *Camma* especially deserves notice. Thomas Corneille is in many ways remarkable in the literary history of his time. His *Timocrate* had the longest run recorded of any play in the century. For *La Dévotion* he and his coadjutor De Visé received above 6000 livres, the largest sum known to have been thus paid. Lastly, one of his pieces (*Le Baron des Foudrières*) contests the honor of being the first which was hissed off the stage.

(G. SA.)

CORNELIA, one of the greatest women in Roman history, was the younger daughter of Scipio Africanus the Elder, the conqueror of Carthage, and mother of the two great tribunes, Tiberius and Caius Gracchus, and of Cornelia, the wife of Scipio Africanus the younger. On the death of her husband, refusing numerous offers of marriage, including even one from King Ptolemy, she devoted herself to the education of her children, a task for which her lofty spirit and wide attainments rendered her admirably fitted, and which had the most extraordinary results. The only attack ever made upon her lofty reputation was the charge that she was concerned in the death of her son-in-law, Scipio, which was, there is no reason to doubt, a mere baseless slander. On her death a statue was erected to her memory bearing the inscription—"Cornelia, mother of the Gracchi." She is said to have presented her sons to a Campanian lady, who asked to see her jewels, as the only jewels of which she could boast. After the murder of Caius, the second of her sons, she retired to Misenum, where she devoted herself to Greek and Latin literature, and to the society of men of letters. See Plutarch's *Lives of T. and C. Gracchus*.

CORNELIUS, PETER VON, the leader of the German art revival, was born in Düsseldorf in 1784, and died in Berlin, March 6, 1867.

Cornelius, like other great painters, is reported to have manifested his artistic talent at a very early age. His father, who was inspector of the Düsseldorf Gallery, dying whilst the painter was yet a boy, the young Cornelius was stimulated to extraordinary exertions. The reasons for this he has himself pathetically expressed in a letter to the Count Raczynski. "I was in my sixteenth year," he writes, "when I lost my father, and it fell to the lot of an elder brother and myself to watch over the interests of a numerous family. It was at this time that it was attempted to persuade my mother that it would be better for me to devote myself to the trade of a goldsmith than to continue to pursue painting—in the first place, in consequence of the time necessary to qualify me for the art, and in the next

because there were already so many painters. My dear mother, however, rejected all this advice, and I felt myself impelled onward by an uncontrollable enthusiasm, to which the confidence of my mother gave new strength, which was supported by the continual fear that I should be removed from the study of that art I loved so much."

His earliest work of importance was the decoration of the choir of St. Quirinus Church at Neuss. At the age of twenty-six he produced his designs from *Faust*. On October 14, 1811, he arrived in Rome, where he soon became one of the most promising of that brotherhood of young German painters which included Overbeck, Schadow, Veit, Schnorr, Pforr, Vogel, and Wächter,—a member of a fraternity (some of whom selected a ruinous convent for their home) who were banded together for resolute study and mutual criticism. Out of this association came the men who, though they were ridiculed at the time, were destined to found a new German school of art.

At Rome Cornelius participated, with other members of his fraternity, in the decoration of the Casa Bartoldi and the Villa Massimi, and while thus employed he was also engaged upon designs for the Nibelungenlied. From Rome he was called to Düsseldorf to remodel the Academy, and to Munich by the then crown-prince of Bavaria, afterwards Louis I., to take the direction of those decorations which his royal highness had projected for the Glyptothek. Cornelius, however, soon found that attention to such widely separated duties was incompatible with the just performance of either, and most inconvenient to himself; eventually, therefore, he resigned his post at Düsseldorf to throw himself completely and thoroughly into those works for which he had been commissioned by the crown-prince. He therefore left Düsseldorf for Munich, where he was joined by those of his pupils who elected to follow and to assist him. At the death of Director Langer, 1824–25, he became director of the Munich Academy.

The fresco decorations of the Ludwigskirche, which were for the most part designed and executed by Cornelius, are perhaps the most important mural works of modern times. The large fresco of the Last Judgment, over the high altar in that church, measures 62 feet in height by 38 feet in width. The frescoes of the Creator, the Nativity, and the Crucifixion in the same building are also upon a large scale.

Amongst his other great works in Munich may be included his decorations in the Pinakothek and in the Glyptothek; those in the latter building, in the hall of the gods and the hall of the hero-myths, are perhaps the best known. About the year 1839–40 he left Munich for Berlin to proceed with that series of cartoons, from the Apocalypse, for the frescoes for which he had been commissioned by Frederick William IV., and which were intended to decorate the Campo Santo, or Royal Mausoleum, forming one of the wings of the new cathedral. These were his final works.

It is difficult to convey to the English reader any adequate notion of the important position which this great designer and master spirit held in contemporary art; for Cornelius, as an oil painter, possessed but little technical skill, nor do his works exhibit any instinctive appreciation of color. Even as a fresco painter his manipulative power was not great. And in critically examining the execution in color of some of his magnificent designs, one cannot help feeling that he was, in this respect, unable to do them full justice. This criticism will even hold after making due allowance, in works of a high intellectual aim, for the claims of form over those of color. Cornelius and his associates formed their styles on the study of the great Italian masters, or rather, we should say, endeavored to follow in their own works the spirit of the Italian painters. But as in family descent so in the works of genius we may sometimes detect the indications of several distinct formative influences. Thus in Cornelius the Italian strain is to a considerable extent modified by the Dürer heritage. This is true not only of Cornelius but of all the original members of the Munich school of thirty years since. This Dürer influence is manifest in a tendency to overcrowding in composition, in a degree of attenuation in the proportions of and a poverty of contour in the nude figure, and also in a leaning to the selection of Gothic forms for draperies. These peculiarities are even noticeable in Cornelius's principal work of the Last Judgment, in the Ludwigskirche in Munich. The attenuation and want of flexibility of contour in the nude are perhaps most conspicuous

in his frescoes of classical subjects in the Glyptothek, especially in that representing the contention for the body of Patroclus. But notwithstanding these peculiarities there is always in his works a grandeur and nobleness of conception, as all must acknowledge who have inspected his designs for the Ludwigskirche, for the Campo Santo, etc.

The difficulty which many have of understanding how a painter of such comparatively slight technical skill could materially influence the art of his age lies in their want of ability to estimate the value of a dominant or leading mind. They are alive only to those practical matters which come within the compass of their own understandings. Yet that mental calibre, that grasp of thought, that knowledge of principles, and that power of directing other men which Cornelius possessed, are the very qualities which are of the greatest value, since for one man who possesses them, there are thousands who have the capacity either for acquiring technical skill, for observing facts, or for administrative routine. Cornelius was a man of that far rarer order of regal minds who transform wastes into kingdoms. If he were not dextrous in the handling of the brush, he could conceive and design a subject with masterly purpose. If he had an imperfect eye for color, in the Venetian, the Flemish, or the English sense, he had vast mental foresight, and could direct the German school of painting into those paths which promise to make it, at no distant date, the first on the continent of Europe.<sup>1</sup> He had great political prevision, too; his favorite motto of "Deutschland über Alles" indicates the direction and the strength of his patriotism.

Carl Hermann was one of Cornelius's earliest and most esteemed scholars, a man of simple and fervent nature, painstaking to the utmost, a very type of the finest German student nature; Kaulbach and Eberle were also amongst his valued scholars. The reader may here be reminded that the vast importance of the practice of mural paintings to the fine arts of a country consists in the necessity which it involves of obtaining the assistance of scholars in the carrying out, within reasonable time, of extensive mural works. Hence the institution of scholarship in Germany as in the great Italian art epoch. Every public edifice in Munich and other German cities which was embellished with frescoes, became, as in Italy, a school of art of the very best kind; for the decoration of a public building begets a practical knowledge of design. The development of this institution of scholarship in Munich was a work of time. The cartoons for the Glyptothek were all by Cornelius's own hand. In the Pinakothek his sketches and small drawings sufficed; but in the Ludwigskirche the invention even of some of the subjects was entrusted to his scholar Hermann.

To comprehend and appreciate thoroughly the magnitude of the work which Cornelius accomplished for Germany, we must remember at the beginning of this century Germany had no national school of art. Germany was in painting and sculpture behind all the rest of Europe. Yet in less than half a century Cornelius founded a great school, revived mural painting, and turned the gaze of the art world towards Munich. The German revival of mural painting had its effect upon England, as well as upon other European nations, and led to those famous cartoon competitions being held in Westminster Hall, and ultimately to the partial decoration of the Houses of Parliament. When the latter work was in contemplation, Cornelius, in response to invitations, visited England (November, 1841). His opinion was in every way favorable to the carrying out of the project, and even in respect of the durability of fresco in the climate of England.

Cornelius, in his teaching, always inculcated a close and rigorous study of nature, but he understood by the study of nature something more than what is ordinarily implied by that expression, something more than constantly making studies from life; he meant the study of nature with an inquiring and scientific spirit. "Study nature," was the advice he once gave, "in order that you may become acquainted with its essential forms."

<sup>1</sup> There were, of course, other distinguished artists besides Cornelius who contributed to the success and the glory of the German art revival—notably Overbeck, who was his first ally in that art-loving fraternity of his early manhood, Schnorr von Carolsfeld, Heinrich Hess, Wilhelm von Kaulbach, Veit, Schadow, etc.; also those scholars who assisted in the execution of the great mural works in Munich and elsewhere, some of whom themselves became eminent, whilst others esteemed it a sufficient privilege to be permitted to help in the great and national work.

The personal appearance of Cornelius could not but convey to those who were fortunate enough to come into contact with him the impression that he was a man of an energetic, firm, and resolute nature. He was below the middle height and squarely built. There was evidence of power about his broad and overhanging brow, in his eagle eyes and firmly gripped attenuated lips, which no one with the least discernment could misinterpret. Yet there was a sense of humor and a geniality which drew men towards him; and towards those young artists who sought his teaching and his criticism he always exhibited a calm patience.

The reader may consult Mr. Beavington Atkinson's excellent papers on German art, contributed to the *Art Journal* in 1865, and Dr. Förster's life of the painter, published at Munich.

(w. c. r.)

CORNETO, a town of Italy with about 4000 inhabitants, in the province of Rome and district of Civita Vecchia, on the River Marta, two miles from the railway between Civita Vecchia and Leghorn. Dating probably from about the 8th century, and fortified in the 14th or 15th, it still presents a distinctly mediæval aspect. Among its more interesting buildings are the now ruinous cathedral of St. Maria di Castello, of the 12th century, the mansion of the Cardinal Vitelleschi, now used as a hotel, and the *palazzo comunale* with its fresco-paintings. During the great Guelph and Ghibelline struggle Corneto adhered enthusiastically to the Papal cause, and it was the first place in Italy that had the honor of welcoming back Gregory XI. from Avignon. Its interest to the archaeologist and the traveller depends on its connection with a much earlier age; it occupies the western extremity of Montarozzi, a volcanic spur of the Ciminian Hills, which served as a necropolis for the old Etruscan city of Tarquinii, and the neighborhood is rich in various kinds of Etruscan remains. The most interesting of these are the painted tombs, which, though referred to in a Latin poem of the 15th century, and the object of a commission by Innocent VIII., were practically lost sight of till the present century. The largest, indeed, known as the *Grotta del Cardinale*, was discovered in 1669, but the discovery was again forgotten till 1780. General attention was drawn to the district by Mr. Byres in 1842, and investigations have since been prosecuted by Prince Lucien Bonaparte, Signor Avvolta, Baron Stackelberg, Kestner, and other archaeologists. The subjects represented on the walls are of very miscellaneous character, and, according to the best authorities, the tombs belong to very different epochs. That known as the *Grotta Querciola* contains a banqueting scene and a boar hunt; the *Grotta del Morto*, a picture of a dead man attended by mourners; the *Delle Bighe*, a chariot race; and the *Del Barone*, warlike games, horsemen, and similar subjects. These were all known before 1840, and several of them have become greatly decayed; but the loss has so far been made good by more recent discoveries. Among these may be mentioned the *Tomba Baietti*, adorned with figures of gymnasts, dancers, and horsemen; the *Del Cacciatore*, with a variety of well-designed hunting scenes; and the *Del Letto Funebre*, with charioteers, pugilists, and other figures.

The first extant treatise on the tombs of Corneto is a manuscript of the year 1756, by an Augustinian monk, Padre Jeannicola Forlivesi. See J. Byres, *Hypogæi, or The Sepulchral Caverns of Tarquinia*, 1842; Dennis, *The Cities and Cemeteries of Etruria*; and especially the *Bullettino and Annali dell' Istituto di corrisp. Arch. di Roma*, which, in the earlier volumes, are full of details of the Corneto discoveries and continue to give information as occasion serves.

CORNHIERT, THEODORE (1522-1590), a Dutch writer on politics and theology, was born at Amsterdam of a good Dutch family. While a child he was for some years in Spain and Portugal. On returning to Holland, having married a wife without fortune in defiance of the provisions of his father's will, he was obliged to accept a situation as *major-domo* to the father of the Henry Broderode who took so prominent a part in the contest with Spain. Afterwards he settled in Haarlem as an engraver on copper. In 1562 he obtained the post of secretary to the city of Haarlem, and in 1564 that of secretary to the burgomasters of that city. He now threw himself into the struggle of his country against Spanish tyranny; and he was employed to draw up the famous manifesto which the prince of Orange published in 1566. Not long after he was seized and im-

prisoned by the Government; but he escaped to Cleves, where he maintained himself by his art. When the States, however, obtained their freedom, Cornhert returned home, and became secretary of state; but this position he did not long retain, on account, it is said, of the rigor with which he strove to repress military disorders. Cornhert was also famous as a theologian. At thirty years of age, having become interested in theology, and being desirous of consulting St. Augustine, he commenced the study of Latin. He entered into controversy alike with Catholics and Reformers, with both of whom he refused to communicate. Reformers, he said, were sadly wanted, but those who called themselves such were not the kind that the church required; what was needed was apostles directly inspired from heaven. Till such were sent, he advised all churches to join together in an undogmatic communion.

He wrote a treatise against the capital punishment of heretics, a pamphlet defending the rebellion of the United Provinces, a preface to the Dutch grammar published by the Society of Rhetoricians of Amsterdam, and a number of poems, including, according to some, the popular song, *Wilhelmus van Nassouwe*, which, however, is attributed by others to Philip van Marnix. His collected works appeared in 1630.

CORNUTUS, L. ANNÆUS, was a Stoic philosopher of great repute, who flourished in the reign of Nero. He was a native of Leptis, a city of Libya, but resided for the most part of his life in Rome. He is best known as the teacher and friend of Persius, who dedicated his fifth satire to him, and in it describes in glowing terms his affection for him. The youthful poet at his death left a large sum of money and all his books to Cornutus. Cornutus took the books, but gave the money to the poet's sisters. He also revised the poems of Persius before their publication, but committed the task of editing them to Cæsius Bassus, who requested the privilege of discharging that duty. He was well known to the famous men of the court of Nero and to Nero himself. Indeed, some have inferred from his name Annæus that he was a freedman of that family, and thus connected with Seneca and Lucan. He was banished by Nero under the following circumstances. Nero intended to write a history of the Romans in heroic verse. Before beginning his work he consulted various persons, and amongst them Cornutus, as to the number of books of which it should consist. Some advised him to make his poem in 400 books, but Cornutus urged that the number was too great, and that nobody would read so long a poem. Whereupon some one said, "Chrysippus, whom you praise and imitate, wrote many more." "Yes," said Cornutus, "but these books are useful for the life of man." Nero was enraged, and thought of putting him to death, but contented himself with banishing him to some island. We hear nothing more of Cornutus. Cornutus seems to have been a voluminous writer, but considerable uncertainty hangs about the subject of his literary activity, owing mainly to the circumstances that we do not know how many of the writings attributed to authors of the name of Cornutus are to be assigned to this one. With considerable certainty we may ascribe to him a *Commentary or Notes on Virgil*, which is frequently quoted by Servius. It also appears likely that he wrote notes on Persius, and that these notes form the nucleus of the *Scholæ* which the manuscripts attribute to Cornutus. Otto Jahn thinks that they are the production of a Cornutus who lived in the Middle Ages. He also wrote books on rhetoric, one of which, *De Figuris Sententiarum* is mentioned by Aulus Gellius, and another, *Προποικιλ τέχνας*, is noticed by Simplicius. Some have inferred from corrupt passages in ancient writers that he wrote tragedies and satires; but the inference is not warranted. He also wrote on philosophical subjects. The only work that has come down to us has appeared under the title *De Natura Deorum*. Theodoret and the *Etymologicum Magnum* speak of it as being *περί Ἑλληνικῆς θεολογίας*, and this seems to have been its real name. It is an exceedingly interesting book, and deserves much more attention than it has received. It is a manual of Greek theology for the use of Stoic boys. It is marred by many absurd etymologies, but it abounds in beautiful thoughts, worthy of the teacher of Persius. Fabricius (*Bibl. Græc.*, vol. iii. p. 554, Harless) gives a list of the earlier editions. In this century it has been only once edited. Frederic Osann edited it from the papers of Jean Bapt. Cusp. d'Ansee de Vilvoisin, Göttingen, 1844. Much information in regard to Cornutus will be found in Martini's *Literaria*

*Disputatio*, Leyden, 1825, and in Otto Jahn's *Prolegomena to Pevrius*.

**CORNWALL**, the most westerly county in England, is also that which extends farthest to the south. The extreme western point of the mainland is the Land's End, 5° 41' 31" W. long.; the extreme southern point is the Lizard Head, in 49° 57' 30" N. lat. It is bounded on all sides by the sea, except on the east, where it joins Devonshire. The River Tamar forms the general boundary between the two counties from its source in the parish of Morwenstow. At the source of the river the boundary turns westward to the sea, cutting off from Cornwall the point of Hartland. Cornwall is in effect a long promontory, which gradually narrows toward the Land's End, and has one deeply projecting spur ending in the Lizard. The breadth of the county is nowhere very great; and the two seas, the English and the British channels, are visible at once from several parts of the high land of the interior. The greatest length of the county, from the Tamar to the Land's End, is 80 miles. It covers an area, including the Scilly Islands, of 869,878 acres, or 1359 square miles; contains 9 hundreds (16 divisions), 216 parishes, 28 market towns; and in 1871 had 362,343 inhabitants (169,706 males, 192,637 females). The population in 1861 numbered 369,390 persons, and in 1851 it was 355,559, showing an increase between 1851 and 1871 of 2 per cent. Cornwall is included in the western circuit. Originally forming part of the diocese of Exeter, it was in 1878 disjoined therefrom and erected into a separate bishopric—that of Truro. The assizes for the county are held at Bodmin.

**Rivers.**—The rivers all flow towards the south, with the exception of the Camel and the Alan, which, uniting, fall into the sea at Padstow. Every northern coombe, however, has its streamlet. The rivers of the south coast are—the Tamar, by far the most important; the Lynher, which falls into it; the Looe and the Fowey rivers, falling into creeks at those places; and the Fal, on which stands Falmouth. Except the Tamar none of these streams are of great size or length of course.

**Geology.**—The Carbonaceous formations of North Devon extend into the north-western angle of Cornwall, but by far the greater part of the county belongs to the Devonian or grauwacke series of rocks, consisting of slates and shales, which occupy much of South Devon, and occur again in North Devon and Somersetshire. From the Devonians four large patches of granite project at intervals. The Land's End district forms the most westerly of these granite patches, each one of which is of considerably less area than the granitic region of Dartmoor, east and north of which true granite does not occur in England except in Cumberland and Westmoreland. The highest point of the Dartmoor granite rises to 2050 feet. The highest point in Cornwall is Brown Willy, 1368 feet. This is in the most easterly patch of granite, and the height of each patch diminishes westward until the granite of the Scilly Isles, which lie beyond the Land's End, and belong to the same system, reaches, at its highest, to no more than 140 feet. A large mass of serpentine occupies the district about the Lizard Head; and the Devonian rocks are traversed by numerous veins and outbreaks of trap and of "elvens,"—the name locally given to porphyries, granitic and felspathic. The most curious pile of weathered granite is the Cheesewring, near Liskeard. Roche Rocks are formed by protruding trap. The mineral veins, for which Cornwall has so long been famous, occur in both the Devonian rocks and the granitic.

**Scenery.**—The distinctive scenery of Cornwall is to be observed on her coast line, which is much indented, and consists mostly of bold, rugged, and fantastically shaped rocks.

**Soil.**—The position of the county between two seas, and the character of its geological formations, affect the cultivation of its soil, and the character of its climate. The soil of a great part of Cornwall is indifferent, and the interior, where the ground rises to its greatest height, is so completely exposed to the sea-winds that sweep across it from east and west, that it remains almost without cultivation. The granite district west of Launceston is broken and picturesque, with rough *tors* or hills and boulders. This is for the most part a region of furze and heather; but after passing Bodmin, the true Cornish moorland asserts itself,—bare, desolate, and impracticable, broken and dug into hillocks,

sometimes due to primeval stream-works, sometimes to more modern search for metals. The seventy miles from Launceston to Mount's Bay have been not untruly called "the dreariest strip of earth traversed by any English high road." There is hardly more cultivation on the higher ground west of Mount's Bay, or in the "Meneage," or "rocky country," the old Cornish name of the promontory which ends in the Lizard. Long coombes and valleys, however, descend from this upper moorland towards the coast on both sides. In them the soil is frequently rich and deep; there are good arable and pasture farms, and the natural oak wood which these coombes or gullies contain has been well cared for and increased by modern plantations. Hitherto, however, the wealth of Cornwall has lain not so much in the soil, but underground, and in the seas which beat against her coast. Hence the favorite Cornish toast,— "fish, tin, and copper."

The *climate* of Cornwall is peculiar. Snow seldom lies for more than a few days, and the winters are less severe than in any other part of England. The sea-winds, except in a few sheltered places, prevent timber-trees from attaining to any great size, but the air is mild, and the lower vegetation, especially in the Penzance district, is almost southern in its luxuriance. This is partly due to the influence of the Gulf Stream, which passes but a short distance west of the Scilly Islands. Geraniums, fuchsias, myrtles, hydrangeas, and camellias grow to a considerable size, and flourish through the winter at Penzance and round Falmouth; and in the Scilly Isles a great variety of exotics may be seen flourishing in the open air. Stone fruit, and even apples and pears, do not attain the same full flavor as in the neighboring county, owing to the want of dry heat. The pinaster, the *Pinus austriaca*, *Pinus insignis*, and other firs succeed well in the western part of the county. All native plants display a perfection of beauty hardly to be seen elsewhere, and the furze, including the double blossomed variety, and the heaths, among which *Erica vagans* and *ciliaris* are peculiar to Cornwall, cover the moorland and the cliff summits with a blaze of the richest color. On the whole the climate is healthy, though the constant west and south-west winds, bringing with them great bodies of cloud from the Atlantic, render it damp and showery.

**Agriculture** has not received so much attention here as the more remunerative although more speculative pursuit of mining. Barley, wheat, and oats are the principal corn crops, and the acreage under each of these is much the same in amount; while of green crops one-half the acreage is occupied by turnips, a fifth by mangolds, and only a tenth by potatoes. Early potatoes, brocoli, and asparagus are grown extensively around Penzance, where the climate is very equable, and these products are sent off in large quantities to the London market. The stock of animals is considerable, and has recently been increased to some extent. The cattle, which on some farms are used for ploughing, belong mostly to the Devon breed. The following tables, taken from the agricultural returns, show the acreage of crops and numbers of live stock in the years 1873 and 1876 respectively:—

	Acres under corn crops.	Green crops.	Grass under rotation.	Percentage of area under cultivation.
1873	150,106	60,244	149,785	59
1876	143,211	60,281	138,721	60½
	Cattle.	Sheep.	Pigs.	Horses.
1873	145,286	408,173	62,827	37,466
1876	155,950	437,440	62,206	30,613

With reference to the division of the land, according to the "Owners of Land" Return, 1873, the county was in that year divided among 13,866 separate proprietors, holding land estimated at a total value of £1,235,167. There were 8717 owners of less than 1 acre, and the largest separate holding amounted to 25,910 acres. Of the whole proprietors 62 per cent. held less than 1 acre of land, which is a little under the proportion of small proprietors in the neighboring county of Devon, and still more under that of all England. The average size of the holdings was 54 acres, while that of all England was 34, and the average value per acre was £1, 12s. 6½d. as against £3, the average of the whole country. The proprietors who in 1873 held more than 10,000 acres in the county were the following:—Viscount Falmouth, 25,910; Lord Robartes (Lanhydrock), 22,234; Hon. G. M. Fortescue (Bocconoc), 17,208; G. L. Basset







(Tehidy Park), 16,969; Earl of Mount Edgcumbe, 13,288; Duchy of Cornwall, 12,516; C. H. T. Hawkins (Probus), 12,119; and Lord John Thynne, 10,244.

*Economic Geology and Mines.*—The granite, the slate, and the serpentine of Cornwall are of the first importance. The mines are among the chief features of the county. Granite is largely quarried in various districts, especially at Luxulian, on the Liskeard moors, and at Penryn, and has served for the material of London and Waterloo bridges, the docks of Chatham, and many great public works. The granite of Cornwall is for the most part coarse-grained; but in this respect it differs considerably in different places, and the coarse-grained rock is often traversed by veins of finer texture. From the Delabole quarries, in the Devonian series, near Tintagel, the best slate in the kingdom is extracted, and is largely exported; 120 tons are raised on an average daily. These slates were in great repute in the 16th century and earlier. Serpentine is quarried in the Lizard district, where alone it is found, and, besides its use as a decorative stone, it is exported in small quantities to Bristol for the manufacture of carbonate of magnesia. Chinaclay is prepared artificially from decomposed granite, chiefly in the neighborhood of St. Austell, and is exported to an annual amount of about 80,000 tons. The chief mineral productions of Cornwall, considered as objects of trade, are tin and copper, the former being found nowhere in the United Kingdom except in Cornwall and Devon. Both these metals occur most plentifully in the Devonian series, but for the most part in the neighborhood of granite, or of its modification, elvan. The veins of ore are arranged in groups as follows:—1. That of St. Austell, chiefly stanniferous; 2. St. Agnes, chiefly stanniferous; 3. Gwennap, Redruth, and Camborne, chiefly cupriferous; 4. Breage, Marazion, and Gwinear, of mixed character; 5. St. Just and St. Ives, mainly stanniferous. Besides tin and copper, antimony ores are found where the Devonian rocks are much traversed by traps, as at Endellion, Port Isaac, and St. Germans. Manganese is also found under similar conditions. Some lead occurs, and some small mines are worked, but with no great results; and iron, in lodes, as brown hæmatite, has been worked extensively near Lostwithiel and elsewhere. Metals occur in the lines of fault and fissure, which extend through the different geological formations of Devon and Cornwall. In Devon and in East Cornwall these lines run nearly N. and S., and are crossed by others running E. and W. In West Cornwall the lines are more bent, and the main fissures take a direction nearly parallel with the general range of land. Metallic fissures are locally termed lodes. Ores are not disseminated through all parts of the fissures in which they are found, but are gathered in patches known as "bunches of ore," the intervening portions containing strings and specks of metal, but in quantities too small to be profitably worked. It should be observed that in all lodes or fissures, whatever may be the nature of their produce, the parts most highly inclined are always the most productive. Tin occurs not only in lodes but in streams of stones and minute grains, carried from the head of the lode, where it neared the surface, apparently by some great force of water, which must have rushed from N. to S., since the great streams of tin are in all instances carried toward the S. coast. Stream tin is found immediately on the hard rocky surface of the country, and is covered by numerous tertiary deposits, which indicate that much of the coast line has been depressed and again raised, since the first deposit of the tin stones. Oxide of tin also generally occurs in the "gossan," or ochreous substance which forms the upper part of a good copper lode. The native ore from the mine or the stream-work is known as black tin. White tin is the metal after smelting. In the stream-works tin pebbles are sometimes found of 10 or 12 lb weight, and great masses of rock richly impregnated with metal have occurred weighing more than 200 lb. But the small or grain tin, as it is called, is of better quality.

Tin occurs in both granite and slate; copper for the most part in granite. The most important Cornish copper ore is the sulphuret, commonly known as grey ore by the miners; but copper pyrites, or the bisulphuret of copper, occurs far more frequently in both Cornwall and Devon. The tin of Cornwall has been known and worked from a period long before the dawn of certain history. Copper, which lies deeper in the earth, and consequently cannot be "streamed" for, was almost unnoticed in the county until

the end of the 15th century, and little attention was paid to it until the last years of the 17th. No mine seems to have been worked exclusively for copper before the year 1700; and up to that time the casual produce had been bought by Bristol merchants, to their great gain, at the rate of from £2 10s. to £4 per ton. In 1718 a Mr. Coster gave a great impulse to the trade by draining some of the deeper mines, and instructing the men in an improved method of dressing the ore. From that period the present trade in Cornish copper may be said to date its rise, the annual produce, with occasional exceptions, having until recent times progressively increased. In 1851 the mines of Devon and Cornwall together were estimated to furnish one-third of the copper raised throughout other parts of Europe and the British Isles (De la Beche). It has been calculated that the clear profits from fourteen of the most productive mines in Cornwall (both tin and copper), during the present century, have reached to £2,756,840, the value of the entire produce having been £13,158,203. From this gross sum the expenses of labor, materials, working costs, and "dues" or royalties have to be deducted. The number of years during which these fourteen mines have been worked varies from 5 to 66.

The underground wealth of Cornwall is, however, not only diminishing in quantity and quality, but the process of raising it is becoming too expensive to be continued. No copper lodes of great importance have been discovered of late years, while the surface or stream tin is nearly exhausted. Almost all the Cornish tin is now raised from deep mines at heavy expense, and has to compete with the vast supplies which arrive from foreign countries. The Cornish miners are an intelligent and independent body of men. They are in request in whatever part of the world mining operations are conducted; and it may fairly be asserted that the solution of every intricate problem in mining geology is generally assigned to a Cornish agent, and every task requiring skill, resource, and courage intrusted to a Cornish miner. About 28,000 persons used to be employed in the mines, but emigration to more remunerative fields abroad has recently reduced that number most materially. For many centuries a tax on the tin, after smelting, was paid to the earls and dukes of Cornwall. The smelted blocks were carried to certain towns to be coined,—that is, stamped with the duchy seal before they could be sold. By an Act of 1838 the dues payable on the coinage of tin were abolished, and a compensation was awarded to the duchy instead of them.

*Stannary Courts.*—By ancient charters, the tanners of Cornwall were exempt from all other jurisdiction than that of the stannary courts, except in cases affecting land, life, and limb. The earliest charter is that of Edmund earl of Cornwall, but the freedom then assured was rather confirmed than given for the first time; and it is probable that the customs of the stannary courts are of high antiquity. Twenty-four stannators were returned for the whole of Cornwall. Their meeting was termed a parliament, and when they assembled they chose a speaker. In earlier times, the combined tanners of Devon and Cornwall assembled on Hingston Down, a tract of highland on the Cornish side of the Tamar. After the charter of Earl Edmund, the Cornish stannators met (apparently) at Truro; those of Devonshire at Crocken Tor on Dartmoor. An officer was appointed by the duke of Cornwall or the Crown, who was Lord Warden of the Stannaries, and the parliaments were assembled by him from time to time, in order to revise old or to enact new laws. The last Cornish stannary parliament was held at Truro in 1752. For a long series of years little or no business was transacted in the stannary courts; but the necessity for a court of peculiar jurisdiction, embracing mines and mining transactions of every description within the county of Cornwall having become more and more apparent, a committee was appointed to report on the subject, and an Act of Parliament was afterwards (1836) passed, suppressing the law courts of the stewards of the different stannaries, and giving to the vice-warden their jurisdiction, besides confirming and enlarging the ancient equity jurisdiction of that office. Several statutes have since been passed defining and amending the stannary laws. From the judgments of the vice-warden an appeal lies to the Lord Warden, and from him to the Supreme Court of Judicature. The court, thus renewed, has greatly benefited the mining interests of Cornwall.

**Fisheries.**—The fisheries of Cornwall and Devon are the most important on the south-west coasts. The pilchard is in great measure confined to Cornwall, living habitually in deep water not far west of the Scilly Isles, and visiting the coast in great shoals,—one of which is described as having extended from Mevagissey to the Land's End, a distance, including the windings of the coast, of nearly 100 miles. In summer and autumn pilchards are caught by drift nets; later in the year they are taken off the northern coast by seine nets. Forty thousand hogsheds, or 120 million fish, have been taken in the course of a single season, requiring 20,000 tons of salt to cure them. The northern shoals are by far the largest. Twelve millions have been taken in a single day; and the sight of this great army of fish passing the Land's End, and pursued by hordes of dog-fish, hake, and cod, besides vast flocks of sea-birds, is one of the most striking that can be imagined. The fishery gives employment to about 10,000 persons, and a capital of nearly £300,000 is engaged in it. The headquarters of the fishery are Mount's Bay and St. Ives, but boats are employed all along the coast. When brought to shore the pilchards are carried to the cellars to be cured. They are then packed in hogsheds, each containing about 2400 fish. These casks are largely exported to Naples and other Italian ports—whence the fisherman's toast, "Long life to the Pope, and death to thousands." Besides pilchards, mackerel are taken in great numbers on the southern coast. Conger eels of great size, weighing from 60 to 120 lb, are found near the shores, and among other fish taken should be mentioned mullet and John Dory. Recently a brisk trade in "sardines" has been established—young pilchards taking the place of the real Mediterranean fish.

**History.**—Although there can be no doubt that Cornwall and Devonshire are referred to under the general name of Cassiterides, or the "Tin Islands," it cannot be said that we have any authentic historical knowledge of either county until after the Roman conquest of Britain. It remains uncertain whether Phœnician or Carthaginian traders actually visited Cornwall, or whether they obtained their supplies of tin through Gaul. But we know that the tin of the district was largely exported from a very early period, and that the mines were still worked under the Romans. Cornwall formed part of the British kingdom of Damnonia, which long resisted the advance of the Saxons westward, and remained almost unbroken in power until the reign of Ine of Wessex (688-726). From that time the borders of the British Kingdom gradually narrowed, until, about the year 926, Athelstane drove the Britons from Exeter, and fixed the Tamar as the limit between them and the Saxons of Devon. At this period, and perhaps for some time after, the Britons of West Wales (the name given by the Saxons to the old Damnonian kingdom) retained their line of chiefs, though under some kind of subjection to the kings of Wessex. The British bishop, Conan, submitted to archbishop Wulfhelm of Canterbury after Athelstane's conquest, and was reappointed by him in 936. The Cornish see was afterwards merged in that of Crediton, and in 1050 the place of the united sees was transferred to Exeter, where it remained till 1876. But Cornwall, although the mass of the people remained Celtic, speedily received Saxon masters, and in the Domesday Survey the recorded names of the owners of land in the days of the Confessor are all Saxon. The conqueror bestowed nearly the whole county on his half-brother, Robert of Mortain, and thus arose what Mr. Freeman styles "that great earldom and duchy of Cornwall which was deemed too powerful to be trusted in the hands of any but men closely akin to the royal house, and the remains of which have for ages formed the apanage of the heir-apparent to the crown." Of the earls, the most important were the brother of Henry III., Richard, king of the Romans, and his son Edmund. In 1336 the earldom was raised to a duchy by Edward III. in favor of his son, the Black Prince, and of his heirs, eldest sons of the kings of England. Since that time the Prince of Wales has always been duke of Cornwall. When there is no Prince of Wales the revenues of the duchy are appropriated by the Crown. When the duchy was first created by Edward III., the lands belonging to and dependent on it included not only the great open moors of Cornwall, and Dartmoor forest in Devonshire, but 9 parks, 63 manors, 10 castles, 13 boroughs and towns, and 9 hundreds. Considerable changes and reductions have, however, been since made, and the income of the duchy is at

present derived from lands in Somerset and Devon as well as in Cornwall itself. The history of the duchy is virtually that of Cornwall. There has been little to connect it with the general history of the country except during the Civil War, when Cornwall was for the most part royalist, and some sharp fighting took place within its bounds. Besides much skirmishing, there were two important battles, that of Braddock Down (Jan. 19, 1642-3), and that of Stratton (May 15, 1643), both gained for the king.

**Antiquities.**—No part of England is so rich as Cornwall in antiquities of the primæval period. These chiefly abound in the district between Penzance and the Land's End, but they occur in all the wilder parts of the country. They may be classed as follows: (1.) *Cromlechs*. These in the west of Cornwall are called "quoits," with a reference to their broad and flat covering stones. The largest and most important are those known as Lanyon, Caerwynen, Mulfra, Chûn, and Zennor quoits, all in the Land's End district. Of these, Chûn is the only one which has not been thrown down. Zennor is said to be the largest in the British Isles, while Lanyon, when perfect, was of sufficient height for a man on horseback to ride under. Of those in the eastern part of Cornwall, Trethevy, near Liskeard, and Pawton, in the parish of St. Breock, are the finest, and have remained intact. (2.) Rude unincised *menolites* are common to all parts of Cornwall. Those at Boleit, in the parish of Buryan, are the most important. (3.) *Circles*, none of which are of great dimensions. The principal are the Hurlers, near Liskeard; the Boskednan, Boscawen-on, and Tregeseal circles; and that called the Dawn-on, or Merry Maidens. All of these, except the Hurlers, are in the Land's End district. The other circles that may be mentioned are the "Trippet Stones," in the parish of Blisland, and one at Duloe. (4.) *Long alignments or avenues* of stones, resembling those on Dartmoor, but not so perfect, are to be found on the moors near Boughator and Brown Willy. A very remarkable monument of this kind exists in the neighborhood of St. Columb, called the "Nine Maidens." It consists of nine rude pillars placed in a line, while near them is a single stone known as the "Old Man." (5.) *Hut dwellings*. Of these there are at least two kinds, those in the eastern part of the county resembling the beehive structures and enclosures of Dartmoor, and those in the west comprising "hut-clusters," having a central court, and a surrounding wall often of considerable height and thickness. The beehive masonry is also found in connection with these latter, as are also (6.) *Caves*, or subterranean structures, resembling those of Scotland and Ireland. (7.) *Cliff castles* are a characteristic feature of the Cornish coast, the chief being the "Little Dinas," near Falmouth, Trevelgue, near St. Columb, and Treryn, Mên, Kenedjack, Bosigran, and others in the west. These are all fortified against the land side. (8.) *Hill castles*, or camps, are very numerous. Castle-an-Dinas, near St. Columb, is the best example of the earthwork camp, and Chûn Castle, near Penzance, of the stone.

Of early and mediæval antiquities the most noticeable are crosses, scattered all over the country, and of various dates, from the 6th to the 16th century, many resembling the early crosses of Wales; inscribed sepulchral stones of the 7th and 8th centuries, of which the "mén scriffa," in Madron is a good example; and oratories of the early Irish type. St. Pyrans is the most important of these.

The Cornish churches for the most part belong to the Perpendicular style of architecture, and are generally low in the body, but with high and plain granite towers. The rich tower of Probus, however, is an exception, as well as the church of St. Mary Magdalene at Launceston, the exterior of which is covered with sculpture. Within, the chief feature is the absence of a chancel arch. The castles of Launceston, Trematon, and Restormel seem to be of the time of Henry III., but the mounds which occur in the first two are no doubt much earlier,—possibly marking British strongholds. Tintagel has but a few shapeless walls. Of later castles there is Pendennis (built temp. Henry VIII.); St. Michael's Mount, although castellated at an early period, has nothing more ancient than the 15th century.

**Language.**—The old Cornish language survives in a few words still in use in the fishing and mining communities, as well as in the names of persons and places, but the last persons who spoke it died toward the end of the 18th century. It belonged to the Cymric division of Celtic, in which Welsh and Armorican are also included. The

most important relics of the language known to exist are three dramas or miracle plays, edited and translated by Edwin Norris, Oxford, 1859. A sketch of Cornish grammar is added, and a Cornish vocabulary from a MS. of the 13th century (Cotton MSS. Vespasian A. 14, p. 7a). The best dictionary of the language (indeed the only one) is Williams's *Lexicon Cornu-Britannicum*, London, 1865. Some valuable remarks on this ancient language will be found in Max Müller's *Chips*, vol. iii. See also CELTIC LITERATURE, vol. v. pp. 259, 281.

**Parliamentary Representation.**—The duchy returns 13 members to Parliament, 4 for the county (2 from the east division and 2 from the west division) and 9 from the following boroughs:—Truro, 2 (pop. 11,049); Penryn (pop. 3679) and Falmouth (pop. 5294), 2; St. Ives, 1 (pop. 6965); Liskeard, 1 (pop. 4700); Bodmin, the assize town, 1 (pop. 4672); Helston, 1 (pop. 3797); and Launceston, 1 (pop. 2935). The only unrepresented town of importance is Penzance, which has a population of 10,414.

**Gentleman's Seats.**—The principal houses to be noticed in Cornwall are Mount Edgcumbe (earl of Mount Edgcumbe), originally Tudor of Queen Mary's time, but much altered; the grounds and gardens are, however, more important than the house; Cotele, on the Tamar (dowager countess of Mount Edgcumbe),—a most striking place, the house Tudor, temp. Henry VIII. and Elizabeth, and little changed; it contains the ancient furniture; Antony, the seat of the Carews; Pentillie (A. Coryton, Esq.); Port Eliot (earl of St. Germans); Trelawny (Sir John Trelawny); Menabilly (Jonathan Rashleigh, Esq.); Bocomnoc (Hon. G. M. Fortescue), where are the finest woods in the county; Lanhydrock (Lord Robartes), built between 1636-1651, and containing a very picturesque gallery, with richly moulded roof; Glynn (Lord Vivian); Pencarrow (dowager lady Molesworth); Heligan (John Tremayne, Esq.); Carclew (Col. Tremayne), where the gardens are fine and interesting; Tregothnan (Viscount Falmouth); Clowence (Rev. A. H. M. St. Aubyn); and St. Michael's Mount (Sir John St. Aubyn), from its site one of the most remarkable places in Great Britain.

**Bibliography.**—Besides the works which have already been mentioned, the following are important:—*Bibliotheca Cornubiensis*, a catalogue of the writings, both MS. and printed, of Cornishmen, and of works relating to the county of Cornwall, by G. C. Bease and W. P. Courtney, London, 1874; *A Glossary of Cornish Names*, by the Rev. J. Bannister, Truro, 1871; *Report on the Geology of Cornwall, Devon, and West Somerset*, by H. T. de la Beche, London, 1839 (this report contains the most complete general view of the geology of Cornwall; valuable papers on the subject are scattered through the *Transactions of the Geol. Soc.*, and the *Journals and Reports of the Royal Institution of Cornwall*, established in 1818); *A Handbook to the Mineralogy of Cornwall and Devon*, by J. H. Collins, Truro, 1871; *Cornish Fama*, by J. Couch, Truro, n. d.; *Annual Reports of the Royal Polytechnic Society of Cornwall*, established 1833. Of county histories the earliest is Carew's *Survey of Cornwall*, first published in 1602. The collections of Hals and Tonkin were partly printed by Davies Gilbert in 1838, with additions of his own, under the title of *The Parochial Hist. of Cornwall*. Lyson's *Cornwall*, 1814, remains the most useful and most accurate history of the county. *The Parochial and Family History of the Deanery of Trigg Minor*, by Sir John Maclean, London, 1873, &c. (published in parts) is exhaustive for that division. The folk lore of Cornwall is well illustrated in *Popular Romances and Drolls of the West of England*, by R. Hunt, London, 1865; and in *Traditions and Hearthside Stories of West Cornwall*, by W. Bottrell, Penzance, 1870-3. *Murray's Handbook for Cornwall and Devon*, 8th ed., 1872, is also a work well worth consultation. On the antiquities of the county the following authorities are important:—Dr. W. Borlase's *Antiquities of Cornwall*, 1754 and 1769; W. C. Borlase's *Nenia Cornubia*, 1872, and a paper by the same author in the *Archæol. Journ.*, vol. xxx., on "Vestiges of Early Institutions in Cornwall;" Blight's *Ancient Crosses of Cornwall*, 1858; Hadda and Stubbs' *Councils*, vol. i.; Blight's *Churches of West Cornwall*, 1865. (R. J. K.)

**CORNWALL, BARRY.** See PROCTER.

**CORNWALLIS, CHARLES, SECOND EARL AND FIRST MARQUESS (1738-1805)**, was the eldest son of Charles, the first earl Cornwallis. Having been educated at Eton and St. John's College, Cambridge, he entered the army. For some time he was member of Parliament for Eye; in 1761 he served a campaign in Germany, and was gazetted to a lieutenant-colonelcy in the 12th Foot. In 1762 he succeeded to the earldom and estates of his father; in

1765 he was made aide-de-camp to the king and gentleman of the bedchamber; in 1766 he obtained a colonelcy in the 33d Foot; and in 1770 he was appointed governor of the Tower. In public life, he was distinguished by independence of character and inflexible integrity; he voted without regard to party, and opposed the ministerial action against Wilkes and in the case of the American colonies. But when the War of Independence broke out, he accompanied his regiment across the Atlantic, and served not without success as major-general. In 1780 he was appointed to command the British forces in South Carolina, and in the same year he routed Gates at Camden. In 1781 he defeated Greene at Guilford, and made a destructive raid into Virginia; and in 1781 he was besieged at York Town by French and American armies and a French fleet, and was forced to capitulate. With him fell the English cause in the United States. He not only escaped censure, however, but in 1786 received a vacant garter, and was appointed governor-general of India and commander-in-chief in Bengal. As an administrator he projected many reforms, but he was interrupted in his work by the advance of Tippoo Sahib. In 1791 he assumed in person the conduct of the war and captured Bangalore; and in 1792 he laid siege to Seringapatam, and concluded a treaty with Tippoo Sahib, which stripped the latter of half his realm, and placed his two sons as hostages in the hands of the English. For the Permanent Settlement of the Land Revenue under his administration, see BENGAL, vol. iii. p. 492. He returned to England in 1793, received a marquise and a seat in the Privy Council, and was made master-general of the ordnance with a place in the Cabinet. Five years afterwards (21st June, 1798) he was appointed to the viceroyalty of Ireland, and the zeal with which he strove to pacify the country gained him the respect and good-will of both Roman Catholics and Orangemen. On 17th July a general amnesty was proclaimed, and a few weeks afterwards the French army under Humbert was surrounded and forced to surrender. In 1801 Cornwallis was replaced by Lord Hardwicke, and soon after he was appointed plenipotentiary to negotiate the treaty of Amiens (1802). In 1805 he was again sent to India as governor-general. He was in ill-health when he arrived at Calcutta, and while hastening up the country to assume command of the troops, he died at Ghazepore, in the province of Benares, October 5, 1805.

**CORO**, or **SANTA-ANA DE CORO**, a maritime town of Venezuela, South America, and capital of the province of Falcon, is situated in a sandy plain at the inner angle of a peninsula, dividing the Gulf of Venezuela from the Caribbean Sea, 155 miles W.N.W. of Valencia. It is ill built, the streets are unpaved, and there are no public buildings of consequence except two churches. The climate is hot but not unhealthy. The water-supply is brought by mules from springs at some distance from the town. About seven miles to the north-east is the port, near the mouth of the little Rio Coro. The export trade with the West Indies, in mules, goats, hides, cheese, pottery-ware, indigo, and cochineal, is considerably less than formerly. Coro is one of the oldest settlements of the Spaniards on the north coast of S. America. It was founded on the 26th July, 1527 (St. Ann's day), by Juan de Ampués, who named it Santa Ana de Coriana after the Indian tribe inhabiting the spot. It came also to be known as Venezuela (or Little Venice), which was the name given originally to an Indian village founded on piles in the water on the east side of the lake of Maracaibo. In 1578 Caracas was made the seat of the government of the country instead of Coro, and in 1583 the bishopric of Coro, founded in 1536, was transferred thither. In 1815 Coro was made the chief town of a province. It suffered greatly in the Venezuelan war of independence. Population about 7000.

**COROMANDEL COAST**, the eastern seaboard of India between Cape Calimere, in 10° 17' N. lat. and 79° 56' E. long., and the mouths of the Kistnah or Krishnah. The shore, which is shallow, is without a single good natural harbor, and is at all times beaten by a heavy sea. Communication with ships can be effected only by catamarans and flat-bottomed surf-boats. The north-east monsoon, which lasts from October till April, is exceedingly violent for three months after its commencement. From April till October hot southerly winds blow by day; at night the heat is tempered by sea-breezes. The principal places

<sup>1</sup> But on the third day after the battle, pursued by Greene, he fled to Wilmington.—AM. ED.

frequented by shipping are Pulicat, Madras, Sadras, Pondicherry, Cuddalore, Tranquebar, Nagore, and Nagapatnam. The name Coromandel is said to be derived from *Chola-mandal*, the mandal or region of the ancient dynasty of the Chola.

CORONA, in astronomy, the name given to the phenomenon seen round the sun during a total eclipse. This phenomenon is doubtless a complex one, and comprises effects due (1) to the sun's surroundings or the various layers of its atmosphere, (2) to the sunlight falling on something between us and the sun, and (3) to certain physiological effects in the eye. These effects will be discussed under the heading SUN. In the meantime it may be stated that the solar part of the phenomenon comprises the *chromosphere*, the layer of brightly incandescent hydrogen, with other included metallic vapors, which lies immediately over that interior part of the sun which we ordinarily see; the *prominences* or *red flames*, which are local uprisings of the chromosphere; and outside all, the *coronal atmosphere*, which consists, so far as is yet known, of hydrogen less brightly incandescent than that in the chromosphere, and of an unknown substance, the vapor density of which appears to be less than that of hydrogen.

CORONATION, literally a crowning, a placing of a crown on the head. The word is restricted, in use, to the ceremony or solemnity of placing a crown on the head of an actual or future king or emperor to signify his accession or his formal recognition as actual or future sovereign. The custom of marking the commencement of a king's reign by some special rite is a very ancient one. The Jewish kings, like the Jewish high priests, were anointed; but, as the crown was among the insignia of their new royalty, it is probable that they were also crowned, and in some cases certain that they were. We read, for example, of the crowning as well as of the anointing of King Josiah (2 Kings xi. 12), and when David, or rather Joab, had subdued Rabbah, the crown which the king of Rabbah had worn was taken from him, and placed upon David's head. We find among the nations of modern Europe a tolerably exact counterpart of all these observances. After the destruction of the western Roman empire, the tribal chiefs or kings among whom the Roman territory was divided appear generally to have been crowned on their accession or election to office. This was customary, we know, among the Franks, the Lombards, and the Burgundians, as it was also among our own Saxon ancestors. The revival of the empire by Charlemagne was marked by his solemn coronation at Rome by the Roman Pontiff. His successors in the empire for more than three hundred years were, without exception, inaugurated in the same way. The rule was followed, though not invariably, for some time afterwards, most of the emperors up to the time of Frederick III. (1440) being crowned, as Charlemagne had been, at Rome. On the day before the coronation, the Roman elders met the emperor-elect at the gate of their city, had their charters confirmed by him, and received an oath from him that he would preserve their good customs. On the next day the emperor went to Saint Peter's, and was there met by the Pope and his clergy, and was solemnly blessed and crowned. From Frederick III. downwards, this custom, always distasteful to the Roman people, wholly ceased to be observed. Charles V. received the imperial crown at the Pope's hands, not at Rome but at Bologna, and at the same time with the Lombard or Italian crown. There were, besides the imperial crown, three other distinct crowns, some or all of which were assumed by each emperor according to his respective rights. The German crown, which by the time of Charles V. had become the most important of the four, was taken at Aix-la-Chapelle; the Lombard or Italian crown generally at Milan; and the Burgundian crown, of less importance than the other two, at Arles. Charlemagne, uniting in his own person what were always distinguishable and what became afterwards distinct sovereignties, took them all four. Charles V. took first the German crown at Aix-la-Chapelle. It was not until 1530 that he took his other two crowns at Bologna. From the time of Charles V., down to the close of the empire in 1806, every emperor bound himself at his accession that he would proceed to Rome, and receive the imperial crown from the Pope, but as a matter of fact no one of them complied with the obligation.

We have clear traces of the coronation of the English

kings before the Conquest, though, as in the case of the Jewish kings, we read of their being anointed more frequently than we read of their being crowned. Bath, Winchester, or Kingston-upon-Thames was the place commonly chosen for the rite. After the foundation of Westminster Abbey by Edward the Confessor, Westminster succeeded to the privilege to the exclusion of the others. Harold, we read, was made king at Westminster, and so was William I. Of the actual crowning of the kings before William there are sometimes precise notices by the chroniclers, and the ceremony itself is sometimes to be found represented on medals. That the king was hallowed or anointed is, however, the phrase generally employed; but that crowning also was an essential part of the rite we may infer from the case of William I., of whom we are told that Archbishop Aldred hallowed him to king at Westminster, and also swore him, ere that he would set the crown on his head, that he would as well govern the nation as any king before him best did. For some time the archbishops of Canterbury claimed the sole right of crowning, personally or by deputy. Becket made it a cause of complaint against Henry II. that he had not been called in to crown Henry's son, and he even procured the excommunication of the archbishop of York and the bishop of Durham for having acted in the matter without his license. It was usual with the early Norman kings to be crowned more than once, and also, as we have seen in Henry II.'s case, to have their sons crowned, and oaths of allegiance taken to them during their own lifetime. The reader will be reminded here of the case of David and Solomon, though he may refer the resemblance to nothing more than an accidental choice of the same obvious means to secure a disputable succession. He will find, however, in some parts of the English coronation rite traces of its Jewish original not so easily to be explained away.

The coronation of Richard I. is the earliest of which we have a circumstantial account. The archbishop of Canterbury officiated at it, and with him were the archbishops of Rouen, of Treves, and of Dublin, and all the bishops of the kingdom. The king was accompanied to the abbey by a grand procession of nobles, and among them came the earl of Chester bearing the royal crown. When the crown had been laid on the altar, and the coronation oath had been taken by Richard, next came the actual ceremony of coronation, or rather the long series of ceremonies of which the placing of the crown on Richard's head formed a part. After Richard had drawn near to the altar, his head was first covered with a sacred linen cap. He was then anointed in several places. The great crown was then brought to him, and was by him handed to the archbishop, who placed it on the king's head. After various further rites and prayers, the king left the altar and went back to his former seat, and there exchanged the great crown for a lesser crown, which he continued to wear when he left the abbey.

The doubtful title of Henry IV. was confirmed by a double ceremony. The already crowned king, Richard II., was brought to the Tower of London in his coronation robes, holding in his hands his crown and other royal insignia. These he resigned into the hands of Henry, then duke of Lancaster. The public assumption of them by Henry was made afterwards with great splendor. On the day appointed, after having confessed and heard three several masses, he went to Westminster Abbey with a vast procession of nobles and clergy. A high scaffolding was erected in the abbey, and on this Henry was displayed to the people, seated, and with his head bare. The archbishop of Canterbury then demanded of the assembly whether he should crown Henry, and was answered by general shouts of yes, yes. Henry then drew near to the altar, and was first anointed by the archbishop in six places. The crown of Edward the Confessor was then brought forward, blessed by the archbishop, and placed by him upon Henry's head. Mass was then again said, and the king and his attendants left the abbey. Henry VI. was twice crowned while he was still a child, first at the abbey at Westminster, afterwards at Saint Denis near Paris. Representations of the two ceremonies are to be found in Strutt's *Manners and Customs*. The coronation of Richard III. has also been very fully recorded. It does not differ materially from the instances already given. The directions followed, both in these cases and subsequently, are taken from the *Liber Regalis*, in the archives of Westminster Abbey; nor, in-

dead, from the nature of the case is there much room for variety in essentials. The anointing and crowning may be accompanied by circumstances of more or less magnificence, but the acts themselves are likely to be done in much the same way at one time and at another.

**Coronation Oath.**—The imposition of some form of coronation oath appears to be as old as the ceremony of coronation. It is natural enough that, at the commencement of each new reign, the king and people should mutually give and receive pledges from each other, the people promising obedience to lawful commands, the king binding himself to act with justice and to observe the established laws. There are informal traces of this to be found in abundance in the histories of the Jewish kings. It was still more regularly the case among the tribal chiefs who broke up the western Roman empire, and established themselves upon its ruins. Hereditary title was far from absolutely recognized, and the will of the people had a most potent influence in determining the succession. There was thus room for something like an express bargain, the new chief or king receiving his dignity on conditions which his people imposed upon him. The custom thus established continued after the rules of succession had become settled. The election to the imperial office was marked in the same way. Before the time of Charles V. a verbal promise had been thought sufficient, but on Charles's election a formal "capitulation" of rights and liberties was drawn up in writing by the German electors, signed by the new emperor's ambassadors, and solemnly confirmed by himself on his coronation at Aix-la-Chapelle. From that time forward the same conditions were observed at each election, the attacks by Charles V. upon the rights of his German subjects not having convinced them of the intrinsic worthlessness of agreements of the kind. We have seen already the form of coronation oath prescribed to William I. of England, and we know, too, the amount of regard he paid to it. Richard I. was sworn to keep the holy ordinances of God, to exercise justice, to abolish grievous laws, and to put in practice all laws that were good. The *Liber Regalis* prescribes a series of similar oaths. The king is to grant and to confirm the laws and customs of his predecessors, and especially those of the glorious king Saint Edward. He promises peace and agreement to God, the holy church, and the people, and swears further, with a vast amount of verbiage, to maintain law and justice, to uphold customs, and to perform rightly all the other duties of his office. The modern form of the coronation oath dates from the coronation of William and Mary in 1689, with some slight necessary alterations and additions made afterwards at the Unions with Scotland and with Ireland. The oath, in 1689, was made at every point more precise and explicit than before; and, in particular, there was added an express engagement on the part of the sovereign to maintain "the laws of God, the true profession of the Gospel, and the Protestant reformed religion as it is established by law." It provided, further, that the king should preserve to the bishops and clergy, and the churches committed to their charge, all their actual and future legal rights and privileges. Its intention, as the debates at the time prove, is to restrain the king in his administrative, not in his legislative, capacity. It binds him to observe the established law. It does not and cannot bind him to refuse his assent to all subsequent changes of the law in ecclesiastical any more than in civil matters. The point, obvious enough in itself, deserves notice chiefly because the opposite view was taken by George III., fatally for Pitt's project of Catholic emancipation, a measure of relief to which it is difficult to see how the Coronation oath, whatever force is given to it, could with any reason be thought opposed. In connection with the subject of coronation, see also CROWN. (S. H. R.)

**CORONELLI, VINCENZO** (1650-1718), an Italian geographer, was born at Venice. Having by his skill in mathematics become known to the Count d'Estrées, Coronelli was employed by the count to make globes for Louis XIV. In 1685 he was appointed cosmographer to the republic of Venice, and four years afterwards public professor of geography. He founded an academy of cosmography at Venice, and died in that city in 1718. He published about 400 geographical charts, an abridgment of cosmography, several books on geography, and other works. See Tiraboschi, *Litteratura Italiana*.

**CORONER**, an ancient officer of the common law, so called, according to Coke, because he had principally to do

with pleas of the Crown. The lord chief justice of the Queen's Bench is said to be the principal coroner of the kingdom, and may in any place exercise the jurisdiction of the coroner. The duties of the office are now practically confined to holding inquests in case of violent or sudden death.

The office is and always has been elective, the appointment being made by the freeholders of the county assembled in county court. By the Statute of Westminster the First it was ordered that none but lawful and discreet knights should be chosen as coroners, and in one instance a person was actually removed from office for insufficiency of estate. Lands to the value of £20 per annum (the qualification for knighthood) were afterwards deemed sufficient to satisfy the requirements as to estate which ought to be insisted on in the case of a coroner. The complaint of Blackstone shows the transition of the office from its original dignified and honorary character to a paid appointment in the public service. "Now, indeed, through the culpable neglect of gentlemen of property, this office has been suffered to fall into disrepute, and get into low and indigent hands; so that, although formerly no coroners would condescend to be paid for serving their country, and they were by the aforesaid Statute of Westminster expressly forbidden to take a reward, under pain of a great forfeiture to the king; yet for many years past they have only desired to be chosen for their perquisites; being allowed fees for their attendance by the statute 3 Henry VII. c. 1, which Sir Edward Coke complains of heavily; though since his time those fees have been much enlarged." The mercenary character of the office, thus deprecated by Coke and Blackstone, is now firmly established, without, however (it need hardly be said), affording the slightest ground for such reflections as the above. The coroner is in fact a public officer, and like other public officers receives payment for his services. The person appointed is almost invariably a qualified legal or medical practitioner, the duties of the office being supposed to require some acquaintance with the learning of both of these professions. The property qualification appears to be virtually dispensed with, the county being liable for any penalties that may be incurred by the coroner. The appointment is held for life, but is vacated by the holder being made sheriff. He may also be removed by the writ *de coronatore exonerando*, for sufficient cause assigned, as, for instance, that he is engaged in other business, or incapacitated by old age or sickness, &c. By 23 and 24 Vict. c. 116, the lord chancellor may remove any coroner for "inability or misbehavior in his office."

The coroner is primarily an officer of the county, elected by the freeholders. In certain liberties and franchises the appointment is made by the Crown, or lords holding a charter from the Crown. By the Municipal Corporations Act, in any borough having a separate quarter-sessions the council may appoint a coroner; in other boroughs the coroner for the county has jurisdiction.

The remuneration of the county coroner is now regulated by the Act 23 and 24 Vict. c. 116 above mentioned. The system of payment by fees, established by an earlier Act of the same reign is abolished, and payment is to be made by salary calculated on the average amount of the fees, mileage, and allowances usually received by the coroner for a period of five years, and the calculation is to be revised every five years. The home secretary is to decide between the coroner and the justices when they cannot agree. Borough coroners under the Municipal Corporations Act are to be paid by fees.

The duties of the office are ascertained by the 4 Edward I. st. 2:—"A coroner of our lord the king ought to inquire of these things, first, when coroners are commanded by the king's bailiffs or by the honest men of the county, they shall go to the places where any be slain, or suddenly dead or wounded, or where houses are broken, or where treasure is said to be found, and shall forthwith command four of the next towns, or five, or six, to appear before him in such a place; and when they are come thither, the coroner upon the oath of them shall inquire in this manner, that is, to wit, if it concerns a man slain, if they know when the person was slain, whether it were in any house, field, bed, tavern, or company, and if any, and who, were there, &c. It shall also be inquired if the dead person were known, or else a stranger, and where he lay the night before. And if any person is said to be guilty of the murder

the coroner shall go to their house and inquire what goods they have, &c." Similar directions are given for cases of persons found drowned or suddenly dead, for attachment in criminal cases of violence, &c. It is the duty of the township to give notice of violent or sudden death to the coroner; and the inquisition is held before him and a jury of not less than twelve persons, constituting a court of record. Their charge is to inquire how the party came by his death. The inquisition must be *super visum corporis*; if the body be not recovered, the coroner can only sit in virtue of a special commission. By 6 and 7 Vict. c. 12, it was provided (in remedy of the inconveniences of the common law) that the coroner only within whose jurisdiction the body shall be lying dead shall hold the inquest, although the cause of death may have happened somewhere out of his jurisdiction. And in the case of any body found dead in the sea, &c., the inquest, in the absence of a deputy coroner for the admiralty, shall be held by the coroner of the place where the body is first brought to land.

At the inquest the evidence is taken on oath, and the Crown or any party suspected may tender evidence. The medical man attending the deceased, if any, may be ordered to attend, and the coroner may order a *post-mortem* examination. If the jury are not satisfied they may name any properly-qualified practitioner, who shall be required to attend and give evidence, or make a *post-mortem* examination. The verdict must be that of twelve at least of the jury. If any person is found guilty of murder or other homicide, the coroner shall commit him to prison for trial; he shall also certify the material evidence to the court, and bind over the proper persons to prosecute or to give evidence at the trial. He may in his discretion accept bail for a person found guilty of manslaughter. Since the abolition of public executions, the coroner is required to hold an inquest on the body of any criminal on whom sentence of death has been carried into effect. The question of reopening the coroner's inquests after verdict given was discussed in a recent case. The Queen's Bench, on a suggestion on the part of the Crown that there was a probability of fixing the suspected crime by further inquisition, ordered the verdict to be quashed and a new inquest to be held.

There has been of late years much discussion on the subject of the coroner's office, and legislation at no distant time may be expected. The points on which reform is generally asked for may be briefly indicated. It is desirable that the qualification for the office should be fixed, and that it should be a legal and not a medical qualification. The duties of the office are mainly judicial; such medical information as may be necessary can be had from experts; while of course a knowledge of the technical rules of evidence is essential to the efficient discharge of the coroner's duties. Again, that the election to a judicial office, wholly unpolitical in character, should be by vote of the freeholders of the county is generally felt to be an anomaly. A county coroner recently declared that the expense of contesting the county amounted, in his own case, to several thousand pounds. Payment, depending directly or indirectly on fees, also produces unfortunate results. It leads occasionally to disputes between the coroners and the justices, and exposes the former to the suspicion of holding unnecessary inquests for the sake of increasing their income. In any circumstances the propriety of holding an inquest may be a question of great delicacy, and a slight mistake on either side may subject the officer to unmerited obloquy. In some cases the present state of the law involves the great evil of too much inquiry. Besides the coroner's inquest there are, in cases of a criminal character, the public examination before a magistrate, and the private examination by the grand jury. But it may also happen that not merely one but two or more inquests may be held in the same matter. In the case of a railway accident or a collision at sea, the victims may die in different jurisdictions, and if there is a suspicion of criminal negligence, the accused party must practically stand his trial several times over. He may even be acquitted by one jury and condemned by another.

There is no corresponding office in Scotland. (E. R.)

COROT, JEAN BAPTISTE CAMILLE (1796-1875), French landscape-painter, was born at Paris in July, 1796. He received an ordinary school education at Rouen, and was then apprenticed to a Paris draper. From childhood it was evident that he was a born artist; but prudential motives induced his father sternly to repress the strivings and utterances of his genius. He continued therefore to drudge at the draper's counter till his twenty-sixth year. He then finally escaped from the grip of trade, and his genius had its own way in the world. He entered the atelier of Michallon; and on the death of his master the

same year (1822) he passed to that of Victor Bertin. But he did not get on happily with, or learn much from either of these teachers. At length he made his escape from the town and the school with their oppressive conventionalities, and took refuge with nature in the fields of Italy. Here he studied, dreamed, and painted for several years. In 1827 he began to exhibit at the Salon, his first works being *Vue prise à Narni* and *La Campagne de Rome*. The public passed them by without much notice, but artists saw in them decisive proof that a new poet-painter was among them. From this time he worked on vigorously for nearly fifty years, seldom failing to make his appearance at the Salon. Public recognition and "golden joys" were very slow to come; nor was it till he was nearly seventy that he became a wealthy man. He had obtained a medal of the second class in 1833, and medals of the first class in 1848 and 1855. He received the cross of the Legion of Honor in 1846, and was promoted officer in 1867. Corot was one of the most original of painters. He was almost exclusively a landscape-painter; for although in a very few cases his pictures bear historical titles, landscape is even in these the predominant element. And with him it was always the poetry of landscape, never the topography. He stood in nature's presence, reverent, loving, enthusiastic, watching for the most delicate effects and changes of light, especially at early dawn and at dewy eve and in still moonlight, on cloud and sky, on tree and stream,—seeing thus what but few eyes do see, and ever striving to reproduce in his works his own impressions of magical dreamy beauty. His works, like those of Millet, are mostly touched with sadness; but while Millet is stern and almost savage, Corot is always tender and delicate. In his chosen field he stands almost alone and unrivalled. Among his works are—*Vue d'Italie* (1834); *Souvenir des environs de Florence* (1839); *La Daase des Nymphes*; *Soleil couchant dans le Tyrol* (1850); *Effet de Matin*; *Dante et Virgile*; *Macbeth*; *Agar au Désert*; *Soleil levant*; *Souvenir d'Italie*; *Le Repos*; *La Solitude* (1866); *Un Matin à Ville d'Avray* (1868); *Une Danse Antique*; and *Le Bûcheron*. The two last mentioned were exhibited, after his death, at the Salon of 1875. In the social circle Corot was one of the frankest and most genial of men. His favorite relaxation after a long day's work was the theatre, where to the last he is said to have followed the performance with the fresh delight of a child. Naturally of a generous disposition, he gave away with a large hand the wealth which flowed in on him in his later years; and many a touching tale is told of distress relieved and sad hearts comforted by his ministrations. The affectionate regard generally felt towards him is shown in the designation "le Père Corot" by which he was commonly known. In 1874 he lost a beloved sister; and after this sharp blow he never recovered his former gaiety of heart. One of his last acts was the gift of a pension to the widow of his brother artist Millet, who had died not long before. In December, 1874, a gold medal designed for the occasion was presented to him by many French artists in token of honor and esteem. Corot died at Paris, after a long period of failing health, February 22, 1875.

CORPORATION. A corporation is an association of persons which the law treats in many respects as if it were itself a person. It has rights and duties of its own which are not the rights and duties of the individual members thereof. Thus a corporation may own land, but the individual members of the corporation have no rights therein. A corporation may owe money, but the corporators as individuals are under no obligation to pay the debt. The rights and duties descend to the successive members of the corporation. This capacity of perpetual succession is regarded as the distinguishing feature of corporations as compared with other societies. One of the phrases most commonly met with in law books describes a corporation as a society with perpetual succession and a common seal. The latter point, however, is not conclusive of the corporate character.

The legal attributes of a corporation have been worked out with great fulness and ingenuity in English law, but the conception has been taken full-grown from the law of Rome. The technical term in Roman law corresponding to our corporation is *collegium*; a more general term is *universitas*. A *collegium* or *corpus* must have consisted of at least three persons, who were said to be *corporati*—*habere corpus*. They could hold property in common and had a common chest. They might sue and be sued by the



agent (*syndicus* or *actor*). There was a complete separation in law between the rights of the *collegium* as a body and those of its individual members. The *collegium* remained in existence although all its original members were changed. It was governed by its own by-laws, provided these were not contrary to the common law. The power of forming *collegia* was restrained, and societies pretending to act as corporations were often suppressed. In all these points the *collegia* of Roman closely resemble the corporations of English law. There is a similar parallel between the purposes for which the formation of such societies is authorized in English and in Roman law. Thus among the Roman *collegia* the following classes are distinguished:—(1) Public governing bodies, or municipalities, *civitates*; (2) religious societies, such as the *collegia* of priests and Vestal Virgins; (3) official societies, *e. g.*, the *scribes*, employed in the administration of the state; (4) trade societies, *e. g.*, *fabri, pictores, navicularii*, &c. This class shades down into the *societates* not incorporated, just as our own trading corporations partake largely of the character of ordinary partnerships. In the later Roman law the distinction of corporations into civil and ecclesiastical, into lay and eleemosynary, is recognized. The latter could not alienate without just cause, nor take land without a license—a restriction which may be compared with our statutes of mortmain. All these privileged societies are what we should call *corporations aggregate*. The *corporation sole* (*i. e.*, consisting of only a single person) is a refinement of our own, for although Roman law held that the corporation subsisted in full force, notwithstanding that only one member survived, it did not impute to the successive holders of a public office the character of a corporation. When a public officer in our law is said to be a corporation sole, the meaning is that the rights acquired by him in that capacity descend to his successor in office, and not (as the case is where a public officer is not a corporation) to his ordinary legal representative. The best known instances of corporation sole are the king and the parson of a parish. The conception of the king as a corporation is the key to many of his paradoxical attributes in constitutional theory—his invisibility, immortality, &c.

The Roman conception of a corporation was kept alive by ecclesiastical and municipal bodies. When English lawyers came to deal with such societies, the corporation law of Rome admitted of easy application. Accordingly, in no department of our law have we borrowed so copiously and so directly from the civil law. The corporations known to the earlier English law were mainly the municipal, the ecclesiastical, and the educational and eleemosynary. To all of these the same principles, borrowed from Roman jurisprudence, were applied. The different purposes of these institutions brought about in course of time differences in the rules of the law applicable to each. In particular, the great development of trading companies under special statutes has produced a new class of corporations, differing widely from those formerly known to the law. The reform of municipal corporations effected by the Act of 1837 has also restricted the operation of the principles of the older corporation law. These principles, however, still apply when special statutes have not intervened. But the extent and importance of Parliamentary legislation on corporations have withdrawn the attention of writers from corporation law pure and simple, and there has been no book on that subject since Mr. Grant's, published in 1850. Two earlier treatises by Mr. Kyd and Mr. Willcocks may be mentioned. American lawyers have dealt more satisfactorily with corporations, and special reference may be made to Abbott's *Digest of Corporation Law*.

The legal origin of corporation is ascribed by Grant to five sources, *viz.*, common law, prescription, Act of Parliament, charter, and implication. Prescription, in legal theory, implies a grant, so that corporations by prescription would be reducible to the class of chartered or statutory corporations. A corporation is said to exist by implication when the purposes of a legally constituted society cannot be carried out without corporate powers. Corporations are thus ultimately traceable to the authority of charters and Acts of Parliament. The power of creating corporations by charter is an important prerogative of the Crown, but in the present state of the constitution, when all the powers of the Crown are practically exercised by Parliament, there is no room for any jealousy as to the manner in which it

may be exercised. The power of chartering corporations belonged also to subjects who had *jura regalia*, *e. g.*, the bishops of Durham granted a charter of incorporation to the city of Durham in 1565, 1602, and 1780, and the last was the charter in operation up to the passing of the Municipal Corporations Act. The charter of a corporation is regarded as being of the nature of a contract between the king and the corporation. It will be construed more favorably for the Crown, and more strictly as against the grantee. It cannot alter the law of the land, and it may be surrendered, so that, if the surrender is accepted by the Crown and enrolled in Chancery, the corporation is thereby dissolved. The use made of this power of the Crown in the reigns of Charles II. and James II. will be familiar to most readers. Chartered corporations were originally held to be *ex necessitate* immortal; only a statute could give a society corporate privileges to ensue for a limited time. But now, by 1 Vict. c. 77 § 29, the Crown may incorporate for any period.

Every corporation, it is said, must have a name, and it may have more names than one, but two corporations cannot have the same name. And corporations cannot change their name save by charter or some equivalent authority.

The possession of a common seal, though, as already stated, not conclusive of the corporate character, has been held to be an incident of every corporation aggregate. The ins of court have common seals, but they are only voluntary societies, not corporations. Generally speaking, all corporate acts affecting strangers must be performed under the common seal; acts of internal administration affecting only the corporators, need not be under seal. The rule has been defended by high judicial authority as following necessarily from the impersonal character of a corporation; either a seal or something equivalent must be fixed upon so that the act of the corporation may be recognized by all. In the matter of contracts, however, the strict rule of law has been found untenable. A large exception has long been recognized by the courts. In cases of "convenience almost amounting to necessity," the use of the seal will not be necessary in order to bind a corporation. Examples given in the old cases of such convenience are the retainer of an inferior servant, authority to make a distress, to drive away cattle damage feasant, &c. This exception has been extended in different degrees in different classes of corporations. In trading corporations it has been lately held that it will include all contracts entered into for the purposes for which the society was incorporated, and will not be limited to matters of constant occurrence or small importance. In other corporations the same latitude does not appear to be encouraged by the decisions. Goods of a kind which must have been necessary from time to time, and actually supplied to a corporation under a contract not sealed, may be sued upon; but an engagement as clerk to a workhouse was held not binding on a board of guardians because not under their seal. And where a municipal corporation caused some tolls to be let by auction, they were not allowed to recover on the contract because it was not under their seal; and work done for local improvements, under an unsealed contract, was held to give no claim against a corporation. In such cases the fact of the contract being executed makes no difference as against the corporation, but where the corporation has executed an unsealed contract it may recover thereon.

The somewhat unsatisfactory principles as to the dissolution of corporations are not now of much practical importance. A corporation may of course be abolished by statute, but not by the mere authority of the Crown. It is held that a corporation may become extinct by the disappearance of all its members or of any integral part, or by surrender of charter if it is a chartered society, or by process of law for abuse of powers. In such cases the real property of the corporation will go to the heir of the founder, and the personal property as *bona vacantia* to the Crown. Corporations created by statute cannot surrender, nor will they be suffered to avoid elections so as to become extinct for want of members.

The power of the majority to bind the society is one of the first principles of corporation law, even in cases where the corporation has a head. It is even said that only by an act of Parliament can this rule be avoided. The binding majority is that of the number present at a corporate meeting duly summoned. Votes given for an illegal pur-

pose or a disqualified person are considered as thrown away, and in an election votes must be given for some particular candidate,—if they are merely *against* a candidate they are void.

In corporations which have a head (as colleges), although the head cannot veto the resolution of the majority, he is still considered an integral part of the society, and his death suspends its existence, so that a head cannot devise or bequeath to the corporation, nor can a grant be made to a corporation during vacancy of the headship.

A corporation has power to make such regulations (by-laws) as are necessary for carrying out its purposes, and these are binding on its members and on persons within its local jurisdiction if it has any. Such by-laws must not be at variance with the law of the land, nor retrospective in their operation, nor unreasonable. They must further be in harmony with the objects of the society, and must not infringe or limit the powers and duties of its officers. A by-law to compel the giving of a dinner was held to be invalid unless it could be shown that the interest of the corporation was to be promoted thereby.

The power to acquire and hold land was incident to a corporation at common law, but its restriction by the statutes of mortmain dates from a very early period. The English law against mortmain was dictated by the jealousy of the feudal lords, who lost the services they would otherwise have been entitled to, when their land passed into the hands of a perpetual corporation. The vast increase in the estates of ecclesiastical corporations constituted by itself a danger which might well justify the operation of the restricting statutes. Accordingly, in Magna Charta (9 Hen. III. c. 36) there is a clause against the granting of land to religious houses. The statute 7 Edward I. st. 2, c. 1 (*De Religiosis*), and the Statute of Westminster the Second extended by 15 Richard II. c. 5, prohibited corporations from buying land in mortmain under penalty of forfeiture. The next lord might enter within a year, and each succeeding lord had half a year, and for default of intermediate lord the king should have the lands for ever. If the king and the lords waived their rights, the corporation could hold the land without question. Hence a practice grew up for the king to grant to a corporation a license to hold the lands given to it; and this, although strictly speaking a waiving of the king's rights, was in course of time held sufficient to bar the *reue* lord's right also. Its power to do so was expressly confirmed by 7 and 8 Will. III. c. 37,—not that there was any doubt about it in practice, but to avoid the hateful example of anything like a power in the crown to suspend the laws. A licensed corporation can hold lands to the extent of its license.

The Mortmain Acts applied only to cases of alienation *inter vivos*. There was no power to devise lands by will until 32 Henry VIII. c. 1 (explained by 34 and 35 Henry VIII. c. 5), and when the power was granted corporations were expressly excluded from its benefits. No devise to a corporation, whether for its own use or in trust, was allowed to be good; land so devised went to the heir, either absolutely or charged with the trusts imposed upon it in the abortive devise. A modification, however, was gradually wrought by the judicial interpretations of the Charitable Trusts Act 43 Elizabeth c. 4, and it was held that a devise to a corporation for a charitable purpose might be a good devise, and would stand unless voided by the Mortmain Acts;—so that no corporation could take land, without a license, for any purpose or in any way; and no licensed corporation could take lands by devise, save for charitable purposes. Then came the 9 George II. c. 36, commonly but improperly called the Mortmain Act. Its effect is generally to make it impossible for land to be left by will for charitable uses, whether through a corporation or natural person.<sup>1</sup> The new Wills Act does not renew the old provision against devises to corporations, which therefore fall under the general law of mortmain. The result is simply that corporations cannot take land for any purpose without a license, and that neither corporations nor natural persons can take land by devise for charitable uses (see CHARITIES). The policy of the law of mortmain may be compared with the rule against perpetuities—a rule which forbids the operation of settlements purporting to regulate

<sup>1</sup> Devises to colleges are excepted from the operation of the Act, but such devises must be for purposes identical with or closely resembling the original purposes of the college; and the exception from this Act does not supersede the necessity for a license in mortmain.

the devolution of land for ever. The longest period for which the law will allow the future disposition of land to be tied up is a life or lives in being, and twenty-one years thereafter.

The power of corporations at common law to alienate their property is a question of much greater difficulty, and no satisfactory solution of it is to be found in the cases or text-books. Coke is understood to say in his report of Sutton's Hospital case that they have the power to alienate, but later authorities are sometimes quoted on the other side. "All civil corporations," says Kyd, "such as the corporations of mayor and commonalty, bailiffs and burgesses of a town, or the corporate companies of trades in cities and towns, &c., have and always have had an unlimited control over their respective properties, and may alienate in fee, or make what estates they please for years, for life, or in tail, as fully as any individual may do in respect of his own property." And he makes the same assertion as to the common law right of colleges and ecclesiastical corporations. Grant, however, argues that no civil corporation can be supposed to hold land otherwise than as "clothed with a public purpose," and that, therefore, there is no right of alienation. Recent judicial decisions, however, seem to favor it. In a case before the late master of the rolls (*Evan v. Corporation of Avon*, 29 Beavan 144), it was held that a municipal corporation, apart from the Municipal Corporations Act, has full power to dispose of all its property like a private individual, and in the more recent case of *Riche v. Ashbury Company* (*Law Reports*, 9 Exchequer, 224) Mr. Justice Blackburn, quoting the opinion of Coke in Sutton's Hospital case, lays it down that at common law a corporation might bind itself to anything to which a natural person could bind himself, and deal with its property as a natural person might, and that an attempt to forbid this by the king, even by express negative words, does not bind the law. When land is held by a corporation for charitable or other fiduciary purposes the Court of Chancery will interfere to prevent any improper alienation.

In the case of ecclesiastical and college property, the dangers incident to unlimited power of alienation produced what are known as the restraining statutes in the reign of Elizabeth. The first of these, 1 Elizabeth c. 19, applies only to bishops, and forbids alienations whereby an estate should pass other than for the term of twenty-one years or three lives, with accustomed yearly rent or more reserved. The 13 Elizabeth c. 10 extends this principle to other ecclesiastical persons and to colleges. The alienation of college and church property is now permitted by modern statutes, under the supervision of commissioners. The Municipal Corporations Act, 1835, deals with the alienation of municipal property in a similar spirit.

As already indicated, the more important classes of corporations are now governed by special statutes which exclude or modify the operation of the common law principles. The most considerable class of societies still unaffected by such special legislation are the Livery Companies; for an account of which see COMPANIES. Under the same heading will be found an account of the important enactments regulating joint-stock companies.

The question to what extent the common law incidents of a corporation have been interfered with by special legislation has become one of much importance, especially under the Acts relating to joint-stock companies. The most important case on this subject is that of *Riche v. The Ashbury Railway Carriage Company* before mentioned, in which, the judges of the Exchequer Chamber being equally divided, the decision of the court below was affirmed. The view taken by the affirming judges, viz., that the common law incidents of a corporation adhere unless expressly removed by the legislature, may be illustrated by a short extract from the judgment of Mr. Justice Blackburn:—

"If I thought it was at common law an incident to a corporation that its capacity should be limited by the instrument creating it, I should agree that the capacity of a company incorporated under the Act of 1862 was limited to the object in the memorandum of association. But if I am right in the opinion which I have already expressed, that the general power of contracting is an incident to a corporation which it requires an indication of intention in the legislature to take away, I see no such indication here. If the question was whether the legislature had conferred on a corporation, created under this Act, capacity to enter into contracts beyond the provisions of the deed, there could be only one answer. The legislature did not

confer such capacity. But if the question be, as I apprehend it is, whether the legislature have indicated an intention to take away the power of contracting which at common law would be incident to a body corporate, and not merely to limit the authority of the managing body and the majority of the shareholders to bind the minority, but also to prohibit and make illegal contracts made by the body corporate, in such a manner that they would be binding on the body if incorporated at common law I think the answer should be the other way."

On the other hand, the House of Lords, agreeing with the three dissentient judges in the Exchequer Chamber, pronounced the effect of the Companies Act to be the opposite of that indicated by Mr. Justice Blackburn. "It was the intention of the legislature, not implied but actually expressed, that the corporations should not enter, having regard to this memorandum of association, into a contract of this description. The contract in my judgment could not have been ratified by the unanimous assent of the whole corporation." In such companies, therefore, objects beyond the scope of the memorandum of association are *ultra vires* of the corporation. The doctrine of *ultra vires*, as it is called, is almost wholly of modern and judicial creation. Its first emphatic recognition of it appears to have been in the case of companies created for special purposes with extraordinary powers, by Act of Parliament, and, more particularly, railway companies. The funds of such companies, it was held, must be applied to the purposes for which they were created and to no other. Whether this doctrine is applicable to the older or, as they are sometimes called, ordinary corporations, appears to be doubtful. A recent author (Brice on *Ultra Vires*) writes:—

"Take, as a strong instance, a university or a London guild. Either can undoubtedly manage, invest, transform, and expend the corporate property in almost any way it pleases, but if they propose to exhaust the same on the private pleasures of existing members, or to abandon the promotion, the one of education, the other of their art and mystery, it is very probable, if not absolutely certain, that the Court of Chancery would restrain the same, as being *ultra vires*."

**Municipal Corporations.**—The introduction of corporations into cities and towns does not appear to date farther back than the reign of Henry VI., although they had long possessed what may be called a quasi-corporate character. By that time the corporate character of ecclesiastical and educational societies and even of guilds had been recognized, and the great convenience of corporate powers was, no doubt, the reason why they were demanded by the commonalties of towns. The inhabitants of Plymouth appear to have petitioned for a corporation in 13 Henry IV., and the charter of Kingston-on-Hull in 18 Henry VI. is said to be the first charter of municipal incorporation in England. The ultimate effect of these charters was in general to reduce the boroughs into close corporations, the members of which engrossed the municipal and political powers to the exclusion of the general body of the inhabitants. The legal dependence of such corporations on the charter of the king suggested the measures above referred to by which the Crown attempted to get the control of the corporations. The reversal of the judgments obtained in the proceedings against corporations formed one of the first acts of the people after the Revolution of 1688, and thereafter corporations shared with private persons the advantages of freedom from arbitrary interference on the part of the Crown. Freedom from state control, however, means in the case of corporations the growth of abuses. The Corporations Act of the reign of Charles II., one of the measures forced on the king by the jealousy of his Parliament for the rights of the church, provided that no person should be elected to office in any corporate town, who should not within one year previously have taken the sacrament of the Lord's Supper according to the rites of the church, and this enactment, although after a time suspended by temporary statutes, was not finally abolished till 9 Geo. IV. c. 17, which substituted for the test a declaration not to injure or weaken the Church of England. The important powers, municipal, political, and judicial, possessed by town corporations, the large ascertained amount of property in their hands, their exclusiveness, secrecy, and almost total freedom from responsibility,—all these abuses were acquiesced in till the reform of the House of Commons in 1832 enabled Parliament to turn its attention to the reform of other public institutions. The royal commissioners appointed in 1834 reported that "there prevails among the inhabitants of

a great majority of the incorporated towns a general and in our opinion a just dissatisfaction with the municipal institutions—a distrust of the self-elected municipal councils, whose powers are subject to no popular control, and whose acts and proceedings, being secret, are not checked by the influence of public opinion; a distrust of the municipal magistracy, tainting with suspicion the local administration of justice; a discontent under the burthen of local taxation, while revenues are diverted from their legitimate use." The publication of this report was followed by the Municipal Corporations Act, 5 and 6 Will. IV. c. 26, by which, in all the boroughs named in the schedules to the Act, the laws, customs, charters, theretofore in force, are repealed where inconsistent with the provisions of the Act. Section 2 reserves all rights of property and beneficial exemptions to freemen, their wives and children; but freedom is not in future to be acquired by gift or purchase. The body corporate in such borough shall be called the mayor, aldermen, and burgesses of such borough, and by that name shall have perpetual succession, and shall be capable in law by the council hereinafter mentioned to do and suffer all things which now lawfully they and their successors respectively may do and suffer by any name or title of incorporation. It has been held that this Act does not create new corporations, although it alters the name, title, and constitution of the governing body. All corporate funds, after payment of debts, salaries, &c., as specified in the Act, are expressly appropriated to public purposes. Adwosons in the possession of the body corporate are to be sold under the direction of the ecclesiastical commissioners, and the proceeds invested in securities for the use of the corporation. The general regulations of municipalities under this and subsequent Acts not affecting them in their character as corporations, belong to the subject of Municipal Government.

This beneficial Act was unfortunately limited in its operation. London and all its corporations were left out, and the municipal government of the metropolis is at this moment a medley of independent jurisdictions in striking contrast with the orderly corporations of other large towns. And on the other hand, many small boroughs were omitted in the original Act, which still exhibit in the mismanagement of their property and powers the abuses against which that Act was directed. In 1875 and 1876 resolutions on the subject were laid before the Parliament, and from a return procured by Government, it appeared that the number of unreformed corporations was 102. Many of these were places of some importance, and in possession of considerable property. Government yielded to the general feeling that inquiry was desirable, and a royal commission was appointed to consider the subject. (E. R.)

**CORPULENCE, or OBESITY,** is a condition of the body characterized by the over-accumulation of fat under the skin and around certain of the internal organs. In all healthy persons a greater or less amount of fat is present in these parts, and serves important physiological ends, besides contributing to the proper configuration of the body. Even a considerable measure of corpulence, however inconvenient, is not inconsistent with a high degree of health and activity, and it is only when in great excess or rapidly increasing that it can be regarded as a morbid state. The extent to which obesity may proceed is illustrated by numerous well-authenticated examples recorded in medical works, of which only a few can be here mentioned. Thus Bright, a grocer of Maldon, in Essex, who died in 1750, in his twenty-ninth year, weighed 616 lb. Dr. F. Dancel records the case of a young man of twenty-two, who died from excessive obesity, weighing 643 lb. In the *Philosophical Transactions* for 1813 a case is recorded of a girl of four years of age who weighed 256 lb. But the most celebrated case is that of Daniel Lambert of Leicester, who died in 1809 in his fortieth year. He is said to have been the heaviest man that ever lived, his weight being 739 lb. (52 st. 11 lb.). Lambert had publicly exhibited himself for some years prior to his death, which occurred suddenly at Stamford. At the inn where he died two suits of his clothes were preserved, from which some idea of his enormous dimensions may be obtained, when it is stated that his waistcoat could easily inclose seven persons of ordinary size. Lambert ate moderately, drank only water, and slept less than most persons. He is said to have had an excellent tenor voice.

Health cannot be long maintained under excessive obesity, for the increase in bulk of the body, rendering

<sup>1</sup> Miles Darden (1708-1857) died at Lexington, Tenn., weighing over 1000 lbs. His height was 7½ feet.—*Am. Ec.*

exercise more difficult, leads to relaxation and defective nutrition of muscle, while the accumulations of fat in the chest and abdomen occasion serious embarrassment to the functions of the various organs in those cavities. In general the mental activity of the highly corpulent becomes impaired, although there have always been many notable exceptions to this rule.

Various causes are assigned for the production of corpulence, but it must be admitted that in many cases it cannot be accounted for. In some families there exists an hereditary predisposition to an obese habit of body, the manifestation of which no precautions as to living appear capable of averting. But beyond this it is unquestionable that certain habits favor the occurrence of corpulence. A luxurious, inactive, or sedentary life, with over-indulgence in sleep and absence of mental occupation, are well recognized predisposing causes. The more immediate exciting causes are over-feeding and the large use of fluids of any kind, but especially alcoholic liquors. Fat persons are not always great eaters, though many of them are, while again, leanness and inordinate appetite are not infrequently associated. Still, it may be stated generally that indulgence in food, beyond what is requisite to repair daily waste, goes towards the increase of flesh, particularly of fat. This is more especially the case when the non-nitrogenous (the fatty, saccharine, and starchy) elements of the food are in excess. Although it is still undetermined whether the fat of the body is derived alone from these, or also from the nitrogenous (albuminous) elements of the food, it seems certain that while an excess of the latter constituents accelerates the oxidation and metamorphoses of the fatty tissues, an excess of the non-nitrogenous retards these changes, and thus tends directly to the production of obesity (Parkes). The want of adequate bodily exercise will in a similar manner produce a like effect, and it is probable that many cases of corpulence are to be ascribed to this cause alone, from the well-known facts that many persons of sedentary occupation become stout, although of most abstemious habits, and that obesity frequently comes on in the middle-aged and old, who take relatively less exercise than the young, in whom it is comparatively rare. Women are more prone to become corpulent than men, and appear to take on this condition more readily after the cessation of the function of menstruation.

For the prevention of corpulence and the reduction of superfluous fat many expedients have been resorted to, and numerous remedies recommended. It is unnecessary to allude to these in detail, further than to state that they embrace such regimen as bleeding, blistering, purging, starving, the use of different kinds of baths, and of drugs innumerable, most of which means have been found utterly to fail in accomplishing the desired object. The drinking of vinegar was long popularly supposed to be a remedy for obesity. It is related of the marquis of Cortona, a noted general of the duke of Alva, that by drinking vinegar he so reduced his body from a condition of enormous obesity that he could fold his skin about him like a garment. Such a remarkable result was only a proof of the injury done to his health by the excessive use of vinegar. There is no evidence, whatever, that this liquid has any power to remove fat, while its pernicious effects upon the health, when taken in large quantity, are well known to medical men. Another medicinal agent, which has been proposed on the high authority of Dr. T. King Chambers, is the *liquor potassæ*. This medicine, which is recommended on the ground of the chemical affinity of the alkalis for fats, is directed to be taken in teaspoonful doses in milk twice or thrice daily, at the same time that a restricted diet and abundant exercise is enjoined. But even this plan, although occasionally yielding good results, cannot be said to have been widely successful. The more rational and hopeful system of treatment appears to be that which is directed towards regulating the quality as well as the quantity of nutriment ingested. This method has of late years received much attention, chiefly in consequence of the publication, in 1863, of a pamphlet entitled *Letter on Corpulence, Addressed to the Public by William Banting*, in which was narrated the remarkable experience of the writer in accomplishing the reduction of his own weight in a short space of time by the adoption of a particular kind of diet. Mr. Banting describes the condition of obesity in which he was in August, 1862, and which, although certainly less than those examples above mentioned, appears to have been

sufficient to prove a source of much discomfort and even of actual suffering. After trying almost every known remedy without effect, he was induced, on the suggestion of Mr. Harvey, a London artist, to place himself upon an entirely new form of diet, which consisted chiefly in the removal, as far as possible, of all saccharine, starchy, and fat food, the reduction of liquids, and the substitution of meat or fish and fruit in moderate quantity at each meal, together with the daily use of an antacid draught. Under this regimen his weight was reduced 46 lb in the course of a few weeks, while his health underwent a marked improvement. Mr. Banting's recorded experience, as might have been expected, induced many to follow his example, and in numerous instances the effects were all that could be desired. But in many cases the diminution in weight was found to be attended with such a serious impairment of health as to render the carrying out of this system impossible. It is probable that in some at least of these cases the unfavorable effects might have been avoided had the change in diet been more gradually brought about. There seems little reason to doubt that this method, founded as it is on well-recognized principles of physiological chemistry, is that which is most likely to yield the best results in the treatment of corpulence. It evidently cannot, however, be safely adopted in all cases, and ought not to be attempted to be carried out except under medical advice and observation; for however desirable it be to get rid of superabundant fat, it would be manifestly no gain were this to be achieved by the sacrifice of the general health. An important element in the treatment of obesity is the due regulation of the amount of bodily exercise, and this, too, ought to be made the subject of the physician's careful attention.

*Cursorry Remarks on Corpulence, or Obesity considered as a Disease*, by William Wadd, 3d ed., London, 1816; *Corpulence or Excess of Fat in the Human Body*, by Dr. T. King Chambers, London, 1850; *Traité théorique et pratique de l'obésité*, by Dr. F. Dancoel, Paris, 1863; *Letter on Corpulence, addressed to the Public by William Banting*, 3d ed., London, 1864; *The Practice of Medicine*, by Dr. Tanner, London, 6th ed., London, 1869. (J. O. A.)

CORPUS CHRISTI, a festival of the Church of Rome observed on the first Thursday after Trinity Sunday, in honor of the doctrine of the Eucharist. It was instituted by Pope Urban IV., in 1264, and is still celebrated as one of the greatest feasts of the church.

CORREA DA SERRA, JOSÉ FRANCISCO (1750-1823), a Portuguese politician and man of science, was born at Serpa, in Alemtejo, in 1750. Having been educated at Rome, he took orders under the protection of the duke of Alafões, uncle of Mary I. of Portugal. In 1777 he returned to Lisbon, where he resided with his patron, with whose assistance he founded the Portuguese Academy of Sciences. Of this institution he was named perpetual secretary, and he received the privilege of publishing its transactions without reference to any censor whatever. His use of this right brought him into conflict with the Holy Office; and consequently in 1786 he fled to France, and remained there till the death of Pedro III., when he again took up his residence with Alafões. But having given a lodging in the palace to a French Girondist, he was forced to flee to England, where he found a protector in Sir Joseph Banks, and became a member of the Royal Society. In 1797 he was appointed secretary to the Portuguese legation, but a quarrel with the ambassador drove him once more to Paris (1802), and in that city he resided till 1813, when he crossed over to New York. In 1816 he was made Portuguese minister-plenipotentiary at Washington, and in 1820 he was recalled home, appointed a member of the Financial Council, and elected to a seat in the Cortes. Three years after, and in the same year with the fall of the constitutional Government, he died. Correa da Serra ranks high as a botanist, though he published no great special work. His principal claim to renown is the *Coleção de Livros inéditos da Historia Portuguesa*, 4 vols. (1790-1816), an invaluable selection of documents, exceedingly well edited.

CORREGGIO, or COREGGIO, is the name ordinarily given to Antonio Allegri (1494-1534), one of the most celebrated Italian painters, of the most vivid and impulsive inventors in expression and pose, and of the most consummate executants. The external circumstances of his life have been very diversely stated by different writers, and the whole of what has been narrated regarding him, even waiving the question of its authenticity, is but meagre

The first controversy is as to his origin. Some say that he was born of poor and lowly parents; others, that his family was noble and rich. Neither account is accurate. His father was Pellegrino Allegri, a tradesman in comfortable circumstances, living at Correggio, a small city in the territory of Modena; his mother Bernardina Piazzoli degli Aromani, also of a creditable family of moderate means. Antonio was born at Correggio, and was carefully educated. He was not (as has been often alleged) strictly self-taught in his art—a supposition which the internal evidence of his pictures must of itself refute. They show a knowledge of optics, perspective, architecture, sculpture, and anatomy. The last-named science he studied under Dr. Giovanni Battista Lombardi, whom he is believed to have represented in the portrait currently named *Il Medico del Correggio* (Correggio's physician). It is concluded that he learned the first elements of design from his uncle, Lorenzo Allegri, a painter of moderate ability at Correggio, and from Andrea Bartolotti, named Tognino, and that he afterwards went to the school of Francesco Ferrari Bianchi (named Frari), and perhaps to that of the successors of Andrea Mantegna in Mantua. He is said to have learned modelling along with the celebrated Begarelli at Parma; and it has even been suggested that, in the *Pietà* executed by Begarelli for the church of Santa Margherita, the three finest figures are the work of Correggio, but, as the group appears to have been completed three years after the painter's death, there is very little plausibility in this story. Another statement connecting Begarelli with Correggio is probably true, namely, that the sculptor executed models in relief for the figures which the painter had to design on the cupolas of the churches in Parma. This was necessarily an expensive item, and it has been cited as showing that Correggio must have been at least tolerably well off,—an inference further supported by the fact that he used the most precious and costly colors, and generally painted on fine canvases, or sometimes on sheets of copper.

The few certain early works of Correggio show a rapid progression towards the attainment of his own original style. Though he never achieved any large measure of reputation during his brief lifetime, and was perhaps totally unknown beyond his own district of country, he found a sufficiency of employers, and this from a very youthful age. One of his early pictures, painted in 1514 when he was nineteen or twenty years old, is a large altar-piece commissioned for the Franciscan convent at Carpi, representing the Virgin enthroned, with Saints; it indicates a predilection for the style of Leonardo da Vinci, and has certainly even greater freedom than similarly early works of Raphael. This picture is now in the Dresden Gallery. Another painting of Correggio's youth is the *Arrest of Christ*. A third is an Ancona (or triple altar-piece)—the *Repose in Egypt*, with Sts. Bartholomew and John) in the church of the Conventuali at Correggio, showing the transition from the painter's first to his second style. Between 1514 and 1520 Correggio worked much, both in oil and in fresco, for churches and convents. In 1520 he began his famous fresco of the *Ascension* or *Assumption* of Christ, on the cupola of the Benedictine church of St. John in Parma; here the Redeemer is surrounded by the twelve apostles and the four doctors of the church, supported by a host of wingless cherub boys amid the clouds. This he finished in 1524, and soon afterwards undertook his still vaster work on another cupola, that of the cathedral of the same city, representing the *Assumption* of the Virgin, amid an unnumbered host of saints and angels rapt in celestial joy. It occupied him up to 1530. The astounding boldness of scheme in these works, especially as regards their incessant and audacious foreshortenings—the whole mass of figures being portrayed as in the clouds, and as seen from below—becomes all the more startling when we recall to mind the three facts—that Correggio had apparently never seen any of the masterpieces of Raphael or his other great predecessors and contemporaries, in Rome, Florence, or other chief centres of art; that he was the first artist who ever undertook the painting of a large cupola; and that he not only went at once to the extreme of what can be adventured in foreshortening, but even forestalled in this attempt the mightiest geniuses of an elder generation—the *Last Judgment* of Michelangelo, for instance, not having been begun earlier than 1533 (although the ceiling of the Sistine Chapel, in which foreshortening plays a comparatively small part, dates from 1508 to 1512). The cupola of the cathedral has

neither skylight nor windows, but only light reflected from below; the frescoes, some portions of which were ultimately supplied by Giorgio Gandini, are now dusky with the smoke of tapers, and parts of them, both in the cathedral and in the church of St. John, having during many past years been peeling off. The violent foreshortenings were not, in the painter's own time, the object of unmixed admiration; some satirist termed the groups a "guzzetto di rane," or hash of frogs. This was not exactly the opinion of Titian, who is reported to have said, on seeing the pictures, and finding them lightly esteemed by local dignitaries, "Reverse the cupola, and fill it with gold, and even that will not be its money's worth." Annibale Caracci and the Eclectics generally evinced their zealous admiration quite as ardently. Parma is the only city which contains frescoes by Correggio. For the paintings of the cupola of St. John he received the moderate sum of 472 sequins; for those of the cathedral, much less proportionately, 350. On these amounts he had to subsist, himself and his family, and to provide the colors, for about ten years, having little time for further work meanwhile. Parma was in an exceedingly unsettled and turbulent condition during some of the years covered by Correggio's labors there, veering between the governmental ascendancy of the French and of the Pope, with wars and rumors of wars, alarms, tumults, and pestilence.

Other leading works by Correggio are the following:—The frescoes in the Camera di San Paolo (the abbess's saloon) in the monastery of S. Lodovico at Parma, painted towards 1519 in fresco,—*Diana* returning from the Chase, with auxiliary groups of lovely and vivacious boys of more than life-size, in sixteen oval compartments. In the National Gallery, London, the *Ecce Homo*, painted probably towards 1520; and *Cupid, Mercury, and Venus*, the latter more especially a fine example. The oil-painting of the *Nativity* named *Night*, or *La Notte*, for which 40 ducats and 208 livres of old Reggio coin were paid; the nocturnal scene is partially lit up by the splendor proceeding from the divine Infant. This work was undertaken at Reggio in 1522 for Alberto Pratoneria, and is now in the Dresden Gallery. The oil-painting of *St. Jerome*, termed also *Day* (*Il Giorno*), as contrasting with the above-named *Night*. Jerome is here with the *Madonna and Child*, the *Magdalene*, and two *Angels*, of whom one points out to the *Infant* a passage in the book held by the *Saint*. This was painted for Briseida Bergonzi from 1527 onwards, and was remunerated by 400 gold imperials, some cartloads of fagots and measures of wheat, and a fat pig. It is now in the gallery at Parma. The *Magdalene* lying at the entrance of her cavern: this small picture (only 18 inches wide) was bought by Augustus III. of Saxony for 6000 louis d'or, and is in Dresden. In the same Gallery, the two works designated *St. George* (painted towards 1532) and *St. Sebastian*. In the Parma Gallery, the *Madonna* named "*della Scala*," a fresco which was originally in a recess of the *Porta Romana*, Parma; also the *Madonna "della Scodella"* (of the bowl, which is held by the *Virgin*—the subject being the *Repose* in *Egypt*): it was executed for the church of San Sepolcro. Both these works date towards 1526. In the church of the *Annunciation*, Parma, a fresco of the *Annunciation*, now all but perished. Five celebrated pictures painted or begun in 1532,—*Venus, Leda, Danae, Vice, and Virtue*: the *Leda*, with figures of charming girls bathing, is now in the Berlin Gallery, and is a singularly delightful specimen of the master. In Vienna, *Jupiter and Io*. In the Louvre, *Jupiter and Antiope*, and the *Mystic Marriage* of *St. Catharine*. In the Naples Museum, the *Madonna* *Reposing*, commonly named *La Zingarella*, or the *Madonna del Coniglio* (*Gipsy-girl*, or *Madonna of the Rabbit*). On some of his pictures Correggio signed "*Lieto*," as a synonym of "*Allegri*." About forty works can be confidently assigned to him, apart from a multitude of others probably or manifestly spurious.

The famous story that this great but isolated artist was once, after long expectancy, gratified by seeing a picture of Raphael's, and closed an intense scrutiny of it by exclaiming "*Anch'io son pittore*" (I too am a painter), cannot be traced to any certain source. It has nevertheless a great internal air of probability; and the most enthusiastic devotee of the Umbrian will admit that in technical bravura, in enterprising, gifted, and consummated execution, not Raphael himself could have assumed to lord it over Correggio.

In 1520 Correggio married Girolama Merlini, a young lady of Mantua, who brought him a good dowry. She

was but sixteen years of age, very lovely, and is said by tradition to have been the model of his Zingarella. They lived in great harmony together, and had a family of four children. She died in 1529. Correggio himself expired at his native place on the 5th of March, 1534. His illness was a short one, and has by some authors been termed pleurisy. Others, following Vasari, allege that it was brought on by his having had to carry home a sum of money, 50 scudi, which had been paid to him for one of his pictures, and paid in copper coin to humiliate and annoy him; he carried the money himself, to save expense, from Parma to Correggio on a hot day, and his fatigue and exhaustion led to the mortal illness. In this curious tale there is no symptom of authenticity, unless its very singularity, and the unlikelihood of its being invented without any foundation at all, may be allowed to count for something. He is said to have died with Christian piety; and his eulogists (speaking apparently from intuition rather than record) affirm that he was a good citizen, an affectionate son and father, fond and observant of children, a sincere and obliging friend, pacific, beneficent, grateful; unassuming, without meanness, free from envy, and tolerant of criticism. He was buried with some pomp in the Arrivabene Chapel, in the cloister of the Franciscan church at Correggio.

Regarding the art of Correggio from an intellectual or emotional point of view, his supreme gift may be defined as suavity,—a vivid spontaneous lambent play of the affections, a heartfelt inner grace which fashions the forms and features, and beams like soft and glancing sunshine in the expressions. We see lovely or lovable souls clothed in bodies of corresponding loveliness, which are not only physically charming, but are so informed with the spirit within as to become one with that in movement and gesture. In these qualities of graceful naturalness, not heightened into the sacred or severe, and of joyous animation, in momentary smiles and casual living turns of head or limb, Correggio undoubtedly carried the art some steps beyond anything it had previously attained, and he remains to this day the unsurpassed or unequalled model of pre-eminence. From a technical point of view, his supreme gift—even exceeding his prodigious faculty in foreshortening and the like—is *chiaroscuro*, the power of modifying every tone, from bright light to depth of darkness, with the sweetest and most subtle gradations, all being combined into harmonious unity. In this again he far distanced all predecessors, and defied subsequent competition. His color also is luminous and precious, perfectly understood and blended; it does not rival the superb richness or deep intense glow of the Venetians, but on its own showing is a perfect achievement, in exact keeping with his powers in *chiaroscuro* and in vital expression. When we come, however, to estimate painters according to their dramatic faculty, their power of telling a story or impressing a majestic truth, their range and strength of mind, we find the merits of Correggio very feeble in comparison with those of the highest masters, and even of many who without being altogether great have excelled in these particular qualities. Correggio never *means* much, and often, in subjects where fulness of significance is demanded, he means provokingly little. He expressed his own miraculous facility by saying that he always had his thoughts at the end of his pencil; in truth, they were often thoughts rather of the pencil and its controlling hand than of the teeming brain. He has the faults of his excellences—sweetness lapsing into mawkishness and affectation, empty in elevated themes and lasciviously voluptuous in those of a sensuous type, rapid and forceful action lapsing into posturing and self-display, fineness and sinuosity of contour lapsing into exaggeration and mannerism, daring design lapsing into incorrectness. No great master is more dangerous than Correggio to his enthusiasts; round him the misdeeds of conventionalists and the follies of connoisseurs cluster with peculiar virulence, and almost tend to blind to his real and astonishing excellences those practitioners or lovers of painting who, while they can acknowledge the value of *technique*, are still more devoted to greatness of soul, and grave or elevated invention, as expressed in the form of art.

Correggio was the head of the school of painting of Parma, which forms one main division of the Lombardic school. He had more imitators than pupils. Of the latter one can name with certainty only his son Pomponio, who was born in 1521 and died at an advanced age; Francesco

Capelli; Giovanni Giarola; Antonio Bernieri (who, being also a native of the town of Correggio, has sometimes been confounded with Allegri); and Bernardo Gatti, who ranks as the best of all. The Parmigiani (Mazzuoli) were his most highly distinguished imitators. (w. m. r.)

CORRÈZE, an inland department of France, formed from the southern portion of the old province of Limousin, is bounded N. by the departments of Haute-Vienne and Creuse, E. by Puy-de-Dôme and Cantal, S. by Lot, and W. by Dordogne, and lies between 44° 55' and 45° 40' N. lat. The surface of the country is in general hilly, but in the south-west there are some plains. In the north an offshoot of the mountains of Auvergne separates the basins of the Dordogne and Loire. The soil is mostly poor and thin, moderately fertile in the low, but heathy and unproductive in the high land. In certain districts there are forests of oak, birch, beech, elm, and poplar. The average temperature of Corrèze is low, and the climate is damp, as several of the higher mountain summits are covered with snow for many months in the year; the summer heat in the valleys is, however, excessive. The principal rivers are the Dordogne and the Vézère, with its affluent the Corrèze. The chief productions are wheat and other cereals, hemp, flax, and wine of an inferior quality. Chestnuts are a staple article of diet with many of the people. Cattle, sheep, goats, horses, mules, and pigs are reared in considerable numbers. The mineral resources, which are little developed, include ores of iron, copper, lead, tin, and antimony, besides coal, marble, slates, clay, millstones, grindstones, granite, and porphyry. The manufactures are fire-arms, glass, bricks, leather, coarse woollens, paper, lace, wax candles, and nut oil. The department is divided into the arrondissements Tulle, Brive, and Ussel, containing 29 cantons and 286 communes. The chief town is Tulle. The total area is 2265 square miles, and the population in 1872 numbered 302,746.

CORRIENTES, or SAN JUAN DE CORRIENTES, a town of the Argentine Republic, South America, and capital of the province of Corrientes, is situated on the left bank of the Parana, below its junction with the Paraguay, in 27° 27' 31" S. lat. and 59° 46' W. long. It has a college, Government house, museum, several schools and churches, and a good quay; and is an emporium for the maté, sugar, cotton, and tobacco of Paraguay, and for the furs of the Chaco Indians. The exports are chiefly hides, wool, and timber. Population, 10,546. Corrientes was founded by Alonzo de Bera on the 3d April, 1588.

CORRY, a city of 6800 inhabitants, in Erie county, Pennsylvania, which owes its existence and its prosperity to the petroleum wells discovered in 1861. Besides the numerous establishments connected with the oil trade, it has engineering works, steam-mills, and tanneries; and, favored as it is by its position at a railway junction, it is rapidly developing a considerable traffic. Its incorporation as a city dates from 1866.

CORSEUL, or CORSEULT. See COTES-DU-NORD.

CORSICA (Greek, *Kῆπος*; Latin, *Corsus* and *Corsica*; French, *Corse*), a large island of the Mediterranean, belonging to France, is situated immediately to the north of Sardinia (from which it is separated by the narrow strait of Bonifacio), between 41° 20' and 43' N. lat., and 8° 30' and 9° 30' E. long. Population, 253,507. It lies within 54 miles west of the coast of Tuscany, 98 miles south of Genoa, and 106 miles south-east of the French coast at Nice. The extreme length of the island is 116 miles, and its breadth 52 miles; and it has an area of 3376 square miles—about one-third of the extent of Sardinia. The greater part of the surface of Corsica is occupied by a central range of lofty and rugged mountains, diverging in all directions, the highest peaks being Monte Cinto (8889 feet), Rotondo (8609), Pagliorba (8284), Padro (7846), and d'Cro (7841). On the west and south of the island the spurs of this range either terminate abruptly on the shore or run out to a great distance into the sea, forming bays and gulfs, some of which afford excellent harbors. The prevailing rocks are of granite, gneiss, and mica slate, with occasional beds of syenite, porphyry, and serpentine. Minerals are not worked to any great extent, although lead is found in some quantity at Luri, antimony at Ersa, and copper at Bastia, Ponte Leccia, etc. On the eastern side of the island, between Bastia and Porto Vecchio, there intervenes between the mountains and the sea a considerable tract of low country, where there are plantations of olive trees,

almond and fig trees, and vineyards. The oil produced is, however, not of the best quality, and much of the wine is exported to France in a raw state for the manufacture of liqueurs. Corsica is well watered with rivers, which, though short in their course, bring down large volumes of water from the mountains. The longest is the Golo (the Tavola of the Romans), which enters the sea on the east coast through the large salt-water lake of Biguglia; further south on the same side of the island are the Tavignano and the Rezzanese; while on the east side is the Taravo. The other streams are all comparatively small. From the rugged and indented outline of the coast there are an unusual number of bays and harbors. Of the former the most important on the western side of the island are Porto, Sagone, Ajaccio, and Propriano; of the latter, St. Florent, Ile Rousse, Calvi, and Ajaccio. On the eastern side, which is much less rugged and broken, the only harbors worth mentioning are Bastia and Porto Vecchio (the Portus Syracusanus of the ancients), and the only gulf that of

forests. The former of these has a somewhat bitter flavor, from the yew and box trees on which the bees feed. Beyond the making of oil, wine, soap, bricks, and coarse glass, the Corsicans are entirely destitute of manufacturing industry, and their commerce consists for the most part of the spontaneous produce of the island. The fisheries of tunny, pilchard, and anchovy are extensively prosecuted for the supply of the Italian markets; but comparatively few of the native Corsicans are engaged in this department of industry. The Government have constructed 700 miles of excellent roads (*Routes Nationales*), round the entire island, and crossing it at various points, by which regular communication is maintained by means of diligences. Corsica, which forms a department of France, is divided into five arrondissements, subdivided and peopled as follows:—

Arrondissements.	Cantons.	Communes.	Population (1872).
1. Ajaccio ..	12	72	66,701
2. Sartene ..	8	46	33,495
3. Bastia ..	20	93	74,124
4. Calvi ..	6	34	24,516
5. Corte ..	16	110	59,671
Total ..	62	355	258,507

Of this number 130,406 were males and 128,101 females; and compared with the census of 1851, the total population has increased by 22,256 souls, or nearly 9 per cent. in twenty-one years.

The principal towns are Ajaccio (pop. 16,545), the capital and the seat of the bishop of the island (who is under the archbishop of Aix), the prefect, and the commander of the forces; Bastia (pop. 17,850), Corte (5430), and Sartene (4166). Education is very backward among the islanders, about 40 per cent. being returned as unable to read or write. There are, however, several colleges, such as the lyceum of Bastia, the Collège Fesch of Ajaccio, the Collège de Calvi, and the Ecole Paoli de Corte. The people are sober in their habits, but not enterprising and without much knowledge of sanitary laws. Their proneness to agrarian outrages has brought upon them an evil repute, but thanks to the strenuous efforts of the French Government this spirit of lawlessness has been greatly curbed. A great part of the agricultural labor is performed by laborers from Tuscany and Lucca, who periodically visit the island for that purpose.

*History.*—It is not known who the original inhabitants of Corsica were. The Phœnicians of Ionia were the first civilized people that established settlements in Corsica. About the year 560 a.c. they landed for the first time on the island, and founded the city of Aleria, which after a short occupation they were compelled to abandon. After an interval of a few years they again returned, rebuilt Aleria, which they fortified, and endeavored to maintain their ground against the natives. After a struggle of some years they were again compelled to leave the island. The next foreign occupants of Corsica were the Tuscans, who founded the city of Nisea, but they in their turn were compelled to give way before the growing maritime power of the Carthaginians, whose jurisdiction in the island was unquestioned till the beginning of the first Punic war. On that occasion the Romans sent out a fleet, drove the Carthaginians from the island, and exacted at least a nominal homage from the native population. They did not, however, fully establish their power here till about thirty years later, and even then rebellions and revolts were of constant occurrence. The first step made towards the real subjugation of the island was the establishment of the two colonies on its eastern coast—that of Aleria by Sulla, and that of Mariana by Marius. In the time of the emperors, the island had fallen into disrepute among the Romans, by whom it was used chiefly as a place of banishment for political offenders. One of the most distinguished of these sufferers was the younger Seneca, who spent in exile here the eight years ending 49 A.D.

On the downfall of the Roman empire in the West, Corsica passed into the hands of the Vandals. These barbarians were driven out by Belisarius, but after the death of that illustrious general, 565 A.D., the resistless hordes of Attila once more gained possession of the island. Since that period it has successively owned the dominion of the Goths, the Saracens, the Pisans, and the Genoese. The impress of the last is to be found in the style of the church architecture and notably in the *patois* of the people; while the armorial crest of the island, a Moor's head, is ascribable to the Saracen occupation. Corsica was ceded by the Genoese to the French in 1768; and for a few years after the French Revolution of 1793 it was placed under the protection of Great Britain. Since 1814 it has been in undisturbed possession of the French. Corsica is famous as the birthplace of Pascal Paoli and of Napoleon Bonaparte.

CORSSEN, WILHELM PAUL (1820-1875), a distin-



Island of Corsica.

Santa Manza. At the extreme south are the harbor and town of Bonifacio, giving name to the strait which separates Corsica from Sardinia.

Of the internal resources of the island the most important consist of those vast forests that cover the summits of the hills, and which furnished timber for the navies of antiquity. Partly, however, from the indolence of the inhabitants, and partly from the difficulties of land carriage, this source of wealth is comparatively neglected. The mountain pastures are made available for the rearing of cattle, horses, asses, and mules. Sheep of a peculiar black breed, called *mufflons*, inhabit the more inaccessible parts of the mountains, and goats and pigs abound in the island. The uncultivated districts are generally overgrown with a thick tangled underwood, consisting of arbutus, myrtle, thorn, laurel, broom, and other shrubs, and called by the natives *maquis*, which, however, is easily cleared off by burning. Throughout the island the growth of the cereal crops is generally abandoned for the easier cultivation of the olive and vine. Chestnuts constitute an important article of food, but wheat, maize, and barley are also cultivated. The backward state of agriculture is caused principally by the minute subdivision of the land, a system which perpetuates the social evils of hereditary feuds and jealousies, by which Corsica has long been distracted. A large proportion of the exports of the island consists of honey and wax, which are procured from the

guished German philologist, was born at Bremen, January 20, 1820, and received his school education in the Prussian town of Schwedt, to which his father, a merchant, had removed. After spending some time at the Joachimsthal Gymnasium in Berlin, where his interest in philological pursuits was awakened by the Rector Meinike, he proceeded to the university, and there came especially under the influence of Boeckh and Lachmann. His first important appearance in literature was as the author of *Origines Poësis Romanae*, by which he had obtained the prize offered by the "philosophical" or "arts" faculty of the university. In 1846 he was called from Stettin, where he had for nearly two years held a post in the gymnasium, to occupy the position of lecturer in the royal academy at Pforta (near Naumburg), and there he continued to labor for the next twenty years. The philosophico-historical class of the Royal Prussian Academy of Sciences having, in 1854, offered a prize for the best work on the pronunciation and accent of Latin, he gained the day by means of a treatise which at once took rank, on its publication under the title of *Ueber Aussprache, Vokalismus, und Betonung der Lateinischen Sprache* (2 vols. Leipsic, 1858-59), as one of the most erudite and masterly works in its department. This was followed in 1863 by his *Kritische Beiträge zur Lat. Formenlehre*, which was supplanted in 1866 by *Kritische Nachträge zur Lat. Formenlehre*. In the discussion of the pronunciation of Latin he was naturally led to consider the various old Italian dialects, and the results of his investigations appeared in miscellaneous communications to Kuhn's *Zeitschrift für vergleichende Schriftforschung*. The state of his health obliged him to give up his professorship at Pforta, and return to Berlin, in 1866; but it produced almost no diminution of his literary activity. In 1867 he published an elaborate archaeological study entitled the *Alterthümer und Kunstdenkmale des Cistercienserklosters St. Marien und der Landesschule Pforta*, in which he gathers together all that can be discovered about the history of the establishment where he had taught so long; and in 1868-69 he brought out a new edition of his work on Latin pronunciation. From a very early period he had been attracted to the special study of Etruscan remains, and had at various times given occasional expression to his opinions on individual points; but it was not till 1870 that he had the opportunity of visiting Italy and completing his equipment for a formal treatment of the whole subject by personal inspection of the monuments. In 1874 appeared the first volume of *Ueber die Sprache der Etrusker*, in which with great ingenuity and erudition he endeavors, it cannot be said with complete success, to prove that the Etruscan language was cognate with that of the Romans. Before the second volume had received the last touches of his hand he was cut off by a comparatively early death, which had in all probability been hastened by those long hours which he had spent "in damp grave-chambers," painfully deciphering by candle-light the faded and fragmentary inscriptions of forgotten days. Whatever may be the ultimate decision of criticism on the great question at issue, and however unfortunate his conjectures may be proved by later investigators, it cannot be denied that he has brought the matter one step nearer to a final conclusion. The posthumous volume appeared in 1875, having been edited by E. W. A. Kuhn.

CORT, CORNELIUS (1536-1578), was born at Horn in Holland, and studied engraving under Jerom Cockx of Antwerp. About 1565 he went to Venice, where Titian employed him to execute the well-known copper-plates of St. Jerome in the Desert, the Magdalen, Prometheus, Diana and Acteon, and Diana and Calisto. From Italy he wandered back to the Netherlands, but he returned to Venice soon after 1567, proceeding thence to Bologna and Rome, where he produced engravings from all the great masters of the time. At Rome he founded the well-known school in which, as Bartsch tells us, the simple line of Marcantonio was modified by a brilliant touch of the burin, afterwards imitated and perfected by Agostino Caracci in Italy and Nicholas de Bruyn in the Netherlands. Before visiting the Peninsula, Cort had been content to copy Coxie, F. Floris, Hemskerk, Mostaert, Spranger, and Stradan. In Italy he gave circulation to the works of Raphael, Titian, Polidoro da Caravaggio, Baroccio, Giulio Clovio, Muziano, and the Zuccari. His connection with Jerom Cockx and Titian is pleasantly illustrated in a letter addressed to the latter by Dominick Lampeon of Liège in 1567. Cort is said to have engraved upwards of 151 plates.

<sup>1</sup> [Spanish navigator, coasted Yucatan in 1518,

CORTE-REAL, the name of a noble Portuguese family. In 1500 Gaspard Cort-Real sailed from Lisbon, landed on the coast of Labrador, and, having named the country, returned home with some of the natives whom he had captured. In 1501 he undertook a second voyage to the Arctic seas, from which he did not return. In the following year his brother Miguel led an expedition for the purpose of discovering him, but he also never returned. The king, Emmanuel, sent out two ships to the assistance of the brothers, but no traces of either could be found. A third brother, Vasco, was only prevented from risking the fate of Gaspard and Miguel by the king's command. To the same family belonged the poet, Jeronymo Corte-Real. He also was a sailor; for the first fact in his life that has come down to us is that, about 1571, he was appointed captain-general of a fleet fitted out for explorations in the Indies. The invasion of Philip II. in 1580 found him in retirement at Evora; but of the rest of his life there is nothing satisfactorily known except that he died before 1594. His *Dia*, an epic founded on the siege of Diu, and his *Austriad*, celebrating the victory won in 1571 by Don John of Austria over the Turks at Lepanto, have no great merit. His best work is the *Naufragio de Sepulveda* (published in 1594), a poem describing the shipwreck and death of Lionor de Sa (the mother of his wife) and of Manoel de Souza. An edition of this story, which has been translated into both French and Spanish, appeared at Lisbon in 1849.

See Ferdinand Denis, *Chroniques chevaleresque de l'Espagne et Portugal*; and Sismondi, *Littérature du midi de l'Europe*.

CORTES, a Spanish term literally signifying the "courts," and applied to the States, or assembly of the States, of the kingdom. See SPAIN and PORTUGAL.

CORTES, HERNAN, or HERNANDO (1485-1547), conqueror of Mexico, was born at Medellin, a small town of Extremadura, in 1485. He belonged to a noble family of decayed fortune, and, being destined for the bar, was sent, at fourteen years of age, to the University of Salamanca; but study was distasteful to him, and he returned home in 1501, resolved to enter upon a life of adventure. He arranged to accompany Ovando, who had been appointed to the command of St. Domingo, but was prevented from joining the expedition by an accident that happened to him in a love adventure. He next sought military service under the celebrated Gonsalvo de Cordova, but a serious illness frustrated his purpose. At last, in 1504, he set out, according to his first plan, for St. Domingo, where he was kindly received by Ovando. He was then only nineteen, and remarkable for a graceful physiognomy and amiable manners, as well as for skill and address in all military exercises. He remained in St. Domingo, where Ovando had successively conferred upon him several lucrative and honorable employments, until 1511, when he accompanied Diego Velasquez in his expedition to the island of Cuba. Here he became alcalde of St. Iago, and displayed great ability on several trying occasions. An opportunity was soon afforded him of showing his powers as a military leader in an enterprise of the first importance. Grijalva, lieutenant of Velasquez, had just discovered Mexico, but had not attempted to effect a settlement. This displeased the governor of Cuba, who superseded Grijalva, and intrusted the conquest of the newly-discovered country to Cortes. The latter hastened his preparations, and, on the 18th of November, 1518, he set out from St. Iago, with 10 vessels, 600 or 700 Spaniards, 18 horsemen, and some pieces of cannon. Scarcely had he set sail, however, when Velasquez, probably apprehensive that his lieutenant would carry off all the glory as well as the profit of the enterprise, recalled the commission which he had granted to Cortes, and even ordered him to be put under arrest; but the attachment of the troops, by whom he was greatly beloved, enabled him to persevere in spite of the governor; and on the 4th of March, 1519, he landed on the coast of Mexico. Advancing along the gulf, sometimes taking measures to conciliate the natives, and sometimes spreading terror by his arms, he took possession of the town of Tabasco. The noise of the artillery, the appearance of the floating fortresses which had transported the Spaniards over the ocean, and the horses on which they fought, all new objects to the natives, inspired them with astonishment mingled with terror and admiration; they regarded the Spaniards as gods, and sent them ambassadors with presents. Cortes here learned that the native sovereign was called

slain in 1527 by Nicaragus Indians.—Am. Ed.]



Montezuma; that he reigned over an extensive empire, which had lasted for three centuries; that thirty vassals, called caciques, obeyed him; and that his riches were immense and his power absolute. No more was necessary to inflame the ambition of the invader, who did not hesitate to undertake the conquest of this great empire, which could only be effected by combining stratagem and address with force and courage. He laid the foundation of the town of Vera Cruz, caused himself to be elected captain-general of the new colony, and, like Agathocles, burned his vessels to cut off the possibility of retreat and show his soldiers that they must either conquer or perish. He then penetrated into the interior of the country, drew to his camp several caciques hostile to Montezuma, and induced these native princes to facilitate his progress. The republic of Tlascala, which was hostile to Montezuma, opposed him; but he routed its army, which had resisted all the forces of the Mexican empire, dictated peace on moderate terms, and converted the people into powerful auxiliaries. His further advance was in vain attempted to be checked by an ambuscade laid by the inhabitants of Cholula, on whom he took signal vengeance. Surmounting all other obstacles he arrived, with 6000 natives and a handful of Spaniards, in sight of the immense lake on which was built the city of Mexico, the capital of the empire. Montezuma received him with great pomp, and his subjects, believing Cortes to be a descendant of the sun, prostrated themselves before him. The first care of Cortes was to fortify himself in one of the beautiful palaces of the prince, and he was planning how to possess himself of the riches of so opulent an empire, when intelligence reached him that a general of the emperor who had received secret orders had just attacked the garrison of Vera Cruz and killed several of his soldiers. The head of one of the Spaniards was sent to the capital. This event undeceived the Mexicans, who had hitherto believed the Spaniards to be immortal, and necessarily altered the whole policy of Cortes. Struck with the greatness of the danger, surrounded by enemies, and having only a handful of soldiers, he conceived and instantly executed a most daring project. Having repaired with his officers to the palace of the emperor, he announced to Montezuma that he must either accompany him or perish. Being thus master of the person of the monarch, he next demanded that the Mexican general and his officers who had attacked the Spaniards should be delivered into his hands; and when this had been done he caused these unfortunate men, who had only obeyed the orders of their sovereign, to be burned alive before the gates of the imperial palace. During this cruel execution Cortes entered the apartment of Montezuma, and caused him to be loaded with irons, in order to force him to acknowledge himself a vassal of Charles V. The unhappy prince yielded, and was restored to a semblance of liberty on presenting the fierce conqueror with 600,000 marks of pure gold, and a prodigious quantity of precious stones. Scarcely had he reaped the fruits of his audacity, however, when he was informed of the landing of a Spanish army, under Narvaez, which had been sent by Velasquez to compel him to renounce his command. In this emergency Cortes acted with his usual decision and courage. Leaving 200 men at Mexico under the orders of his lieutenant, he marched against Narvaez, whom he defeated and made prisoner, and he then enlisted under his standard the Spanish soldiers who had been sent to attack him. On his return to the capital, however, he found that the Mexicans had revolted against the emperor and the Spaniards, and that dangers thickened around him. Montezuma perished in attempting to address his revolted subjects, upon which the latter, having chosen a new emperor, attacked the headquarters of Cortes with the utmost fury, and, in spite of the advantage of fire-arms, forced the Spaniards to retire, as the only means of escaping destruction. Their rear-guard, however, was cut in pieces, and they suffered severely during the retreat, which was continued during six days. Elated with their success, the Mexicans offered battle in the plain of Otumba. This was what Cortes desired, and it proved their destruction. Cortes gave the signal for battle, and on the 7th of July, 1520, gained a victory which decided the fate of Mexico. Immediately afterwards he proceeded to Tlascala, assembled an auxiliary army of natives, subjected the neighboring provinces, and then marched a second time against Mexico, which, after a gallant defence of several months, was retaken on

the 13th of August, 1521. These successes were entirely owing to the genius, valor, and profound but unscrupulous policy of Cortes; and the account of them which he transmitted to Spain excited the admiration of his countrymen. The extent of his conquests, and the ability he had displayed, effaced the censure which he had incurred by the irregularity of his operations; and public opinion having declared in his favor, Charles V., disregarding the pretensions of Velasquez, appointed him governor and captain-general of Mexico, at the same time conferring on him the valley of Guaxaca, which was erected into a marquissate, with a considerable revenue. But although his power was thus confirmed by royal authority, and although he exerted himself to consolidate Spanish domination throughout all Mexico, the means he employed were such that the natives, reduced to despair, took arms against the Spaniards. This revolt, however, was speedily subdued, and the Mexicans were everywhere forced to yield to the ascendancy of European discipline and valor. Guatimozin, who had been recognized as emperor, and a great number of caciques, accused of having conspired against the conquerors, were publicly executed, with circumstances of great cruelty, by order of Cortes. Meanwhile the court of Madrid, dreading the ambition and popularity of the victorious chief, sent commissioners to watch his conduct and thwart his proceedings; and whilst he was completing the conquest of New Spain, his goods were seized by the fiscal of the Council of the Indies, and his retainers imprisoned and put into irons. Indignant at the ingratitude of his sovereign, Cortes returned in person to Spain to appeal to the justice of the emperor, and appeared there with great splendor. The emperor received him with every mark of distinction, and decorated him with the order of St. Iago. Cortes returned to Mexico with new titles but diminished authority, a viceroy having been intrusted with the administration of civil affairs, whilst the military department, with permission to push his conquests, was all that remained to Cortes. This division of powers became a source of continual dissension, and caused the failure of the last enterprises in which he engaged. Nevertheless, in 1536 he discovered the peninsula of California, and surveyed a part of the gulf which separates it from Mexico. At length, tired of struggling with adversaries unworthy of him, whom the court took care to multiply, he returned to Europe, hoping to confound his enemies. But Charles V. received him coldly. Cortes dissembled, redoubled the assiduity of his attendance on the emperor, accompanied him in the disastrous expedition to Algiers in 1541, served as a volunteer, and had a horse killed under him. This was his last appearance in the field, and if his advice had been followed the Spanish arms would have been saved from disgrace, and Europe delivered nearly three centuries earlier from the scourge of organized piracy. Soon afterwards he fell into neglect, and could scarcely obtain an audience. One day, however, having forced his way through the crowd which surrounded the emperor's carriage, and mounted on the doorstep, Charles, astonished at an act of such audacity, demanded to know who he was. "I am a man," replied the conqueror of Mexico proudly, "who has given you more provinces than your ancestors left you cities." This haughty declaration of important services ill-requited could scarcely fail to offend a monarch on whom fortune had lavished her choicest favors; and Cortes, overwhelmed with disgust, withdrew from court, passed the remainder of his days in solitude, and died near Seville on the 2d of December, 1554, being then in the sixty-third year of his age.

The only writings of Cortes are five letters on the subject of his conquests, which he addressed to Charles V., and which have fortunately been given to the world. The best edition of them is that of Don Francisco Antonio Lorenzana, archbishop of Mexico, entitled *Historia de Nueva-España escrita por su esclarecido conquistador, Hernan Cortes, aumentada con otros documentos y notas* (Mexico, 1770, 4to) a work the noble simplicity of which attests the truth of the recital it contains. An English translation of the letters, by George Folsom, was published at New York in 1843. The conquests of Cortes have been described with pompous elegance by Antonio de Solis in his *Historia de la Conquista de Mexico*, and with more truth and simplicity by Bernardo Dias del Castillo in his work under the same title. See also Robertson's *History of America*, Prescott's *History of the Conquest of Mexico*, and Sir Arthur Helps's *Life of Hernando Cortes* (2 vols., Lond., 1871).

CORTESE. See COURTOISE.

CORTONA, a city of Italy, in the province of Arezzo, and about thirteen miles south of the city of that name, occupying the summit and slope of a steep hill that, from a height of 2000 feet above the sea, overlooks the fertile valley of the Chiana or Clanis. Its ancient fortifications, which are well preserved in almost their total circuit, present not only portions of Roman and mediæval works, but magnificent specimens of the so-called Cyclopean architecture. The cathedral, a building of the 15th century, but restored by Galilei in the 18th, contains a number of paintings by Luca Signorelli and Pietro Berettini, who were both natives of the town; the tomb of John Baptist Tommasi, the last grand-master of the Order of Malta; and a large sarcophagus, adorned with bas-reliefs of the Lapithæ and Centaurs, in which, according to the fanciful hypothesis of the local antiquaries, were the remains of the Consul Flaminius, who perished in the battle of Lake Trasymene against the Carthaginian invader. Among the other churches, which are almost all in possession of paintings of interest to connoisseurs, the most important is Santa Margherita, a fine building of the 13th century by Nicola and Giovanni Pisano, which occupies the top of the hill and is embosomed in cypress trees. The *Accademia Etrusca*, founded by Ridolfino Venni in 1726, has a museum in the *palazzo pretorio*, which numbers amongst its various treasures a bronze candelabrum of sixteen lights, ranked among the finest specimens of Etruscan art. In the same building is preserved the Bombuci Library, which contains a fine MS. of Dante and a curious unpublished work called the *Notti Cortiane*, or *Nights of Cortona*. Outside of the town is an Etruscan tomb of some architectural interest, known as the Grotto of Pythagoras. The population of the commune is upwards of 26,000; that of the city is only 3973.

The origin of Cortona, or Corythus, as it is called by Virgil, is lost in remote antiquity; and little light is thrown on the question by the statement of Dionysius that it was founded by the Umbrians, and passed from them to the Pelasgians. It was certainly one of the most powerful of the twelve Etrurian cities, and continued to maintain its position under the Romans; but probably from the fact that its supposed impregnability led the successive conquerors of Italy to pass it by, its name is rarely found in the ancient classics, and we are even ignorant of the date when it first fell into the hands of the Romans. It was colonized about the end of the 2d century B.C., but as the colony was never renewed it is not mentioned in the lists of Pliny or Ptolemy. It was one of the first bishoprics of the Christian church; and after the barbarian invasions, it reappears in the Middle Ages as a place of importance. Held for about a century by the Casale family, it was transmitted by them to King Ladislas of Naples, who, in his turn, in 1412 bestowed it on the Florentines.

CORUNNA (Spanish *La Coruña*; French, *La Corogne*; English, formerly often *The Groyne*), a city and seaport of Spain, the capital at one time of Galicia, and now of a province of its own name, is situated on the north-west coast, 43 miles north of Santiago de Compostella, in 43° 23' N. lat. and 8° 27' W. long. It is of first rank both as a fortress and a port, and is the seat of a superior court and a commercial tribunal. There is an upper and a lower town, the former built on the east side of a small peninsula, and the latter on the isthmus connecting the peninsula with the mainland. The upper town is the more ancient, and is still surrounded by walls and bastions and defended by a citadel; but it has been gradually outgrown by the lower, which, though at first a mere *Pescaderia*, or fishing-village, is now comparatively well built, and has several broad and handsome streets. There is little remarkable in the public buildings, though they include six churches, of which Santiago dates from the 11th and the *Colegiata* from the 13th century, five convents, two hospitals, a palace for the captain-general of Galicia, a theatre, a school of navigation, an arsenal, and barracks. The harbor, though of rather difficult access, is perfectly secure, and it is defended by several forts, of which the most important are San Diego on the east and San Antonio on the west. These fortifications are of little practical importance on the land side, as they are commanded by a hill that overlooks the city. The so-called Tower of Hercules to the north, supposed to have been originally built by the Romans, has been raised in modern times to a height of upwards of 360 feet, and is now crowned with a fine revolving light visible for a distance of twelve miles to sea. English, French, and Belgian

steamers call here on their way to South America for mail or emigrants; and upwards of 300 merchant ships, mostly British, enter the port every year. The trade consists mainly in the export of fat cattle—20,000 of which were sent to England in 1873,—eggs, meats, fruits, and sardines; and in the importation of general grocery goods and manufactured articles. Besides a large Government tobacco-factory, which employs about 3000 women, there are in the city two glass-factories, two cotton-factories, and several steam saw-mills and sardine-curing establishments; and the herring and the pilchard fisheries give employment to a number of the inhabitants. According to the census of 1869, the population of the town and suburbs was about 30,000; and in 1874 it was estimated at 40,000.

Corunna, possibly at first a Phœnician settlement, is identified with the ancient *Ardobrica*, a seaport mentioned by Mela in the country of the Artabri, from whom the name of *Portus Artabrorum* was given to the bay on which the city is situated. In the Middle Ages, and probably at an earlier period, it was called *Caronium*, a name which is much more probably the origin of the present designation than the Latin *Columna* which is sometimes put forward. The harbor has always been of considerable importance, but it is only in comparatively modern times that it has made a figure in history. In 1588 it gave shelter to the Invincible Armada; and in 1598 the town was captured and burned by the English under Drake and Norris. In 1747, and again in 1805, the bay was the scene of a naval victory of the English over the French; and in 1809 an action took place in the neighborhood which has become one of the most celebrated in British military annals. The French under Marshal Soult attempted to prevent the embarkation of the English under Sir John Moore, but were successfully repulsed in spite of their numbers. Moore was mortally wounded in the engagement, and expired shortly after its termination. He was hastily buried on a bastion near the sea; and a monument in the *Jardin de San Carlos* raised by the British Government commemorates his bravery and intrepidity. In 1820 the town joined the revolutionary movement and declared the constitution, but in 1823 it had to capitulate to Bourck, the French general.

CORVEY, a famous Benedictine abbey in Saxony, situated on the Weser, in the neighborhood of Hörter, with which it communicates by an avenue about three-quarters of a mile in length. It was founded by Louis the Pious in 813, and received its name from the fact that the first body of monks by whom it was held came from Corbie in Picardy. Raised to the rank of a bishopric in 1793, it was secularized in 1802, and bestowed on the Nassau Orange family; and since then it has passed through various hands to those of the present prince of Ratibor, who received it in 1840 by the will of Victor Amadeus of Hesse-Rothenberg. The abbey, or, as it is now called, the castle of Corvey, possesses a very extensive library, especially rich in old illustrated works; but the ancient collection due to the literary enthusiasm of the Benedictines is no longer extant. It at one time preserved the famous manuscript of Tacitus which contains the six books of the *Annals*. Widukind composed his history of the Saxons within the precincts of Corvey; and the *Annales Corbejenses* of the monks can still be read in Pertz's *Monumenta Germanicæ Historica*, vol. iii. The *Chronicon Corbejense*, published by Wedekind in 1324, has been proved a forgery. (See Wigand, *Geschichte der Abtei Korvey*, Hörter, 1819, and *Der Korveische Güterbesitz*.)

CORVISART-DESMARETS, JEAN NICOLAS, BARON DE (1755–1821), French physician, was born at Vouziers, in Champagne. His parents intended him for the profession of the law, but he turned aside to the study of medicine, in which he took an enthusiastic interest. He became parish doctor of Saint-Sulpice, and then obtained a post in the hospital of La Charité, where he founded a flourishing clinical school. He was next appointed professor in the Collège de France (in which position he was eminently successful), and member of the Academy of Sciences. But he was still struggling with debt when the Empress Josephine introduced him to Napoleon, by whom he was created baron and member of the Legion of Honor. His only original work of importance is his *Essay on Diseases of the Heart and the Great Vessels*.

CORVUS, M. VALERIUS, one of the most illustrious generals of the early Roman republic, was born about 370 B. C. The legend which accounts for his cognomen of *Corvus* (the raven) tells how, while fighting with a gigantic Gaul, he was assisted by a raven, which baffled his enemy by fluttering in his face. He was twice dictator and six

times consul, and he occupied the curule chair twenty-one times. In his various campaigns he defeated successively the Gauls, the Volsci, the Samnites, the Etruscans, and the Marsi. His most important victory was that which he won over the Samnites at Mount Gaurus (343 B. C.). He died a hundred years old about 270 B. C.

CORYATT, THOMAS (1577-1617), was born at Odcombe, Somersetshire, where his father, the Rev. George Coryatt, prebendary of York Cathedral, was rector. Educated in Westminster School and Gloucester Hall, Oxford, he entered the household of Prince Henry, the eldest son of James I. In 1611 he published a curious account of a walking tour, under the title of *Coryatt's Crudities hastily gobbled up in Five Months' Travels in France, Italy, &c.* At the command of Prince Henry, verses in mock praise of the author (afterwards published by themselves as the *Od-combian Banquet*) were added to the volume, written in a number of languages, and some in a mixture of languages, by Ben Jonson, Donne, Chapman, Drayton, and many other of the literary men of the time. In the same year he published a second volume of a similar kind, *Coryatt's Crambe, or his Coleworte twice Soddén.* In 1612 he set out on another journey, which also was mostly performed on foot. He visited Greece, the Holy Land, Persia, and Agra, whence he sent home an account of his adventures. He died at Surat in 1617.

CORYBANTES, in Greek mythology, were associated with the Phrygian goddess Rhea Cybele as her first worshippers and priests. They were of the same class of beings as the Curetes, Cabiri, and Dactyls of Mount Ida in Crete, and were of the nature of *dæmones*, supposed by some to have sprung from the earth like trees (*δερύποδες*). The wild orgiastic dance with clangor of music, which was part of the worship of Cybele, was traced to them, and was called *κορυβαντία*, whence a derivation of their name has been sought in a word to express this din of music and dance. An old derivation traced it to *Κόρυον*, a hill said to be in Cyprus, but not otherwise known to be there. Besides the power of music the Corybantes exercised also cures by magic and other arts of superstition. Of the other *dæmones* with whom the Corybantes were identified in antiquity the Cabiri have already been described (see CABIRI). The Curetes were associated with the infancy of Zeus in Crete, where they kept guard over him, dancing and clanging their shields. They were thought of as having skill in working in metals and in finding them under the earth. They had also prophetic powers, and made a wild dance part of their ceremony of worshipping Zeus. Through being identified with the Corybantes they became associated with the goddess Cybele, and were found connected with her worship in its various centres in Asia Minor. The Dactyls of Crete were distinctly associated with Rhea Cybele, and were chiefly thought of as being possessed of metallurgic powers, as their names, Kelmis, Damnameneus, and Akmon, imply, though they were also skilled in music.

CORYPHÆUS (from *κορυφή*, the top of the head), in ancient tragedy, was the leader of the chorus. Hence coryphæus passed into a general name for the chief or leader of any company or movement.

COS (or STANKO, or STANCHIO, by corruption from *ἑρὰν Κώ*), an island in that part of the Turkish archipelago which was anciently known as the Myrtoan Sea, not far from the south-western corner of Asia Minor, at the mouth of the Gulf of Halicarnassus, or Bay of Budrum. Its total length is about 25 miles, and its circumference about 74. A considerable chain of mountains, known to the ancients as Oromedon, or Prion, extends along the southern coast with hardly a break except near the island of Nisyros; so that the greatest versant and most important streams turn towards the north. The whole island is little more than a mass of limestone, and consequently unites great aridity in the drier mountain regions with the richest fertility in the alluvial districts. As the attention of the islanders is mainly directed to the culture of their vineyards, which yield the famous Sultana raisins, a considerable proportion of the arable land is left untouched, though wheat, barley, and maize are sown in some quarters, and melons and sesamum seed appear among the exports. Formerly one of the most valuable products of the island was its lemons and oranges, but since the destruction of the trees by a severe frost in 1850, these fruits hardly take any place in the market. The wild olive is abundant

enough, but neglected; and cotton, though it thrives well, is only grown in small quantities. As the principal harbor, in spite of dredging operations, is only fit for smaller vessels, the island is not of so much commercial importance as it would otherwise be; but since 1868 it has been regularly visited by steamers, and about fifty vessels annually enter the harbor. The only town in the island is Cos, or Stanko, at the eastern extremity, remarkable for its fortress, founded by the knights of Rhodes, and for the gigantic plane-tree in the public square. The fortress is supposed to occupy the site of the temple of Æsculapius so celebrated in antiquity, and it preserves in its walls a number of interesting architectural fragments. The plane-tree has a circumference of about 30 feet, and its huge and heavy branches have to be supported by pillars; of its age there is no certain knowledge, but the popular tradition connects it with Hippocrates. The town is supplied by an aqueduct, about four miles in length, with water from a hot chalybeate spring, which is likewise named after the great physician of the island. The villages of Pyli and Kephala are interesting, the former for the Greek tomb of a certain Chamylos, and the latter for a castle of the knights of St. John and the numerous inscriptions that prove that it occupies the site of an ancient city called Isthmos. The population of the island amounts to about 10,400 souls, of whom about a third are Mahometans, and the rest, with the exception of a dozen Jewish families, Christians.

Cos is said to have been colonized from Epidaurus, the great Peloponnesian centre of the worship of Æsculapius, and it is certain that the Æsculapian cultus had a remarkable hold in the island. For a time the city was a member of the Dorian Pentapolis which held its federal assemblies in the Triopian headland; but at a later date it became subject to the Athenians, by whom it was fortified. The Emperor Claudius made it a free state, and to Antoninus Pius it was indebted for restoration from the effects of a great earthquake. During the Greek and Roman period the island was famous for its purple and its wines; the Coan robes were celebrated by the poets for the delicacy and transparency of their texture; and it also enjoyed a nobler celebrity as the birthplace of Hippocrates the physician and Apelles the artist. In modern times its history presents few details, the most interesting fact being its possession by the knights of St. John.

See Clarke's *Travels*, vol. ii., 1812; Küster, *De Co Insula*, Halle, 1833; Ross, *Reisen nach Kos, Halicarnassus, &c.*, Halle, 1852; and *Reisen auf den Griech. Inseln*; Leake's paper in the *Transactions of the Roy. Soc. of Lit.*, 1843; C. T. Newton, *Travels and Discoveries in the Levant*, 1865.

COSENZA, a city of Italy, the seat of an archbishopric, and the capital of the province of Calabria Citra, is situated in a deep glen at the junction of the Busento with the Crati, twelve miles east of the Mediterranean. It is intersected by the Busento, which is there crossed by two bridges. The streets are generally narrow and crooked, and the lower part of the town is said to be unhealthy. The *tribunale*, or palace of justice, one of the finest edifices in the kingdom, is on the eastern bank; and an old castle, now used as barracks, crowns the summit of an eminence on the opposite side of the river. It has also a diocesan seminary, a royal college, a theatre, a founding hospital, and academies of science and literature, manufactures earthenware and cutlery, and trades in silk, rice, wine, fruits, and flax. Population of the commune, 15,960; of the city, 12,613.

Cosenza is a place of great antiquity, having under the name of Consentia been the chief city of the Bruttii. It was possibly captured by Alexander of Epirus, and certainly became the place of his sepulture. After various vicissitudes during the Carthaginian war, it was finally reduced by the Romans about 204 B.C.; and in the reign of Augustus it received a Roman colony. Alaric, king of the Goths, died while besieging the city in 410 A.D., and was buried in the bed of the Busento, which was turned from its course for his interment. During the Middle Ages the city retained its importance, and in the 11th century it was raised to the rank of an archbishopric. In 1461 it was taken by Roberto Orsini, and suffered severely; and in the beginning of the present century, it was the seat of the French commission which made itself so notorious by its sanguinary proceedings in Calabria. Among its celebrities may be mentioned the grammarian Parrhasius and the philosopher Telesio.

COSIN, JOHN (1594-1672), bishop of Durham, was born at Norwich, November 30, 1594. From the grammar

school of his native city he passed, at the age of sixteen, to Caius College, Cambridge, where he graduated B. A. After a few years he took holy orders and was appointed domestic chaplain to the bishop of Durham. At the close of 1624 he was made a prebendary of Durham, and in the following year archdeacon of the East Riding of Yorkshire. Before this time he had married, and in 1628 he took his degree of D. D. He first became known as an author in 1627, when he published his *Collection of Private Devotions*, a manual stated to have been prepared by command of the king, Charles I., for the use of the maids of honor to the queen. This book, in connection with his insistence on points of ritual in his cathedral church and his friendship with Bishop Laud, exposed him to the suspicion and hostility of the Puritans; and the book was rudely handled by Prynne and Burton (who both, nine years later, were set in the pillory and mutilated for their free speeches on other matters). In the year following this publication Cosin took part in the prosecution of Prebendary Smart for a sermon against Papistical bishops and priests and practices; and the prebendary was deprived. In 1634 Cosin was appointed master of Peterhouse, Cambridge; and in 1640 he became vice-chancellor of the university. In October of this year he was promoted to the deanery of Peterborough. A few days before his installation the Long Parliament had met; and among the complainants who hastened to appeal to it for redress was the ex-prebendary Smart. His petition against the new dean was considered; and early in 1641 Dr. Cosin was sequestered from his benefices. Articles of impeachment were, two months later, presented against him, but he was dismissed on bail, and was not again called for. He took part, in 1642, in sending the university plate to the king, and was for this offence deprived of the mastership of Peterhouse. He thereupon withdrew to France, preached at Paris, served as chaplain to some members of the household of the exiled royal family, and at the Restoration he returned to England. He was reinstated in the mastership, restored to all his church benefices, and in a few months raised to the see of Durham (December, 1660). This dignity he enjoyed for about eleven years; and during this time he applied a large share of his revenues to the promotion of the interests of the church, of schools, and of charitable institutions. He died in London, January 15, 1672.

Among his writings are a *Historia Transubstantiationis Papalis*, *Notes and Collections on the Book of Common Prayer*, and a *Scholastical History of the Canon of the Holy Scriptures*. A collected edition of his works, forming 5 vols. of the Oxford Library of Anglo-Catholic Theology, was published between 1848 and 1855.

COSMAS, surnamed from his maritime experiences *Indicopleustes*, a writer of the 6th century. We know nothing of his history except what can be gathered from one of his works which has come down to us, a book which is in itself a mere bank of mud, but is remarkable on account of certain geographical fossils of considerable interest which are found imbedded in it. The first part of the work, embracing books i.-v., can be shown to have been written soon after 535; to these seven more books appear to have been gradually added by the author. He was a monk when he wrote, but in earlier days apparently had been a merchant, and in that capacity had sailed on the Red Sea and the Indian Ocean, visiting Abyssinia and Socotra (*Αἰθιοπία* and *ἡ νῆσος ἡ καλουμένη Διοσκορίδους*), and apparently also the Persian Gulf, Western India, and Ceylon. The book, which was written at Alexandria, is called by the writer *Χριστιανικὴ τοπογραφία περιεκτικὴ παντὸς τοῦ κόσμου*, *A Christian Topography Embracing the Whole World*, and the great object of it is to denounce the false and heathen doctrine of the rotundity of the earth, and to show that the tabernacle in the wilderness is the pattern or model of the universe. Thus the earth is a rectangular plane twice as long as it is broad. The heavens come down to the earth on all four sides like the walls of a room. From the north wall to the south wall, at an undefined level, a semi-circular wagon vault is turned, and at the same level stretches the "firmament" (*στερέωμα*) like a flat ceiling. All below the firmament is this world; the story above is heaven, or the world to come. In fact, one of the huge receptacles in which female travellers of our own day carry their dresses forms a perfect model of the universe of Cosmas. Midway in the rectangular surface

below lies the inhabited earth, encompassed by Ocean. Beyond Ocean, bordering the edge, is the unvisited transoceanic land on which, in the far east, lies Terrestrial Paradise. Here, too, on a barren and thorny soil, without the walls of Paradise, dwelt man from the fall to the deluge. The ark floated the survivors across the great ocean belt to this better land which we inhabit. The earth rises gradually from south to north and west, culminating in a great conical mountain behind which the sun sets. Repeatedly the writer overflows with indignation against those who reject these views of his, "not built on his own opinions and conjectures, but drawn from Holy Scripture, and from the mouth of that divine man and great master, Patricius."<sup>1</sup> The wretched people who chop logic, and hold that the earth and heaven are spherical, are mere blasphemers, given up for their sins to the belief of such impudent nonsense as the doctrine of Antipodes, and so forth. Altogether the book is a kind of caricature type of that process of loading Christian truth with a dead weight of false science which has had so many followers and done so much mischief. Similar cosmography was taught by Diodorus of Tarsus, and other Nestorian doctors.

Among the curious pieces of information very sparsely found amid this stuff are notices of *Ethiopia* (Abyssinia) and its traffic for gold with Inner Africa, of *Tuprobane* or *Sielediba* (Ceylon), *Male* (Malabar), and the products and animals of those regions. But the most interesting geographical circumstance is the fact that Cosmas is not only the first who mentions China by a name on which there can be no controversy, *Tzinista*, i.e., the Persian *Chinistān*, but also that he had a very correct idea of its position as lying on the extreme eastern coast of Asia, and "compassed by the ocean running round it to the left just as the same ocean encompasses Barbary (i.e., the Somali country beyond Abyssinia) round to the right." He knew also that a ship sailing to China, after running east for a long way, and leaving the Clove Country behind, had to turn north at least as far as a ship bound for Chaldea would have to run up the Persian Gulf, and thus it was intelligible how *Tzinista* by the overland route lay much nearer Persia than might have been thought from the length of the sea voyage thither.

The work has been preserved in at least two MSS. One is in the Vatican, a very fine uncial MS. of the 8th century, with figures apparently from drawings by Cosmas himself; the other a parchment MS. of the 10th century, is in the Medicean. This last alone contains the 12th book, and of that a leaf is lost. An account of the work is given in the *Bibliotheca* of Photius, who speaks contemptuously of the author. Some geographical extracts were first published in Thévenot's *Collection of Travels* (1696). The whole work was edited by Montfaucon in his *Collectio nova Patrum et Script. Græc.*, 1706 (vol. ii.), and is republished in *Bibl. Veterum Patrum* of P. Andrea Gallandi (vol. xl, Venice, 1776). It appears from allusions in the book itself that Cosmas also wrote a more detailed *Topography of the Earth*, a work on the motions of the stars, and a *Commentary on Canticles*. The loss of the first is to be regretted. (S. r.)

COSMAS, of Prague (1045-1126), a Bohemian priest and historian, wrote a *Chronicon Bohemorum*, which contains the history and traditions of his country up to nearly the time of his death. This work was printed in 1602, and again among the *Scriptores Rerum Bohemicarum* (Prague, 1783).

COSMOGONY, a theory of the origin of the world and its inhabitants. Such a theory is never found on the lowest stage of human culture. Thus, "it never occurred to the Eskimos," says Dr. Brinton, "that the earth had a beginning;" and the Abipones of South America "never troubled themselves about what went on in the heavens" (Sir J. Lubbock). And even when a theory of the world's origin is formed, it is at first of the simplest character. Two elements, no more, are necessary. With regard to the first, there is a consensus of opinion among primitive races that, before the present order of things, water held all things in solution. Thus the Accadians, whose mythology passed into that of the Semitic Babylonians, "considered the humid element as the vehicle of all life, the source of all generation" (Lenormant). To "make pregnant" this "vast abyss" a creator or organizer is necessary, who is educed, at least not unfrequently, from the

<sup>1</sup> This Patricius is stated by Cosmas to have been afterwards *Cuthocus* of Persia. This and other circumstances identify Patricius with Mar Abbas, who ruled the Nestorian Church from 536 to 552 (see Assemani, *Bibl. Orient.*, tom. ii. and iii.).

abyss itself. Thus, in a Japanese myth reported by Mr. Tylor (*Journ. of Anthropol. Inst.*, July, 1876), "while the earth is still soft like mud, or like oil floating on the surface of water, there arises out of the mass the flag or rush called *aei*, from which there springs the land-forming god." Some, content with throwing the speculative difficulty further back, imagine the present creation to be rather a re-creation. Hence the notion of world-ages "rounded off by sweeping destructions," the last of which was the deluge. Thus, among the non-Aryan Santals of Bengal, "the tradition of the creation is mixed up with one of the deluge, if indeed the creation with these less gifted races does not begin with the flood. . . . The Santal legend describes rather the subsidence of waters than a creation" (Dr. Hunter, *Rural Bengal*, pp. 150-1). Some simple-minded tribes suppose the earth to have been fished up from the depths of the sea, that is, from the transparent depths of their own Pacific (Waits and Gerland, *Anthropologie der Naturvölker*, vi. 241). The egg is another common mythic element. It is found in Phœnicia, Egypt, India, China, Polynesia, and Finland, associated with one or another of the ideas of mixture, generation, fragility, the dome-like appearance of the sky, and the form of the sun and the planets. The Creator himself assumes the most Protean shapes, ranging from the magnified man to the musk-rat. From this brief introduction we pass on to a few specimen cosmogonies of the more important races.

Until the year 1876 our materials for the Babylonian cosmogony were almost entirely confined to second-hand extracts from Berosus (? 280-260 B. C.). Many (Niebuhr was not among them) doubted their trustworthiness. But the reign of scepticism is over. The late talented decipherer, George Smith, has, it would seem, actually discovered some of the cuneiform tablets from which the priest of Bel compiled. No doubt Berosus was uncritical—he was an Euhemerist, like his contemporaries. But he was honest and learned in cuneiform, and enjoyed access to unmutated documents, whereas the tablets in our possession are fragmentary, and their interpretation is only inchoate. We cannot, therefore, yet afford to ignore the Berosian narratives, which Syncellus and others have preserved. (See Müller's *Fragmenta Histor. Græc.*, ii. 497, and with caution Cory's *Ancient Fragments*, by Hodges, pp. 58-60.) One of these contains a cosmogony, or rather two cosmogonies, the latter of which is fragmentary, and fitted rather awkwardly into the former. Its resemblances to Gen. i. are obvious, such as the primeval flood, which Berosus calls Thauath (= *Tihavtu* or *Tihamtu*), and creation by cutting or dividing. But the divergences are equally striking—e.g., Berosus tells of certain composite beings who dwell in the dark primeval water. This seems to indicate that the water means the æther, which is in fact one of its mythic senses, and that the monsters are the constellations. Mr. G. Smith compares this narrative with a tablet derived from the city of Cutha (*Chaldean Account*, etc., pp. 102-3), but the parallel is fallacious. Tiamat, the primeval flood, is only mentioned in the latter incidentally, and the monsters are placed on the earth, not in Tiamat.

But there is a much more important cosmogony, for which we are indebted to the library of King Assurbanipal (673-626 B. C.). The tablets (probably twelve in number) are copies of much older originals, which Mr. G. Smith would place near 2000 B. C., i. e., at the beginning of the literary period. This is perhaps too early, to judge from the absence of a statement in the colophon that the copy had an "old" original (Mr. Sayce in *Academy*, ix. 4). But "late" in Babylonian history is still early from the point of view of Greek and Hebrew literary history. The fragments have been arranged by Mr. Smith on valid internal grounds in an order corresponding to the cosmogony in Gen. i. The Babylonian parallels are very striking, and would probably be still more so if the tablets were complete. They are—(1) the general arrangement, (2) the introduction of a god speaking, (3) the notion of the primeval flood, called *tiamat* (feminine) like the *têhom* (masculine) of Gen. i., (4) the repeated eulogy on the previous creative work as "delightful," and (5) the mention of the stars as placed to determine the year. The chief differences arise from the polytheism of Babylonia, and yet some have seen a survival of polytheistic language in Gen. i. 26.

The sacred archives, now lost, of the Phœnicians were known, it seems, to Sanchoniathon, who found a translator (?) in Philo of Byblus (end of 1st century A. D.). The origin

and value of Philo's work (only known from the extracts in Eusebius) have been discussed by Ewald and M. Renan, with a tolerably satisfactory result. The latter, writing from the shores of Phœnicia, calls it "the admirably faithful mirror of that which I have under my eyes" (*Rev. archéol.* iii., 172). Distorted and discolored as the myths in Philo may be, they are such as no forger could have invented. Among them are parts of two, if not three, cosmogonies (Müller, *Fragm. Hist. Gr.*, iii. 565, comp. with caution Cory's *Anc. Fragments*, pp. 1-5). The text is here and there corrupt, and its mythic meaning obscure. Movers and Bunsen are fantastic, nor can we accept Mr. Sayce's theory (*Academy*, March 20, 1875), though he is right in seeking for a clue in Babylonia. The first part, however, is clear, with its chaos black as Erebus, and its wind (comp. Gen. i. 2) which became enamored of its own elements. The explanation of this is due to M. de Vogüé (*Mélanges*, pp. 60, 61). The wind is the creating deity regarded as one; the *ápçai* are the two sides or persons of the deity when analyzed. In the inscriptions we find both Baal and Tanith, "the Name, or Face, of Baal." i. e., the male and female principles, the conjugal union of which produced creation. In another cosmogony we meet with the woman Baan, "which is interpreted Night," probably the *bôhu*, or chaos of Gen. i. 2 (a Babylonian parallel has also been found). On the whole these cosmogonies agree with the Babylonian and portions of the Hebrew, though laying a somewhat greater stress on the life-evolving power of matter (which may be due to the systematizers), and in one case ("Chysor, the opener" = the Egyptian demiurge Ptah) influenced from Egypt. The Semitic (and probably pre-Semitic) notion of creation by division is, however, no longer traceable.<sup>1</sup>

Such were the myths current among the near relatives of the Israelites. But what beliefs had the Israelites themselves? The old Testament contains three cosmogonies:—Gen. i.-ii. 4a; Gen. ii. 4b-7; and Prov. iii. 19, 20, viii. 22-31 (with Job xv. 7, 8). Only the first is perfect. The second seems to be fragmentary, and adds but little to our knowledge. The third is poetical and speculative. All three apparently proceed from the lettered class, and have been attributed to an outburst of historic and prehistoric study in the Babylonian and Persian period. It would be too much to say that the Israelites had no cosmogony before the exile, but the probability is that it was comparatively undeveloped, and in the competition of beliefs had fallen into the background. The chief characteristic of Gen. i. is the union of two apparently inconsistent phraseologies, the supernaturalistic and the evolutionary. Thus the pre-existence of matter seems to be asserted in vv. 2, 3. "Now the earth was (i. e., was involved in) chaos [Heb. *tôhû va-bôhû*], and darkness was upon the face of the flood [Heb. *têhom*], and the wind of Elohim was hovering upon the face of the waters"—this describes the circumstances under which the following act took place; "then Elohim said, Let light (the condition of life) be, and light was." The writer uses language common to other cosmogonies, but strives to accommodate it to his own high type of religion. It was not, he consciously or unconsciously implies, a blind force inherent in nature, which produced the first beginnings of life, nor was the creator himself the offspring of chaos; his demiurge was a supernatural being, whom some orthodox commentators have identified with the Logos of later writers, and who was from the first preparing the "rude mass" for its human inhabitants. The peculiar expression, "the wind of Elohim was hovering," suggests different comparisons; thus, on a far lower stage of religious progress, the Polynesians often describe the heaven-and-air-god Tangaloa as a bird hovering over the waters (Wartz, vi. 241). In the earliest form of the narrative in Gen. i. it may have been "the bird of Elohim;" "wind" seems to be an interpretation. Another peculiar form of expression is the creation of the light before the sun (v. 3), which may be supposed to be paralleled by similar expressions elsewhere. The Egyptian god Thoth, the demiurge, is said to have "given the world light when all was darkness, and there was no sun;" and the Orphic light-god Phanes is anterior to the sun. But it is the place of a commentator to trace similar phenomena throughout the first cosmogony, and also to exhibit the evidence of the

<sup>1</sup> The writer regrets not to have received Graf Bandisain's *Studien über semitischen Religionsgeschichte* in time for this article, but finds nothing to alter in the above remarks.

various redactions through which the section has passed. For, as Dr. Schrader (1863) and Mr. E. Martineau (1868) have shown, the narrative in its original form did not divide creation into days, but merely gave a catalogue of divine works. We need only add that the word for "to create" in Gen. i. originally meant "to carve." The Hellenistic Jews, it is true, took it in the sense of "to create out of nothing," but many think this is not favored by the context in Genesis. The problem of the origin of matter seems not to have arisen among the Jews of the 6th century B. C.

The Egyptians have left us no ancient cosmogonical system, though speculation was early rife among them. They appear to have had three great creative deities. Ptah, "the opener" (of the world-egg?), was probably the god of the cosmic fire, who prepared matter for Amen-Ra to organize. But it was to Ra that the honor of creation was chiefly ascribed (see the unsurpassable hymn in *Records of the Past*, ii. 129-136)—to Ra, i. e., the sun-god, as the people supposed, or the *anima mundi*, as the priests. One of Ra's (later) manifestations was Chnum, the divine breath which stirred the primeval waters (as in Gen. i. 2, except that Chnum is never represented as a bird), and the fashioner of gods and men (see *Records of the Past*, ii. 145, and comp. Gen. ii. 7). Thoth, originally the moon-god, became the principle of creative intelligence, and with him were worshipped the eight cosmic forces called Sesennu. He is called "the tongue of Ra," though elsewhere Ra himself is said to create by a word, and this ascription of speech to the deity is, according to M. Naville, one of the most important points in common between the Egyptian and the Hebrew cosmogonies, to be added therefore to those we have already mentioned,—chaos, the divine breath, the creation of light before the sun, and the moulding hand of the deity.

We hasten on to the Aryan nations of the East. The Iranian parallels to the early chapters of Genesis have been greatly exaggerated. The only really valuable ones are those contained in the Avesta, which, though the date of its final redaction is uncertain, is probably in the main earlier than the return of the Jews from Babylon. The cosmogonical parallels are (1) the ascription of creation to the will of a supernatural deity, and (2) the ideal perfection attributed to the newly created world. Yet even here some deduction is necessary. For apparently the world is produced out of pre-existent matter, according to Genesis (see above); out of nothing, according to the Avesta. And though Ahura-mazda (Ormuzd) is generally described in the Avesta as the sole creator, there is an ancient passage (*Yasna*, ch. xxx.) in which a good and an evil spirit are spoken of as joint-creators. Still, in the period of Darius and Xerxes (to which the first Hebrew cosmogony in its final form probably belongs) we have the best possible evidence for the sole creatorship of Ahura-mazda, for the great cuneiform inscription at Naksh-i-Rustam describes him as "the great God of gods, who made heaven and earth, and made men," and similar language occurs in the royal inscriptions at Elvend, Van, and Persepolis.

There is a well-known Vedic hymn ("Nor aught, nor naught existed," etc.), which has been adduced to prove the antiquity of the most refined speculations among the Hindus. But it seems unwise to adduce this as a typical race-myth, for it probably marks the end rather than the beginning of a theological stage (Goldstücker's *Pāṇini*, p. 144, comp. Max Müller's *Anc. Sansk. Lit.*, pp. 559-565). Another hymn of the same Mandala (*Rig Veda* x. 90) embodies the comparatively naive conception of the world as the covering of the divinity, Purusha being represented as a prodigious body, from which the various parts of creation proceeded. This is intermixed, however, with the much less simple theory of the sacrifice of the cosmogonic agent himself, the primitive unity parting into different forms as the limbs of the victim are served on the altar. In the Śatapatha Brāhmana we meet again with the primeval waters and the world-egg, which according to one account produce Prajāpati, and according to another are produced by him. In the same Brāhmana we find the first mention of the tortoise theory, the origin of which has been well pointed out by Mr. Tylor (*Early History of Mankind*, p. 340). The cosmogony in Manu (Dr. Muir's *Sanskrit Texts*, iv. 26) is still more deeply tinged with speculation. Here we meet with "the self-existent Lord," who "with a thought created the waters, and deposited in them a

seed," which becomes a golden egg, in which egg "he himself is born as Brahmā, the progenitor of all the worlds." Contrast this theory of the speculative Hindu, ascribing creation to a thought, with that of the more energetic Semites and Egyptians—"God said, Let it be, and it was so."

Turning to Africa, we find that Old Calabar and Zulu land are among the few regions where cosmogonical speculation seems to have at least germinated (see Bastian, Callaway, Tylor). Even the important myths of the American and Polynesian races must on this occasion be dismissed in a few lines. With regard to the former, Dr. Brinton's *Myths of the New World* and Mr. Bancroft's *Native Races of North America* will supply the reader with much food for thought. Let him not neglect the poetic narrative of the Quiché, with its Hurakan (comp. "hurricane"), the thunder-god, the Heart of Heaven, and the Creator, nor the still more important myth of the north-west Athapascas, nor, for its curiosity, the "Darwinian theory" of the Ahts of Vancouver Island. With regard to the latter, the sixth volume of Waitz and Gerland, and the works of Sir George Grey (*Polynesian Mythology*) and Mr. Gill (*Myths and Songs of the South Pacific*), are full of suggestive material and remarkable parallels to the myths of more civilized races. The cosmogony, however, which opens Mr. Gill's fascinating collection is too complicated and artificial to be ancient or even (perhaps) indigenous. Even Sir George Grey's delightful story of the rending apart of Heaven and Earth (comp. Gen. i. 6-10) must be pronounced modern as compared with the simple stories of the heaven-god Tangaroa. It is only in the last stage of a religion that cosmogonies are systematized,—

"Greek endings, each the little passing bell  
That signifies some faith's about to die,"

though the death struggle may be prolonged, and may issue in a higher life.

Besides the works already expressly cited see Bastian *Geographische Bilder* (for a remarkable Old Calabar story); Naville, *La litanie du soleil* (translation from the Egyptian, with commentary); The Funeral Ritual (or Book of the Dead), by Dr. Birch, in Bunsen's *Egypt*, vol. vi.; Spiegel's *Avesta*, etc. (T. K. C.)

COSNE, a town of France in the department of Nièvre, at the head of an arrondissement on the right bank of the Loire, 35 miles N.N.W. of Nevers. It has a tribunal of primary instance, a communal college, and an agricultural society. Some ruins of its mediæval walls, towers, and castle are still preserved. In the vicinity there are extensive forges for the making of anchors and other heavy iron articles. Cosne is mentioned in the Antonine Itinerary under the name of Condate, but it was not till the Middle Ages that it rose into importance as a military post. It was at Cosne that the arrest of Crussol took place which gave rise to the War of the Public Weal under Louis XI.

COSSACKS, certain Russian tribes originally settled on the southern frontiers of Russia in Europe, but now distributed through various parts of the empire, and largely modified by successive intrusions of alien blood. They probably derive their name, which in Russian appears as *Kazak*, from a word synonymous in Tartar with a freebooter, and in Turkish with a light-armed soldier. Ethnographically and historically they are divided into two principal sections, the Cossacks of Little Russia, or of the Dnieper, and the Cossacks of Great Russia, or of the Don.

The former, or Malo-Russian branch seems to have grown up in the 13th and 14th centuries, and probably owed its existence to the confusion caused by the Tartar invasion. Bands of hardy refugees from the surrounding regions, mainly with Russian blood in their veins, gathered together for mutual defence in the islands of the Dnieper, where the natural character of the situation of itself afforded them considerable protection. Their numbers were rapidly increased, and before long they formed a strong and active community. In the 16th century they were enrolled among the vassals of Poland, but were permitted to retain a number of privileges which put them on a level with the Polish nobility. Their constitution was consolidated, their territory extended, and their valor utilized by the able policy of King Stephen Bathori. Meanwhile the more ardent adventurers amongst them were united into a strict military confederation, not unlike in many respects to those orders of knights which in similar circumstances sprung up

in Western Europe for the defence of Christendom. They established their *setcha*, or fortified camp, on an island in the Dnieper, to the south of the *Porogi*, or cataracts, and from this circumstance acquired the name of Zaporogians, or Dwellers beyond the Cataracts. The members were bound by a vow of celibacy; but as every one was welcome to join the association who was willing to submit to its rules, so every one was free to depart as soon as he found it irksome to obey. Freedom and independence were of the first necessity to the Cossacks; their constitution was purely democratic; their *hetmans* or leaders were chosen by popular election, and held their office only for one year. This independent spirit was abundantly displayed in their policy; they lent their services now to the king of Poland, now to Russia, now to the Sultan, and now, it might be, even to the Tartar Khan himself. In 1571, when their leader was put to death by Bathori for having invaded Moldavia on his own authority, thousands of his followers left the country, and went to join their brethren on the Don; and in the following century, the main body which had remained behind, after carrying on a successful war against Poland under the astute Khmelnicki, put themselves under the protection of Russia, whose right to the whole country of the Cossacks, with the exception of a small portion to the west of the Dnieper, was formally recognized by the peace of Radzine in 1681. In 1708 the famous Ivan Stevanovitch Mazepa, who had succeeded in raising himself to the office of hetman, joined the standard of Charles XII. of Sweden; and this revolt brought down on the Cossacks the vengeance of Peter the Great, who ultimately deprived them of all their privileges and abolished their military organization. The Zaporogians, who left the country after the capture of their *setcha*, were recalled by the Empress Anne; but they proved so obstinately obstructive to the civil settlement of the country that they had again to be expelled. They retired for the most part to the Crimea, and on the incorporation of that district with the Russian empire they were deported to Kuban to defend the frontiers against the Caucasian tribes. A small band which had migrated to the Balkan, was recalled in 1828 by the Emperor Nicholas, and sent to form a sort of coast-guard on the Sea of Azoff. The character of the Zaporogian fraternity which was thus destroyed has been the object of very divergent judgments,—some writers seeing in it little more than an organized band of ruffian adventurers, while others raise its members to the dignity of patriots and martyrs who fought and died in defence of national and religious liberty. The last view is well presented by Kulish, one of the most recent of the historians of Little Russia, and it receives no small support from the popular songs in which their virtues and valor are still commemorated among the people of the Ukraine.

The Cossacks of the Don have all along had more direct connection with the empire than their brethren of the Dnieper; and their insurrections, though numerous, have had less of the character of genuine revolt. About seven years after the foundations of their capital Cherkask had been fixed in the marshes of the Don, Ivan IV., irritated at their conduct, despatched against them his general Murashkine. At the approach of the formidable invader the Cossacks dispersed; one band under Yermak pushed eastwards, and effected the conquest of Siberia; another company established themselves in the Ural Mountains and expelled the Tartars from Jaik (Uralsk); while a third probably found a refuge in the Caucasus, where their descendants are still known as the Grebenski, or Mountain Cossacks. In 1637 the portion still left on the Don expelled the Turks from the town of Azoff; and they managed to keep possession of it till 1642 without aid from the Russian Government. Exasperated by the execution of some of their number, and by an attempt to introduce alterations in their religion, they were easily excited to rebellion by the freebooter Stenka (or Stephen) Razine; but after it had risen to a formidable height, the insurrection was suppressed, and its leader executed at Moscow in 1671. In the following century another adventurer found in the discontent of the Cossacks a formidable means of supporting his pretensions; but the success of Pugacheff was as temporary as that of Razine, whom the local superstition imagined to have come to life in his person. The result to the Cossacks was a serious diminution of their privileges, and an extension of Russian control.

Gradually brought under a more rigid military disci-

pline, this restless and warlike race has furnished the empire with one of the most valuable elements in its national army; and their services in the protection of the frontiers from the Caucasus to China are almost incalculable. They form a first-rate irregular cavalry, and render excellent service as scouts and skirmishers; but their steadiness can hardly be trusted in an important engagement. So great is their superstition, that in the midst of a conflict they have been known to give chase to a hare in order to avert the omen by its destruction, and they still retain a large measure of the freebooter's fondness for plunder.

According to their present distribution the Cossacks are distinguished as Cossacks of the Don, of the Azoff, of the Danube, of the Black Sea, of the Caucasus, of the Ural, of Orenburg, of Siberia, of the Chinese frontiers, and of Astrakhan. In their organization they retain the communistic habits of earlier times. The territory is the common property of the stanitz or township; the hay can only be cut after public notice by the Ataman; and no fish can be captured except at prescribed periods, when the whole community join in the enterprise.

Among the privileges still retained by the Cossacks the most important are freedom from taxes, and the right of distilling, brewing, hunting, and fishing.

See Houpel, "Sur les Cosaques," in *Miscellanees du Nord*, 1790; Lesur, *Histoire des Cosaques*, Paris, 1814; Bronevski, *Istoria Donskova Voiska*, St. Petersburg, 1834; Wagner, *Der Kaukasus und das Land der Kosaken*, 1850; Haxthausen, *Études sur la Russie*, Berlin, 1853, vol. iii.; Prosper Mérimée, *Les Cosaques d'autrefois*, dealing only with the insurrections of Khmelnicki, and Stenka Razine, and based on the works of N. Kostmaroff, the Malo-Russian historian; Alfred Rambaud, "L'Ukraine et ses chansons historiques," in *Revue des Deux Mondes*, 1877.

COSTA RICA, THE REPUBLIC OF, the most southern of the five states of Central America, occupies the isthmus between about 8° and 11° N. lat., and 82° and 86° W. long. It is bounded on the N. by Nicaragua, the frontier claimed on this side running from the Pacific coast at the stream called La Flor, immediately north of Salinas Bay, to the Lake of Nicaragua, and along its southern shore to the Rio San Juan, and thence down the right bank of the river to its most southerly mouth—but this line is disputed by the Nicaraguan Government; on the S. by the Colombian state of Panamá, the recognized boundary extending from the Golfo Dulce to the Chiriqui river south of the islet called Escudo de Veragua—this line also over-lapping a debatable borderland; on the N.E. by the Caribbean Sea; and on the S.W. by the Pacific Ocean.

Its area within these limits, officially stated at 26,040 English square miles, has been found by planimetric measurements, made at Gotha, to be more accurately 21,495 square miles, or not quite double that of Belgium.

The population, which consists mainly of people of Spanish descent, little mixed with foreign elements, is officially estimated at 175,000 (according to M. Belly it is 154,000), including about 5000 civilized Indians of pure blood, 1200 negroes, and 600 Chinese; but besides these there are from 10,000 to 12,000 uncivilized Indians within the limits of the republic.

The Atlantic coastland is generally low, and is characterized by numerous lagoons which have been formed by the prevailing currents opposite the river mouths, the chief break in its extent being the great Lagoon or Gulf of Chiriqui; the Pacific coast rises higher and is marked by the two large peninsulas which inclose the Gulfs of Nicoya and Dulce. Inland the surface of the country is much diversified, but is chiefly occupied by mountains, plateaus, and valleys. In the northern portion a great volcanic range extends from north-west to south-east, from between the Lake of Nicaragua and the Pacific coast to the centre of Costa Rica, separating a narrower Pacific descent from the broader slope to the Atlantic; the peaks of Orosi (5200 feet), Rincon de la Vieja, Miravalles, Poas (8845 feet), Barba, Irazu (10,850 feet), and Turrialba, (10,330 feet) are the summits of this range. The form of the southern half of Costa Rica is determined by the great range called the Montaña Dota, 7000 to 9000 feet in elevation, which extends from west to east nearly across the country, in about 9° 40' N. lat., and from which two branch ranges extend south-eastwards, the one close along the Pacific coast as far as the lower Terraba river, the other through the centre of the country, rising to its highest points in the Cerro Chi-

rip6 and Pico Blanco or Nem6, 11,740 feet above the sea. Between the northern and southern masses lie the broad table-lands of San Jos6 and Cartago, marked out on the Pacific side by the ridges called the Cerro del Aguacate and Cerro de Candelaria, and towards the Atlantic by the Cerro Mateo. This central plateau has an elevation of from 3000 to 4000 feet above the sea, and is the most important, and as yet almost the only cultivated region of the country.

The rivers which flow down the Atlantic slope in the N.E., the Rio Frio, San Carlos, Sarapiqui, and Colorado, are tributaries of the boundary river San Juan, the outlet of Lake Nicaragua; the others of this slope from N. to S., the Reventazon, Pecuar, Chirip6 or Matini, Sixaula or Estrella, Changuenola, and Chiriqui, flow independently to the Atlantic lagoons. On the Pacific side from N. to S. the chief rivers are the Tempisque and Las Piedras, flowing to the head of the Gulf of Nicoya; the Rio Grande, from the high borders of the plateau of San Jos6; the Rio de Pirris, Naranjo, and Rio Grande de Terraba.

In contrast to the south-western descent, the Atlantic slope is covered with dense impenetrable forest, and has remained almost closed to traffic and civilization from the earliest times of colonization. Indians still living in a savage state occupy some portions of this wild forest country. The former tribes of the Raventazon and Pacuar have been completely exterminated; those remaining are the Pranzos or Guatusos Indians of the valley of the Rio Frio in the north, the Bizeita tribe on the Sixaula River, and the Terrbis on the Changuenola, in the south-east, sometimes collectively called the Talamanca Indians. The latter tribes have remained in hostility to each other since the discovery of the country; they are perfectly uncivilized, hunters with bow and arrow, and independent of the Government; they trade a little with adventurers from Jamaica, bartering sarsaparilla, hides, and turtle-shells for arms and powder, cotton stuffs, and tobacco. The Mosquito Indians come annually in canoes to the Atlantic coast in May and June to fish for turtle in the Lagoon of Chiriqui. The Pacific slope, on the other hand, is characterized by wide savannas or llanuras, bordered by forest, and is much more accessible.

The climate varies with the elevation, from the tropical heat of the coast, which is often fever-stricken, to the temperate and healthy air of the plateau and the cold of the mountain heights. In the plateau of San Jos6 the north-east trade wind, prevailing from October to April, brings dry weather; from April to October the south-west monsoon, blowing up from the Pacific, brings almost daily rain, excepting within a remarkable period of about a fortnight of dry weather in June, called the "Veranillo de San Juan." The rainfall at San Jos6 (3872 feet above the sea) averages from 40 to 60 inches annually; the average temperature here is about 68° Fahr., rising to 6° in the hottest month of summer and falling to 55° Fahr. in the coldest. The country is subject to earthquakes; a very severe one occurring in 1841 destroyed the town of Cartago.

Costa Rica is exceedingly fertile, its forests being filled with an immense variety of timber trees and useful dye woods, such as mahogany, ebony, India-rubber, Brazil-wood, and oak; almost all the fruits of the tropical and temperate zones are found to thrive, and flowering plants are in rich profusion. Coffee is the staple cultivated product of the country, and is grown chiefly on the plateau lands of San Jos6 and Cartago,—the special adaptability of these to the growth of this plant being attributed to the nature of the soil, which consists of layers of black or dark brown volcanic ash of from 1 to 6 yards in depth. Rice, maize, barley, potatoes, beans, bananas, and yucca are also cultivated to some extent in the interior; cocoa, vanilla, sugar-cane, tobacco, cotton, and indigo, on the warm coast lands, but as yet only for home consumption. About 1150 square miles of the country are under cultivation.

In the forests the wild animals of Central America—the tapir, jaguar, ocelot, puma, deer, and wild pigs—are numerous; a multitude of birds, including the humming bird and the splendid quetzal or trogon, fill the woods; the reptiles include the alligator of the rivers, the iguana, and many other lizards, the boba, tuboba, black snake, rattle-snake, and corale. Among domestic animals oxen and mules are the most valuable, almost all the traffic of the country being carried on by means of ox-wagons.

As yet the chief highway of Costa Rica is the wagon road from Punta Arenas on the Gulf of Nicoya, virtually the only port of the country, to the capital San Jos6, and thence to Cartago on the central plateau. Mule tracks lead north-westwards from Punta Arenas through the province of Guanacaste to Nicaragua, from San Jos6 north-east by the valley of the Sarapiqui to Grey Town on the Atlantic, from Cartago eastwards to Puerto Limon also on the Atlantic, and southward over the western spurs of the Montafia Dota to the plains of Terraba. A railroad from Alajuela to the capital and through Cartago to Puerto Limon, part of a proposed inter-oceanic highway, was begun in 1871, and in December, 1873, the portion between Alajuela and Cartago, 42 miles, had been completed. Owing to financial difficulties, however, the work ceased in 1874, and only sufficient hands were employed to keep the part finished in working order. Two hundred miles of telegraph line had been completed in 1875.

There are no manufacturing industries in Costa Rica. The country is rich in minerals—gold, silver, copper, iron, nickel, zinc, lead, marble—but up to the present time gold, silver, and copper are the only ores that have been worked. The principal gold mines are—(1) those of Trinidad, 4 leagues inland from Punta Arenas, 1200 feet above the sea, worked on a small scale by a Costa Rican company,—the quartz yields gold of a fineness of about 17½ carats; and (2) the mines of the Cerro del Aguacate, one of which is worked by the native "Compania de la Montafia del Aguacate," also in an imperfect manner, but with good results. Another, called the "Sacra Familia," lies a little north of the Aguacate mine, at an elevation of 3000 feet above the sea; it has two chief veins, one containing galena and zinc blend, with silver, and grey copper ore also yielding silver, and a second, with a lode of gold quartz similar to that of Trinidad. This mine is also worked on a small scale by private individuals, and gives gold of about 15½ carats fine. Gold is said also to exist in the wild Indian country of the Atlantic slope, but the position of the supposed mines is uncertain.

Costa Rica is divided into six provinces, in which the population is distributed as follows according to the estimate of M. Bely:—

San Jos6,	45,000	Capital—San Jos6,	15,000
Cartago,	36,000	Cartago,	10,000
H6r6dia,	30,000	H6r6dia,	9,000
Alajuela,	29,000	Alajuela,	6,000
Guanacaste,	8,000	Liberia,	2,000
Punta Arenas,	6,000	Punta Arenas,	1,800

The government is vested in a president elected for four years, and a first and second vice-president, aided by four ministers and the national congress of deputies, also elected for four years. The present constitution, the seventh which has been in force in the republic, dates from 1871. All men between the ages of eighteen and thirty form the militia of the republic, and in 1874 numbered 16,380,—900 being employed in active service. All men between the ages of thirty and fifty-five years form a reserve. The religion of the state is Roman Catholic, but full liberty for the public exercise of all religions is granted by the constitution. The revenue of the republic, derived from customs, monopolies of spirits and tobacco, from the national bank, sales of land, and various taxes, chiefly that on the exportation of coffee, amounted in 1875 to £517,605; the expenditure in the same year was £556,221, showing a deficit of £38,616.

In 1871 the Government contracted in London a loan of £1,000,000, and in 1872 another of £2,400,000 for the construction of an inter-oceanic railway. In 1875 the external debt from this source was £2,401,300. Of this sum £1,116,000 had been spent on the railroad previous to the close of 1873, when the further execution of the work ceased. The interest and sinking-fund of this loan are far in arrears; the country is bankrupt, and the Government has made no attempt to pay even part of its liabilities.

The value of the coffee exported in 1874 was estimated at £892,800, and that of hides, timber, &c., at £20,000.

Imports are chiefly of Manchester goods, hardware, flour, salt, and sugar, chiefly shipped from England; but trade with France, Germany, and the United States was increasing in 1875. Only about a fourth part of the trade of the republic passes through Puerto Limon on the Atlantic, to which there is a mule track, the bulk of goods being car-



ried round to the Pacific port of Punta Arenas, whence there is a highway to the interior.

Costa Rica was one of the first discovered portions of the American continent; Columbus touched on its shores in his third voyage, and it is probable that Spanish adventurers first established themselves within it after the fourth voyage of Columbus in 1602. In 1821, when all the provinces which formed the kingdom of Guatemala declared their independence of the mother-country, two parties, one desiring union with Mexico under the dynasty of Iturbide, the other seeking to form a separate republic, divided opinions in the revolted provinces. In Costa Rica the town of Cartago chose the former; San José the latter. The opposing factions met at a place called the Laguna de Ochomogo. The republicans were victorious, and the seat of government was transferred from Cartago to San José. In 1824 Costa Rica joined the federation of the Central American States, but on the dissolution of that union in 1839 became an independent republic. Internal disturbances and over-turnings of the Government have been less frequent in Costa Rica than in the other states of Central America, and its progress has been correspondingly greater. Of recent years, however, the Government has been obliged to maintain an army to guard itself against smouldering revolutions, and at the present time (1877) angry discussions are taking place with Nicaragua on the question of boundaries. On the other hand, an attempt is being made to induce the Central American republics to join again in forming one government.

Frantsius, Dr. A., "Der südöstliche Theil der Rep. Costa Rica," Petermann's *Mittheilungen*, 1869; "Klimatischen Verhältnisse Central Americas," *Zeitschrift der Gesellschaft für Erdkunde*, Berlin, Bd. iii., 1869, Bd. iv., 1869; and "Die Costa Rica Eisenbahn," *Das Ausland*, 1868, No. 6; Boyle (Fred.), *Wanderings in Nicaragua and Costa Rica*, London, 1868; Belly (Felix), *A travers l'Amérique Centrale*, Paris, 1872; Peralta (Manuel M.), "Costa Rica," *Le Globe de Genève*, x., 1871; Gabb (W. M.), "Notes on the Geology of Costa Rica," *American Journal of Science and Art*, Nov., 1874 and March, 1875; Molina (Felipe), *Boquejo de la Republica de Costa Rica*, Madrid, 1880; Wagner (M.) and Scherzer (C.), *Die Republik Costa Rica*, Leipzig, 1887; *Reports from H. M. Consuls*, Part iii., 1874, Part v., 1875; Polakowsky (Dr. H.), "Central America," in *Das Ausland*, Nov., 1876. The best map is *Original Karte von Costa Rica* von A. von Frantsius, Gotha, 1869. (K. J.)

COSTANZO, ANGELO DI (about 1507–1591), an Italian historian and poet, was born at Naples about 1507. His great work is *Le Istorie del Regno di Napoli dal 1250 fino al 1499*, which first appeared at Naples in 1572, and was the fruit of thirty or forty years' labor; but ten more years were devoted to the task before it appeared in its final form at Aquila (1582). It is still one of the best histories of Naples; and the style is distinguished by clearness, simplicity, and elegance. As a poet Costanzo is remarkable for finical taste, for polish and frequent beauty of expression, and for strict obedience to the poetical canons of his time.

COSTELLO, DUDLEY (1803–1865), a journalist, novelist, and miscellaneous writer, was born in Ireland in 1803. He was the son of Colonel J. F. Costello, and choosing his father's profession, was educated at Sandhurst College, and served for a short time with his regiment in Canada and the West Indies. His literary and artistic tastes led him to quit the army, and he then passed some years (1822–1831) at Paris. During this period he was introduced to Baron Cuvier, and was employed by him as draughtsman in the preparation of his work on comparative anatomy. He next occupied himself in copying illuminated manuscripts in the Bibliothèque Royale; and to him and his sister belongs the merit of being the first to draw general attention to the beautiful forgotten art, and of thus leading to its revival. About 1832 Costello became foreign correspondent to the *Morning Herald*, and from this time he was regularly occupied as journalist and contributor to periodical literature. During the last twenty years of his life he held the post of sub-editor of the *Examiner*. He wrote *A Tour through the Valley of the Meuse* (1845), and *Italy from the Alps to the Tiber* (1861). Among his novels are *Stories from a Screen* (1855), *The Millionaire* (1858), *Faint Heart never won Fair Lady* (1859), and *Holidays with Hobgoblins* (1860). He died in London, September 30, 1865. A few years before his death a pension of £100 per annum was conferred on him.

COSTELLO, LOUISA STUART (1799–1870), an historical

and miscellaneous writer, elder sister of the preceding, was born in Ireland in 1799. Her father dying while she was young, during the occupation of France by the allies, she aided in the support of her mother and brother by her skill as an artist. At the age of sixteen she published a volume of verse entitled *The Maid of the Cyprus Isle, and other Poems*. This was followed in 1825 by *Songs of a Stranger*, dedicated to W. L. Bowles. Ten years later appeared her *Specimens of the Early Poetry of France*, which was illustrated by beautifully executed illuminations, the work of her brother and herself. It was dedicated to Moore, and procured her his friendship as well as that of Sir Walter Scott. Henceforth literature was the labor of her life. Her principal works are—*A Summer among the Bocages and Vines* (1840); *The Queen's Poisoner* (or *The Queen-Mother*), an historical romance (1841); *Bearn and the Pyrenees* (1844); *Memoirs of Eminent Englishwomen* (1844); *The Rose-Garden of Persia* (1845), a series of translations from Persian poets, with illuminations by herself and her brother; *The Falls, Lakes, and Mountains of North Wales* (1845); *Clara Fane* (1848), a novel; *Memoirs of Mary of Burgundy* (1853); and *Memoirs of Anne of Brittany* (1855). She died at Boulogne, April 24, 1870.

COSTER, LAURENCE. See KOSTER and PRINTING.

COSTS. When a person brings an action in law against another and succeeds, it is only fair that the defendant, besides paying the sum which he ought to have paid, should also recoup the expenses incurred by the plaintiff in prosecuting a rightful claim. On the other hand, when the action fails, the defendant is justly entitled to be repaid the expenses he has incurred in defending a wrongful claim. That costs should follow the event may therefore be taken as the first principle of the law relating to this subject; but there are many special circumstances which interfere to modify its application. The action, though successful, may be in its nature frivolous or vexatious, or it may have been brought into a higher court where a lower court would have been competent to deal with it; and, on the other hand, the defendant, although he has escaped a judgment against him, may by his conduct have rendered the action necessary, or otherwise justifiable. In such cases the rule that costs should follow the event would be felt to work an injustice, and exceptions to its operation have therefore to be devised. The law of England as to costs, simple as the subject may appear, is in reality highly complicated.

At common law, costs were not given either to plaintiff or defendant, although the damages given to a successful plaintiff would include the expense he had been put to in taking proceedings. The defendant in a wrongful action could not even recover his costs thus indirectly, and the indirect costs given to a plaintiff under the name of damages were often inadequate and uncertain. Costs were first given under the Statute of Gloucester (6 Edward I. c. 1), which enacts that "the demandant shall recover damages in an assize of novel disseisin and in writs of mort d'ancestor, coisnage, aiel, and beziel, and further that the demandant may recover against the tenant the costs of his writ purchased together with the damages above said. And this Act shall hold in all cases when the party is to recover damages." The words "costs of his writ" were extended to mean all the legal costs in the suit. The clause gives costs, wherever damages are recovered, and no matter what the amount of the damages may be. Costs were first given to a defendant by the Statute of Marlebridge in a case relating to wardship in chivalry (52 Henry III. c. 6); but costs were not given generally to successful defendants until the 23 Henry VIII. c. 15, which provides that "if in the actions therein mentioned the plaintiff after appearance of the defendant be nonsuited, or any verdict happen to pass by lawful trial against the plaintiff, the defendant shall have judgment to recover his costs against the plaintiff, to be assessed and taxed at the discretion of the court, and shall have such process and execution for the recovery and paying his costs against the plaintiff, as the plaintiff should or might have had against the defendant, in case the judgment had been given for the plaintiff." By the 4 James I. c. 3, this "good and profitable law" was extended to other actions not originally specified, although within the meaning of the Act, so that in any action wherein the plaintiff might have costs if judgment were given for him, the defendant if successful should have costs against the plaintiff. The policy of these enactments is expressed to be the discouragement of frivolous and unjust suits. This policy

was carried out by other and later Acts. The 21 James I. c. 16 § 8 (the statute for the limitation of actions) orders that, if the plaintiff in an action of slander recover less than 40s. damages, the plaintiff shall be allowed no more as costs than he gets as damages. By the 43 Elizabeth c. 6 it had been enacted that in any personal action not being for any title or interest in land, nor concerning the freehold or inheritance of lands nor for battery, where the damages shall not amount to 40s. no more costs than damages shall be allowed. By 3 and 4 Vict. c. 24 (Lord Denman's Act), where the plaintiff in an action of tort recovers less than 40s., he shall not be allowed costs unless the judge certifies that the action was really brought to try a right besides the right to recover damages, or that the injury was wilful or malicious. Not to speak of other enactments on this subject, the County Courts Act, 1867, laid down the following rule:—If in any action in any of the superior courts the plaintiff shall recover a sum not exceeding £20 if the action is founded on contract, or £10 if founded on tort, whether by verdict, judgment by default, or on demurrer, or otherwise, he shall not be entitled to any costs of suit unless the judge certify on the record that there was sufficient reason for bringing such action in such superior court, or unless the court or a judge at chambers shall by rule or order allow such costs.

Costs in equity were subject to the discretion of the court, but as a general rule the maxim of the civil law, *victus victori in expensis condemnatus est*, was followed. The successful party has a *prima facie* claim to costs, but the court might, on sufficient cause shown, not only deprive him of his costs, but even in some rare cases order him to pay the costs of his unsuccessful opponent. There was a class of cases in which the court generally gave costs to parties sustaining a certain character, whatever might be the result of the suit (e. g., heirs-at-law, mortgagees, etc.). A defendant would have been exempted from costs if he had made such a tender of payment as would have rendered a suit unnecessary—such tender to be full and unconditional, and to include costs already incurred, as well as the principal claim.

The following rule as to costs is laid down in the Rules of Court appended to Judicature Act, 1875, order 55:—“Subject to the provisions of the Act the costs of and incident to all proceedings in the High Court shall be in the discretion of the court; but nothing herein contained shall deprive a trustee, mortgagee, or other person of any right to costs out of a particular estate or fund to which he would be entitled under the rules hitherto acted upon in courts of equity: provided that, where any action or issue is tried by a jury, the cost shall follow the event, unless upon application made at the trial, for good cause shown, the judge before whom such action or issue is tried, or the court, shall otherwise order.” The provisions of the County Court Act, 1867, above referred to, still hold good, as well as those of Lord Denman's Act, depriving a plaintiff of costs when he recovers less than 40s. on an action of tort, unless the judge certifies; and of 21 James I. c. 16, making costs no more than damages in actions of slander where damages are assessed under 40s.

In the taxation of costs certain principles are observed which may be briefly adverted to. Thus in some cases costs are to be taxed as “between party and party,” in others as between solicitor and client. “No definite rules can be laid down with respect to the difference between the costs to be allowed upon one principle of taxation and those allowed upon the other. In general, however, in taxations as between party and party, only those charges will be allowed which are strictly necessary for the purposes of the prosecution of the litigation, or are contained in the table of fees annexed to the general orders and regulations of the court; while in taxations as between solicitor and client the party will be allowed as many of the charges which he would have been compelled to pay his own solicitor, as being costs of suits, as fair justice to the other party will permit” (Daniel's *Chancery Practice*). Costs are taxed between party and party unless otherwise specially directed. Costs of interlocutory motions made in the course of a litigation are sometimes said to be “costs in the cause,” that is, they abide the result of the principal issue. A party succeeding in an interlocutory motion, and paying the costs therein made costs on the cause, would recover the amount of such costs if he had a judgment for costs on the result of the whole trial, but not otherwise.

When one of the party makes default, as in failing to proceed to trial according to notice at the time appointed, he becomes liable to the other for what are called the “costs of the day.”

Regulations as to costs of proceedings in the Supreme Court of Judicature will be found in order vi. of the Additional Rules of Court under the Judicature Act, 1875. Two scales of fees which may be charged by solicitors are printed—the lower to be the general charge for matters assigned to the different divisions of the court (except causes relating to sums over £1000 in the Chancery division) and actions for special injunctions. But a court or judge may in any case direct the fees in either scale to be allowed “to all or either or any of the parties and as to all or any part of the costs.”

The court of appeal shall have power to make such order as to the whole or any part of the costs of the appeal as may seem just (Rules of the Judicature Act, 1875). (R. R.)

COSTUME, as defined for the present inquiry, is limited to personal attire, but with the exclusion of armor, which has been dealt with under a separate heading.

#### GREEK COSTUME.

The inquiry begins with Greek costume, as to which, so far as it consists of dress, the general remark may be made that its history is for the most part free from what is known as the changes of fashion, for this reason that the Greeks did not attempt to reconcile the two opposite principles of covering and at the same time displaying the figure, that is to say, of cutting the dress to fit the body. There are changes which will be noted between the dress worn after 450 B. C. and that of an earlier date, when the material was heavier and the figure more closely developed, suggesting a difference of climate in these different periods.

*Female Dress.*—The chief and indispensable article of female dress was the *chiton*, consisting of one piece of material sewed together in the form of a sack open at top and bottom, in height reaching from the neck to the feet of the wearer, and in width equal to that of the extended arms. Within this stands the figure, and first it is girt round under the breasts, to keep it from falling, by a girdle



Fig. 1.—Bronze statuette (stand of mirror) wearing Chiton. From Athens. Brit. Mus.

(*soster*). Next, the upper edges are fastened together on the top of the shoulders by a brooch (*stula*), and the arms are either left bare, pressing down into folds at each side the masses of material, or these masses may be gathered round each arm, and fastened down the outside with buttons and loops so as to form sleeves (*chiton cheiridotos*). The chiton could be left open down one side for convenience in dancing, and was then called *chiton schistos*. To secure greater

warmth on the breast and shoulders the chiton was made long enough to be doubled back from the top, and this part reaching to the waist was called the *diplois* or *diploidion*. It could be also made of a separate piece. Underneath the chiton was worn a band of cloth (*tonia*) to support the breasts, and in addition to this a cord was sometimes crossed round the breasts outside the chiton to assist either in supporting them or in bringing out their form. Round the loins was worn, perhaps not always, either a short petticoat of thick woollen stuff or a sort of bathing drawers, *ῥα λουρῆς*, such as acrobats wore. So far we have mentioned all the dress that was necessary for indoor wear, which, also, since it had to be got into, was called *ἐνδύμα*, as opposed to other parts of dress, which were thrown round the body, and were called *περὶβλήματα*. To the latter class belongs the next article of importance in female dress, the *himation*, a garment worn also by men. While the chiton was generally made of linen, of which there was a variety of fabrics (e. g., those of Amorgos, Tarentum, Sicily, Crete, and Phrygia), or of cannabis (made from hemp), or of byssos (flax from India and Egypt chiefly), or of silk (*serica*), the *himation* consisted of woollen stuff, and was worn like a plaid. It was first thrown over the left shoulder, leaving the short end to hang down in front; the long end was then gathered round the back with the right hand, brought under the right arm, and across the body in front, and finally held in this position by being thrown over the left fore arm. Or instead of being passed under the right arm it could be brought over the right shoulder so as to envelop the right arm, then carried closely round the neck, and finally thrown over the left shoulder with an end hanging down behind; or again, it could be still further drawn up over the back of the head to form a hood. As regards colors, it will be found, when we have taken away black for the use of mourners (*τὰ δὲ μέλαινα ἑμάτια ὀρφάνινα ἐκάλονον*), that the others were employed in a great variety of combinations. An important point was always to have a deep border round the foot of the chiton, either of some uniform color which suggests solidity and heaviness, so as to weigh down the dress, or of some pattern which would suggest strength to prevent the dress from being torn when striding. Strong contrasts of colors were used, such as a white chiton with pink *himation*, or a white chiton with a broad blue border round the foot. Besides embroidery, another kind of ornament consisted of designs beaten out in thin gold and stitched on the dress. Great numbers of these have been found in tombs where the dress itself has entirely perished. Greek vases and sculptures represent Amazons and Persians wearing trousers (*anaxyrides*), but this article of dress did not come into use among the Greeks themselves.

While the chiton and *himation*, as above described, continued to be the standard dress from about 450 B. C. onwards, it is the rule to find in figures of an earlier date the *himation* worn as in fig. 3, where it has more of the appearance of a chiton, having like it a *diploidion*, and enveloping the greater part of the figure, so that the chiton proper appears as distinctly an under garment. It is a *himation* of this kind that the archaic figure of Athena wears, and since we know that the name for this garment of hers was *peplos*, it would perhaps be more correct to use this word instead of *himation* for the upper garment of the earlier period. Among other reasons also for this is the negative evidence that the word *peplos* does not occur in the inventory of female dresses on an inscription from Athens in the British Museum, in which the latest date given is 335 B. C. Pollux, it is true (vii. 47), cites it in his list of names for dresses worn by women.



FIG. 2. —Terracotta statue, wearing Chiton and Himation. From Tanagra. Brit. Mus.

Returning to the dress after 450 B. C., we find that the chiton could be tucked up under the girdle till the skirt reached only to the knees, as in the figures of Artemis. A short linen chiton, reaching half way down the thighs, was called *kypassis*. The *diploidion*, when once made of a separate piece, could have the form of a sleeveless jacket reaching nearly to the knees. A *diploidion* worn only in front was called a *hemidiploidion*. A chiton worn to leave one breast bare was called *heteromastichalos*; worn without a girdle, as by priests and old women, it was *orthostadios*, or perhaps *soma*. The *ampechonion* appears to have been a small shawl. The *kimbarikon* was a transparent under-chiton. The following names of dresses are still undetermined—*kandydys* or *kandyke*, *epomis*, *pharos*, *phænole*, *xystis* (*xyston*), *heanos*, *mandys*, *ephestrides*, and *amphistrides*.



FIG. 3.—Bronze statuette, wearing Peplos. From Ravenna. Brit. Mus.

As regards the covering of the head, that was perhaps most generally accomplished by drawing the *himation* up over the back of the head like a hood; or, instead of this, a separate piece of cloth was made to perform this service, the end of it falling under the *himation*. This was the *kalypttra*, or veil. A cap merely

intended to cover in the hair and hold it together was called *kekryphalos*. When hats were worn they were of circular shape, and either of some stiff material, as the Thessalian or Boeotian hat (*Θεσσαλικὴ κνήη*), observed in terra-cottas from Tanagra in Boeotia and in Pompeian paintings, or of pliant material which could be bent down at the sides like the *petasus* worn by Atalanta. Similar to this seems to have been the *kausia* or Macedonian hat. The *kyrbasia*, or *kadiras*, was a high pointed hat of Persian origin, as was also the *tiara*, which served the double purpose of an ornament and a covering for the head. When the object was only to hold up the hair from the neck, the *spondone* was used, which, as its name implies, was in the form of a sling; but in this case it was called more particularly *opitho-sphendone*, as a distinction from the *sphendone* when worn in the front of the head. The head ornaments include the *diadema*, a narrow band bound round the hair a little way back from the brow and temples, and fastened in the knot of the hair behind; the *ampyx*, a variety of the diadem; the *stephane*, a crown worn over the forehead, its highest point being in the centre, and narrowing at each side into a thin band which is tied at the back of the head. Different from this is the *stephanos*, which is a crown of the same breadth and design all round, as on the coins of Argos with the head of Hera, who is expressly said by Pausanias to wear a *stephanos*. This word is also employed for crowns of laurel, olive, or other plant, when the form would be the same all round the head. Crowns made of wicker-work (*poloi kalathoi*) were also worn (see Gerhard, *Antike Bildwerke*, pls. 303-305). When the hair, as was most usual, was gathered back from the temples and fastened in a knot behind, hair pins were required, and these were mostly of bone or ivory, mounted with gold or plain. So also when the hair was tied in a large knot above the forehead, as in the case of Artemis, or of Apollo as leader of the Muses. The early Athenians wore their hair so, with a pin representing a grasshopper (*τέττις*), in allusion to their claim of having originally sprung from the soil (Thucyd. i. 6). Whether this knot was the *trobylos* is not determined. In archaic figures the hair is most frequently arranged over the brow and temples in parallel rows of small curls which must have been kept in their places by artificial means, probably by small spirals of gold wire, such as are found in early Etruscan tombs lying near the

head of the skeleton. Ear-rings (*ἐνώτια, ἐλλόβια, ἐλακτρές*) of gold, silver, or bronze plaited with gold, and frequently ornamented with pearls, precious stones, or enamel, were worn attached to the lobes of the ear. For necklaces (*δέρμοι*), bracelets (*δέρεις*), brooches (*πέροναι*), and finger-rings (*δακτύλιοι* or *σφραγίδες*) the same variety and preciousness of material was employed. The gold used was always very thin; the intrinsic value, for example, of the famous Milo necklace in the British Museum is very slight, while the extraordinary amount of skilled workmanship in it would represent a very high value in labor. This is the rule in the best period of Greek art, that the jewelry is of value according to its workmanship; but in later times preciousness of material determined the value. In the earliest jewelry, amber is conspicuous, alternating with pale gold or electrum. For the feet the sandal (*σάνδαλον, πέδιλα*) was the usual wear; in exceptional cases, as for the bath, shoes, and for hunting, high boots were worn. The hunting boot was laced up the front, and reached to the calves. Gloves (*χειρίδες*) were worn by the Persians, but apparently never by the Greeks unless to protect the hands when working (*Odyssey*, xxiv. 230).

**Male Dress.**—Fig. 4 represents the dress of a Greek citizen, such as it appears, for example, on the frieze of the Parthenon. It consists

of nothing more than a himation such as that already described for women, but worn differently; and from the simplicity of this attire it may be seen in how ridiculously awkward a position Blepyrus was placed by his wife's having carried off his himation and shoes (*Aristoph., Eccles.*, 310 *sqq.*). But underneath the himation was sometimes also a short linen chiton similar to that worn by armed men under their armor; and with this chiton on, the himation could be laid aside on occasion. Workmen of all kinds wore only a short chiton girt round the waist, and let loose from the right shoulder to leave the arm free. In this case the material varied according to the necessary exposure to cold,—a fisherman, for example, having a chiton of hide, as had also slaves; but the slave's chiton was more like a jacket with sleeves reaching to the wrist, and corresponding to the *σάστρα* as defined by Pollux (vii. 70), who mentions further the *βαίτη* and *σάστρα* as garments of hide worn by peasants in the form of mantles. The same class of persons wore at other times the *καρνώδην*, a mantle of woollen stuff with border of sheepskin. But among the citizen class where the himation, as in fig. 4, was the proper dress for a man of mature years, younger men and youths appear to have worn it only as a sort of undress to wrap round them when heated in the palestra or at the bath. On public appearances they wore a linen chiton girt at the waist, and reaching half-way down the thighs, and on their shoulders a purple *chlamys* of woollen stuff fastened with a brooch on the right shoulder as in fig. 5. The *chlamys* was properly a military mantle, and is said to have been introduced from Macedonia, as was also the *kausia*, worn along with it by Athenian youth, a round hat with flat pliant brim resembling the *petasus* of Hermes. In winter a mantle of thick stuff, the *chitona*, was sometimes worn, while in summer the himation could be replaced by the thin linen *chlanis*. For official or priestly dignity an ungirt chiton reaching to the feet (*chiton orthostaidios*) was worn. Sandals, shoes, or high boots were used as occasion required.



FIG. 4.—Bronze statuette, wearing Himation. From Greece. Brit. Mus.

The citizen of mature years wore no covering for the head. That was confined to youth, workmen, and slaves. His hair was cut short on the top, and lay on the head without parting. At the sides and round the neck it was allowed to fall a short way. His beard was of moderate size. Before Alexander's time only the Spartans shaved the upper lip, but after that shaving became more general. Except a finger ring, a brooch to fasten the *chlamys*, or on

occasion a wreath, the citizen usually wore no ornaments. While with this class there was no limit to the display of limbs, it was on the other hand the object of the slave's dress to conceal the limbs as far as possible, and for this purpose he wore, besides the jacket with long sleeves already noticed, close-fitting hose reaching to the ankles. For his head he had, like fishermen and other workmen, a pointed cap (*pileos*).

The constancy to one fashion observed in the dress of the Greeks is not remarkable when we remember that the fashions with which they were familiar in other nations must have shared in their minds the association with servitude and lower civilization which attached to these nations. Yet if it is true that they



FIG. 5.—Terracotta figure, wearing Chlamys and Chiton. From Tanagra. Brit. Mus.

entered Greece from the north, and had previously permanent settlements in that region, it is curious that they did not retain in their costume some evidence of the colder climate in which they had lived, unless, indeed, the hose relegated to slaves furnish such evidence. This same difficulty occurs with regard to the Etruscans, whose dress is peculiarly the natural one for an Oriental climate; and it is the more remarkable in their case since the cold of the north of Italy would, it might be supposed, have induced them to retain part of the dress peculiar to the north, had they, as is argued, been previously settled there.

#### ETRUSCAN.

The female dress of the Etruscans consisted, like that of the Greeks, in (1) a *chiton poderes*, reaching to the feet and girt at the waist; (2) a himation, worn in the fashion of a shawl, as occasionally on early Greek figures, or as a plaid; (3) a hat (*tutulus*) rising to a high point; and (4) pointed shoes. The chiton with diploidion on the breast, which is so conspicuous in Greek art after 450 B. C., does not so far as we know occur in pure Etruscan representations of dress; nor is the himation found wrapped round the body as in Greek figures of this period (see fig. 2 above). It seems to have been much narrower as used by the Etruscans, and more like a shepherd's plaid. Instead of a himation a close-fitting jacket of thick stuff is worn by an archaic Etruscan female figure in the British Museum, fig. 6. The pointed hat (*tutulus*) resembles the Persian *kidaris*, and from its Oriental appearance has been cited as a survival of part of the national dress from the time when the Etruscans inhabited Lydia. On a celebrated terracotta sarcophagus in the British Museum the female figure reclining on the lid wears a Greek chiton of a thin white material, with short sleeves fastened on the outside of the arm, by means of buttons and loops; a himation of dark purple thick stuff is wrapped round her hips and legs; on her feet are sandals, consisting of a sole apparently of leather, and attached to the foot and leg with leather straps; under the straps are thin socks which do not cover the toes; she wears a necklace of heavy pendants; her ears are pierced for ear-rings; her hair is partly gath-

ered together with a ribbon at the roots behind, and partly hangs in long tresses before and behind; a flat diadem is bound round her head a little way back from the brow and temples. Purple, pale green, and white, richly embroidered, are favorite colors in the dresses represented on the painted tombs.

No less essentially identical with the Greek are the representations of male dress on works of Etruscan art dating from the period of national independence. The chief article of male dress was called the *tebenna*. On the other hand there are the statements of ancient writers that the *toga prætexta*, with its purple border (*περιπόρφυρος ῥιβερνα*), as worn by Roman magistrates and priests, had been derived from the Etruscans (Pliny, *N. H.*, ix. 63, *prætextatus apud Etruscos originem invenere*); and the Roman toga, though placed round the body much in the same way as the Greek himation, yet differed from it in shape so far that, while the latter was an oblong, the toga was a circular piece of stuff (*toga rotunda*), of which a large segment was doubled back so as to reduce the whole to little more than a semicircle. By this means a greater profusion of folds was obtained, and this at first sight is the characteristic difference between the Greek and Roman male dress. But though the toga, worn as it was by the Romans, does not occur in early Etruscan art, there is sufficient likeness between it and the *tebenna*, which does occur, to justify the statement of the Roman toga being derived from the earlier costume of the Etruscans. It would have been equally, perhaps more, correct to have traced it to a Greek origin, the *tebenna* having been worn in Argos and Arcadia (Pollux, vii. 61) apparently from early times. Under the *tebenna*, or toga, which was necessary only for public appearance, the Etruscans wore a short tunic similar to the Greek chiton. For workmen and others of inferior occupation this appears to have been the only dress.

Youths, when engaged in horsemanship and other exercises, wore a chlamys round the shoulders, just as the youths similarly engaged on the Parthenon frieze. But the Etruscan chlamys, again, is semicircular in cut, and was fastened on the breast by buttons and a loop, or tied in a knot, whereas the Greek chlamys was oblong and fastened on the shoulder by a brooch (*perone*). On public or festal occasions the Etruscan noble wore, besides the *tebenna*, a *bullæ*, or necklace of *bullæ*, and a wreath, *corona Etrusca*. The *bullæ* was a circular gold locket containing a charm of some kind against evil. On the later sarcophagi the male figures wear not only a wreath, or *corona* proper, but also a garland of flowers hung round the neck. The Roman manner of wearing occasionally the toga, with the end thrown over the left shoulder, and wrapped round the waist (*Gabinocinctus*), was derived, it was said, from Etruria. The upper fold of the *tebenna* could be drawn up over the head if needed. As a separate male head-dress there was the *galerus*, a hat of leather, said to have been worn by the Lucumoi in early times, or the *aper*, a pointed hat corresponding to the *tutulus* worn by females. The fashion of shoes worn by Roman senators was said to have been derived from Etruria. Etruscan shoes were prized both in Greece and in Rome.



FIG. 6.—Bronze Etruscan figure. From Sessa. Brit. Mus.

shoulder and breast. The toga as here worn is, when spread out, a nearly elliptical piece of cloth, its greatest length being three times the height of the person who wears it, and



FIG. 7.—Bronze statuette, wearing Toga. Brit. Mus.

its greatest breadth equal to at least twice the height of the wearer. It is, therefore, correctly called *toga rotunda*. The first step is to double back a segment of this ellipse so that it may nearly resemble a semicircle, and thus also justify the other definition of the toga as semicircular (*περιβόλαιον ἡμικύκλιον*). With the long straight edge so obtained, and with the smaller segment on the outside, the toga is thrown over the left shoulder, one end hanging down in front and over the left arm to the ground. The long end is then gathered round the back with the right hand, brought under the right arm and across the body, and finally thrown again over the left shoulder so that it may hang down the back some distance. The segment which was doubled back may be drawn over the back of the head like a veil, or, more generally, is drawn up as far as the

neck and round the right shoulder, from which it forms a sweep in front of the body resembling the curve of a bay, whence it is called the *sinus*. The end, at first allowed to fall down in front, is drawn up a little and hangs over the edge, which passes round the waist in front. This is perhaps what is called the *umbo*. Instead of the loose end of the toga being thrown over the left shoulder, as here, it was sometimes carried round under the left arm and tied tightly round the waist. This was called the *cinctus Gabinus*, and from having been once, it appears, a common fashion of citizens when engaged in war, was retained as the official form in certain ceremonies arising out of war, as at the opening of the temple of Janus. The toga was of a thin woollen stuff, and as to color was always white for the ordinary burgesses. A white toga with a purple border (*toga prætexta*) was worn as a distinction by those holding public offices, entitling them to the curule chair and the fasces, by the great colleges of priests (Flamen Dialis, Pontifices, Augurs, Septemviri, Quindecimviri, and Arvales), but in this case only during the act of performing their offices, and by boys up to their sixteenth year, when they assumed the *toga virilis*. The tribunes and ædiles of the plebs and the quaestors were denied the right to the *prætexta*. A purple toga (*toga purpurea*) was always the mark of high office, and as such was worn by the magistrates of republican times, though not except on public occasions, as well as by the emperors. The purple toga was sometimes embroidered with gold (*toga picta*), and it could only be worn with an under dress of the same color (*tunica palmata*). The *prætexta*, on the other hand, with its purple border, could only be worn along with a white tunic under it with a purple stripe (*clavus*). The *prætexta* was laid aside when the wearer retired from office, but the *clavus*, or purple stripe on the tunic, was retained, and became in consequence the distinguishing mark of the senatorial order.

The tunic corresponds exactly to the Greek chiton, reaching, like it, half way down the thigh, and being girt round the waist, but with the apparent difference that the Greeks rarely brought the stuff pressed down by both arms up round the arms so as to form sleeves down to the elbows, as did the Romans frequently. Further, it was a custom of the Romans to wear two tunics,—Augustus is said to have worn four. The one next the skin was known as the

ROMAN.

*Male Dress.*—Fig. 7 represents the full Roman dress of tunic and toga, the former being visible only on the right

*subucula*, and the other as the *supparus*, or *intusium*. Only the latter had sleeves (*tunica manicata*), and over it passed the girdle (*cinctura*). The tunic of the senatorial order had, as has been said, a broad purple stripe, *latus clavius*, woven into it down the front, whence it was called *tunica lativittata*. That of the knightly order had two narrow purple stripes and was known as *tunica angustivittata*. Tunics with two narrow stripes, one passing over each shoulder before and behind, are seen on Roman bronze statuettes of boys represented acting as Camilli at sacrifices. The tunic was usually of linen, just as the toga was of wool, and the national color for ordinary purposes was white. Poor persons were doubtless content with the natural color of the linen or wool, and when in mourning the higher classes wore a dark-colored toga (*toga palla* or *sordida*), though this was not always the rule.

More convenient than the toga, but retaining a general likeness to it, was the *pallium*, an adaptation of the Greek himation. Among other substitutes for the toga were (1) the *trabea*, which formed the official dress of the Augurs and Salii, resembling in shape the Etruscan *tebenna*, and being purple in color; (2) *paludamentum*, an adaptation of the Greek *chlamys*, worn by the emperor as head of the army, purple in color, though white was also allowed; (3) *sagum*, or *sagulum*, similar to the last, but worn only by soldiers; it differs from the *chlamys* in having the corners rounded off so as to be nearly circular when folded out; (4) *penula*, worn in rainy weather to cover the dress, and made of thick flaxen material (*gausepe*) or leather, with or without a hood, and formed of an elliptical piece of stuff with a round hole in the middle for the head to pass through; (5) *lacerna*, a sort of *chlamys* of expensive materials and colors, worn in the theatre or circus in presence of the emperor. As regards covering for the head, there was the hood of the *penula* in rough weather ( *cucullus* or *cucullio*), or the toga could be drawn up over the head, or there was a separate article—the *ricinium*—in the form of a veil, as worn by the Arval Brothers. Workmen and others wore hats or caps corresponding to the Greek *pilus* (*pilleus*) and *petasus*. As an ornament for the head the diadem was only occasionally used till the time of Constantine. It was declined by Cæsar. After Caracalla the most usual mark of an emperor was a crown of radii. The heavy garments worn out of doors, or officially, were replaced at dinner by *vestes comatorie* of thin material. Trousers (*bracæ*) were not worn till after the Parthian and Celtic wars, and even then only by soldiers who were exposed to northern climates. The legs were protected by flat bands (*fasciæ*) laced round them up to the knees. On the feet senators wore shoes of red leather (*mulleus*, *calceus senatorius*), ornamented with knobs of ivory or brass, and having a high sole. The patrician order wore shoes of black leather (*calceus patricius*), ornamented with an ivory crescent, and hence called *lunula*. For unofficial occasions, and for persons not belonging to these orders, there were the sandals (*soleæ*). The *compagus*, said to have been introduced from Etruria by Romulus, appears to have been a high hunting boot laced up the front, while the *caliga* appears to have been a sort of shoe. For personal ornament finger-rings of great variety in the material and design were worn, sometimes to the extent of one or more on each finger, many persons possessing small cabinets of them. But at first the Roman citizen wore only an iron signet ring. A gold ring was introduced for persons sent on foreign embassies, but by degrees the *jus annuli aurei* was extended to all classes of citizens. In the case of baldness, a wig (*capillamentum*) was allowed to men as well as women during the empire. Till 290 B. C. it was the custom of men to let the hair and beard grow long. From that time shaving and short hair were the fashion, till under Hadrian, when long beards were again grown.

**Female Dress.**—The proximity of wealthy Greek towns in the south of Italy, and the extensive intercourse between the Romans and Greece and the East even in republican times, offered tempting facilities to Roman ladies for the supply of dress, and the result is that in artistic representations their dress does not differ in any important particulars from that of the Greeks as already described. Still the names for the main articles of dress remain Roman, from which it may be inferred that the differences between the original Roman and the imported Greek dress were not essential as regards shape. Next the skin was worn the *tunica interior* (*intusium* or *interula*), loose

and without sleeves. Under the breasts passed the *maxillare* or *strophium*. Then came the *tunica* proper, generally called *stola*, girt at the waist, and with sleeves fastened down the arms as in the chiton. Over this was thrown for out-door wear the *palla*, or plaid, identical with the Greek himation. A veil over the back of the head (*flammeum* or *ricinium*) was the mark of a well-to-do matron. In rainy weather a hood like the Etruscan *tutulus* was worn. To cover or hold up the hair, nets were used (*mitra*, *calantica*, *calantica*), but this simple article was far from common among the Roman ladies, whose chief characteristic in works of art is the elaborateness of their manner of braiding and twining the hair. After the Germanic wars a blond color of hair became fashionable, and to get this dyeing was resorted to. Generally the eyebrows and eyelashes were painted; even the veins on temples were sometimes touched with delicate blue color. The complexion was improved by various powders and washes. The teeth were carefully looked after, false ones making up the deficiency of nature. For the feet sandals, but by preference shoes, were made use of, generally of bright colors and embroidered with gold or pearls; socks or stockings were confined to ceremonial appearances. Personal ornaments consisted of brooches (*fibulæ*), bracelets (*armillæ*), armlets (*bracchialia*), ear-rings (*incaures*), necklaces (*monilia*), wreaths (*coronæ*), and hair-pins (*crinales*). The torc (*torques*), or cord of gold worn round the neck, was introduced from Gaul. A profusion of precious stones, and absence of skill or refinement in workmanship, distinguish Roman from Greek or Etruscan jewelry; but in the character of the designs there is no real difference.

#### EGYPTIAN AND ASSYRIAN.

**Egyptian.**—The ordinary male dress of the Egyptians, previous to about 1600 B. C., consisted of a piece of linen cloth tied round the loins, with occasionally an upper garment or skin of a tiger or leopard thrown round the body. Though this continued even to much later times to be the dress of many, yet from the date just given distinctions of grade in society began to be marked by different ways of girding the loins, by greater size of the cloth, by twining it up round the body, and by wearing two or more loin cloths of different materials (Weiss, *Kostümkunde*, i. fig. 18, p. 33). The peculiarly Ethiopian dress was in the form of a sleeveless skirt with fringe round the lower edge, hanging loose except among poorer people, who wore it fitting close to the body. The rule in earlier times was to go barefooted except on occasions of ceremonial, when a sort of hose of network or greaves were worn. But under the new empire, after 1600 B. C., covering for both feet and head came into general use, the former consisting of sandals, the latter of a cap made of leather, or of what some call

cotton. Magistrates and others of rank wore from the earliest times sandals, and on the head a square of cloth folded diagonally with its three points gathered together at the back of the neck. The dress of a king was distinguished by a triangular projecting skirt (fig. 8) of leather and ornamented with gold. Over this he wore a chiton and a sash round the waist. On his head was a crown, *pschent*, which could be of three kinds, either that of Lower or of Upper Egypt, or a combination of these two, the latter having nearly the appearance of a mitre. A queen wore a long, thin, and richly ornamented chiton, with sash round waist and shoulders (fig. 9). A broad collar round neck and over breast was worn both by men and women who could afford it. The taste for ornament was general, men wearing armlets, bracelets, anklets, and finger-rings, while women not only wore these articles in greater size, number, and richness



FIG. 8.—An Egyptian King.

general, men wearing armlets, bracelets, anklets, and finger-rings, while women not only wore these articles in greater size, number, and richness

but also diadems, girdles, and bands of ornament round the breasts and hips. The national dress, however, for poorer women was a simple close-fitting skirt reaching up to the breast and held up by straps over the shoulders. Woollen garments were worn chiefly by the poor, and occasionally by the rich, or by priests, who were permitted an upper dress of this material. Next the skin it was unlawful to wear it, nor could any one be buried in a dress of this material (Herod. ii. 81). A priest had to put off the woollen part of his dress before entering a temple. 'Cotton (*εἰρίσιαι ἀπὸ Φύλον*, Herod. iii. 47) appears to have been manufactured in Egypt, but to have been less used than linen, or *byblus*, which was made from flax and cotton.

**Assyrian.**—In weaving, embroidery, and dyeing the Assyrians surpassed the other ancient nations, as is known from tradition and may be seen in their existing sculptures. While the characteristic dress of an ordinary Egyptian was a cloth girt round the loins, that of an Assyrian was a long skirt worn close round the body and with short sleeves. This was worn by all classes, and apparently by women as well as by men. Only royal and priestly persons were allowed

an upper garment, at least during the early and flourishing period of Assyria. By the time of Herodotus a considerable variety of other dresses had been introduced among the different classes. The king's dress, as will be seen in fig. 10, consists of a long chiton, or skirt, with short sleeves, and above this a mantle with heavy fringes passing over one shoulder, or in other cases over both shoulders. The dress of a priest consisted of an under-chiton, and over it a sort of long narrow plaid with fringes wrapped spirally round the figure (Weiss, i. fig. 119, α, p. 202). Diadems variously ornamented were worn by officers of the court and by certain priests, as were also sandals. Hose did not come into use till a late period, and then chiefly as a part of the military dress. Necklaces, armlets, bracelets, and finger-rings were worn in abundance by Assyrians of rank. (A. S. M.)



FIG. 10.—An Assyrian King.

#### JEWISH.

Of the dress generally worn in ancient Israel there are known to exist no original authentic representations, nor is it possible to refer to any minute descriptions of it either in the one great source of Jewish history or in the pages of Josephus. Certain paintings and sculptures, it is true, in Egypt and Assyria, have been supposed to represent captive Israelites; but, even should this supposition be correct, in the figures thus represented there is nothing whatever which could be accepted as typical of national costume. On the other hand, while in certain details and accessories of the dress adopted by the different classes of the Israelite community, there doubtless arose from time to time both fresh modifications and decided changes of fashion and

adjustment, the general essential typical characteristics of dress may be assumed to have continued the same in Israel,—the same, also, as in no slight degree continue to distinguish the Oriental costume still worn in Palestine. The garments, certainly, were loose and flowing; the girdle was in universal use; and a primary motive in the head-gear was protection for the wearer from the hot sunshine of the East. The garments, in whatever manner or degree they may have been affected by varieties of material and adornment, certainly may be divided into two distinct groups, the under and the outer garments,—the former being light and specially adapted to a hot climate, and the latter being of heavier materials and suited to the colder seasons. As in the case of their arts, so in their costume the Israelites must be considered to have been influenced by usages prevalent in Egypt and Phœnicia; subsequently, by those of Assyria; and, still later, by those of the Romans. Again, it is more than probable that local influences introduced fashions of their own into the costume of the dwellers in the more mountainous districts of Palestine. For peculiar classes among them the Israelites had costumes specially appointed. For the priesthood there were their own official vestments, for which regulations were laid down with extreme minuteness, and enforced by supreme authority. The kings and princes had their "royal apparel," and for the warriors appropriate appointments were provided. Different ranks of persons, too, in various ways were distinguished by the richness, the costliness, the simplicity, or the meanness of their attire. So far as externals went, the episode in the Gospel of the rich man clothed in purple and fine linen with a Lazarus at his gate, so true a picture of Oriental life, would have been equally consistent had it found a place in some one of the earlier chapters in the same national history. Of the distinctive characteristics of female costume in Israel nothing is known, beyond the general fact that it was rich and delicate as far as circumstances would admit, and that personal ornaments were highly prized. Thus much is certain that the veil, a modern fashion now so prevalent in the East, in its modern acceptation was unknown among the women of ancient Israel, with certain exceptions only that are altogether at variance with the uses and associations of the Oriental veil at the present day. Furs, used both for warmth and adornment, with cloth woven from camels' and from goats' hair, including the "sackcloth" of sorrow and humiliation, were in use from an early period; so also, doubtless, was woollen cloth, the natural material for the clothing of a pastoral people. Familiarity with fabrics of linen, cotton, and silk, with those of various materials of foreign manufacture, may be considered to have been acquired by the Israelites in and from Egypt. There, too, they became familiar with the process of dyeing, and with the use of colored threads, and of gold-thread or fine wire, for textile purposes; and there they learned both to introduce various figures and devices into their woven fabrics, and to enhance their effectiveness with the needle. Needlework and embroidery, indeed, were extensively used by them in the production of various decorative fabrics. Whatever may have been the use in Israel of fabrics and decorations that were colored, those that were white (the natural hue of any material, as well as actual whiteness, being understood to be implied by their term "white") were in general use by the Israelites for their dress, and also were held by them in the highest estimation. This preference possibly may be traced to the provision in the Mosaic law which, apparently from the view to impress on the mind of the Israelites the idea of simplicity, and to protect them from the hurtful effects of Oriental luxury and extravagance, forbade the use of mixed textures such as would be produced by wool and flax in combination.

The particular garments of the Israelites, of which express mention is made, include the following:—

I. *Under Garments.*—(1.) The *sadin*, a light wrapper, worn next to the person. (2.) The *cetoneith*, or under-tunic, either sleeveless or having open sleeves, moderately loose, varying in length, and adjusted about the waist in such a manner as to form a pocket from an overlapping fold. Corresponding with the modern *kaftan*, the *cetoneith* was habitually in use, worn either with or without the *sadin*, by both sexes, and by persons of all ranks. (3.) The *mich*, or over-tunic, made with sleeves, longer and somewhat thicker in substance than the *cetoneith*, and, like it, in general use. To both these garments the term "coat" is applied in our version of the ancient Scriptures.

II. *Outer Garments.*—To all these garments, alike in being designed only for occasional use or for use under exceptional conditions and circumstances, in their generic character the term "cloak," as understood by ourselves, appears to have been applicable. Of these cloaks, robes, mantles, or wrappers there were several varieties, which differed from each other as well in form as in material, substance, and ornamentation; fringes, however, seem to have been generally attached to them; and they were worn with various modes of adjustment. The word *walbusah* distinguished a robe of state. Express mention is made, but unattended with any precise descriptive notices, of more than one variety of shawl, worn by women, which might be so adjusted as to form a head-covering in addition to enveloping the person. To very light female robes, also, which were long and flowing, occasional references are made. Of the male head-dresses worn by Israelites, distinct from such coverings for the head as might act as hoods formed by wrapping the mantle or cloak about the head, we have no exact knowledge. Though no such relics are known to be still in existence, goldsmiths' work and jewelry certainly enjoyed a high degree of estimation in ancient Israel, as always has been the case with all Eastern races; and they constituted important elements in the decoration of Jewish costume.

The passages of chief importance in the Old Testament, in which the vestments of the priesthood are enumerated and described, occur in Exodus xxviii., xxix., and xxxix., and in Leviticus viii. and xvi. In the Apocryphal books also reference may be made to Ecclesiasticus xlv., and to 1 Maccabees x. 21, in which last passage the entire investiture of the high priest is designed to be understood. Very full descriptive notices of the sacerdotal vestments of the Jewish priesthood are given by Josephus in his *Antiquities*, iii. 7, and in his *Wars*, v. v. 7. Further illustration on the same subject is given in his *Epistle to Fabiola*, ii. 574, written at Bethlehem by St. Jerome, 396 A. D.

An "order" or "change of garments," for a man—always in the East highly esteemed as both an honorable and a valuable present—among the Israelites consisted of a *canoneth* and a *miel*, with perhaps a *sadin*, and certainly one or more of the occasional outer robes, mantles, or cloaks. In presents of this kind, the number of the "changes of garments," which from their loose and flowing character would not fail to adapt themselves to general use, was studiously adjusted to the degree of estimation in which the recipient was held, and not without an indirect and yet significant reference to the dignity of the giver. The expression "naked," when applied to an Israelite, denoted, not a condition of actual nudity, but the fact of being attired only in a single under garment, and consequently implied the being in readiness for active exercise or violent exertion. The strongly marked and comprehensive distinction between the East and the West receives a characteristic illustration in the Oriental usage of uncovering the feet and covering the head, in token of respect and even of adoration. The "rending the garments," generally the outer garment only, an act so strange to us in the West, to the Israelites, in common with other Orientals, was peculiarly significant of grief, indignation, humiliation, and despair.

Among the figures painted in the very ancient tomb at Beni Hassan, in Egypt, occurs a group of figures from

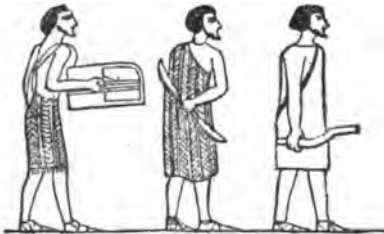

FIG. 11.—From Beni Hassan.

which the annexed woodcut has been drawn (fig. 11), conjectured to represent the arrival of Joseph's brethren when they went to purchase corn in the land of the Pharaohs. Again, considerably later, but as early as the days of the Pharaoh-Necho, by whom Josiah was defeated and slain at Megiddo, among some figures sculptured in one of the tombs discovered by Belzoni, near Thebes, which represent captives of different nations brought before their

Egyptian conqueror, four Jews are supposed to have been introduced after the manner shown in fig. 12. The fringes commanded by Moses, Num. xv. 38, to be worn by his people, and which probably was a relic of a still more ancient usage in the family of Jacob, may be considered to have been shown in both these groups. In the almost total absence of other not less improbable ancient examples, these figures may be accepted as contemporary representations of persons whose attire, such as it is shown to have been, at any rate may be considered to represent corresponding articles of dress in use in ancient Israel. Captive Jews, once more, are undoubtedly represented in the fine series of Assyrian bas-reliefs commemorating the capture of Lachish by Sennacherib, discovered and de-

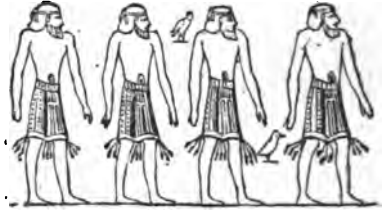

FIG. 12.—From tombs near Thebes.

scribed by Mr. Layard (*Nineveh and Babylon*, p. 152; and 2d series of *Monuments of Nineveh*, plates xx. to xxiv.). The physiognomy of these Jewish captives is strikingly indicated in the sculptures in question, but of their national costume very little is shown; for "they had been stripped of their ornaments and their fine raiment, and were left barefooted and half-clothed. From the women, too, had been removed the 'splendor of the foot ornaments, and the caps of network, and the crescents; the ear pendants, and the bracelets, and the thin veils; the head-dresses, and the ornaments of the legs, and the girdles, and the perfume boxes, and the amulets; the rings and the jewels of the nose; the embroidered robes, and the tunics, and the cloaks, and the satchels; the transparent garments, and the fine linen vests, and the turbans, and the mantles;' for they wore, 'instead of a girdle, a rope; and, instead of



FIG. 13.—Indoor Costume of modern Syrian Women.

a stomacher, a girding of sackcloth.'" See Isa. iiii. 18, &c.; and Ezek. xvi. 10, &c. Upon the exceedingly interesting description of the dress worn in ancient times by the women of Israel, as given by the two great prophets, Mr. Layard remarks that "most of the ornaments enumerated, probably, indeed, the whole of them, if we were acquainted with the exact meaning of the Hebrew words, are still to be traced in the costumes of Eastern women inhabiting the same country. Many appear to be mentioned in the Assyrian inscriptions among objects of tribute and spoil brought to the king." With this reference to the dress and ornaments of the female inhabitants of Syria at the present day, of whom two groups are represented in figs. 13 and 14, the following brief but graphic passage from the same writer's *Nineveh and Babylon* (p. 472) may consistently be associated. On approaching Baghdad, the



low banks of the Tigris—the river itself gradually becoming wider and wider, and its stream being almost motionless—were seen to “swarm with Arabs,—men, women, and naked children. Horsemen and riders on white asses were hurrying along the river side. Turks in flowing robes and

same regions in remote centuries; as, in like manner, the patriarchal dress of ancient Israel may be assumed to have had its primitive type in a great measure reproduced in our own times in the long coarse shirt, the ample striped *aba* of camels' hair (the colored stripe that alternates with the white one, denoting the wearer's tribe), and the red and yellow *keffieh*, folded and tied in hereditary fashion about his swarthy face and over his neck and shoulders by the Bedouin Arab of the desert (fig. 17).



FIG. 14.—Outdoor Costume of modern Syrian Women.

broad turbans; Persians in high black caps and close-fitting tunics; the Bokhara pilgrim in his white head-dress and way-worn garments; the Bedouin chief in his tasseled *keffieh* and striped *aba*; Baghdad ladies, with their scarlet and white draperies fretted with threads of gold,



FIG. 15.—Modern Syrian.

and their black horse-hair veils concealing even their eyes; Persian women wrapped in their sightless garments; and Arab girls in their simple blue shirts,—all were mingled together in one motley crowd.” In the costume in

ORIENTAL.

If it may be said, as it may certainly be said with truth, of Oriental costume both in its general character and its specific details, that it is distinguished, in contrast to that of the ever-changing West, by the pervading and characteristic unchangeableness of the East, equally true it is that the vast populations which through the wide expanse of the earth's surface included in “The East,” comprehend in their numbers the inheritors and the wearers of costumes exhibiting in many peculiar and distinctive features an almost endless variety. At the same time, precisely as a distinct recognition as well of the range as of the applicability and the significance of the one term “The East” suggests no confusion of ideas respecting different Eastern realms and peoples, so also all Oriental costume so far bears the impress of Eastern requirement and association as in a certain degree to admit of a single general classification. Thus, unlike to each other in not a few of their personal qualities as any two human beings well could be, and differing also in many decidedly marked particulars in regard to their costume, the nomad Bedouin of Arabia in every essential respect is no less a true and truly typical Oriental than the most gorgeously attired and, after his fashion, the most refined of the native potentates of Hindustan. So, also, notwithstanding the points of difference between their costumes, the costume as well of the one as of the other is unmistakably Oriental. The same may be said of the dresses of the different races that inhabit Hindustan. And they all share an equally true Oriental brotherhood, and especially in externals, in however decided a manner and degree each race may bear its own distinctive impress even in those very externals, with the natives of Japan and China and Burmah, of Persia, Arabia, Modern Egypt, Armenia, and Turkey, and with our Eastern races also that need not to be here particularized. Unless when circumstances reduce their attire to proportions so scanty as scarcely, if at all, to exceed that of the savage tribes who inhabit some tropical districts, or when influenced by some exceptional conditions, all Orientals are more or less inclined to wear loose and long and flowing garments; their trousers, when any are worn, are very large and gathered in at the ankles; they have their heads habitually covered, whether with a turban, fez, or some variety of cap of a local hereditary style; their feet, when not bare, are very lightly equipped; they delight in white fabrics, mingled with such as exhibit the most brilliant colors and the richest designs; and they indulge in an abundance and variety of personal ornaments. Also a general resemblance prevails between the costumes of the two sexes. The decorative arts of China and Japan, always national both in the selection and the treatment of their subjects, in connection with certain universally esteemed varieties of their manufactures, have familiarized the world with the typical characteristics of the costumes worn by all ranks and classes in those countries. Recent events have caused the more remarkable costumes of India to become well known through several popular publications; and the same may also be said concerning the costumes of other Oriental nations, and those of them more particularly which are nearest to Europe and have the closest relations with Europeans. In South-Eastern Europe itself, the costume of the modern Greeks exhibits semi-Oriental qualities.



FIG. 16.—Modern Syrian.



FIG. 17.—Bedouin.

ECCLESIASTICAL.

common and constant use at the present day, as well by men—such as is exemplified in the groups shown in figs. 15 and 16—as by women in the towns and villages of Syria, may be discerned the transmitted representations of the general character and aspect of the attire of the

attire habitually worn in everyday life, at successive periods, by ecclesiastical personages of all ranks and orders in the Christian church, *ecclesiastical costumes* here may be considered to imply and consequently to include the vestments, distinctively official and ministerial in their cha-

acter and use, which such personages would wear only when actually engaged in the functions of their respective offices, or on occasions of special state and solemnity. The habits, which with the advance of time came to be assumed by the members of the monastic orders, may most appropriately and advantageously be treated apart by themselves.

That ministering vestments, properly so called, and with them ecclesiastical insignia, were unknown among Christians of the apostolic age may be considered as unquestionably certain; and, in like manner, in the three succeeding centuries only the faintest traces, if indeed any authentic traces whatever, of such vestments can be said either to exist, or to have left indications of ever having existed. The long and flowing garments, suggestive of peaceful repose and enjoyment, and always in some degree endowed with dignified associations, whenever the circumstances of the times would permit, doubtless, were worn by the primitive Christian ministers when discharging their official duties; but it also is no less certain that on the same occasions precisely similar garments were generally worn by Christian worshippers, whose condition justified their appearing in them. During the prolonged stormy period of the second group of four centuries in the Christian era the primitive ecclesiastical costume—the costume, be it remembered, at times of joyous festival and solemn ceremonial adopted by *all* persons of comparatively high social standing—still was retained unchanged in its general style and aspect, and having experienced only such slight modifications and additions as naturally would have their development with the course of events. As time passed on, keeping pace both with innovations upon primitive doctrine and with vicissitudes of political position, in various ways these modifications became modified, and to these additions fresh novelties gradually were added. Even at the commencement of the 9th century, when the true historic era of ecclesiastical costume may be defined to have commenced with it, the two most remarkable circumstances in connection with ecclesiastical costume were, on the one hand, its approximately unchanged character, and, on the other hand, its close general resemblance, amounting almost to identity, to the old civil costume, which in the state dresses of the Roman official dignitaries survived the sweeping changes of barbarian revolution. It is worthy of especial remark that the earliest evidence of the introduction of any insignia distinctive of rank and dignity in ecclesiastical costume is to be derived from the presence of two dark strips of varying width on the long white tunics in which certain early figures, certainly to be regarded as habited in ecclesiastical vestments, are represented; and these strips can be considered in no other light than as adaptations from the *clavi*, some broad and others narrow, so well known in classic attire to distinguish the Roman senatorial and equestrian ranks. Equally remarkable is the fact that the Christian hierarchy should have derived the insignia of their rank in the church, through the high position of civil power in the state exercised by the early bishops of Rome, from the official decorations of the Roman magistracy as well of the republic as of the empire. It will be borne in mind that all changes in ecclesiastical vestments, and all additions to those of early date, made by authority during the Middle Ages, were designed to be suggestive of some symbolical motive and to convey some doctrinal significance—considerations, however important in many respects in themselves, which it would be out of place here to discuss even superficially, when treating of all ecclesiastical vestments simply in their capacity as “costume.” In connection also with the full development in the 11th and 12th centuries of that type of vestments which, when once it had been formally established, has been maintained with but slight modifications in the Roman Church to the present time, no unimportant part was taken by the attempts, first contemplated in the 9th century, that were made to assimilate such vestments as might be distinctive of the Christian ministry with those appointed in the Mosaic law for the priesthood in Israel. The idea that any such similitude might exist, or should be made to attain to existence, once having arisen would naturally take a strong hold on the minds of the more ambitious and also of the more learned ecclesiastics of those times. So, when in the first instance the points of difference between the two types of vestments were found to be far more decided than those of resemblance, a process of deliberate assimilation was decreed,

which brought about as close an approximation between the two types as was held to be desirable—an approximation, it scarcely is necessary to add, that removed the elaborate and ornate vestments of mediæval Christendom as far as possible from retaining any affinity to the dignified simplicity of Christian ministerial costume in primitive times.

#### VESTMENTS IN USE IN THE WEST.

1. The *Alb*.—In the Acts of the Council of Toledo, 633, the habits and insignia of the three orders of the clergy are thus defined:—of the bishop, the *orarium*, the *ring*, and the *staff*; of the presbyter, the *orarium* and the *planeta*; and of the deacon, the *orarium* and the *alba* or *alb*. In this definition it may be assumed to have been implied that the *alb* was common to the three orders, as the *planeta* was worn by bishops as well as by presbyters. Its name abbreviated from *tunica alba*, and at first the simple and yet dignified white linen tunic that in the primitive ages was held to be the costume appropriate for the Christian ministry, in the 9th century the *alb* began to have its loose and flowing proportions contracted; and these changes were continued until the vestment was made to fit with comparative closeness about the person of the wearer, when it was confined about the waist by a narrow girdle. The pure simplicity of the early white tunic also was superseded by the addition of rich “*orfreys*” (*aurifrigia*) of embroidery and goldsmiths’ work. These “*apparels*” (*parure*), in the form of masses and stripes, were attached to the lower part of the *alb* and to the wrists of its sleeves. In the second half of the 14th century the wrist-*apparels* of *albs*, instead of encircling the sleeves as previously had been the custom, appear only upon the upper part of them.



FIG. 18.—From brass at Horsham, showing Stole, etc.

some few early ecclesiastical effigies, which are without a chasuble, but in its stead have a cope open in front, the entire adjustment of the stole is distinctly shown, as in fig. 18 drawn from a brass at Horsham. This effigy also shows in what manner the *alb*, *amice*, and *maniple* are worn, and it may advantageously be compared with fig. 20, also drawn from a brass to Peter de Lacy, rector of Northfleet, in Northfleet Church, in which the stole for the most part is covered by the chasuble. Its ancient name *orarium*, equivalent to our “handkerchief,” shows the mediæval stole to have been designed as well to wipe the face as, in accordance with primitive usage, to cover it when offering prayer. For deacons it was appointed to wear the stole depending from over the left shoulder only, so as to show but one end of it on the front of their persons (fig. 19). The idea of a connection in the significance of the stole to denote dignity with the ribband worn as a knightly distinction is obvious.



FIG. 19.—Deacon—9th century.

3. The *Maniple*.—A short species of stole, the representative of the ancient *mappula* and its successor, the *maniple*, which is worn so as to hang from the left wrist, may be considered to have been substituted in the first instance for the purposes to which the stole itself originally had been applied. Like the stole, however, the *maniple*, regarded as one of the ecclesiastical vestments as early as the 9th century, soon became merely a decorative accessory of the official costume of ecclesiastics (see figs. 18, 20).

4. The *Chasuble*.—This super-vestment, worn over the *alb* and the stole, and by ecclesiastics of episcopal rank also over the dalmatic and tunic, which in the 11th century was expressly associated with the ecclesiastical office, is identical with the *casula* of the 9th century and, through it, derived from the *planeta* of still earlier times. Both *planeta* and *casula*, how-

over, as over-garments furnished with a hood which would envelop the entire person, were worn by laymen, the chief if not the only distinction between these two garments being that the former from its greater costliness was in use by persons of rank and wealth, while the latter was adopted by the humbler and poorer classes. In form and general character both the *planeta* and the *casula* appear to have resembled the ancient *paenula*, an outer garment worn in Italy long before our era, and of which the memory still survives in the title of the ecclesiastical super-vestment of the East. Circular or oval in form, and having in the centre an aperture for the head of the wearer to pass through, the chasuble covers the arms as well as the body, so that when they are raised it falls over the arms both before and behind. Made of various materials and of different colors, in early representations of it this vestment is constantly found to have been elaborately adorned with embroideries and other decorative accessories, also with a profusion of orfrees in gold and silver work enriched with gems (fig. 20). A favorite form of chasuble-orfrey, evidently an imitation of the archiepiscopal pall, encircles the head-aperture, and, passing over the shoulders of the wearer, falls in a straight line down both the back and the front of his person.

5. The *Amice*.—First mentioned as a vestment in the 9th century, and from the following century enriched with apparels, when opened out the *amice* was square in shape, and it was adjusted precisely after the manner of its present adjustment, beneath both alb and chasuble, about the throat and over the shoulders. In monumental effigies the apparel of this vestment is represented either falling back from the throat of the wearer, or, in the later examples, standing up somewhat stiffly around it; and this position over the chasuble sometimes has suggested the mistaken idea that the apparel of the *amice* forms a collar to the chasuble itself. By holding it for a few moments over the head at the time of putting it on, the *amice* in course of time was considered to symbolize the Christian helmet (see fig. 20).

6. The *Dalmatic*, a full-sleeved tunic reaching about to the knees. Long after its adoption as an ecclesiastical vestment, the dalmatic continued in use in Rome as a garment appropriate for secular officials on occasions of ceremony and state; and at the present time it continues, as it continued through the Middle Ages, to be a royal robe as well in England as on the Continent. Like the other ancient vestments, originally white and plain, in the 10th century the dalmatic assumed various colors, and in the 12th and the succeeding centuries it followed the color of the chasuble. Appointed to be worn by deacons over the alb as the distinctive vestment of their order, when made of costly materials and richly adorned the dalmatic was added to their official costumes by prelates, by them to be worn immediately under the chasuble. In early episcopal effigies the lower part of the dalmatic is represented, appearing beneath the chasuble, richly fringed and partially slit up at the sides, as in fig. 21, drawn from the corresponding part of the brass at Thomas Cranley, archbishop of Dublin, in the chapel of New College, Oxford, 1417. Nearly a century earlier (1327), in the cathedral of St. Nazaire at Carcassonne in France, the statue of Bishop Pierre de Roquefort, which is without the chasuble, shows with admirable distinctness the form and adjustment of the episcopal dalmatic, with the tunic appearing beneath it, the ends of the stole being visible issuing from beneath them both. The large sleeves of the dalmatic and the tight sleeves of the tunic are shown at the wrists, and from the left wrist the maniple hangs down (fig. 22). Over the other vestment (as in fig. 18) is a cope, fastened across the breast with a morse charged with an *Agnus Dei*. The prelate wears his mitre, and in his hand he holds his pastoral-staff. In England, in Norwich Cathedral, there is a similar example of the episcopal habit in the effigy of Bishop Goldwell (1498) which represents both dalmatic and tunic as shorter than

in the French statue; the dalmatic also has a broad central vertical band of rich embroidery, and at the wrists the sleeves of the alb, tunic, and dalmatic are shown. Figures of deacons, rare in mediæval art, when they occur generally profess to represent St. Lawrence, with the instrument of his martyrdom. In fig. 23, reduced from a drawing on vellum in a MS. of the 13th century in the Lambeth Library, the dalmatic, which is nearly as long as the unusually short alb, is shown as it was ornamented and worn at that period. Another good example, much later in date, also a figure of St. Lawrence, is sculptured in one of the canopied compartments of the monumental chantry of Prince Arthur Tudor in Worcester Cathedral. Fig. 19, from the *Tiber Pontificalis* of Landolfus, a MS. of the 9th century, shows how the stole was disposed over the left shoulder by a deacon wearing an alb and a dalmatic.

7. The *Tunic*.—The vestment distinguished by this name, worn by prelates between the alb and the dalmatic, is rather longer than the vestment last named, and its sleeves also are somewhat longer and not quite so full. As the vestments increased in number, and at the same time became less simple and more splendid, the gradual addition of one tunic after another, to be traced from the 9th century downwards, was strictly in keeping with the spirit of the times. Early in the 14th century it had a remarkable parallel in the succession of surcoats, with which, regardless of their palpable inconvenience, the knights covered their armor. It is specially curious to observe how studiously the men-at-arms carried out their imitation of the ecclesiastical vestments of their day, by making each one of their successive surcoats in front of their persons shorter than the one beneath it, so displaying them all. In the case of the ecclesiastical vestments, the tunic proper, become distinctively the *alb* or *under-tunic*, was covered by the *tunic*, a rich and splendid vestment; and the *dalmatic*, shorn of its ancient length in order to leave the second or middle tunic visible, followed, third in order, and became the super-tunic of the group. The tunic, like the dalmatic, partially slit at its sides and generally fringed, is well represented in monumental effigies and other early works (see fig. 21).



FIG. 20.—From brass at Northfleet, showing Chasuble, etc.



FIG. 22.—Showing Dalmatic, etc. (After Viollet-le-Duc.)



FIG. 23.—From vellum drawing at Lambeth, showing Dalmatic, etc.



FIG. 21.—From brass at Oxford, showing Dalmatic.

8. The *Cope*, a voluminous cloak or outer garment, originally furnished with a hood for covering and protecting the head, and of sufficient size to envelop the entire person of the wearer, would naturally admit of every possible variety in material, color, and ornamentation, and it also would be used as well by laymen, as by ecclesiastics of all orders and by monks. Richly adorned copes, however, appear in mediæval times to have been considered as almost exclusively ecclesiastical vestments of stately dignity, to be worn in processions and on those ceremonial occasions which would be distinguished from the service of the altar. Such copes, having splendid border-apparels into which canopied figures of sainted personages frequently were introduced with heraldic and other devices, were fastened across the breast by a morse, often of costly material and highly artistic workmanship (see fig. 22).

9. The *Almuce* or *Aumuce*, a hood of fur, was apparently introduced in the 13th century, its object being to afford protection from cold in processions, &c., and in the 15th century a cape and pendants also of fur were added to it.

10. The *Surplice*, an alb, almost of primitive form, ample and flowing, and closely resembling the surplice of the present day, was in use in the Middle Ages in processions and on certain occasions of ceremony. An excellent example of a surplice of the 15th century is given in the noble brass to Prior Nelond, at Cowfold, Sussex, 1433.

11. The *Mitre*.—First mentioned among ecclesiastical vestments about the middle of the 12th century, though some kind of dignified episcopal head-gear certainly had been in use considerably earlier, the mitre originally was made of linen embroidered; and it does not appear in its well-known double or cleft form until the 12th century had made a considerable advance, when it began to be constructed of some rich material and to receive costly adornment. Previous to the 14th century, when they attained to the perfection of their form, mitres were very low, their contour then being concave. Subsequently they became more and more elevated, and their contour was changed from concave to convex. Two short bands of some rich material, fringed at the ends, form the *infolds* of a mitre, and depend from it, one on either side.

12. The *Crosier* and the *Pastoral-staff*.—The former, having a cross-head, is appropriated to archbishops; and the latter, the official pastoral-staff of bishops and abbots, has a crook-head, like the head of a shepherd's staff. Expressly mentioned as the ensign of the episcopal office in the first half of the 7th century, as early as the 10th century the pastoral-staff became enriched with elaborate and precious ornamentation, and was adorned with a *vezillum*, or scarf, attached to the staff immediately below the cross or crook-head. The idea that some special signification is conveyed by the position in which in monumental effigies and in other episcopal figures the pastoral-staff is represented to be held appears to be without any foundation.

13. The episcopal *Ring, Gloves, and Boots*.—Early in the 7th century, and probably still earlier, a ring of large size, to be worn on the right hand, formed a regular part of the episcopal insignia; and in the full development of the vestments which took place in the 12th century, embroidered gloves, made with an opening to display the ring, and corresponding boots or shoes were included as components of the full official attire of the hierarchy.

14. The *Pall* ("Pallium").—This remarkable vestment, sent by the Pope to prelates of archiepiscopal rank, and restricted to their order, being in fact a peculiar form of the orarium or stole, consists of a narrow band of white lamb's wool, forming a circle to rest on the chasuble around the throat and over the shoulders, from which circle depend two other bands of the same fabric and width to hang down, the one on the front and the other on the back of the prelate, thus, whether seen in front or behind, presenting the appearance of the letter V. The depending bands, which terminate in fringes and appear occasionally to have been fastened with golden pins to the chasuble, like the circular band, are charged with crosses *pattée-fitchée* of black or purple silk. This pall, constantly represented in early works of Christian art through successive centuries, and blazoned among ourselves in the armorial insignia of the archiepiscopal see of Canterbury, is seen to have varied but slightly in either its form or its adjustment from the 9th century to the 16th. An apparel, evidently designed to represent the pall, is found constantly to have been adopted for the ornamentation of mediæval chasubles. The pall still in use in the Roman Church has the pendent bands considerably shorter than they appear in the early representations (see fig. 21).

15. The *Chimere* and *Rocket*.—Of the former it will be sufficient to state it to be a modification of the cope; while the latter, a long sleeveless robe representing a garment known as a *colobium* in ancient times, appears to have been assigned distinctively for episcopal use, and also after the Reformation to have been allied to the full lawn-sleeves well known at the present day, from being well suited to be worn under another vestment. By prelates of the Reformed Church a short cassock of black silk is worn with their ordinary attire. A long loose black cassock also was commonly worn by ecclesiastics during the 17th and 18th centuries.

**VESTMENTS IN USE IN THE EAST.**—In its general bearing, what has been said of the vestments in use in Western Christendom, and particularly in reference to their use during the first eight centuries of our era, with comparatively slight modifications, is also applicable to the official vestments of the church in the East,—the chief distinctions between the vestments of the East and the West, in addition to such as may in a great degree be traced to the influences of climate and to certain local associations, being a closer adherence in the former than in the latter to the earliest usages. The Greek Church also, being very tenacious in its own usages, to the present day retains everywhere its mediæval vestments, their forms, names, and uses remaining unchanged—the *sticharion* corresponding with the alb and the early dalmatic of the West; the *phalomon*, with the chasuble and its earlier predecessors, the *casula*

and *planeta*; the *omophoron*, with the pall; and the *orarium*, with the orarium and its successor the *stola*.

#### MONASTIC.

The habits worn during the Middle Ages by the monastic orders may be briefly described as follows:—

*Benedictines*.—Gown or cassock of black, white, or russet cloth, with white or black fur, and black cape and hood.

*Cluniacs*.—Habit entirely black.

*Cistercians*.—White cassock with cape and small hood; over this when in the church a white gown, when abroad a black gown.

*Carthusians*.—Habit entirely white, except black cloak.

*Augustines*.—Black cassock under white full-sleeved tunic; over all, black cloak and hood; square black cap.

*Pramonstratensians*.—White Canons.—Cassock and tunic, long cloak and hood, and round cap,—all of them white.

*Gilbertines*.—Monks.—Black cassock and hood, and white cloak lined with lamb's wool. Nuns.—Black tunic, cloak, and hood, the last lined with lamb's wool.

*Dominicans*, or "Black Friars."—Same habit as that worn by the Augustine monks.

*Franciscans*, or "Grey Friars."—Loose and long grey cassock girded with a cord; hood or cowl and cloak of the same.

*Carmelites*, or "White Friars."—Habit white throughout; but from about 1240 to about 1290, their cloaks were parti-colored, white and red.

*Austin Friars*, or "Eremites."—White cassock girded with a leather thong, with short tunic and hood; and over these, long black gown with wide sleeves and hood.

*Crossed* ("Crutched") *Friars*.—Blue habit, with plain red cross.

*Maturins*, or "Trinitarian Friars."—Habit entirely white, with eight-pointed cross of red and blue.

The monastic garment named "*scapular*," the exact character of which has not been decidedly determined, appears to have been a short super-tunic, sleeveless, but having a hood or cowl.

#### ACADEMIC.

In the Middle Ages, professors or doctors and bachelors of divinity, and graduates of the universities above the rank of bachelor in the faculties of arts and law, in addition to the customary costume of their time and station, in connection with their academic rank wore long flowing gowns having slits at the sides for their arms to pass through, with large capes or tippets and hoods, the latter having pendent streamers, these capes and hoods in many instances forming parts of the same article of dress. Graduates of the highest rank also wore round caps, pointed in the crown, and of a dark color. In the 15th century, when distinctions appear first to have been introduced into the costumes of masters and bachelors of arts, the gowns of the latter were shorter than those of masters, and had full sleeves reaching to the wrists and pointed at the back. The capes and hoods of bachelors also were bordered with white fur or wool. By various peculiarities of form, color, and lining, the gowns, capes, and hoods of graduates of all the higher ranks certainly were distinguished; but in the comparatively rare examples of monumental effigies represented in academic habit, which almost without exception are destitute of color, these distinctions are not shown in any regular or marked and decided manner. Throughout the last two hundred years, if not for a still longer period, the academic habits of the University of Oxford have retained their forms unaltered. They may generally be classified in two groups—ecclesiastical and civil. The gowns of the former, worn by all graduates in both divinity and arts, and also by all members on the foundation of any college, have loose sleeves, are destitute of collars and gathered in in small plaits at the back, and bear a general resemblance to what is known of the more ancient habits, the sleeves of the masters' gowns still having slits (now cut horizontally, instead of vertically) for the passage of the arms. On the other hand, the gowns of graduates in law and the other faculties, and of undergraduates who are not on the foundation of any college, besides being of less ample proportions, have falling collars and closer sleeves, which latter in the undergraduates' gowns have dwindled into mere strips; and they evidently derive their origin from parts of the ordinary dress of civilians in the 16th and 17th centuries. The gowns of graduates of the University of Cambridge for the most part are the same as those worn in the sister university; but at Cambridge the undergraduates, not being on the foundation, of almost every college have a gown appropriated to their own col-

lege. The hoods of their degrees worn by graduates in the faculties of divinity and arts are distinguished as follows:—D. D., Oxford scarlet cloth, lined with black silk; Cambridge, scarlet cloth, lined with lilac blossom or pink silk; M. A., Oxford, black, lined with cherry-color or crimson; Cambridge, black, lined with white; Dublin, lined with blue; Durham, lined with purple; London, lined with brown. B. A. hoods are black and bordered with white fur.

#### EARLY EUROPEAN AND MEDIEVAL.

For the purpose of the present article the terms "early European" and "medieval" may be considered to apply to the period ranging from the withdrawal of the Romans from Britain to the accession of the Stuarts to the throne of Great Britain—that is, from about the close of the first quarter of the 5th century to the commencement of the 17th century; and the latter term, "medieval," may date the commencement of its application from the establishment of his Anglo-Saxon dynasty by Egbert at the opening of the 9th century.

A prolonged period of total darkness having passed away, at first, and for a considerable time, in addition to written descriptions and indirect notices which frequently are far from being intelligible, and to such actual relics as originally were deposited with the remains of the dead without any view either to monumental commemoration or to historical illustration, the authorities are restricted to the illuminated compositions which so happily are associated with early MSS. After a while, the earliest seals and some ivory carvings lend such aid as may lie within the compass of their power. Next follow those invaluable illustrators of costume, monumental effigies of every class, with which may be allied figures represented in architectural sculpture and painting, upon seals also and coins. Actual relics throughout the era of monumental effigies gradually increase in both number and variety, until at length the ages of personal portraiture, properly so called, are duly reached. It will be borne in mind that until some years after the close of the 15th century, defensive armor occupied a most important position in what strictly was the "costume" of the men of the higher classes, whose effigies, with rare exceptions only, appear sculptured, engraved, or painted in their armor, precisely as the men themselves had been armed and equipped when in life. In the Middle Ages in Europe, costume, considered as dress distinct and distinguished from armor, was affected in no slight degree by the prevailing character of the armor of each successive period, so long as a defensive equipment of any kind continued to be generally adopted. Dresses that had been devised expressly to be worn, some of them under defences of mail or plate, and others over them, suggested much in the way of garments that never would have any direct connection with armor. Again, when not armed, nobles, knights, and men-at-arms naturally would adopt such loose and flowing garments as would combine the greatest degree of ease with a dignified aspect; and their example in this respect would be certain to be very widely followed. The feudal system, also, powerfully aided by the heraldic sentiment that at once grew up in the feudal era and gave to it its tone and color, exercised a powerful influence upon the costume of the various classes who, under varying conditions, were dependent upon a common feudal superior. And this influence, while adapting itself in matters of detail to personal considerations, in its general bearing acted with uniform effect upon the entire community. Of the extravagance of so many of the diverse costumes that followed each other in rapid succession during the 14th and 15th centuries, much may be directly traced to the development of heraldry in those ages, and to the enthusiastic delight in armorial devices and insignia then universally prevalent. The singular resemblance in many marked particulars between the dresses of the two sexes, observable in the Middle Ages, undoubtedly was stimulated by the science and art of the contemporary heralds; as the strange and often wildly fantastic crests and the mantlings displayed upon their helms and basinets by the one sex were parodied, and sometimes were fairly outdone, by the equally strange and no less wildly fanciful head-gear adopted by the other sex, with a view either to conceal or to enhance the natural glory of their hair. Medieval costume, once more, would experience both changes and modifications arising out of

the introduction of fresh manufactures, and necessarily resulting from the constantly expanding range of the foreign commercial relations of different countries. Costume, moreover, would be certain to be attracted by the progressive phases of national civilization, culture, and refinement, even though it might not consistently keep pace with them. Fashion, too, always arbitrary and often inexplicable, would not fail to do its work effectually, under the diversified conditions and aspects of advancing centuries, among races by whom to costume it is assigned, not merely to clothe the persons of both sexes, but also to display and adorn the human figure.

It will be observed that, in all countries among civilized races, in the degree that climate is more temperate, in that same degree is costume more liable to changes and fluctuations, and more completely under the sway of fashion. In regions that are very hot or very cold, fashion, however quaint and eccentric, is long-lived and tenacious of its hold, so that the costume of one generation for the most part is reflected in that of its successor. In like manner, costume, and especially in its general character, is comparatively permanent among mountaineers. The history of costume, it must be added, approximately complete and explicit as it may be, can contain but little more than scant notices of the unavoidably simple or even rude attire of a considerable proportion of the laborious population in every country and at every period.

Subjugation by the Romans in the first centuries of the Christian era naturally was followed by a general conformity among the conquered populations to the costume of their more civilized as well as more powerful rulers, so that after a while Roman dress may be considered to have become European. And, as Rome herself through her Eastern connections had yielded in no slight degree to Oriental influences in matters connected with costume, so also Roman influence in the West carried with it much that was strongly marked with the characteristics of the East. This singular association also in after-times derived fresh impulses, as well in peaceful costume as in armor and other military matters, through the direct agency of the crusades, acting in concert with an artistic current flowing westwards continually in the Middle Ages from Byzantium.

ANGLO-SAXON.—Generally simple in its character and designedly adapted both to the tastes and sentiments and to the usages and requirements of a hardy and temperate race, the prevailing costume of the Anglo-Saxons consisted of a sleeved tunic, varying in length, but generally comparatively short, partly open at the sides, and confined about the waist by a girdle. Over this tunic, which was made of various colors, and both plain and occasionally enriched with varied ornamentation, a short cloak was worn by the young, while in its stead a mantle of ample dimensions and greater length was adopted by persons more advanced in age. Similar mantles, not assumed as wrappers for extra warmth or protection against the weather, were in general use at ceremonies and festivals. Trews, or drawers, continued to form hose for the lower limbs, while shoes or low boots completed the ordinary attire of the men, who wore their beards, and delighted in having long and flowing hair. Ornaments, many of them of gold, and remarkable for beauty of design and excellence of workmanship, were freely used by the Anglo-Saxons of both sexes; and the numerous fibulae, brooches, armlets, and other personal ornaments that have been discovered in their graves attest the attainment of the Anglo-Saxons to an advanced condition of civilization and refinement. A peculiarity in the dress of the men of all ranks was the cross-gartering of their hose, or their simply covering their legs below the knee with cross swathing bands fastened at the knee. The females wore long tunics or gowns, made loose and high, and girt in about the waist. Over these they had shorter tunics, often much enriched, and with sleeves, unlike the close-fitting sleeves of their under tunics, that were very wide, and widest at the wrist. Over all, mantles of ample size and provided with hoods to cover the head were thrown, and disposed with effective gracefulness. Coverchefs also were habitually in use, to cover the head when the mantle would not be assumed; and they often were so adjusted as to encircle the face and to cover both the throat and the shoulders; so that they may correctly be regarded as prototypes of the wimple, so popular in somewhat later times. The girdle, it may be added, as worn by both sexes, was rather a swathing band,

folded for doing girdle duty, than a girdle proper. The costume of the princes, the nobles, and the wealthy, while in its general character the same as that already described, was distinguished by greater richness of material and more costly adornment. As if to parody the universal fashion of cross bandages for the legs, the Anglo-Saxons habitually wore upon their arms twisted bracelets or *torques*, or, in their stead, a number of simple bracelets—a custom common to them and all their kindred of Scandinavian descent.

#### COSTUMES (ESPECIALLY ENGLISH) FROM THE 11TH TO THE 17TH CENTURY.

*Century XI.*—During the brief rule of the Danes, the national costume does not appear to have experienced any change in England. The advent of the Normans brought with it to England the establishment of that luxury in dress, with which the Anglo-Saxons previously had become in some degree acquainted, and which was destined to so great an extent to supersede the still prevailing simplicity of their hereditary attire. The Norman conquerors, however, with their short cloaks and shaven faces, were not slow to adopt so much of the Saxon style of dress as led them to wear tunics of ample proportions, and in many ways to assume whatever in that dress was most graceful and dignified. Still, as in other things, so in costume, until the 12th century had made a considerable advance the powerful and wealthy Anglo-Normans preserved an external visible distinction between themselves and their Anglo-Saxon fellow-subjects. And yet, the ordinary costume of the people of England appears to have undergone no characteristic change during the second half of the 11th century, seeing that short tunics and capes, cloaks with hoods, cross-banded chausses or hose, shoes or low boots, and caps pointed in the crown continued in general use. But it was not so with the nobles, who speedily indulged in every species of ostentatious display upon their persons, covering their rich dresses with ornamentation, introducing gorgeous novelties in fabrics, with costly furs, lengthening their garments till they swept the ground, and widening their sleeves till they hung down open-mouthed from their wrists. To these wide and open-mouthed sleeves the Norman ladies speedily added long pendent lappets, in which extravagant form this portion of their dress was commemorated in the heraldic "maunche" of later times (fig. 24). Tunics richly adorned, made to fit closely about the figure, but with long and loosely flowing skirts, and having the "maunche" sleeves, with splendid mantles of ample size which were fastened on one of the shoulders and were furnished with hoods, enjoyed the highest favor with the Norman ladies, who also wore their hair in heavy and long braids, when the century of the Conquest came to its termination.

*Century XII.*—Like their armor—if to their defensive equipment the term armor may be applicable—and weapons, the costume of the Normans when they established themselves in England, while exhibiting significant tokens of affinity to that worn by their own Scandinavian contemporaries, had become assimilated to the dress prevalent among the races with whom they were familiar more to the south. As a matter of course, also, through what remained of the 11th century, and until the succeeding century had far advanced, the distinctive characteristics of Anglo-Saxon and Anglo-Norman attire were retained, and appeared simultaneously in use; nor can they be considered to have become blended in what might claim to be accepted as a single national costume before the reign of Henry III. Many circumstances appear to have combined to have caused the same general character of costume, unless under special local circumstances, to have prevailed throughout Europe during the period of mediæval armor—from the second half of the 12th century, that is, till the end of the 16th—the same general uniformity in essentials being further observable in the armor itself. It may here be remarked, that both the armor and the costume represented in the monumental effigies of the Middle Ages are alike in being distinguished by a pervading simplicity and an absence of excesses, which in a signal degree qualify them to be accepted as typical rather than as exceptional examples and authorities. This is especially the case with the monumental effigies of various kinds, second to none as works of mediæval art, that abound throughout England. It but too frequently happens, however, that in forming their estimate of costume, reversing the judicious and sound principles adopted by the monumental artists of the Middle Ages, writers permit themselves to select as their types the occasional eccentricities and vagaries of fashion or of individual extravagance.



FIG. 24.—"Maunche" Sleeve.

The first sculptured representations of English sovereigns that are known to exist in England appear at the sides of the great west doorway-arch of Rochester Cathedral, and they show the costume worn by Henry I. and his queen Matilda of Scotland. The king, in whose reign boards and long hair again came into fashion, has gathered about his person a flowing tunic, worn under a dalmatic and a mantle; his queen also wears corresponding garments, the sleeves of her dalmatic (or over-tunic) being even wider than those of her consort. Her hair she wears in two very long braids, one of them hanging down on either side on the front of her person. Under and upper tunics, girdles, and mantles, both with and without hoods, pointed caps and low hats with wide brims, and leggings and shoes, are represented in the various illuminations of this era, which convey very clear and well-defined ideas of the costume then in use by various classes and both sexes. Towards the close of this century the costume of Henry II. and of his Queen Eleanor, as represented in their effigies, may be accepted as characteristic illustrations of a period in which considerable luxury in dress was becoming generally prevalent. The king is attired in an under-tunic reaching to his feet, and a blue tunic almost of the same length, both garments having comparatively tight sleeves reaching to the wrists; over the upper-tunic is a dalmatic of crimson enriched with a floral pattern in gold, long but not very full, and without any front-opening being apparent, its full sleeves shorter than those of the tunic; over all, a purple mantle, fastened with a morse on the right shoulder, covers the left arm, and is drawn up on the right side so as partly to cover the figure also on the right side below the girdle. The gloves are jewelled, and the boots, green in color, enriched with gold and armed with golden spurs, are broad and slightly pointed. Over a white under-tunic, visible only at the throat where it is fastened by a circular brooch, the queen wears a long tunic or gown, loose throughout, its sleeves tight at the wrists, and enlarging upwards to the shoulders, which is secured about the waist by a buckled girdle. The pattern upon this dress, which is represented to have been worn uncovered by a dalmatic, and is white, consists of golden crescents in pairs, set reversed and contained within the meshes of an interlaced lozenge-work also golden. The mantle of blue, studded with golden crescents, is secured across the breast with a cord, and, falling back from the shoulders, it is gathered up on both sides and drawn partly across the figure in front. About her face the queen has a plain wimple; and beneath her crown her head is covered with a coverchef, which falls in folds on either shoulder. The king also is crowned; but his sceptre has been broken away from his right hand. In her illuminated portraits, Eleanor of Aquitaine is represented with a wimple, which is fastened with a circlet of gems; her under-tunic, or cote-hardi, fitting closely and having tight sleeves, is gathered into a rich collar about her throat; over this dress is a loose tunic, long and flowing, guarded with fur, its full and open sleeves also being lined with fur; and, over all, there is the ever-present mantle, generally of some light material, so adjusted that at the pleasure of the wearer it might be drawn over the head. Henry II. is not known to have been represented wearing the short cloak of Anjou, familiarly associated with his name. A few years later the same royal attire is represented in the effigy of Richard I. Here, over a white under-tunic, the long tunic and the almost equally long crimson dalmatic are shown to be slit up at the sides; the latter garment has very full sleeves, which hang down from a little above the wrists, and the rich girdle, covered by the mantle in his father's effigy, is shown. The mantle, of royal blue and gold, has a different adjustment, being fastened in the centre over the chest by a large morse, from which it falls back over the right shoulder, but on the left side it is drawn forward so as partly to cover the person and to hang down in folds over the arm; and on the right side also this mantle is drawn forward below the girdle. The king is crowned; he wears gloves, jewelled at the back of the hand; and to his enriched boots, which in their form and adornment resemble his father's, his spurs are attached by buckled straps. In all these royal effigies it is certain that a faithful representation is given of the remains, attired as had been the custom of these personages in life, when lying in state before interment. In that warlike and turbulent age, when the possession of good arms and armor and the means of effecting improvements in them were objects of supreme importance, the peaceful population appear to have been content to retain the system and style of dress in use shortly after the establishment of the Norman dynasty. A tunic, worn over some under-garment, generally made to reach about to the knees, but sometimes very short, constantly made with a cape and occasionally also with a hood, loose chausses or trews and light hose and pointed boots or shoes, with some kind of cap for head-gear, and a hood to the favorite cloak or mantle, formed the prevalent male dress. The nobles and other men of rank, when not in their armor, aspired to rival the princes in the richness of their attire; and, in addition to such costumes as might be habitual to them when engaged in active occupations, wealthy citizens were not slow to follow the higher and perhaps still richer classes as closely as

might be permitted to them, by indulging in long and flowing gown-like tunics when in repose or on occasions of ceremony and festivity. The long tunics which came into use by men early in the century at first had long sleeves very wide at the wrists; and at the same time the sleeves of their tunics were worn of extravagant length and proportions by ladies of rank. This extravagance, particularly in the male attire, however, had almost disappeared before the close of the century. On the whole, the female attire may be said in its common use to have been subjected to but little of decided change, except that in its general aspect it exhibited somewhat less of an Oriental character than it had done at the commencement of the century. The powerful influence exercised by the East through the crusades on the armor and military appointments of the warriors of the West, did not take effect till the next century in matters connected with Western female fashions and usages.

*Century XIII.*—As in the century next succeeding, in both the first and the second half of the 13th century, royal costume, which may be accepted as the most perfect example of the dress of the higher and wealthier classes, is happily exemplified with the highest contemporary authority. King John, upon whose monument (itself a work of the Tudor era) in Worcester Cathedral rests the earliest of the royal portrait effigies that are in existence in England, is attired in a loose tunic reaching from the throat almost to the ankles, having tight sleeves, and its color being golden. Over this is a loose full-sleeved crimson dalmatic, shorter than the tunic, bordered about the throat-opening and at the very wide extremities of the sleeves with richly gemmed gold embroidery, and secured about the waist by a buckled girdle having a long pendent end. The mantle, worn over all, which hangs down the back of the figure, is gathered up on the right arm in a manner long as well as very generally adopted by both sexes. The king, who has red hose with black boots and golden spurs, is crowned, a circlet of jewels which binds his hair appearing on his brow from beneath his crown. In his gloved hands, the gloves being gemmed, he holds his sword and what remains of his sceptre. Among notices of King John's costume, he is recorded to have appeared at a certain Christmas festival in a white damask tunic with a jewelled girdle and gloves, his mantle being of red satin embroidered with sapphires and pearls. Over a white under-tunic fastened with a circular brooch at the throat, Queen Isabel of Angoulême appears in her effigy habited in a long blue tunic covered with single golden crescents; this robe, which is loose and flowing throughout, has its full sleeves gathered in at the wrists, and it is adjusted about the waist by a rich girdle secured by a buckle. The queen wears a wimple and on her coverchef rests her crown; her mantle, which hangs from her shoulders and on her right side is drawn partly over her figure, is yellow covered with red roses and green leaves. Berengaria, the widow of Richard I., who died about 1235, is attired in the same fashion; but her tunic, of ampler proportions, is more gracefully disposed; her large brooch is elaborately enriched; from her gemmed girdle on her left side an amouillère, or purse, is suspended; her mantle, secured by a narrow cord across her breast, is not drawn forward; she wears no wimple, and her coverchef is so adjusted about her crowned head as to permit her wavy hair to be visible. The effigy of this royal widow displays no tokens of any such style or accessories of costume as might have reference to her condition of widowhood.

The crowned effigy of Henry III. (1272), a noble work, is remarkable for the classic grace and dignity of the adjustment of the ample mantle about the king's person, over his long tunic and dalmatic; this mantle is fastened by a large morse on the right shoulder. The king's boots, which are elaborately embroidered with small gold lions inclosed in losenge-work, are without spurs. During the long reign of this weak prince but few decided changes appear to have taken place to affect what gradually had settled down into becoming the national costume in England. New varieties, however, of rich and costly fabrics continued to be introduced, and they were eagerly adopted as materials for their dress by both sexes of the wealthier classes. Eleanor of Provence is represented clad in an embroidered mantle having an ermine collar, fastened, with a small brooch over a close-fitting and wide-skirted tunic of gold brocade, having its sleeves so cut as nearly to cover the hands. At this time furs of various kinds were greatly in request. The fashion, too, which had been introduced in the time of Rufus and was long prevalent, of cutting the borders of dresses into fantastic patterns became more general, and often was carried to excess. Sleeveless tunics, which would show the sleeves as well as the lower parts of the longer under-tunics, began to assume a recognized position in the female attire of the time; and, no longer braided in long tails, ladies' hair was arranged within network of gold or silver flagree or of silk, the wimple and coverchef, now constantly of very rich materials, being retained in use, and often so adjusted as to display the countenance in a triangular form after the manner of the mail coif of the knights. Of this fashion the effigy of Aveline, first countess of Lancaster, in Westminster Abbey, affords a truly characteristic illustration (fig. 25). At this same period the diapered patterns and rich

tissues of Ypres attained to a great celebrity, and heraldic devices began to appear as decorative accessories of dress. No effigy of the warlike Edward I. exists, to show him either in his mail, or in such attire as it pleased him to assume when not fully armed; but, doubtless, the fine effigy of Fair Rosamond's son, Earl William Longespée, in Salisbury Cathedral, may be ac-



FIG. 25.—Head-dress from Effigy of countess of Lancaster.

cepted as a sufficiently accurate illustration of the *military uniform* of the first Edward after the Conquest, who also may be assumed to have been attired, when his mail had been laid aside, much after the fashion of his father. It is well known that in his day princes and nobles arrayed themselves in flowing robes, worn over comparatively closely fitting tunics or doublets, these garments being made of silk damasks and satins of brilliant colors, with adornments of goldsmiths' work and furs, in the use of which they were freely followed by the knights and the wealthy classes as well as by the ladies of their era. Not content with the triangular adjustment of the wimple, towards the close of this century the ladies adopted the strange and unsightly gorget to cover their throats, thus still more closely adapting the aspect of their own head-gear and its accessories to the mail coifs and the helmets of their martial lords. The beautiful effigy of Eleanor of Castile, which rests upon a massive plate of bronze gilt and diapered with the armorial castles and lions of Castile and Leon, is remarkable as well for the dignified simplicity of the costume as for the sweet expression of the countenance. Secured by a narrow band which she holds in her left hand, the queen's long and ample mantle for the most part envelops her person, disclosing only the upper part of her wide-sleeved tunic and the close-fitting sleeves of the dress worn beneath it; she wears neither wimple nor coverchef, but allows her luxuriant hair to fall in rich waves from beneath her diadem upon her shoulders.

*Century XIV.*—The royal attire represented in the two halves of this century in the effigies of Edward II. and Edward III. is a tunic (the under-tunic not being visible) descending to the feet and having tight sleeves; a dalmatic, open in front to midway between the knees and the waist, of the same length; and a long flowing mantle, secured across the breast by a broad band of rich workmanship. The dalmatic of the father, who is crowned and in his ungloved hands holds a sceptre and an orb, has full sleeves reaching only to the elbows, but prolonged in broad lappets of moderate length, while that of the son has its sleeves tight and but little shorter than those of his tunic. In both cases the mantle, covering the shoulders but not drawn across the chest or covering any part of the front of the person, falls at the back of the wearer. The boots of Edward III., richly embroidered, are acutely pointed at the toes, but not of extravagant length; the aged monarch is bare-headed, with long flowing hair and beard; his two sceptres have been broken away. One of the crowned statuettes upon the monument of her younger son, John of Eltham, duke of Cornwall, apparently represents Isabelle of France, queen of Edward II., in a tunic and mantle, having her throat and head enveloped in a combination of a wimple with a gorget, after a fashion equally strange and unbecoming, but which, nevertheless, in her time was prevalent. This queen, who delighted in splendid extravagance, is recorded to have habitually worn, richly embroidered and adorned with jewels, dresses of cloth of gold or silver, with others of velvet of various colors and of shot taffeta, and with others also of green cloth of Douay and of rose satin. The inventories of wardrobes and jewelry that still exist show, in a significant manner peculiar to themselves, the extent, variety, and unbounded extravagance of the costumes of both sexes, with their costly accessories and ornaments. In strong contrast to the tales thus told, the costume of the effigy of Queen Philippa is simply a gown or tunic, quite tight to the figure and laced down the front; the sleeves tight, traversed from the shoulder onwards by a close-set row of small buttons, and prolonged from the wrists so as partly to cover the hands; and the skirt being very full and falling in rich folds over the feet. A narrow girdle encircles the royal person, adjusted, not as in earlier times somewhat tightly around the waist, but loosely and about the hips, precisely as the military belt had begun to be worn by the other sex. Over this tunic, the only other garment visible, a mantle falls from the shoulders down the back. The queen's hair, confined within a reticulated covering of goldsmiths' work beneath her diadem, is bound by a circlet and made to project prominently on each side of the face. At the close of the century, the effigies of Richard II. and Anne of Bohemia show the same costume to be repeated in the case of both royal personages, the whole being covered with the royal heraldic badges; and the queen's hair falls unconfined and

naturally over her shoulders. Other effigies of ladies of different ranks, notably a fine one of Lady Stapleton at Ingham in Norfolk, give similar examples of the costume worn by the two queens. Established in use early in the century, the display of heraldic insignia blazoned upon articles of dress rose into the highest favor and popularity during the brilliant reign of Edward III., and they also were lavishly adopted in the luxurious times of his grandson. Indeed, with the progress of this century, mediæval costume both attained to its highest splendor, and also exhibited much of its extreme extravagance. It became the fashion, for example, for both sexes to wear hanging from their sleeves long lappets, sometimes prolongations of the actual sleeves, and at other times mere strips, and their hoods were prolonged in points to correspond with them. Dresses, some very long, others very short, having their edges cut and jagged in a most bizarre manner, often were worn parti-colored, the colors in many cases having been chosen expressly with a view to produce the most vivid contrast; boots and shoes had their pointed toes made twice or even thrice the length of the wearer's foot; and head-gear, exhibiting no little



FIG. 26.—Part of Statue of Jean de Bourbon, from St. Denis, 1379.



FIG. 27.—From MS., 1430. (After Viollet-le-Duc.)

diversity of fantastic forms, was universally prevalent. The fashions of England corresponded with those of France, though apparently they were not carried here quite to the same excess that they were on the Continent. The singular aim of each sex, not only to emulate the other in the sumptuous style and profuse adornment of their dress, but also to imitate the form and fashion of each other's attire obtained in both countries. The consistent adjustment of the knightly surcoats and jupons over armor, enhancing its effect while partly covering it, suggested to the ladies to adopt kirtles or cotes-hardi, that from being merely sleeveless became sideless also. This form of garment, so well adapted for the display of what was worn under it, assumed several varieties of treatment. Sometimes, it was little more than the front and back of a jacket, as in fig. 26; and at other times it became a complete dress, with the exception of sides and sleeves, in which case it was either made to fit closely about the person both before and behind, and then was continued to form a loose and flowing skirt of ample proportions and great length, or with a similar skirt the upper part of the dress also hung loosely about the figure, as in fig. 27. In the next century this same dress at times was worn out off at the knees, so as to leave the lower part of the under-tunic visible as well as its sides and sleeves. This dress constantly was richly guarded and sometimes lined with costly furs, and it generally was also adorned down the front with a continuous series of massive studs or other goldsmiths' work. It appears also to have been a never-failing usage in connection with this fashion of a sideless kirtle to display the girdle of the under-tunic, which rested loosely on the hips, as it passed under the sideless garment both before and behind. Found to have been in use, in the form at first of a long and flowing sleeveless robe or gown, early in the 14th century, this sideless kirtle or cote-hardi continued to enjoy unabated favor for not much less than two centuries. It appears, certainly not later than 1320, in effigies at Bedale, Selby, and Staindrop—the Selby lady having the flowing skirt of her sideless dress blazoned with armorial insignia; in her effigy at Oxford, Lady Montacute is represented in this dress, 1354; and it is repeated

in the effigies of Lady Beauchamp, at Worcester, 1384; of Queen Joanna of Navarre, at Canterbury, 1407; of Lady Harcourt, at Stanton Harcourt, 1471; and of the Duchess of Suffolk, at Ewelme, 1474: the two ladies last named, whose husbands were K. G., wear the garter of the order, the former as an armlet and the latter as a bracelet. Still later, 1500, in her beautiful effigy in Westminster Abbey, Elizabeth Arundel, wife of Sir Giles Daubeney, K. G., treasurer to Henry VII., is represented in this same sideless over-tunic which reaches only about to the knees, so displaying the lower part of the long and flowing under-tunic as well as its sides and sleeves. M. Viollet-le-Duc has shown the sideless kirtle to have been no less fashionable and no less capable to maintain its position in France, than we possess abundant evidence to prove it to have been in England. The same fashion also prevailed at the same period in other parts of Europe. At Worcester a closely wimpled effigy illustrates in a remarkable manner the usage, at the commencement of the century, to attach small enamelled shields of arms in profusion upon the dresses of ladies of rank, a mode of decoration shown again in a brass at Troton, 1310. Throughout this century the wimple and coverchef continued to be worn, or the hair was confined within bands of fretwork, or had some light and delicate covering which did not extend to the face and throat. In the second half of the century the hair appears to have been worn partly within the favorite fretwork, and in part falling on the shoulders; the coverchef also then assumed the forms of a variety of caps, and some of the more extravagant head-dresses of the following century began to make their appearance. For protection from the cold and wet the hoods of mantles always were available, and hats wide in the brim were also worn. The hip-belt was universal. Pockets, into which the hands of the wearers often are represented to have been inserted, are shown to have been made in the outer-tunics and robes. Throughout the era of splendid armor, men of distinction so constantly are represented in their armor that the typical and specially characteristic male costume of the Middle Ages is commonly considered to have been identified with what in reality ought to be distinguished as the military equipment of the period. Rarely, however, as we see the more accessible and popular of their "counterfeit presentments" in peaceful guise, the warriors of those days when circumstances



FIG. 28.—(c. 1330 A. D.)

permitted gladly laid aside basinet and hauberk and panoply of plate, in order to assume some less weighty and uneasy garb. Under the armor close-fitting doublets and hose were worn, made either of leather or of some quilted fabric. When without their armor, the dress of nobles and knights in many respects was assimilated to the garments assumed by them over their armor. The general costume of men of all classes at the same period was closely in accord with the style prevalent with their contemporaries of exalted rank, the essential distinctions of different classes being comparative costliness and splendor of adornment. It will be observed that garments fitting closely to the person were in constant use, as is well exemplified in fig. 28, and also such others as were Oriental in their length and flowing looseness. Early in the 14th century two or three surcoats were worn over the armor; but later the short jupon, generally jagged at the edges and sleeveless, but sometimes plain and having sleeves reaching only to the elbows, superseded them, when a similar jupon made of some rich material and often having a hood, was adopted to be worn with a hip-belt, without the armor. The hip-belt, as was the case with the other sex who borrowed it from the men, was universal.

The hose, shoes, boots or buskins, always sharply pointed, became very long as the century advanced. Rows of buttons, also, some of them very small and closely set, were in great favor. Heraldic devices, assumed as military insignia, became the favorite ornaments of the dress of peace. The military camail, again, the representative of the mail-coif of earlier times, found a parallel in the hood when resting on the shoulders, and in the cape which so frequently was associated with the peaceful attire of this century. See fig. 28, which also gives a characteristic illustration of the prolonged sleeve-lappets that still held their ground with resolute tenacity. Six of the original beautiful bronze statuettes, representing two of the daughters and four of the sons of Edward III., which still remain *in situ* on the south side of that monarch's monument in Westminster Abbey, form a group so happily illustrative of both male and female costume in the second half of the 14th century before it had degenerated into the extravagances of the reign of Richard II., that it has appeared desirable here to introduce the accompanying sketches of the entire group (figs. 29-34). One of these statuettes (fig. 29) is especially interesting, since it



is a contemporary portrait of the Black Prince when he was not armed, which consequently may be agreeably associated with his noble armed effigy upon his own monument at Canterbury. The doublet and hose, doubtless worn by the Black Prince under his voluminous mantle with its deeply jagged lower border, is effectively shown in the statuettes of two of his brothers, Lionel, duke of Clarence (fig. 30), who also wears his mantle; and a younger brother (fig. 31), not now to be identified in consequence of his shield of arms having long been lost. The effigy of the fourth brother (fig. 32), enveloped like the

we learn from contemporary illuminations—by the pervading love of lavish extravagance in dress in all classes, and by the excess to which the more fanciful devices and fashions of earlier times were carried. Thus, the jagged borders of tunics and mantles became more than ever fantastic; the tunics and mantles themselves attained to a larger size, and the hanging sleeves commonly attached to them drooped to the very ground. Hoods, from being merely pointed, were prolonged in pipe-like extensions ("lirripipes"), and the points of boots and shoes were made sharper, and the boots and shoes were made longer



Fig. 29.—The Black Prince.



Fig. 30.—Lionel, duke of Clarence.

Black Prince in his mantle, has also lost the armorial shield which would have declared his name and title. With the costume of these royal brothers may be compared the habit of a civilian, who lived at the same time with them, as it is shown in his monumental brass at Shottesbroke (fig. 35). The corresponding French costume of a few years earlier, which continued in fashion till the close of the century, is well exemplified in figs. 28 and 36. The effigies of the two royal sisters (figs. 33, 34) speak for themselves as expressive and authoritative typical illustrations of the female dress of their era in its simplest and

than ever. The singularly quaint and bizarre usage of making dresses parti-colored, the colors being selected in the majority of instances with a view to decided contrast, derived doubtless from heraldic impalements and quarterings with fields of different tinctures, and carried out in the livery colors assumed by the retainers and dependants of great houses,—a fashion which had established itself during the palmy heraldic days of Edward III.,—became general in the reign of Richard II., and then it was carried out in every variety of the details, accessories, and ornaments of costume.



Fig. 33.—Daughter of Edward III.



Fig. 34.—Daughter of Edward III.



Fig. 31.—Son of Edward III.



Fig. 32.—Son of Edward III.

most characteristic forms, as the entire group in which they appear attests the dignified simplicity which the artists of the Middle Ages, with such excellent taste, have shown that they held to be appropriate for the costume, in itself always accurate and historically true, to be represented in monumental sculpture. Without introducing much of actual novelty, except in the case of some of the head-dresses which from this time continued in use under the fourth, fifth, and sixth Henries, the concluding quarter of the 14th century was distinguished—as



Fig. 35.—Civilian, c. 1375.



Fig. 36.—Lancelot du Lac, c. 1360. From Viollet-le-Duc.

Century XV.—Remarkable for a sustained succession of important changes in armor, and also from the fact that after about 1405, and until about 1475, the panoply of steel was worn uncovered by any surcoat or jupon, this turbulent century also witnessed a variety of changes in costume—changes that maintained a general uniformity throughout the greater part of Europe—which in their turn led in the succeeding century to the equally general establishment of the Tudor fashions. Heraldic

devices continued to constitute favorite accessories and ornaments of dress, and in no slight degree determined both its character and its aspect. To the crests of the knightly helms, and to the coiffures or scarves and the mantlings displayed from them by the knights, may be assigned, as being the sources whence they were suggested, the more extravagant and quaint varieties of the female head-gear, which prevailed at this period. And, in like manner, the "livery colors" of the nobles and other personages of distinction, introduced during the preceding century, together with their armorial badges, all of them worn by their partisans, adherents, and dependants, imparted a heraldic character to the costume of the middle and even of the humbler classes. The only royal monumental effigies of this century are those of Henry IV. and of his second wife, Joanna of Navarre, at Canterbury. The king's dalmatic, of ample proportions and ungiirt by any girdle, falls to his feet, completely covering his tunic, except at the wrists of its tight sleeves, which have an under row of small buttons set in contact; over these sleeves are the large and open sleeves of the dalmatic itself, which is remarkable from having at each side a very large opening to give access to the pockets of the tunic. About the shoulders and covering the chest is a cape or tippet; and, over all, there is a mantle, its hood adjusted about the neck of the wearer, which is secured by a broad and rich band, with moreses, cords, and tassels. Upon his head the first Lancastrian king wears a crown of elaborate splendor. The effigy of Queen Joanna, from which, as also is the case with the companion effigy of her royal husband, the hands and the greater part of the arms have been broken away, represents her attired in a close-fitting tunic with a narrow very rich hip-girdle, under a long sleeveless and sideless cote-hardi, cut low and fitting tightly in the body, but having a loose, long and flowing skirt, and adorned with a row of rich circular studs down the front. The mantle, which falls over the back of the figure and is not gathered up at the arms, is secured by a cordon attached to two losenge-shaped studs. As a necklace the queen wears the Lancastrian collar of SS; and her hair, which is plaited in bands within golden network, is surmounted by a truly beautiful crown. Thus the costume of this royal lady shows no change from the ruling fashion of the previous century. At this same time female dresses were worn made full, and either gathered into a kind of close collar about the throat, or having a broad collar falling over the shoulders, their sleeves very large and full and sometimes quite open, while at other times they also were gathered in (but not closely) at the wrists; these dresses, often having a row of small buttons from the throat downwards, were so adjusted by a belt as to have very short waists. At this period also, and till the middle of the century, the tunic commonly worn by men, with the exception of being shorter, in form was almost identical with the full-sleeved kirtle also in common use by the other sex. Among characteristic examples of the ordinary costumes of the first half of the 15th century are effigies, some sculptured and some engraved, at Chipping Campden, Willoughby, Northleach, Kingston-on-Thames, Great Tew, Higham Ferrers, and Bedington. In the third quarter of the century the male dress in general use underwent but little change, the very long tunics of earlier times still remaining in favor; but the female kirtles are seldom seen with very full sleeves, the sleeves of the under-tunic being continued in the form of mittens so as partly to cover the hands, the outer sleeves ending in cuffs that are turned back. While the costume of the commonly thus was at any rate comparatively simple and sober, throughout the turbulent period that succeeded the death of Henry V. till the establishment of the Tudors, it would appear as if the fierce excitement and the terrible vicissitudes of a prolonged civil war had impelled the nobility and others of the upper classes in England—encouraged in such a course, as it would seem, and still further stimulated to pursue it by the contemporaneous fashions of France—to have sought a not altogether inconsistent kind of relief in both the revival and the invention of almost every conceivable extravagance and absurdity in dress and personal ornament. Long and loose robes having immense drooping sleeves had as their contemporaries close-fitting tunics reaching down not quite to the knees, with others of looser make which descended midway between the knee and the ankle, and also with jerkins cut short only a few inches below the hips, made very full and gathered in with a belt about the waist. Of these tunics and jerkins the sleeves assumed an endless variety of form and decoration, being sometimes made to fit tightly, but more generally being large and open, and at their extremities either jagged or bordered with fur. These large sleeves enabled the wearers to display the sleeves of their under-garments, and in so doing to emulate the ladies with their sideless cote-hardis and kirtles. Mantles of the richest materials and splendidly adorned, which were made to reach about to the knees, were worn as parts of the regular dress. The half-boots or shoes distinguished as *poulaines* continued to be long and very sharply pointed; and men of rank and fashion actually walked about in clogs, pointed like their poulaines, and exceeding them in length by several inches. The excesses in attire characteristic of this period culminated (in every acceptation of that word) in the

female head-dresses, that appear literally to have exhausted the inventive faculties both of the ladies themselves and of those persons who ministered to their tastes and wishes. From their more decidedly characteristic features, some of the more popular of these strange varieties of head-gear have been distinguished as the "horned," the "mitre," the "steeple"—in France known as the "hennin,"—and the "butterfly" (figs. 37–40). Examples of all these head-dresses in their various modifications of contour, size, accessories, adornment, and adjustment, abound in the monuments and illuminated MSS. of both France and



FIG. 37.—"Horned"  
Head-dress, c. 1475.



FIG. 38.—"Mitre"  
Head-dress, c. 1475.

England; also, as in the general character of the costume of each era, the same fashions of head-gear are found to have prevailed about the same period in other European countries. The most remarkable example of the "horned" head-dress that has been observed either in France or England, is represented in the effigy of Beatrice of Portugal, who married one of the earls of Arundel in the time of Henry V., which remains in good preservation in Arundel church in Sussex; fig. 37, from the brass to Lady Halsham in the same county, shows a simpler and more moderate form of the same head-dress. Fig. 38 is drawn from a portrait of Elizabeth of York when young, in stained glass at Little Malvern. The "hennin," fig. 39, is a French example, reproduced from the always effective pages of Viollet-le-Duc. The "butterfly," shown in fig. 40, is another example in which the type of a particular head-gear is exhibited with no less of moderation than of accuracy. In every case, to these head-dresses veils, generally of ample proportions and often of great length or depth, and always of some light and



FIG. 39.—"Steeple" Head-dress  
("Hennin"). From Viollet-  
le-Duc.



FIG. 40.—"Butterfly"  
Head-dress.

delicate material, were attached, and from the actual structure worn in connection with the hair upon the head they either were expanded by wires or were permitted to fall drooping freely. Extravagances in head-gear, however, were not restricted to the fashions of one sex only; on the contrary, at this same period, among other strange eccentricities and fancies, a kind of cap, in form somewhat resembling a turban, was introduced and generally worn by men, which on one side had attached to it a cluster of very large bows or puffs (the prototype of the "cockade" of later times), while on the other side a broad band or scarf of the same material as the cluster of bows hung down to the ground, or even trailed along upon it, unless it should be the pleasure of the wearer to tuck it up in his girdle, or to wind it round either his head or his throat and shoulders. This strange male head-gear, of which a French example is given in fig. 41, showing the upper part of the scarf when hanging down, often was treated as a hood for occasional use only, when it rested on one of the shoulders of the wearer, its cluster of bows drooping

over his back, and the long band or lappet pendent in front of his person, his head, meanwhile, if not bare, being covered with a cap, round or square or peaked, or by a brimless hat adorned with an upright feather and a jewel. In the 13th and 14th centuries the knightly surcoats and jupons, worn over armor, had their counterparts in the robes and tunics of peaceful attire; and so, in like manner, the shortened tunics and still shorter jerkins, that were in common use when the 15th century was bringing the great civil struggle to its termination in the accession of the Tudors, may be considered to have been suggested by the short "tabard" with its short and full sleeves and its heraldic blazonry, at that time worn by men-at-arms over their plate-armor. At the same time and till the end of the century, the long tunics still in use, which some years earlier had been slit up in front and had their full sleeves somewhat gathered in at the wrists, were made still longer, and had collars either close-fitting or open and falling back; they also were made open in front throughout their entire length, and their loose sleeves were of a uniform size from the shoulder to the wrist. At this same time also rosaries, and gypsoires or purses, were worn attached to their girdles by both sexes. About the year 1480 the long and acutely pointed poulnes were superseded by coverings for the feet of both sexes which exhibited the opposite extreme of being short, very broad, and rounded or sometimes almost square at the toes. In the concluding quarter of this century, the super-tunic or gown of the ladies, made to fit closely and having a long and flowing skirt, the sleeves also close-fitting and with cuffs either turned back or drawn over the hands, was open above the short waist, the collar falling back over the shoulders and showing the under-tunic either carried up to fit closely at the throat, or sometimes out square and low. Rich and broad necklaces were worn, and belts of goldsmiths' work with long pendants. The "horned" head-dress became either sharper in its points, or considerably less pointed and more graceful. The "butterfly" head-dress increased in favor, and was worn with the hair drawn back into an enriched caul or cap. About 1490 an angular or "diamond" head-dress superseded the "butterfly;" it had a ridge, after the manner of a gabled roof of a house, over the head, and forming an angle above the centre of the forehead, from which it descended with a slope on each side of the face; then, another angle having been formed slightly below each eye, this head-gear, which inclosed the back of the head in a species of cap, was continued as a broad lappet falling over each shoulder in front of the person of the wearer; occasionally, also, two other similar lappets depended behind (see fig. 42).

*Early Painted Glass.*—Upon the costume, always without doubt in a signal degree characteristic of the period in which it was executed, of the various figures introduced by mediæval artists into their numerous pictures executed in glass, Winston has made the following concise remarks:—  
*Early English Gothic, 1175 to 1300.*—"Robes, whether lay or ecclesiastical, are generally short, in male figures hardly reaching to the ankles, and in females scarcely more than touching the ground. The female dress usually consists of a close garment with tight sleeves and a loose robe and shoes; the head is sometimes bare, but more commonly draped. The male dress, usually appropriated to dignified persons, also consists of a close garment confined at the waist, and furnished sometimes with tight and sometimes with loose sleeves, a robe or mantle, and long hose, to which is often added a cap greatly resembling the Phrygian bonnet. The costume of ordinary persons is generally a short tunic, confined at the waist and reaching nearly to the knees, and sometimes a short cloak; when this is used, the legs of the figure are generally represented encoased in hose, or in a loose sort of stocking setting in folds about the leg, and with or without shoes."

*Decorated English Gothic, 1300 to 1380.*—"The draperies of this period are much more flowing and ample than those of the last; and in ecclesiastical and female figures the robe is generally long and envelops the feet. The secular female costume usually consists of a garment tightly fitting to the arms and body, and having a wide long skirt trailing along the ground; upon it sometimes are depicted the armorial bearings of the wearer. A cloak or mantle is often loosely thrown over it. The wimple is a frequent adjunct to the head-dress, and the hair is usually plaited down on each side of the face and inclosed in a net or eowl. The ordinary costume of dignified laymen consists of a long robe and loose cloak,—the hair and beard being arranged

in loose and wavy locks. The usual secular dress is a short jerkin or tunic reaching about half-way down the thighs, and tight hose and shoes, upon which model the armor of this period was formed."

*Perpendicular English Gothic, 1380 to about 1550.*—"Greater repose was given to the figures in this than in either of the former styles, and the draperies are generally disposed in very broad and grand folds. The female dress in general consists either of a close-bodied dress with long skirts and tight sleeves, or of a looser dress with sleeves wide at the shoulders and tight at the wrists. A cloak is often added, upon which armorial bearings, when used, are emblazoned more frequently than on the other garment. The variety of the head-dresses is great, especially towards and during the reign of Edward IV. The secular male costume, until almost the end of Edward IV.'s reign, appears usually to have consisted of a furred gown of tunic-like form, reaching rather below the knees, slit nearly half-way up the middle, and confined round the waist with a girdle; it had either wide sleeves narrowing toward the wrist, or small at the shoulder and wide at the wrist like those of a surplice. The legs were enclosed in pointed-toed hose. The hair, until the latter part of the reign of Edward IV., appears to have been cropped closely all round, and after this time to have been cut straight across the forehead, but allowed to grow long behind and at the sides of the face, and to have been smoothed down like a club. In the reign of Henry VII. long furred gowns reaching to the feet and obtusely-toed shoes were used; they continued in fashion during the next reign also."

*Century XVI.*—"We find," says M. Paul Lacroix, writing specially with reference to the costume prevalent in France, "that a distinct separation between ancient and modern dress took place as early as the 16th century. In fact, our present fashions may be said to have taken their origin from about that time. It was during this century that men adopted clothes closely fitting to the body,—overcoats with tight sleeves, felt hats with more or less wide brims, and closed boots and shoes. The women also wore their dresses closely fitting to the figure, with tight sleeves, low crowned hats, and richly trimmed petticoats. These garments, which differ altogether from those of antiquity, constitute, as it were, the common type from which have arisen the endless varieties of modern male and female dress; and there is no doubt that fashion thus will continually be moving backwards and forwards from period to period, sometimes returning to its original model, and sometimes departing from it." Before arriving, however, at the useful and generally consistent and becoming dress of the present day, the fashions of both male and female attire had to pass on from the 16th century through a series of changes in every respect no less strange and extravagant, and yet always more or less directly tending in the same direction, than those which the earlier centuries had witnessed, and then had carried away with themselves. And even now more than a little remains to be accomplished, before the ordinary costume in general use can be considered to have realized what ought to be its true aim—the most perfect attainable applicability, that is, to the condition and the requirements of the wearer, due but not excessive attention at the same time being bestowed upon appropriate effectiveness of appearance.

At the commencement of this century in England, there are the royal effigies of Henry VII. and his queen, Elizabeth of York. The king himself is represented as having his person entirely enveloped in a loose fur-lined robe or gown of ample size, reaching from its close fur collar about his neck to his feet, and so adjusted as to disclose but little of the garments worn beneath it. On his head he has the square cap that came into use and was generally worn during his reign. The queen wears a richly adorned angular head-dress (fig. 42), from beneath which her hair falls unconfined over her shoulders; and the adjustment of her royal mantle is such as to display the upper part of her tunic, which is cut square and does not quite reach to her throat. The countess of Richmond, the mother of Henry VII., in her effigy appears wrapped from head to foot in a loose mantle, her tunic having plain and tight sleeves; and on her head she has a plain angular head-dress with a plaited wimple, over which the lappets fall. This costume may be regarded to have been designed to denote the widowhood of this four times married lady. Thus it appears that in their costume the effigies of these royal personages exhibit none of the distinctive insignia of royalty, and conse-



FIG. 41.—Head-dress with Scarf.



FIG. 42.—Angular Head-dress.

Elizabeth, Queen of Henry VII.

quently they may be accepted as typical of the costume of their era. Neither of Henry VIII. nor of any one of his queens is there any monumental effigy; but this deficiency is more than compensated by the portraits painted by Holbein, made familiar to all by engravings; while other artists have left no less characteristic pictures representing personages of different ranks and classes who at the same period lived in France and England. Armor, which in the course of this century gradually became less esteemed for purposes of defence, and in a corresponding degree came to be more and more regarded as but little more than a splendid component or accessory of dress, in its form and aspect was closely assimilated to certain garments made of textile materials and in fashion among the armor-wearing classes. Much of curious and suggestive mutual illustration, accordingly, is to be obtained by a comparison between the aspect of a man of rank of this century in his armor, and the same person when in his customary attire. In the time of the first of the Tudor princes men wore two distinct varieties of dress. The one was a long and loose gown, having wide open sleeves, girt about the waist with a belt or scarf, above which it was open, its broad collar falling back over the shoulders; thus an under-tunic or vest was displayed, that in its turn allowed the shirt to be visible both at the throat and the wrists; the hose were tight, and the shoes very broad at the toes. The other form of dress consisted of a short tunic or vest, tight and close-fitting as the hose, worn under an open doublet with long sleeves made throughout very large and loose; hats, low in the crown and broad in the brim and having plumes of feathers, were either worn on the head over a small and closely-fitting cap or coif, or they were carried hanging from over one of the shoulders down the back. The angular cap represented in the royal effigy also was constantly worn, and the cap (fig. 41) with a cluster of bows and the long pendent sash continued in use. Under Henry VIII., in men's attire, from midway between the knee and the hip, or from the knee itself, downwards to the wide and easy shoes, all was tight, while about the upper part of the lower limbs and the body all was loose, spacious, and broad, the entire costume at the same time being distinguished by decided stiffness and formality. At the line of junction between the tight and the loose portions of the dress, the trunk hose, at the time in question universally worn, were gathered in closely either at the middle of the thigh or at the knee, and then they were widely puffed out as they rose to meet the jerkin or jacket, which was open in front and reached only to the hips. These jerkins sometimes were closed at the throat, when a small falling white collar or band was worn; or the jerkin was spread open to display a sleeveless vest, and an embroidered shirt having large sleeves and small ruffles at the wrists. The doublets, or coats, worn over the other garments were very short and very full, an especial object being to give to the figure, and particularly about the shoulders, the appearance of as much breadth and squareness as possible. A cloak, as short as the doublet, was suspended from the shoulders, rather for display than for use; the head-covering was a round cap, low and flat, adorned with a jewel and a single small waving feather; and, attached to the belt, with a gyprière or purse, a dagger was carried horizontally in front of the wearer. The sword, when worn, was a rapier. It was at this period a peculiar and universally prevalent fashion, varying in degrees of eccentricity and extravagance, to slash the garments, so as either simply to show glimpses of some under-dress, or to have some different material of another color drawn out in puffs through the slashes. This slashing and puffing was extended even to the broad shoes, the tight hose alone being exempted. Besides being frequently slashed and striped, the trunk hose were habitually made with a succession of alternate gatherings-in and puffings-out. All this display, made regardless of true taste and solely in order to accomplish as much of display as possible, naturally was attended with a prevalent indulgence in the use of rich and costly fabrics and splendid decorations. Of King Henry himself it is recorded, at his famous meeting with Francis I. in 1540, that he was apparelled in "a garment of cloth-of-silver damask, ribbed with cloth-of-gold, as thick as might be; the garment was large and plaited very thick, of such shape and make as was marvellous to behold." The French king was attired in a splendor quite equal to that of his royal English guest; and the nobles and courtiers of both countries took care to emulate their sovereigns in their attire, and in wearing several gorgeous costumes, all of them in the same style of fashion, every day. The costume of Henry II. of France, represented in the woodcut, fig. 43, from the original portrait by Clouet, is a characteristic example of the fashion prevalent in the middle of the 16th century, and it also shows how close was the resemblance between the fashions of male dress at that time in France and England. The costume of the middle and the humbler classes at this era, as naturally would be expected, bore a decided general resemblance to the more elaborate and costly attire of the dignified and wealthy of their contemporaries. They wore the same short close jerkin, the short doublet often with lappet sleeves, the short cloak, the flat round cap plainly made

from simple materials, and the tight leggings and broad shoes with the puffed upper hose. Or, instead of the short cloak, they wore a long gown; furred, and with hanging sleeves, sometimes pierced



FIG. 43.—Henry II. of France.

midway for the arms to pass through; a coif tied under the chin also was commonly worn under the flat cap. The doublets of the men of the Elizabethan portion of this century, which were made long-breasted and padded so as to fit the body tightly, were carried down in front to a prolonged peak, and so they closely resembled both the stomachers of the ladies and the breast-plates of the military. The fashion of these grotesque doublets, apparently originally Venetian, travelled to England by way of France. The hose, if of the English "trunk" type, were puffed out immediately from the middle of the thigh, where they met the tight leggings or stockings that were carried up beneath them, as in fig. 44; but the French and Venetian hose, also in fashion in England, swelled out gradually from the knee, and the stockings sometimes were drawn over them. These dresses constantly were puffed and slashed, padded and banded throughout, one long slash being carried down the entire length of each sleeve of the doublet. The contemporary portrait of the French king, Henry III., about 1575, from which the woodcut (fig. 45) has been drawn, shows very distinctly the tapering French hose and the long peaked doublet, with the treatment of those garments characteristic of that period. Very large circular ruffs, in their form and adjustment differing little, if at all, from those worn by the other sex, formed essential features of the male attire in the reign of Elizabeth, when very short cloaks also continued to be worn. At the same period, long gowns guarded with fur, having open collars falling back, and their sleeves comparatively tight and having puffs at the shoulders, were in common use, as were caps and hats greatly varying in form, color, material, and adornment. It must be added, that amidst all this extravagance and eccentricity of attire, there



FIG. 44.—English Trunk-hose, c. 1550.



FIG. 45.—From Portrait of Henry III. of France, 1576.

also existed a taste for simplifying the fashions of the time so as to render them at least comparatively graceful and becoming. In connection also with the costume of the 16th century, it will be kept in remembrance, as one of the most decided innovations ever introduced into male dress, that two distinct coverings were given to the lower limbs when the hose were worn in part tight and plain, and partly puffed out, slashed, and embroidered. The term "hose" then was applied, by way of distinction, to the upper portion, while to the lower the name of "stocking" was assigned. Towards the close of the century the hose of that period also became "breeches;" and so, in process of time, the old and long-used word "hose" came to be retained only as an equivalent for "stockings." Early in the 16th century noble ladies and gentlewomen introduced various modifications of the universal angular head-dress. Their dresses, fitting closely about the figure, and with long skirts open in front to display the under-dress, were made low and cut square about the neck; their sleeves, tight at the shoulder,

suddenly became very large and open, disclosing the puffed sleeves of the under-dress; sometimes, however, these dresses were worn high, with short waists, and a small falling collar. Necklaces and numerous other ornaments of jewelry were in general use; chains also, with objects of various kinds for use or ornament attached to them, hung down from the universal girdles, or the girdles themselves had one long pendent end that was elaborately enriched. By country ladies and by the wives and daughters of citizens a similar style of dress, somewhat simplified, was generally adopted. Somewhat later, the sleeves of dresses had puffs at the shoulders, and when the dresses were made open above the girdle, a "partlet," or kind of habit-shirt, was worn beneath them and carried up to the throat; the head-dress at the same time, while generally retaining an angular contour, was small and made to fit almost closely to the head. At this same time, the general resemblance which all along may be traced between the dresses of the two sexes became universally decided. After the accession of Queen Elizabeth in 1558, the well-known costume, associated with herself from about the middle till the close of her reign, gradually became established. Of the long, peaked, and tight stomachers of the ladies, and of the padded and quilted doublets of the men, it might be said with equal truth that each garment was a parody of the other. Ruffs, often of exaggerated amplitude and of a painfully severe stiffness, were worn by both sexes; sometimes open in front and rising like an expanded fan around the throat and head, more generally they completely encircled the throat, and rested, nearly at right angles to it, on the shoulders. In their puffings and slashings the sleeves of the dresses of both sexes were alike; nor was almost a corresponding resemblance wanting between the trunk hose and the "petticoat-breeches" of one sex, and the skirts of the kirtles and gowns and the veritable petticoats that were made to expand by enormous wheel-like "farthingales," as in fig. 46, from the hips of



FIG. 46.—Farthingale.

the other sex. Ornaments of every kind abounded. The richest and most showy fabrics in endless variety were in great request, and were worn with abundance of lace, feathers, and embroidery. The monumental effigy of Elizabeth herself, the last memorial of its class commemorative of an English sovereign, represents the queen as attired at all points in the characteristic fashion, by herself set to her time, and identified with her name; and the sister effigy of Queen Mary Stuart, like that of Elizabeth, the work of James I. and in Westminster Abbey, gives another, but a somewhat simpler and a much more graceful, example of the same costume—the queen of Scots wearing the cap that bears her name. As at other periods, the general female costume in the Elizabethan era was a modification of the dress of the court, the circumstance and position of different classes and individuals determining the degree of resemblance.

In taking a retrospective glance at the numerous changes in costume which had taken place from ancient times to the 16th century, M. Lacroix remarks that "among European nations during the Middle Ages we find there to have been but one common standard of fashion, which varied from time to time according to the particular customs of each country, and in accordance also with the peculiarities of each race. In Italy, for example, dress always maintained a certain character of grandeur, ever recalling the fact that the influence of antiquity had not been altogether lost. In Germany and Switzerland garments generally had a heavy and massive appearance, and in Holland still more so. England uniformly studied a kind of instinctive elegance and propriety. It is a curious fact that Spain invariably partook of the heaviness peculiar to Germany, either because the Gothic element still prevailed there, or that the Wallon fashions had an especial attraction to her, owing to associations and general usage. France was then, as she is now, fickle and capricious, fantastical and wavering, not indeed from indifference, but because she always was ready to borrow from every quarter anything that pleased her. She, however, never failed to place her own stamp upon whatever she adopted, so making any fashion essentially French, even though she had only just borrowed it from Spain, England, Germany, or Italy. In all these countries we have seen, and still see, entire provinces adhering to some ancient custom, causing them to differ altogether in character from the rest of the nation. This is simply owing to the fact of the fashions having become obsolete in the neighboring places; for every local costume faithfully and rigorously preserved in any community at a distance from the centre of political action or government, must originally have been brought there by the nobles of the country. Thus, the head-dress of Anne of Brittany (1498–1514) is still

that of the peasant-women of Penhoet and Labrevaok; and the tall conical 'hennin' (fig. 39) of Isabel of Bavaria (1400) is still the head-dress of Normandy." With the view "briefly to indicate the last connecting link between modern fashions and those of former periods," the same writer proceeds to point out how, "under Francis I. (1515–1547), the costumes adopted from Italy became almost stationary. Under Henry II. (1547–1559), and especially after the death of that prince, the taste for frivolities made immense progress, and the style of dress in ordinary use seemed day by day to lose the few traces of dignity which it previously had possessed. The fashion of ruffs had been introduced into France by Catherine de' Medici (1560); and at the beginning of the 17th century that of small collars. Dresses, tight at the waist, began to be made very full round the hips by means of large padded rolls; and these were still more enlarged by a monstrous arrangement of padded whalebone and steel, which subsequently became the ridiculous 'paniers' that were worn almost down to the present century. Under the last of the Valois (1500) men's dress was short, the jacket or jerkin was pointed and trimmed round with small peaks; the velvet cap was trimmed with aigrettes; the beard was pointed; a pearl hung from the left ear; and a small cloak or mantle, which reached only to the waist, was carried on the shoulder. The use of gloves made of scented leather became universal. Ladies wore their dresses long, very full, and of costly materials, little or no change in these respects having taken place during the reign of Henry IV. (1589–1610). At this period the men's high hose were made longer and fuller, especially in Spain and the Low Countries, and the fashion of large soft boots, made of doeskin or of black morocco, became universal. For a long time, even in the towns, the costume of the bourgeois was almost unchanged. Never having adopted either the tight-fitting hose or the balloon breeches, they wore an easy jerkin, a large cloak, and a felt hat, which the English made conical and with a broad brim. Towards the beginning of the 17th century, the high hose, which were worn by the northern nations profusely trimmed, were transformed into the 'culottes,' which were full and open at the knees. A division thus was suddenly made between the lower and the upper parts of the hose, as if the garment which covered the lower limbs had been cut in two, and then garters were necessarily adopted. Almost throughout Europe, the felt hat became a cap taking the exact form of the head, and having a wide and flat brim turned up on one side. To boots and shoes high heels were added, in place of those which before had been flat and had been accompanied with single soles. Two centuries later a terrible social agitation took place in Europe, after which male attire became plain, ungraceful, mean, and more paltry than ever; whereas female dress, the fashions of which were perpetually changing, became graceful and elegant, though often approaching the extravagant and absurd."

*Century XVII.*—During the reign of the first Stuart sovereign of Great Britain the fashions of dress, which under his Tudor predecessor had culminated without undergoing any changes sufficiently marked to give to them a fresh character, attained to even an exaggerated extravagance. Notwithstanding the absence of any effigy of him, we are familiar with the personal appearance and costume of James I. and VI., and in his costume we possess a true type of the dress prevalent during his reign. The long-waisted, peaked, and close-fitting slashed doublets of the days of Elizabeth, still longer in the waist, more acutely peaked, and as far as was possible more closely fitting than ever, habitually were kept in shape by means of stays worn under them. The trunk hose, mercilessly slashed, became larger than before, padded garments being specially congenial to the disposition and temperament of the king; and, having attained to a balloon shape, they tapered down to the knees of the wearer, where they were secured by sashes tied in bows at the side. Cloaks and ruffs remained unchanged. Hats came into fashion that were tall in the crown, slightly conical in shape, with a narrow brim turned up on one side, and adorned with a jewel and a single feather, or with a rich band and a plume. Large rosettes were worn on the shoes, which retained their broad shape, and often had high red heels. Rapiers, worn without any belt crossing the person, were narrow and very long in the blade. In like manner, the female dresses underwent but little change, except in having their worst features and especially their farthingales, with the lavish profusion of their tasteless adornment, intensified. It was at this time, however, that the custom of painting the face began to prevail; and while ruffs or bands of immoderate size stretched forth from the ladies' necks, they wore the front of their dresses cut away immediately beneath them in a manner that exposed the bosom in defiance of all modesty. Lees fashionable ladies, between 1615 and 1625, discarded the tight and pointed stomacher and farthingale, and wore, over an easy jerkin and ample petticoat, a loose gown open in front, made high to meet the ruff, and with long hanging sleeves through which the tight sleeves of the jerkin were displayed; or they followed the fashion of their time, modified and without its more salient absurdities. The same may be said of the men, who were content in some degree to follow the fashion, while altogether repudiating being leaders of it. With the costume

of the reign of Charles I., on the whole more sober, and in more than a few respects really elegant, Vandyck has made the world happily familiar. At first the ruffs were retained, their size only having been diminished; but all traces both of the angular head-dress and of the Mary Stuart cap, and with them of the farthingale, disappeared; and after a while the ruffs followed them. The ladies wore the very full sleeves of their dresses tied in at the elbows as well as gathered in at the wrists; their bodies, tightly fitting, sometimes were long and pointed, and at other times not longer than the natural waist; the long petticoat of some rich material was displayed beneath a loose and open robe or gown, that was gathered up and had short loose sleeves with deep white cuffs, and a deep falling collar or "band" was fastened closely at their throat; or they wore large kerchiefs over their bodies, and gowns having flowing skirts and comparatively tight sleeves. Coverhefs or hoods also were worn, from which descended long veils, often of such ample proportions as to resemble mantles. Patches at this time began to make their appearance; and notwithstanding their intrinsic absurdity and their strange faculty for disfigurement, they continued in fashion throughout the century. Men's doublets or coats, the true prototypes of the frock-coats of the present day, having full sleeves made tight at the wrists, were rather longer and worn buttoned from the waist (where they showed the shirt) upwards to the falling white band; plain white cuffs, sometimes superseded by others of lace, were also worn. The trunk-hose became loose breeches of uniform width and open at the knees, where they were fringed or had a border of lace, and were fastened with sash-like garters; the stockings were tight; the shoes had large roses; and the felt hat was large and wide in the brim. By the men of fashion this costume, in itself really worthy of decided commendation, was easily made to assume a fantastic aspect, by the adoption of rich and variously colored fabrics and the addition of lace, bunches of ribbon, feathers, embroidery, and gold lace, and numerous "points" or laces to fasten the breeches to the stockings, with boots long in the foot, and having tops of enormous width that were turned down and lined with lace. These gentlemen, who delighted in having long hair, also wore or more frequently carried on their left arm a short cloak; and they were provided with basket-hilted rapiers having blades of great length. Besides rejecting all bright colors, and every kind of ornamental accessory, a very different class of their contemporaries reduced this same costume to its simplest possible conditions, thus contrasting one extreme with another most opposed to it. These men, who to their closely-cropped hair owed their famous designation as "Roundheads," with their sombre and plain garments wore their felt hats of excessive height, with a great breadth of brim, and perfectly plain. The buff coats, adopted at this period as parts of the military uniform, conformed in their general character to the doublets worn as ordinary dress. While retaining the characteristic features of the fashions of their times, the dresses of the female members of the "Roundhead" section of the English community were made with the plainest simplicity—a simplicity, however, which the taste and ingenuity of the wearers rarely failed to render graceful and becoming. On his restoration, Charles II. brought with him to England the fashions of dress with which he had been familiar in France, and they suited well both his own character and that irresistible and widespread reaction from the stern and yet manly gloom of the Protectorate that burst out into a frenzy of national recklessness. Shortly after the king's return, indeed, and for some little time after the re-establishment of the monarchy, in the families of graver citizens a quiet style of dress, not unlike what had been prevalent for several years, continued in use by both sexes. Men wore plain doublets of moderate length, full breeches slightly ornamented at the knee, large bands, shoes tied over the instep in bows of moderate size, and loose cloaks having long open sleeves; pointed beards and moustaches continued to be worn also, and under their felt hats the men retained the coifs of past times, or they covered their heads with coifs or caps only. Plain, and in the body closely fitting, the ample skirts of the ladies' dresses, open in front to display an equally unpretending under-dress, occasionally were partly covered by a no less plain apron; their bands or collars, fastened in front with formal bows, were very large and generally quite plain, and their close hoods they wore tied under the chin, beneath flowing veils or mantles. The very different style of costume which Charles himself had learned to wear at the court of Louis XII. of France, and which he speedily taught his own subjects to assume, consisted of a comparatively long and loose doublet richly laced and embroidered, having large and puffed-out sleeves turned back a little below the elbow, leaving the lower arm to be covered by the full sleeves of the shirt with their lace ruffles at the wrists. Under this doublet was a vest, sleeveless, but otherwise resembling it, which was left open at the waist; in their turn, from beneath the vest, the breeches displayed their expanded width, with their ornamental bunches of ribbon above the knees and lace ruffles below them. A falling band of the richest lace enveloped the throat, and was loosely tied with an equally rich scarf of which the ends

hung down over the vest; an enormous periwig superseded the natural hair, its curls falling in abundance over the shoulders the beard being close shaven, and only a slight moustache permitted to remain. The hat, broad-brimmed, and having its brim on one side slightly turned up, was adorned with a rich band and a profusion of drooping feathers; the stockings were tight to the leg, and the shoes, made very high over the instep, were tied with immense bows that extended horizontally on either side of the foot; and a short cloak, no less splendid in both material and enrichment than the other portions of this gorgeous attire, either was suspended from the left shoulder or carried on the left arm. The sword, a rapier long and narrow in the blade, was suspended from a very broad and elaborately enriched belt crossing the person over the right shoulder. It



FIG. 47.—Costume, temp. Charles II.

will be understood that in the production of this costume the richest and most showy fabrics were employed; also that the men delighted in exhibiting in their dress every variety as well of color and tint as of material, white, black, scarlet, and different shades of brown being in especial favor, with trimmings of gold and silver lace, buttons and twist, and ribbons of all breadths and every hue. The accompanying woodcut, drawn from an original contemporary authority (fig. 47), gives a correct general idea of the costume of the period of Charles II. In the autumn of 1666, as we learn from the ever-observant Pepys, the king in council declared his purpose to set a more sober and less costly fashion for dress, which he declared that he would not alter. Accordingly, under his doublet Charles appeared in a "vest," "being a long cassock," as Pepys explains, "close to the body, of black cloth and pinked with white silk under it; and a coat, or doublet, over it; and the legs ruffled with white ribbon, like a pigeon's leg;" "and upon the whole," adds the diarist, "I wish the king may keep it, for it is a very fine and handsome garment." The king kept it so far as afterwards it pleased him, and no further. This vest, or waistcoat, has undergone many changes, indeed, but it never has fallen into disuse since that 15th day of October, 1666. In 1680 both vest and doublet became considerably longer, the latter reaching quite to the knees, and the former being but little shorter. The doublet was worn open, a sash about the waist then confining the vest. The brims of the hats at the same time became narrower, and bows of ribbon often were worn in place of feathers. The bandrick, or diagonal sword-belt, worn over the doublet was very broad, and allowed the hilt of the rapier to hang considerably below the left hip. About this time also, when jack-boots resembling those that had formed a part of the military appointments of the troopers in the civil war came into fashion, the sleeves of doublets were lengthened, and made with very broad cuffs which doubled back from the wrists. In the short reign of James II. (1685-1688), when the moustache disappeared, doublets and vests still further increased in length, and the cuffs of the doublet-sleeves became extravagantly large; more prominence was given to the lace cravats, which were worn loosely about the throat and with their ends hanging down over the upper part of the vest; the breeches and stockings remained without any change of form or adjustment; half-boots were worn, and buckles began at times to supersede roses and bows upon shoes; and at this time the sword was occasionally carried thrust through the lower part of the doublet, and almost in a horizontal position. The costume of the ladies of the Charles II. era, represented with such grace and effectiveness in Lely's pictures, Planché thus describes: "A studied negligence, an elegant deshabille, is the prevailing character of the costume in which they are nearly all represented; their glossy ringlets escaping from a bandeau of pearls, unveiled by even the transparent lawn of the band or of the partlet; and the fair round arm reclines upon the voluptuous satin petticoat, while the gown of the same rich materials piles up its voluminous train in the background." During the early part of the reign, however, much of the Puritan formality of then recent times lingered in female dress, as it did also in the attire of the male portion of the commonalty. Tightly laced bodices at no time lost favor with females of all ranks and classes. Hoods were worn, but generally only for protection from the weather, the prevailing usage being for females to wear their own hair in natural ringlets flowing over their shoulders, and with small

curls over their foreheads; false hair, indeed, was sometimes, but only sometimes, worn, and worn in an extravagant fashion. The custom of painting and placing patches on the face became more common as the second half of the century advanced; and the immodest practice of exposing the bosom then attained to the extreme of indelicacy. As might have been expected at that era, the seldom dormant aim of the one sex to imitate the costume of the other was in full activity; thus, Pepys says,—“Walking in the gallery at Whitehall (June 1, 1664), I find the ladies of honor dressed in their riding garbs, with coats and doublets with deep skirts, just for all the world like mine, and their doublets buttoned up the breast, with periwigs and with hats; so that only for a long petticoat dragging under their men's coats, nobody would take them for women in any point whatever; which was an odd sight, and a sight that did not please me.” Somewhat later, a similar “odd sight” excited a corresponding feeling, the disapproval being blended with perplexed surprise, in the mind of Sir Roger de Coverley (*Spectator*, June 2, 1711).

Whether worn by men or women, the ordinary dresses of the commonality in their general character resembled those of the noble and wealthy, but were much simpler in both style and materials. Accompanied by no other decided or marked innovation than the introduction of tight knee-breeches, which during the following century were worn by all classes, and still form no unimportant part of English costume, the reign of William III. witnessed such modifications in the costume of the two preceding centuries as tended to make it more formal and appropriate, while at the same time leading the way to the tasteless frivolities and excesses of the next succeeding century. The doublets or coats of the gentlemen, their favorite color some tint of claret when not scarlet or black, were longer, made to fit stiffly to the body and laced and embroidered along the edges and seams and around the pocket-holes or the large flaps of the pockets in their skirts; and their comparatively tight sleeves had enormous cuffs that were laced and adorned with buttons; large shoulder-knots of ribbon were also worn. The vests, retaining their length, were left unbuttoned below the waist. Sashes occasionally were worn, and sometimes over the doublet. The breeches were made to fit tolerably closely to the limbs, and were quite tight at the knees, where the tightly-fitting stockings, if not gartered, were drawn over them in a roll. The shoes, very high in the heel and fastened with buckles, had flaps which covered the instep and rose in front of the legs for 3 or 4 inches. The full shirt-sleeves with their lace ruffles were shown at the wrists; the loose neckcloth, had long pendent ends terminating in lace, if it was not entirely made of that material. The periwig, if possible more voluminous than ever, was abundantly powdered. The hat, sometimes triangular in form and with a narrow turned-up brim, was low in the crown, edged with gold-lace, and covered with feathers; or, being wide-brimmed, its brim was slightly turned up at the sides, when it was adorned only with a laced band and a small tuft of ribbons or feathers. The cloak, when in use, was rather longer than the doublet. In winter, the men kept their hands warm in small muffs that were suspended from ribbons about their necks; and for summer wear they had gloves edged with lace. When not attached to a broad and elaborately enriched belt crossing the right shoulder over the doublet, the rapier was carried thrust through the left pocket-hole of the doublet itself, the weapon being made to form an acute angle at the back of the wearer. A costume such as this, as a matter of course, would be subjected to various modifications, and would constantly be simplified in many particulars without any essential departure from the actual type. The accompanying figure (fig. 48), drawn from a contemporary French engraving which represents an assemblage of the most illustrious personages in France in the year 1696, when compared with the numerous effigies and other portraits of the same era in this country, shows the typical dress to have been identical in its essentials and characteristic on both sides of the Channel at the close of the 17th century. Further comparison, extending its range over the greater number of the countries of Europe, would serve to demonstrate the comprehensive prevalence of this same typical dress, and at the same time to assign its va-



FIG. 48.—French costume, 1696.

rious subordinate local modifications to the varying influences of climate and of national character. In the female dress of this period, as it is exemplified in portraits of ladies of rank and fashion, stiffness and a formality of aspect were strangely blended with eccentricity and frivolous display. Bodices, very long in the waist and rather obtusely pointed both behind and before, were very tightly laced over rigid corsets; rich petticoats or under-dresses, partly covered with equally rich small aprons, were displayed from under full and flowing dresses that were gathered up in masses at the back of the wearer, or were drawn back and made to trail along on the ground behind her. At first very short and wide and edged with lace, from within which the delicate sleeves of the undergarment issued forth, the sleeves of the gowns after a while became tight and were prolonged to the wrists, where they terminated in deep and wide upturned cuffs whence drooped a profusion of lace lappets or ruffles. Furbelows were introduced and worn in profusion upon dresses of every kind, including scarves and cloaks; and the fashion for adopting doublets and vests, with neckcloths, resembling those worn by men was prevalent in riding and walking costume. Heavy head-dresses also succeeded to the flowing ringlets and to the natural gracefulness of the coiffure of the era of Charles II. The hair, combed up and with an inclination backwards from the forehead, was surmounted by strata of ribbon and lace, sometimes intermingled with feathers, and a kerchief or scarf of some very light material thrown over all was permitted to hang down to the waist over and below it. Structures so produced assumed various forms, some of them being made to project while others either rose vertically or expanded in a horizontal direction, height, however, being the special aim; but in every case the result was the reverse of graceful or becoming. Hats, low in the crown and with wide brims, were worn over hoods when cold or when protection from wet required their adoption.

#### MODERN COSTUME.

*Century XVIII.*—The 17th century having been treated as a period of transition in the matter of costume between the Middle Ages and modern times, the era of modern costume may be defined to commence with the 18th century—that is, fourteen years before the accession of the sovereigns of the House of Hanover to the crown of Great Britain. Until in the course of this century it fell into general disuse for regular military service, defensive armor must be considered to have maintained a claim to have been regarded, under certain conditions and to a certain extent, as identified with the dress of an important and influential section of the community; that claim, however, which lingered so long and with such tenacity, altogether ceased to exist shortly after the commencement of the era of modern costume. For a considerable time, indeed almost till the middle of the century, costume must be considered to have been modified rather than subjected to decided innovation. Men's dress remained the same in its general character, but became improved from being simplified and from having its decoration toned down. Planché says:—"Square-cut coats and long-flapped waistcoats with pockets in them, the latter meeting the stockings, still drawn up over the knee so high as entirely to conceal the breeches (then made to fit with comparative tightness to the limbs), but gartered below it; large hanging cuffs and lace ruffles; the skirts of the coat stiffened out with wire or buckram, from between which peeped the hilt of the sword, deprived of the broad and splendid belt in which it swung in preceding reigns; blue or scarlet silk stockings with gold or silver clocks; lace neckcloths; square-toed, short-quartered shoes, with high red heels and small buckles; very long and formally-curved perukes, black riding-wigs, bag-wigs, and nightcap-wigs; small three-cornered hats laced with gold or silver galloon, and sometimes trimmed with feathers,—composed the habit of the noblemen and gentlemen during the reigns of Queen Anne and George I." To this habit the dress of the commonality, according to custom, conformed in all characteristic essentials. Meanwhile, when they did not wear such head-dresses as were very low, the ladies continued to elevate their strange and uncouth head-gear. About 1710, as if resolved that their figures should rival their heads in extravagance, they introduced the hooped petticoat, at first worn in such a manner as to give to the person of the wearer below her very tightly laced waist a contour resembling the letter V inverted—A. The hooped dresses, thus introduced, about 1740 attained to an enormous expansion; and, being worn at their full circumference immediately below the waist, they in many ways emulated the most outrageous of the farthingales of the Elizabethan age. Some few years also

before the middle of this century the "saque" made its appearance: it was a loose gown, open in front, which was worn hanging from the shoulders quite free of the person of the wearer, and was gathered up over the hoop when not permitted to trail along on the ground; in this unsightly garment any approach to "fit" was necessarily out of the question. At the same period, the men began to lay aside more of their lace and of the other ornamental accessories of their garments; their coats became longer, and their waistcoats somewhat shorter; the cuffs of their collarless coats increased in size until they reached their elbows; their stockings, when still drawn over their breeches above the knee, were so adjusted as to permit their breeches to be seen, but the breeches began to be made to fasten over the stockings, with buttons and buckles below the knee; their wigs ceased to curl over their shoulders, and pig-tails came into fashion. The costume of this era has been immortalized by Hogarth. During the forty years of this century that George III. was king, the fashions of dress passed through a remarkable variety of changes, each change contributing its own full share to the aggregate of extravagance and absurdity that was surpassed at no earlier period. About 1760 a passion for adorning the dress of both sexes began to revive; and it soon exercised its influence, reckless of all true taste, with unsparing energy—the head-dresses of the ladies, which about 1780 attained to the culminating degree of extravagant unsightliness, being its specially-favored field for operations. Fig. 49, faithfully reproduced from a contemporary engraving, shows under one of its least extravagant and tasteless forms a fashionable head-dress of the period in question. As a matter of course, in the construction of every variety of head-gear such as this, which in every instance necessarily obliterated all traces of the true form of the head and destroyed all proportion in the entire figure, false hair was used in abundance with a profusion of objects of a so-called decorative order. Until about 1785 the type of men's dress remained established without any essential change: the coat was made to fall back more than had been the usage a few years earlier, the object being to display more effectively the long-flapped waistcoat with the pockets in its laced flaps; the stockings always were gathered up below the knee under the breeches, which were fastened by buckles; the heels of shoes were lowered, and the buckles worn in them were comparatively small; cocked-hats were worn, with laced ruffles and cravats, and bag-wigs, which generally were powdered; and a broad black ribbon, called a "solitaire," was placed about the throat and fastened behind.



FIG. 49.—Head-dress, c. 1780.

This costume about 1785 gave way to the dress that in France was developed with the advance of the Revolution. Men's coats became very long, and sloped off from the waist, where they were buttoned, both upwards and downwards; their sleeves were moderately tight with small close-fitting cuffs, and their collars either were high and doubled back stiffly, or made to spread upon the shoulders; the flaps of their pockets were placed at the back and close together; and all puffing and lace and embroidery were laid aside. The flaps of waistcoats, if retained at all, were short, and the garment itself was made open at the throat, the frill of the shirt appearing from under it. The breeches, fitting very tightly, either were cut short at the knee, or carried a few inches below it and there buttoned and tied with strings, knee-buckles except for court-dresses having gone out of fashion; the tight breeches also at this same time frequently were prolonged as pantaloons to the middle of the calf of the leg, where they were met by half top-boots. A rather large cravat was tied loosely in bows about the throat; the hair, worn long generally, was powdered and tied in a queue; and the hats, round in form, were either of moderate height in the crown, or tall and conical, and their nearly flat round brim was either narrow or moderately

broad. The ladies delighted in tight bodices, furbelowed dresses, gorgeous petticoats, worn over hoops varying in size, and saques, which in reality were the mantles of early times revived, without a revival of their grace and elegance. About 1770, the sleeves of the ladies' dresses were tight on the upper arm, where they suddenly became very large, and, drooping at the elbow, they terminated in rich fringes of lace ruffles; a few years later the sleeves expanded from the shoulder, till they became a succession of constantly enlarging ruffles and lappets; and again, before 1780, they became tight throughout, with small cuffs and no lace at the elbows, when they were worn with long gloves. Influenced, doubtless, by the great portrait-painters of that time, about 1785 the female head-dresses gradually subsided, and their worst features for the most part disappeared. Hats having an immense expanse of brim grew into favor, and the natural hair was permitted to fall over the shoulders in ringlets. Small hoops were worn in 1788, with a dress open in front and trailing on the ground behind, their sleeves tight and frilled at the elbows. This dress often was worn with a tight and very low bodice, a white kerchief being gathered closely about the throat, and while entirely enveloping the bust, being puffed out from beneath the chin so as to resemble the breast of a pigeon. Round straw hats, with drooping edge-frills, bows of ribbon, feathers, and high crowns, completed this costume. Then in about five years came the era of short waists, that might be distinguished as the waistless era, when ladies' dresses, no longer distended by hoops, fell in straight loose folds to their feet. About 1795 open dresses were discarded; the saques ceased to be; waists became longer, and when the present century dawned they regained their natural position and form. At this time bonnets were worn that increased the wearer's head, or were flat and projecting. They also were adorned with a taste that was comparatively simple and becoming; and, at the same time, the hair, free from powder, was dressed in curls about the face and neck. While thus in ordinary life costume at the close of the 18th century became approximately what might be desired, court-dress still exhibited the extravagances that under other conditions had happily become obsolete, the hoop with all its really offensive mass of so-called decorative allies retaining its ground in defiance of all opposition, until the chief offender and its worst associates were banished by royal command when George IV. had become king.

#### BARONIAL.

The peers of the United Kingdom, on occasions of state and ceremony, over their habitual dress wear robes of scarlet cloth, made long and of ample dimensions, which are adjusted on the right shoulder and are guarded with bands or rows of ermine, the robes of the different orders and ranks of the peerage being distinguished as follows:—Barons, who now form the lowest order of British peers, on their scarlet robes have two bands of ermine; viscounts, whose order intervenes between the barons and the earls, have two and a half bands of ermine; the robes of earls have three bands; those of marquises have three and a half rows; and upon the robes of dukes, whose order is the highest, the ermine is in four rows.

For notices of the costume and insignia of members of orders of knighthood, see HERALDRY.

#### JUDICIAL AND FORENSIC:

So long as the highest offices in the law were held, in accordance with mediæval usage, by dignified ecclesiastics, those eminent personages were represented in their monumental effigies, not as wearing judicial or other legal dress and robes, but as habited in the official vestments of their rank as churchmen; and that this practice continued in force down to the time of the Reformation is shown in the brass in Ely Cathedral to Thomas Goodrich, bishop of that see, who also was lord high chancellor of England. Monumental effigies of judges, however, and of other personages of note in the law, occasionally occur from the middle of the 14th century downwards, which give information as to the form and adjustment of legal robes that doubtless is authentic, and therefore valuable; but these authorities do not extend to any indications of color. The actual dress of these legal personages evidently differed but little, if it differed at all, from the ordinary costume of their day; but over their



dress they wore a tippet, and a robe which with rare exceptions was fastened on the right shoulder, and their heads were covered with a close-fitting coif, in addition to which in the 15th and 16th centuries they carried the hood with the long pendent scarf, so characteristic of those times, cast over one of their shoulders. It is probable, also, that the long and loose gown with wide sleeves in general use assumed at a comparatively early period the aspect of an official robe by being made of the same material and color as the unquestionably official mantle. In the second half of the 16th century, and in the century following, the gowns worn by the judges when on the bench, and on all occasions of state and ceremony, certainly constituted parts of their official attire. Scarlet appears to have been the prevalent color of judicial robes, with linings and trimmings of miniver—the white skin of the ermine—until the 17th century, when on certain occasions the judges wore robes of black or violet; but robes and gowns of a yellowish hue, and distinguished as “mustard-colored,” were also worn; and there is a record of an issue of “liveries” of both cloth and silk with fur from the great wardrobe, in the time of Edward III., to the justices, the color of each fabric being green. Again, in similar allowances under Richard II. and Henry VI., “green” is a color specially mentioned with “violet in grain,” and fur of “miniver.” In his fine sculptured effigy at Harwood in Yorkshire, Chief Justice Sir William Gascoigne (died in 1419) is represented having suspended from his girdle an anlace or short sword, with a gypciere; and the same appendages also appear in several brasses to judges. In four illuminations, which have been reproduced in fac-simile and published in the *Archæologia* (xxxix. 358), in which are represented sittings of the king's four superior courts in the time of Henry VI.—Chancery, King's Bench, Common Pleas, and Exchequer—the robes and costume of the lord chancellor, judges, serjeants, barristers, and officers of the courts are shown with minute attention to both color and details. The chancellor and one judge who sits beside him, and all the judges of the three other courts, are alike in being attired in ample robes of scarlet, lined and trimmed with white fur; but the chancellor alone wears a scarlet robe which is not fastened on the shoulder and has openings pierced on each side to admit his arms passing through, so showing the sleeves of his under garment to be white; he is further distinguished by having about his shoulders and over his robe a tippet of scarlet, lined and bordered with white fur; the white lining of his hood, also, stands up about his neck like a collar, and on his head he has a close-fitting, dark-brown cap. Under his scarlet robe, the judge sitting on the right of the chancellor, who holds in his hands a sealed document, is habited in a gown of the same color; bare-headed and tonsured, he also has the white lining of his hood adjusted about his neck after the manner of a collar. To the right and left, two on each side, their seats on the same level with the two central scarlet-robed figures, four other personages, who may have been masters in Chancery, are seated, habited in flowing “mustard-color” robes not adjusted on the shoulder, and having falling over their shoulders large hoods of the same color lined with white; they all are bare-headed, and three of their number certainly are tonsured. Five judges sit in the court of King's Bench, robed alike in scarlet gowns, with tippets, and mantles worn over their tippets, and fastened on the right shoulder. All these robes are lined and bordered with white, and the mantles have scarlet hoods worn as collars closely encircling the throat. These five judges wear white coifs, as do the seven judges, all of them robed exactly like their brethren of the King's Bench, who preside in the Court of Common Pleas. Over the Court of Exchequer a baron presides, who is robed in the same manner as the judges of the two courts last named; but he differs from them in wearing (doubtless over his coif, which is not shown) a large scarlet hood-like cap, of the fashion prevalent at his day. He sits with two other judges on each side of him, who wear “mustard-color” robes of the same character; two of them also wear the large caps; while the two others, wearing coifs, hold similar caps in their hands; all these caps are “mustard-color.”

At the table in each court stand serjeants, counsel, notaries, clerks, and officers of various ranks, all of them in their proper official costume. All of them bare-headed, some of these persons wear full-sleeved gowns reaching to their feet, of blue, green, or mustard color; and their gowns,

which have small black collars, are adjusted at the waist with narrow black girdles. Others, wearing similar girdles, are habited in gowns of the same fashion that are party-colored, the division and junction of the two colors being vertical or per pale, and the colors being blue and green, blue or green and mustard-color, green and murrey, and two tints of green. These gowns also are “rayed,” or striped, either diagonally or vertically, with yellow, white, or blue. The notaries carry at their girdles their inkhorn and penner. The serjeants alone, who appear in each one of the four pictures, are habited in long and flowing gowns, worn without any belt, all of them party-colored blue and green and rayed, with tippets and hoods of the same colors; these learned gentlemen, also, have on their heads



FIG. 50.—Serjeant-at-law (time of Henry VI.).

coifs similar to those worn by the judges (fig. 50). The use of party-colored garments, undoubtedly of heraldic origin, by persons of various classes and ranks, has already been noticed. In the absence of any express record of the source whence certain officers of the law derived their party-colored gowns, it has been considered probable that these were livery gowns presented to serjeants and barristers by their clients of high rank, with their retaining fees. However this may be, it appears certain that their party-colored robes were worn by serjeants long before the 15th century; and, when giving his view as to their significance, in the following passage from a charge delivered to certain serjeants then newly created, in the thirty-sixth year of Queen Elizabeth, the lord chief justice suggested these party-colored robes having been worn by the judges:—“By the party-colored garments,” said that learned personage, “being both of deep color, and such as the judges themselves in ancient times used (for so we receive it by tradition), is signified soundness and depth of judgment, an ability to discern of causes, what color soever be cast over them, and under or with what veil or shadow soever they be disguised.” In the 15th century Sir John Fortescue said of a judge,—“Being a serjeant-at-law, he is clothed in a long priest-like robe, with a furred cape about his shoulders, and thereupon a hood with two labels (such as doctors of the law wear in certain universities with their coif); but, being made a justice, instead of his hood he must wear a cloak closed upon his right shoulder, all the other ornaments of a serjeant still remaining, saving that his vesture shall not be party-colored as a serjeant's may, and his cape furred with miniver, whereas the serjeant's cape is ever furred with white lambskin.” Whatever at various periods may have been the usage with judges, the wearing of party-colored robes by serjeants appears to have been finally discontinued about the commencement of the present century. In our own times, except on some special occasions when their robes are either purple or scarlet, serjeants wear a black silk gown, like that of queen's counsel. The robes of the junior members of the bar, made of black stuff instead of silk, are further distinguished by certain peculiarities of form. Reminiscences of the coifs of earlier days, and of the caps with the pendants, still linger in the wigs worn by the entire learned brotherhood of the law, and in certain peculiar appendages attached to their robes. The large bands also, worn at the present day, may be considered to have had their prototypes in the labels already mentioned, which appear, dependent on his breast from his hood, in the brass to Thomas Rolfe, barrister, 1446, at Gosfield, Essex. Fine and characteristic examples of judicial costume are preserved in various monumental effigies, some sculptured and others engraved, which include in their number the memorials of Judge Thomas Owen, 1598, and Lord Chief Justice Sir Thomas Richardson, 1634, both in Westminster Abbey; the effigy of Judge Richard Harper, temp. Mary, at Swarthstone,

Derbyshire; and the brasses, ranging in date from 1400 to 1563, at Deerhurst, Watford, Gunby, Graveney, Latton, Dagenham, Cowthorpe, Norbury, Milton, and Narburgh. It may here be added that, in various representations of notaries of the 15th and 16th centuries, they appear in the ordinary civilian attire of their period with a pen-case and inkhorn suspended from the girdle of their tunic; there is a good example in a brass in the church of St. Mary's Tower, Ipswich; while several of these personages are introduced into the illuminations representing the courts of law described above.

#### NAVAL AND MILITARY.

Any attempt to notice in detail the naval and military uniforms in use at successive periods even in England would far exceed our present limits. At the same time, it appears desirable here to observe that the very decided distinction between "uniform," and especially military uniform, and contemporary civil costume now obtaining is of comparatively recent date. Throughout the armor era such distinction can scarcely be said to have existed, nor were the services afloat and on land distinguished by special and recognized peculiarities of dress. In the navy, the distinctive characteristics of uniform have become the cocked hat, epaulets of bullion, the crown-and-anchor button, and a by no means lavish application of gold lace—the cloth, a dark blue with facings and lining of white, except during the reign of William IV., when the white was superseded by scarlet. Gradations of naval rank are indicated by the presence of a crown, a star or stars, and an anchor on the shoulder-strap of the epaulets, and by the size and comparative richness of the bullion; also by the number and the breadth of distinct strips of gold lace that encircle the cuffs of coats and jackets; all executive officers being further distinguished by a coil of the gold lace attached to the uppermost of the cuff-circles. From the time that the stout "buff-coat" of the era of the Commonwealth succeeded to what still lingered of the plate panoply and the mail of earlier times, the uniform of the British army, for a while in many essential features conforming to the prevailing characteristics of the general costume of the day, has undergone a succession of changes for the most part more remarkable for variety and often for caprice, than expressive either of true taste in the consistent adornment of a soldier's person, or of considerate adjustment to the exigences of military service, the exceptions being the judicious innovations happily introduced early in the present century by the duke of Wellington. Scarlet obtains as the distinctive national British military color, certain arms of the service being attired in blue or dark green; while the recent volunteer movement has brought with it a variety of uniforms expressly adapted for use by the reserved forces. For a comprehensive, accurate, and copiously illustrated sketch of British military costume, readers are referred to the *History of the Dress of the British Soldier*, by Captain John Luard.

#### HIGHLANDS OF SCOTLAND.

Without a rival in the picturesque individuality of its character, the national costume of the Highlands of Scotland is remarkable as well for the manner in which it has been made to distinguish the various clans or septes of the same race, as for a certain general uniformity that significantly intimates the brotherhood of the clans as alike sharing a single common nationality. It probably is due to its own distinctive peculiarities that the Scottish Highland dress should have been inherited and transmitted from generation to generation almost without any change, and that at the present day it should be held in as high a degree of estimation as it ever enjoyed in past times. In early ages, having been influenced in a certain degree by the general fashions of dress prevalent at successive periods, a comparatively slight use of defensive armor having also for a while been adopted as a military accessory, shortly after the commencement of the 17th century this costume may be considered to have assumed the character which since that time it has maintained, with scarcely any modification except in the style of the short tunic. Before the accession of James VI. of Scotland to the throne of Great Britain, the tunic and the "phillibeg," or kilt, formed a single garment, whereas apparently during the reign of the son of Queen Mary Stuart the kilt became a separate garment, to be adjusted about the waist, and reaching not

quite to the knees after the manner of a short petticoat, a vest and tunic being separate garments also. Stockings, gartered below the knees, which thus would be left bare, with shoes, completed the equipment of the lower limbs. A cap or bonnet, without any peak, decorated with a spray of heather, was worn as a head covering, the bonnets of the chiefs being distinguished by the addition of eagle's feathers. In front of the person, and depending from a belt encircling the waist, was worn the "spileuchan," or pocket-purse, covered with fur; and a "plaid," or scarf, of ample dimensions, generally adjusted across the person of the wearer, and having the ends hanging down from a brooch fastened on the left shoulder, as in fig. 52, completed the costume; occasionally, however, the plaid was gathered up so as to admit more free movement in the manner represented in fig. 51.

The weapons were a broadsword, or "claymore," having a straight blade and a basket-hilt attached to a broad baudrick which passed over the right shoulder, and a dirk worn on the right side, the sheath of the dirk being also



FIG. 51.—Chief of the Clan MacDonell.



FIG. 52.—Piper of the Clan Gregarach.

provided with a hunting-knife. Before the general use of firearms by the highlanders, they carried for defence a circular target on the left arm. The two accompanying figures, which show the different modes of adjusting the plaid, are also examples, the one of the tartan in which green is the prevailing color, with narrow checks of red (fig. 51), a chief of the clan MacDonell, and the other (fig. 52), a piper of the clan Gregarach, of a tartan which is red with narrow black checks. The colors, and the "set" or patterns of the checks, of the tartans of the different clans, the Royal Stuart being the richest of all, have been determined for a considerable time, the actual era of their original introduction not having been definitely determined. The costume of each clan is fully and faithfully represented in M'ian's volumes, referred to below.

#### BIBLIOGRAPHY.

To compensate in some degree for unavoidable conciseness, as much space as possible is here assigned to references to publications which comprehend within their range the consideration and illustration of minute details, and which also treat of costume under widely varying conditions and regarded from very different points of view. No attempt is made to give a list that is even approximately complete, but attention is directed to a selected series of works of a typical and authoritative character, in which is concentrated direct, specific, and suggestive information. In its historical aspect, the study of costume implies a systematic comparison of the costumes of different races and countries. Reference must also be made to those monumental works of art that have come down to our own times comparatively unmutated, which are also of equal value as illustrations of armor. (See ARMS AND ARMOR.)

EGYPTIAN.—The great and magnificent foreign works on the "monuments" of Egypt by Lepsius (*Denkmäler aus Ägypten*)

and *Ethiopes*, with 899 plates), Champollion, and Rosellini; *Egypt and Nubia*, by David Roberts, R.A. In the two series of Sir G. Wilkinson's *Manners and Customs of the Ancient Egyptians* (8 vols. with 600 illustrations) the subject is exhaustively treated; see also the smaller work (2 vols., copiously illustrated) by the same author. Equally excellent is the companion work, Lane's *Manners and Customs of the Modern Egyptians*, 5th edition, illustrated. See also the *British Museum Photographs*, part ii., 118 plates.

**ASSTRIAN.**—Layard's *Monuments of Nineveh*, two series; and, by the same author, *Nineveh and its Remains*, and *Nineveh and Babylon*; *British Museum Photographs*, part iii., 245 plates.

**GREEK AND ROMAN.**—The best illustrators are the *British Museum Photographs*, parts iv. and v., 175 and 97 plates; with other photographs of Greek and Roman draped statues and busts, and also others of certain gems and vases by ancient artists. The fac-simile representations will be advantageously associated with Smith's and Rich's *Dictionaries of Greek and Roman Antiquities*. See also Hope's *Costumes of the Ancients* (Egyptian, Greek, and Roman); Hamilton's *Etruscan and Greek Vases*; Millingen's *Ancient Unedited Monuments* (Greek), and Inghram's great work, *Monumenti Etruschi* (14 vols., including the *Vasi Fittili*).

**ORIENTAL.**—Simpson's *India, Ancient and Modern* (2 vols., 50 illustrations); Forbes Watson and J. W. Kaye's *People of India* (with photographs); *Chinese Costumes and the Employments of Chinese Traders*, edited by Sir J. Bowring (3 vols.); and J. Thompson's illustrated volumes on China, the Straits of Malacca, etc. Also Audsley and Bowe's splendid *Keramic Art of Japan*, and Sir R. Ker Porter's illustrated *Travels in Persia*, etc. For the costumes of Central Asia, Schuyler's *Turkistan* and Captain Burnaby's *Khiva*.

**ECCLIASTICAL.**—*Vestiarium Christianum*, by Rev. W. B. Marriott, written with true historical impartiality, and illustrated with 63 excellent photographs and engravings, commencing from the earliest known examples of authority, and tracing the history of ecclesiastical vestments from its origin. The subject is further worked out in D'Agincourt's *History of Art by its Monuments* from 4th to 16th century (51 plates of sculpture and 204 of painting); in Lee's *Glossary of Liturgical and Ecclesiastical Terms*. In its full development, from the 13th century downwards, effigies of ecclesiastics, which abound in England and in some parts of the Continent, are among the most perfect of the mediæval exponents and illustrators of costume; and they themselves have been fully and faithfully illustrated in the following works on early monumental art:—Stothard's *Monumental Effigies of Great Britain*; Waller's *Monumental Brasces*; Cotman's *Brasces of Norfolk and Suffolk*; Boutell's *Monumental Brasces and Slabs*, and *Monumental Brasces of Great Britain*; Hollis's *Monumental Effigies* (incomplete); Haines's *Manual of Monumental Brasces*.

**MISCELLANEOUS WORKS ON COSTUME.**—Bruce's *Bayeux Tapestry*; 4to, 17 fac-simile plates, 1856; Fairholt's *Costume in England*, 8vo, illustrated, 1860; Fowler's (William, of Winterton) *Examples of Mediæval Art*, atlas folio, 116 plates, 1796–1829; Froissart's *Chronicles*, translated by Johnes, 4 vols. roy. 8vo, 72 plates and numerous woodcuts, 1844; Hogarth's *Works*, engraved by himself, with descriptions by J. Nichols, atlas folio, 153 plates, 1822; Holbein's *Portraits of the Court of Henry VIII.*, imp. 4to, 80 plates, 1828; Humphrey's (R. N.) *Illuminated Books of the Middle Ages*, folio, London, 1849; Lodge's *Portraits and Memoirs of Illustrious Personages of Great Britain*, 12 vols. imp. 8vo, 240 plates, 1823–35; Luard's *History of the Dress of the British Soldier from the Earliest Period to the Present Time*, 8vo, 50 plates, 1852 (the later portions are the best); M'Ian and Logan's *Clans of the Scottish Highlands*, 2 vols. imp. folio, 72 plates, 1857; Malcolm's *Manners and Customs of London*, 6 vols. 8vo, 63 plates, 1810–11; Nichols's *Progresses, Pageants, &c., of Queen Elizabeth*, 7 vols. 4to, numerous plates, 1823–29; Planché's *History of British Costumes*, small 8vo, 1836; Planché's *Encyclopædia of Costume*, 2 vols. 4to, 1876–77; Sample's (Miss) *Costume of the Netherlands*, folio, 30 plates, 1817; Shaw's *Dresses and Decorations of the Middle Ages* (from 7th to 17th century), 2 vols. imp. 8vo, 94 plates, and numerous woodcuts, 1840–43; Strutt's *Regal and Ecclesiastical Antiquities of Great Britain*, roy. 4to, 72 plates, 1842; Strutt's *Dresses and Habits of the English*, 2 vols. roy. 4to, 153 plates, 1842; Westwood's *Miniatures of Anglo-Saxon and Irish Manuscripts*, imp. folio, 54 plates, 1868.

Of foreign works on costume, the two that have special claims to the attention, the admiration, and the grateful confidence of students are—Hefner-Alteneck, *Costume du moyen-âge chrétien*, 4 vols. imp. 4to, 420 plates, Frankfurt, 1840–50; and Viollet-le-Duc, *Dictionnaire raisonné du mobilier française*, 6 vols. 8vo, Paris, 1858–75 (the first four volumes, rich in admirable engravings, are specially devoted to armor and costume). Besides these, the following are of importance:—Bonnani's *Costumes of the Religious Orders*, 2 vols. 4to, 249 plates, Rome, 1741; Bonnard et Mercuri, *Costumes historiques des XIe, XIIIe, XIVe, et XVe siècles*, 2 vols. imp. 4to, 200 plates, Paris, 1867; Burgmair, *Triomphe de l'Empereur Maximilien I.*, atlas folio, 135 plates,

Vienna, 1796; Chapuy, *Le moyen âge pittoresque*, 2 vols. folio, 180 plates, 1837; Chevignard et Duplessis, *Costumes historiques des XVIIe, XVIIIe, et XIXe siècles*, 2 vols. imp. 4to, 150 plates, Paris, 1867; Du Sommerard, *Les arts au moyen âge*, 10 vols. (5 folio, and 5 of text 8vo), 510 plates, Paris, 1838–48; Duflon, *Recueil d'estampes, représentant les grades, les rangs, et les dignités, suivant le costume de toutes les nations existantes*, large folio, 240 plates, Paris, 1779–80; *España artistica y monumental*, 3 vols. imp. folio, 145 plates, Paris, 1842–59; Fabri's *Raccolta di Varii Vestimenti ed Arti del Regno di Napoli*, folio, 27 plates, Naples, 1773; Helyot, *Histoire des ordres monastiques, religieux, et militaires*, 8 vols. 4to, 812 plates, Paris, 1792; Jaquemin, *Iconographie méthodique du costume du Ve au XIXe siècle*, roy. folio, 200 plates, Paris; Lacombe, *Galerie de Florence et du Palais Pitti*, 4 vols. roy. folio, 192 plates, Paris, 1789–1807; Laeroix, Paul, *Manners, Customs, and Dress during the Middle Ages and the Renaissance*, 8vo, London, 1874; Laeroix, Paul, *Military and Religious Life in the Middle Ages and the Renaissance*, 4to, London, 1874; Laeroix, Paul, *The 18th Century, its Institutions, Customs, Costumes*, 8vo, London, 1875–76; Lanté, *Gallerie française de femmes célèbres*, atlas 4to, 70 plates, Paris, 1841; Malliot et Martin, *Recherches sur les costumes, les mœurs, les usages religieux, civils, et militaires des anciens peuples*, 3 vols. 4to, 228 plates, Paris, 1809; Pauly, *Description ethnographique des peuples*, roy. folio, St. Petersburg, 1862; Panquet Frères, *Modes et costumes historiques et étrangers*, 2 vols. med. 4to, 196 plates, Paris, 1873; Racinet, M. A., *Le costume historique*, in two forms, large and small, Paris, 1876; Straub, G. M., *Trachten oder Stammbuch*, small oblong 4to (several hundreds of curious woodcuts of costumes), 1600; Voellio, *Habiti Antichi et Moderni di tutti il Mondo*, 3 vols. 8vo, Venice, 1859–63.

Examples and illustrations of early costume of great interest and value may be found in the *Archæologia*, M. Didron's *Annales Archæologiques*, the *Journals of the Archæological Societies*, the various County Histories, the *Monumenta Vetusta of the London Society of Antiquaries*, and other kindred works.

(C. B.)

COTA, RODRIGO, a Spanish poet of the 15th century, said to have been born at Toledo. Nothing is known of his life or death, saying that he was poor and of humble rank. To him is attributed the popular *Coplas de Mingo Revulgo*, an anonymous pastoral satire against Henry IV. of Castile, which has been often edited and often imitated, and which is unquestionably one of the first attempts at dramatic poetry in Spanish literature. To him, too, is sometimes ascribed the authorship of a similar piece, the *Dialogo entre el amor y un viejo*. Besides these, he is supposed to have written the first act of the celebrated novel-drama, the *Celestina* (1480), which was finished in twenty-one acts by Fernando de Rojas. For an account of the influence of the *Celestina* on the Castilian drama, and of the numerous editions, imitations, and translations of it, see Ticknor, *History of Spanish Literature*, vol. i. pp. 235–244.

CÔTE D'OR, a department in the east of France, formed of the northern region of the old province of Burgundy. It is bounded N. by the department of Aube, N. E. by Haute-Marne, E. by Haute-Saône and Jura, S. by Saône-et-Loire, and W. by Nièvre and Yonne, and lies between 46° 55' and 48° 2' N. lat. The surface is mostly rugged. A chain of hills runs from north-east to south-west through the centre of the department, separating the basin of the Seine from that of the Saône, and forming the connecting-link between the Cévennes and the Vosges mountains. Extending southwards from Dijon is a portion of this range which, on account of the excellence of its vineyards, bears the name Côte d'Or, whence that of the department. The rivers are numerous but small, the only one navigable being the Saône. The Burgundy Canal, connecting the Rivers Saône and Yonne, traverses the department from south-east to north-west. The soil is generally stony, but rich. Wine in large quantities, cereals, fruit, beetroot, rape-seed, mustard, honey, flax, hemp, and hops are produced; and good horses, sheep, and cattle are reared. The iron mines furnish large quantities of ore; and anthracite, marble, lithographic stones, gypsum, and potter's clay are worked. The manufactures include iron, steel, nails, tiles, oil, leather, grindstones, paper, cloth, sugar, beer, and spirits. The department is divided into the arrondissements of Dijon, Beaune, Châtillon, and Semur, containing 36 cantons and 717 communes. The chief town is Dijon. The total area is 3382 square miles, and the population in 1872 was 374,510.

COTES, ROGER (1682–1716), an English mathematician and philosopher, born at Burbage, Leicestershire, of which place his father was rector. When only twenty-four years of age he was appointed Plumian professor of astronomy

and experimental philosophy in the university of Cambridge. He took orders in 1713; and the same year, at the request of Dr. Bentley, he published the second edition of Newton's *Principia* with an original preface. He died June 5, 1716, at the age of thirty-three, leaving unfinished a series of elaborate researches on optics, in reference to which Newton observed, "If Mr. Cotes had lived, we should have known something." With regard to pure mathematics, the principal discovery of Cotes consists in a theorem which still bears his name, and which furnishes the means of integrating by logarithms and arcs of the circle the rational fractions whose denominator is a binomial. His papers were collected and published by his successor Dr. Robert Smith.

**CÔTES-DU-NORD**, a maritime department of the north-west of France, formed from the northern part of the province of Brittany, is bounded on the N. by the English Channel, on the E. by the department of Ille-et-Vilaine, on the S. by Morbihan, and on the W. by Finistère, and is situated between 48° 3' and 48° 67' N. lat. To the north the country is flat, but to the south it is rugged and undulating. A chain of granitic hills, the Monts du Menez, runs east to west through the department, dividing it into two unequal parts, of which the southern is the smaller. Towards its western extremity this chain bifurcates to form the Montagnes Noires, to the south-west of the department, and the Montagnes d'Arès in Finistère. The rivers of the Channel slope are the Rance, Arguenon, Guessan, Gouet, Trieux, Tréguier, and Léguer, while the Blavet, Meu, Oust, and Aulne belong to the southern slope. Off the coast, which is steep, rocky, and much indented, are the Sept-Iles, Bréhat, and other small islands. The principal bays are those of St. Malo and St. Briec. The rocks of the district are granite, porphyry, gneiss, schist, and allied rocks, and workable slate and marble. Many of the plains on both sides of the chain of hills are sandy and sterile, and much of the soil is stony. The more important products are hemp, flax, cereals, wax, honey, lead, and iron; the chief industries are the rearing of horses, sheep, goats, and cattle; sea-fishing; the manufacture of sail-cloth, linen, spun-wool, sugar, and paper; and smelting and forging. The department is divided into the five arrondissements of St. Briec, Dinan, Guingamp, Lannion, and Loudéac, which contain 48 cantons and 384 communes. The chief town is St. Briec. Corseul, or Corseult, a small town of some 3000 inhabitants, six miles to the north-west of Dinan, is interesting for the Roman remains discovered there, and for its preservation of the name of the ancient Celtic tribe of the Curiosolite. The total area of Côtes-du-Nord is 2688½ square miles, and the population in 1872 was 622,295. Bas Breton is spoken in the arrondissements of Guingamp and Lannion, and in part of those of Loudéac and St. Briec.

**COTOPAXI**, a volcano of the Andes, in Ecuador, 35 miles S.S.E. of Quito, remarkable as the loftiest in the world. The earliest outbursts on record took place in 1532 and 1533; and since then the eruptions have been both numerous and destructive. Among the most important are those of 1744, 1746, 1766, 1768, and 1803. In 1744 the thunderings of the volcano were heard at Honda on the Rio Magdalena, about 500 miles distant; in 1768 the quantity of ashes ejected was so great that it covered all the lesser vegetation as far as Riobamba; and in 1803 Humboldt reports that at the port of Guayaquil, 160 miles from the crater, he heard the noise day and night like continued discharges of a battery. There were considerable outbursts in 1850, 1854, 1856, and 1864; and the escape of steam and smoke still continues. The appearance of the mountain is in the highest degree sublime,—its summit presenting the aspect of a perfect cone, which stands out against the sky in bold relief and splendor of snow. In 1802 Humboldt made a vain attempt to scale the cone, and pronounced the enterprise impossible; and the failure of Boussingault in 1831, and the double failure of Wagner in 1858, seemed to confirm his opinion. In 1872, however, Dr. Wilhelm Reiss succeeded on the 27th and 28th of November in reaching the top, and in the May of the following year the same feat was accomplished by Dr. A. Stübel. According to Dr. Reiss the height of the north-west peak of Cotopaxi is 19,498 feet above the level of the sea, and that of the south-west peak 19,429, while the snow-line on the western side is at a height of 15,180 feet, and on the southern at 15,174.

See Dr. Reiss, "Über eine Reise," &c., in *Zeitschrift der Deutschen Geolog. Gesellschaft*, 1873; Stübel, in *Bulletin de la Soc. de Géogr. de Paris*, 1874; also article **ALBANI**, vol. ii. p. 17.

**COTRONE**, a town of Italy. See **COTRONA**.

**COTTA**, a family intimately connected with the history of German literature.

**JOHANN GEORG COTTA** was the founder of the illustrious Cotta publishing-house. At the time of the Reformation the family (originally of noble Italian blood) lived in Eisenach; and we hear of them later as being settled in Dresden. Johann Georg started business at Tübingen in 1640.

His son, **JOHANN FRIEDRICH** (1701–1779), born March 12, 1701, devoted himself to theological study, and began his public career as lecturer in Jena University. He then travelled in Germany, France, and Holland, and, after a stay of several years in London, became professor at Tübingen in 1733. In 1736 he removed to the chair of theology in the university of Göttingen, which had been instituted as a seat of learning, two years before, by George II. of England, in his capacity as elector of Hanover. In 1739, however, he returned, as extraordinary professor of theology, to his Alma Mater, and, after successively filling the chairs of history, poetry, and oratory, was appointed ordinary professor of theology in 1741. Finally he died, as chancellor of the university, on the 31st of December, 1779. His learning was at once wide and accurate; his theological views were orthodox, although he did not believe in strict verbal inspiration. He was a voluminous writer. His chief works are his edition of Johann Gerard's *Locis Theologicis*, and the *Kirchen Historie des Neuen Testaments*.

The most famous member of the family was **JOHANN FRIEDRICH FRIEDRICH COTTA VON COTTENDORF** (1764–1832), a grandson of the theologian, who was born at Stuttgart April 27, 1764. He attended the gymnasium of his native place, and originally meant to study theology, but became greatly interested in the science of war. In 1782 he entered, as a student of mathematics, in the university of Tübingen, and on the recommendation of Professor Pfeiderer was elected tutor of Prince Lubomirski in Warsaw. While engaged in tuition, he continued his own studies with great enthusiasm; and, in his zeal for self-culture, he spent a considerable time in Paris, studying French and natural science, and mixing with distinguished literary men. After practising as an advocate in one of the higher courts, Cotta, in compliance with his father's earnest desire, undertook to conduct the publishing business at Tübingen, which, in the hands of subordinates, had very much declined. He started in December, 1787, and labored incessantly to acquire familiarity with all the details. The house connections rapidly extended; and, in 1793, the *Allgemeine Zeitung*, of which Schiller was to be editor, was planned. Schiller was compelled to withdraw on account of his health; but his friendship with Cotta deepened every year, and was a great advantage to the poet and his family. Cotta awakened in Schiller so warm an attachment that, as Doering tells us, when a bookseller offered him a higher price than Cotta for the copyright of *Wallenstein*, the poet firmly declined it, replying, "Cotta deals steadily with me, and I with him." In 1796 Schiller and Cotta founded the *Boren*, a periodical very important to the student of German literature. The poet intended, by means of this work, to infuse higher ideas into the common lives of men, by giving them a nobler human culture, and "to reunite the divided political world under the banner of truth and beauty." The *Boren* brought Goethe and Schiller into most intimate relations with each other and with Cotta; and Goethe, while regretting that he had already promised *Wilhelm Meister* to another publisher, contributed the *Unterhaltung Deutscher Ausgewanderten*, the *Roman Elegies*, and a paper on Literary Sensualism. Fichte sent essays from the first; and the other brilliant German authors of the time were also represented. In 1798 the *Allgemeine Zeitung*, which is still the leading daily paper in Germany, appeared at Tübingen, being edited first by Posselt and then by Huber. It soon wielded a mighty influence, and must prove a valuable storehouse to the historian. In 1798 the editorial office was transferred to Stuttgart, and in 1803 to Augsburg. In 1799 Cotta entered on his political career, and was sent to Paris by the Würtemberg states as their representative, where he made friendships which proved very advantageous

for the *Allgemeine Zeitung*. In 1801 he paid another visit to Paris in a political capacity, when he carefully studied Napoleon's policy, and treasured up many hints which were useful to him in his literary undertakings. He still, however, devoted most of his attention to his own business, and, for many years, made all the entries into the ledger with his own hand. He relieved the tedium of almost ceaseless toil by pleasant intercourse with literary men. With Schiller, Huber and Pfeffel he was on terms of the warmest friendship; and he was also intimate with Herder, Schelling, Fichte, Richter, Voss, Hebel, Tieck, Therese Huber, Matthiesson, the brothers Humboldt, Johan Müller, Spittler, and others, whose works he published in whole or in part. In the correspondence of Alexander von Humboldt with Varuhagen von Esme we see the familiar relations in which the former stood to the Cotta family. In 1795 appeared the *Politischen Annalen* and the *Jahrbücher der Buchhandlung*, and in 1798 the *Damenkalender*, along with some works of less importance. In 1807 he issued the *Morgenblatt*, to which Schorn's *Kunstblatt* and Menzels *Literaturblatt* were afterwards added. In 1810 he removed to Stuttgart; and from that time till his death he was loaded with honors. State affairs and an honorable commission from the German booksellers took him to the Vienna Congress; and in 1815 he was deputy-elect at the Württemberg Diet. In 1819 he became representative of the nobility; then he succeeded to the office of member of committee and (1824) vice-president of the Württemberg second chamber. He was also chosen Prussian privy court councillor, Bavarian chancellor, and knight of the order of the Württemberg Crown. Meanwhile such publications as the *Polytechnische Journal*, the *Hesperus*, the *Württembergischen Jahrbücher*, the *Hertha*, the *Ausland*, and the *Inland* issued from the press. In 1828-29 appeared the famous correspondence between Schiller and Goethe. Cotta was an unflinching friend of young struggling men of talent. In addition to his high standing as a publisher, he was a man of great practical energy, which flowed into various fields of activity. He was a scientific agriculturist, and promoted many reforms in farming. He was the first Württemberg landholder who did away with servitude on his estates. In politics he was throughout his life a moderate liberal. In 1824 he set up a steam printing press in Augsburg, and, about the same time, founded a literary institute at Munich. In 1825 he started steamboats, for the first time, on Lake Constance, and introduced them in the following year for the Rhine traffic. In 1828 he was sent to Berlin, on an important commission, by Bavaria and Württemberg, and was there rewarded with orders of distinction at the hands of the three kings. He died on the 29th of December, 1832.

His son, FRIEDRICH GEORG COTTA VON COTTENDORF, who was born in 1796, and died in 1863, succeeded to the management of the business on the death of his father. He was materially assisted by his brother-in-law, Chamberlain Freiherr von Reischach. He greatly extended the connections of the firm; and, in 1865, the house had establishments for different kinds of publications at Stuttgart, Augsburg, Leipzig, and Muzioh. The business is still in the hands of the Cotta family. (r. gr.)

COTTABUS (Greek, *κότταβος*, *κόσσαβος*, or *ότταβος*), a game of skill for a long time in great vogue in ancient Greece, frequently alluded to by the classical writers of the period, and not seldom depicted on the ancient vases. The object of the player was to cast a portion of wine left in his drinking cup in such a way that without breaking bulk in its passage through the air, it should reach a vessel set to receive it, and there produce a distinct noise by its impact. The thrower, in the ordinary form of the game, was expected to retain the recumbent position that was usual at table, and in flinging the cottabus, to make use of his right hand only. To succeed in the aim no small amount of dexterity was required, and unusual ability in the game was rated as high as corresponding excellence in throwing the javelin. Not only was the cottabus the ordinary accompaniment of the festal assembly, but at least in Sicily a special building of a circular form was sometimes erected so that the players might be easily arranged round the basin, and follow each other in rapid succession. Like all games in which the element of chance found a place, it was regarded as more or less ominous of the future success of the players, especially in matters of love; and the excitement was sometimes further augmented by some object

of value being staked on the event. Various modifications of the original principle of the game were gradually introduced, and no fewer than nine different kinds, though some of these have no very striking individuality, have been described by Greddeck in his essay on the subject, published in his *Antiquarische Versuche*, 1800. In one variety a flotilla of shallow saucers was set swimming in a basin, and he was regarded as the victor who sank the greatest number by his casts; in another the difficulty of the task was increased by setting up a small figure called a *μάρις*, and requiring the jet of wine first to strike on this, and then to fall with a noise into the vessel beneath; while in a third two scales were balanced in such a way that the weight of the liquid cast into either scale caused it to dip down, and touch the top of an image. In the boisterous mirth of convivial gatherings the players seem sometimes to have set a slave or one of their companions whom they wished to annoy, in the place of the *μάρις*; and from this ill-mannered custom the word *ακουσραβίζω* is occasionally used in the sense of to insult. The game appears to have been of Sicilian origin, but it spread through Greece from Thessaly to Rhodes, and was especially fashionable at Athens. Dionysius, Alceus, Anacreon, Pindar, Bacchylides, Æschylus, Sophocles, Euripides, Aristophanes, Antiphanes, have frequent and familiar allusion to the *κότταβος*; but in the writers of the Roman and Alexandrian period such reference as occurs shows that the fashion had died out. In Latin literature it is almost altogether unknown.

For ancient accounts see Athenæus, xv.; the Scholiast on Aristophanes, *Pac.*; the Scholiast on Lucian's *Lexiphrones*; Tzetzes, *Chilodæ*, vi.; Suidas, s. v. *κότταβίζω*; Nonnus, xxxiii.; and for modern investigation, Meursius, *De ludicæ Græcorum*; Becker, *De ludicæ cottaborum*, Dresden, 1754-55; Fr. Jacobs, "Ueber den Cottabus," in Wieland's *Attisches Museum*, iii.; Osann, *Beiträge zu griech. Litt. Geschichte*, 1835; Panofka, *Recherches sur les noms de vases grecques*, 1827; Otto Jahn, "Kottabos auf Vasenbildern," with illustrations, in *Philologus*, 1867; and *Annali dell' Instituto di corrisp. Arch. di Roma*, 1868 and 1870.

COTTEREAU, JEAN. See CHOUEAN.

COTTIN, SOPHIE (1773-1807), née RESTAUD, was born at Tonneins, Lot-et-Garonne, and was educated at Bordeaux. At seventeen she married a banker, who died three years after, when she removed to Paris. In 1798 she published anonymously her *Clair de Albe*, to obtain money, it is said, for a friend who was proscribed and exiled. Her second romance, *Malvina* (1800), was also anonymous; but the success of *Amélie Mansfield* (1802) induced the authoress to reveal her identity. In 1805 appeared *Mathilde*, a crusading story, sentimental and extravagant to a degree; and in 1806 she produced her last story, the famous *Elisabeth, ou les exilés de Sibirie*. At the date of her death Madame Cottin was engaged on an educational novel, and on a treatise entitled *La religion prouvée par le sentiment*. Her worst fault is a tendency to exaggerate the virtues of her characters. A complete edition of her works was published, in two volumes, in 1847.

COTTON, an indigenous product of all intertropical regions, consists of the down or fine cellular hair attached to the seeds of plants belonging to the genus *Gossypium*, natural order *Malvaceæ*. The plants which supply the raw material for one of our greatest industries, and for the clothing of all nations, may claim to be ranked amongst the most valuable of nature's productions. The genus has occasioned no small degree of perplexity to botanists, and the genealogy of the different varieties is still involved in much uncertainty. Linneus admitted five species of *Gossypium*, an estimate which by some subsequent botanists has been more than quadrupled. The investigations of Professor Parlatore, who, in a handsome folio with colored plates, described the cottons which he had seen cultivated in Italy, led him to the conclusion that there were seven species of cotton only, the rest being merely varieties. These are:—

1. *Gossypium arboreum*, Linn., found in Ceylon, the Moluccas, Arabia, Senegal, &c.
2. *G. herbaceum*, Linn., growing in Siam, China, India, Italy, &c.
3. *G. condavichense*, Parl., indigenous to the Sandwich Islands.
4. *G. hirsutum*, Linn., including Siamese, Bourbon, Upland Georgia, and Louisiana cottons.
5. *G. barbadense*, Linn., comprising Sea Island and Barbados cotton, with long staple.

6. *G. tahitense*, cottons from the Society Islands, Tahiti, &c., in the Pacific.

7. *G. religiosum*, Linn., including Peruvian and other cottons, principally with seeds in adherent files.

Some authorities have enumerated ten species, and the cultivators of cotton have been still more extravagant in the multiplication of species or varieties. Not regarding the effects produced by soil, climate, or culture, they have given new or provincial names to the different sorts of the same species, and have invented a nomenclature which has only produced additional confusion. In Dr. Royle's exhaustive work entitled *The Culture of Cotton in India* the reader will find a trustworthy source of information upon the botanical part of the subject.

The cottons of the New and those of the Old World constitute the two great typical divisions of the kinds most known to commerce—these are the Oriental and the Occidental, the Indian and the American cottons. The botanical characteristics, though slight, are sufficiently marked to prevent the one being mistaken for the other,—the seed of the Eastern plant is never black or naked, and the curvature at the base of the leaf lobes is compounded of two opposite curves, and not purely heart-shaped as in the case of the Western plant. Numerous varieties of each



FIG. 1.—Cotton Plant.

type are to be found constituting distinct races of the same species, and affording ample scope for experimenters in their efforts for the improvement of the plant.

*Oriental, Asiatic, or Indian Cottons.*—All these, although the several varieties may be distinguished from one another, belong to the species designated by Linnaeus *Gossypium herbaceum*. There is one exception, however, to be made, and that is the singular purple-blossomed cotton-tree, the *Gossypium arboreum*, Linn., held sacred by the Hindus, known also as *Gossypium religiosum*, grown about the temples in India, which supplies the material for the sacerdotal tripartite thread of the Brahmans, the emblem of their Trinity. The plant has dark-green leaves, bears handsome red-purple blossoms, and produces silky cotton. Attempts have been made to improve its cultivation by hybridizing, and to bring it into general use, but hitherto without success, and it remains almost entirely unknown to commerce. With the exception, then, of this curious species, the numerous varieties of Indian cottons are but different forms of *Gossypium herbaceum*. One of these is cultivated to a considerable extent in the Levant, and is known in the market as Smyrna cotton. The different kinds of Indian cotton are usually included in the generic term *Surata*. The principal sorts are *Hingunghât*, *Oomravuttee*, *Brouch*, *Dhollera*, and *Dharwar*. The Hingunghât, which may perhaps be said to possess the highest qualities, stands at the head of the different descriptions grown in the Central Provinces and the Berars. The staple is of moderate length and strength, white, soft, and silky, and well

adapted for spinning. Dharwar, in the southern part of the Bombay Presidency, is the only district in India where exotic cotton has been successfully cultivated; the variety grown is chiefly acclimatized American cotton, from seed of the New Orleans species, *Gossypium hirsutum*. In the North-Western Provinces, Assam, and other parts of India, various kinds of cotton are grown, but none of them is of so much importance to the manufacturer as any of those already enumerated. The cottons produced in China and Central Asia also belong to the same species, but little or no supply is furnished for export to other countries.

*The Occidental or American Cottons.*—These, which have become known to the civilized world only since the discovery of America, consist of two great divisions—the *Barbadensian* or black-seeded cottons, bearing pure yellow blossoms, with a reddish-purple spot at the base of the petals, and the *Hirsute* or hairy cotton, more or less covered with a distinct clothing of hairs, bearing white or faintly primrose-colored blossoms. The two cannot always be distinguished from each other by the appearance of the seed, as the black-seeded cottons are occasionally found with a tuft of short hairs or fuzz at one or both ends, and the hairy, though generally downy all over, are also sometimes found with seeds black or naked. On this account some authorities have concluded that the two kinds belong to the same species—the *Barbadensian*; but carefully conducted experiments show that the variation in the seeds may be attributed to peculiarities of soil or cultivation, and that the specific characteristics of the two kinds remain unaltered generation after generation. The cottons most in demand among the manufacturers are those of the Western world, viz., the Sea Island and New Orleans or Uplands, varieties which are altogether unequalled by the products of any other part of the globe. The Sea Island plant in the soft maritime climate of the low-lying islands off the coast of Georgia, where frost is scarcely known, has surpassed all other descriptions of cotton in the strength, length, and beauty of its staple. The "Georgian Uplands" cotton, sometimes called "Bowed," is the result of attempts to cultivate Sea Island cotton on the uplands of Georgia. Sea Island cotton has also been successfully introduced into Queensland, the Fiji Islands, Tahiti, and Egypt. Of the other great Western cotton, the New Orleans, which is probably of Mexican origin, there are two principal varieties—one with green seeds and hardy constitution, the other with white, tawny, or greyish seeds, longer and more silky in staple. The New Orleans and Bowed cottons constitute the great production of the United States, and are known in English and European markets as "American cottons." The sowing time is March and April, and the crop is gathered from August to the end of the year, or even later in the absence of frost. There are several forms of this *Hirsute* or Orleans type, such as the Cuba Vine, a large and showy plant, another bearing yellow or brown stapled cotton used for nankeen cloths, and a third kind, producing the "Bourbon" cotton; but all these are more remarkable than useful. The fine Venezuela and the West Indian green-seeded cottons belong to the same race, the latter differing only by a faint blotch of purple at the base of the pale yellow petals. The black-seeded, long-stapled cottons (*G. barbadense*), though of the Sea Island type, are found in such diversified forms, and so widely spread over the different parts of the globe, that some of them have been classed as separate species. The Peruvian and the Brazilian may be adduced as instances; the latter, known by the name of "kidney" cotton, is remarkable for the curious arrangement of its seeds, eight or ten of which adhere together in compact kidney-shaped masses, but there is little else to distinguish it from other forms of black or naked seeded cottons. The various black-seeded cottons cultivated in Brazil, together with the Peruvian and some other descriptions, constitute the *Gossypium acuminatum* of Royle. Colonel Trevor Clarks has made the cotton plant his special study with a view to its improvement by hybridization, and it is to be hoped that ere long he may be induced to publish the results of his investigations.

*Cotton Ginning.*—The lobes in every boll of cotton contain seeds which, except when covered with down, resemble the coffee-berry, and which have to be separated from the fibre, by a process called "ginning." When this is done there remains of the bulk, as gathered from the tree, about one-third of clean cotton fit for manufacturing purposes.

and two-thirds of seed. The separation of the seed from the lint is accomplished by different methods. The most primitive as well as the most rude and simple machine employed is the churka used by the Chinese and Hindus, and known in Italy under the name of manganello. It consists of two wooden rollers fixed in a frame and revolving in contact, between which the cotton is drawn to the exclusion of the seeds. Though various attempts have been made to increase the efficiency of the churka, which is still extensively used in India, there has been but little real improvement, and it is found impossible to clean cotton rapidly by means of it. Hence ginning establishments with machines worked by steam power have now been introduced into the principal cotton districts of India. In the year 1792 Eli Whitney, an American, produced his saw gin, the machine which, under various modifications, is still employed for cleaning the greater proportion of the cotton grown in the Southern States. It consists of a series of saws revolving between the interstices of an iron bed upon which the cotton is placed so as to be drawn through whilst the seeds are left behind. As the fibre of the long-stapled cottons was found to be injured by the action of the saws, and to be more or less cut or "nepped," another more recent American invention, the Macarthy gin, has come into use for cleaning Sea Island, Egyptian, and Brazilian cotton. The fibre is drawn by a leather roller between a metal-plate called the "doctor," fixed tangential to the roller, and a blade called the beater, which moves up and down in a plane immediately behind and parallel to the fixed plate. As the cotton is drawn through by the roller the seeds are forced out by the action of the movable blade, which in some machines is made to work horizontally instead of vertically. Attempts continue to be made so to improve both the saw gin and the roller gin as in the one case to prevent injury to the staple, and in the other to increase the efficiency or capability of the machine to clean large quantities of cotton quickly. The "needle" saw gin is a recent invention intended to prevent the fibre from being cut. It consists of steel-wire set in block tin with the bottom of the teeth rounded or made smooth. On the other hand the double-action Macarthy gin, with two movable blades or beaters, the "knife-roller" gin, the "lock-jaw" gin, and others have appeared as rivals to the saw gin. The machine which will clean the largest quantity in the shortest space of time is naturally preferred, unless such injury is occasioned as materially to diminish the market value of the cotton. This has sometimes been the case to the extent of 1d. or 2d. per lb, and even more as regards Sea Island or long-stapled cottons. The production, therefore, of the most perfect and efficient cotton-cleaning machinery is of importance alike to the planter and the manufacturer, and although considerable improvement has already been effected, there is still room for further efforts in the same direction. The seed obtained in ginning that is not required for sowing, comprising many thousands of tons, is pressed for oil, which when refined is in some cases used to mix with olive oil, or is converted into cake for feeding cattle, or into a material for making paper, whilst the ultimate residuum, or refuse, is made into soap. Even the stalks of the cotton plant are made to answer some valuable purposes. Besides being used for thatch and baskets, a fibre is obtained that can be converted into gunny and other kinds of cloths, equal to those manufactured from jute. They furnish also a material that can be used for the manufacture of the common kinds of paper. The cotton when cleaned or separated from the seed is pressed, chiefly by hydraulic power, into bales varying in weight in different countries, and in this state it is ready for market and for the various processes of manufacture.

**Sources of supply.** *Cotton Supply.*—The capability of the world to furnish in sufficient abundance the raw material required by the vast and ever-expanding cotton industry has from time to time, and under the pressure of dire necessity, been well ascertained. Happily it has been found possible to cultivate cotton over almost the whole of the intertropical and in many of the temperate portions of the globe, so that if from any cause there should be a deficiency in one part this may be compensated by the superabundance in others. The most ancient cotton-growing country is probably India. For five centuries before the Christian era cotton was largely used in the domestic manufactures of India; and the clothes of the inhabitants then consisted as now chiefly of

garments made from this vegetable product. More than two thousand years before Europe or England had conceived the idea of applying modern industry to the manufacture of cotton, India had matured a system of hand-spinning, weaving, and dyeing which during that vast period received no recorded improvement. The people, though remarkable for their intelligence whilst Europe was in a state of barbarism, made no approximation to the mechanical operations of modern times, nor was the cultivation of cotton either improved or considerably extended. Possessing soil, climate, and apparently all the requisite elements from nature for the production of cotton to an almost boundless extent, and of a useful and acceptable quality, India for a long series of years did but little towards supplying the manufacturers of other countries with the raw material which they required. Between the years 1788 and 1850 numerous attempts were made by the East India Company to improve the cultivation and to increase the supply of cotton in India, and botanists and American planters were engaged for the purpose. One great object of their experiments was to introduce and acclimatize exotic cottons. Bourbon, New Orleans, Upland Georgia, Sea Island, Pernambuco, Egyptian, &c., were tried but with little permanent success. The result of these and similar attempts, more recently made, has been to establish the conclusion that efforts to improve the indigenous cottons are most likely to be rewarded with success. As will be seen from the table showing the imports of cotton into Great Britain, on a subsequent page, the largest supply obtained from India prior to the American civil war was in 1857, being upwards of 680,000 bales, of the value of £5,458,426; but in 1866, owing to the efforts employed to increase the production of cotton, the import from India had reached a total of 1,847,760 bales, of the value of £25,270,547. The quantity now obtained from India averages something over one million of bales annually, being the largest supply procured from any one country with the exception of America. The cultivation of cotton is not so remote a date in China as in India. In the accounts of the revenues and of the arts of China during the period of the celebrated dynasty which commenced about 1100 years before the Christian era, and lasted for some centuries, no mention is made of the cotton plant; nor, indeed, is there any notice of cotton in these records until about 200 years before the Christian era; from which period to the 6th century the cotton cloth, which was either paid in tribute, or offered in presents to the emperors, is always mentioned as a thing rare and precious. The annals record as a singular circumstance that the Emperor Ou-ti, who ascended the throne in 502, had a robe of cotton. In the 7th century we find the cotton plant mentioned, but its cultivation appears to have been then confined to gardens; and the poems and romances of that period are occupied in celebrating the beauty of its flowers. It was in the 11th century that the cotton plant was first removed from the gardens to the fields, and became an object of common culture; and it is only from this period that we can date the commencement of the manufacture in China. The cotton tree was introduced into that country at the time of its conquest by the Mongol Tartars in the year 1280; after which period every encouragement was given by the Government to the culture and manufacture of cotton. Considerable difficulties, however, were at first encountered through the prejudices of the people and the opposition of those engaged in the manufacture of woollen and linen; and it was not until the year 1368 that they were altogether surmounted. After that date rapid progress was made, and cotton has ever since supplied the material manufactured for the clothing of a large proportion of the population of China. The Chinese, in addition to their own growth of cotton, obtain large imports from India and the Burmese territories. A famine which happened in China about the close of the 18th century induced the Government to direct, by an imperial edict, that a greater portion of the land should be devoted to the cultivation of grain. Since then the importation of cotton from India has been considerable, though but a small part of that which is consumed in their manufactures. China, indeed, was never a source of supply to other countries, excepting to a small extent and for a brief period, when the whole world was ransacked to meet the exigences of the cotton famine.

Central and South America and the West Indies,

though now but comparatively insignificant sources of supply, were formerly of much greater importance. On the conquest of Mexico, in 1519, it is said that Cortes received garments of cotton as presents from the natives of Yucatan, as well as cotton cloths for coverings to his huts; and the clothing of the Mexicans was found to consist chiefly of cotton. In Peru raw cotton and cotton fabrics have long been known to exist, and specimens from the ancient Peruvian tombs were at an early period brought to Europe for exhibition. In the time of the Incas, in 1532, there is evidence that the plant was successfully cultivated; and the tree-cotton of Peru has often attracted attention, and been made the subject of examination for the purpose of determining whether it is the veritable *Gossypium arboreum* of Linneus. It is represented to be not only exceedingly beautiful, but valuable on account of its abundant crops. It yields largely for four or five years, and may be maintained for eight or ten years without being renewed. The *Gossypium peruvianum* or *acuminatum*, cultivated in the coast valleys of Peru, is an arborescent kind growing to 10 or 15 feet in height. It produces the cotton of Brazil, Pernambuco, Maranhão, Peru, &c. The Anguilla cotton, better known as Sea Island, is represented to be a native of Honduras; it spread thence to the West Indies, and was carried to the United States shortly after the Revolution. The West Indies, before the present century, was the chief source from which England derived the cotton then required. The finest ever brought to the English market, or probably ever grown, was raised in the island of Tobago between the years 1789 and 1792 upon the estate of Mr. Robley. The West Indian cottons have generally been highly esteemed, but the cultivation has been neglected for the sake of sugar, which was found to be a more profitable crop.

Amongst the countries which in more recent times have become prominent for the supply of cotton, Egypt deserves to be specially mentioned, furnishing a staple which for quality and length holds a high rank and comes next to Sea Island. Cotton was doubtless grown in Egypt at a very remote period, but was cultivated only to a small extent, and chiefly for home consumption, before the early part of the present century, when the inferior indigenous was superseded by the present exotic plant, the produce of which has obtained a high reputation. Its introduction was due to Mahd Bey, who had been governor of Dongola and Sennaar, and had brought seed of the plant with him from Ethiopia. In his garden at Cairo it was discovered about the year 1820, by a Frenchman named Jumel, in the service of Mehemet Ali. That sagacious ruler saw the advantages likely to accrue from the cultivation of a product suited to the soil and climate of the country, and which was in great and growing demand. His measures were carried out with such energy, and upon such a scale, as to enable him so early as 1823 to export to England 5623 bales of this new description of cotton. Jumel, who had resided for some years in America, and had some acquaintance with cotton, after some not very satisfactory first essays in cotton-growing, associated himself with a Cairo merchant, and commenced a small plantation near the obelisk of Heliopolis. His efforts proving highly successful, he was at length entrusted with the control of the viceroy's cotton plantations, which became immensely profitable under his direction. The new description of Egyptian cotton has since been known by the name "Jumel" in France, and "Mahd," or "Mako," in England. Its cultivation has rapidly extended throughout Lower Egypt, the soil as well as the climate being found to be specially favorable. The scantiness of the population, and the difficulty of providing adequate supplies of food, seem the only causes likely to curtail the production of cotton. The thickly populated inverted alluvial delta of the Soudan, between the Blue and the White Nile, is said to be even more favorable to the growth of cotton than the lower parts of the valley, and to afford room for the plantation of ten times the area obtainable in Egypt proper. It is not, perhaps, too much to say that Egypt is the finest cotton-growing country in the world; it is not surpassed in productiveness even by the Southern States of America. So firmly is the growth of cotton established, and so fully are both the Government and the people alive to its importance and advantages, that there is no reason to apprehend that it will be allowed

to decline, or that Egypt will ever lose its position as a source of supply. It will be seen from the table of imports on page 431 that the Egyptian supply, which in 1859-60 was only about 100,000 bales, has since become nearly 300,000. The bales, too, have been increasing in size, and now contain six cantars, or about 600 lb each.<sup>1</sup>

The growth of cotton in Turkey, as elsewhere, Turkey was greatly stimulated and increased during the time of scarcity, but it has since declined largely on account of the feebleness of the Government and the corruption of its agents, and the expectations once entertained have not been fulfilled. The country possesses, however, splendid cotton-growing capabilities, and might be made a very prolific source of supply. Much of the cotton produced is taken by Continental manufacturers. From Brazil cotton of excellent quality has long been obtained, and in various provinces of that vast empire its cultivation has for many years been a favorite and profitable branch of agriculture. The plant thrives in all the varied climates from Para in the north down to Rio Grande in the south, and requires scarcely any care to guard it either from sun or frost. Owing to the demands occasioned by the cotton famine, cotton was for the first time grown for export in the province of São Paulo; and the experiments commenced in 1861 with some New Orleans seed sent out from England by the Cotton Supply Association, and freely distributed, became the means of procuring from this one province a quantity as large as had been received from the whole of Brazil in any year previous to the American civil war. This cotton, known as "Santos" in the market, has been steadily growing in favor with the manufacturer. The rank which Brazil holds amongst the countries from which cotton is imported may be ascertained by reference to the table already mentioned. From several other sources, such as Italy, the Cape of Good Hope, Natal, and other parts of Africa, Queensland, Australia, Fiji, Tahiti, &c., smaller supplies of cotton are obtained, but they are all of minor importance.

These and all others, whether large or small, dwindle into insignificance when compared with America, which is *par excellence* the great cotton-producing country of the world. About the year 1770<sup>2</sup> the planters in the Southern States of the American Union began to turn their attention to the production of cotton; and besides carrying the cultivation to a great extent, they introduced qualities before unknown. The supplies continued to be small up to the end of the century. In 1792 the quantity exported from the United States was only 138,324 lb, but by the year 1800 it had increased to nearly 18,000,000 lb. At the close of the war in 1815 the revival of trade led to an increased demand, and the progress of cotton cultivation in America became rapid and continuous, until at length about 85 per cent. of the raw material used by English manufacturers was derived from this one source. With a capacity for the production of cotton almost boundless, the crop, which was so insignificant when the century began, had in 1860 reached the enormous extent of 4,824,000 bales. This great source of supply, when apparently most abundant and secure, was shortly after suddenly cut off, and thousands were for a time deprived of employment and the means of subsistence. In this period of destitution the cotton-growing resources of every part of the globe were tested to the utmost; and in the exhibition of 1862 the representatives of every country from which supplies might be expected met to concert measures for obtaining all that was wanted without the aid of America. The colonies and dependencies of Great Britain, including India, seemed well able to grow all the cotton that could be required, whilst numerous other countries were ready to afford their co-operation. A powerful stimulus was thus given to the growth of cotton in all directions; a degree of activity and enterprise never witnessed before was seen in India, Egypt, Turkey, Greece, Italy, Africa, the West

<sup>1</sup> The discovery of a new variety of cotton plant said to be much more prolific than any previously known in Egypt, has just been reported from that country.

<sup>2</sup> It is related that in the year 1764 William Rathbone, an extensive American merchant in Liverpool, received from one of his correspondents in the Southern States a consignment of eight bags of cotton, which on its arrival in Liverpool was seized by the custom-house officers, on the allegation that it could not have been grown in the United States, and that it was liable to seizure under the Shipping Acts, as not being imported in a vessel belonging to the country of its growth. When afterwards released, it lay for many months unsold, in consequence of the speculators doubting whether it could be profitably worked up.



India, Queensland, New South Wales, Peru, Brazil, and in short wherever cotton could be produced; and there seemed no room to doubt that in a short time there would be abundant supplies independently of America. But ten years afterwards, in the exhibition of 1872, which was specially devoted to cotton, a few only of the thirty-five countries which had sent their samples in 1862 again appeared, and these for the most part only to bear witness to disappointment and failure. America had re-entered the field of competition, and was rapidly gaining ground so as to be able to bid defiance to the world. True, the supply from India had been more than doubled, the adulteration once so rife had been checked, and the improved quality

and value of the cotton had been fully acknowledged, but still the superiority of the produce of the United States was proved beyond all dispute, and American cotton was again king. Slave labor has disappeared, and under new and more promising auspices a fresh career of progress has been commenced. With a rare combination of facilities and advantages, made available with remarkable skill and enterprise, the production of cotton in America seems likely for a long series of years to increase in magnitude and importance.

Table I., below, shows the quantity of the raw material annually furnished to English manufacturers during the past three-quarters of a century by the chief sources

TABLE I.—Import, Export, and Stocks of Cotton in Great Britain in Thousands of Bales during the present Century; with the Annual Consumption in Millions of lbs., and the Weekly Average in Bales; also the Average Prices, &c.

Year.	IMPORTS.					EXPT.	STOCK, 31st Dec.		CONSUMPTION.				AVERAGE PRICES.				AMERICAN CROPS, EXPORTS, ETC.									
	America.	Brazil.	Egyptian, &c.	W. India, &c.	East India.		Total.	Liverpool.	Great Britain.	Total.	Average weight.	Total lb.	Weekly Average in Bales.	Middling Uplands.	Fair Fernam.	Fair Surat.	Crop.	Great Britain.	Continent.	Total.	North.	South.				
1801	84	70		92	14	260	315		16	8	...	129	226	215	45-4	4,330	18	33	16	...	...	...	...	...	...	
1802	107	75		91	8	281	215		16	8	...	154	249	215	51-6	4,610	18	30	14	...	...	...	...	...	...	
1803	107	75		96	10	239	225		7	7	...	148	240	225	54-0	4,610	12	26	11	...	...	...	...	...	...	
1804	104	69		86	4	242	255		2	2	...	141	243	255	62-4	4,710	14	28	11	...	...	...	...	...	...	
1805	134	51		75	2	252	235		4	4	...	138	250	235	68-7	4,510	16	26	14	...	...	...	...	...	...	
1806	123	51		78	8	262	217		8	8	...	140	269	217	68-6	4,170	18	22	14	...	...	...	...	...	...	
1807	171	19		81	11	282	264		10	10	...	50	121	280	54-8	4,380	14	21	13	...	...	...	...	...	...	
1808	88	20		67	13	168	360		6	6	...	25	71	210	54-6	4,040	22	28	19	...	...	...	...	...	...	
1809	160	141		103	86	440	211		19	19	...	80	192	309	211	63-3	4,770	20	25	18	...	...	...	...	...	...
1810	247	143		92	79	561	236		4	4	...	150	375	334	236	78-8	6,420	15	22	15	...	...	...	...	...	...
1811	128	118		65	15	226	280		6	6	...	185	355	350	280	98-9	6,790	12	19	12	...	...	...	...	...	...
1812	95	99		64	3	261	232		8	8	...	85	280	328	232	78-1	6,310	16	22	14	...	...	...	...	...	...
1813	38	137		73	2	260	205		21	21	...	56	165	344	205	70-5	6,610	23	27	17	...	...	...	...	...	...
1814	49	151		75	13	288	210		26	26	...	82	114	313	210	65-7	6,000	20	27	17	...	...	...	...	...	...
1815	203	91		53	22	369	259		86	70	...	113	354	248	322-2	6,420	20	28	17	...	...	...	...	...	...	
1816	166	123		49	31	369	266		29	47	...	116	337	263	387-7	6,490	18	26	15	...	...	...	...	...	...	
1817	200	114		45	120	479	266		27	64	...	161	407	263	107-0	7,820	20	25	17	...	...	...	...	...	...	
1818	206	162		51	248	669	268		55	146	...	352	423	260	169-9	8,130	20	25	15	...	...	...	...	...	...	
1819	205	162		31	184	546	264		67	127	...	397	434	252	166-5	8,350	13	18	9	...	...	...	...	...	...	
1820	303	180		41	58	572	249		28	167	...	478	467	246	126-8	8,980	11	15	8	...	...	...	...	...	...	
1821	300	181		41	30	492	262		68	167	...	418	499	258	122-0	9,600	9	12	7	...	...	...	...	...	...	
1822	339	143		41	19	533	267		59	153	...	342	545	267	145-5	10,480	8	11	6	...	...	...	...	...	...	
1823	452	145	6	28	38	669	281		85	261	...	416	669	275	154-1	10,770	8	12	6	...	...	...	...	...	...	
1824	252	143	113	26	61	540	266		54	121	...	297	605	278	165-2	11,630	8	11	6	...	...	...	...	...	...	
1825	423	194	328	32	61	821	270		73	131	...	446	609	278	166-8	11,530	11	15	8	...	...	...	...	...	...	
1826	396	45	48	18	65	592	295		95	338	...	472	511	294	150-2	9,820	6	10	5	...	...	...	...	...	...	
1827	447	139	22	31	74	894	303		69	343	...	572	675	297	137-2	12,980	6	9	5	...	...	...	...	...	...	
1828	444	167	33	20	85	749	393		64	396	...	526	732	297	217-9	14,050	6	8	4	...	...	...	...	...	...	
1829	453	169	25	19	80	747	297		118	368	...	499	745	294	212-2	14,330	5	7	4	...	...	...	...	...	...	
1830	618	191	15	12	35	871	300		83	253	...	415	832	298	247-7	16,000	6	8	5	...	...	...	...	...	...	
1831	609	168	38	11	77	908	310		75	312	...	386	856	306	262-7	16,500	6	7	4	...	...	...	...	...	...	
1832	629	115	41	8	109	902	319		67	198	...	330	891	311	276-9	17,140	6	8	5	...	...	...	...	...	...	
1833	655	163	4	13	95	930	327		68	181	...	300	869	326	367-9	16,920	3	10	6	...	...	...	...	...	...	
1834	734	194	7	17	89	951	337		87	145	...	346	919	339	303-4	17,470	3	11	6	...	...	...	...	...	...	
1835	763	143	44	23	115	1091	331		103	185	...	280	954	338	311-1	18,350	10	13	7	...	...	...	...	...	...	
1836	763	149	35	33	219	1291	342		166	206	...	364	1011	343	347-4	19,450	9	12	6	...	...	...	...	...	...	
1837	845	117	41	28	145	1176	347		128	171	...	359	1176	346	365-7	20,330	7	10	4	...	...	...	...	...	...	
1838	1026	126	30	29	107	1429	350		103	248	...	471	1207	346	416-7	22,200	7	9	4	...	...	...	...	...	...	
1839	815	99	33	36	133	1116	348		117	306	...	355	1114	343	367-1	21,430	7	10	6	...	...	...	...	...	...	
1840	1286	86	38	22	166	1598	365		120	346	...	584	1251	367	458-9	24,060	6	9	4	...	...	...	...	...	...	
1841	902	94	41	33	274	1344	355		116	430	...	619	1192	367	531-1	22,930	6	8	4	...	...	...	...	...	...	
1842	1013	87	49	17	256	1393	379		134	457	...	674	1160	375	455-1	22,130	6	7	4	...	...	...	...	...	...	
1843	1307	98	29	18	182	1744	382		120	554	...	921	1367	379	517-8	26,290	4	6	3	...	...	...	...	...	...	
1844	1247	113	67	17	238	1632	388		187	750	...	1037	1429	381	544-0	27,470	4	6	3	...	...	...	...	...	...	
1845	1580	119	82	9	155	1856	398		123	868	...	1195	1674	385	606-0	30,230	4	6	3	...	...	...	...	...	...	
1846	932	84	60	9	49	1134	386		194	439	...	659	1586	387	614-3	30,500	4	6	3	...	...	...	...	...	...	
1847	874	110	21	5	223	1233	377		222	365	...	512	1198	381	441-4	22,260	6	7	4	...	...	...	...	...	...	
1848	1376	100	29	8	228	1740	395		190	393	...	599	1464	394	676-6	26,150	4	5	3	...	...	...	...	...	...	
1849	1478	164	73	9	182	1905	396		254	468	...	659	1590	396	629-9	30,550	5	5	3	...	...	...	...	...	...	
1850	1184	172	79	6	305	1749	392		272	455	...	622	1514	388	688-2	26,120	7	7	4	...	...	...	...	...	...	
1851	1394	109	67	5	329	1904	399		268	424	...	594	1668	396	558-9	31,990	5	7	4	...	...	...	...	...	...	
1852	1799	144	199	18	221	2357	392		363	578	...	807	1861	397	730-6	35,790	5	6	4	...	...	...	...	...	...	
1853	1532	133	305	9	485	2264	398		350	597	...	817	1904	400	769-9	36,610	5	6	4	...	...	...	...	...	...	
1854	1666	107	81	10	308	2172	408		317	551	...	706	1967	304	776-1	37,830	5	6	4	...	...	...	...	...	...	
1855	1623	115	9	9	396	2278	396		317	429	...	566	2101	399	839-1	46,400	5	6	4	...	...	...	...	...	...	
1856	1708	122	114	11	463	2468	414		309	261	...	493	2183	408	801-4	41,990	5	6	4	...	...	...	...	...	...	
1857	1482	189	76	11	680	2418	404		337	400	...	543	2081	406	826-0	39,060	7	8	5	...	...	...	...	...	...	
1858	1389	106	106	6	361	2442	420		349	349	...	462	2175	417	905-6	41,820	6	8	5	...	...	...	...	...	...	
1859	2036	125	101	7	511	2823	421		436	442	...	559	2297	424	976-6	44,170	6	8	5	...	...	...	...	...	...	
1860	2341	108	169	10	563	3356	424		608	548	...	794	2323	429	1063-6	48,320	5	8	5	...	...	...	...	...	...	
1861	1941	106	96	10	887	3006	415		677	623	...	789	2344	436	1007-4	45,450	5	8	5	...	...	...	...	...	...	
1862	73	134	147	20	1072	1445	369		565	392	...	484	1185	381	451-7	22,790	17	18	12	...	...	...	...	...	...	
1863	132																									

of supply. The table also contains a statement of the exports, the annual consumption, the average prices, and the stocks at the end of each year, as well as details of the American produce, exports, &c.

The statement embodied in Table II., below, issued

under the authority of the Liverpool Cotton Brokers' Association, shows the total American crop (including Sea Island produce), the stock in the ports, and the total supply from 1826-27 to 1875-76. Table III. gives the appropriation of the American crops.

TABLE II.—Total American Crops (in Bales) from 1826-27 to 1875-76.

Years.	Total Crop.	Stock in the Ports at commencement of Season.	Total Supply.	Years.	Total Crop.	Stock in the Ports at commencement of Season.	Total Supply.
1826-27	957,281	...	957,281	1850-51	2,415,257	167,930	2,583,187
1827-28	720,593	...	720,593	1851-52	3,098,029	128,304	3,218,333
1828-29	857,744	...	857,744	1852-53	3,352,882	91,176	3,444,058
1829-30	976,845	16,562	993,407	1853-54	3,035,027	135,643	3,170,670
1830-31	1,038,847	20,898	1,059,745	1854-55	2,932,339	135,603	3,067,942
1831-32	987,477	119,423	1,106,900	1855-56	3,645,345	143,336	3,788,681
1832-33	1,070,438	41,599	1,112,037	1856-57	3,056,519	64,171	3,120,690
1833-34	1,205,394	48,205	1,253,599	1857-58	3,238,962	49,258	3,288,220
1834-35	1,254,323	29,617	1,283,945	1858-59	3,994,481	102,926	4,097,407
1835-36	1,360,725	41,623	1,402,348	1859-60	4,823,770	149,237	4,973,007
1836-37	1,425,575	43,341	1,468,916	1860-61	3,826,086	227,708	4,053,794
1837-38	1,804,797	75,820	1,880,617	1861-65	...	...	...
1838-39	1,363,403	40,305	1,403,708	1865-66	2,314,476	243,125	2,562,601
1839-40	2,181,749	52,244	2,233,993	1866-67	2,204,089	282,439	2,486,528
1840-41	1,639,353	58,442	1,697,795	1867-68	2,498,895	80,216	2,579,111
1841-42	1,688,675	82,068	1,770,743	1868-69	2,439,039	38,130	2,477,169
1842-43	2,394,203	31,807	2,426,010	1869-70	3,154,946	12,343	3,167,289
1843-44	2,108,579	94,486	2,203,065	1870-71	4,352,317	59,747	4,412,064
1844-45	2,484,662	159,772	2,644,434	1871-72	2,974,351	104,814	3,079,165
1845-46	2,170,537	94,126	2,264,663	1872-73	3,930,508	54,521	3,985,029
1846-47	1,860,479	107,122	1,967,601	1873-74	4,170,388	90,989	4,261,377
1847-48	2,434,113	214,837	2,638,950	1874-75	3,832,991	108,152	3,941,143
1848-49	2,808,596	171,468	2,980,064	1875-76	4,669,388	66,059	4,735,347
1849-50	2,171,706	154,753	2,326,459				

TABLE III.—Showing the Appropriation of the entire Crop of Cotton raised in America.

Years.	DISTRIBUTION IN AVERAGE PERIODS OF FIVE YEARS.					Taken by American Spinners North and South.	Total Deliveries.	PROPORTIONAL DISTRIBUTION.					Taken by American Spinners North and South.	Years.
	EXPORT.							EXPORT.						
	Great Britain.	France.	North Europe.	Other Ports.	Total.			Great Britain.	France.	North Europe.	Other Ports.	Total.		
1826-31...	556,663	163,822	42,374		762,859	122,183	885,042	62-90	18-51	4-79	86-20	13-90	1826-31	
1831-36...	703,690	229,962	38,641	13,154	985,447	204,099	1,189,546	59-16	19-33	3-25	1-10	82-94	17-16	1831-36
1836-41...	983,978	324,137	64,113	39,376	1,401,604	268,080	1,669,684	58-94	19-41	3-24	2-38	83-95	16-05	1836-41
1841-46...	1,229,903	349,208	97,599	94,380	1,771,085	390,324	2,161,409	56-90	16-16	4-51	4-37	81-94	18-06	1841-46
1846-51...	1,243,632	295,980	112,629	129,207	1,781,238	548,538	2,329,821	53-37	12-70	4-84	5-53	76-44	23-56	1846-51
1851-56...	1,696,092	422,546	188,856	190,478	2,498,002	720,686	3,218,688	52-70	13-13	5-88	5-91	77-60	22-40	1851-56
1856-66...	2,020,549	483,141	260,455	189,106	2,953,251	826,825	3,780,076	53-45	12-78	6-89	5-00	78-12	21-88	1856-66
1866-70...	1,234,359	237,634	144,107	63,094	1,679,134	874,860	2,553,994	48-34	9-30	5-64	2-46	65-74	34-26	1866-70
1870-75...	1,897,833	261,245	893,696	113,172	2,665,946	1,183,543	3,849,489	49-30	6-79	10-22	2-94	69-25	30-75	1870-75
1875-76 (1 year.)	2,080,711	456,872	498,249	217,102	3,252,934	1,362,889	4,615,383	45-08	9-90	10-80	4-70	70-48	29-52	1875-76 (1 year)

COTTON MANUFACTURE AND TRADE.

The manufacture of cotton had its origin in the East, where the cotton plant is indigenous, and where the climate renders a light and absorbent fabric a suitable clothing for the people. It has in consequence been long established over every part of Asia, although it was only in India that the fabric was manufactured extensively with a view to foreign exchange.

Arrian mentions cotton cloth among the commodities which the Romans brought from India; but the quantity imported by them was inconsiderable, from the preference which they gave to woollen clothing. The difference between ancient and modern Indian imports appears to have arisen, not from any diversity in the nature of the goods produced in that country, but from variety in the tastes or in the wants of the nations with which it has traded.

The implements used by the Indians in the different processes of the cotton manufacture, from the cleaning of the wool to its conversion into the finest muslin, may be purchased for the value of a few shillings, and are of so rude and simple a construction as to be evidently the invention of a very early period. With the exception of the loom, none of them deserves the name of a machine, or displays the slightest mechanical ingenuity. They spin the yarn upon the distaff; and yet, with all the advantages which we in this country derive from machinery, we have only recently been able to equal, either in fineness or quality, the yarn which is produced by means of this primitive instrument. The well-managed use of the finger and thumb of the Indian spinner, patiently and carefully

applied in the formation of the thread, and the moisture at the same time communicated to it, are found to have the effect of incorporating the fibres of the cotton more perfectly than can be accomplished by our most improved machines.

The loom is composed of a few sticks or reeds, which the Indian carries about with him, and puts up in the fields under the shade of a tree, or at the side of his cottage. He digs a hole large enough to contain his legs and the lower part of the "geer," and fastens the balances to some convenient branch overhead. Two loops underneath the geer, in which he inserts his great toes, serve as treadles; and he employs the shuttle, formed like a large netting needle, but of a length somewhat exceeding the breadth of the cloth, as "battoon," using it alternately to draw through the weft and strike it up. The reed is the only part of the weaving apparatus which approaches, in the perfection of its construction, to the instruments we use. The loom has no beam, and the warp is laid out upon the ground the whole length of the piece of cloth. The weavers live entirely in villages, as they could not, if shut up in towns, work in this manner.

It is probable that the whole of the implements which have just been described existed as we now find them before the people of India were divided into castes. The transmission of the same employment from father to son (which is the invariable practice in India), while it has the effect of conveying unimpaired the knowledge acquired in any art, tends to check its farther advancement. To the same cause, however, which thus prevented improvement in India, is to be attributed that dexterity in his particular

employment which the Indian artisan possesses. From the earliest age he learns to spin and weave under the direction of his father; and having no hope or desire of advancement in any other line, he gains, through constant practice, that wonderful skill which may thus be considered almost as a family inheritance. To be able to manage his ill-constructed loom, even in the production of ordinary fabrics, he is obliged to acquire such a sleight of hand, that it is not surprising if, out of the multitude trained in this manner, a few should be found capable of producing those muslins which are said, when spread upon the grass, to appear like the gossamer web. From the superiority of these goods, and from their retaining the beauty of their appearance longer than European muslins, it has been supposed that the cotton of which they are made is of better quality than any known to the European manufacturers. This, however, is a mistake; there is no cotton in India of a quality superior to the best Sea Islands.

As the largest country in the world producing cotton, it was reasonable to expect that India would also at an early period engage in its manufacture, and to such a degree of perfection was this branch of industry carried, that some of the fabrics produced have never been equalled, and have attained a world-wide celebrity. The kind of manufacture for which Manchester is famous bears a name which indicates its Eastern origin, and Calicut has supplied the designation of our English calico. Formerly the East India Company was in the habit of making a great part of its remittances in manufactures, and actually advanced, through its resident, the funds required to enable the workmen to produce the goods. The resident, when not engaged in providing goods for the Company's investment, was authorized to employ the weavers on his own account. This state of things, which was often attended with abuses, has disappeared, and for a long period British manufactured cottons have been largely imported into India. Common muslins were made in every village throughout the Peninsula. Orme says, "When not near the high road or a principal town, it is difficult to find a village in which every man, woman, and child is not employed in making a piece of cloth." The very fine muslins made at Dacca, and which were of such exquisite texture as to be poetically designated "webs of woven wind," were intended chiefly for the use of the potentates of the country, who kept agents to superintend the workmen employed in the manufacture; but since the assumption by Government of the territories of these Indian princes, the demand has fallen off, and a considerable part of the population have betaken themselves to the cultivation of indigo. The cotton from which the Dacca muslins are woven grows in a district of not more than forty miles in length by three in breadth, and in so limited a quantity as never to have become an article of commerce.<sup>1</sup> Long cloths and fine pullicats were made in the Madras Presidency, coarse piece goods and pullicats in Surat, the finest calicoes at Masulipatam, and table-cloths of a superior quality at Patna.

The apprehension often expressed that the inhabitants of India, in possession of the raw material, would, by the introduction of machinery, and by their cheaper labor and superior manual dexterity, be enabled some day to undersell us so as greatly to injure, if not to ruin, and put an end to the Indian demand for English manufactures, has to some extent been realized. The most important industry in the Bombay Presidency is now the manufacture of cotton cloth and yarn. Whilst this has always existed in nearly every village, it is only in recent years that steam spinning and weaving mills have been introduced. The first factory was started in 1863 at Kurla, Bombay, and in 1874 the number had increased to thirteen in the town and island, employing 60,000 spindles and 848 looms. These, together with other mills at Surat, Broach, and Ahmedabad, with an aggregate of 405,000 spindles and 4500 looms, had furnished employment for 10,000 people. Since then

<sup>1</sup> The wool is equal in fineness to the very best Sea Islands, and of still stronger staple, but so short as to preclude the possibility of its being spun by our machinery. The district in which the cotton is grown is stated to be periodically overflowed. The yarn is of different grades, the coarsest greatly finer than the highest number spun in England (No. 250), while the finest has been rated by an experienced spinner to be not under 350. How this yarn can be spun by the distaff and spindle, or woven afterwards by any machinery, is almost beyond conception. Machine-spun cotton yarn has, however, more recently been produced in Manchester which very greatly exceeds in fineness any yarn ever known to have been produced by the hand labor of India.

the number has been still further increased both in Bombay and other parts of the country, as well as in the presidencies of Bengal and Madras, and in some of the native states. It is probable that at present there are nearly 1,250,000 spindles and upwards of 10,000 looms employed in the various mills scattered over different parts of the country. Encouraged by the protective import duty on foreign manufactures, the number of mills is constantly on the increase, and the English trade in certain heavy and coarse descriptions of goods has consequently sustained serious injury. The import duty on English manufactures has been repeatedly condemned by Government, and its abolition has been expressly promised, but it is still retained for the convenient season when the Indian treasury shall be able to dispense with this small source of revenue. Meanwhile, new mills, supported to a large extent by English capital, and fitted with English machinery, such as that recently established at Nagpore, are constantly springing up, which will doubtless, under all changes, obtain a share of the trade of the country, and will not probably be seriously injured by the free importation of English manufactures. They have an advantage both in their proximity to the raw material and in the cheapness of native labor. The manufacture of cotton cloth has long been diffused all over the Central Provinces, hand-loom may be found at work in every considerable village, and the agricultural and laboring classes have hitherto preferred the home manufactures to any other. The increase of foreign importations, however, has led to a growing taste for English piece goods, and the productions of Indian mills have materially affected the local industry.

The cotton manufacture in China is of immense extent, and is carried on almost entirely China. for home consumption. Almost the only cotton goods exported from China are nankeens. Owing to greater encouragement on the part of the Government, and a less rigid adherence to ancient usages by the people, there has been considerable increase in native manufactures in China; and it will be seen from the table of exports that there has been a remarkable increase in the extent and value of English trade with that country during recent years. In this trade we have now to encounter American competition, which, however, is less formidable than it might be, on account of the protective policy of the United States.

In the interior of Africa, Clapperton and Landers found that cotton was not only grown but Africa. also spun and made into cloth. It would be interesting to know the methods which the natives have adopted, and from what source they obtained their acquaintance with the art of weaving. The settlers in Liberia appear to have established a communication across the country with Timbuctoo, and to have found there a market for cotton cloths. Increased commercial intercourse with the interior of Africa, and the opening up of markets there for British manufactures, are still objects to be earnestly pursued.

The manufacture of cotton goods in Europe First man-  
ufacture in  
Europe. is said to have been first attempted by the commercial states of Italy, before the discovery of the passage to India by the Cape of Good Hope. These enterprising communities were the entrepôts through which the cotton fabrics of India passed to the different markets of the West; and being situated in the neighborhood of countries where cotton was grown, and familiar with manufacturing processes, it is supposed that they were led to attempt the imitation of articles so much valued, and bringing so high a price. Another account assigns the introduction of the cotton manufacture into Europe to a later date, and gives to the people of the Low Countries the honor of having been the first manufacturers of these articles, in imitation of the cotton fabrics which the Dutch, about the beginning of the 17th century, began to import from India. But this last account cannot be correct; for Guicciardini in 1560, in a very full list which he gives of the different articles annually imported into and exported from Antwerp,<sup>2</sup> then the greatest commercial mart in Europe, specifies fustians and dimities of many fine sorts among the manufactured articles imported from Milan, and mentions cottons generally among those brought from Venice. But in the articles exported from Antwerp, although we find linens sent to almost every country, cotton cloth is not once mentioned. Italy, therefore, at that time had a cotton manufacture, which, it is probable, soon

<sup>2</sup> See Macpherson's *Annals of Commerce*.

after made its way to the Netherlands; for we know it was brought from the latter country to Britain by Protestant refugees about the close of the 16th or early in the 17th century.

That this manufacture was carried on in England at a pretty early period of the 17th century we know on good authority. Lewis Roberts in his *Treasures of Traffic*, published in the year 1641, says, "The town of Manchester buys linen yarn from the Irish in great quantity, and weaving it, returns the same again in linen into Ireland to sell. Neither does her industry rest here; for they buy cotton wool in London that comes from Cyprus and Smyrna, and work the same into fustians, vermilions, and dimities, which they return to London, where they are sold, and from thence not seldom are sent into such foreign parts, where the first material may be more easily had for that manufacture." These goods were woven chiefly about Bolton, and were purchased there at the weekly market by the Manchester dealers, who afterwards finished them, and either sent them to London for export, or sold them to their customers over the country.

At this period, and for a long time after, the weaver provided his own warp, which was of linen yarn, and the cotton wool for his weft; but as much time was lost in seeking these materials, agents for their sale were established in the different villages by the Manchester purchasers. Each weaver's cottage formed a separate and independent little factory. The yarn for his warp was bought by him in a prepared state, the wool for his weft was carded and spun by the female part of his family, and the cloth was woven by himself and his sons.

It would be impossible to enumerate all the descriptions of cotton goods which, in succession, were brought forward from the commencement of the manufacture.<sup>1</sup> The pattern cards of the principal houses in the trade, which were circulated from time to time through the kingdom, and over the continents of Europe and America, exhibited specimens of nearly two thousand kinds.

For the introduction and after improvement of many of these articles England is indebted to John Wilson of Ainsworth. This gentleman was originally a manufacturer of fustians at Manchester, but had early engaged in the manufacture of cotton velvets. His improvements in the mode of dressing, of finishing, and particularly of dyeing these goods acquired for them so high a character, that both in the home and foreign market his articles sold in preference to those of every other manufacturer. His plan for cleaning off the loose and uneven fibres was by the use of razors. He afterwards successively employed for this end, singeing by spirits of wine and the application of a hot iron resembling a weaver's drying iron. At a later period he effected his object by drawing the goods rapidly over a cylinder of cast-iron heated to redness, by which they were in a superior manner cleared of the down or pile which had been raised upon them in the various operations of weaving, washing, bleaching, or dyeing. Wilson having a turn for chemical inquiries, investigated the different known processes of dyeing; and by the improvements he introduced in the application of them to his own manufacture, materially advanced that art. The many valuable improvements introduced by Wilson into the different processes connected with the cotton manufacture had the effect not only of establishing it more firmly, but of rapidly enlarging its extent.

A considerable share of the calico-printing business was transferred, about the year 1760, from London to Lancashire, in consequence of the cheaper accommodation for carrying on the work, and the lower wages of the workmen. A fall in prices thereupon took place, which produced an increased demand for calicoes. These goods were at that time made of linen warp and cotton weft, it having been found impracticable, before Sir Richard Arkwright's discovery, to spin cotton warp of sufficient strength.

At this period the dealers from Manchester, in place of buying fustians and calicoes from the weaver, as had been

<sup>1</sup> The fustians that were made at this early period of manufacture were those denominated herring-bone, pillows for pockets and outside wear, strong cotton ribs and barragon, broad-raced linen thick-set and tufts, with whitened diaper, striped dimities, and jeans. At some distance of time there were added to these cotton thicksets, goods figured in the loom, and at a still later date cotton velvets, poliveteens, and strong and fancy corda.—(Aiken's *History of Manchester*.)

the practice before, began to furnish him with materials for the cloth, and to pay him a fixed price per piece for the work when executed. Along with the portion of linen warp, they gave him out a portion of cotton wool, which he was obliged to get spun into the weft he was to use. But so fast was the manufacture by this time outstripping the process of spinning, that it frequently happened that the sum which the master weaver was allowed by his employer was less than what he found himself obliged to pay to those whom he employed to spin it. He durst not, however, complain, much less abate the spinner's price, lest his looms should be unemployed. In this state of things, the further progress of the manufacture must have been stopped, if a more productive mode of spinning had not been discovered.

It has been said that the yarn produced at this time in England, by the one-thread wheel, the only spinning machine known, did not exceed in quantity what 50,000 spindles of our present machinery can yield. To have reared and trained hands sufficient to have doubled this quantity, had it been possible, must have been the work of a length of time, and the amount of the manufacture would still have been insignificant. A change in the system, therefore, had become indispensable; and we find that different ingenious individuals had already begun to employ themselves in contriving a better mode of spinning.

When we contrast the splendid inventions connected with the cotton manufacture, which from this period burst forth in rapid succession, with the passive acquiescence in the use of imperfect machinery during the long period which preceded, we are apt to ascribe these improvements to the circumstance alone of a number of men of genius having at that moment arisen, and to forget that the ultimate cause existed in the times calling their energies into action.

Already, about the year 1750, the fly-shuttle had been invented by Kaye of Bury—one of the most important steps in the progress of the art of weaving; and in the year 1760 improvements had begun to be made in the carding process.

James Hargreaves, a weaver of Stanhill, near Church, in Lancashire, an illiterate man, possessed of no great mechanical knowledge, had adapted the stock cards used in the woollen manufacture to the carding of cotton, and had besides greatly improved them. By this invention a person was able to do double the work, and with more ease than by hand carding. In the stock cards, one of the cards is fixed, whilst the other, being suspended by a cord over a pulley, is worked by the carder; and in this way two or three cards can be applied to the same stock.

This contrivance was soon succeeded by the cylinder cards, or carding engine. It is not ascertained who was the inventor of this valuable machine, but it is known that the father of the late Sir Robert Peel was among the first who used it, and that, so early as 1762, he, with the assistance of Hargreaves, erected a carding engine with cylinders at Blackburn. This machine did not differ materially from that now in use, except that it had no contrivance for detaching the cotton from the cards, an operation which was performed by women with hand cards.

There had been several unsuccessful attempts to improve the mode of spinning before 1767, when Hargreaves invented the "Spinning Jenny," patented in 1770. The idea of this machine is said to have been suggested to him by seeing a common spinning wheel, which had been accidentally overturned, continue its motion while it lay on the ground. After several unsuccessful attempts to carry into execution the conception he had formed, he succeeded in producing a rudely-constructed "jenny" of eight spindles, turned by bands from a horizontal wheel. In it the eight rovings were passed between two pieces of wood laid horizontally the breadth of the machine; and these, being grasped in the spinner's hand, and drawn out by him, formed the rovings into threads. The structure of this jenny was soon afterwards greatly improved, and it was at last brought to work as many as eighty spindles. This machine, although of limited power when compared with the beautiful inventions which succeeded it, must be considered as the first and leading step in that progress of discovery which carried improvement into every branch of the manufacture. The jenny of Hargreaves was very similar in its mode of working to the present "hand-twiner" or mule-doubler, the spindles being

mounted on a stationary carriage, and the "slide," or lock, receding from the spindles during the twisting of the threads, and returning to the spindle again during the winding on of the yarn. These hand-twiners are being rapidly replaced by self-acting twiners; but the type of Hargreaves's remains substantially the same as at first. His principle of drawing the fibre is still in universal use for carded wool.

Hargreaves's invention occasioned great alarm among those who earned their subsistence by the old mode of spinning, and even produced popular commotion. A mob broke into his house and destroyed his machine; and some time after, when a better knowledge of its advantages had begun to bring his spinning jenny into general use, the people rose a second time, and, scouring the country, broke to pieces every carding and spinning machine they could find. The jenny in a short time put an end to the spinning of cotton by the common wheel; and the whole wefts used in the manufacture continued to be spun upon that machine, until the invention of the "mule jenny," by which it was in its turn superseded.

While Hargreaves was producing the common jenny, Arkwright was employed in contriving that wonderful piece of mechanism, the spinning-frame, called first the water-frame, and afterwards the throstle, which, when put into motion, performs of itself the whole process of spinning, leaving to the workmen only the office of supplying the

roving or prepared material, and of joining or piecing the thread when it breaks. See ARKWRIGHT, vol. ii. p. 474. On Arkwright's removal to Nottingham he obtained from Messrs. Wrights, bankers there, and afterwards from Mr. Need of Nottingham and Strutt of Derby the assistance necessary to enable him to perfect his inventions and turn them to advantage, and in the year 1769 he obtained his patent for spinning with rollers. In 1772 his patent was contested, but a verdict was given in his favor, and his right to the exclusive use of the discovery remained afterwards undisturbed. Soon after his removal to Cromford, he followed up his first great discovery with other inventions for preparing the cotton for spinning, for which he took out another patent in the year 1775. But in 1781 his right to this patent was disputed; and judgment was finally given against him in November, 1785, and the patent cancelled. Arkwright's inventions for preparing the cotton, which are sometimes spoken of as the most wonderful parts of the process of spinning, do not appear so striking as the first effort of his genius. Although only to have been conceived by an original and fertile mind, they are still but improved arrangements of a machine previously in use, or suitable adaptations of his own spinning machine. But the power of Arkwright's mind was perhaps marked by nothing more strongly than the judgment with which, although new to business, he conducted the great concerns to which his discovery gave rise, and the systematic order and arrangement which he introduced

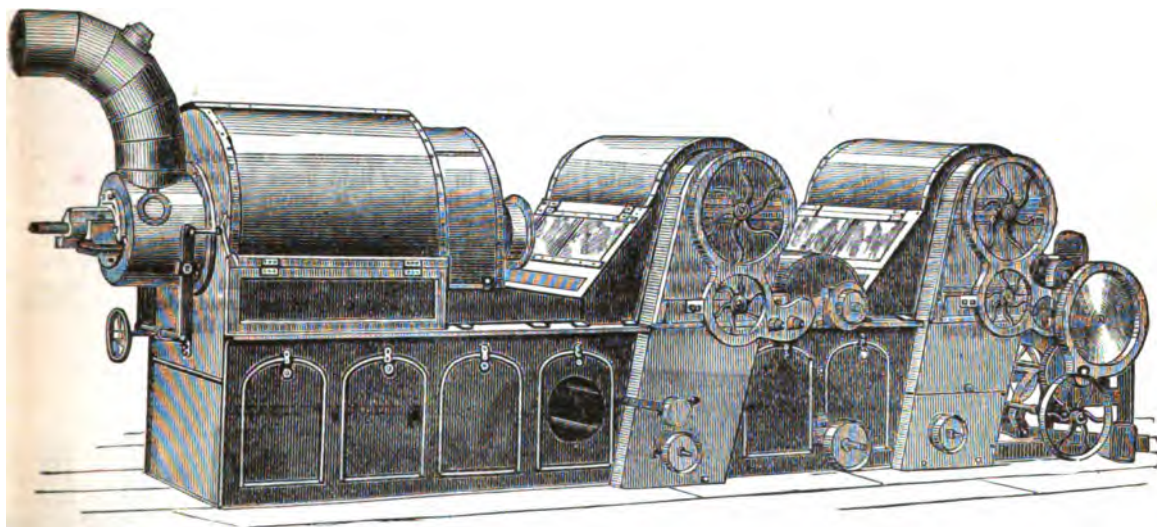

FIG. 2.—Opener.

into every department of his extensive works. His plans of management were universally adopted by others; and after long experience, they have not yet in any material point been improved.

#### Machinery.

The principal machines used in cotton spinning, taking them in the order in which they are employed, are the following:—The opener, scutcher and lap machine, carding engine, combing machine, drawing frame, slubbing frame, intermediate frame, and roving frame; the throstle, the self-acting mule and hand mule, doubling frame, and mule doublers or twiners. The first two are employed in the process of cleaning the raw cotton, and separating its matted flocks. In the lap machine it is fashioned into flat folds; in the carding machine it is carded and further cleaned and the fibres straightened; and in the drawing frame it is formed into a loose rope the fibres of which are laid parallel. In the slubbing frame it is slightly twisted; and in the intermediate and finishing frames it is still farther twisted, particularly in the higher numbers; but it is not yet yarn. The throstle frame is chiefly used for coarse warps: whilst upon the self-acting and hand mules both coarse and fine yarns are spun.

The OPENER.—In this machine the raw cotton is spread uniformly on a feeding table; from this it is taken by a pair of feeding rollers, and by them subjected to the action

of a beater. The beater consists of a cylinder bearing at intervals four or six rows of projecting teeth. It is 18 inches in diameter over the teeth, with an average of 40 inches in width, and when in motion makes 1400 revolutions in a minute. By an ingenious contrivance a strong draught of air is made to play through the newly-opened cotton, carrying away the dust and other foreign particles which adhere to it. This machine is capable of opening up about 15,000 lb of cotton in 56 hours. The cotton is carried forward between two perforated zinc or wire cylinders connected with the draught, the cotton being taken from another pair of feed rollers and a beater with two or three blades, and from this beater the cotton passes through a second pair of perforated cylinders, from which it is taken off by a pair of rollers and delivered to calendar rollers, and formed into laps for the scutcher. Various kinds of openers have been patented which differ in some respects from one another, each claiming to have some special advantage; of these Crichton's may be mentioned, and that of Lord Brothers (see fig. 2), which possesses an arrangement for drawing the cotton by means of a vacuum from places situated at long distances from the blowing room, and claims among other advantages that it will open up 25,000 lb per week of 56 hours. In this machine an ingenious contrivance presents the cotton to the cylinder by one roller working in a trough formed by a series of weighted levers. These reduce the risk of breaking the

fibre, and at the same time by moving a horizontal bar connected with a pair of cones acting upon the feed roller so regulate the supply of the cotton as to dispense with the necessity of weighing it, and make a more uniform lap.

The **SCUTCHER**, which has also a lap machine combined with it (fig. 4), in many respects resembles the opener. In some cases it is fed with cotton in a loose fleece, and in others, instead of the loose cotton, three or four laps are placed upon the feeder, and the beater or beaters are used in place of the cylinder. The cotton is further cleaned

and carried forward in the same manner as in the opener, making laps for the second or finishing scutcher, which is of similar construction to the first, the laps going from this machine to the carding engine.

The **CARDING ENGINE** (figs. 5 and 6) consists of one large or main cylinder covered with cards, a smaller one called the *doffer*, and a still smaller one called the *taker in*. The main cylinder is surmounted with small ones, called rollers, covered in like manner with cards, by whose revolutions in opposite directions to those of the large cylinder,

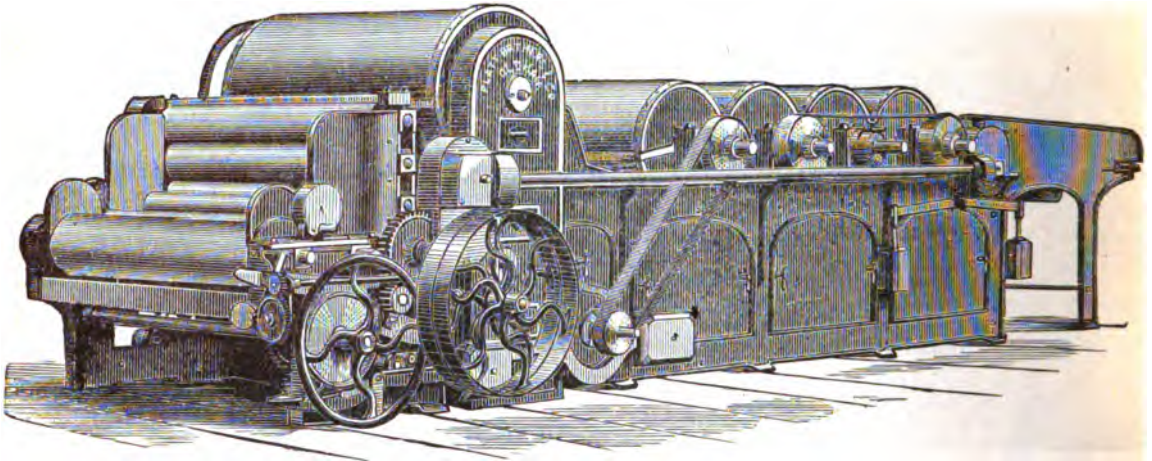

FIG. 3.—Three-cylinder Opener, Beater, and Lap Machine.

and with different velocities, the cotton is carded and put on the second cylinder or *doffer*. In some cases the main cylinder is furnished with what are technically termed "flats,"—a series of flat cards revolving to form an endless travelling lattice. The third cylinder, or *taker in*, which is really the first to act upon the cotton, is usually covered with a stronger wire; it receives the cotton from a pair of feed-rollers, striking out the heavier part of the dirt remaining from the scutching, and delivering the

cotton to the main cylinder. The cotton is taken from the *doffer* in a very light fleece by means of a vibrating comb, and this fleece is drawn together into a funnel which forms it into a narrow web; then passing through two pairs of calendar rollers, it is coiled into a can. The carding engines are often made with two main cylinders and a connecting cylinder called the *tummer*, but in all other respects they resemble those already described. The cans with the slivers are next taken to the

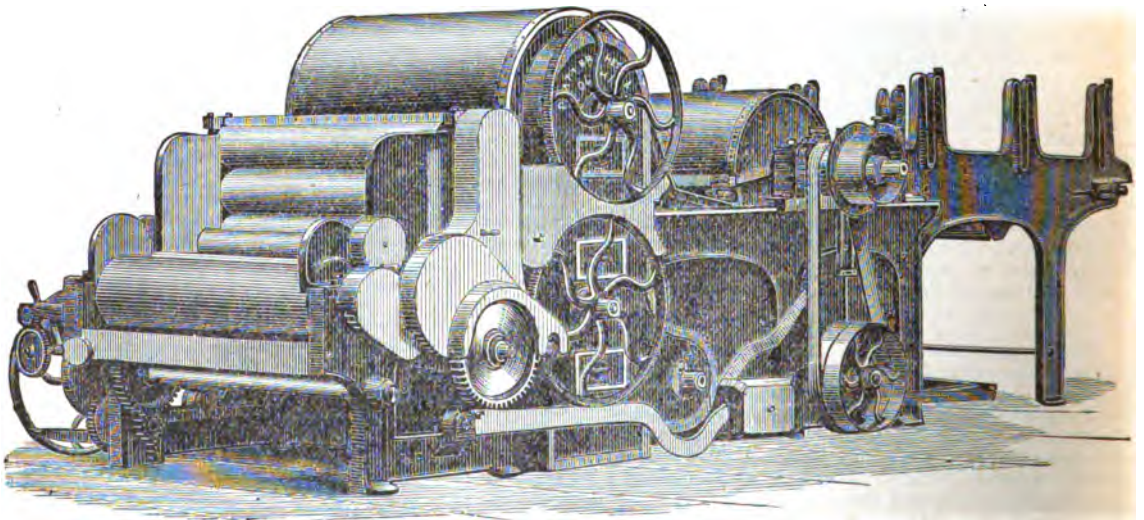

FIG. 4.—Single Scutcher and Lap Machine.

**DRAWING FRAME** (fig. 8), where the processes of elongation or attenuation are carried on through the successive pairs of rollers with which it is provided. The lower roller of each pair is furrowed, or fluted longitudinally, and the upper one is neatly covered with leather to give the two a proper hold of the cotton. There are generally four pairs or rows of rollers in each drawing frame, and three heads, each head containing five or six deliveries. Six ends or slivers are, as a rule, put up to each box, and drawn down into one by each line of rollers going at an accelerated

speed, the front roller revolving about six times faster than the back roller. The first doubling being 6 into 1, the next will be 36, and the third 216. Fine spinners will sometimes have four heads of drawings and double 8 ends into 1 at the first head, and 8 into 1 afterwards, which makes the total number of doublings in the drawing frame 4096.

**SLUBBING FRAME** (see fig. 9).—The operation which succeeds that of the drawing frame is slubbing, where the sliver has a certain amount of twist imparted to it, and is

wound on a bobbin. In this process the end or sliver from | of three pairs of rollers, and this is twisted as it emerges  
the last head of the drawing frame is drawn out by means | from the front line of rollers by the action of vertical spin-

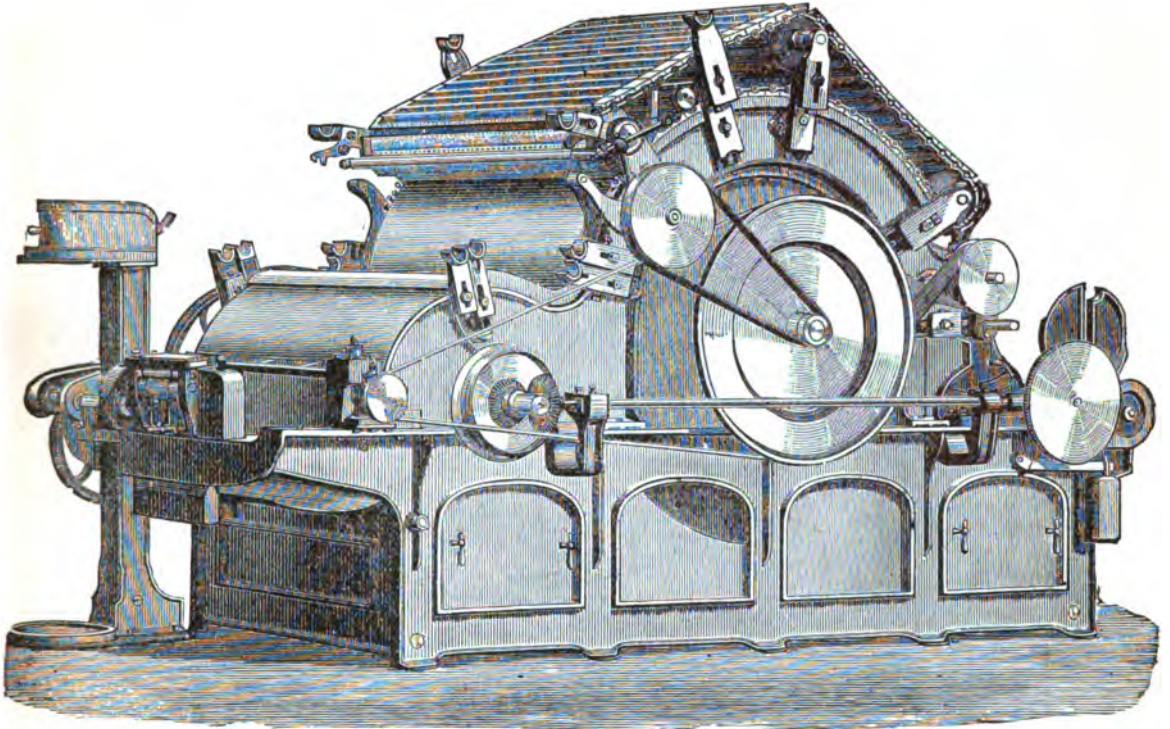

FIG. 5.—Self-stripping Flat Carding Machine.

dles and flyers, which at the same time wind the ends upon | crease in diameter their rate is gradually made slower at  
bobbins in successive layers. As the bobbins fill and in- | each layer by a very ingenious piece of mechanism known

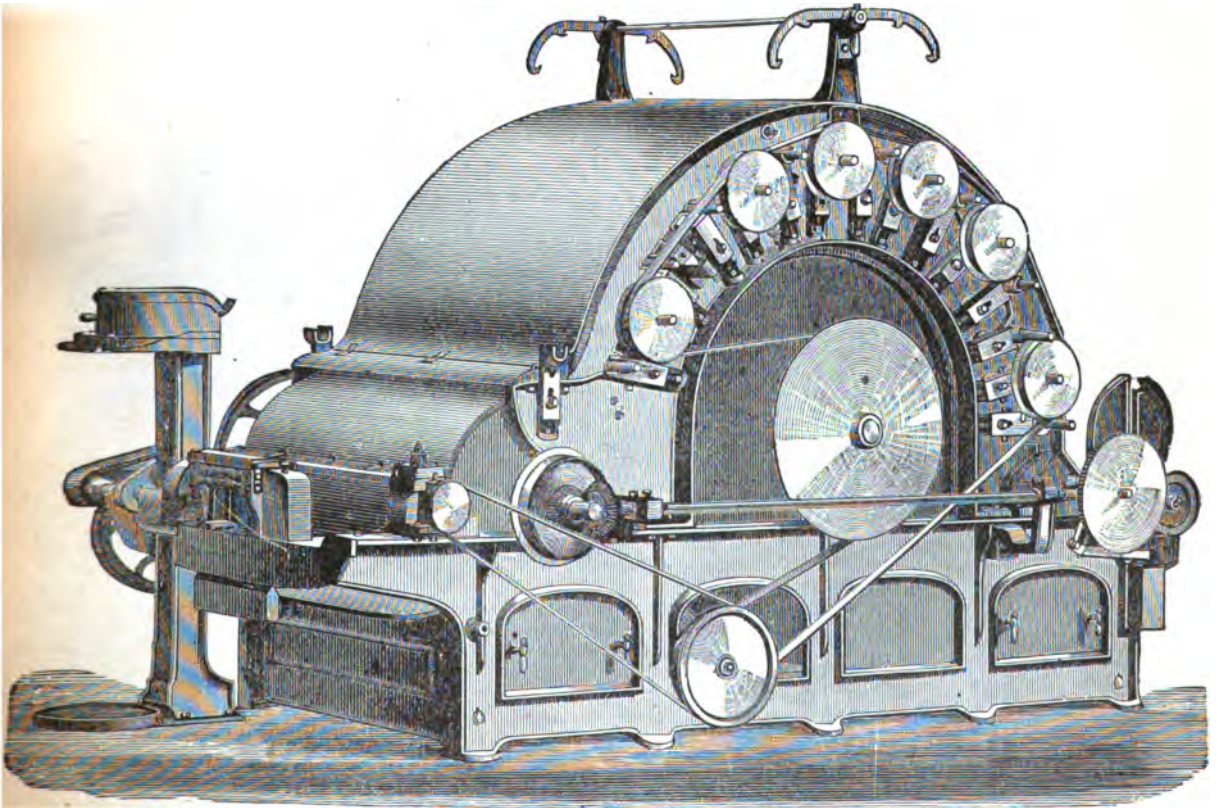

FIG. 6.—Roller and Clearer Carding Machine.

as "the sun and planet motion," consisting of a large wheel within which two other wheels are made to work, the interior one having a regular motion, and the sun wheel being driven from a pair of cone drums with a rate of speed constantly decreasing. Thus the slubbing frame answers three purposes,—it draws out the cotton, twists it, and winds it

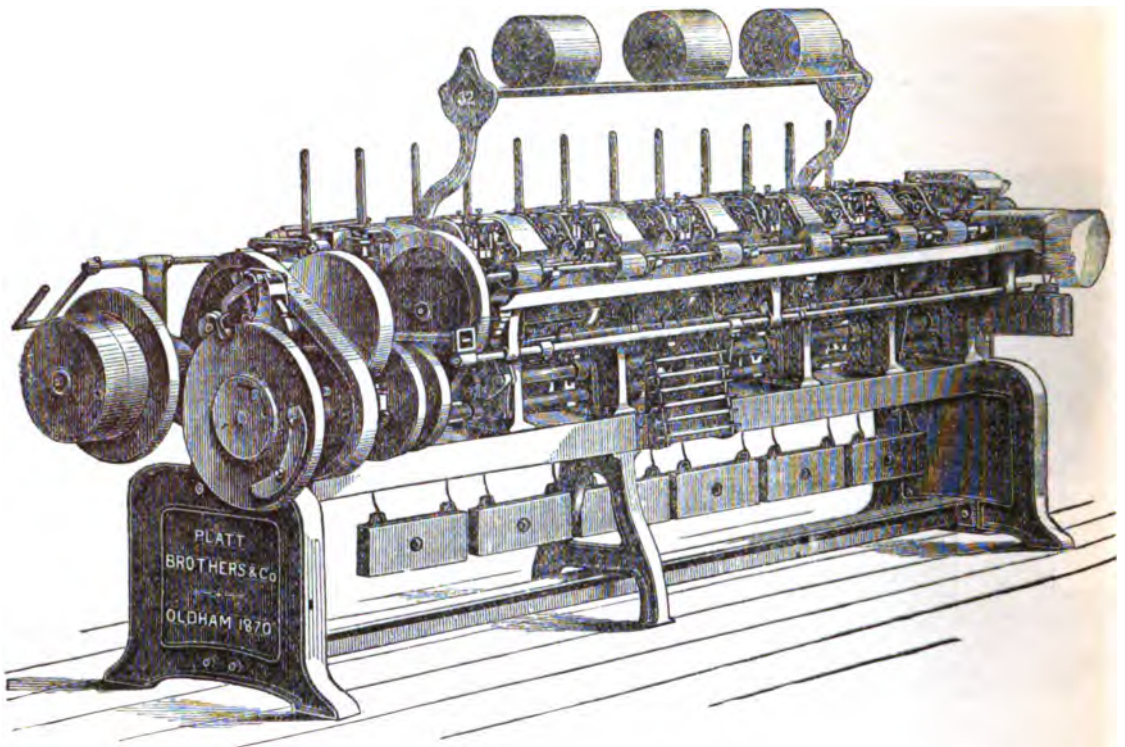

FIG. 7.—Combing Machine.

upon a bobbin; the first is done by the rollers, the second by the spindles, and the third by the flyers and pressers. Following this is

The INTERMEDIATE FRAME, of similar construction, but having a larger number of spindles and sometimes smaller-

sized bobbins. Instead of having cans put at the back it has what are termed *creels*, in which the slubbing bobbins are put so as to be drawn off through the rollers of the frame and doubled two into one. It is called *intermediate* because it comes between the slubbing and roving frames.

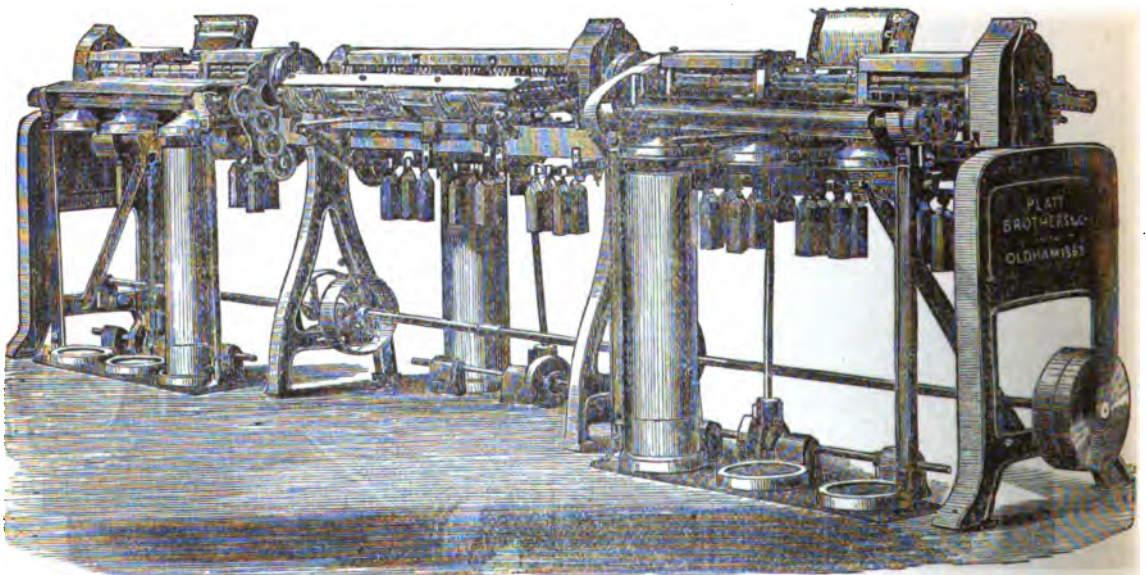

FIG. 8.—Drawing Frame.

Spinners of low numbers or counts sometimes omit this frame, and set the slubbing frame bobbins into the "creels" of the roving frame.

The ROVING FRAME (fig. 10).—This, which is the last required before the operations of spinning, strictly so called,

commence, resembles in principle the slubbing and intermediate frames. It has a greater number of spindles than either, seldom less than 100, and often 164; and these spindles are set closer together, and the bobbins are shorter and smaller than in the intermediate frame.



For medium counts, from 60's to 100's, the cans are taken to a lap machine or doubler, where from 80 to 120 ends or slivers are formed into a lap, which is placed at the back of the finisher card; this machine has the main cylinder surmounted with flats (see fig. 5) instead of rollers and clearers. From this finisher card the cans are taken

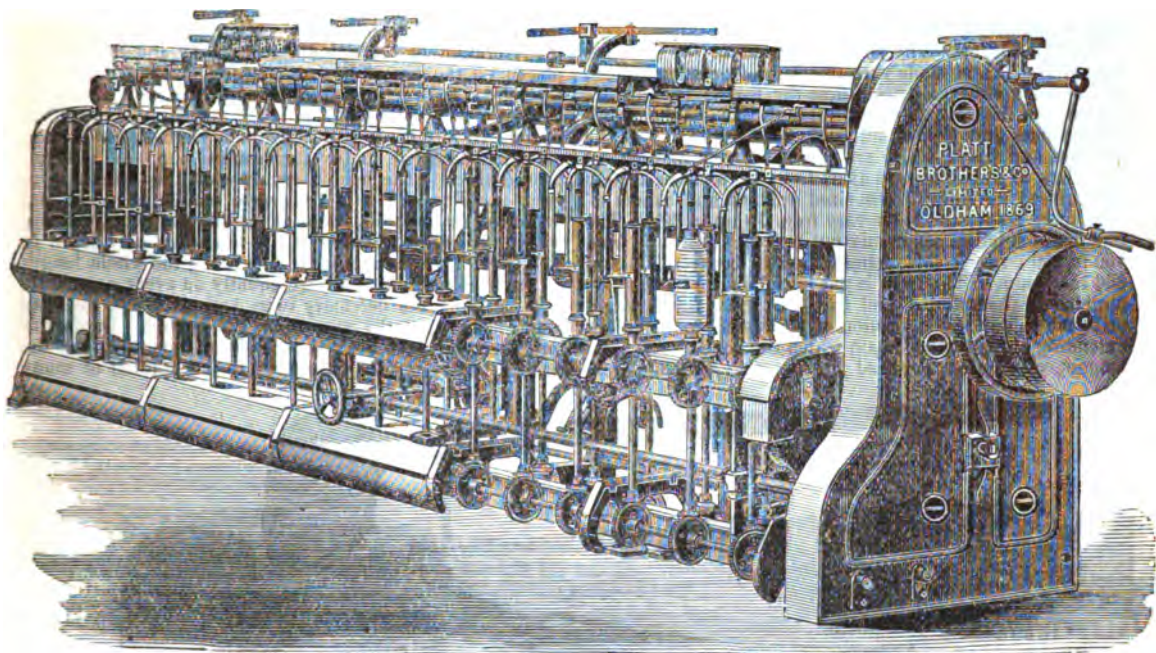

FIG. 9.—Slabbing Frame.

to the drawing frame in the way already described. For the higher numbers this card, the finisher card, is used as a breaker or first card; and from it the cans are taken into a small lap for the *combing machine* (fig. 7), and the cans from the comb are taken to the drawing frame. The degree of elongation completed by the roving frame is technically described by the number of hanks roving per

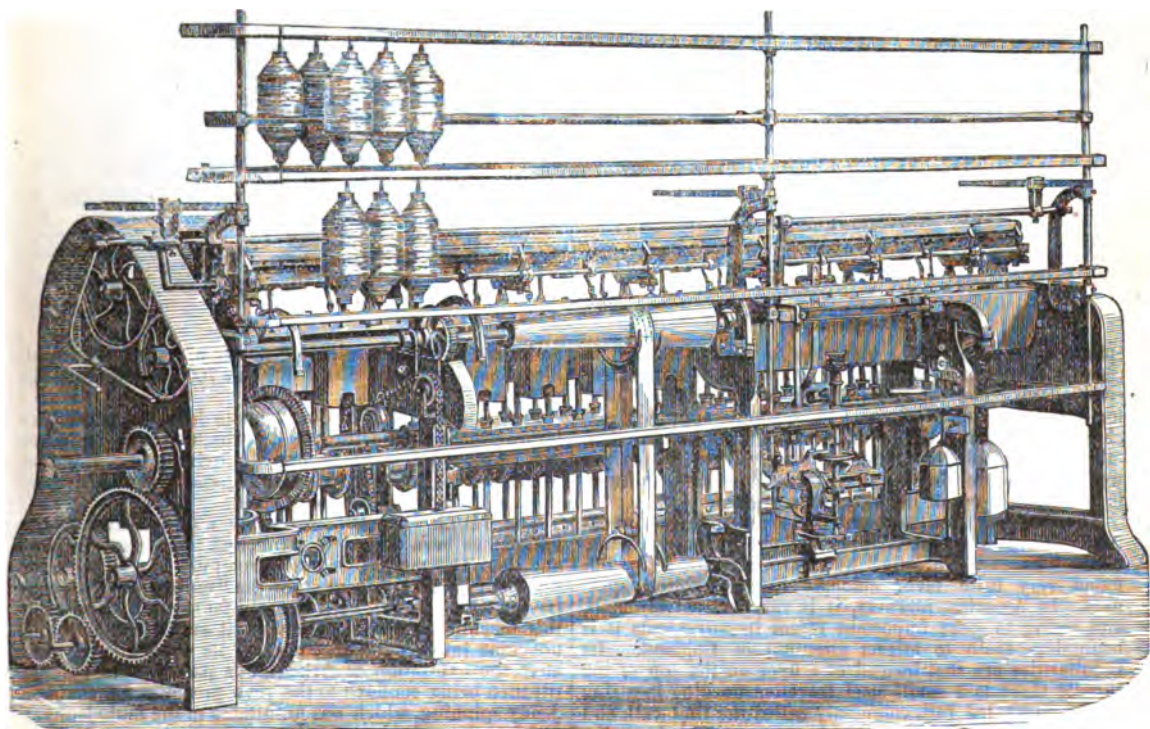

FIG. 10.—Roving Frame.

pound, each hank consisting of 840 yards; for instance, the hank roving usual for the lower counts up to 30's would be  $2\frac{1}{2}$  to 4 hanks in the pound. For the medium counts four frames are generally used to reduce the roving to the necessary degree of fineness, say 12 to 14 hanks roving, for the mule, viz., slabbing, intermediate, roving, and fine

jack frames. For the higher counts sometimes a fifth frame is used, called a second roving frame, reducing the finished roving to from 30 to 35 hanks. The first preparation goes to the throstle or to the self-acting mule, the second to the self-acting mule chiefly, and the third or higher numbers to the hand mule.

**The THROSTLE.**—The spinning frame, or throstle (see figs. 11 and 12), is made with two sets of drawing rollers, one on each side. Between these the roving bobbins are placed, and the rove is drawn through them to the requisite fineness, and formed into thread by the action of the spindles and flyers, which are placed in front of each set of rollers, at such distances apart from one another as may be required for the different-sized bobbins and counts of yarn to be spun; the latter vary from 6's up to 60's. The number of spindles commonly put into the throstle is from 100 to 150 on each side, being a total of between 200 and 300 in a frame. The twist is put into the yarn by the revolutions of the spindles and flyer, and the yarn is wound on to the bobbin by the friction of a piece of woollen cloth extending along the rail upon which the bobbins rest; the amount of friction required for the varying counts of

yarn is regulated by the differing weights and the shape of the bottom of the bobbins, and also by the fineness or coarseness of the cloth placed underneath.

An improvement on the throstle, which was thought to be very promising, was made by Mr. Danforth, an American spinner of Scotch birth. His object was to obviate the vibration of the spindle (caused by the flyer being placed on the top of it, with nothing to keep it steady), whereby it is prevented from being driven with advantage beyond a certain limited speed. To remedy this, Danforth introduced into his throstle a stationary spindle, on the top of which he fixed an inverted conical cup. In this improved throstle the bobbin revolves on the spindle with great rapidity, and by a transverse motion is raised and depressed so as to be, when at the highest point, entirely within the cup, and when at the lowest entirely below it. The edge of the cup, passing thus along the whole length of the bobbin, builds the yarn equally on every part while it is receiving the necessary twist, and gives also the drag required to wind the yarn upon the bobbin. Danforth's improvement gives a great increase of quantity, but the waste it causes is such as to form, in the opinion of many

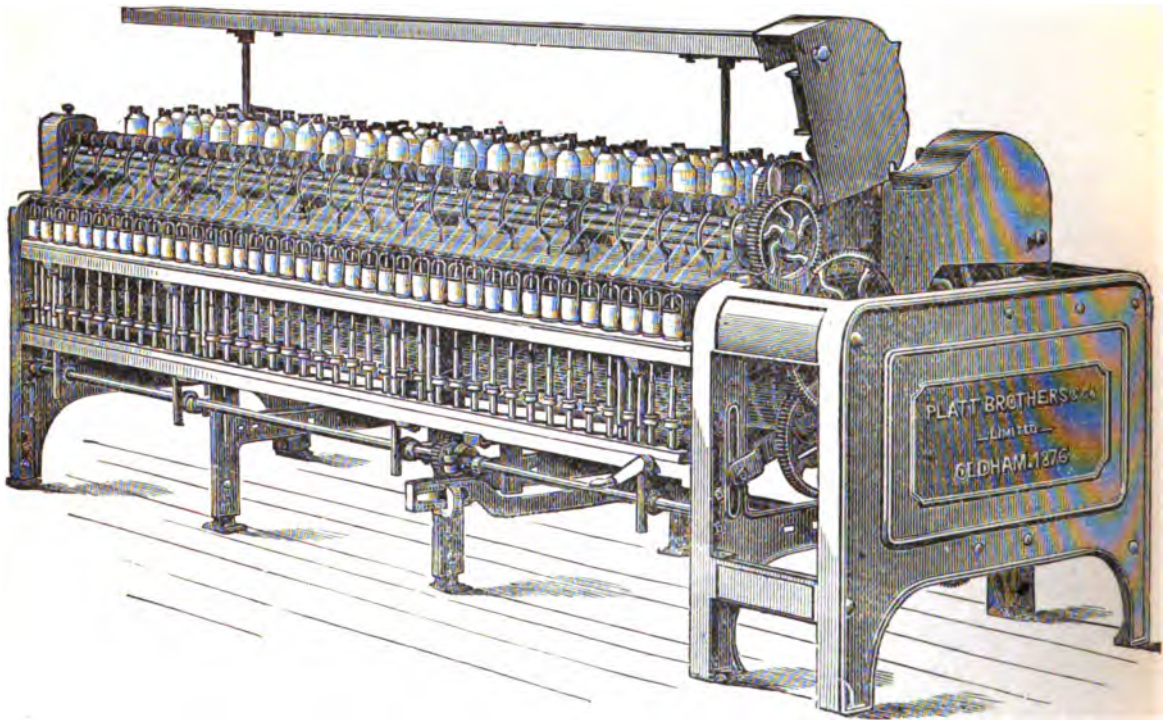

FIG. 11.—Throstle with Spindles and Flyers.

spinners, an insuperable objection to its use, though as regards the stronger material of worsted it is still extensively used. The throstle frame is now exclusively used for the production of warps. In the most approved machines of this kind the spindles make 5500 revolutions a minute, each spindle producing twenty-seven hanks per week of 56 hours when spinning 32's. The Danforth frame is now entirely out of use except for worsted.

The ring and traveller frame is also an American invention. It was introduced into England under the name of the "Niagara Throstle" by Sharp, Stewart, & Co., but found very little favor amongst English cotton spinners. In America, however, it is very extensively used, and owing to some important recent improvements it is beginning again to attract attention in England. Its peculiarities are that instead of a flyer on the top of the spindle there is a small steel traveller working in a ring placed in a third rail, commonly called the rind rail, and passing over the bobbin, which moves up and down the full length of the bobbin; the twist is given by the revolution of the spindle, the drag or winding of the thread on the bobbin (fixed to the spindle and carried round with it) being effected by the friction of the traveller in its revolutions round the ring. The travellers are of varying weights

and sizes to suit the different counts of yarn. The spindles generally make about 6000 to 7000 revolutions per minute.

Messrs. John Elce & Co. claim to have introduced an improvement in the throstle, in which two tin cylinders are employed instead of one for driving the spindles, whereby a longer band is obtained, and a saving of friction and power is said to be effected.

**The MULE (fig. 13).**—Probably no inventive contribution has been offered to the cotton trade more important than the mule. Samuel Crompton of Bolton completed in 1775 his invention of the "mule jenny," in contriving which he had been engaged for several years. But this machine, possessing great merit and advantages, did not come into general use, nor was its value known, until after the expiration of Arkwright's patent,—the spinner till then being confined to the rove prepared for common jenny spinning, which was unsuitable to the mule jenny.

After the spinner was allowed to make use of Arkwright's fine process of preparation, by his patent being cancelled, the power of this machine became known; and its introduction forms an important era in the history of the cotton manufacture. Being fitted to supply those counts or "grists" and qualities of yarn which the other machines

could not produce, it enabled the manufacturer to enter upon fabrics which otherwise it would have been in vain to attempt. Warps of the finest quality are spun upon the mule; while on the throstle yarn of a finer grist than No. 40 could not without the combing machine be spun to advantage. Since the introduction of the latter, throstles have been constructed to spin yarns as fine as Nos. 80 or 100. The reason is that the fine thread has not strength to stand the drag required for winding the yarn upon the bobbin,—the difficulty being occasioned by each thread having its own drag regulated separately. In Crompton's mule and Hargreaves's jenny this difficulty was avoided by the spinner putting the required tension or drag on the yarn by the "faller," which operating on all the threads at once, and being controlled by the hand of the spinner, allowed the tension of the yarn during the winding on to be easily governed. All wefts, from the lowest to the highest numbers, are now spun upon Crompton's machine, the use of Hargreaves's jenny having been almost entirely superseded

by it as regards cotton, though not as regards woollen. It was some time, indeed, after the mule came into use before it was ascertained that the finest yarn required for the manufacture could be produced from it. But in the year 1792, Jonathan Pollard of Manchester succeeded in spinning yarn of 278 hanks to the pound, from cotton wool grown by Mr. Robley, in the island of Tobago. This yarn was sold at twenty guineas per pound to the muslin manufacturers of Glasgow.

The mule, in its structure and operation, is a compound of the spinning frame and of Hargreaves's jenny; from which circumstance it probably received its name. It contains a system of rollers like that belonging to the throstle; but the attenuated roving, as it issues from between the rollers, is twisted by the action of the spindles, which, in the mule, are mounted on a movable carriage that recedes from the rollers a little faster than the roving is delivered by them. The mode of putting the twist in by means of the spindles is exactly the same as in the jenny, and in fact

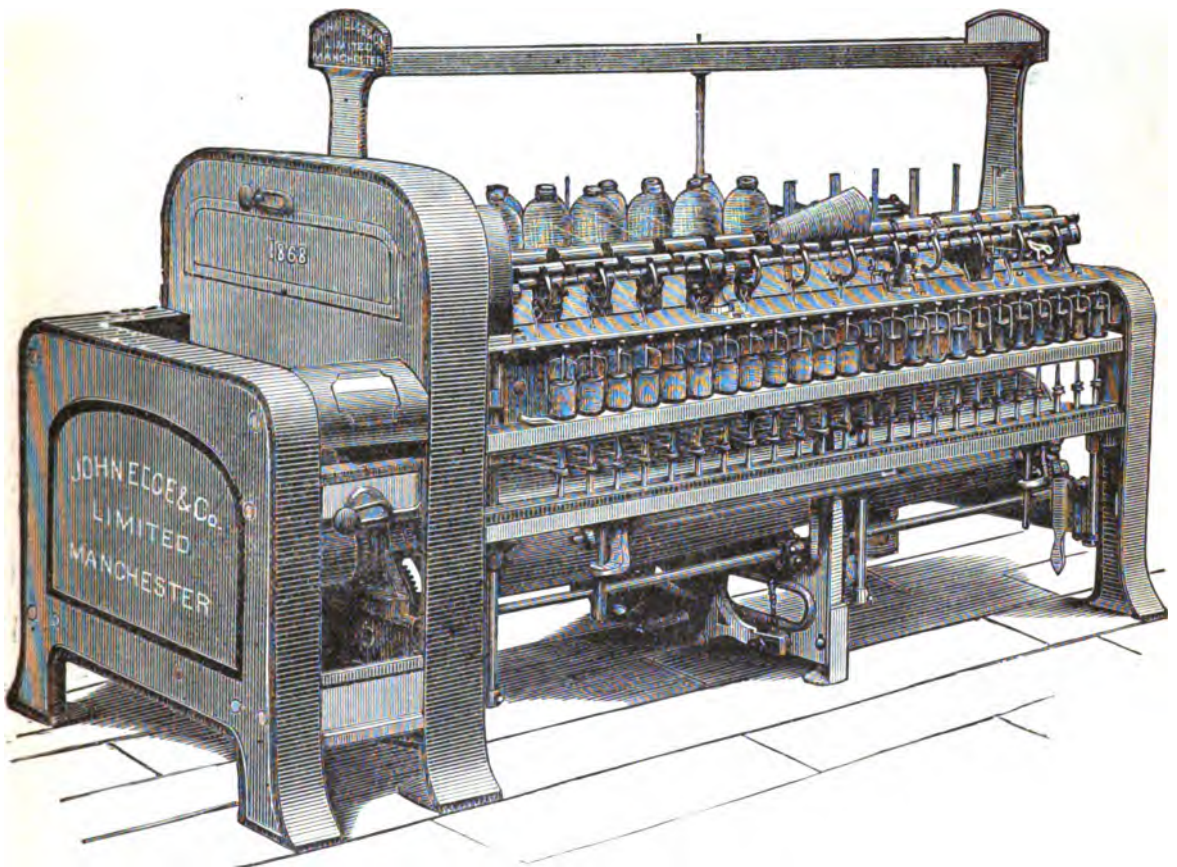

FIG. 12.—Throstle.

resembles the most ancient method of using a spinning spindle. When a sufficient length of yarn or a "stretch" had been spun the rollers and spindles were stopped, the yarn coiled round the bare spindles was unwound, or "backed off;" as it is technically called, the faller was put down by the spinner and the "nose" of the cop, and the spindles turned during the run in of the carriage with sufficient quickness to wind the spun yarn on the top of the yarn already wound on the spindles. When the spindle points have been brought by the running in of the carriage within a short distance of the delivery rollers, the rollers and spindles are again set in motion for another stretch. The manner of backing off and winding the spun yarn on the spindles is exactly the same as that used in Hargreaves's jenny. Crompton's great merit consisted in the adaptation of the best features of the throstle and the best principles of Hargreaves's jenny, so as to obtain from the combination of the two the principal elements of a perfect spinning machine. The motive power being manual, the work was

rendered more fatiguing as the mules became longer, and thus the size of the machine was restricted by the strength of the spinner. In spinning the finer counts of yarn it became customary to continue the outward movement of the carriage, and the rotation of the spindles, a short time after the rollers were stopped; the movement of the carriage was then arrested, but the rotation of the spindles continued until the proper amount of twist had been put in the yarn. This last operation resembles that performed by the common jenny, and produces a similar effect.

In 1792, William Kelly of Glasgow, at that time manager of the Lanark mills, obtained a patent for moving the mule by power in order to relieve the spinner from the most laborious part of his work, and thus enable him to attend to a longer mule and spin the yarn at a reduced cost. Kelly's machinery was contrived so as to move every part of the mule, even to the returning of the carriage into its place, after the draught was finished. Had it come into full operation, fewer men need have been employed as

spinners, and children would have been able to do a great part of the duty required. But, after a short trial, it was discovered that this invention, though intended to bring out the carriage, and return it again during the winding

on of the yarns, was found to be valuable only for bringing out the carriage. A spinner could, however, serve two mules, the one carriage moving out during the time that the other was returning.

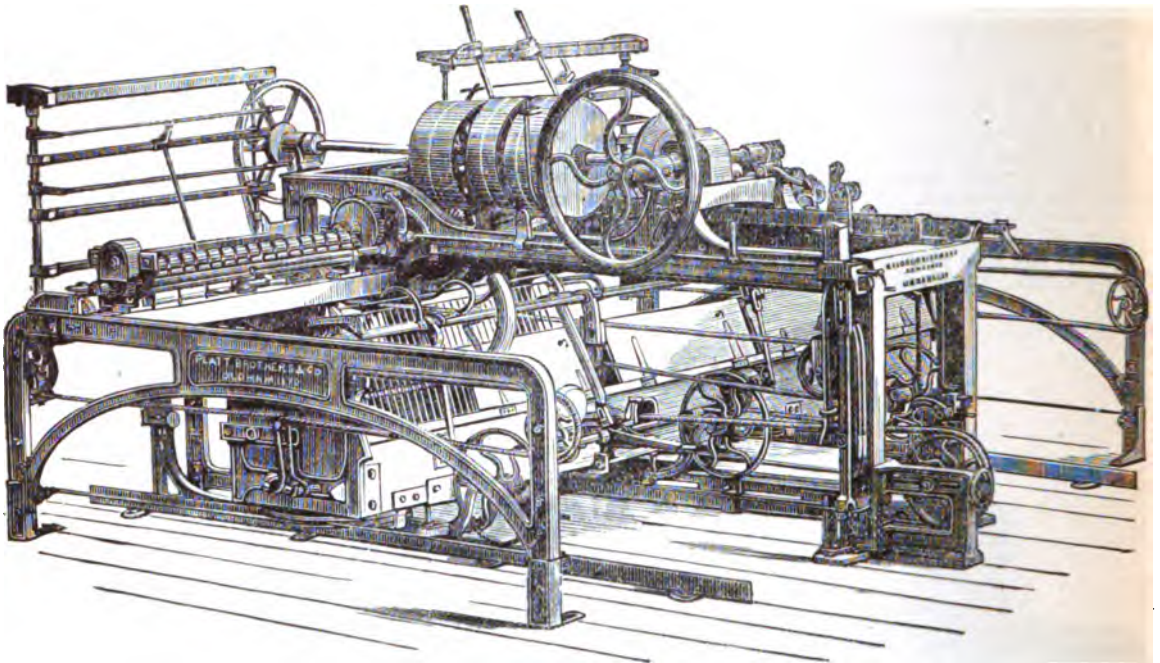

FIG. 13.—Hand-Mule.

It was next found unnecessary to confine the mule to 144 spindles, the largest number it had till then contained; for, with the assistance of the above mechanical improvement, the spinner could manage two mules of 300 or 400 spindles each. The process of mule spinning continued

to be conducted upon this plan till several proprietors of large cotton works restored the part of Kelly's machinery which returns the carriage into its place after the draught is completed, thus further lessening the fatigue to the spinner. All that is to be done by the spinner in this case is,

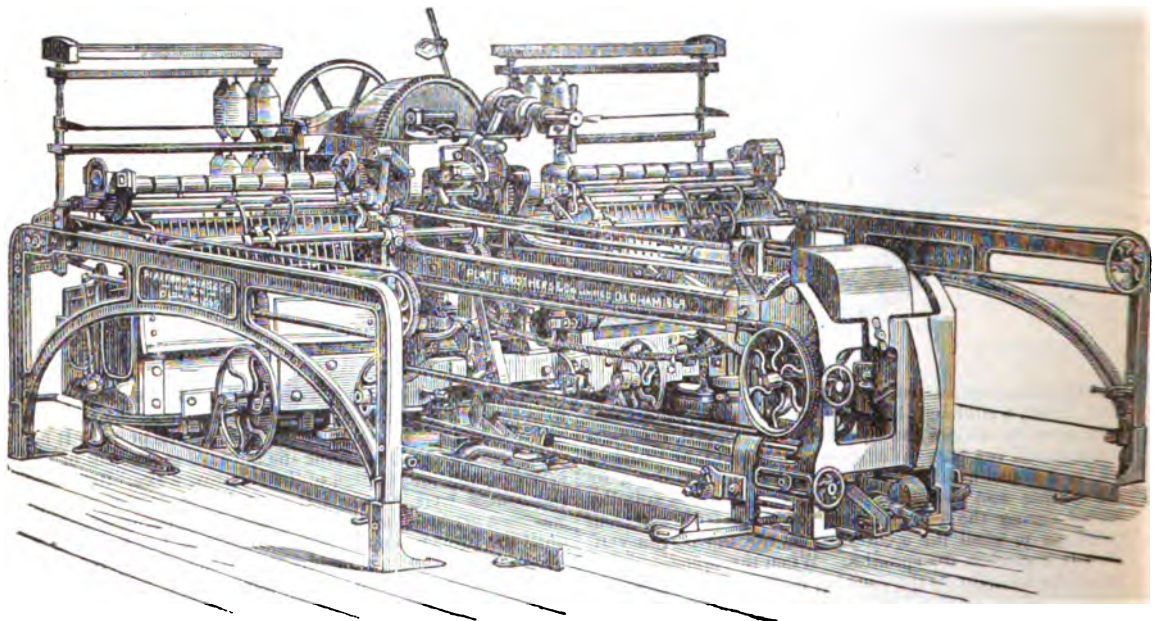

FIG. 14.—Self-acting Mule.

with a slight touch of the hand to shift the belt so as to allow the carriage to be moved back into its resting position, and, as this takes place, to manage the guide for building the cop, regulate the motion of the carriage as it recedes, and govern the speed of the spindle for winding on the yarn.

Some improvements were from time to time made in the headstocks, which either rendered the mule more automatic or else enabled the spinner to work a larger pair of machines; but notwithstanding, the work still required the greatest attention and care, as well as an amount of skill

that could only be attained by long practice. Spinners thus became a very important and powerful class, demanding and obtaining a high rate of wages, and sometimes occasioning to their employers more trouble than any other class. This doubtless contributed to the introduction of the self-acting mule. At the same time, it must be observed that great improvements were introduced, and still continue to be made, in the construction of the hand-mule, perfecting and extending its operative powers, and enabling it to do its work almost automatically with the aid of the most delicate control of the spinner, who has no longer to use his strength to drive the various parts, but is required chiefly to regulate or reduce the velocity of the backing off and winding on, though the same unremitting attention and care are as necessary as before. The hand-mule, as it is designated, is therefore quite as complex a machine as the modern self-acting mule.

**SELF-ACTING MULE** (fig. 14).—In 1818 William Eaton obtained a patent for a self-acting mule, in which the operations ordinarily performed by the spinner were effected by automatic means, and this machine, though not extensively adopted, contained several ingenious arrangements. His faller lock, after a lapse of thirty-six years, was said to be re-invented, and still continues to be the best in use at the present day. His apparatus for governing the formation of the cop was founded on correct principles, and was a beautiful contrivance, much superior to many that have been since introduced. Mr. Smith of Deanston, Scotland, was also the author of several valuable inventions, and others might be named who made efforts, more or less successful, to provide the desired machine.

About 1824 Richard Roberts directed his attention to the best means of rendering the hand-mule self-acting, and in 1825 a patent was taken out for his invention. In the mule now introduced the governing power was exercised by what was then and has ever since been called a "cam shaft," by which all the movements were so regulated as to succeed each other in their proper order, the termination of one operation being the initiation of the next. In 1830 Roberts took out another patent for his "quadrant" winding apparatus, and thus completed his self-acting mule, which in its chief essential features remains the same at the present day; for though as regards the head-stock there have been improvements, yet the whole combination still bears indelible marks of his genius. Many improvements have of late years been introduced and patented, and the self-acting mule now in use is superior in its manner of working to the one made by Roberts. It is now employed for spinning all sizes of yarns up to 100's, and in a few cases as high as 160's, and in the manufacture of these numbers a great saving is effected by its use. It has now almost entirely superseded the hand-mule, which only retains its position for the production of the finest yarns, and in a few years will undoubtedly have to give place altogether to the self-actor, on which yarn up to 160's, or even 200's, has already been successfully spun.<sup>1</sup>

#### *Effects of Machinery, &c., on Production and Cost.*

About the year 1790 the average product of yarn No. 40 was little more than a hank per spindle per day; but by the year 1812 it had advanced to two hanks per day, and in 1830 to 2½. The effect of this increase of production upon the cost of the article was very great, as will be seen by the following statement of the reduction of the cost of spinning, and in the price of yarn.

We have already noticed that, until the cancelling of Arkwright's patent, by which the mule spinner became at liberty to use his improved mode of preparation, the few fine wets required were spun on Hargreaves's jenny. In the year 1788 this yarn was sold in Glasgow and Paisley at 31s. per pound for No. 90, 7s. per pound being the price of spinning it; the warp, spun upon the water or throstle frame, was sold at 47s. 6d. the pound for No. 90.

It was stated by Crompton that, immediately upon completing his invention of the mule in the year 1775, he obtained 14s. per pound for the spinning and preparation of No. 40; that a short time after he got 25s. per pound for No. 60; and that to show that it was not impossible to

spin yarn of so fine a grist, he then manufactured a small quantity of No. 80, for the spinning and preparation of which he got 42s. per pound. For some little time after the mule came into general use, in the year 1786, it was the practice in many places for the spinner to purchase the wool in a prepared state; and separate concerns for preparing cotton were established and carried on. At that time 10s. per pound was paid for spinning No. 100; but soon afterwards the cost for this number was reduced, first to 8s. and then to 6s. 8d. In 1790 the price of spinning No. 100 was 4s. per pound. In 1792 it was brought to 3s. 1d., and in 1793 to 2s. 8d., at which price it continued till 1795, when, the mule coming to be worked by machinery, and an increase being made in the number of spindles, the spinner was enabled so to extend the quantity of his produce as to admit of another considerable reduction in cost. The price of spinning No. 100 was in the course of a few years brought down to 8d. per pound, and continued so until 1826, when it was further reduced to 6½d. per pound. Notwithstanding this extraordinary diminution of the price of spinning, such have been the effects of the improvements in machinery, in the selection and preparation of wool, and in the skill and tact brought to bear on the work, that the spinner is able to earn more money now than he did when the wages were at the highest.

The sale prices of the yarn during this period were as follows:—

In 1786, for No. 100..	38s.	In 1797.....	19s.
1788 .....	35s.	1799 .....	10s. 11d
1791 .....	29s. 9d.	1801 .....	8s. 9d
1793 .....	15s. 1d.	1803 .....	8s. 4d.
1795, spun from		1805 .....	7s. 10d.
Bourbon cotton		1807 .....	6s. 9d.
wool.....	19s.		

After 1807 the price of yarn underwent various fluctuations; it fell in 1829 to 3s. 2d., and in 1831 to 2s. 11d., at which price it remained in 1832. Since 1832 the fluctuations have not been extreme, the price never rising above 5s. 6d., at which it stood in 1836, nor falling below 2s. 9d., as in 1842. Prices for No. 100 at the close of 1876 were warp-twist 2s. 10d., medium 2s. 6d., and west 1s. 10d.

But the benefits of improved machinery have not been confined to the reduction of the cost of the yarn; they have at the same time considerably increased the quantity which a workman can produce in the same hours of labor.

*Application of Steam Power.*—During the time that the machines for the different processes of cotton spinning were advancing towards perfection, James Watt had been employed in maturing and reducing to practice his conceptions for extending the powers of the steam-engine.

Among the engines erected by Bolton and Watt in 1785 was one for Messrs. Robinsons, at Papplewick, in Nottinghamshire, for spinning cotton,—the first instance of the application of steam to this manufacture. In 1787 they put up one for the Messrs. Peel, at Warrington, for cotton spinning, and three others for the same purpose at Nottingham. No rotative engine had yet been erected at Manchester; and it was seven years after Bolton and Watt had received their patent that they constructed for Mr. Drinkwater the first engine used there for spinning cotton. In 1790 they erected one for spinning cotton at Nottingham for Sir Richard Arkwright, another at Manchester for Mr. Simpson, and a third at Papplewick for Messrs. Robinsons. Some time before this Sir Richard Arkwright and others, from an ill-judged economy in the first cost, had introduced into their spinning factory atmospherical or Newcomen's engines, with rotative motions applied to them. But quickly perceiving their error, they abandoned them;—and Bolton and Watt's engines soon came to be universally used among cotton spinners and all other manufacturers.

*Cotton Supply Improved.*—In an account of the means which contributed to the fall in the price of spinning we must not overlook the progressive improvement in the cultivation of the raw material which has taken place, and in the application of its different qualities to their most profitable uses. Previous to the year 1793, the cotton used in the coarser articles of the manufacture, with the exception of a small quantity imported from India and from the Levant for the fustian trades was wholly the growth of the British and French West India Islands. That for the better kind of goods was raised in Demerara, Surinam, and Berbice. The wool for fine goods was grown in the

<sup>1</sup> Fuller details of cotton machinery may be found in a work entitled *The Science of Modern Cotton Spinning, &c.*, by Evan Leigh, O. E.; in a paper by Mr. John Platt on machinery for the preparing and spinning of cotton, published in *The Proceedings of the Institution of Mechanical Engineers*; and in Spon's *Dictionary of Engineering*.

Brazils; and that for the few very fine muslins then manufactured, in the isle of Bourbon.

In 1787 the descriptions of cotton imported into Britain appear to have been as follows:—

From the British West Indies .....	6,800,000 lb
From the French and Spanish colonies.....	6,000,000
From the Dutch do .....	1,700,000
From the Portuguese do .....	2,500,000
From the Isle of Bourbon, by Ostend .....	100,000
Smyrna and Turkey.....	5,700,000
	<u>22,800,000</u>

Had we continued to derive our sole supply of cotton from these countries, the progress of the manufacture would have been greatly retarded, not only from the difficulty of making the production keep pace with the increasing consumption, but from the impossibility of obtaining the qualities suited to the finer descriptions of goods, which the improved machinery enabled us to undertake. But as we have already seen, more abundant supplies were procured from America, and of qualities before unknown. It was soon found that the Sea Island cotton grown in the small islands, extending along the American coast from Charleston to Savannah, was so exquisitely fine, long, and strong in staple as to surpass any cotton previously obtained from any part of the globe. After a succession of trials its superiority was fully admitted, and it soon came into use for the purposes for which Bourbon cotton had been employed before 1796, and in a short time entirely supplanted it.

#### *Progress of Cotton Manufacture in England.*

Nottingham, where Arkwright commenced Stocking operations, was the seat of the stocking manufacture, in which moreover his partner Need was largely engaged, and the whole produce of his spinning was therefore at first devoted to that industry. The cotton yarn for stockings requires to be particularly smooth and equal; and to secure these qualities, it is spun by a process differing a little from that employed for ordinary twist. Being from two roves in place of one, it is called double-spun twist. The introduction of this article produced a great change in the stocking manufacture. Hand-spun cotton was entirely laid aside; and stockings made of twist were of so superior a quality, that in a short time they wholly supplanted those made from thread.

About the year 1773 Need and Strutt made the important discovery that the yarn produced by the spinning frame had sufficient strength to fit it for warp, although its firmness and hardness rendered it less suitable for weft. The weft, therefore, continued to be spun by Hargreaves's jenny; and from this time the calicoes, and other articles in imitation of India goods, which had hitherto been manufactured with linen warp, came to be made wholly of cotton; and the progressive increase of these manufactures, particularly of calicoes, after this time, was unexampled.

After having made a considerable quantity of those goods, Need and Strutt discovered that, when printed, they were subject to double the duty charged upon calicoes woven with linen warp, and that their sale was even prohibited in the home market. After a long and expensive application to the legislature, they succeeded in procuring the repeal of those impolitic laws. Nearly about the same period, calicoes entirely of cotton were begun to be made at Blackburn, and also at Preston,—

which places soon became the seat of their manufacture, and for a long time the great market to which the printers from all parts of the kingdom resorted for their supplies. This branch went on increasing for many years in a most extraordinary degree. About the year 1805, it was calculated that the number of pieces sold annually in the Blackburn market was not less than a million; and by that time the manufacture of this article was not confined to the country around Blackburn, but had spread into the north-west district of Yorkshire, principally about Colne and Bradford, from which part of the country 20,000 pieces weekly are said to have been sent to Manchester.

The first attempts to make muslins in Britain commenced simultaneously in Lancashire and at Glasgow about the year 1780, but were without success. There was no yarn fitted for the weft of these goods, except that spun upon Hargreaves's jenny; and when made of this,

it was found they were not of a marketable quality. Recourse was then had to wefts brought from India; and although a better article than the former was by this means produced, it was still not of a quality to compete successfully with Indian muslin. As soon, however, as the invention of the mule jenny enabled the spinner to produce yarns suited to such fabrics, the manufacture of the finest cotton articles became an important branch of trade in this country. That machine, as has been mentioned, came into use at the end of the year 1785, upon Arkwright's patent being cancelled; and it is from that period we ought to date the commencement of this part of the manufacture. So rapid was its increase, that in 1787 it was computed that 500,000 pieces of muslin were in that year manufactured in Great Britain.

*Power-Loom Weaving.*—The credit of the invention of the power loom is due to the Rev. E. Cartwright of Hollander House, Kent. The circumstances of his discovery, which will be found fully detailed in the following letter, are curious, and of interest in the history of inventions. Mr. Cartwright says:—

"Happening to be at Matlock in the summer of 1784, I fell in company with some gentlemen of Manchester, when the conversation turned on Arkwright's spinning machinery. One of the company observed, that as soon as Arkwright's patent expired, so many mills would be erected, and so much cotton spun, that hands never could be found to weave it. To this observation I replied, that Arkwright must then set his wits to work and invent a weaving mill. This brought on a conversation on the subject, in which the Manchester gentlemen unanimously agreed that the thing was impracticable; and, in defence of their opinion, they adduced arguments which I certainly was incompetent to answer, or even to comprehend, being totally ignorant of the subject, having never at that time seen a person weave. I controverted, however, the impracticability of the thing, by remarking that there had lately been exhibited in London an automaton figure which played at chess.

"Some little time afterwards, a particular circumstance recalling this conversation to my mind, it struck me that, as in plain weaving, according to the conception I then had of the business, there could only be three movements, which were to follow each other in succession, there would be little difficulty in producing and repeating them. Full of these ideas, I immediately employed a carpenter and smith to carry them into effect. As soon as the machine was finished, I got a weaver to put in the warp, which was of such materials as sail-cloth is usually made of. To my great delight a piece of cloth, such as it was, was the produce. As I had never before turned my thoughts to anything mechanical, either in theory or practice, nor had ever seen a loom at work, or knew anything of its construction, you will readily suppose that my first loom must have been a most rude piece of machinery. The warp was placed perpendicularly, the reed fell with a force of at least half a hundred weight, and the springs which threw the shuttle were strong enough to have thrown a Congreve rocket. In short, it required the strength of two powerful men to work the machine at a slow rate, and only for a short time. Conceiving in my great simplicity that I had accomplished all that was required, I then secured what I thought a most valuable property by a patent, 4th April, 1785. This being done, I then condescended to see how other people wove; and you will guess my astonishment when I compared their easy mode of operation with mine. Availing myself, however, of what I then saw, I made a loom, in its general principles nearly as they are now made; but it was not till the year 1787 that I completed my invention, when I took out my last weaving patent, August 1st of that year."

But the idea of weaving by machinery was not new, although it had never been carried into practice. About the close of the preceding century, a drawing and a description of a similar loom (a circumstance unknown to Cartwright) had been presented to the Royal Society of London. The movements, too, in both are the same in principle with those of the inch or tape loom, a machine which had long been in use. Cartwright, after obtaining his second patent, erected a weaving factory at Doncaster, which he filled with looms. This concern was unsuccessful, and was at last abandoned. But still the invention was considered so important to the country, that some years after, upon an application from a number of manufacturers at Manchester, Parliament granted Cartwright a sum of money as a remuneration for his ingenuity and trouble. About the year 1790, Grimshaw of Manchester, under a license from Cartwright, erected a weaving factory, which was to have contained 500 looms, for weaving coarse sacking-cloth.

He intended also to have attempted the weaving of fustians. But, after a small part of the machinery had been set agoing, the work was destroyed by fire; and as the concern during the short trial that had been made did not promise to be successful, the mill was not rebuilt. Weaving by power, in fact, could never have succeeded but for the discovery, by Mr. Radcliffe of Stockport, of a process for dressing the web before it is put into the loom. The stoppage of the work from time to time for dressing the web made it impossible to do more than attend to one loom; but owing to the introduction of this process, one person was soon enabled to attend to two looms, and can now attend even to four.

**Dressing.** The contrivances for "dressing" are very ingenious, the machinery employed in it deriving its movement from the power which gives motion to the looms. The yarn is first wound from the cop upon bobbins by a winding machine. These are then taken to the warping mill and made into warps of such number of ends and such lengths as may be required by the manufacturer. The warp is taken to the beaming machine to be wound on to beams, and then to the dressing machine, and passed through strong starch liquid, &c. Where the manufacturer is also a spinner he can dispense with the warping mill, the bobbins being taken at once to the beaming machine. The warp is then compressed between two rollers, to free it from the moisture it had imbibed with the dressing, and drawn over a succession of tin cylinders heated by steam, to dry it. During the whole of this last part of its progress, it is lightly brushed as it moves along, and fanned by rapidly revolving fanners.

Peter Marsland of Stockport, who for many years had a large factory for weaving cotton cloth of a superior quality, was the inventor of an improvement upon the power-loom, by means of the double crank, for which, about the year 1807, he obtained a patent. The operation of the crank is to make the lathe give a quick blow to the cloth on coming in contact with it, and by that means render it more stout and even.

The weaving of calicoes by power did not succeed in Lancashire so early as it did in Scotland. In 1817, the number of power-looms in Lancashire was estimated to be about 2000, of which only about 1000 were said to be then in employment. The cause of this was that the price paid at the time we refer to for weaving by the hand had been forced down to the very lowest degree by the depressed state of trade, and the pressure of an overgrown population bearing upon the means of employment. Wages had fallen below the rate at which the goods could be produced by machinery. This struggle for existence between the two processes terminated, however, as might have been expected. The hand-weavers, finding it impossible to go on with the reduced wages, gradually gave way. Their numbers ceased to increase; and the extraordinary addition to the amount of the manufacture since that time has been the product of the power-loom. Goods of very low and fine qualities are still woven by the hand.

**Lace.** There is a branch of the cotton manufacture yet to be noticed,—a branch not derived from the East, like muslin, but one that has had its origin in England,—namely, the bobbinet or Nottingham lace manufacture, which now furnishes employment for a large amount of labor and capital. See **LACE**.

#### *Cotton Manufacture in Scotland.*

Previous to 1778 there were no pure cotton fabrics woven in Scotland, and the only form in which the fibre was used to any considerable extent was in the manufacture of blunks, a coarse kind of handkerchief having linen warp and cotton weft. The first cotton-mill in Scotland was erected at Penicuik, and the second at Rothesay in 1779. These were succeeded by others at Barrhead, Johnstone, and other localities where a suitable supply of water could be obtained, as, excepting horses and oxen, it was at that period the only power available. The name of David Dale is closely associated with the early progress of cotton spinning and weaving in Scotland. In 1785 Dale began, with Arkwright, who that year had been beaten out of his patent rights by the Lancashire spinners, to erect cotton-mills at New Lanark. These mills were the most extensive of their period; and they at a later time acquired a very wide notoriety by being made the scene—in conjunction with his establishment at Orbiston in the parish of Both-

well—of the attempt of Robert Owen, Dale's son-in-law, to commence the regeneration of society by a practical exemplification of the virtues of socialism. Owen's fidelity to his convictions cost him a princely fortune, and the mills passed in 1827 into the hands of a firm with, perhaps, less lofty but more practical views. By the year 1787 there were nineteen cotton spinning-mills in Scotland.

Although all the great inventions which revolutionized the spinning trade were of English origin, many adaptations which greatly facilitated the working of spinning machinery were devised by the ingenuity of Scotch manufacturers. Cartwright's power-loom was introduced into Glasgow in 1793, by James Lewis Robertson, who, when on a visit to London, had seen it in operation in the hulks. He obtained and brought away two, which he had fitted up in a cellar in Argyle Street, the motive power being a large Newfoundland dog which walked inside a revolving drum or cylinder. In the following year about forty power-looms were fitted up in a factory at Milton, near Dumbar-ton, for weaving printing-calicoes, and in 1801 John Monteith erected a factory for the accommodation of 200 looms at Pollokshaws. The looms were subsequently adopted in 1805 by Archibald Buchanan for the Catrine Mills; and as the apparatus improved in efficiency its progress became rapid, new power-loom factories being erected almost every year thereafter in Glasgow, till in 1817 there existed fifteen factories containing 2275 looms.

Glasgow and Paisley manufacturers having been from very early times engaged in the linen, cambric, and lawn trade, to which in the latter town in the year 1760 the manufacture of silk gauzes was added, it was natural that on the introduction of cotton spinning the attention of weavers should be directed to the finer and more delicate fabrics into which cotton fibre can be wrought. Muslins, therefore (plain for the most part in Glasgow, and fancy ornamented in Paisley), were among the earliest and principal cotton fabrics produced on the looms of the west of Scotland. About the year 1780 James Monteith, the father of Henry Monteith, the founder of the great print-works at Barrowfield, and of the spinning and weaving mills at Blantyre, warped a muslin web, the first attempted in Scotland; and he set himself resolutely to try to imitate or excel the famous products of Dacca and other Indian muslin-producing centres. As the yarn which could then be produced was not fine enough for his purposes, he procured a quantity of "bird-nest" Indian yarn, and employed James Dalziel to weave a 6-4th 12<sup>oo</sup> book with a hand-shuttle, for which he paid him 21d. per ell for weaving. It is worthy of remark that the same kind of web is now wrought at 2½d. per ell. The second web was wove with a fly shuttle, which was the second used in Scotland. The Indian yarn was so difficult to wind that Christian Gray, wife of Robert Dougall, bellman, got 6s. 9d. for winding each pound of it. When the web was finished Mr. Monteith ordered a dress of it to be embroidered with gold, which he presented to Her Majesty Queen Charlotte."<sup>1</sup>

Once fairly established, the muslin trade and various other cotton manufactures developed with extraordinary rapidity, and diverged into a great variety of products which were disposed of through equally numerous channels. Among the earliest staples, along with plain book muslins, came mull, jacconets or nainsooks, and checked and striped muslins. Gingham and pullicats formed an early and very important trade with the West Indian market, as well as for home consumption. These articles for a long period afforded the chief employment to the hand-loom weavers in the numerous villages around Glasgow and throughout the west of Scotland. The weaving of sprigged or spotted muslins and lappets was subsequently introduced, the latter not having been commenced till 1814. Although the weaving of ordinary grey calico for bleaching or printing purposes has always held and still retains an important place among Glasgow cotton manufactures, it has never been a peculiar feature of the cotton industry; and the very extensive bleaching and print-works of the locality have always been supplied with a proportion of their material from the great cotton manufacturing districts of Lancashire.

About the end of last century the ornamentation of plain muslins with hand-sewed patterns began to be practised as a domestic industry in the west of Scotland; and by rapid degrees it rose into high reputation, many manufacturers

<sup>1</sup> Cleland's *Former and Present State of Glasgow*, 1840.

having realized large fortunes from the trade during its palmy days. The trade continued to flourish till the great commercial crash of 1857, which compelled many to retire from it, and others thereafter gradually withdrew, till it dwindled down to its present comparatively humble proportions. When in its zenith it afforded home employment to large numbers of females not only throughout the west of Scotland, but across the Irish Channel. Elaborate and artistic patterns were prepared for embroidering by specially trained designers; these patterns were printed, from engraved cylinders of wood, on the surface of suitable pieces of muslin, on which also was printed the number of the pattern, the length of time allowed for sewing it, and the price to be paid by the agent or manufacturer on the work being satisfactorily performed.

**Thread.** *Thread Manufacture*, a branch of trade very intimately related to ordinary textiles, is carried on on a large scale in Glasgow, and is the outstanding feature in the industries of Paisley. From that town there are probably sent out a greater length and weight of sewing thread than from all the other thread factories of Great Britain combined. Within a comparatively recent period, what constituted the staple trade of the town from thirty to forty years ago—shawl weaving—has greatly decreased, whilst the manufacture of cotton thread has considerably extended, principally through the almost universal introduction of sewing machines for dressmaking and other purposes. These machines, by requiring for the most part double threads, and by increasing the sewed work while lessening the cost of dressmaking, have very greatly increased the demand for thread.

The process of thread-making is so well known that few words are required to describe it. It is chiefly carried on by twistors, who purchase the yarn needed from cotton-spinners. To spin from the raw cotton, and twist yarn into thread, in the same factory, would require premises of much greater extent than any hitherto employed; or the spinning and twisting would need to be confined to a small range of numbers. The manufacture of sewing cotton is, therefore, generally understood as confined to the twining or doubling of yarn previously obtained from the spinner. When the yarn is received it is tested by being reeled from the cops, and having a certain length of hank weighed. This is called sizing. The next process is cop-winding—that is, winding it from the cop on bobbins—two or three ply as required. These bobbins are taken to the twisting frame and twisted first two ply, then this is doubled or tripled for four or six cord as required. Each number of yarn has its own twist, that is, the number of turns it gets per inch. When finished the thread is taken from the twisting frames, and according to the size so much of it is wound upon a large bobbin, from which it is reeled into hanks for bleaching or dyeing. After bleaching it is given out in bundles to the hank-winder, who winds it on a large bobbin, and that in its turn is handed to the spooler, who fills the bobbin with a certain length of thread—say 100, 200, or 300 yards, and upwards. The largest portion of thread made is sold on spools, which contain a great variety of lengths. After spooling the bobbins are labelled on each end; they are then arranged in dozens and grosses, papered and stringed, and finished for the market. The qualities principally used are 3, 4, and 6 cord—the greatest portion of the sewing-machine thread being 6 cord. A large quantity of thread is now polished, and is known in the trade as *glacé*. Of late there has been an increasing demand for crochet thread, the manufacture of which is somewhat similar to the process for ordinary sewing cotton.

**Spools.** The spools are made of birch or ash—preferably the former—and the wood is obtained chiefly from the Highlands of Scotland. Finished spools are made in large quantities by wood turners in various localities, particularly in the Lake districts in the north of England, and find their way to those thread manufacturers who are unable to turn the whole of the spools they require. The birch, to be in proper condition, is cut when the sap is out of it, and partially rinded at once to prevent souring. After remaining in stock till perfectly dry it is sawn up into cross sections, from which are blocked out the various diameters of spools wanted. The blocking machines now in use over the whole country were invented at Ferguslie Works, Paisley (Messrs. J. & P. Coats), and by their employment a great saving in both wood and labor is effected. These blocks are placed on the self-acting

laths, which turns them out finished spools with great rapidity.

*Statistics of Scotch Cotton Trade.*—In the year 1787 there were only nineteen cotton mills in the whole of Scotland, of which Lanarkshire and Renfrewshire each possessed four. In the report of Leonard Horner as one of the Factory Commissioners, dated 1834, it is stated that "in Scotland there are 134 cotton mills; with the exception of some large establishments at Aberdeen and one at Stanley near Perth, the cotton manufacture is almost confined to Glasgow and the country immediately adjoining, to a distance of about 25 miles radius; and all these cotton mills, even including the great house at Stanley, are connected with Glasgow houses or the Glasgow trade. In Lanarkshire, in which Glasgow is situated, there are 74 cotton factories; in Renfrewshire, 41; Dumbartonshire, 4; Bute-shire, 2; Argy'eshire, 1; Perthshire, 1. In these six counties there are 123 cotton mills, nearly 100 of which belong to Glasgow. . . . In Lanarkshire there are 74 cotton mills, 2 woollen and 2 silk factories; 78 steam-engines and 5 water wheels; total horse-power, 2914, of which steam 2394, water 520. Total persons employed in factories, 17 969" In 1838, according to the report on hand-loom weavers by Mr. Symons, there were more than 37,000 hand-loom weavers in the west of Scotland directly connected with cotton weaving. According to a Parliamentary return the cotton industries of Lanark, Ayr, and Renfrew in 1850 were distributed in 146 factories, of which 94 were in Lanark, 51 in Renfrew, and 4 in Ayr. These establishments had jointly 1,410,054 spindles and 21,575 power-looms, the whole of which gave occupation to 31,710 persons. In 1861 the same counties possessed 143 factories, with an aggregate of 1,577,584 spindles and 28,085 power-looms, in all employing 36,908 hands. In the year 1875 the three counties possessed 84 cotton factories, in which there were 1,526,990 spinning and doubling spindles and 27,489 power-looms, the whole cotton industry giving occupation to 33,276 individuals. The total number of factories in Scotland in the same year was 96, containing 1,711,214 spindles and 29,171 power-looms, giving employment in all to 35,652 persons, of whom nearly 30,000 were females above thirteen years of age.

It may be gathered from this table that the Glasgow district has still a practical monopoly of the Scotch cotton trade, not more than 10 per cent. of the work being distributed among counties other than the three above named. On the other hand Scotland, taken altogether, does not employ in cotton factories more than one-thirteenth part of the number of operatives in the enormous cotton industries of England, while Scotch spindles are only as one to twenty-five of the English, and power-looms are as one to about fourteen.

In some of the Glasgow establishments the only fabrics manufactured are printers' cloths, grey calicoes, jacobets, and fancy textures, which are subsequently prepared for the market by calico-printing. In the case of other exclusive attention is bestowed on the weaving of colored goods, such as ginghams, Oxford and other fancy shirtings, dress stripes, &c., and several devote their attention peculiarly to the weaving of muslins and similar delicate fabrics.

#### *Cotton Manufacture in Ireland.*

Little notice has been taken of the cotton manufacture in Ireland, the great seat of the once rival flax manufacture; but it may be observed that cotton has not furnished any considerable employment for capital and labor in that island. Some attempts to introduce the manufacture of cotton goods in Ireland were made as early as 1770, but the manufacture continued on a very limited scale until the year 1790. After this period the progress was more considerable, although out of all comparison with what took place during the same time in Great Britain; indeed, its products have never been such as to enter into competition with those of England.

The chief seat of this manufacture in Ireland is Belfast, and the district of country situated within twenty miles of that town. But a good many calicoes, muslins, and cotton checks are made in Dublin, Balbriggan, Bandon, and Cork. All these goods are consigned to factors in Dublin for sale, except a part of the calicoes, which the manufacturers sometimes dispose of to printers on the spot.

The cotton trade of Ireland is, as already indicated, at the present day of limited extent, embracing only 8 factories, and giving employment to about 3000 persons.



Statistics of Progress of the Cotton Manufacture.

The enormous increase which has taken place in the production and consumption of cotton, as shown in the accompanying tables, implies a corresponding increase in the manufacture and consumption of yarn and cloth. It would be difficult to find any trade which has exhibited so rapid a development, or which has attained such vast proportions, as the British cotton manufacture. It has for three-quarters of a century gone on extending from year to year, working up all the cotton which the world could supply, and producing goods in enormous quantities which have found their way into every part of the globe. At the beginning of the century less than a hundred thousand

bales of cotton were sufficient for the requirements of Great Britain, and now about three and a half millions of bales are required. The quantity of yarn and piece goods produced for home and foreign consumption amounted in 1863 to 404,979,000 lb in weight, and in value to £59,796,000; but in 1875, a year of great stagnation in the cotton trade, the production had reached 1,088,890,000 lb in weight, and £95,447,000 in value. Notwithstanding protracted periods of depression, and increased competition on the part of other nations, England at the present time employs more spindles than all the rest of the world combined.

Tables IV. and V. subjoined show the quantities of yarn

TABLE IV.—The quantities of Cotton Yarn spun, and the quantities exported and worked up at home, from 1819 to 1876.

Years.	Yarn produced.	Exported.	Consumed at Home.	Years.	Yarn Produced.	Exported.	Consumed at Home.
	<b>lb</b>	<b>lb</b>	<b>lb</b>		<b>lb</b>	<b>lb</b>	<b>lb</b>
1819	98,566,200	18,085,410	80,480,790	1848	518,840,000	131,500,141	387,439,859
1820	108,238,500	23,032,325	85,206,175	1849	566,910,000	148,275,885	418,634,115
1821	116,126,100	21,526,369	95,599,731	1850	529,380,000	124,241,100	405,138,900
1822	130,943,700	26,595,468	104,348,232	1851	593,910,000	131,587,577	461,422,423
1823	138,731,400	27,378,968	111,352,414	1852	665,190,000	129,386,924	535,804,076
1824	148,656,600	33,605,510	115,051,090	1853	685,440,000	129,190,507	556,249,495
1825	150,147,900	32,641,604	117,506,296	1854	693,659,000	147,128,000	546,531,000
1826	135,191,700	42,179,521	93,012,179	1855	750,278,000	165,493,000	584,785,000
1827	177,450,000	43,346,632	134,103,368	1856	797,800,000	181,495,000	616,305,000
1828	196,074,000	43,242,882	152,831,118	1857	738,400,000	176,621,000	561,779,000
1829	197,280,000	60,562,189	136,717,811	1858	812,513,000	200,017,000	612,496,000
1830	222,840,000	63,678,116	159,161,884	1859	874,982,000	192,206,000	682,776,000
1831	236,436,000	61,561,154	174,865,846	1860	965,993,000	197,343,000	768,650,000
1832	246,935,124	75,667,150	171,267,974	1861	899,902,000	177,848,000	722,054,000
1833	251,757,600	70,626,161	181,131,439	1862	373,352,000	88,554,000	284,798,000
1834	270,188,876	76,478,468	193,708,408	1863	404,979,000	70,678,000	334,301,000
1835	281,435,222	83,214,193	198,221,024	1864	432,829,000	71,951,000	360,878,000
1836	293,064,496	88,191,046	204,873,450	1865	618,040,000	98,563,000	519,477,000
1837	324,031,851	103,455,138	220,576,713	1866	774,928,000	134,835,000	640,093,000
1838	379,436,510	114,596,602	264,839,898	1867	839,984,000	164,276,000	675,708,000
1839	342,624,571	105,686,442	237,140,129	1868	876,653,000	174,538,000	702,115,000
1840	406,864,913	118,470,223	288,394,690	1869	816,949,000	169,518,000	647,431,000
1841	370,768,077	123,226,510	247,541,567	1870	942,460,000	186,078,000	756,382,000
1842	372,754,144	137,466,892	235,277,252	1871	1,072,850,000	193,480,000	879,370,000
1843	437,569,411	140,321,176	297,248,265	1872	1,040,380,000	211,940,000	828,440,000
1844	445,577,480	133,540,079	307,037,401	1873	1,077,920,000	214,687,000	863,233,000
1845	494,766,487	135,766,487	359,621,622	1874	1,129,525,000	220,599,000	899,926,000
1846	532,870,000	160,554,673	392,315,327	1875	1,088,890,000	215,490,000	873,400,000
1847	397,260,000	119,489,554	277,770,446	1876	1,131,056,000	232,150,000	898,906,000

TABLE V.—This Table, prepared by Messrs. Ellison and Co., gives the chief markets to which the cotton yarn and goods produced have been exported in the years quoted (the figures representing millions of yards and pounds).

	1830.	1835.	1840.	1845.	1850.	1855.	1860.	1865.	1870.	1875.
<b>PIECE GOODS.</b>										
To Germany and Holland.....	54·3	65·3	70·9	69·8	77·1	88·0	102·0	83·7	85·5	115·9
Portugal, Azores, and Madeira	22·2	36·1	38·9	42·6	50·0	60·3	62·9	43·6	64·6	70·6
Gibraltar and Malta.....	7·6	19·0	31·7	33·5	23·9	49·4	42·3	33·2	37·8	31·7
Italy and Austria.....	53·3	84·7	58·9	52·4	71·1	80·4	93·3	63·7	75·6	101·7
Turkey, Syria, and Egypt.....	33·5	37·3	58·0	137·0	165·6	358·6	312·0	313·9	635·4	356·2
West and South Africa.....	6·5	8·0	10·6	21·0	28·3	39·9	45·8	20·1	35·1	38·4
British North America.....	11·4	16·9	24·1	33·0	35·3	17·4	37·4	30·6	76·2	43·2
United States.....	49·3	74·9	32·1	31·2	104·2	184·6	226·8	126·5	103·3	79·8
W. Indies and Central America	56·9	78·2	104·2	112·5	146·9	168·3	158·0	191·9	212·7	195·9
Brazil.....	46·2	58·8	76·8	87·0	103·0	125·0	156·2	111·5	149·2	196·8
Other South American States..	26·3	39·6	73·5	72·3	75·2	103·4	175·5	86·2	156·4	115·1
British East Indies.....	62·2	51·8	145·1	229·3	314·4	467·4	825·1	563·2	923·3	1231·4
China and Hong Kong.....		11·2	13·5	108·4	73·2	74·0	228·0	136·0	417·3	436·0
Java and Philippine Islands...	4·7	11·6	16·4	25·9	31·1	44·8	101·2	58·1	60·9	90·6
Australia.....	1·2	2·3	5·2	10·5	15·7	13·4	22·4	25·8	27·9	46·3
Other Countries.....	19·0	16·8	24·7	25·3	43·2	52·8	192·3	153·4	191·5	395·3
<b>Total.....</b>	<b>444·6</b>	<b>557·5</b>	<b>790·6</b>	<b>1091·7</b>	<b>1358·2</b>	<b>1937·7</b>	<b>2776·2</b>	<b>2031·4</b>	<b>3252·8</b>	<b>3559·9</b>
<b>Total value.....</b>	<b>£14·1</b>	<b>£15·2</b>	<b>£16·3</b>	<b>£18·0</b>	<b>£20·5</b>	<b>£26·1</b>	<b>£40·3</b>	<b>£45·2</b>	<b>£52·5</b>	<b>£53·6</b>
<b>YARN.</b>										
To Russia.....	18·5	21·1	16·9	18·2	4·8	4·0	3·1	1·7	2·8	4·0
Germany and Holland.....	29·1	41·7	63·5	65·4	70·8	78·1	92·4	45·8	72·7	76·1
Italy and Austria.....	8·4	7·0	11·5	13·0	15·6	23·6	20·5	15·5	18·2	23·6
Turkey.....	1·5	1·6	3·3	5·8	4·7	9·0	19·6	8·2	14·2	15·9
British East Indies.....	4·9	5·4	16·0	16·8	21·0	28·6	30·7	15·2	31·0	32·5
China and Hong Kong.....		2·8	1·8	2·6	3·1	2·8	6·6	1·2	20·8	29·4
Other Countries.....	2·2	3·6	5·4	13·3	11·9	19·1	22·2	15·6	23·6	29·0
<b>Total.....</b>	<b>64·6</b>	<b>83·2</b>	<b>118·4</b>	<b>135·1</b>	<b>131·4</b>	<b>165·5</b>	<b>197·3</b>	<b>103·2</b>	<b>187·7</b>	<b>215·5</b>
<b>Total value.....</b>	<b>£4·1</b>	<b>£7·7</b>	<b>£7·1</b>	<b>£6·9</b>	<b>£6·4</b>	<b>£7·2</b>	<b>£9·9</b>	<b>£10·3</b>	<b>£14·6</b>	<b>£13·2</b>

TABLE VI.—An Estimate of the Weight and Value of the Total Production of Cotton Manufactures in Great Britain, with the Cost of Cotton Consumed, and the Balance remaining for each of the past Ten Years.

	1867.	1868.	1869.	1870.	1871.	1872.	1873.	1874.	1875.	1876.
Cotton consumed.....	964,617,000	998,197,000	999,019,000	1,071,770,000	1,305,450,000	1,178,345,000	1,244,128,000	1,328,129,000	1,330,000,000	1,574,900,000
Less waste in spinning.....	114,533,000	119,544,000	123,070,000	128,510,000	132,600,000	134,985,000	162,230,000	145,604,000	141,090,000	143,300,000
Yarn produced.....	909,984,000	878,653,000	875,949,000	943,260,000	1,072,850,000	1,043,360,000	1,077,898,000	1,182,525,000	1,188,910,000	1,431,600,000
Exported in yarn.....	164,276,000	174,558,000	169,518,000	186,078,000	198,480,000	211,940,000	214,637,000	230,500,000	215,400,000	238,150,000
Exported in piece goods, apparel, etc.....	623,562,000	648,678,000	658,195,000	616,233,000	679,520,000	698,840,000	698,333,000	728,000,000	713,000,000	728,000,000
Retained for home consumption and stock.....	121,146,000	155,417,000	148,236,000	146,950,000	194,850,000	133,580,000	175,000,000	174,025,000	160,510,000	165,450,000
Total as above.....	829,984,000	878,653,000	875,949,000	943,260,000	1,072,850,000	1,043,360,000	1,077,898,000	1,182,525,000	1,188,910,000	1,431,600,000
Declared value of yarn exported.....	18,600,000	14,700,000	14,157,000	14,671,000	15,055,000	16,710,000	15,876,000	14,516,000	13,170,000	12,700,000
Declared value of piece goods, apparel, etc., exported.....	57,232,000	57,243,000	57,060,000	61,434,000	63,322,000	60,900,000	60,185,700	65,234,430	65,000,000	65,000,000
Estimated value of home consumption, etc.....	19,368,000	19,665,000	14,900,000	17,050,000	22,530,000	15,800,000	20,000,000	20,110,000	18,212,000	17,777,000
Total value of goods produced.....	95,200,000	91,717,000	86,197,000	93,155,000	101,907,000	102,370,000	104,612,000	100,560,430	96,482,000	95,477,000
Cost of cotton consumed.....	41,202,000	40,899,000	43,772,000	42,145,000	46,810,000	45,054,000	45,441,000	46,225,900	46,530,000	52,900,000
Balance left for wages, other expenses, interest of capital, and profits.....	46,178,000	50,728,000	42,425,000	51,000,000	55,097,000	57,316,000	59,171,000	54,334,530	49,952,000	42,577,000

TABLE VII.—A Comparative Statement of the Quantities of Yarns and Piece Goods, and the Aggregate Value of these and other Cotton Products Exported to the various Countries of the World, with the Population of each Country, and the value of British Cotton Products Consumed by each per Head, in the years 1851, 1861, 1871.

	Population in 1000's.			Yarn exported, in 1000's of lb.			Piece Goods exported in 1000's of Yards.			Value of Yarn and all kinds of Cotton Goods Exported.			Value of Exports per Head.			
	1851.	1861.	1871.	1851.	1861.	1871.	1851.	1861.	1871.	1851.	1861.	1871.	1851.	1861.	1871.	
<b>EUROPE.</b>																
Russia, European and Asiatic	67,995	75,995	81,995	5,947	8,261	8,478	1,569	4,797	3,761	325,117	355,948	566,649	£	7s	11s	
Sweden and Norway	4,980	5,277	5,545	1,464	963	3,941	2,217	8,789	6,425	95,305	105,771	229,541	4	10	12	
Denmark	2,402	2,678	2,791	1,908	2,145	2,434	3,421	5,413	3,599	121,126	160,089	305,593	12	13	15	
Germany and Holland	38,194	39,465	42,062	67,471	90,336	85,427	76,185	106,535	107,410	5,064,712	6,756,059	10,525,362	30	40	50	
Austrian possessions	39,850	33,673	35,994	4,953	4,816	5,064	30,879	19,901	14,049	445,879	500,172	436,317	9	8	7	
Belgium	4,136	4,624	5,087	1,979	962	1,994	2,122	6,354	6,401	206,708	214,380	622,798	11	11	12	
France and Switzerland	39,178	39,825	40,812	69	1,702	4,531	3,926	21,331	28,854	158,963	174,109	2,908,739	40	45	50	
Channel Islands	143	144	145	9	9	9	9	9	9	9	9	9	9	9	9	
Spain, Gibraltar, etc.	15,487	16,666	16,661	163	633	410	37,312	31,571	60,234	671,995	666,329	588,000	1	1	1	
Portugal, the Azores, etc.	3,798	3,964	4,247	918	402	148	49,746	69,416	69,416	674,907	649,520	891,811	43	45	47	
Italy and Italian Islands	23,800	25,003	26,711	17,931	24,838	17,130	85,928	114,190	85,851	1,838,074	2,056,983	3,449,197	19	21	23	
Greece	1,211	1,338	1,458	1,609	1,985	1,728	21,567	19,458	64,059	361,179	353,080	518,590	11	11	11	
Turkey in Europe	15,740	15,550	16,035	7,421	7,564	14,466	104,771	158,917	167,180	1,745,730	2,183,098	2,437,506	9	9	9	
Total for Europe and Asiatic Russia	248,312	263,308	279,819	100,008	139,100	127,161	600,741	537,689	600,621	11,507,487	12,638,523	23,771,628	11	12	13	
<b>ASIA.</b>																
Turkey in Asia	16,050	16,250	16,463	1,817	2,513	4,311	23,179	91,927	74,637	834,046	1,164,058	1,434,656	4	5	6	
Persia, Arabia, etc.	30,730	32,250	33,800	..	..	..	..	1,808	443	..	32,505	6,454	..	..	..	
Cochin China, Siam, etc.	20,000	31,000	22,000	..	1,674	2,250	..	44,527	71,458	..	719,804	1,232,854	..	..	..	
China	375,000	400,000	440,000	4,319	6,734	8,929	114,976	945,654	469,089	1,609,829	3,496,832	7,030,259	1	1	1	
Japan	30,000	32,000	35,000	..	264	1,017	10,217	1,154	37,891	..	86,658	1,649,701	..	..	..	
Indian Islands	30,000	32,000	35,000	846	811	1,049	49,206	82,569	44,392	792,823	1,444,183	691,000	9	10	11	
India, Burmah, Ceylon	190,000	220,000	241,000	25,728	32,128	32,123	860,667	753,831	950,382	5,628,925	10,307,494	13,801,908	7	8	9	
Egypt and Abyssinia	10,000	11,550	13,000	1,311	1,061	6,252	45,119	77,249	399,071	673,849	926,505	1,134,241	1	1	1	
Total for Asia and Egypt	601,780	755,050	826,268	33,839	56,610	55,401	592,147	1,206,919	1,917,354	9,036,391	16,708,030	29,237,331	9	10	11	
<b>AFRICA.</b>																
Tripoli, Tunis, Algeria, and Morocco	8,900	8,990	10,871	2	..	..	28	1,996	6,967	13,187	32,567	164,980	211,944	94	9	10
West Coast and Islands	2,900	3,600	3,700	3	6	34	17,626	39,765	65,895	322,394	581,435	839,346	39	39	42	
South Coast	950	950	950	9	..	..	10,490	14,835	18,815	156,730	304,745	476,220	169	170	173	
East Coast and Islands	4,150	5,100	5,500	..	..	..	8,805	16,477	15,689	79,771	217,156	328,619	4	5	6	
Interior of Continent	32,000	36,000	40,000	..	..	..	..	..	..	..	..	..	..	..	..	
Total (except Egypt, etc.)	47,800	53,020	60,021	14	6	33	35,423	74,147	96,567	549,362	1,310,308	1,764,596	2	3	4	
<b>AMERICA.</b>																
British North America	2,517	3,230	4,154	831	256	153	26,476	39,296	42,647	721,097	894,675	1,016,480	69	70	72	
United States	22,192	31,445	36,244	79	..	..	978	76,590	129,701	1,977,236	3,599,098	5,108,083	30	35	40	
Mexico	7,860	8,295	9,175	..	136	71	10,555	18,789	86,121	343,495	357,445	645,083	7	8	9	
Central America and British Honduras	2,000	2,250	2,736	194	267	..	27,981	15,126	13,015	369,164	214,398	195,641	67	68	70	
British West Indies and Guiana	1,059	1,108	1,275	12	..	..	37,709	39,545	39,103	535,428	508,916	677,730	12	13	14	
Haiti	650	660	673	..	..	..	7,299	9,465	8,140	144,496	172,875	179,738	6	6	7	
Foreign West Indies	1,720	1,830	2,100	36	..	..	51,989	53,129	17,870	785,407	848,149	1,226,501	100	100	100	
New Granada	3,800	3,936	3,900	6	..	161	11,471	86,572	92,001	185,748	386,132	1,618,055	19	19	19	
Venezuela	1,270	1,350	1,400	8	..	..	14,827	19,313	13,633	211,130	307,978	341,265	20	21	21	
Ecuador	750	800	1,108	8	..	..	1,943	8,955	763	82,314	129,392	13,910	10	10	10	
Total—Mexico, W. Indies, etc.	17,309	18,996	21,265	248	403	323	163,296	199,237	374,694	2,535,254	3,142,128	4,986,519	25	26	27	
Brazil	7,000	8,100	9,858	3	..	..	134,431	168,298	185,310	2,018,239	3,549,891	5,973,509	19	19	19	
Paraguay, Uruguay, La Plata, etc.	8,805	9,650	4,000	9	..	..	14,127	58,976	75,232	337,000	806,712	1,301,481	11	12	13	
Chili, Peru, Bolivia, etc.	4,975	6,100	6,460	23	..	..	71,968	77,799	86,143	1,151,308	1,216,720	1,308,739	14	15	16	
Total for South America	15,299	17,850	20,318	44	..	..	239,546	300,073	336,894	3,405,363	4,645,442	6,849,739	20	21	22	
Total for America	58,296	71,621	83,961	1,302	606	1,263	498,900	613,496	778,738	6,638,966	10,010,846	14,867,700	20	21	22	
<b>AUSTRALIA AND SOUTH SEA ISLANDS.</b>																
Total for the world	1,041,456	1,164,200	1,261,284	148,961	178,374	168,977	1,543,158	2,568,411	3,411,008	20,008,336	40,783,064	72,678,946	9	10	11	

produced, and the principal markets to which yarn and goods are consigned, for the years stated. From Table VI, above, it appears that the value of the production of the cotton manufacture of Great Britain in 1875 exceeded

£95,000,000 sterling, of which upwards of £77,000,000 was the value of goods and yarn made for exportation. Table VII. (page 448) presents a synoptical view of the cotton industry of Great Britain.

In the year 1812, when Crompton applied to Parliament for a remuneration for his invention, he found by an accurate investigation as he could make that the number of mule spindles in the country was between four and five millions; and Kennedy, in his memoir of Crompton, has stated that the number in 1829 had increased to seven millions. In 1817, he estimated the number of persons employed in the spinning of cotton in Great Britain at 110,763, and the number of spindles in motion at 6,645,833, and the quantity of yarn produced at 99,687,500 lb. The quantity of cotton yarn spun in 1832 was 222,000,000 lb, of which 132,000,000 lb was manufactured into cloth, giving employment to 203,373 looms; but in 1853 the yarn spun was 685,440,000 lb.

A tolerably accurate estimate of the capital now invested in the cotton trade and of the persons dependent upon its prosperity may be formed from the following particulars taken from the reports of the factory inspectors. In 1871 the cost of the buildings and machinery employed in the trade was £57,000,000, whilst the floating capital was not less than £30,000,000, making together at least £87,000,000, sterling. From a Parliamentary return issued in August, 1875, it appears that in that year there were in the United Kingdom 2655 factories employed in spinning, weaving, and other industries connected with the manufacture of cotton. Of that number 2542 were in England and Wales, 105 in Scotland, and only 8 in Ireland. These factories contained 71,166 carding machines, 2901 combing machines, 37,515,772 spinning spindles, 4,366,017 doubling spindles, and 463,118 power looms. The total number of persons employed was 479,515,—of these 440,336 being in England, 36,104 in Scotland, and 3075 in Ireland. Of the total number 115,391 were adult males, 258,667 were females above thirteen years of age, 38,557 were males between thirteen and eighteen, and the remainder were half-time boys and girls in about equal numbers. Probably the number of persons directly or indirectly dependent on the cotton trade in the United Kingdom is not much under two millions.

As successive mechanical inventions came to be applied to the manufacture, they changed the principle of production, and made what had been nearly wholly a product of labor become almost entirely a product of capital. Important results flowed from this change. It enabled Great Britain, the principal holder of these machines, to become the furnisher of a commodity which up to that time had been brought at a great expense from India. It further enabled her to reduce its cost, and render what till then had been accessible only to the rich, and of limited sale, an article of general wear. During the long struggle which took place between machinery and hand labor, this country continued to be the nearly exclusive possessor of the machines by which the reduction of cost was effected. Having in consequence, in a great measure, a monopoly of the supply, she was enabled to reap that harvest of prosperity which so unusual a combination of circumstances was calculated to produce; an improvement in the condition of every class of the community followed the advance of the manufacture.

To preserve the pre-eminence gained by this great branch of British industry against all the competitors which it has had to encounter, has tasked to the utmost the inventive genius and energies of all connected with it. The rival manufacturers in India, Europe, and America have put forth all their resources to impair or destroy the supremacy which England has established in the markets of the world. In almost all cases, not even excluding our own colonies and dependencies, these rivals, in addition to any natural advantages which they might possess, have been aided by the establishment of high protective tariffs.

Fears have often been expressed that the lower wages for which the laborers of some other countries can work, may ultimately enable them to take the manufacture out of our hands. In reply to this, it may perhaps be sufficient to recall to our readers the small part of the cost of the commodity which now belongs to the labor of the hand, and the daily diminution which is taking place even of that part, by the introduction of new mechanical substitutes. Thus, for example, in 1767 each spindle required a person

to work it; but now one man, with the aid of two pieces to take up and join his broken ends, can work two thousand spindles. In speaking on this subject in 1874, Mr. Hugh Mason, then president of the Manchester Chamber of Commerce, endeavored to reassure some of his timid colleagues by such facts as these, viz., that in 1850 the export from this country of cotton cloth had attained for the first time the amount of 1,000,000,000 yards; that in 1860 the exports for the first time had reached 2,000,000,000 yards; and that in the year 1870 the export of manufactured cotton goods from this country had amounted for the first time to 3,000,000,000 yards. Although foreign competitors are able in common with ourselves to buy the best machinery that can be made, and have free and cheap imports of the raw material, in addition to any special advantages as to cheaper labor and longer hours or otherwise which they may possess, and although great advances have taken place in the wages of the operatives employed in our factories, while there has been great diminution in the hours of labor during these two decades, and these are now still further reduced, we have still almost undisputed possession of the home trade, and our foreign trade has at the same time increased from 1,000,000,000 yards to 3,000,000,000 yards of our manufactured cotton cloth. The quantity of cotton piece goods exported from the United Kingdom in 1876 exceeds that ever exported before in any one year, and amounts to 3,668,582,100 yards, an average of more than 10,000,000 yards a day.

The following table presents a summary of the cotton industry of Great Britain for the year 1876:—

TABLE VIII.—*Details of Cotton Industry.*

Number of factories.....	2,655
Number of spindles (including doubling).....	41,881,789
Number of power looms.....	463,118
Number of persons employed.....	479,515
Estimated capital invested.....	£90,000,000
Quantity of cotton consumed (in bales of 400 lb each).....	3,185,942
Cost of cotton consumed.....	£32,855,000
Quantity of yarn produced.....	1,131,056,000 lb
Quantity of cloth manufactured.....	898,906,000 lb
Quantity of yarn and goods made for home consumption.....	163,906,000 lb
Quantity of yarn and piece goods exported.....	967,150,000 lb
Annual value of home consumption of yarns and cloth.....	£17,777,000
Annual value of exports of yarn and cloth.....	£72,079,000
Total annual value of cotton manufactures.....	£89,856,000

The rapid growth and enormous extent of the cotton industry, the numerous vicissitudes through which it has passed, the elasticity which it has shown in periods of deep depression, and the vitality and latent power which, notwithstanding all past development and progress, it still possesses, may well excite astonishment and admiration. It is a proud memorial of the genius, and energy, and enterprise of the men who have conducted it from its small beginnings to its present gigantic proportions. Whilst at home the consumption of cotton goods has been steadily increasing, the export trade with all its fluctuations remains more than double that in any other article of commerce. The free-trade policy of Britain promotes an interchange of commodities with all other countries. We are as ready to purchase what they can offer as we are to sell them our goods, and even in the same branch of manufacture there are often shades of difference in the fabrics produced, upon which taste, or fashion, or caprice has fixed an arbitrary value, which may make the exchange of goods by rivals mutually beneficial. This example and influence are beginning to lead other countries to perceive and understand that isolation and rigid protection can confer but little real benefit even upon themselves, and must eventually injure those who thus stand aloof from the commercial comity of nations.

#### *Cotton Industry on the Continent.*

The progress and present state of the cotton industry on the continent of Europe have been carefully ascertained by Messrs. Ellison & Co., from their own special correspondents in all the manufacturing centres. The statistics furnished by them, in their review of the cotton trade for the season 1875-76, are as follows:—

*Russia and Poland.*—Spindles in Russia, 2,800,000; in Poland, 200,000; total, 3,000,000. Average consumption of cotton 60 lb per spindle per annum.

Sweden and Norway.—Spindles in Sweden, 245,000; in Norway, 69,000; total, 305,000. Average consumption of cotton 65 lb per spindle per annum.

Germany.—The estimates vary, but the following is the nearest approximation attainable:

	Spindles.
Austria.....	1,650,000
Bararia.....	875,000
Prussia.....	700,000
Saxony.....	500,000
Baden.....	350,000
Württemberg.....	315,000
Hanover, Oldenberg, &c.....	260,000
Total.....	4,650,000

Some estimates exceed this, and make the total 5,000,000 or 5,200,000. Average consumption of cotton for all Germany about 55 lb per spindle per annum.

Austria.—Spindles in Austria, 1,555,000, including 740,000 in Bohemia, and 500,000 in the Vienna district. Average rate of consumption of cotton 67 lb per spindle per annum.

Switzerland.—According to a recent Government estimate, made in view of negotiations for a new treaty of commerce, the number of spindles is 1,854,091. Average consumption of cotton, used chiefly for the production of fine goods, about 25 lb per spindle per annum.

Holland.—The estimated number of spindles is 230,000. Average consumption of cotton about 60 lb per spindle per annum.

Belgium.—Estimated spindles, 800,000. Average consumption of cotton about 50 lb per spindle per annum.

France.—The total number of spindles is about 5,000,000, and the average consumption of cotton 42 lb per spindle per annum.

Spain.—Estimated number of spindles, 1,750,000. Average consumption of cotton about 46 lb per spindle per annum.

Italy.—The total number of spindles is about 800,000. The consumption of cotton averages 56 lb per spindle per annum.

The total number of spindles at work in the various manufacturing countries of Europe is 19,440,000, to which must be added 2,500,000 in the United States, and 39,000,000 in Great Britain, making a total of 67,940,000, requiring not less than 7,000,000 bales of cotton of 400 lb each, or at least 2,800,000,000 lb, to keep them in operation.

*Cotton Manufacture in the United States.<sup>1</sup>*

The Government of the United States at an early period evinced great anxiety to promote the establishment of the cotton manufacture in the northern part of the Union. In tracing the rise of the American cotton manufacture, we shall refer chiefly to the public documents, in which its growth is studiously detailed and the difficulties it has had to struggle with are anxiously dwelt upon.

Before the year 1791, America possessed no manufacture except for domestic production and family use. But it appears from a report of the secretary to the American treasury, drawn up in 1810, that a cotton-mill was erected in the State of Rhode Island in that year; that another mill was erected in the same State in 1795, and two more in the State of Massachusetts in 1803 and 1804; that during the three succeeding years ten more were erected in Rhode Island, and one in Connecticut, making together fifteen mills, working about 8000 spindles, and producing about 300,000 pounds of yarn in the year; that by a return which was made at the date of the report, eighty-seven additional mills had been erected by the end of the year 1809, which, with others soon to be in operation, would, it was estimated, work more than 80,000 spindles at the commencement of 1811. The capital required to carry on the manufacture was believed to be at the rate of sixty dollars per spindle, each producing annually from forty-five pounds of cotton about thirty-six pounds of yarn, of the average worth of one dollar twelve and a half cents per pound. Eight hundred spindles employed forty persons, viz., five men and thirty-five women and children.

We learn the farther progress of this manufacture from a report of the House of Representatives, presented in the spring session of 1816. The report states that the quantity of cotton manufactured in the year 1815 was 90,000 bales, a quantity nearly equal to that used in the cotton manufacture of France; and that the quantity used in 1810 was 10,000 bales; in 1805, 1000 bales; and in 1800, 500 bales; and gives the following statement of the condition of the cotton industry in the United States:—

Capital employed.....	40,000,000 dollars.
Males employed from the age of seventeen and upwards.....	10,000
Women and female children.....	66,000

<sup>1</sup>[Expression of oil from cotton-seed after decortication, but more recently after using attrition machines to remove the lint, has grown in the United States into a large industry since 1880, capable of adding one-fourth to the value of the cotton crop.—See Vol. XVII. pp. 760, 767.—Am. Ed.]

Boys under seventeen years of age.....	24,000
Cotton manufactured, 90,000 bales.....	27,000,000 lb.
Cotton cloth of various kinds manufactured 81,000,000 yards.	
Cost.....	24,000,000 dollars.

At the date of this report the duty upon cotton goods imported into the United States was 15 per cent.; but before charging it, 10 per cent. was added to the invoice, and the duty thus raised to 16½ per cent. Upon the recommendation of the committee, 10 per cent. more was imposed; and the whole being charged upon £110 for every £100 of net value brought it up to 27½ per cent. Besides this, it was ordered that all cotton goods below 13½d. per yard should be rated at 13½d., and the difference added to the amount of the invoice before calculating the duty.

New tariff Acts were successively passed in 1824, 1828, 1832, and 1864, in each of which the duty upon cotton goods imported was declared to be 25 per cent. *ad valorem*, the coarser fabrics being rated as in 1816.

The manufacture, under this protection against foreign competition, rapidly increased. Power-loom works were erected; the most approved processes both in spinning and weaving were adopted; and the business was generally successful. The manufacture is no longer confined to the States of New York and Rhode Island and the New England States, though in those it has been greatly extended. In other Northern States, such as New Jersey, Pennsylvania, Delaware, Maryland, Ohio, and Indiana, new mills have been erected; whilst in the Southern States, especially in Alabama, Georgia, North and South Carolina, Mississippi, Virginia, etc., the manufacture as well as the growth of cotton has become an important industry. The following statement (Table IX.) shows the progress already made:—

	Number of Mills.	Number of Spindles.	Average size of Yarn.	Average consumption of Cotton per Spindle.	Quantity of Cotton used.	Quantity of Cotton used.
			No. lb	lb	lb	Bales.
1869						
North...	...	6,538,494	28	60-70	...	...
South...	...	225,063	12½	138-12	...	...
Total...	...	6,763,557	27½	64-88	...	...
1870						
North...	...	6,851,779	28½	50-87	...	...
South...	...	262,221	12½	124-23	...	...
Total...	...	7,114,000	28½	52-93	...	...
1874						
North...	...	8,927,764	28-56	56-86	507,790,099	1,094,387
South...	...	487,629	12-6	122-53	59,793,774	128,526
Total...	...	9,415,283	27-73	60-29	567,583,873	1,222,913
1875						
North...	694	9,057,543	28-42	56-25	509,009,613	1,097,001
South...	181	481,821	12-67	140-57	67,733,140	145,079
Total...	875	9,539,364	27-60	60-46	576,742,753	1,242,080

Under the influence of protecting duties the prosperity of the American cotton manufacture has continued to increase, until the anticipated condition has at length been reached when the product exceeds the demand for the home consumption. As the surplus could not be disposed of in foreign markets, the manufacturers have had to experience similar distress to that which befell the cotton manufacturers of France in the years from 1827 to 1832. Owing, however, to the different circumstances of the two countries, this state of things in America may be expected to be of a more temporary character. The depression existing in the cotton industry since the crisis of 1873, has excited the desire for a wider field for American enterprise, a successful competition with other countries in the markets of the world. But all aspirations of this kind must be doomed to disappointment so long as the protectionist policy of the States is upheld—the very means which they adopt to shut out all other manufactures from their markets must have the effect of shutting out their own from the

markets of the world—they cannot sell freely to other nations from which they refuse to buy. Although, therefore, much is from time to time spoken and written by alarmists of the danger to be apprehended by the cotton-manufacturing interests of England from American competition, we believe the fears entertained to be without any real foundation. The addition of 50 per cent., more or less, made by the tariff to the cost of English-made goods

would be unnecessary to prevent competition, if the American manufacturer could produce those goods as cheaply as his foreign rival. If America be thought to possess any superiority over England in the greater facility and cheapness with which the raw material can be provided—and even this may be doubtful—such advantage is more than counterbalanced in other respects, and especially as regards labor. Wages in the States have been gradually declin-

TABLE X.—Showing the kinds and quantities of Cotton Goods manufactured in the United States—From the Financial Review (American).

	New England States.	Middle and Western States.	Total Northern States.	Total Southern States.	Total United States.
<i>Year ending July 1, 1874.</i>					
Threads, yarns, and twines.....lb	32,000,000	29,000,000	61,000,000	18,000,000	79,000,000
Sheetings, shirtings, and similar plain goods.....yards	520,000,000	90,000,000	610,000,000	97,000,000	707,000,000
Twisted and fancy goods, osenaburgs, jeans, etc.....yards	204,000,000	80,000,000	284,000,000	22,000,000	306,000,000
Print cloths.....yards	481,000,000	107,000,000	588,000,000	---	588,000,000
Ginghams.....yards	30,000,000	3,000,000	33,000,000	---	33,000,000
Ducks.....yards	14,000,000	16,000,000	30,000,000	---	30,000,000
Bags.....number	4,000,000	1,000,000	5,000,000	---	6,000,000
<i>Year ending July 1, 1875.</i>					
Threads, yarns, and twines.....lb	45,000,000	19,000,000	64,000,000	19,000,000	83,000,000
Sheetings, shirtings, and similar plain goods.....yards	540,000,000	94,000,000	634,000,000	92,000,000	726,000,000
Twills and fancy goods, osenaburgs, jeans, etc.....yards	180,000,000	48,000,000	228,000,000	21,000,000	249,000,000
Print cloths.....yards	640,000,000	109,000,000	749,000,000	---	749,000,000
Ginghams.....yards	30,000,000	5,000,000	35,000,000	---	35,000,000
Ducks.....yards	12,000,000	16,000,000	28,000,000	---	28,000,000
Bags.....number	8,000,000	2,000,000	10,000,000	---	10,000,000

ing, and are probably now 20 per cent. lower than in 1869, but they are still about 40 per cent. higher than in 1860. The following is a statement of the weekly wages in cotton mills:—

Overseer—	carding.....	\$21-00
Picker tender,	".....	6-74
Grinders,	".....	8-28
Strippers,	".....	6-84
Overseer—	spinning.....	21-00
Mule spinners,	".....	9-12
Mule backside piecers,	".....	2-40
Frame spinners,	".....	4-62
Overseer—	dressing.....	21-00
Second hand,	".....	11-88
Spoolers,	".....	5-94
Warpers	".....	5-70
Drawers and twistors,	".....	5-52
Dressers,	".....	10-92
Overseer,	weaving.....	21-00
Weavers,	".....	5-61

The hours of labor are from 60 to 66 per week.

The following is about the present rate of wages paid in English cotton mills:—

Carder.....	32s. to 40s.	per week.
Under-carder.....	27s. " 32s.	"
Grinders.....	25s. " 28s.	"
Card tenters.....	14s. " 16s.	"
Drawing tenters.....	16s. " 18s.	"
Slabbing tenters.....	16s. " 18s.	"
Intermediate tenters.....	16s. " 18s.	"
Reving tenters.....	16s. " 18s.	"
Back tenters.....	9s. " 10s.	"

#### Spinning.

Mule overlookers.....	35s. " 40s.	"
Throstle ".....	30s. " 35s.	"
Self-actor minders.....	32s. " 40s.	"
" piecers.....	14s. " 17s.	"
Throstle spinners.....	12s. " 14s.	"
" dofers.....	9s. " 11s.	"
Half-timers.....	4s. 6d.	"
Doublers.....	14s. to 18s.	"

#### Weaving.

Beamers.....	15s. " 20s.	"
Drawer in.....	24s.	"
Weavers.....	15s. " 20s.	"
Reelers.....	15s. " 20s.	"
Engineer.....	35s. " 40s.	"

The hours of labor (52½ per week) are shorter than those in America. If the artificial barriers which are at present kept up to exclude English manufactures from the United States were thrown down, they would probably even

there be able to maintain a successful competition, whilst as regards all neutral markets, where they can meet on equal terms, English manufacturers need never be afraid of the issue. Past progress and success furnish the means and the motive for further exertions, both to extend their manufactures and to open out new channels of trade. (L. W.)

COTTON, CHARLES (1630-1687), an English translator, poet, and wit, was born at Beresford in Staffordshire. He was educated at Trinity College, Cambridge, and afterwards spent some time on the Continent. At the age of twenty-eight he succeeded to an estate greatly encumbered through his father's extravagance, and the rest of his life was that of a country gentleman. He gained the friendship of Isaac Walton, whose fishing expeditions to the Dove he was privileged to accompany; and to the *Complete Angler* he added *Instructions how to angle for a Trout or Grayling in a Clear Stream*. His second wife, the countess of Ardglass, had a jointure of £1500 a year, but it was secured from his extravagance, and at his death in 1687 he was insolvent. Cotton is the author of a good deal of verse, much of which is jocular. Though his love songs are frequently quaint and frigid, they are sometimes exceedingly gay and spirited, as are also most of his bacchic verses.

His chief works are—Translations of the *Horace* of Cornelle, the *Life of the Duke d'Espernon*, and the *Fair One of Tunes*, and above all his famous and often published translation of Moutaigne (1683, 1689, etc.); the *Scarronides*, or *Vingill Travesties*, a coarse parody of the first and fourth books of the *Aeneid*, which ran through fifteen editions; a humorous poem, the *Voyage to Ireland*; and a serious poem of small merit, the *Wonders of the Peak*.

COTTON, GEORGE EDWARD LYNCH (1813-1866), headmaster of Marlborough School, and bishop of Calcutta, metropolitan to India and Ceylon, was born at Chester, October 29, 1813. He was the son of an officer who was killed at the battle of the Nivelle, a fortnight after his son's birth, and grandson of Dr. Cotton, formerly dean of Chester. He received his education at Westminster School, whence he passed in 1832 to Trinity College, Cambridge. Here he became an adherent of the Low Church party, and at the same time the intimate friend of several disciples of Dr. Arnold, among whom were Dr. Vaughan of Harrow, W. J. Conybeare, and Dr. Howson. The influence of Arnold was powerful enough to determine the character and course of his whole life. He graduated B. A. in 1836, and was forthwith appointed by Dr. Arnold to an assistant-mastership at Rugby. Here he worked steadily and devotedly for fifteen years, inspired with the spirit and heartily entering into the plans and methods of his beloved master. He became master of the fifth form about 1840. He made himself the

sympathising companion and friend of his pupils; and by the force of his character and the geniality of his disposition gained their unbounded esteem and love. In 1852 he accepted the appointment of head-master of Marlborough College, which was then in a state of serious financial embarrassment and of almost hopeless disorganization; but, giving himself to the task of reforming it with all his heart, in his six years of rule he rescued it from impending dissolution and raised it to a high position. In 1858 Cotton was offered the see of Calcutta, vacant by the death of Dr. Daniel Wilson; and this high post, after much hesitation about quitting Marlborough, he accepted. For its peculiar duties and responsibilities he was remarkably fitted by the simplicity and solidity of his character, by his large tolerance, by his capacity of sympathy with other men, and by the experience which he had gained as teacher and ruler at Rugby and Marlborough. It was natural that the cause of education should especially engage his attention in his new sphere; and through his zealous endeavors a large number of schools were established, the working of which must be among the most beneficent influences of English rule in India. Bishop Cotton endeared himself to men of all parties, and his sudden death was mourned as a loss throughout his vast diocese. On his return journey from a visitation tour in the autumn of 1866, he slipped while passing in the twilight, October 6, along the plank from his barge towards the shore at Kooshtea, on the Ganges, and was drowned. The body was borne away by the current and never seen again. A memoir of his life, with selections from his journals and correspondence, edited by his widow, was published in 1870.

COTTON, SIR ROBERT BRUCE (1570–1631), the founder of the Cottonian Library, born at Denton in Huntingdonshire in 1570, was a descendant, as he delighted to boast, of Robert Bruce. He was educated at Trinity College, Cambridge, where he took his B.A. degree at the age of fifteen. His antiquarian tastes were early displayed in the collection of ancient records, charters, and other manuscripts, which had been dispersed from the monastic libraries in the reign of Henry VIII.; and throughout the whole of his life he was earnestly engaged in gathering materials for his library and museum of antiquities from all parts of England and the Continent. Perhaps his first pamphlet is that maintaining the right of the English ambassador to precedence over the envoy of Spain, which was written at the request of Elizabeth. On the accession of James I. he was knighted, and soon after he was employed in drawing up a *Memorial on Abuses in the Navy*, in consequence of which a navy commission was appointed, of which he was made a member. He also presented to the king an historical *Inquiry into the Crown Revenues*, in which he speaks freely about the expenses of the royal household, and asserts that tonnage and poundage are only to be levied in war time, and to “proceed out of good will, not of duty.” In this paper he proposed the creation of the order of baronets, each of whom was to pay the Crown £1000; and in 1611 he himself received the title. In 1615 Cotton, as the intimate of the earl of Somerset, whose innocence he always maintained, was placed in confinement on the charge of being implicated in the murder of Overbury; nor did he obtain his release till he had paid £500 for a pardon. Shortly before he had been examined before a royal commission, being suspected of having made known to Gondomar, the Spanish ambassador, the intentions of the English court. The charge is supported by the despatches of Gondomar to Madrid, though probably Cotton deserves no serious blame. From Charles I. and Buckingham Cotton received no favor; he was the intimate friend of Sir John Eliot, Sir Symonds d’Ewes, and John Selden. In 1626 he gave advice before the council against debasing the standard; and in January, 1628, he was again before the council, urging in courtly language the summons of a Parliament. His arguments on the latter occasion are contained in his tract entitled *The Danger in which the Kingdom now standeth and the Remedy*. In October of the next year he was arrested, together with the earls of Bedford, Somerset, and Clare, for having circulated a tract known as the *Proposition to bridle Parliament*, which had been addressed some fifteen years before by Sir Robert Dudley to James I., advising him to govern by force; the circulation of this by Parliamentarians was regarded as intended to insinuate that Charles’s government was arbitrary and unconstitutional. Cotton was himself released the next

month; but the proceedings in the Star Chamber continued, and, to his intense vexation, his library was sealed up by the king. The pain caused by a base attempt to extort money by attacking his character further weakened his already failing health; and on the 6th of May, 1631, he died. He was buried in Conington Church, where a monument is erected to his memory. His son, Sir Thomas, added considerably to the Cottonian library, and Sir John, the fourth baronet, presented it to the nation in 1700. In 1731 the collection, which had in the interval been removed to the Strand, and thence to Ashburnham House, was seriously damaged by fire. In 1757 it was transferred to the British Museum.

See the article LIBRARIES, and Edwards’s *Lives of the Founders of the British Museum*, vol. I. Several of Cotton’s papers have been printed under the title *Cottoni Posthumi*; others have been published by Thomas Hearne.

COTYS, a name common to several kings of Thracia. Of these the most important began to reign in 382 B. C. He was notorious both for cruelty and for drunkenness. Almost the whole of the information we possess of his reign is connected with his quarrels with the Athenians. The first of these was for the Thracian Cheronese, in which Cotys was assisted by the Athenian Iphicrates, to whom he had given his daughter in marriage. On the revolt of Ariobarzanes from Persia, Cotys opposed him and his ally, the Athenians. In 358 he was murdered by the sons of a man whom he had wronged, and the Athenians rewarded his assassins with golden crowns.

COULOMB, CHARLES AUGUSTIN (1736–1806), a distinguished French natural philosopher, was born at Angoulême, June 14, 1736, and belonged to a noble family of Montpellier. He chose the profession of military engineer, spent three years, to the decided injury of his health, at Fort Bourbon, Martinique, and was employed on his return at Aix, Rochelle, and Cherbourg. He gained great distinction in 1773 by his *Statistical Problems Applied to Architecture*, which he presented to the Academy of Sciences in 1779; he shared with Van Swinden the prize for improvements in the construction of compasses, and two years later he obtained the prize of the Academy by his *Theory of Simple Machines, comprehending the Effects of Friction and the Stiffness of Ropes*. In 1781 he was stationed permanently at Paris. There being a proposal for the construction of a system of canals in Brittany, Coulomb was sent as royal commissioner to the estates of that province. He expressed decided disapproval of the scheme, and his opinion caused him to be thrown into prison. He remained firm, however, and refused to give any other verdict, and at length he succeeded in convincing the estates, who showed their appreciation of his candor by making him handsome offers, and presenting him with a seconds watch, adapted for scientific experiments. Coulomb was also appointed intendant-general of waters and fountains, chevalier of St. Louis, member of the legion of honor, and member of the Academy of Sciences. On the outbreak of the revolution he gave up his office, and retired from Paris to a small estate which he possessed at Blois. He was recalled to Paris for a time in order to take part in the new determination of weights and measures, which had been decreed by the Revolutionary Government. Of the National Institute he was one of the first members; and he was appointed inspector of public instruction in 1802. But his health was already very feeble, and four years later he died of slow fever. His fame rests chiefly on his most elaborate and important investigations in electricity and magnetism, and on his invention of the torsion balance.

Coulomb’s chief works, besides those already mentioned, are—*Methods of executing without Water all Kinds of Hydraulic Works; Observations on the Daily Labor of Men; On Heat; Experiments on the Circulation of Sap; On the Cohesion of Fluids, and their Resistance to Slow Motions; Theoretical and Experimental Researches on the Forces of Torsion; and several treatises on electricity and magnetism.*

COUNCIL. Early in its history the Christian church gave outward expression to a sense of the mutual dependence of its members by summoning Councils, or Synods, where on common ground the spokesmen of the Christian community sought, with zeal and acumen, but often not without passion, prejudice, and diplomacy all too human, to discover the mind of the Spirit. There prevailing prac-

ances were approved or reprehended, and the dim persuasions of the few or the many were sharpened into dogmatic statement binding on all. On the great movements of Christian thought, much has ever been reserved for individuals to accomplish, the collective church gradually and unofficially recognizing the indefeasible power of some one spiritual or ecclesiastical genius; but the councils have deeply left their mark on the doctrine and on the constitution of the church. The minor synods, forming a well-balanced system of regularly recurring assemblies, served as an important organ for the administration of ecclesiastical business; and the greater councils, summoned to meet pressing emergencies, often proved turning-points in the church's history. At them the pulse of the visible church beat high. The councils have not inaptly been called "the pitched battles of church history;" but while they have at times caused the forces of the heretics to draw more closely together, and have more than once precipitated schism, or rendered it more determined and persistent, it is not the less true that the synods of the church universal have been her great legislative assemblies, when discussion and decision, more or less full and deliberate, have restored into one channel the main stream of ecclesiastical life, and have brought home, alike to those within and to those without the pale, a sense of the church's corporate oneness.

It is characteristic of the church of Christ that it was left free to mould its constitution according to its circumstances. The founders of Christianity left no detailed constitutional code. And as in other regards, so it was here; neither Christ nor the apostles prescribed a synodal system for the infant church, nor enacted when and where councils should assemble, how they should be constituted, and what they should determine. Much zealous labor has been spent in proving that the councils, even as a developed organization, are a divine institution,—a difficult task certainly, if it be necessary to agree that what is human is therefore not divine, but accidental and "invented." The most various Christian parties have with one consent sought the prototype of all Christian councils in that assembled at Jerusalem under the apostles; and from its scanty record in Acts xv. (the other apostolic assemblies reported in Acts i., vi., xxi., being passed by as irrelevant) the advocates of the most divergent systems have extracted precise rules for the convening and the guidance of ecclesiastical assemblies. But even if we fully accept the historical accuracy of the report, it is impossible to decide with certainty the relation of the apostles to the "presbyters," and of both to the "brethren;" and the decree embodying the decision of the Jerusalem Council contains rather a practical compromise, the arrangement of a *modus vivendi* in the spirit of peace and mutual forbearance, than a final settlement on grounds of principle of the grave and long-lasting problem as to what should be the relations between the new Christian church and the old Jewish law. It points to temporary concession, not to the formulation of a permanent creed.

It is not till after the middle of the 2d century that we find the example of Jerusalem followed, and councils called to solve questions that threatened the unity and well-being of the Christian church and community. The earliest councils historically attested are those convened in Asia Minor against the Montanists; though it is by no means unlikely that at a much earlier period the Christian Greeks gave scope, in ecclesiastical affairs, to their instinct for organization, for taking common action in regard to matters affecting the public good. Near the end of the 2d century again, varying views as to the celebration of Easter led to councils in Palestine, at Rome, in Pontus, Gaul, Mesopotamia, and at Ephesus. These councils were all specially called to consider particular questions. But before the middle of the 3d century, it seems that in Asia Minor at least the councils or synods had become a standing institution, and met yearly. About the same time we find councils in the Latin Church of North Africa. Before the end of this century there were councils meeting regularly in almost every province in Christendom, from Spain and Gaul to Arabia and Mesopotamia; and by extension and further organization, there was soon formed a system of mutually correspondent synods that gave to the church the aspect of a federative republic.

The developing episcopal system suggested plainly enough a gradation of rank and functions for the various synods. A synod composed of all the clergy under one bishop, with their bishop as president, stood at the bottom

of the scale, and is commonly named the *diocesan* synod. The *metropolitan* synod, or *provincial* council, met under the presidency of the metropolitan, and included all the bishops of his ecclesiastical province. Such metropolitan synods the Councils of Nicaea recommended to be held twice a year. When all the bishops of a patriarchate met under the patriarch, or all those of a nation under its primate or first metropolitan, the council was *patriarchal* or *national* or *primatial* (not infrequently termed *concilium generale* or *plenarium*). Occasionally the bishops of adjoining provinces met, the senior metropolitan presiding, for the consideration of matters common to a district of wider area than the one ecclesiastical province. The *synodus evnqmuicau* held at Constantinople by the metropolitan, who invited as many bishops to meet him as chanced to be then in the city, though not irregular, corresponded to no territorial division of the church. *Councils mixta*, held chiefly during the Middle Ages in Germany, England, Spain, and Italy, were constituted not less of temporal than of spiritual princes, and resolved questions not solely ecclesiastical. *General* synod was usually the name for an assembly of the bishops from all portions either of the Western or of the Oriental division of the church. Such a synod was that of Arles, whither, in 314 A. D., Constantine summoned the bishops of the Western Church. But the minor councils were soon overshadowed by the *oecumenical* councils, at which the whole of Christendom was held to be represented, and which by universal agreement came ultimately to be regarded as having authority for the whole church.

At the diocesan synods, presbyters were members as well as the bishop, but they had only a *volunt consultativum*. The regular members of the higher synods were the bishops alone or their representatives, and exercised the *volunt decisivum*. But other clergy, deacons, doctors of theology and of canon law, and abbots, were invited to assist the bishops with their advice, and it seems that sometimes at least the abbots were permitted to give a decisive vote. Laics, especially emperors, kings, and their commissioners, were often present, and to some English councils even abbesses were admitted. Save at the Councils of Constance and Basel, the voting was by count of heads; but at Constance the voting was according to nations, in order to counteract the numerical predominance of the Italian Bishops. A similar method was adopted at the Council of Basel.

It has never been settled beyond dispute which of the councils are to be regarded as truly and authoritatively representative of the Christian *oikouμένη*. And of those that may fairly be called *oecumenical*, one differs widely from another not merely in its catholicity of spirit and in the abiding interest of the questions discussed, but in the width of area from which its members were drawn, and the extent of territory throughout which its authority was at the time recognized. At the earliest universal councils the representatives of the Western Church were a small minority; at Nicaea hardly 10 of the 318 (?) bishops were of the Latin-speaking church. The council at Constantinople in 381 was at first only a general synod of the Oriental church, and it was not till the 6th century that it was recognized as *oecumenical* in the West. Some councils, such as those summoned to Pavia and Siena, were designed to be *oecumenical*, but led to no such result. The whole Greek Church acknowledges still but seven *oecumenical* councils. The English Church after the Reformation practically recognized the first five. The doctrinal definitions of the first four councils became the common property of the churches of the Reformation, but Protestant authors rarely refer to the later councils save polemically. The Latins even are not entirely agreed amongst themselves. The claims of the council at Sardica in 393 to universal authority have been asserted, but seldom conceded. Some Catholics have protested against the *oecumenicity* of the synod in 1311 at Vienne, generally reckoned the 15th *oecumenical*. Most Catholics, including some of those most anxious to promote reforms, refused to admit the Gallican claim in favor of the council summoned to Pisa in 1409, and its rank as a universal council has never been allowed by the most approved Catholic theologians. The Gallicans wished to have the Council of Constance recognized as *oecumenical* throughout; good Catholics acknowledge only the sittings held after Pope Martin V. was chosen, or such earlier decrees as were afterwards

sanctioned by this Pope. Some Gallicans regard the Council of Basel as œcumenical from beginning to end; most insist on regarding it as legitimate only till it was transferred to Ferrara; many Catholics, amongst others Bellarmine, decline to admit the œcumenicity of any of its decrees. The council of Ferrara-Florence, a Papal continuation of that of Basel, was at first protested against by the Gallican party, but is fully accepted by most Catholic theologians and canonists. The Gallicans were also slow to admit the binding authority of the 5th Lateran synod, the 18th œcumenical council.

The question as to the number of councils is naturally of most consequence to the only section of the church that still assumes the right to summon councils and to call them œcumenical. The view that prevails in the Roman Catholic Church may best be shown by giving a list of the councils accepted as œcumenical by Hefele (*Council-geschichte*, 2d ed., vol. i pp. 59, 60).

	A. D.
1. The Council at Nicæa.....	325
2. The 1st Council at Constantinople.....	381
3. The Council at Ephesus.....	431
4. The Council at Chalcedon.....	451
5. The 2d at Constantinople.....	553
6. The 3d at Constantinople.....	680
7. The 2d at Nicæa.....	787
8. The 4th at Constantinople.....	869
9. The 1st Lateran Council.....	1123
10. The 2d Lateran Council.....	1139
11. The 3d Lateran Council.....	1179
12. The 4th Lateran Council.....	1215
13. The 1st Council at Lyons.....	1245
14. The 2d Council at Lyons.....	1274
15. The Council at Vienne.....	1311
16. The Council at Constance (partially)...	1414-1418
17a. The Council of Basel (partially).....	1431-1438
17b. The Council of Ferrara-Florence (a continuation of that at Basel).....	1438-1442
18. The 5th Lateran Council.....	1512-1517
19. The Council of Trent.....	1545-1563
20. Vatican Council.....	1869-1870

These œcumenical councils fall naturally into several groups or series. The first eight, including that at Constantinople in 869, were summoned by the emperors, all the later ones by the popes,—and this though the analogy of the inferior councils seems to demand that the representative assemblies of the universal church should be summoned by the head of the church alone. Catholics always assert that no council can be œcumenical unless called by the Pope, or by a temporal prince with and by the Pope's assent obtained before or after; and Catholic authors have been at pains to attempt a proof that, even at the councils undoubtedly summoned by the emperors, the bishop of Rome stood to the calling of them in a relation different from that of the other patriarchs. In the case of the 3d œcumenical council, for example, Hefele contends that the Pope did not merely, like the other bishops, passively assent, but actively sanctioned the summons.

The exclusive right of the popes to preside was unhesitatingly admitted at all the later councils; but at the earlier ones, where manifestly emperors, empresses, or their commissioners were the formal presidents, Catholic canonists have persuaded themselves that such presidency was merely in regard to external matters, and that the true president was always episcopal. Even at the Council of Nicæa, they argue, Hosius and the two Roman presbyters who signed the decrees first must have done so as deputies of the Roman bishop, and as such must have been the true presidents.

The first eight councils differed from the rest in that whereas all others met within the bounds of the Western Church, they were all held in the East. Further, the great majority of those who attended them were Greeks, and spoke Greek alone; and the chief subjects of debate at several turned on distinctions not safely translatable into the Western tongues. The first six of these eight councils were occupied mainly, though by no means exclusively, with aspects of the great trinitarian and christological controversies, and their decrees are accordingly of high dogmatical interest.

Of councils held in the West, a well-defined sub-group includes the 9th (the 1st Lateran) to the 15th (at Vienne in 1311). The first of these is significantly enough concerned with the dispute about the right of investiture; and

though some of this series of seven discussed or defined dogmas, as did the brilliant 4th Lateran Council, they were for the most part busied with matters pertaining to the rights and dignity of the popes and with questions concerning their election. Indeed, several of them have less the aspect of free and independent councils than of assemblies gathered for the official ratification of the proceedings of Pope and Curia.

The reasons for the calling of universal synods are of various kinds. When a serious heresy or schism has arisen, when it is doubtful which of two opposing popes is legitimate, when it is proposed to undertake some grand design against the enemies of the church, when the Pope is accused of heresy or other grave fault, when the cardinals will not or cannot elect a Pope, and when a root and branch reformation of the church is in view,—councils may or must be summoned. It was the last of these grounds for assembling the universal church that led to the 16th, 17th, and 18th œcumenical councils; and the 19th, that of Trent, though the sufficiency of the reforms agreed to by it was unanimously denied by the Protestant reformers, must also be reckoned amongst the reforming councils.

The Vatican Council is the last of those claiming to be œcumenical, and in decreeing the infallibility of the Pope it has appeared to many that the 20th council has shown cause why, for all essential purposes, there needs never be another. The very institution of councils seems in itself an admission that apart from them there was no source of accessible and infallible authority on disputed points. If the assembly at Jerusalem was really a council, then even where Paul and at least one of the original twelve apostles were present, the settlement of a question with vast doctrinal and practical issues was arrived at by means of open debate amongst the members of the synod. Unhesitating belief in frequent and miraculous manifestations of the divine will was universal for centuries; yet when the illumination of the Holy Spirit was most urgently needed for the establishment of Christian truth, recourse was had to the collective opinion of assembled representatives, to discussion more or less calm and candid, and to the counting of votes,—a most noteworthy feature in the development of the church. And it deserves to be remarked that thus, in times of all-embracing despotism, the church secured for the representatives of the Christian community one side of corporate and individual freedom, a measure of independence such as could not fail to keep alive a feeling hostile to the extension of imperial, though Christian, tyranny into at least one of the provinces of thought and action.

The infallibility of universal councils, ultimately admitted by the whole Catholic Church, was early claimed. "It seemed good to the Holy Ghost and to us," words occurring in the Jerusalem decree, could not but suggest to the successors of the apostles that the synods assembled under them were favored by the special superintendence of the Holy Ghost; and this was distinctly asserted by Cyprian. But the sanction of the Pope has always been held by modern Catholics as necessary to the infallibility of any council; and the decrees even of the minor councils attain to infallibility if approved by the Pope and accepted by the church at large. A limitation of synodical authority that merely recognized the Pope as an integral part of the church might be agreed to even by those who asserted that œcumenical councils are superior to the popes, a theory long and vehemently contended for and against in the church. That the councils are above the popes was the view of the Councils of Constance and Basel, and was formulated as one of the four Gallican propositions; whereas at the 5th Lateran Council Pope Leo X. roundly asserted the authority of the Pope over all councils.

Yet the infallibility of universal councils was most confidently accepted by the very parties in the church which were least disposed to concede absolute authority to any other ecclesiastical institution,—notably by the Gallicans and by the German Reformers in the early stages of the Reformation. And the institution of councils, both of occasional councils called for special purposes and of those meeting steadily, was inherited by the Protestant churches. The Synod of Dort is an instance of a general council of churches adhering to the Reformed Confessions; the Westminster Assembly was designed to be a national council. It is of course in the Presbyterian churches that councils have received their most systematic development, and



without claiming infallible authority, retain the most extended powers as legislative, administrative, and judicial. In the Church of Scotland the regular gradation of kirk sessions, presbyteries, provincial synods, and general assembly of representative ministers and elders supervises and regulates all the functions of the church, and forms a compact and balanced system of constitutional government. In non-Presbyterian churches synods have various degrees of deliberative or decisive authority. Even now the reorganization of the synodical system of the United Protestant Church of Prussia is regarded both by churchmen and by statesmen in Germany as one of the ecclesiastical questions of the day.

The chief collections of the Acts of the Councils of the Catholic Church are that by Hardouin, published at Paris in 1715 in 13 folios, and the still more complete one by Masai (Florence and Venice, 1758-1799) in 31 folio vols., but extending only to the 15th century. By far the most elaborate recent work on the Councils is the *Concilien Geschichte* of Dr. Hefele, bishop of Rottenburg (7 vols., 1st ed., 1855-1874; 2d ed., 1873, etc.). (p. r.)

**COUNCIL BLUFFS**, a town of the State of Iowa, United States, near the left bank of the Missouri, opposite to Omaha in Nebraska, and on the line of the great continental Railroad from Chicago to San Francisco. It is a rapidly growing place, and in 1870 had 10,020 inhabitants. Open prairie surrounds it on all sides. A mile west of the town the Missouri is spanned by a great iron bridge, one of the finest in the country.

**COUNSEL**. See **ADVOCATE**, vol. i. p. 161; and **BARRISTERS**, vol. iii. p. 340.

**COUNT**, **COUNTESS** (Latin *Comes*, *Comitissa*). In the peerage of Great Britain and Ireland the Continental title count, in its highest and most dignified acceptation, is represented by earl,—an earl's wife, however, being styled countess. In the times of the Roman Commonwealth, personages of different degrees of rank, who in various capacities officially accompanied the proconsuls and proprietors into the provinces, bore the common designation of *comites*, either a *comitatus* or a *comitanda*. At a later period, the *comites*, as personal companions and counsellors of the prince, whose name they always added to the title of their office, became lords of the palace, whence the origin of their style as *counts palatine*. At a considerably later era, this same title implied princely rank, dignity, and power enjoyed by the bearer under a supreme imperial sovereign. By Constantine the title *comes* was first established as a definite dignity; but this same title, within a short time after its first formal establishment, was conferred indiscriminately upon various classes of public officers, of whom a long list, specifying the capacity in which each one served, is given by Du Cange. After the fall of the Roman empire the governors of provinces and cities who commanded in war and during peace presided over the administration of the laws retained the titles of *duces* and *comites* (dukes and counts); occasionally also the distinction between these titles failed to be observed, and some counts became governors of provinces. Under the last king of the second royal dynasty of France, the dignity of the counts of the highest rank was rendered hereditary, when they even aspired to independent sovereignty. From the inability of Hugh Capet to maintain the supremacy of the Crown against their encroachments, these great peers assigned to his reign their first assumption of coronets with their arms, to denote their enjoyment of sovereign power in their particular counties or territories. In after times, the dignity of count, hereditary in the male line, was granted by a sovereign upon his erecting a territory into a county, with a reserve of sovereignty and jurisdiction to the Crown, and also with reversion to the Crown in default of heirs male. At the present day, from the custom of styling all the sons of a count also counts, the titular bearers of this designation on the Continent are very numerous, while their rank is little more than nominal. In Germany the equivalent for count is *Graf*, and the several orders of these German counts are distinguished by the formation of compound titles, as "landgraves," "palgraves," &c. See **EARL**.

**COUNTY** is the chief of the administrative areas into which England is divided. This is an ancient division, and, according to the popular manner of accounting for the origin of social institutions, is attributed to the wisdom of our early kings, and more particularly to King Alfred. It

is tolerably clear, however, that this theory is a reversal of the natural process, and that, instead of counties having been formed by the division of the country, the country itself was formed by the aggregation of counties. The county, in fact, is the representative of an independent kingdom or community, now long merged in the larger unity of the English kingdom. The same mistake that has been made as to the historical relations of the county and the kingdom is repeated in the popular accounts of the subdivisions of the county itself. Alfred the Great, it is said, divided the county into hundreds, and these again into tithings. The truth is exactly the contrary—the subdivision of the county being an earlier aggregate than the county itself. The parish, the manor, and the township all appear to be traceable to the independent tribal settlement—the village community—of the early Saxons. They appear in history with their political and judicial organism complete. A combination of these units forms the district of the hundred; and a combination of hundreds forms the county. All of these groups have the same kind of organization. They all have their moots or meetings, partly judicial partly political in character, and their head-man or reeve. The Witenagemot of the Saxon kingdom is the folk-moot for the whole kingdom, corresponding to the folk-moot for the shire or county.

In the period preceding the Norman Conquest two officers appear at the head of the county organization. These are the ealdorman or earl and the sciregerefa or sheriff. The latter was more particularly the representative of the king; the former represented, in dignity at least, the head of the county before it had ceased to be an independent community. After the Conquest the sheriff became a purely royal officer (*vicescomes* or *ballivus*). He held an annual court (the sheriff's tourn or leet) to which the vassals of the king were suitors. These were the judicial tribunals for the people within the jurisdiction of the county. An appeal lay from them to the king, and the growth of the king's court, in its three developments—King's Bench, Common Pleas, and Exchequer—tended to draw suits at the first instance away from the county court into the higher tribunal. The county court, moreover, arranged the assessment of rates, and the sheriff was, in fact, the financial representative of the Crown within his district. When the principle of representation came into existence, the county court was the assembly which elected the knights of the shire. The ancient offices of coroner and verderer were also filled up by the same assembly. The county organization thus in many points retained the features of an independent political society. From the time of the Plantagenets its importance in the constitution declined.

The office of sheriff in England has lost all its financial and nearly all its judicial duties. He is now chiefly a ministerial officer—he arrests or imprisons, summons and returns the jury, carries the judgment or sentence of the court into effect, &c.

The military functions of the sheriff were in the reign of Henry VIII. (or, according to some, Edward VI.) handed over to a new officer, the lord-lieutenant, who is now more prominently associated with the headship of the county than the sheriff is. The office is honorary, and is held during royal pleasure, but virtually for life. The Government of the day invariably appoints one of its own supporters,—generally a person of high position in the county. He is the chief conservator of the peace and keeper of the records of quarter sessions. He is also commander of the militia and yeomanry of the county, whose officers he appoints.

In the United States of America the county forms the section into which the State is divided; it is again subdivided into townships. The financial affairs of the county are superintended by county officers, and each county is provided with a court of inferior jurisdiction. Louisiana is the only State which is divided into parishes, instead of counties.

The *Counties Palatine* are three in number, viz., Durham, Chester, and Lancaster. The counts palatine (earl of Chester, bishop of Durham, and duke of Lancaster) exercised royal rights within their districts. Chester was united with the Crown under Henry III., but the palatinate jurisdictions survived in the other two cases. The Court of Common Pleas at Lancaster and the Court of Common Pleas at Durham are among the courts whose jurisdiction is transferred to the High Court of Justice by

the Judicature Act, 1873. The palatine authority of the bishop of Durham was vested in the Crown by 6 and 7 Will. IV. c. 19. The duchy of Lancaster has still its own chancellor, in whose name a chancery court is held, presided over by a vice-chancellor, and the courts of the lord chancellor of England do not run in the districts. The chancery court is not affected by the Judicature Act. Section 99 of that Act provides that, from and after the commencement of this Act, the counties palatine of Lancaster and Durham shall respectively cease to be counties palatine, so far as respects the issue of commissions of assize, or other like commissions, but not further or otherwise.

*Counties of cities, or counties corporate*, are cities which have acquired the privileges of counties. The officers of the counties in which these towns are situated have no jurisdiction within them. Among them are London, York, and Bristol.

*County Court*.—The jurisdiction of the ancient County Court has within recent years been revised and extended with the view of making justice cheaper and more accessible, especially in disputes about small amounts. The 9 and 10 Vict. c. 95 (County Courts Act, 1846) reciting various Acts, the provisions of which should be amended, and that one rule and manner of proceeding for the recovery of small debts and demands, should prevail throughout England; that the County Court is a court of ancient jurisdiction, having cognizance of all pleas of personal actions to any amount by virtue of a writ of justices issued in that behalf; that the proceedings in the County Court are dilatory and expensive, and that it is expedient to alter and regulate the manner of proceeding in the said courts for the recovery of small debts and demands; that the courts established under the said recited Acts of Parliament, or such of them as ought to be continued, should be holden after the passing of this Act as branches of the County Court under the provisions of this Act,—enacts that "it shall be lawful for her Majesty, with the advice of her Privy Council, to order that this Act shall be put in force in such county or counties as to her Majesty, with the advice aforesaid, shall seem fit." By section 2 her Majesty, with the advice aforesaid, may divide the whole or part of any such county, including all counties of cities and counties of towns, cities, boroughs, towns, ports, and places, liberties and franchises therein contained into districts, and may order that the County Court shall be holden under this Act in each of such districts. Courts under this Act are to have "all the jurisdiction and powers of the County Court for recovery of debts and demand as altered by this Act," and shall be courts of record. For all other purposes the County Court shall be holden as if this Act had not passed. Judges, treasurers, registrars, high bailiffs, and their assistants, were to be appointed for each district. The 21 and 22 Vict. c. 74 § 8 limits the number of judges to sixty. The salary of a County Court judge was originally fixed at £1200, but as a rule he now receives £1500. He must be a barrister-at-law of seven years' standing; after appointment he cannot sit as a member of Parliament, or practise at the bar. The appointment is made by the lord chancellor, with whom also rests the power of dismissal for sufficient cause shown. Lawyers of considerable repute have in many cases accepted these appointments.

The jurisdiction of the County Courts was at first confined to pleas in personal actions, when the sum claimed was not more than £20, but it has since been considerably enlarged. The limit was raised to £50 by the 13 and 14 Vict. c. 61. A jurisdiction in ejectment, where the annual rent or value of the land was not more than £20, was conferred by the County Courts Act, 1867. Up to 1865 the jurisdiction of the County Courts was with a few trifling exceptions a common law jurisdiction, but the County Courts Act of that year conferred an equitable jurisdiction, limited as to the value of the amount at stake to £500. This Act, and the power to set up equitable defences to actions under the Common Law Procedure Act, 1854, are noticeable in the history of English law, as anticipations of the fusion of law and equity now being carried out under the recent Judicature Act. Jurisdiction in probate (up to £200), in admiralty, in bankruptcy, and certain powers in aid of the jurisdiction of other courts have also been conferred by separate Acts. By the consent of parties the court may have jurisdiction in any action. In certain cases (e.g., recovery of penalties for bribery at municipal elections, etc.) the County Courts have exclusive jurisdiction. Otherwise they have jurisdiction concurrently with the superior courts, but when a case which a County Court might have tried is brought into a superior court, the costs will not in general be granted. The County Courts Act, 1867, dealing with this subject, enacts (§ 5) that costs shall not be recoverable by the plaintiff in any action in the superior courts, when the amount recovered does not exceed £20 in a case of contract, or £10 in a case of tort (civil injury)—unless the judge certify that there was a good reason for bringing the action in a superior court. By § 8 when any action of contract is brought in a superior court for a sum in dispute not exceeding £50, the judge

may on the application of the defendant order the case to be sent to the County Court. By § 8 proceedings in equity may be transferred to the County Court which might have commenced therein; and by § 10 in actions for tort, the judge may, on an affidavit by defendant that the plaintiff has no visible means of paying costs if unsuccessful, send down the case to the County Court. These provisions, which it will be observed only indirectly compel suitors to resort to the County Courts in cases of minor importance, are embodied in the Judicature Act, 1873, by section 67:—"The provisions contained in the fifth, seventh, eighth, and tenth sections of the County Courts Act, 1867, shall apply to all actions commenced or pending in the said High Court of Justice on which any relief is sought which can be given in a County Court."

A County Court judge may determine all matters of fact as well as law, but a jury may be summoned at the option of either plaintiff or defendant when the amount in dispute exceeds £5, and the judge may at his discretion summon a jury in any case. Counsel as well as attorneys may appear in the County Courts, but as the object of the legislature was to establish a cheap tribunal, costs are in the discretion of the judge, and the remuneration for professional services recoverable as costs is paid on a reduced scale. By the Judicature Act, 1873, appeals from County Courts and other inferior courts are heard in divisional courts of the High Court of Justice, consisting of such judges as may be assigned for that purpose, and the decision of any such divisional court shall be final, unless it gives special leave to appeal to the Court of Appeal. The Acts relating to County Courts are now numerous, and through frequent amendment and repeal are in a state of great confusion. A Consolidation Act is much to be desired. (E. E.)

COURAYER, PIERRE FRANCOIS LE (1681-1776), a Roman Catholic theological writer, was born at Vernon, in Normandy, in 1681. While canon regular and librarian of the abbey of St. Geneviève at Paris, he conducted a correspondence with Archbishop Wake on the subject of Episcopal succession in England, which supplied him with material for his work *On the Validity of English Ordinations*, published in Holland in 1727, in which he tries to prove that there has been no break in the line of ordination from the apostles to the English clergy. His opinions, however, having exposed him to a prosecution in his native country, he took refuge in England, where he was presented by the university of Oxford with a doctor's degree. In 1736 he published a French translation of Father Paul Sarpi's *History of the Council of Trent*, and dedicated it to Queen Caroline, from whom he received a pension of £200 a year. Besides this he translated Sleidan's *History of the Reformation*, and wrote several theological works. Courayer died in 1776, after two days' illness, and was buried in the cloister of Westminster Abbey. In his will, dated two years before his death, he declared himself still a member of the Catholic Church, although dissenting from many of its opinions.

COURIER, PAUL LOUIS (1773-1825), French Hellenist and political and miscellaneous writer, was born at Paris, January 4, 1773. His father, Jean Paul Courier, was owner of the estate of Méré in Touraine, to which he retired when, in consequence of a serious quarrel with a duke, he was compelled to leave Paris. The son, still in his childhood, imbibed a bitter aversion to the nobility, which seemed to strengthen with time. He would never take the name "de Méré," to which he was entitled, lest he should be thought a nobleman. At the age of fifteen he was sent to Paris to complete his education; and there he studied chiefly mathematics and Greek. For Greek literature he had a passionate fondness, and attained in it so remarkable a proficiency that he was complimented by German scholars. Destined by his father for the army, he entered the school of artillery at Châlons, and received his appointment as sub-lieutenant in September, 1792. He served in various campaigns of the Revolutionary wars, especially in those of Italy in 1798-1799 and 1806-1807, and in the German campaign of 1809. He attained the rank of *chef d'escadron* in 1803. Meanwhile, whenever circumstances left him at leisure, he devoted himself to his favorite studies. He made his first appearance as an author in 1802, when he contributed to the *Magasin Encyclopédique* a critique on Schweighäuser's edition of *Athènes*. In the following year appeared his *Éloge d'Hérodote*, a free imitation rather than a translation from Isocrates, which he had sketched in 1798. Courier quitted the army after the battle of Wagram (1809), the savage independence of his nature rendering subordination and obedience irksome and intolerable to him; while his superiors found it

hard to bear the chastisement of his satirical humor, which he freely indulged without respect of persons. After leaving the army he went to Florence, and was fortunate enough to discover in the Laurentian Library a complete manuscript of Longus's *Daphnis and Chloe*, an edition of which he published in 1810. In consequence of a misadventure—blotting the manuscript—he was involved in a quarrel with the librarian, and was compelled by the Government to leave Tuscany. He retired to his estate at Verets (Indre-et-Loire), but frequently visited Paris, and divided his attention between literature and his farm. After the second restoration of the Bourbons the career of Courier as political pamphleteer began. He had before this time waged war against local wrongs in his own district, and had been the adviser and helpful friend of his neighbors. He now carried the war into a larger field, and by his letters and pamphlets made himself one of the most dreaded opponents of the Government of the Restoration. In 1817 he was a candidate for a vacant seat in the Institute; and failing, he took his revenge by publishing a bitter *Lettre à Messieurs de l'Académie des Inscriptions et Belles-Lettres* (1819). This was followed (1819–1820) by a series of letters published in *Le Censeur*, which by the extraordinary power displayed in them gives him a place in literature only second to the author of the *Lettres Provinciales*. The proposal, in 1821, to purchase the estate of Chambord for the duke of Bordeaux called forth from Courier the *Simple Discours*, one of his most powerful and successful pieces. For this he was tried and condemned to suffer a short imprisonment and to pay a fine. Before he went to prison he published a *Compte Rendu* of his trial, which had a still larger circulation than the *Discours* itself. In 1823 appeared the *Livret de Paul Louis*, the *Gazette de Village*, and other pieces, which were followed in 1824 by his famous *Pamphlet des Pamphlets*, called by his biographer, Armand Carrel, his swan-song. Courier projected a translation of Herodotus, and published a specimen, in which he attempted to imitate archaic French; but he did not live to carry out his plan. In the spring of 1825, on a Sunday afternoon (April 10), Courier was found shot in a wood near his house. The murderers remained undiscovered for five years. The writings of Courier, dealing with the facts and events of his own time, are valuable sources of information as to the condition of France before, during, and after the Revolution. Their literary merits are thus set forth in the *Edinburgh Review* (vol. xlix.):—

“They abound in plain, strong, masculine sense, illustrated with classical allusions, naturally and happily introduced, and seasoned with wit more brilliant than is almost anywhere else to be found; for it has the keen edge of Swift's satire, with a style of more pointed epigram, and the easy playfulness of Voltaire, without his pertness and flippancy. His statements and narratives are short, and so clear as to present a sudden and lively picture; his arguments are models of conciseness and force.”

A *Collection Complète des Pamphlets Politiques et Opuscules Littéraires de P. L. Courier* appeared in 1826. An edition of his works, with an essay on his life, etc., by Armand Carrel, was published in 1834.

COURLAND, or KURLAND, one of the Baltic provinces of Russia, lying between 56° and 57° 45' N. lat. and 21° and 27° E. long., is bounded on the N. E. by the River Düna, separating it from the governments of Vitebsk and Livonia, N. by the Gulf of Riga, W. by the Baltic, and S. by the government of Kovno. The area is 10,535 square miles, of which 101 square miles are occupied by lakes. Population (1870), 619,154. The surface is generally low, and the coast-lands, which run out northwards, inclosing the Gulf of Riga, by a broad promontory to the Domensias, opposite the island of Oesel, are flat and marshy. The interior is characterized by wooded dunes, covered with pine, fir, birch, and oak, with swamps and lakes and fertile patches between. Usmaiten, the largest lake, is 24 miles in circuit. The highest point of the province, called the Hüningsberg, in the neighborhood of the capital, is scarcely 700 feet above the sea. The Windau, Aa, and the frontier river Düna pass through the province from the south-east. Owing to the numerous lakes and marshes the climate is damp and foggy, and the winter is severe, though less rigorous than that of Livonia. Agriculture is the chief occupation of the inhabitants, the principal crops being rye, barley, and oats; flax, hemp, and a little tobacco are also grown. Fisheries, cattle-rearing, and

hunting are also carried on to some extent. Except in the making of tiles and in distillation manufactures are insignificant. Iron and limestone are the chief minerals of the province; amber is found on the coasts. The peasantry of Courland are partly the Letts of Courland, or Kures, mixed with Polish and Russian blood; partly Estonian Letts, with German, Swedish, and Finnish admixture, such as the Livs of the north-west coast of the promontory of Courland, and the “Krevinnes,” or Krivingians, living in the district of Bauske, in the interior. The prevailing religion is the Lutheran,—only a small proportion of the people belonging to the Greek Church. Mitau, centrally placed, and in railway communication with Riga, is the capital of the province and its largest town; but Libau and Windau on the Baltic coast are its busiest places. Anciently Courland was an independent possession of the Teutonic knights, who also owned Livonia, and it comprised the two duchies of Kurland and Semgall. As Russian power continued to extend, and the knights could no longer hold their own in Livonia, the duchies were placed, in 1561, under the feudal government of Poland. By the marriage of Duke Frederick William of Kurland to the Russian Princess Anna, daughter of Czar Ivan, in 1710, Courland came into close relation with Russia, and remained for a long period an object of contention between that country and Poland. Ultimately, in 1795, the assembly of nobles in Courland resolved to place the country under the Russian sceptre. The Baltic provinces—Esthonia, Livonia, and Courland—ceased to form collectively a general government of the Russian empire by ukase of January, 1876; their separate administration is now based on the same general system as that of the other governments of the empire, modified by some local and special dispositions.

COURSING may be defined as the hunting of game by dogs solely by means of the organs of sight. From time to time the sport has been pursued by various nations against various animals, but the recognized method has generally been the coursing of the hare by greyhounds. Such sport is of great antiquity, and is fully described by Arrian in his *Cynegeticus* about 150 A. D., when the leading features appear to have been nearly the same as in the present day. Other Greek and Latin authors refer to the sport; but during the Middle Ages it was but little heard of. It may be divided into private and public coursing. The former is more pursued for the sake of filling the pot with game than with the view of affording the exhilarating sport furnished by the latter. The private sportsman seldom possesses good strains of blood to breed his greyhounds from, or has such opportunities of trying them as the public courser. The first known set of rules in England for determining the merits of a course were drawn up by Thomas, duke of Norfolk, in Queen Elizabeth's reign; but no open trials were heard of until half a century later, in the time of Charles I. The oldest regular coursing club whereof any record exists is that of Swaffham, in Norfolk, which was founded by Lord Orford in 1776. During the next seventy years many other large and influential societies sprang up throughout England and Scotland, but the first open champion meeting was held at Glasgow in 1835, and since then they have spread rapidly throughout the country. The chief followers of the sport are to be found amongst the yeoman and middle classes, who prefer coursing to horse-racing on account of its being more economical and devoid of the chicanery connected with the latter. Several noblemen, however, keep large kennels of greyhounds, are enthusiastic patrons of coursing, and further the sport by preserving hares and providing coursing grounds. The season lasts about six months, commencing at the end of September. During 1875–76 the value of the stakes and other prizes coursed for in the United Kingdom was upwards of £40,000. It was not until 1858 that a coursing parliament, so to speak, was formed, and a universally accepted code of rules drawn up. In that year the National Coursing Club was founded. It is composed of representatives from all clubs in the United Kingdom of more than a year's standing, and possessing more than twenty-four members. Their rules govern meetings, and their committee adjudicate on matters of dispute. It must be borne in mind that a comparative trial of two dogs, and not the capture of the game pursued, is the great distinctive trait of modern coursing. Clubs either rent grounds to course over or are allowed the use

of land by large proprietors who are supporters of the sport; but in either case a good stock of strong hares must be maintained by preserving or otherwise. The chief breeds of coursing greyhounds now in vogue are the Newmarket, the Lancashire, and the Scotch. The breeding and training of a successful kennel is a precarious matter; and the most unaccountable ups and downs of fortune often occur in a courser's career. A club meeting is managed by the society's own members, and an open or champion one by whoever may be appointed secretary, assisted in both cases by a committee. An agreed on even number of entries are made for each stake, and the ties drawn by lot. After the first round the winner of the first tie is opposed to the winner of the second, and so on until the last two dogs left in compete for victory. A staff of beaters drive the hares out of their coverts or other hiding-places, whilst the slipper has the pair of dogs in hand, and slips them simultaneously by an arrangement of nooses, when they have both sighted a hare promising a good course. The judge accompanies on horseback, and the six points whereby he decides a course are—(1) speed; (2) the go-by, or when a greyhound starts a clear length behind his opponent, passes him in the straight run, and gets a clear length in front; (3) the turn, where the hare turns at not less than a right angle; (4) the wrench, where the hare turns at less than a right angle; (5) the kill; (6) the trip, or unsuccessful effort to kill. He may return a "no course," as his verdict, if the dogs have not been fairly tried together, or an "undecided course" if he considers their merits equal. The open Waterloo meeting, held at Altcar near Liverpool, every spring, is now the recognized fixture for the decision of the coursing championship, and the Waterloo cup is the "Blue Riband" of the leash.

Rabbit coursing is much pursued in the suburbs of Lancashire manufacturing towns. It is conducted more artificially than hare coursing, the rabbit being dropt by hand some twenty yards in front of the dogs, and the victor being the first that catches and holds the game.

The chief works on coursing are—Arrian, *Cynogeticus*, translated by the Rev. W. Dansey, 1831; T. Thacker, *Courser's Companion and Breeder's Guide*, 1835; Thacker's *Courser's Annual Remembrancer*, 1849-1851; D. P. Blaine, *Encyclopædia of Rural Sports*, third edition, 1870; J. H. Walsh, *The Greyhound*, third edition, 1875, and *British Rural Sports*, twelfth edition, 1875; and the *Coursing Calendar*, edited by J. H. Walsh. (S. F. W.)

**COURT.** This name is now usually restricted to judicial tribunals, almost the only exception being the household of the king, which is still called the Court. All courts are not even now purely judicial in character; the County Court, for instance, is still the assembly of the freeholders of the county in which representatives and certain officers are elected. Such assemblies in early times exercised political and legislative as well as judicial functions. But these have now been almost entirely separated everywhere, and only judicial bodies are now usually called courts. In every court, says Blackstone, there must be three parts,—an actor or plaintiff, reus or defendant, and *judex*, or judge.

The language of legal fictions, which English lawyers invariably use in all constitutional subjects, makes the king the ultimate source of all judicial authority, and assumes his personal presence in all the courts.

"As by our excellent constitution," says Blackstone, "the sole executive power of the laws is vested in the person of the king, it will follow that all courts of justice, which are the medium by which he administers the laws, are derived from the power of the Crown. For whether created by Act of Parliament or letters patent, or subsisting by prescription (the only methods by which any court of judicature can exist), the king's consent in the two former is expressly, in the latter impliedly given. In all these courts the king is supposed in contemplation of law to be always present; but as that is in fact impossible, he is then represented by his judges, whose power is only an emanation of the royal prerogative."

These words, which are still printed in modern editions of the commentaries, might give a false impression of the historical and legal relations of the courts and the Crown, if it is not remembered that they are nothing more than the expression of a venerable fiction. The administration of justice was, indeed, one of the functions of the king in early times; the king himself sat on circuit so late as the reign of Edward IV., and even after regular tribunals were established, a reserve of judicial power still remained in

the king and his council, in the exercise of which it was possible for the king to participate personally. The last judicial act of an English king, if such it can be called, was that by which James I. settled the dispute between the Courts of Chancery and the Court of Common Law. Since the establishment of Parliamentary government the courts take their law directly from the legislature, and the king is only connected with them indirectly as a member of the legislative body. The king's name, however, is still used in this as in other departments of state action. The courts exercising jurisdiction in England are divided by certain features which may here be briefly indicated.

1. We may distinguish between courts exercising general and those exercising special jurisdiction. The latter are the Admiralty, Ecclesiastical, and University Courts, the limits of which are sufficiently indicated by their names. These administer principles of justice founded on the canon and civil law, but the extent of their jurisdiction is ascertained by the Common Law Courts. 2. Superior and inferior courts. The former are the Courts of Common Law at Westminster, and the Court of Chancery, now High Court of Justice. The latter are the local or district Courts, County Courts, etc. 3. Courts of record and courts not of record. "A court of record is one whereof the Acts and judicial proceedings are enrolled for a perpetual memory and testimony, which rolls are called the records of the court, and are of such high and supereminent authority, that their truth is not to be called in question. For it is a settled rule and maxim that nothing shall be averred against a record, nor shall any plea or even proof be admitted to the contrary. And if the existence of the record shall be denied it shall be tried by nothing but itself; that is, upon bare inspection whether there be any such record or no; else there would be no end of disputes. All courts of record are the courts of the sovereign in right of the Crown and royal dignity, and therefore any court of record has authority to fine and imprison for contempt of its authority" (Stephen's *Blackstone*). 4. Courts may also be distinguished as civil or criminal. 5. A further distinction is to be made between courts of first instance and courts of appeal. In the former the first hearing in any judicial proceeding takes place; in the latter, the judgment of the first court is brought under review. Of the superior courts, the High Court of Justice in its various divisions is a court of first instance. Over it is the Court of Appeal, and over that again the House of Lords. The High Court of Justice is (through divisional courts) a court of appeal for inferior courts. 6. There is a special class of local courts, which do not appear to fall within either the first or second of the classes above-mentioned. Some, while administering the ordinary municipal law, have or had jurisdiction exclusive of their superior courts; such were the Common Pleas of Durham and Lancaster (now transferred to the High Court of Justice), and such still is the Chancery Court of the duchy of Lancaster. Others have concurrent jurisdiction with the superior courts; such are the Lord Mayor's Court of London, the Passage Court of Liverpool, etc.

The distribution of judicial business among the various courts may be exhibited as follows:

**Criminal Courts.**—1. The lowest is that of the justice of the peace, sitting singly, but more usually in petty sessions of two or more, to determine in a summary way certain specified minor offences. In populous districts, such as London, Manchester, etc., stipendiary magistrates are appointed, generally with enlarged powers. Besides punishing by summary convictions, justices may commit prisoners for trial at the assizes. 2. The justices in Quarter Sessions are commissioned to determine felonies and other offences. The 5 and 6 Vict. c. 38 contains a list of offences not triable at Quarter Sessions—treason, murder, forgery, bigamy, etc. (see **QUARTER SESSIONS**). The corresponding court in boroughs is presided over by the recorder. 3. The more serious offences are reserved for the judges of the superior courts sitting under a commission of oyer and terminer or jail delivery for each county.—The Assize Courts, as they are called, sit in general in each county twice a year, following the division of circuits; but winter assizes are now held under 39 and 40 Vict. c. 57, which permits several counties to be united together for that purpose. London, which occupies an exceptional position in all matters of judicature, has a high criminal court of its own, established by 4 and 5 Will. IV. c. 36, under the name of the Central Criminal Court. Its judges usually present are a rota selected from the superior judges of common law, the recorder, common sergeant, and the judge of the City of London Court. The Court of Queen's Bench (now Queen's Bench Division) has a general superintendence over all other courts of criminal jurisdiction, and criminal cases may be moved into the Queen's Bench by the writ of *certiorari*. By 11 and 12 Vic. c. 78, the Court for Crown Cases Reserved was established, to which any question of law arising on the trial of a prisoner may after conviction be remitted by the judge in his discretion.

**Civil Courts.**—In certain special cases, civil claims or small

importance may be brought before justices or stipendiaries. Otherwise, and excepting the special and peculiar jurisdictions above mentioned, the civil business of the country may be said to be divided between the County Courts (taking small cases) and the High Court of Justice (taking all others). Before the constitution of the High Court of Justice the judges of the common law courts sat separately with a jury to try cases at Nisi Prius, the sittings being at Westminster for Middlesex, at Guildhall for the City of London, and according to circuits for the rest of the country; and this arrangement is still followed by the divisions corresponding to the common law courts.

The effect of the recent Judicature Acts on the constitution of the superior courts may be briefly stated. There is now one Supreme Court of Judicature, consisting of two permanent divisions called the High Court of Justice and the Court of Appeal. The former takes the jurisdiction of the Court of Chancery, the three Common Law Courts, the Courts of Admiralty, Probate, and Divorce, the Courts of Pleas at Lancaster and Durham, and the courts created by commission of assize, oyer and terminer, and jail delivery. The latter takes the jurisdiction of the Court of Appeal in Chancery (including Chancery of Lancaster), the Court of the Lord Warden of the Stannaries, and of the Exchequer Chamber, and the appellate jurisdiction in admiralty and heresy matters of the judicial committee; and power is given to the Queen to transfer the remaining jurisdiction of that court to the Court of Appeal. By the appellate Jurisdiction Act of 1876, the House of Lords is now enabled to sit for the hearing of appeals from the English Court of Appeal and the Scotch and Irish courts during the prorogation and dissolution of Parliament. The lords of appeal, of whom three must be present, are the lord chancellor, the lords of appeal in ordinary, and peers who have held "high judicial office" in Great Britain or Ireland. The lords in ordinary are an innovation in the constitution of the House. They hold the rank of baron for life only, have a right to sit and vote in the House during tenure of office only, and a salary of £6000 per annum.

Among obsolete or decayed courts, besides those incidentally mentioned above, the following are the most noticeable:

The *Court Leet*, an old local court described as the most ancient known to the law. It was a court of record, and exercised civil as well as criminal jurisdiction. Its origin and nature are fully discussed in Scriven *On Copyhold*.

*Court Baron*, the court of a manor, presided over by the lord, and of which the free tenants of the manor are suitors.

*Court of Pile Powder (pedis pulverisati)*, having jurisdiction in fairs and markets.

*Court of Chivalry*, or Knight's Court, held by the lord high constable, in matters relating to jousts and tournaments.

The Court of the Marshalsea of the Household of the Kings of England, and the Court of our Lady the Queen, of the Palace of the Queen at Westminster, and Her Majesty's Court of Record for the Honor of Peveril are abolished by the 12 and 13 Vict. c. 101.

The history of English courts affords a remarkable illustration of the continuity that characterizes our institutions. It would hardly be too much to say that all the courts now sitting in England may be traced back to a common origin, and at any rate the higher courts are all offshoots from the same original judicature. Leaving out of account the local courts, we find the higher jurisdiction after the Conquest concentrated along with all other public functions in the king and council. The first sign of a separation of the judicial from the other powers of this body is found in the recognition of a *Curia Regis*, which may be described as the king's council, or a portion of it, charged specially with the management of judicial and revenue business. In relation to the revenue it became the Exchequer, under which name a separate court grew up whose special field was the judicial business arising out of revenue cases. By the Great Charter, the inconvenience caused by the curia following the king's person was remedied, in so far as private litigation was concerned, by the order that common pleas (*Communia Placita*) should be held at some fixed place; and hence arose the Court of Common Pleas. The *Curia Regis*, after having thrown off these branches, is represented by the Queen's Bench, so that from the same stock we have now three courts, differing at first in functions, but through competition for business, and the ingenious use of fictions, becoming finally the co-ordinate Courts of Common Law of our later history. In one line of development the council becomes, by the addition of representatives from counties and boroughs, the Parliament in its two Houses of Lords and Commons. But an inner circle of counsellors still surrounded the king, and in his name claimed to exercise judicial as well as other power; hence the chancellor's jurisdiction, which became, partly in harmony with the supra-legal power claimed from which it

sprang, and partly through the influence of the ecclesiastical chancellors by whom it was first administered, the Equity of English law. Similar developments of the same authority were the Court of Requests (which was destroyed by a decision of the Common Pleas) and the Court of Star Chamber,—a Court of Criminal Equity, as it has been called, which, having been made the instrument of tyranny, was abolished in 1641. Even then the productive power of the council was not exhausted; the judicial committee of the Privy Council, established by 2 and 3 Will. IV. c. 92, superseding the previous Court of Delegates, exercises the jurisdiction in appeal belonging to the king in council. The appellate jurisdiction of the Lords rests on their claim to be the representatives of the ancient great council of the realm. (E. R.)

**COURT-MARTIAL.** Courts-martial have inherited part of the jurisdiction of the old *Curia Militaris*, or Court of the Chivalry, in which a single marshal and at one time the High Constable proceeded "according to the customs and usages of that court, and, in cases omitted according to the civil law, *secundum legem armorum*" (Coke, 4 Ins. 17). The modern form of the courts was adopted by ordinance in the time of Charles I., when English soldiers were studying the "articles and military laws" of Gustavus Adolphus and the Dutch military code of Arnheim; it is first recognized by statute in the first Mutiny Act, 1 Will. and Mary c. 5. The royal prerogative of issuing commissions under the sign-manual for holding courts-martial, although superseded as regards the United Kingdom by the express power to make certain articles of war which the Mutiny Acts confer on the sovereign, still exists as regards courts-martial held abroad. But the Mutiny Acts also provide for the issue to commanders abroad of warrants to convene courts-martial, or to authorize field-officers to convene them, and even make it lawful in special cases beyond sea for any officer to convene a detachment general court-martial without warrant or commission. The trial of the militia, yeomanry, and volunteers is provided for by "The Volunteer Act, 1863," and "The Regulation of the Forces Act, 1871." In India the *punchayats*, or native military tribunals, are frequently employed. All commissioned officers on full pay, officers of the general staff, although on half staff pay, and officers on brevet rank, are eligible as members of a court-martial. The president of the court is necessarily the senior combatant officer present, unless it has been his duty to investigate the charges against the prisoner; and it is a general rule that the members should be of equal or superior rank to the prisoner. Impartiality is secured by the system of "roster," i. e., the "tour of duty" is from the senior downwards. The jurisdiction of courts-martial is not confined to purely military offences, but, as regards felonies and misdemeanors mentioned in the Mutiny Act or the Articles, is concurrent with, though subordinate to, the jurisdiction of the ordinary criminal courts. The Mutiny Act, indeed, directs that soldiers charged with common offences against the peace should be delivered up to the magistrate. Officers tried in an ordinary court can be punished afterward by court-martial only by cashiering or reduction. There is a wholesome regulation against sending home for trial accused officers or men, except in cases of unavoidable necessity, but the jurisdiction extends to offences wherever committed. No court-martial can sit in one of H. M. ships in commission, but the "Naval Discipline Act, 1866," subjects land forces on board to its provisions. Half-pay officers are not subject to martial law, but it is thought they ought to be made so, as they derive advantage from retaining their commissions. Even the licensed sutlers, who follow the autumn manoeuvres, are under the Mutiny Act. So are paid recruiting officers, though not themselves enlisted, and, to a certain extent, the "army reserve." But a prisoner of war on parole cannot be brought to trial, and all military offences prescribe in three years. From the administration of martial law must carefully be distinguished the procedure by court-martial authorized by the 148d Article of War in places where there is no "form of civil judicature in force," and with regard to civil crimes. In such cases the court-martial applies the civil law, but its jurisdiction is ousted wherever there is a competent civil court under the royal authority, although that court may itself administer not British law, but French, or Roman-Dutch, or any other form of colonial law, and may do so by machinery of procedure quite unfamiliar to British sol-

diers. This special jurisdiction of courts-martial in non-military offences would also exist where the ordinary courts had been closed by a declaration of martial law (see case of Rev. John Smith of Demerara, June, 1824, 2 Hansard, xi. 976).

The old form of field or drum-head court-martial (in which no notice was given, no oath administered, and no written record kept) being now happily extinct, there remain three forms—(1) general and detachment general courts-martial, (2) district and garrison courts-martial, and (3) regimental and detachment courts-martial, which are distinguished by their powers of awarding punishment, and by the dress of the officers attending them—viz., review order, marching order, drill order. The two latter are called minor courts, and commissioned officers are not amenable to their jurisdiction. A great many offences are, by the Articles of War, made appropriate to the different courts, the general rule being that the general court is not to be resorted to except in aggravated cases, punishable by penal servitude or death. By permission of a general officer the regimental court may try an offence expressly assigned to a higher court, but in no case may it try desertion. To a certain extent these rules are set aside on the line of march or on board ship, but there is always a maximum of punishment which each court is bound to observe. In 1868 the number of members required for a general court at home was reduced from thirteen to nine, a judge-advocate being in attendance. The general court can try all military offences in whatever regiment under the command committed, and it is the only martial court which takes cognizance of civil offences; it also hears appeals from regimental courts. The detachment general court which is since 1860 only competent "beyond seas," where it is impracticable to hold a general court, was introduced by Wellington, "to repress the spirit of plunder and outrage which had broken out in the army after the battle of Vittoria" (*Supp. Desp.* viii. 104). It consists of three commissioned officers, summoned without royal warrant, to investigate any offence against the person or property of an inhabitant of the country where the detachment is. The sentence must be confirmed by the general officer. The district or garrison court, which superseded in 1829 the older general regimental court, consists of seven members, the president doing the work of a judge-advocate in summoning witnesses, administering oaths, and transmitting the proceedings to the judge-advocate-general in London. The power of this court to imprison non-commissioned officers and privates was in 1864 extended from six months to two years; and in 1869 it received additional power to impose forfeitures and to discharge with ignominy. Another form of district court was that formerly called detachment court for the trial of warrant officers (*i. e.*, officers appointed by warrant under the signature of colonels or commandants of corps). The regimental court, summoned by the colonel, consists of five or three members, with power to inflict limited sentences of imprisonment, corporal punishment, solitary confinement, and also fines, stoppages, and other punishments not peculiar to this court. There are also courts or boards of inquiry, called by an exercise of the royal prerogative to inquire into such questions as the failure of an expedition, or the necessity for an armistice or convention, often in order to determine whether or not a court-martial should be held. It was found in the well-known cases of Lord Bentinck (1820) and Lieutenant-Colonel Dawkins (1873) that the Crown may withhold the proceedings of these courts from the courts of law, and that military witnesses are protected from actions of damages in respect of their evidence before such a court. Where an officer is called before the court of inquiry he is not put on oath, or even bound to answer questions which he thinks may be prejudicial to him; and in connection with the celebrated Simla court-martial (1867) this rule was extended to the production of documents. The Articles of War of 1860 introduced a regimental court of inquiry for the purpose of hearing the complaints and redressing wrongs of non-commissioned officers "and soldiers in any matter respecting their pay or clothing." This court, which is generally held by the captain, also inquires into cases of maiming and mutilation, and all judgments may be appealed against to a general court. Smaller courts of inquiry examine cases of illegal absence, loss of medals, and the return of officers who may have been taken prisoner by the enemy by their own neglect.

All members of a court-martial take an oath not only to try according to the evidence, but to keep the sentence of the court secret until approved, and to keep secret the votes and opinions of particular members. Even a peer, if serving on a court-martial, cannot use his privilege of giving judgment on honor. As might be expected, the army has a very varied experience in the forms of swearing witnesses. Besides the ordinary Protestant mode of kissing the Bible or Testament, and the ordinary Catholic mode of marking a cross on the closed book, Mahometans are sworn by kissing or placing on their heads the Koran, Sikhs upon the Grinlh, Hindus upon the Vedas, or by touching the Brahman's foot; and, according to caste custom, Indian witnesses sometimes insist on the oath being administered by a Brahman. But in India affirmations are now generally taken. While a Jew insists on wearing his hat, as in the synagogue, all soldiers, though bound to remain covered before the court, remove their caps in swearing, just as a Protestant witness unglves his hand. Kaffir witnesses before a court-martial have sworn by their own chief, and a Kaffir chief by the king of England. The colonial legislatures, however, have generally made provision for receiving unsworn evidence of barbarous and uncivilized people who have no religious belief. The judge-advocate is a legal assessor and clerk, but in no sense the prosecutor, although the judge-advocate-general still frames and sanctions the formal charges in the indictment. The latter is a Parliamentary officer appointed on change of ministry, and a member of the Privy Council. He advises the Crown as to the legality of courts-martial, reviews proceedings brought under his notice, confidentially advises the commander-in-chief, and is the custodian of the court records. The prosecutor is a staff-officer, or the prisoner's commanding officer, or a field-officer of the regiment, or an adjutant. The prisoner is generally entitled to have legal assistance, and also a private interpreter as a check on the translation of the interpreter for the prosecution. He has no peremptory challenges; but he may challenge on the grounds of defect of rank, inexperience, prejudice, or malice. Formerly, if the prisoner "stood mute," the court-martial entered a verdict of guilty, but this is now altered in conformity with common sense. Where he does not adduce evidence in defence, the prisoner (contrary to the rule under Denman's Act in criminal courts) has a right to the last word. The judgment of the court is by simple majority, except in capital charges, which require the concurrence of two-thirds. The same distinction holds in the subsequent voting on the sentence. Since 1868 the word "honorably" has disappeared from verdicts of acquittal; and the finding "that the charge has not been proved" has been discontinued. Capital punishment awarded for military offences is generally carried out by shooting, but hanging is also competent. In trifling cases between officers the court frequently dictate the terms of a written or verbal apology; and in separate remarks they often observe on the conduct of the prosecutor, on the frivolous or groundless nature of the charges, or the intemperate defence of a prisoner whom they acquit. Such remarks are acted on at headquarters. As a general rule the sovereign's confirmation is required to the decision of a general court. Officers commanding abroad (except in India) have a limited power of confirmation depending on the nature of the sentence. The commander-in-chief in India may confirm all sentences; and this absolute power was also given to Lord Raglan in the Crimea. Even in India, however, a capital sentence by court-martial for a civil offence requires the approval of the governor-general. When a decision, not of acquittal, comes up for approval, it is indispensable that the judge-advocate-general should have a personal audience with the queen. Her Majesty may not only approve, but may also order revision of the proceedings; and where the conviction is sustained, the sentence may be remitted or mitigated, but the professional penalties which martial law attaches to conviction cannot be remitted. The members of courts-martial and those who carry out their sentences are of course liable for illegal sentences or irregularities. Thus in 1861, owing to a defect in the Acts regulating the transfer of colonial prisoners, Lieutenant Allen recovered £200 from H. R. H. the duke of Cambridge for false imprisonment.

In conclusion, it may be stated that treason and other non-military offences, which, if committed in England

would be punishable in the ordinary criminal courts, are tried by a general court-martial, if committed on service at Gibraltar, or in India, 120 miles distant from any of the three presidencies; or elsewhere in the queen's dominions, where there is no competent civil court, or out of the Queen's dominions.

*Naval Courts-Martial.*—The administration of the barbarous naval law of England was long entrusted to the discretion of commanders acting under instructions from the lord high admiral, who was supreme over both the royal and merchant navy. It was the leaders of the Long Parliament who first secured something like a regular tribunal by passing in 1645 an Ordinance and Articles concerning Martial Law for the Government of the Navy. Under this ordinance Blake, Monk, and Penn issued instructions for the holding general and ship courts-martial with written records, the one for captains and commanders, the other for subordinate officers and men. Of the latter, the mate, gunner, and boatswain were members, but the admirals reserved a control over the more serious sentences. Under the Act 13 Car. II. c. 9, the high admiral again received power to issue commissions for holding courts-martial—a power which continues to be exercised by the Board of Admiralty. During the 18th century, under the auspices of Anson, the jurisdiction was greatly extended, and the Consolidation Act of 1749 was passed, in which the penalty of death occurs as frequently as the curses in the commination service. The Naval Articles of War have always been statutory, and the whole system may be said to rest on the Naval Discipline Acts of 1860 and 1866. The navy has its courts of inquiry for the confidential investigation of charges "derogatory to the character of an officer and a gentleman." Under the Act of 1866 a court-martial must consist of from five to nine officers of a certain rank, and must be held publicly on board of one of H. M. ships of war, and where three such ships are together. The rank of the president depends on that of the prisoner. A judge-advocate attends, and the procedure resembles that in military courts, except that the prisoner is not asked to plead, and the sentence, if not one of death, does not require the confirmation of the commander-in-chief abroad or of the Admiralty at home. The court has a large and useful power of finding the prisoner guilty of a less serious offence than that charged, which might well be imitated in the ordinary criminal courts. The death sentence is always carried out by hanging at the yard-arm; Admiral Byng, however, was shot in 1757. The Board of Admiralty have, under the Naval Discipline Acts, a general power of suspending, annulling, and modifying sentences which are not capital. The jurisdiction extends to all persons belonging to the navy, to land forces and other passengers on board, shipwrecked crews, spies, persons borne on the books of H. M. ships in commission, and civilians on board who endeavor to seduce others from allegiance. The definition of the jurisdiction by locality includes harbors, havens, or creeks, lakes or rivers, in or out of the United Kingdom; all places within the jurisdiction of the Admiralty; all places on shore out of the United Kingdom; the dockyards, barracks, hospitals, &c., of the service wherever situated; all places on shore in or out of the United Kingdom for all offences punishable under the Articles of War except those specified in section 38 of the Naval Discipline Act, 1860. Under the Marine Mutiny Acts the Royal Marine forces are, while on board, or borne on the books of H. M. ships, subject to naval courts-martial. In other circumstances the Articles of War made by the Lord High Admiral for the government of the Royal Marines are carried out by general courts-martial, district or garrison courts-martial, divisional and detachment courts-martial, courts-martial on the line of march or in transport ships, all held under the authority, mediate or immediate, of the lord high admiral. The regulations of these different courts in the Marine Mutiny Acts are very much the same as in the case of courts-martial for the land forces. Officers of both services often sit together.

See Simmons *On the Constitution and Practice of Courts-Martial*, 7th ed. 1875; Clode, *Military and Martial Law*, 1872; and Thring's *Treatise on the Criminal Law of the Navy*, 1861. The earlier writers on courts-martial are Ayle (1796), M'Arthur (1813), Maltby (1813, Boston), James (1820), D'Aguiar (1843), and Hough, *Precedents of Military Law* (1855). See also the annual Mutiny Acts and the Articles of War, and the articles **MILITARY LAW AND NAVY**.

**COURT, ANTOINE** (1696–1760), who has been designated the "Restorer of Protestantism in France," was born at the village of Villeneuve-de-Berg, in the province of the Vivarais, in 1696. His parents were poor, belonging to the peasant class, and were unable to give him what was considered a good education. But they were pious folk, adherents of the Reformed Church, against which the most ruthlessly cruel persecution was so long directed by the French Government. Brought up in the fear of God, and early acquainted with the Holy Scriptures, he began to show in his boyhood the signs of a high calling. He was eight years old when the Camisard revolt was finally suppressed, and nineteen when the infamous decree of Louis XIV. was published, declaring that all who professed the Reformed faith should be punished as relapsed heretics. Antoine, taken to the secret meetings of the persecuted Calvinists, held "in dens and caves of the earth" often in darkness, no pastor nor "prophet" present to teach or console, began, when only seventeen, to speak and exhort in these congregations of "the desert." The desire naturally arose in him to deliver the people, and to build up on solid foundations the church which was threatened with extinction. For this purpose he proposed four things as essential:—regular religious meetings for teaching and worship; suppression of the fanaticism of the "inspired," and of the disorders to which it gave rise; restoration of discipline by the establishment of consistories, conferences, and synods; and a careful training of a body of pastors. To the execution of this vast undertaking he devoted his life. The scene of his labors for fifteen years was Languedoc, the Vivarais, and Dauphiny. His beginnings were very small prayer-meetings in "the desert," attended by some half-dozen or dozen persons only. But the work progressed under his wise direction, and after forty years' labor he addressed on one occasion a meeting of 10,000 on the spot where at first he could scarcely gather fifty. In 1724 another heavy blow was struck at Protestantism in the edict of Louis XV., which again assuming that there were no Protestants in France, prohibited the most secret exercise of the Reformed religion, and imposed monstrous penalties. It was impossible fully to carry out its menaces. But persecution raged, especially against the pastors. Many of them were executed, and many fled. A price was set on the life of Antoine Court; and in 1730 he quitted France and took up his abode at Lausanne. He had seen that it was necessary to have a theological college, and Lausanne appeared to be a fitting place for it. He therefore, with the aid of some of the Protestant princes, established the college, and during the remaining thirty years of his life he filled the post of director. He had the title of deputy-general of the churches, and was really the pillar of their hope. He carried on a very extensive correspondence; and, through the often repeated persecutions of his fellow-religionists, fought their battle manfully. The college of Lausanne sent forth all the pastors of the Reformed Church of France till the days of the first French empire. Court formed the design of writing a history of Protestantism, and made large collections for the purpose; but this he did not live to carry out. His character has been thus drawn by M. de Végobre:—he possessed sound straightforward sense, wonderful facility of expression, intrepid courage joined with consummate prudence, astonishing vigor to support the greatest fatigues of body and mind, purity and integrity ever beyond suspicion, and unshaken devotion to the holy cause to which he had consecrated himself. Antoine Court died at Lausanne in 1760. He was the father of the more generally known Court de Gebelin. He hardly finds a place in biographical dictionaries; indeed, for a long time his name and work were almost ignored even by French writers on the history of the Reformed Church.

For details of his life see Peyrat's *Histoire des Pasteurs du Désert*, Coquerel's work bearing the same title, and De Fellos's *Histoire des Protestants de France*. The first special biography of Court appears to be that by M. Edmond Hugues, entitled *Antoine Court, Histoire de la Restauration du Protestantisme en France au XVIII. Siècle*, published in 1872.

**COURT DE GEBELIN, ANTOINE** (1725–1784), a celebrated French scholar, was the son of the preceding, and was born at Nîmes in 1725. He received a good education, and became, like his father, a pastor of the Reformed Church. This office, however, he soon relinquished, to de-

vote himself entirely to literary work. He had conceived the project of a work which should set in a new light the phenomena, especially the languages and mythologies, of the ancient world; and after his father's death, he took up his abode at Paris for the sake of being within reach of the necessary books for his intended researches. After long years of studious devotion, he published in 1775 the first volume of his vast undertaking under the title of *Le Monde Primitif, analysé et comparé avec le monde moderne*. The ninth volume appeared in 1784, leaving the work still unfinished. The literary world marvelled at the encyclopædic learning displayed by the author, and supposed that the Forty of the Academy, or some other society of scholars, must have combined their powers in its production. Now, however, the world has well-nigh forgotten the huge quartos. These learned labors did not prevent Gebelin from pleading earnestly the cause of religious tolerance. In 1780 he published a work entitled *Les Toulousaines*, advocating the rights of the Protestants; and he afterwards established at Paris an agency for collecting information as to their sufferings, and for exciting general interest in their cause. He co-operated with Franklin and others in the periodical work entitled *Affaires de l'Angleterre et de l'Amérique* (1776, *seq.*), which was of course devoted to the support of American independence. He was also a supporter of the principles of the economists, and *Quemay* called him his well-beloved disciple. In the last year of his life he became acquainted with *Mesmer*, and published a *Lettre sur le magnétisme animal*. He was imposed upon by speculators in whom he placed confidence, and was reduced to destitution by the failure of a scheme in which they engaged him. He died at Paris, May 10, 1784.

**COURTOIS, JACQUES AND GUILLAUME** (1621-76 and 1628-79). The two French painters who bore these names are also called by the Italian equivalents *Giacomo* (or *Jacopo*) *Cortese* and *Guglielmo Cortese*. Each of the brothers is likewise named, from his native province, *Le Bourguignon*, or *Il Borgognone*.

Jacques Courtois was born at St. Hippolyte, near Besançon in 1621. His father was a painter, and with him Jacques remained studying up to the age of fifteen. Towards 1637 he came to Italy, was hospitably received at Milan by a Burgundian gentleman, and entered, and for three years remained in, the French military service. The sight of some battle-pictures revived his taste for fine art. He went to Bologna, and studied under the friendly tutelage of Guido; thence he went to Rome, where he painted, in the Clatercian monastery, the *Miracle of the Loaves*. Here he took a house, and entered upon his own characteristic style of art, that of battle-painting, in which he has been accounted to excel all other old masters; his merits were cordially recognized by the celebrated *Cerquozzi*, named *Michelangelo delle Battaglie*. He soon rose from penury to ease, and married a painter's beautiful daughter, *Maria Vagini*; she died after seven years of wedded life. Prince *Matthias of Tuscany* employed Courtois on some striking works in his villa, *Lappoggio*, representing with much historical accuracy the prince's military exploits. In Venice also the artist executed for the senator *Sagrado* some remarkable battle-pieces. Returning to Florence, he entered the Society of Jesus, taking the habit in Rome in 1655; it was calumniously rumored that he adopted this course in order to escape punishment for having poisoned his wife. As a Jesuit father, Courtois painted many works in churches and monasteries of the society. He lived piously in Rome, and died there of apoplexy on 20th May, 1676 (some accounts say 1670 or 1671). His battle-pieces have movement and fire, warm coloring, and great command of the brush,—those of moderate dimensions are the more esteemed. They are slight in execution, and tell out best from a distance. Courtois etched with skill twelve battle subjects of his own composition. The *Dantzig* painter named in Italy *Pandolfo Reschi* was his pupil.

Guillaume Courtois, born likewise at St. Hippolyte, came to Italy with his brother. He went at once to Rome, and entered the school of *Pietro da Cortona*. He studied also the *Bolognese* painters and *Guercino*, and formed for himself a style with very little *excess* mannerism, partly resembling that of *Maratta*. He painted the *Battle of Joshua* in the *Quirinal Gallery*, the *Crucifixion of St. Andrew* in the church of that saint on *Monte Cavallo*, various works for the *Jesuits*, some also in co-operation with his brother. His last production was *Christ admonishing Martha*. His

draughtsmanship is better than that of *Jacques*, whom he did not, however, rival in spirit, color, or composition. He executed some etchings, moreover. *Guillaume Courtois* died of gout on 15th June, 1679.

**COURTRAI**, in Flemish *Kortrijk*, a manufacturing and fortified town of Belgium, capital of the *arrondissement* of Courtrai, province of West Flanders, 26 miles southwest of Ghent. It is a neat, well-built town, situated on both sides of the *Lys* or *Ley*, and connected by railways with most of the principal places in Belgium. Among its remarkable public buildings are the *hôtel de ville*, a Gothic edifice, built in 1526, and containing two singularly carved chimney-pieces, representing the *Virtues* and *Vices*, and events in the early history of the town, and the church of *Notre Dame*, a Gothic structure, founded in 1238 by *Baldwin*, count of Flanders and emperor of Constantinople, but, except a small portion on one side, modernized and lined with marble. This church contains *Vandycy's* celebrated painting of the *Raising of the Cross*. In *St. Martin's Church* is a beautiful tabernacle of carved stonework in the richest Gothic style, erected probably about the end of the 15th century; this church, which dates from about 1390, was rebuilt in the 15th century, and again after being burned in 1862. Courtrai has also an exchange, a college, an academy of design, two orphan asylums, and a public library. A great part of its inhabitants are employed in the spinning of flax and the weaving of plain and damask linens; 5000 to 6000 women are employed in lace-making, besides which cotton and woollen goods, paper, sugar, tobacco, leather, soap, etc., are manufactured. The vicinity is highly cultivated, producing large quantities of the finest flax for supplying the manufactories of the town and for exportation. Courtrai existed in the time of the Romans under the name of *Cortoriacum*, which was afterwards changed to *Curriculum*. In the 7th century it was a municipal city, and in 1302 was fought under its walls the famous battle of the *Spurs*, in which 20,000 Flemings, chiefly weavers from Ghent and Bruges, routed and put to flight a French army of 7000 knights and noblemen, and 40,000 infantry. About 700 gilt spurs were gathered on the field of battle, and hung up as a trophy in the church of the convent of *Groenangen*, now destroyed. The town was taken by the French in 1793, and made the capital of the department of *Lys*. Population (1874) 27,076.

**COUSIN, VICTOR** (1792-1867), was, like another eminent Frenchman, *Jean Jacques Rousseau*—*Birth education*—the son of a watchmaker. He was born in Paris, in the *Quartier St. Antoine*, on the 28th November, 1792. The year of his birth was a critical one for France and for Europe. The ruins of the *Bastille*, which adjoined the place of his birth, already symbolized the wreck of the ancient order of things. The *National Assembly* had in the autumn decreed the deposition of the king; the *National Convention* had been appointed to try him as *Louis Capet* (21st September), and three days later France was declared a republic. While the childhood of the future philosopher was passing in the *Quartier St. Antoine*, the king was guillotined in the neighboring *Place de la Révolution*; Christianity was deposed, like the monarch himself, and the worship of reason solemnly inaugurated; *Marie Antoinette* passed through her bitter humiliations to execution. Before the boy was old enough to be sent to the secondary school of the *Quartier*, *Danton* and *Robespierre* had risen, tyrannized, and fallen; the *Girondists* had gone down before the *Jacobins*, and *Bonaparte* had been proclaimed consul. A youth whose predilections were towards letters or philosophy had his lot cast in especially troubled times. At the age of ten young Cousin was sent to the secondary or grammar school of the *Quartier St. Antoine*, named *Lycée Charlemagne*, a seminary of a rank analogous to the *Prussian gymnasium*. Here he studied until he was eighteen. This embraced the time of the *Consulate* and the *First Empire*,—the period of the power of *Bonaparte* down to very near the commencement of its decline. The *Lycée* had a connection with the university, and when Cousin left the secondary school, he was crowned in the ancient hall of the *Sorbonne* for the Latin oration delivered by him there, in the general concourse of his school competitors. This juvenile distinction may be taken as the sign and promise of that fervid oratorical power for which in after years he was so remarkable. Curiously enough, it was this very hall of the *Sorbonne* which afterwards witnessed the greatest oratorical triumphs of his manhood, and it was in a seat



of rooms under the same roof that he passed in quiet reflective seclusion the latter years of his long and active intellectual life. The careful classical training of the *Lyceé* had at this early period strongly disposed him to literature. He was already known among his compeers for a decided superiority in Greek and familiarity with the best Greek authors. From the *Lyceé* he passed to the Normal School of Paris,—an institution of the higher educational order corresponding very much to the faculty of arts in our Scottish universities. It was destined to train the best youths of the secondary schools for teachers in the more advanced departments. At first simply a pupil, he very soon became a monitor or *maître-répétiteur* in Greek. His impulse at this time was entirely towards letters. But it was now his

Early philosophical influences.

fortune to meet with a powerful influence in a somewhat opposite direction. This was the teaching of Laromiguière, who was then lecturing on philosophy in the Normal School. Cousin was through life essentially open to and impressible by outward influences; and the earnestness and striking power of intellectual analysis displayed by the thinker in France who first opened up to him the questions of philosophy, and first, though only slightly, broke up the beaten path of Condillacism, were very certain to modify his character and studies. In the second preface to the *Fragmens Philosophiques*, in which he manfully and candidly states the varied philosophical influences of his life and their relation to his own opinions, he speaks of the grateful emotion excited by the memory of the day in 1811, when as a pupil in the Normal School destined to letters, he heard Laromiguière for the first time. "That day decided my whole life. Laromiguière taught the philosophy of Locke and Condillac, happily modified on some points, with a clearness and grace which in appearance at least removed difficulties, and with a charm of spiritual *bonhomie* which penetrated and subdued." Cousin was set forthwith to lecture on philosophy, and he speedily obtained the position of master of conferences (*maître de conférences*) in the school. It was the practice of his pupils, who were usually in the third year of their course, to take notes and make a summary of the lectures delivered, and thereafter to meet in conference, the master presiding, for the purpose of discussing the principal points contained in them. This was the revival of a process very much akin to the mediæval practice of *determining* as it was called. Cousin in the first preface to the *Fragmens* refers with great pleasure to the cherished memories of this period, when, he himself young and ardent, and surrounded by sympathetic pupils, they together, forgetful of all else, essayed "the eternal problems" of speculative philosophy.

The youthful thinker very soon, however, passed beyond the point of view of Laromiguière. Royer-Collard was lecturing in the chair of the history of modern philosophy in the faculty of letters. Cousin was very speedily attracted by him, and the teaching of Royer-Collard formed the second great philosophical impulse of his life. This teacher, as he tells us, "by the severity of his logic, the gravity and weight of his words, turned me by degrees, and not without resistance, from the beaten path of Condillac into the way which has since become so easy, but which was then painful and unfrequented, that of the Scottish philosophy." In 1815-16 Cousin attained the position of *suppléant* or assistant to Royer-Collard in the chair of the faculty of letters. But there was still another mind which influenced the young and susceptible philosopher at this early period. This was Maine-de-Biran,—the expounder of the volitional theory of cause, and the upholder of a highly spiritual philosophy. Cousin regarded Maine-de-Biran as the unequalled psychological observer of his time in France, alike in the delicacy and the depth of his analysis. All these men strongly influenced both the method and the matter of his philosophical thought. To Laromiguière he himself attributes the lesson of decomposing thought, even though the reduction of it to sensation was inadequate. Royer-Collard taught him that even sensation is subject to certain internal laws and principles which it does not itself explain, which are superior to analysis and the natural patrimony of the mind. De Biran made a special study of the phenomena of the will. He taught him to distinguish in all cognitions, and especially in the simplest facts of consciousness, the fact of voluntary activity, that activity in which our personality is truly revealed. It was through this "triple discipline," as he

calls it, that Cousin's philosophical thought was first developed, and that in 1815 he entered on the public teaching of philosophy in the Normal School and in the faculty of letters.<sup>1</sup> But the energy and impressibility of the young professor were not to be limited by the philosophical thought of his own country. He betook himself to the study of German, worked at Kant and Jacobi, and then sought to master the *Philosophy of Nature* of Schelling. By this he was at first greatly attracted. The influence of Schelling became manifest in his teaching, and it may be observed very markedly in the earlier form of his philosophy. He sympathized with the principle of faith of Jacobi, but regarded it as arbitrary so long as it was not recognized as grounded in reason. In 1817 he went to Germany, and met Hegel at Heidelberg. In this year appeared Hegel's *Encyclopædia of the Philosophical Sciences*, of which Cousin had one of the earliest copies. He thought Hegel not particularly amiable; but the two became friends. The following year Cousin went to Munich, where he met Schelling for the first time, and spent a month with him and Jacobi, obtaining a deeper insight into the *Philosophy of Nature*. His contrast of Hegel and Schelling is interesting. No two people, he tells us, can be more unlike than the master and the disciple. "Hegel lets fall words few and profound, and somewhat enigmatic; his speech is strong but embarrassed; his immovable countenance, his clouded forehead, seem the image of thought which turns back on itself. Schelling is thought-developed. His language is like his look, rapid, full of *éclat* and life. He is naturally eloquent."

Cousin's future course in life as a professor of philosophy seemed now to be determined. Political troubles. But the political troubles of the country were to interfere for a time with this promising career. In the events of 1814-15 Cousin took the royalist side. He at first adopted the views of the party of which Royer-Collard was the philosophical chief, known as *doctrinaires*. He seems then to have gone further than this party, and even to have approached the extreme left or *Carbonari* section of politicians. This has been alleged, though it is not in accordance with the usual moderation of his character and political views. Then came a reaction against liberalism, and in 1821-22 Cousin was deprived of his offices alike in the faculty of letters and in the Normal School. The Normal School itself was swept away. He simply shared at the hands of a narrow and illiberal Government, influenced mainly by the priesthood, the fate of Guizot, who was ejected from the chair of history. Such was the spirit which actuated the first restoration and the Government of Louis XVIII. This enforced abandonment of public teaching was not wholly an evil to the young speculator. He again set out for Germany with a view to further philosophical study. And here there occurred a curious episode in his life. While at Berlin in 1824-25 he was arrested and thrown into prison, either on some ill-defined political charge at the instance of the French police, or on account of certain incautious expressions which he had let fall in conversation. This imprisonment was in fact the result of the persistent persecution of the man who exercised free thought and preached toleration, at the hands of the priestly party in France, who, ruling a weak king, had already deprived the professor of his public offices. Cousin was liberated at the end of six months,—having thus for an abstract philosopher had a tolerable taste of political martyrdom. He continued under the suspicion of the French Government for three years longer. It was during this period, however, that he thought out and developed what is distinctive in his philosophical doctrine. His eclecticism, ontology, and his philosophy of history were declared in principle and in most of their salient details in the *Fragmens Philosophiques* of 1826. The preface to the second edition (1833) and the *Avertissement* to the third (1838) aimed at a vindication of his principles from hostile contemporary criticism. Even the best of his later books, the *Philosophie Économique*, the *Du Vrai, du Beau, et du Bien*, and the *Philosophie de Locke* were simply matured revisions of his lectures during the period from 1815 to 1820. The lectures on Locke were first sketched in 1819, and fully developed in the course of 1829.

During the seven years of forced abandonment of teaching, he produced, besides the *Fragmens*, the edition of the

<sup>1</sup> *Fragmens Philosophiques*,—Preface Deuxième.

works of Proclus (6 vols. 1820-27), and the works of Descartes (11 vols., 1826). He also commenced his *Translation of Plato* (13 vols.), which occupied his leisure time from 1825 to 1840.

We see in the *Fragmens* very distinctly the fusion of the different philosophical influences of his life to which we have referred, and by which his opinions were finally moulded and matured. For Cousin was as eclectic in cast of thought and personal habit of mind as he was in philosophical principle and system. It is with the publication of the *Fragmens* of 1826 that the first great widening of his reputation is associated. In 1827 followed the *Cours de l'Histoire de la Philosophie*.

In 1828 popular feeling forced the king (Charles X.) to a change of ministry, and M. Martignac returned to the constitutional Charter of 1814, which sought to conciliate liberty and order, but which had been most unfaithfully worked under the restoration. A more enlightened and tolerant spirit seems to have arisen, and M. de Vatimesnil, minister of public instruction, recalled Cousin along with Guizot to his professorial position in the university. Cousin's reappearance in the chair, "on the occasion," as he said, "of the return of the constitutional hopes of France," was marked by an enthusiastic demonstration on the part of students and authors. The professoriate in Paris reached its golden age, at least in this century, when Guizot, Villemain, and Cousin were now colleagues in the faculty of letters.

The three years which followed 1828 was the period of Cousin's greatest distinction and triumph as a lecturer. He reappeared in sympathy with the national feeling of the time; he had suffered for his adherence to popular principles; his return to the chair was at once a compensation for what he had undergone, and the symbol of the triumph of constitutional ideas. This prepared a ready sympathy for him. The hall of the Sorbonne was crowded with auditors as the hall of no philosophical teacher in Paris had been since the days of Abelard. The lecturer had a singular power of identifying himself for the time with the system which he expounded, and the historical character he portrayed. Clear and comprehensive in the grasp of the general outlines of his subject, he was at the same time exceedingly methodical and vivid in the representation of details. In exposition he had the rare art of unfolding and aggrandizing. Beginning with the simple or particular, he proceeded readily and easily to complete the listener's grasp of the matter in hand. There was a rich deep-toned resonant eloquence mingled with the speculative exposition; his style of expression was clear, elegant, and forcible, abounding in happy turns and striking antitheses. To this was joined a singular power of rhetorical climax. His philosophy exhibited in a striking manner the generalizing tendency of the French intellect, and its logical need of grouping details round central principles. The pretension even to grasp and formulize the history of philosophy was dazzling to the imagination of a Parisian auditor, however little ground it might have in fact or reason.

There was withal a moral earnestness and elevation in his spiritual philosophy which came home to the hearts of his hearers, and which seemed to afford a ground for higher development in national literature and art, and even in politics, than the traditional philosophy of France had appeared capable of yielding. It was thus not to be wondered at that the philosophical orator was received with enthusiasm, and that his lectures produced more ardent disciples, imbued at least with his spirit, than it has been the fortune of any other professor of philosophy in France to gather round him in this century. Tested by the power and effect of his teaching influence, Victor Cousin occupies a foremost place in the rank of professors of philosophy who, like Jacobi and Schelling in Germany and Dugald Stewart in Scotland, have united the rare gifts of speculative, expository, and imaginative faculty. Tested even by the strength of the reaction which his writings have in some cases occasioned, his influence is hardly less remarkable, and the degree of petulant detraction to which he himself and his philosophy have been subjected even in France may be taken as the tribute of envy to his power. The taste for philosophy,—especially its history,—was revived in France to an extent unknown since the 17th century.

Among the more distinguished men who were influenced by the teaching and example of Cousin, and who have carried on philosophical work in his manner and spirit, we may note Jouffroy, Damiron, Garnier, Barthelemy St. Hilaire, Ravaisson, Rémusat, Jules Simon, and Franck. Jouffroy and Damiron were first fellow students, and then auditors and disciples. Jouffroy, however, always kept firm to the early—the French and Scottish—impulses of Cousin's teaching. The best research in the history of philosophy, and the best thought of France during the period from 1830 to 1848, were doubtless due to the teaching and writings of Cousin. In fact, for fully fifty years of the philosophical life of France, Cousin has been the greatest power. He continued to lecture regularly for two years and a half after his return to the chair. The three bloody days of July, 1830, led to the flight of Charles X. This was followed by the accession of Louis Philippe, "by the will of the people,"—which meant very much the *bourgeoisie* of Paris and the middle class of the country. Cousin sympathized entirely with the revolution of July, and he was at once recognized by the new Government as a friend of national liberty and constitutional rights. Writing in June, 1833, he explains both his philosophical and his political position:—

"I had the advantage of holding united against me for many years, both the sensational and the theological school. In 1830 both schools descended into the arena of politics. The sensational school quite naturally produced the demagogic party, and the theological school became quite as naturally absolutism, safe to borrow from time to time the mask of the demagogue in order the better to reach its ends, as in philosophy it is by scepticism that it undertakes to restore theocracy. On the other hand, he who combated any exclusive principle in science was bound to reject also any exclusive principle in the state, and to defend representative government."

The Government was not tardy in honoring his public services as a professor and his contributions to the philosophical literature of the country. He was induced by the ministry of which his friend Guizot was the head to take a part in national administration. He ceased to lecture, but retained the title of professor of philosophy. He became a member of the council of public instruction and councillor of state, and in 1832 he was made a peer of France. Finally, he accepted the position of minister of public instruction in 1840 under Thiers. He was besides director of the Normal School and virtual head of the university, and from 1840 a member of the Institute (Academy of the Moral and Political Sciences). His character and his official position at this period gave him great power in the university and in the educational arrangements of the country. In fact, during the seventeen and a half years of the reign of Louis Philippe, Cousin mainly moulded the philosophical and even the literary tendencies of the cultivated class in France.

But the most important work he accomplished during this period was doubtless the organization of primary instruction in the country. It was to the efforts of Cousin that France owed her advance, in primary education, from 1830 to 1848. Prussia and Saxony had set the national example, and France was guided into it by Cousin. Forgetful, as has been well said, of "national calamity and of personal wrong," he looked to Prussia as affording the best example of an organized system of national education; and he was persuaded that "to carry back the education of Prussia into France afforded a nobler (if a bloodless) triumph than the trophies of Austerlitz and Jena." In the summer of 1831, commissioned by the Government, he proceeded to Germany, visiting Frankfort and Saxony, and spending some time in Berlin. The result was a series of reports to the minister, afterwards published as *Rapport sur l'Etat de l'Instruction Publique dans quelques pays de l'Allemagne et particulièrement en Prusse*. (Compare also *De l'Instruction Publique en Hollande*, 1837.) His views were readily accepted on his return to France, and soon afterwards through his influence there was passed the law of primary instruction. (See his *Exposé des Motifs et Projet de Loi sur l'Instruction Primaire, présentés à la Chambre des Députés, Séance du 2 Janvier, 1833*.)

In the words of a reviewer at the time (*Edinburgh Review*, July, 1833), these documents "mark an epoch in the progress of national education, and are directly con-

Disciples  
and  
followers.

Relation to  
primary  
education  
in France.

ducive to results important not only to France but to Europe." The *Report* was translated by Mrs. Austin in 1834. The translation was frequently reprinted in the United States of America. The legislatures of New Jersey and Massachusetts distributed it in the schools at the expense of the States. Cousin remarks that, among all the literary distinctions which he had received, "None has touched me more than the title of foreign member of the American Institute for Education." To the enlightened views of the ministries of Guizot and Thiers under the citizen-king, and to the zeal, energy, and ability of Cousin in the work of organization, France owes what is best in her system of primary education,—a national interest which had been neglected under the Revolution, the Empire, and the Restoration (see *Exposé*, p. 17). In the first two years of the reign of Louis Philippe more was done for the education of the people than had been either sought or accomplished in all the history of France. France since then has, perhaps, owing to political troubles and ecclesiastical obstacles, followed but falteringly in the steps of Prussia; but some considerable progress has been made on the lines laid down by Cousin in a spirit of far-seeing patriotism. If, in 1866, about 30 per cent. of the military conscripts were unable to read, yet we must put alongside of this the fact that, while in 1824, the year of the accession of Charles X., out of the 44,000 communes of France 25,000 were without schools, in that same year of 1866 there were 41,000 free and public schools for boys, and 14,000 for girls. In connection with his services to education we ought not to omit a notice of his noble and eloquent defence of university studies in the Chamber of Peers in 1844, when he stood manfully forth against the clerical party on the one hand, and the levelling or Philistine party on the other. His speeches on this occasion were afterwards published in a most interesting tractate entitled *Défense de l'Université et de la Philosophie*.

This period of official life from 1830 to 1848 was spent by him, so far as philosophical study was concerned, in revising his former lectures and writings, in maturing them for publication or re-issue, and in research into certain periods of the history of philosophy. In 1835 appeared *De la Métaphysique de Aristote, suivi d'un Essai de traduction des deux premiers livres*; in 1836, *Cours de Philosophie professé à la faculté des lettres pendant l'année 1818, and Œuvres inédits d'Abélard*. This *Cours de Philosophie* appeared later in 1854 as *Du Vrai, du Beau, et du Bien*. From 1825 to 1840 appeared *Cours de l'Histoire de la Philosophie*; in 1839 *Manuel de l'Histoire de la Philosophie de Tennemann*, translated from the German. In 1840-41 we have *Cours d'Histoire de la Philosophie Morale au XVIII<sup>e</sup> Siècle* (5 vols.). In 1841 appeared his edition of the *Œuvres Philosophiques de Maine-de-Biran*; in 1842, *Leçons de Philosophie sur Kant*, and in the same year *Des Pensées de Pascal*. The *Nouveaux Fragments* were gathered together and republished in 1847. Later, in 1859, appeared *Petri Abelardi Opera*.

During this period also he seems to have turned with fresh interest to those literary studies which in his youth he had abandoned for speculation under the influence of Laromiguière and Royer-Colard. To this renewed interest we owe his studies of men and women of note in France in the 17th century. This was an epoch of the national history whose spiritualism, alike in philosophy and religion, had a special attraction for him. He turned to it with increasing regard in his latter years, as best representing his own personal convictions and feelings. As the results of his work in this line, we have, besides the *Des Pensées de Pascal*, 1842, already noticed, *Études sur les Femmes et la Société du XVII<sup>e</sup> Siècle*, 1853. He has sketched Jacqueline Pascal, Madame de Longueville, Madame de Sablé, Madame de Chevreuse, Madame de Hautefort. There is as yet no complete edition of his numerous works, which is a great desideratum.

When the reign of Louis Philippe came to a close through the opposition of his ministry, with Guizot at its head, to the demand for electoral reform and through the disgraceful policy of the Spanish marriages, Cousin, who was opposed to the Government on these points, lent his sympathy to Cavaignac and the Provisional Government. He published a pamphlet entitled *Justice et Charité*, the purport of which showed the moderation of his political views. It was markedly anti-socialistic. But from this period he passed almost entirely from public life, and ceased to wield

the personal influence which he had done during the preceding years. After the *coup d'état* of the 2d December, he was deprived of his position as permanent member of the superior council of public instruction. From Napoleon and the empire he stood essentially aloof. A decree of 1852 placed him along with Guizot and Villemain in the rank of honorary professors. His sympathies were apparently with the monarchy, under certain constitutional safeguards. Speaking in 1853 of the political issues of the spiritual philosophy which he had taught during his lifetime, he says,—“It conducts human societies to the true republic, that dream of all generous souls, which in our time can be realized in Europe only by constitutional monarchy.”<sup>1</sup>

During the last years of his life, he occupied a suite of rooms in the Sorbonne, where he lived very simply and unostentatiously. The chief feature of the rooms was the noble library, the cherished collection of a lifetime, which was spread over the walls of each apartment. Besides Latin and Greek classics, representing the studies of his youth, it was rich in philosophical literature, especially historical. The compartments for Italian and English literature and philosophy were especially full and interesting; and the whole was so carefully and methodically arranged that its learned possessor could quite readily lay his hand on any volume of his treasures. The present writer may perhaps be pardoned for saying that he well recollects a forenoon spent with him in these rooms, some twelve years ago. The kindness of his manner, the richness of his talk, his wonderful acquaintance with British literature, politics, and philosophy, the massive head with hair slightly turned to grey, and the kindling dark brown eyes, are elements in the picture of a very pleasant memory.

M. Cousin died at Cannes on the 13th January, 1867, in his seventy-fifth year. In the front of the Sorbonne, below the lecture-rooms of the faculty of letters, is a tablet recording an extract from the will of Victor Cousin, in which he appropriately bequeaths his noble and cherished library to the halls of his professional work and triumphs.

There are three distinctive points in the philosophy of M. Cousin. These are his method, the results of his method, and the application of the method and its results to history,—especially to the history of philosophy. It is usual to speak of his philosophy as eclectic. It is eclectic only in a secondary and subordinate sense. All eclecticism that is not self-condemned and inoperative implies a system of doctrine as its basis,—in fact, a criterion of truth. Otherwise, as Cousin himself remarks, it is simply a blind and useless syncretism. And Cousin saw and proclaimed from an early period in his philosophical teaching the necessity of a system on which to base his eclecticism. This is indeed advanced as an illustration or confirmation of the truth of his system,—as a proof that the facts of history correspond to his analysis of consciousness. These three points—the method, the results, and the philosophy of history—are with him intimately connected; they are developments in a natural order of sequence. They become in practice Psychology, Ontology, and Eclecticism in history.

First, as to method. On no point has Cousin more strongly and frequently insisted than the importance of the method which philosophy may adopt. That which he adopts, and the necessity of which he so strongly proclaims, is the ordinary one of observation, analysis, and induction. This may seem commonplace enough, but it is really not so; it makes all the difference in the world as to the character of a philosophy whether we follow the reflective analysis of experience, or a deductive method of the construction of notions. The observational method Cousin regards as that of the 18th century,—the method which Descartes began and abandoned, and which Locke and Condillac applied, but applied imperfectly, and which Reid and Kant used with more success, yet not completely. He insists that this is the true method of philosophy as applied to consciousness, in which alone the facts of experience appear. But the proper condition of the application of the method is that it shall not through prejudice of system omit a single fact of consciousness. If the authority of consciousness is good in one instance, it is good in all. If not to be trusted in good, it is not to be trusted in

<sup>1</sup> *Du Vrai, Du Beau, Du Bien*.—Preface.

any. Previous systems have erred in not presenting the facts of consciousness, i.e., consciousness itself, in their totality. The observational method applied to consciousness gives us the science of psychology. This is the basis and the only proper basis of ontology or metaphysics—the science of being—and of the philosophy of history. To the observation of consciousness Cousin adds induction as the complement of his method, by which he means inference as to reality necessitated by the data of consciousness, and regulated by certain laws found in consciousness, viz., those of the reason. By his method of observation and induction as thus explained, his philosophy will be found to be marked off very clearly, on the one hand from the deductive construction of notions of an absolute system, as represented either by Schelling or Hegel, which Cousin regards as based simply on hypothesis and abstraction, illegitimately obtained; and on the other, from that of Kant, and in a sense, of Hamilton, both of which in the view of Cousin are limited to psychology, and merely relative or phenomenal knowledge, and issue in scepticism so far as the great realities of ontology are concerned. What Cousin finds psychologically in the individual consciousness, he finds also spontaneously expressed in the common sense or universal experience of humanity. In fact, it is with him the function of philosophy to classify and explain universal convictions and beliefs; but common sense is not with him philosophy, nor is it the instrument of philosophy; it is simply the material on which the philosophical method works, and in harmony with which its results must ultimately be found.

**Results.** The three great results of psychological observation are Sensibility, Activity or Liberty, and Reason.

These three facts are different in character, but are not found apart in consciousness. Sensations, or the facts of the sensibility, are necessary; we do not impute them to ourselves. The facts of reason are also necessary, and reason is not less independent of the will than the sensibility. Voluntary facts are alone marked in the eyes of consciousness with the characters of imputability and personality. The will alone is the person or *Me*. The *me* is the centre of the intellectual sphere without which consciousness is impossible. We find ourselves in a strange world, between two orders of phenomena which do not belong to us, which we apprehend only on the condition of our distinguishing ourselves from them. Further, we apprehend by means of a light which does not come from ourselves. All light comes from the reason, and it is the reason which apprehends both itself, and the sensibility which envelops it and the will which it obliges but does not constrain. Consciousness then is composed of these three integrant and inseparable elements. But Reason is the immediate ground of knowledge, and of consciousness itself.

**Spontaneity in will.**

But there is a peculiarity in M. Cousin's doctrine of activity or freedom, and in his doctrine of reason, which enters deeply into his system. This is the element of spontaneity in volition and in reason. This is the heart of what is new alike in his doctrine of knowledge and being. Liberty or freedom is a generic term which means a cause or being endowed with self-activity. This is to itself and its own development its own ultimate cause. Free-will is so, although it is preceded by deliberation and determination, i.e., reflection, for we are always conscious that even after determination we are free to will or not to will. But there is a primary kind of volition, which has not reflection for its condition, which is yet free and spontaneous. We must have willed thus spontaneously first, otherwise we could not know, before our reflective volition, that we could will and act. Spontaneous volition is free as reflective, but it is the primary act of the two. This view of liberty of will is the only one in accordance with the facts of humanity; it excludes reflective volition, and explains the enthusiasm of the poet and the artist in the act of creation; it explains also the ordinary actions of mankind, which are done as a rule spontaneously and not after reflective deliberation.

**Impersonality of reason.**

But it is in his doctrine of the Reason that the distinctive principle of the philosophy of Cousin lies. The reason given to us by psychological observation, the reason of our consciousness, is impersonal in its nature. We do not make it; its character is precisely the opposite of individuality; it is

universal and necessary. The recognition of universal and necessary principles in knowledge is the essential point in psychology; it ought to be put first and emphasized to the last that these exist, and that they are wholly impersonal or absolute. The number of these principles, their enumeration and classification, is an important point, but it is secondary to that of the recognition of their true nature. This was the point which Kant missed in his analysis, and this is the fundamental truth which Cousin thinks he has restored to the integrity of philosophy by the method of the observation of consciousness. And how is this impersonality or absoluteness of the conditions of knowledge sought to be established? The answer is in substance that Kant went wrong in putting necessity first as the criterion of those laws. This brought them within the sphere of reflection, and gave as their guarantee the impossibility of thinking them reversed; and led to their being regarded as wholly relative to human intelligence, restricted to the sphere of the phenomenal, incapable of revealing to us substantial reality—necessary, yet subjective. But this test of necessity is a wholly secondary one; these laws are not thus guaranteed to us; they are each and all given to us, given to our consciousness, in an act of spontaneous apperception or apprehension, immediately, instantaneously, in a sphere above the reflective consciousness, yet within the reach of knowledge. And "all subjectivity with all reflection expires in the spontaneity of apperception. The reason becomes subjective by relation to the voluntary and free self; but in itself it is impersonal; it belongs not to this or to that self in humanity; it belongs not even to humanity. We may say with truth that nature and humanity belong to it, for without its laws both would perish."

But what is the number of those laws? Kant reviewing the enterprise of Aristotle in modern times has given a complete list of the laws of thought, but it is arbitrary in classification, and may be legitimately reduced. According to Cousin, there are but two primary laws of thought, that of causality and that of substance. From these flow naturally all the others. In the order of nature, that of substance is the first and causality second. In the order of acquisition of our knowledge, causality precedes substance, or rather both are given us in each other, and are contemporaneous in consciousness.

These principles of reason, cause and substance, given thus psychologically, enable us to pass beyond the limits of the relative and subjective to objective and absolute reality,—enable us, in a word, to pass from psychology, or the science of knowledge, to ontology, or the science of being. These laws are inextricably mixed in consciousness with the data of volition and sensation, with free activity and fatal action or impression, and they guide us in rising to a personal being, a self or free cause, and to an impersonal reality, a not-me—nature, the world of force—lying out of us, and modifying us. As I refer to myself the act of attention and volition, so I cannot but refer the sensation to some cause, necessarily other than myself, that is, to an external cause, whose existence is as certain for me as my own existence, since the phenomenon which suggests it to me is as certain as the phenomenon which had suggested my reality, and both are given in each other. I thus reach an objective impersonal world of forces which corresponds to the variety of my sensations. The relation of these forces or causes to each other is the order of the universe.

But these two forces, the *me* and the not-me, are reciprocally limitative. As reason has apprehended these two simultaneous phenomena, attention and sensation, and led us immediately to conceive the two sorts of distinct causes, correlative and reciprocally finite, to which they are related, so, from the notion of this limitation, we find it impossible under the same guide not to conceive a supreme cause, absolute and infinite, itself the first and last cause of all. This is relatively to self and not-self what these are to their proper effects. This cause is self-sufficient, and is sufficient for the reason. This is God; he must be conceived under the notion of cause, related to humanity and the world. He is absolute substance only in so far as he is absolute cause, and his essence lies precisely in his creative power. He thus creates, and he creates necessarily.

This theodicy of Cousin laid him open obviously enough to the charge of pantheism. This he repels, and his an-

**Laws of reason.**

**The infinite or absolute.**

Charge of pantheism. answer may be summed up as follows. Pantheism is properly the deification of the law of phenomena, the universe God. But I distinguish the two finite causes self and not-self from each other and from the infinite cause. They are not mere modifications of this cause or properties, as with Spinoza,—they are free forces having their power or spring of action in themselves, and this is sufficient for our idea of independent finite reality. I hold this, and I hold the relation of these as effects to the one supreme cause. The God I plead for is neither the deity of Pantheism, nor the absolute unity of the Eleatics, a being divorced from all possibility of creation or plurality, a mere metaphysical abstraction. The deity I maintain is creative, and necessarily creative. The deity of Spinoza and the Eleatics is a mere substance, not a cause in any sense. As to the necessity under which Deity exists of acting or creating, this is the highest form of liberty, it is the freedom of spontaneity, activity without deliberation. His action is not the result of a struggle between passion and virtue. He is free in an unlimited manner, the purest spontaneity in man is but the shadow of the freedom of God. He acts freely but not arbitrarily, and with the consciousness of being able to choose the opposite part. He cannot deliberate or will as we do. His spontaneous action excludes at once the efforts and the miseries of will and the mechanical operation of necessity.

History of philosophy. The elements found in consciousness are also to be found in the history of humanity and in the history of philosophy. In external nature there are expansion and contraction which correspond to spontaneity and reflection. External nature again in contrast with humanity expresses spontaneity; humanity expresses reflection. In human history the East represents the spontaneous stage; the Pagan and Christian world represent stages of reflection.

This was afterwards modified, expanded, and more fully expressed by saying that humanity in its universal development has three principal moments. First, in the spontaneous stage, where reflection is not yet developed, and art is imperfect, humanity has thought only of the immensity around it. It is preoccupied by the infinite. Secondly, in the reflective stage, mind has become an object to itself. It thus knows itself explicitly or reflectively. Its own individuality is now the only or at least the supreme thing. This is the moment of the finite. Thirdly, there comes an epoch in which the self or me is subordinated. Mind realizes another power in the universe. The finite and the infinite become two real correlatives in the relation of cause and product. This is the third and highest stage of development, the relation of the finite and the infinite. As philosophy is but the highest expression of humanity, these three moments will be represented in its history. The East typifies the infinite, Greece the finite or reflective epoch, the modern era the stage of relation or correlation of infinite and finite. In theology, the dominant philosophical idea of each of these epochs results in pantheism, polytheism, theism. In politics we have in correspondence also with the idea, monarchy, democracy, constitutionalism.

Eclecticism. Eclecticism thus means the application of the psychological method to the history of philosophy. Confronting the various systems co-ordinated as sensualism, idealism, scepticism, mysticism, with the facts of consciousness, the result was reached "that each system expresses an order of phenomena and ideas, which is in truth very real, but which is not alone in consciousness, and which at the same time holds an almost exclusive place in the system; whence it follows that each system is not false but incomplete, and that in reuniting all incomplete systems, we should have a complete philosophy, adequate to the totality of consciousness." Philosophy, as thus perfected, would not be a mere aggregation of systems, as is ignorantly supposed, but an integration of the truth in each system after the false or incomplete is discarded.

Relations to Kant, Schelling, and Hegel. Such is the system in outline. The historical position of the system lies in its relations to Kant, Schelling, and Hegel. Cousin was opposed to Kant in asserting that the unconditional in the form of infinite or absolute cause was but a mere unrealizable tentative or effort on the part of the mind, something different from a mere negation, yet

not equivalent to a positive thought. With Cousin the absolute as the ground of being is grasped positively by the intelligence, and it renders all else intelligible; it is not as with Kant a certain hypothetical or regulative need.

With Schelling again Cousin agrees in regarding this supreme ground of all as positively apprehended, and as a source of development, but he utterly repudiates Schelling's method. The intellectual intuition either falls under the eye of consciousness, or it does not. If not, how do you know it and its object which are identical? If it does, it comes within the sphere of psychology; and the objections to it as thus a relative, made by Schelling himself, are to be dealt with. Schelling's intellectual intuition is the mere negation of knowledge.

Again, the pure being of Hegel is a mere abstraction,—an hypothesis illegitimately assumed, which he has nowhere sought to vindicate. The very point to be established is the possibility of reaching being *per se* or pure being; yet in the Hegelian system this is the very thing assumed as a starting-point. Besides this, of course, objections might be made to the method of development, as not only subverting the principle of contradiction, but as galvanizing negation into a means of advancing or developing the whole body of human knowledge and reality. The intellectual intuition of Schelling, as above consciousness, the pure being of Hegel, as an empty abstraction, unvindicated, illegitimately assumed, and arbitrarily developed, are equally useless as bases of metaphysics. This led Cousin, still holding by essential knowledge of being, to ground it in an analysis of consciousness,—in psychology.

The absolute or infinite—the unconditional ground and source of all reality—is yet apprehended by us as an immediate datum or reality; and it is apprehended in consciousness,—under its condition, that, to wit, of distinguishing subject and object, knower and known. The doctrine of Cousin was, as is well known, criticised by Sir W. Hamilton in the *Edinburgh Review* of 1829, and it was animadverted upon about the same time by Schelling. The latter Cousin calls the greatest thinker, and the former the greatest critic, of the age. Hamilton's objections are as follows. The correlation of the ideas of infinite and finite does not necessarily imply their correality, as Cousin supposes; on the contrary, it is a presumption that finite is simply positive and infinite negative of the same,—that the finite and infinite are simply contradictory relatives. Of these "the positive alone is real, the negative is only an abstraction of the other, and in the highest generality even an abstraction of thought itself." A study of the few sentences under this head might have obviated the trifling criticisms of Hamilton's objection which has been set afloat recently, that the denial of a knowledge of the absolute or infinite implies a foregone knowledge of it. How can you deny the reality of that which you do not know? The answer to this is that in the case of contradictory statements,—A and not A,—the latter is not a mere negation of the former, and posits nothing; and the negation of a notion with positive attributes, as the finite, does not extend beyond abolishing the given attributes as an object of thought. The infinite or non-finite is not necessarily known, ere the finite is negated, or in order to negate it; all that needs be known is the finite itself; and the contradictory negation of it implies no positive. Non-organized may or may not correspond to a positive,—i. e., an object or notion with qualities contradictory of the organized; but the mere sublation of the organized does not posit it, or suppose that it is known beforehand, or that anything exists corresponding to it. This is one among many flaws in the Hegelian dialectic, and it paralyzes the whole of the *Logic*. Secondly, The conditions of intelligence, which Cousin allows, necessarily exclude the possibility of knowledge of the absolute,—they are held to be incompatible with its unity. Here Schelling and Hamilton argue that Cousin's absolute is a mere relative. Thirdly It is objected that in order to deduce the conditioned, Cousin makes his absolute a relative; for he makes it an absolute cause, i. e., a cause existing absolutely under relation. As such it is necessarily inferior to the sum total of its effects, and dependent for reality on these—in a word, a mere potency or becoming. Further, as a theory of creation, it makes creation a necessity, and destroys the notion of the divine. Cousin made no reply to Hamilton's criticism beyond alleging that Hamilton's doctrine necessarily restricted human know-

Hamilton's criticisms.

ledge and certainty to psychology and logic, and destroyed metaphysics by introducing nescience and uncertainty into its highest sphere,—theodicy.

**Criticism of his philosophy.** The attempt to render the laws of reason thought impersonal by professing to find them in the sphere of spontaneous apperception, and above reflective necessity, can hardly be regarded as successful. It may be that we first of all primitively or spontaneously affirm cause, substance, time, space, etc., in this way. But these are still in each instance given us as realized in a particular form. In no single act of affirmation of cause or substance, much less in such a primitive act, do we affirm the universality of their application. We might thus get particular instances or cases of these laws, but we could never get the laws themselves in their universality, far less absolute impersonality. And as they are not supposed to be mere generalizations from experience, no amount of individual instances of the application of any one of them by us would give it a true universality. The only sure test we have of their universality in our experience is the test of their reflective necessity. We thus after all fall back on reflection as our ground for their universal application; mere spontaneity of apprehension is futile; their universality is grounded in their necessity, not their necessity in their universality. How far and in what sense this ground of necessity renders them personal are of course questions still to be solved.

But if these three correlative facts are immediately given, it seems to be thought possible by Cousin to vindicate them in reflective consciousness. He seeks to trace the steps which the reason has spontaneously and consciously, but irreflectively, followed. And here the question arises—Can we vindicate in a reflective or mediate process this spontaneous apprehension of reality?

The self is found to be a cause or force, free in its action, on the ground that we are obliged to relate the volition of consciousness to the self as its cause, and its ultimate cause. It is not clear from the analysis whether the self is immediately observed as an acting or originating cause, or whether reflection working on the principle of causality is compelled to infer its existence and character. If self is actually so given, we do not need the principle of causality to infer it; if it is not so given, causality could never give us either the notion or the fact of self as a cause or force, far less as an ultimate one. All that it could do would be to warrant a cause of some sort, but not this or that reality as the cause. And further, the principle of causality, if fairly carried out, as universal and necessary, would not allow us to stop at personality or will as the ultimate cause of its effect,—volition. Once applied to the facts at all, it would drive us beyond the first antecedent or term of antecedents of volition to a still further cause or ground,—in fact, land us in an infinite regress of causes.

The same criticism is even more emphatically applicable to the influence of a not-self, or world of forces, corresponding to our sensations, and the cause of them. Starting from sensation as our basis, causality could never give us this, even though it be allowed that sensation is impersonal to the extent of being independent of our volition. Causality might tell us that a cause there is of sensation somewhere and of some sort; but that this cause is a force or sum of forces, existing in space, independently of us, and corresponding to our sensations, it could never tell us, for the simple reason that such a notion is not supposed to exist in our consciousness. Causality cannot add to the number of our notions,—cannot add to the number of realities we know. All it can do is to necessitate us to think that a cause there is of a given change, but *what* that cause is it cannot of itself inform us, or even suggest to us, beyond implying that it must be adequate to the effect. Sensation might arise, for aught we know, so far as causality leads us, not from a world of forces at all, but from a will like our own, though infinitely more powerful, acting upon us, partly furthering and partly thwarting us. And indeed such a supposition is, with the principle of causality at work, within the limits of probability, as we are already supposed to know such a reality,—a will—in our own consciousness. When Cousin thus set himself to vindicate those points by reflection, he gave up the obvious advantage of his other position that the realities in question are given us in immediate and spontaneous

apprehension. The same criticism applies equally to the inference of an absolute cause from the two limited forces which he names self and not-self. Immediate spontaneous apperception may seize this supreme reality; but to vindicate it by reflection as an inference on the principle of causality is impossible. This is a mere paralogism; we can never infer either absolute or infinite from relative or finite.

The truth is that M. Cousin's doctrine of the spontaneous apperception of impersonal truth amounts to little more than a presentment in philosophical language of the ordinary convictions and beliefs of mankind. This is important as a preliminary stage, but philosophy properly begins when it attempts to co-ordinate or systematize these convictions in harmony, to conciliate apparent contradiction and opposition, as between the correlative notions of finite and infinite, the apparently conflicting notions of personality and infinitude, self and not-self; in a word, to reconcile the various sides of consciousness with each other. And whether the laws of our reason are the laws of all intelligence and being,—whether and how we are to relate our fundamental, intellectual, and moral conceptions to what is beyond our experience, or to an infinite being,—are problems which Cousin cannot be regarded as having solved. These are in truth the outstanding problems of modern philosophy.

Cousin's doctrine of spontaneity in volition can hardly be said to be more successful than **Volition.** his impersonality of the reason through spontaneous apperception. Sudden, unpremeditated volition may be the earliest and the most artistic, but it is not the best. Volition is essentially a free choice between alternatives, and that is best which is most deliberate, because it is most rational. Aristotle long ago touched this point in his distinction between *βούλησις* and *προαιρέσις*. The sudden and unpremeditated wish represented by the former is wholly inferior in character to the free choice of the latter, guided and illumined by intelligence. In this we can deliberately resolve upon what is in our power; in that we are subject to the vain impulse of wishing the impossible. Spontaneity is pleasing, sometimes beautiful, but it is not in this instance the highest quality of the thing to be obtained. That is to be found in a guiding and illumining reflective activity.

Eclecticism is not open to the superficial objection of proceeding without a system or test in determining the complete or incomplete. **General estimate.** But it is open to the objection of assuming that a particular analysis of consciousness has reached all the possible elements in humanity and in history, and all their combinations. It may be asked, Can history have that which is not in the individual consciousness? In a sense not; but our analysis may not give all that is there, and we ought not at once to impose that analysis or any formula on history. History is as likely to reveal to us in the first place true and original elements, and combinations of elements in man, as a study of consciousness. Besides, the tendency of applying a formula of this sort to history is to assume that the elements are developed in a certain regular or necessary order, whereas this may not at all be the case; but we may find at any epoch the whole mixed, either crossing or co-operative, as in the consciousness of the individual himself. Further, the question as to how these elements may possibly have grown up in the general consciousness of mankind is assumed to be non-existent or impossible.

It was the tendency of the philosophy of Cousin to outline things and to fill up the details in an artistic and imaginative interest. This is necessarily the case, especially in the application to history of all formulas supposed to be derived either from an analysis of consciousness, or from an abstraction called pure thought. Cousin was observational and generalizing rather than analytic and discriminating. His search into principles was not profound, and his power of rigorous consecutive development was not remarkable. These qualities are essential to the formation of a lasting body of philosophic knowledge. He has left no distinctive principle of philosophy which is likely to be permanent. But he has left very interesting psychological analyses, and several new, just, and true expositions of philosophical systems, especially that of Locke and the philosophers of Scotland. He was at the same time a man of impressive power, of rare and wide culture, and of lofty aim,—far above priestly conception and Philistine narrowness. He was familiar with the broad lines of

nearly every system of philosophy ancient and modern. His eclecticism was the proof of a reverential sympathy with the struggles of human thought to attain to certainty in the highest problems of speculation. It was eminently a doctrine of comprehension and of toleration. In these respects it formed a marked and valuable contrast to the arrogance of absolutism, which really means a supreme egoism, to the narrow dogmatism of sensationalism, and to the not less narrow doctrine of church authority, preached by the theological school of his day. His spirit, while it influenced the youth of France, saved them from the effects of all these lowering influences. As an earnest educational reformer, as a man of letters and learning, who trode "the large and impartial ways of knowledge," and who swayed others to the same paths, as a thinker influential alike in the action and the reaction to which he led,—in some cases the petulant detraction which may pass as a tribute to power,—Cousin stands out conspicuously among the memorable Frenchmen of the 19th century.

We might be inclined to modify the strength of some of the following expressions, but we cannot help feeling that they are in the main true:—"A profound and original thinker, a lucid and eloquent writer, a scholar equally at home in ancient and in modern learning, a philosopher superior to all prejudices of age or country, party or profession, and whose lofty eclecticism, seeking truth under every form of opinion, traces its unity even through the most hostile systems." Such was the estimate of Victor Cousin by the acutest critic and most resolute opponent of his philosophy in this century.<sup>1</sup> (J. V.)

**COUSTOU**, the name of a famous family of French sculptors. Nicholas Coustou (1658-1733) was the son of a wood-carver at Lyons, where he was born. At eighteen he removed to Paris, to study under Coysevox, his uncle, who presided over the recently-established Academy of Painting and Sculpture; and at three-and-twenty he gained the Colbert prize which entitled him to four years education at the French Academy at Rome. He afterwards became rector and chancellor of the Academy of Painting and Sculpture. He was remarkable for his facility; and though he was specially influenced by Michelangelo and Algardi, his numerous works are among the most typical specimens of his age now extant. The most famous are the Union of the Seine and Marne and the Berger Chasseur in the gardens of the Tuileries, and the Descent from the Cross placed behind the choir altar of Notre Dame; he also supplied a large number of statues to Versailles and Marly.

His younger brother, Guillaume Coustou (1678-1746), was a sculptor of still greater merit. He also gained the Colbert prize; but refusing to submit to the rules of the Academy, he soon left it, and for some time wandered houseless through the streets of Rome. At length he was befriended by the sculptor Legros, under whom he studied for some time. Returning to Paris, he was in 1704 admitted into the Academy of Painting and Sculpture, of which he afterwards became director; and, like his brother, he was employed by Louis XIV. His finest works are the famous group of the Horse Tamers in the Champs Elysées at Paris, the Ocean and Mediterranean at Marly, the bronze Rhône which formed part of the statue of Louis XIV. at Lyons, the façade of the Château d'Eau, and the bas-reliefs of the entrance of the Hôtel des Invalides. His work is specially distinguished by its fire and energy.

Guillaume Coustou, the younger (1716-1777), the son of Nicholas, also studied at Rome, as winner of the Colbert prize. While to a great extent a copyist of his predecessors, he was much affected by the bad taste of his time, and produced little or nothing of permanent value.

**COUTANCES**, a town of France, capital of an arrondissement of the department of La Manche, and the seat of a bishop, is built on a granite ridge which rises between the canalized River Souille and the stream called the Buisard, 16 miles W. S. W. of St. Lô and 7 miles from the sea. From the hill, up the sides of which the crooked streets of the town are built, a fine panorama of the surrounding country is obtained. The cathedral of Notre Dame on the height, with two lofty towers terminating in spires, was inaugurated by William the Conqueror in 1056, and is one of the finest specimens of ecclesiastical architecture in Normandy. The churches of St. Nicolas and St. Pierre, dating from the 14th and 15th centuries, are

<sup>1</sup> Sir W. Hamilton, *Discussions*, p. 541.

also fine. The palais de justice, lycée, episcopal palace, and halle aux grains are among the chief buildings. Some manufactures of woollen and cotton goods, marble working, and traffic in corn, poultry, cattle, and horses are the industries of the town. Coutances is the ancient Roman Cosedia in the country of the Unelli. Towards the end of the 3d century its name was changed to Constantia. Many traces of Roman work are still to be seen in its environs. An aqueduct, between the town and a hill on the east, was constructed about the middle of the 13th century on the site of one which was built by the Romans; originally it had sixteen arches, but eleven of these are now ruined. In the Middle Ages Coutances was capital of the vice-county of Coutentin, or Cotentin, a district noted for its breed of cattle. It was held by the English from 1417 to 1449. Population (1872), 14,557.

**COUTHON**, GEORGES (1756-1794), one of the most notorious actors in the Reign of Terror, was born at Orsay (Orcet), a village in the district of Clermont in Auvergne, in 1756. He studied law, and was admitted advocate at Clermont in 1785. At this period he was noted for his integrity, gentle-heartedness, and charitable disposition. His health was feeble, and his body was half paralyzed from a recent misadventure. In 1787 he was a member of the provincial assembly of Auvergne. When the Revolution began Couthon avowed the most liberal sentiments, but at the same time spoke with great moderation. He became very popular, and was appointed chief magistrate of Clermont and president of the tribunal of the town. With the progress of events, however, his feelings rose to a higher pitch, and his sympathies were with the van of the Revolutionary army. In 1791 he was elected deputy to the legislative assembly, and here he soon took his place among the most violent of the Jacobins. He advocated extreme measures against the king. A visit to Flanders for the sake of health brought him into close intercourse and sympathy with Dumouriez. In September, 1792, Couthon was elected member of the National Convention, and voted the death of the king without appeal. He soon attached himself to Robespierre, for whom at first he felt only aversion, and he was the first to demand the arrest of the proscribed Girondins. In July, 1793, he became a member of the Committee of Public Safety, and in the following month he was sent as commissioner of the army to conduct the siege of Lyons. Impatient at the slow progress made by the besieging forces, he collected a body of 60,000 men, and having stormed the place, resolved on its destruction. He made a beginning with a kind of state ceremonial. Carried on a litter, with a silver hammer in his hand, he struck the doors or walls of the houses doomed to be demolished, and his army of satellites then executed his orders. The demolition was carried on for six months, and the cost of it was enormous. Couthon's rage, however, chiefly vented itself on the buildings; the slaughter of the inhabitants was the work of his successor Collot d'Herbois. Couthon returned to Paris, where Robespierre felt the need of his assistance. He was one of the promoters of the infamous law of the 22d Prairial, which shortened the proceedings before the Revolutionary Tribunal by depriving the accused of the aid of counsel or of witnesses for their defence. This was not long before the 9th Thermidor. Couthon had become one of the Triumvirate, with Robespierre and St. Just, and alarmed at the opposition which was rising against their power and projects, declined to make the visit which he had promised to Auvergne. He was arrested at the same time with his colleagues, and after being subjected to indescribable sufferings and insults, was taken on the same car with his master to the scaffold. There, amidst the exultations and execrations of the fierce crowd, he wept with terror, and died by the guillotine (9th Thermidor) July 28, 1794.

**COUTTS**, THOMAS, an eminent banker, head of the London house of Coutts & Co., was born probably about 1731. He was the fourth son of John Coutts, who carried on business at Edinburgh as a corn factor and negotiator of bills of exchange, and who in 1742 was elected lord provost of the city. The family was originally of Montrose, but one of its members had settled at Edinburgh about or before 1696. Soon after the death of John Coutts, the ex-provost, the business was divided into two branches, one carried on at Edinburgh, the other in London. The London branch was in the hands of Patrick and Thomas Coutts, the eldest and the youngest sons of John Coutts.

From the death of his brother in 1788, Thomas, as surviving partner, became sole head of the firm, and under his direction the banking-house rose to the highest distinction. His ambition was to establish his character as a man of business and to make a fortune, and he lived to succeed in this aim and long to enjoy his reputation and wealth. A gentleman in manners, hospitable, and benevolent, he counted amongst his friends some of the literary men and the best actors of the day. Of the enormous wealth which came into his hands he made munificent use. His private life was not without its romantic elements. Soon after his settlement in London he married Elizabeth Starkey, a young woman of humble origin, who was in attendance on the daughter of his brother James. They lived happily together, and had three daughters,—Susan, married in 1796 to the third earl of Guilford; Frances, married in 1800 to the first marquis of Bute; and Sophia, married in 1738 to Sir Francis Burdett, Baronet. Mrs. Coufts dying in 1815, her husband soon after married the popular actress Harriet Mellon, and to her he left the whole of his immense fortune. He died in London February 24, 1822. His widow married in 1827 the duke of St. Albans, and died ten years later, having bequeathed her property to Angela, youngest daughter of Sir Francis Burdett, who then assumed the additional name and arms of Coufts. She was created Baroness Burdett-Coufts in 1871.<sup>1</sup>

COVENANTERS, in Scottish history, the name applied to a party, embracing the great majority of the people, who during the 17th century bound themselves to establish and maintain the Presbyterian doctrine and polity as the sole religion of the country, to the exclusion of Prelacy and Popery. An account of the covenanting cause as a religious and political movement belongs to the history of Scotland. There were several successive Covenants, similar in spirit and expression, the most important historically being the National Covenant of 1638 and the Solemn League and Covenant of 1643. These were both based upon earlier documents. In 1581 the General Assembly of Scotland adopted a confession of faith, or national covenant, drawn up by John Craig, condemning Episcopal government, under the name of hierarchy. This covenant was signed by James I. and enjoined on all his subjects. It was again subscribed in 1590 and 1596. The subscription was renewed in 1638, and the subscribers engaged by oath to maintain religion in the same state in which it existed in 1580, and to reject all innovations introduced since that time. This oath annexed to the confession of faith of 1581 received the name of the National Covenant. The additional matter was prepared by Johnston of Warriston and Alexander Henderson, and was intended to suit the document to the special circumstances of the time. It was adopted and signed by a large gathering in Greyfriars' Churchyard, Edinburgh, on the 28th February, and copies were sent next day throughout the country for additional signatures. The Solemn League and Covenant was established in the year 1643, and formed a bond between Scotland, England, and Ireland for the united preservation of the Reformed religion in the Church of Scotland, the reformation of religion in England and Ireland "according to the Word of God and the example of the best Reformed churches," and the extirpation of Popery and Prelacy. It was sworn and subscribed by many in both nations, approved by the Parliament and Assembly at Westminster, and ratified by the General Assembly of Scotland in 1645. King Charles I. disapproved of it when he surrendered himself to the Scottish army in 1646; but in 1650 Charles II. by a solemn oath declared his approbation both of this and of the National Covenant; and in August the same year he made a further declaration at Dunfermline to the same purpose, which was renewed on the occasion of his coronation at Scone in 1651. In the same year also the covenant was ratified by Parliament, and subscription to it required from every member,—it being declared that without such subscription the constitution of the Parliament was null and void. It was afterwards renounced by Charles, and declared illegal by 13 and 14 Car. II. c. 4 (1662).

The two Covenants are usually published along with the Westminster Confession of Faith, though they are not now included among the authoritative symbols of any Presbyterian church. See *McCrue's Sketches of Scottish Church History*, *Cunningham's Church History of Scotland*, *Grub's Ecclesiastical History of Scotland*, and *Burton's History of Scotland*.

<sup>1</sup> In 1881 she married W. L. Ashmead Bartlett, who took her name.—*Am. Ed.*

COVENTRY, an ancient city and municipal and parliamentary borough of England, in the county of Warwick, 18 miles E.S.E. of Birmingham. It stands on a gentle eminence, and is watered by the Sherbourne and the Radford Brook, which unite within the town. Of its ancient fortifications two gates and some portions of the wall are still extant, and several of the older streets present a picturesque appearance, from the number of half-timbered houses projecting over the footways. In the course of the present century, and more especially since 1850, great improvements have been made in various quarters. The most remarkable buildings are the churches; and of these the oldest are St. Michael's, one of the finest specimens of Perpendicular architecture in England, with a beautiful steeple rising to a height of 303 feet; Holy Trinity Church, a cruciform structure in the Later English style, with a steeple at the intersection 237 feet high; and St. John's, or Bablake Church, which is nearly a parallelogram on the ground plan, but cruciform in the clerestory, with a tower in the centre. All three have been restored under the direction of Sir G. Gilbert Scott. Christ Church only dates from 1832, but it is attached to the ancient spire of the Grey Friars' Church. Of secular edifices the most interesting is St. Mary's Hall, erected by the united guilds in the early part of the 16th century. The principal chamber, situated above a fine crypt, is 76 feet long, 30 feet wide, and 34 feet high; its roof is of carved oak, and in the north end there is a large window of old stained glass,



Arms of Coventry.

with a curious piece of tapestry beneath nearly as old as the building. In the treasury is preserved a valuable collection of ancient monuments. Among the other public buildings of the city may be mentioned the new corporate offices and police court, the county hall, the drapers' hall, the hospital, the corn-exchange, the market hall, the self-supporting dispensary, the free library, the institute, the baths, the theatre, and the barracks. The cemetery is one of the most beautiful in the kingdom. The educational institutions include a well-endowed free grammar school, founded in the reign of Elizabeth, and held in the disused church of the hospital of St. John, a school of art, seven endowed charity schools, and a county reformatory for girls; and among the charitable foundations, which are numerous and valuable, Bond's hospital for old men and Ford's hospital for old women are remarkable as fine specimens of ancient timber work. Coventry was early celebrated for its manufactures, and had numerous guilds or trading companies. It was noted for its woollens in the 15th century, and subsequently acquired such a reputation for its dyeing that the expression "as true as Coventry blue" became proverbial. The weaving of tammsies, camlets, shalloons, etc., succeeded; but these branches of industry no longer exist. At present the staple trades are ribbon and trimming weaving, elastic web manufacturing, dyeing, and watchmaking; to which may be added the weaving of woollens, carpets, and carriage-lace, the spinning of cotton, the manufacture of sewing machines and bicycles, art metal-work, and ironfounding. The fairs are numerous and well attended. The borough returns two members to Parliament. In 1871 the population of the municipal borough was 37,670 (17,750 males, and 19,920 females), and of the parliamentary borough, which comprises an area of 6448 acres, 41,348.

Coventry derives its name (Conventre, or convent town), from a Benedictine priory, founded in 1043 by Earl Leofric and his wife Lady Godiva, who were afterwards buried within the priory church. According to a well-known popular tradition, exquisitely related in Tennyson's poem, the inhabitants were freed from the earl's excessive taxation by the romantic devotion of the lady, who rode through the streets of the city "clothed in with chastity," and thus compelled her husband to keep his oath. A procession, instituted in the time of Charles II. in commemorative imitation of the event, continued for many years to be annually celebrated; and an effigy called



Peeping Tom is still pointed out projecting from an upper window at the corner of Smithford street, popularly reputed to represent an inquisitive tailor, who was struck blind for having peered at the lady as she passed, while every other eye was averted in thankful reverence. Carmelite, Franciscan, and Carthusian monasteries were early established in the city, which was not long in acquiring a high position in the country. Gosford Green, outside its eastern wall, was chosen in 1397 for that great wager of battle between the dukes of Hereford and Norfolk, which was interrupted by Richard II., and formed such an important episode in the tragic history of the time. During the Wars of the Roses the citizens adhered to the Lancastrian party, and were consequently rewarded by Henry VI., whose charter, constituting the city and certain adjacent villages a separate county, continued in force till 1842. In the course of the 15th century several Parliaments were held in the town; and in 1569 it afforded for a short time a prison-house to Mary, Queen of Scots. During the troubles of the commonwealth the citizens espoused the cause of the Parliament; and on the restoration of Charles II. their fortifications were dismantled as a penalty for their disloyalty. To the student of English literature Coventry has a special interest on account of its mystery-plays, full details in regard to which will be found in Thomas Sharp's *Dissertation*, 1825. Various explanations of the popular phrase "to send to Coventry" have been suggested,—none of them particularly satisfactory. See Reader's *History of Coventry*, 1810; B. Poole's *History of Coventry*, 1869; and Sharp's *Antiquities of Coventry*, ed. by Fretton, 1871.

COVERDALE, MILES (1488–1569), the celebrated translator of the first complete English Bible, was born in Yorkshire in 1488. He was educated at Cambridge in the house of the Augustine friars, and, after having been admitted into that order, was ordained priest at Norwich in 1514. On the promulgation of the Reformed opinions at Cambridge, Coverdale was amongst the first to abandon his allegiance to the Church of Rome; and probably finding it unsafe to remain in England, he went abroad, and according to Foxe assisted Tyndale in translating the Bible. There seems, however, to be some reason to doubt Foxe's statement, which is entirely unsupported by corroborative evidence. Coverdale remained in total obscurity until 1535, when he published his own translation, with a dedication to Henry VIII., who had now come to an irreparable breach with the Pope. This was the earliest translation of the whole Bible in the English language, and the Psalms in it are those which are now used in the Book of Common Prayer. Although it is not an immediate version of the original (the title bearing that it is "truly translated out of Douche and Latyn"), it has many merits. Much of the rhythmical flow and finely-balanced cadence of the authorized version may be traced back to Coverdale. With the sanction of the king, Coverdale went to Paris in 1538 to superintend the publication of a new edition; but a decree of the Inquisition broke up the printing-establishment, and consigned the sheets already finished to the flames. A few copies, however, having been sold as waste-paper, were preserved; and these, with the presses which were transported to England, were used in printing *Cranmer's* or the *Great Bible*, under the superintendence of Coverdale, which was published in 1539. After 1540 Coverdale seems to have again resided for some time abroad. He returned to England after the death of Henry (1547), and was appointed almoner to the queen dowager, Catherine Parr. In 1551 Coverdale was appointed to the see of Exeter; and in consideration of his poverty the customary payment of first-fruits was remitted to him. On the accession of Mary he was thrown into prison, and released only on condition of leaving his native country. He received the grace of exile instead of execution through the urgent intercession of the king of Denmark, whose chaplain Mac Alpine was his brother-in-law. On the invitation of the latter, he repaired for a time to the court of Denmark, but afterwards retired to Geneva, where he was associated with other English exiles in executing the Geneva translation. On his return to England, after the death of Mary, he was not reinstated in his bishopric; and in 1563 he declined the see of Llandaff. He held for some time the rectory of St. Magnus, London Bridge, but resigned it in 1566. The rest of his life was spent in translating from the works of the Continental Reformers, and in the publication of tracts

for the spread of the Reformation. The date of Coverdale's death is uncertain, but he was buried in the chancel of the church of St. Bartholomew, February 19, 1569. The third centenary of the publication of Coverdale's Bible was held, October 4, 1835, when a medal was struck to commemorate the occasion. Coverdale's remains now lie in the church of St. Magnus, to which they were removed when St. Bartholomew's Church was taken down in 1840.

See *Writings and Translations of Coverdale*, edited for the Parker Society by Pearson (1844); *Remains of Coverdale*, edited for the Parker Society by Pearson (1846). The latter includes a biographical notice. See also Westcott's *General View of the History of the English Bible* (1868), and Eadie's *The English Bible* (1876).

COVILHA, a town of Portugal, in the province of BeiraBaixa, on the south-eastern slope of the highest part of the Serra da Estrella, where it descends to the upper valley of the River Zezere, 30 miles north of Castello-Branco, to which district it belongs. The town, which is perched on the declivity in the form of an amphitheatre, has been compared to a collection of swallows' nests, and is 2180 feet above the sea. It has several churches and convents. Population (1864), 9022. The people are chiefly employed in the manufacture of the brown cloth called *saragoga*, which is worn throughout Portugal. At the village of Unhacs-da-Serra, five miles W. S. W., there are noted sulphurous baths.

COVINGTON, a city of the United States, in Kenton County, Kentucky, on the Ohio, at its confluence with the Licking, and directly opposite Cincinnati (see plan, p. 684 of vol. v.). Its principal buildings are the city hall, the United States court house, the high school, the Oddfellows' hall, the hospital of St. Elizabeth, the Benedictine priory of St. Joseph's, and the Benedictine nunnery of St. Walburga; and its industrial establishments comprise numerous tobacco and cigar factories, and several iron-mills, distilleries, glass-works, silk factories, etc. Covington, as well as the contiguous town of Newport, is practically a suburb of Cincinnati, with which they have communication by a bridge and steam ferries. Since 1871 it has been supplied with water by water works on the Holly system. Covington was founded in 1812, and received incorporation as a city in 1824. In 1840 its population was 2026; in 1860, 16,471; and in 1870, 24,505. A considerable proportion of the inhabitants are Roman Catholics. There is a German orphan asylum about 4 miles from the city under Catholic management.

COWELL, DR. JOHN (1554–1611), jurist, was born at Ernsborough, Devonshire. He was educated at King's College, Cambridge, and ultimately became professor of civil law in that university, and master of Trinity Hall. In 1607 he compiled a law dictionary, in which he exalted the king's prerogative so much that he was prosecuted before the House of Commons by Sir Edward Coke, and saved from imprisonment only by the interposition of James I. Cowell also wrote a work entitled *Institutiones Juris Anglicani*.

COWES, WEST and EAST, two towns of England, in the county of Hants, on the estuary of the Medina, on the north coast of the Isle of Wight, directly opposite to the mouth of Southampton Water. The port between them is the chief one of the island, and is the headquarters of the Royal Yacht Squadron (founded in 1815); it is in constant steam communication with Ryde, and with Portsmouth and Southampton, each eleven miles distant. A steam ferry across the Medina, here 600 yards broad, unites the towns. Behind the harbor the houses rise picturesquely on gentle wooded slopes, and numerous villas adorn the vicinity. The towns owe their origin to two forts or castles, built on each side of the mouth of the Medina by Henry VIII. in 1540, for the defence of the coast; the eastern one has disappeared, but the west castle still stands and is used as the club-house of the Yacht Squadron. The marine parade of West Cowes, and the public promenade called the Green, are close to the castle. Within the town the streets are narrow; there are no buildings of architectural pretensions; and the place is quiet excepting in the yachting and bathing season from May to November. The resident population is chiefly employed in the ship-building yards, where yachts of the finest models and smaller naval vessels are built, and in ship provisioning. West Cowes is in railway communica-

tion with Newport and Ryde. Population (1871), 5730. On the opposite side of the Medina a broad carriage way leads to East Cowes Castle, a handsome edifice built by Nash, the favorite architect of George IV., in 1798, and immediately beyond it are the grounds surrounding Osborne House, the residence of the queen, completed in 1845. Norris Castle, on the rising ground above the shores of the Solent, built in 1799, and Whippingham Church on the right bank of the Medina, are other buildings of interest in the neighborhood of East Cowes, the population of which in 1871 was 2058.

COWLEY, ABRAHAM (1618-1667), the most popular English poet during the lifetime of Milton, was born in the city of London late in 1618. His father, a wealthy citizen, who died shortly before his birth, is believed to have been a grocer. His mother was wholly given to works of devotion, but it happened that there lay in her parlor a copy of *The Faery Queen*. This became the favorite reading of her son, and he had twice devoured it all before he was sent to school. As early as 1628, that is, in his tenth year, he composed his *Tragicall History of Piramus and Thisbe*, an epical romance written in a six-line stanza of his own invention. It is not too much to say that this work is the most astonishing feat of imaginative precocity on record; it is marked by no great faults of immaturity, and by constructive merits of a very high order. Two years later the child wrote another and still more ambitious poem, *Constantia and Philæta*, being sent about the same time to Westminster School. Here he displayed the most extraordinary mental precocity and versatility, and wrote in his thirteenth year yet another poem, the *Elegy on the Death of Dudley, Lord Carlton*. These three poems of considerable size, and some smaller ones, were collected in 1633, and published in a volume entitled *Poetical Blossoms*, dedicated to the headmaster of the school, and prefaced by many laudatory verses by schoolfellows. The author at once became famous, although he had not, even yet, completed his fifteenth year. His next composition was a pastoral comedy, entitled *Love's Riddle*, a marvellous production for a boy of sixteen, airy, correct, and harmonious in language, and rapid in movement. The style is not without resemblance to that of Randolph, whose earliest works, however, were at that time only just printed. In 1636 Cowley was elected into Trinity College, Cambridge, where he betook himself with enthusiasm to the study of all kinds of learning, and early distinguished himself as a ripe scholar. It was about this time that he composed his scriptural epic on the history of King David, one book of which still exists in the Latin original, the rest being superseded in favor of an English version in four books, called the *Davidica*, which he published a long time after. This his most grave and important work is remarkable as having suggested to Milton several points which he afterwards made use of. This epic, written in a very dreary and turgid manner, but in good rhymed heroic verse, deals with the adventures of King David from his boyhood to the smiting of Amalek by Saul, where it abruptly closes. In 1638 *Love's Riddle* and a Latin comedy, the *Navfragium Joculare*, were printed, and in 1641 the passage of Prince Charles through Cambridge gave occasion to the production of another dramatic work, *The Guardian*, which was acted before the royal visitor with much success. During the civil war this play was privately performed at Dublin, but it was not printed till 1650. It is bright and amusing, in the style common to the "sons" of Ben Jonson, the university wits who wrote more for the closet than the public stage. The learned quiet of the young poet's life was broken up by the civil war; he warmly espoused the royalist side. Cambridge became in 1643 too hot to hold him, and he made his way to Oxford, where he enjoyed the friendship of Lord Falkland, and was tossed, in the tumult of affairs, into the personal confidence of the royal family itself. After the battle of Marston Moor he followed the queen to Paris, and the exile so commenced lasted twelve years. This period was spent almost entirely in the royal service, "bearing a share in the distresses of the royal family, or laboring in their affairs. To this purpose he performed several dangerous journeys into Jersey, Scotland, Flanders, Holland, or wherever else the king's troubles required his attendance. But the chief testimony of his fidelity was the laborious service he underwent in maintaining the constant correspondence between the late king and the queen his wife. In that weighty trust he behaved himself with indefatigable integrity and unsus-

pected secrecy; for he ciphered and deciphered with his own hand the greatest part of all the letters that passed between their majesties, and managed a vast intelligence in many other parts, which for some years together took up all his days, and two or three nights every week." In spite of these labors he did not refrain from literary industry. During his exile he met with the works of Pindar, and determined to reproduce their lofty lyric passion in English. At the same time he occupied himself in writing a history of the civil war, which he completed as far as the battle of Newbury, but unfortunately afterwards destroyed. In 1647 a collection of his love verses, entitled *The Mistress*, was published, and in the next year a volume of wretched satires was brought out under his name, with the composition of which he had nothing to do. In spite of the troubles of the times, so fatal to poetic fame, his reputation steadily increased, and when, on his return to England in 1656, he published a volume of his collected poetical works, he found himself without a rival in public esteem. This volume included the later works already mentioned, the *Pindarique Odes*, and some *Miscellanies*. Among the latter are to be found Cowley's most vital pieces. This section of his works opens with the famous aspiration—

What shall I do to be for ever known,  
And make the coming age my own?

It contains elegies on Wotton, Vandyck, Harvey, and Crashaw, the last two being among Cowley's finest poems, brilliant, sonorous, and original; the amusing ballad of *The Chronicle*, giving a fictitious catalogue of his supposed amours; various gnomic pieces; and some charming paraphrases from Anacreon. The *Pindarique Odes* contain weighty lines and passages, buried in irregular and inharmonious masses of moral verbiage. Not more than one or two are good throughout, but a full posy of beauties may easily be culled from them. The long cadences of the Alexandrines with which most of the strophes close, continued to echo in English poetry from Dryden down to Gray, but the *Odes* themselves, which were found to be obscure by the poet's contemporaries, immediately fell into disesteem. *The Mistress* was the most popular poetic reading of the age, and is now the least read of all Cowley's works. It was the last and most violent expression of the amatory affectation of the 17th century, an affectation which had been endurable in Donne and other early writers because it had been the vehicle of sincere emotion, but was unendurable in Cowley because in him it represented nothing but a perfunctory exercise, a mere exhibition of literary callisthenics. He appears to have been of a cold, or at least of a timid, disposition; in the face of these elaborately erotic volumes, we are told that to the end of his days he never summoned up courage to speak of love to a single woman in real life. Soon after his return to England he was seized in mistake for another person, and only obtained his liberty on a bail of £1000. In 1658 he revised and altered his play of *The Guardian*, and prepared it for the press under the title of *The Culler of Coleman Street*, but it did not appear until 1663. Late in 1658 Oliver Cromwell died, and Cowley took advantage of the confusion of affairs to escape to Paris, where he remained until the Restoration brought him back in Charles's train. Wearied with the broils and fatigues of a political life, Cowley obtained permission to retire into the country; through his friend, Lord St. Albans, he obtained a property near Chertsey, and here, devoting himself to the study of botany, and buried in his books, he lived in comparative solitude until his death, which occurred on the 28th of July, 1667, a period otherwise famous for the publication of *Paradise Lost*. On the 3d of August he was buried in Westminster Abbey beside the ashes of Chaucer and Spenser, where in 1875 the duke of Buckingham erected a monument to his memory. Throughout their parallel lives the fame of Cowley completely eclipsed that of Milton, but posterity instantly and finally reversed the judgment of their contemporaries. The poetry of Cowley rapidly fell into a neglect as unjust as the earlier popularity had been. As a prose writer, especially as an essayist, he holds, and will not lose, a high position in literature; as a poet it is hardly possible that he can enjoy more than a very partial revival. The want of nature, the obvious and awkward art, the defective melody of his poems, destroy the interest that their ingenuity and occasional majesty would otherwise excite. He had lofty views of the mission

of a poet and an insatiable ambition, but his chief claim to poetic life is the dowry of sonorous lyric style which he passed down to Dryden and his successors of the 18th century.

The works of Cowley were not collected till 1688, when Thomas Spratt, afterwards bishop of Rochester, brought out a splendid edition in folio, to which he prefixed a graceful and elegant life of the poet. There were many reprints of this collection, but since the early part of the 18th century no good edition of Cowley's poems has appeared. The Essays, on the contrary, have frequently been revived with approval. (E. W. G.)

COWPER, WILLIAM (1731-1800), the best of English letter-writers and the most distinguished poet of his day, was born on the 26th of November, 1731, at Great Berkhamstead, Hertfordshire. His father, who held the living of the parish, was chaplain to George II. He married Ann, daughter of Roger Donne, of Ludham Hall in Norfolk. This lady, after giving birth to several children who died in infancy, expired in childbed in 1737, leaving two sons—William (the poet) and John. Cowper, who retained the most affectionate remembrance of his mother, embalmed her memory in one of the most affecting tributes that ever came from the heart of a son.

At the age of six years Cowper was placed at Dr. Pitman's school, in Market Street, Bedfordshire. His health was delicate, and he was in consequence exposed to the laughter and ridicule of his rude companions. One boy seems especially to have been the object of his terror. "His savage treatment of me," he says, "impressed such a dread of his figure on my mind, that I well remember being afraid to lift my eyes upon him higher than his knees, and that I knew him better by his shoe-buckle than by any other part of his dress." The cruelty of this boy's conduct was such that on its being discovered he was expelled the school, and Cowper was removed. The mental anguish he endured at this time aggravated, no doubt, the constitutional tendency to despondency which throws such a peculiar interest over much of his after life. At the period of his removal from Dr. Pitman's school he was afflicted with inflammation in the eyes; specks appeared in both of them, and it was feared that blindness would ensue. He was in consequence placed in the house of an eminent oculist, where he remained two years, deriving little benefit from his residence there, his cure being slow and imperfect.

At ten years of age Cowper was placed at Westminster School. In after life he lamented that his learning at this time consisted entirely of Latin and Greek, to the exclusion of the more important matter of religion. Surrounded by strangers, and unable from his unconquerable shyness to mingle with them on easy terms, his fits of depression grew darker and more frequent; and those unhappy views of his spiritual condition, which afterwards produced such deplorable results, began to oppress his mind. In his memoir he relates some of his religious experiences. Crossing St. Margaret's churchyard late in the evening, his curiosity was excited by a glimmering light, and he went to see whence it proceeded. A gravedigger was at work with a lantern; and just as Cowper came to the spot a skull was thrown up which struck him on the leg. This circumstance gave an alarm to his conscience, and he afterwards considered it one of the most valuable religious impressions he received at Westminster. His mental excitement was followed by the notion that he was exempted from the penalty of death, which in its turn was displaced by lowness of spirits and intimations of a consumptive tendency. At thirteen he was seized with small-pox, which completely restored his eyesight. Although threatened by consumption, he seems to have excelled at cricket and football, and to have distinguished himself in his studies. It is curious to know that Warren Hastings, Churchill, Lloyd, and Colman were his fellow-students in Westminster.

Cowper was taken from Westminster at eighteen years of age; and, after spending a few months at home, was articled to Mr. Chapman, an attorney in London. He seems to have most poetically disliked his new position and duties. Thurlow, afterwards lord chancellor, was engaged in the same office; and Cowper describes their leisure as being spent in "giggling and making giggle, instead of studying the law." The following is related of his intimacy with Thurlow a few years later. One evening, in the presence of ladies, Cowper playfully said, "Thurlow, I am

nobody, and shall always be nobody, and you will be chancellor. You shall provide for me when you are." Thurlow replied with a smile, "I surely will." "These ladies," rejoined Cowper, "are our witnesses." "Let them be so," answered the future chancellor, still smiling, "for I will certainly do it." After completing his three years' articles with Mr. Chapman, he removed to the Middle Temple in 1752. The solitariness of his life at this time was productive of the most pernicious results. In his melancholy memoir he describes the dejection and unrest, the horror and despair, he underwent during these miserable months. At length relief came. Sitting with a few friends by the sea near Southampton, the cloud of misery which had overshadowed his spirit so long rolled away, and so happy did he feel that he could have wept for transport had he been alone. Returning to London, and actuated by what he afterwards considered the instigation of Satan, he burned his prayers, and plunged into pleasure and gayety. In 1754 he was called to the bar, but, instead of following his profession, he seems to have yielded himself up to the charms of literature and social intercourse. About this time his father died, leaving him a small patrimony. In 1759 he removed to the Inner Temple, where law was still deserted for literature. He devoted much of his time to the study of Homer, and, in conjunction with his brother, translated some of the books of the *Henriade*. This appears to have been the gayest part of Cowper's life. He had formed literary acquaintances amongst whom were many of his old schoolfellows; he became a member of the Nonsense Club, and occasionally contributed prose and verse to the periodicals of the day.

While in Mr. Chapman's office, Cowper was a frequent visitor at the house of his uncle, Mr. Ashley Cowper, in Southampton Row,—the attraction being his fair cousin. Miss Theodora Jane Cowper was the younger of two daughters (the elder of whom, afterwards Lady Hesketh, is well known as the poet's constant correspondent for many years), and by her brilliant beauty and fascinating manners won the heart of her shy relative. Excited by her presence and sparkling spirits, Cowper became cheerful and even gay, his bashfulness began to wear off; he mixed in company, and occasionally attempted to shine in conversation. He became fastidious in his attire, a critic in ruffles, a haunter of looking-glasses. Seeing how matters were tending, Mr. Cowper opposed their contemplated union on prudential considerations. His daughter pooh-poohed his fears. He asked what she would do if she married her cousin. "Do, sir," answered the high-spirited girl, "wash all day, and ride out on the great dog at night." Mr. Cowper afterwards changed his position, and objected to their marriage on the score of nearness of connection. The lovers pled, but he was inexorable. Miss Cowper thought it her duty to obey her father. They parted and never met again.

During this courtship, Cowper addressed several poems to his cousin, which exhibit all the gentleness and tenderness of his nature. They are unlike the love-poems of every other poet. They have no fervor, no emotion, no fire. Perhaps Cowper's nature was incapable of strong and devouring passion. The memory of his love and his disappointment seems to have been soon and painlessly effaced. With the lady it was different; she could not so easily forget. The little poems which, in his brief dream of passion, he had addressed to her, she carefully treasured up. Unknown to him, her hand was unwearied in its kind and delicate attentions. She never forgot him, and although surviving his death many years, died unmarried.

Cowper's pecuniary resources being at this time slender, he became naturally anxious to obtain suitable employment. An influential kinsman presented him with the lucrative office of clerk to the committees of the House of Lords. Some difficulty, however, being raised as to his relative's right of appointment, an examination at the bar of the House was demanded to test Cowper's fitness for the performance of his duties. Although the prospect of such a public appearance must have been exceedingly painful to him, he resolved to prepare for the ordeal. He attended regularly at the office, and thus describes the result:—"The journal books were thrown open to me—a thing which could not be refused, and from which, perhaps, a man in health and with a head turned to business might have gained all the information he wanted; but it was not

so with me; I read without perception, and was so distressed that, had every clerk in the office been my friend, it could have availed me little, for I was not in a condition to receive instruction, much less to elicit it out of manuscripts without direction." The dreadful trial that awaited him filled his days, and reappeared in dreams. He found no rest. At a tavern he met some miserable men, and suicide became the subject of conversation. The idea was new to him, and held him with a horrid fascination from which he could not escape. He was pursued and goaded by imaginary voices, until at last in a paroxysm of madness he attempted self-destruction. The garter by which he was suspended broke, and he fell heavily to the ground. His landlady hearing the fall, and thinking him in a fit, ran to his assistance; but by the time she reached him he had crept into bed. His mind now became a prey to the keenest remorse. The wrath of God seemed hanging over him on account of his sin. In these circumstances, every thought of his official employment was, of course, abandoned; measures were adopted for his security, and in 1763 he was placed under the care of Dr. Cotton of St. Albans.

After remaining two years at St. Albans he removed to Huntingdon. Here he first met the Unwins, and so charmed was he with their society, that in a short time he became an inmate of their home. On the death of Mr. Unwin in 1767 the family removed to Olney; and on the recommendation of Mr. Newton, the curate of the parish, Cowper accompanied them. About this time his brother died; and in the winter of 1773 his malady returned. Through his long illness he was attended by Mrs. Unwin with the most affectionate care. To beguile the tedium of recovery, he occupied himself with carpentry and gardening, and in domesticating his famous hares. Up till this time he had only written a few hymns; he now, at Mrs. Unwin's suggestion, commenced a poem on the *Progress of Error*. Composition, once begun, was so ardently prosecuted that in a few months his first volume, consisting, with the poem already mentioned, of *Table-Talk, Conversation, Truth, Expectation, Hope, Charity, and Retirement*, was ready for the press. It attracted little attention. One critic declared that "Mr. Cowper was certainly a good pious man, but without one spark of poetic fire." In 1781 he met Lady Austen, and the casual acquaintance soon ripened into the warmest intimacy. Her lively spirits chased from his mind the demon of melancholy. He wrote songs which she set to music and sang to the harpsichord. It is said that observing him one evening in a fit of depression, she related the story of John Gilpin, with which he was so delighted that after retiring to rest he turned it into verse, and repeated it with great glee when they met next morning at the breakfast-table. The *Task*, undertaken at the suggestion of his new friend, was begun in the winter of 1783 and published in 1785. Its success was complete, and his reputation was at once established. Never, perhaps, in England had poetry been at so low an ebb as at this time. The brilliant point and antithesis of Pope had degenerated into the inflated diction of Darwin and the feeble sentimentalities of Hayley. Cowper's hearty and natural verse extinguished these weaklings for ever. Although Cowper cannot be placed in the first rank of English poets, yet few are attended with such retinues of love and blessing. His verse is a transparent medium through which you look into a gentle and most lovable human spirit, and you come to know him as thoroughly as if you had lived in the same house with him for years. His muse does not sit apart in sublime seclusion—she comes down into the ways of men, mingles in their every-day concerns, and is interested in crops and rural affairs. You see by the slight tan on her cheek that she has been much in the harvest-fields. Cowper rather talks than sings. His blank-verse makes no pretensions to majesty; it is colloquial sometimes in its bareness, yet in its artless flow is ever delightful as the conversation of a beloved and gifted companion.

Cowper brought back nature to poetry, and his influence has been extensive and lasting. He is, to a certain extent, the prototype of Wordsworth. Indeed, many passages in the *Excursion* read like extracts from the *Task*. It is curious also to observe in Cowper's verse that subjectivity which is supposed to be the characteristic of more recent times. His allings, his walks, his musings, his tamed hares, his friends, his indignation at slavery, his peculiar views of religion, are the things he delights to portray—the *Task* is a poem entirely about himself.

On Lady Austen leaving Olney, her place was filled by the Throgmortons, whose acquaintance Cowper had made on the occasion of a *fête* which they gave to the surrounding gentry. He was delighted with his new friends and spent much time in their society. During this period he was not idle; he had commenced his translation of Homer, and in the winter of 1785 had advanced as far as the 20th book of the *Iliad*. Owing to the rigorous care he bestowed upon his work it did not advance so rapidly as he at first anticipated, and was not published till 1791. Cowper was now in the zenith of his reputation. Rumors of his fame were wafted to the quiet residence of Olney from that world which he had so long forsaken, he was hailed the first poet of the day, and his old friend Thurlow (whose greatness he had foreseen) opened a correspondence with him and thanked him for his translation. To the mild spirit of Cowper the last circumstance must have been peculiarly grateful. While engaged upon Homer, his dreaded malady returned, but was happily driven away by the charms of society and constant literary occupation. He well knew that if he remained inactive the dark spirit would regain his throne; and no sooner was Homer given to the world than we find him engaged on an edition of Milton. But the labor was too much; his brain sunk beneath the incessant demands made on its energies, and so great was his distress that he was obliged to relinquish the undertaking. The clouds were now closing dark and heavy over the evening of Cowper's life. Mrs. Unwin was an invalid; he was ever by her bedside, and nursed her with a tenderness, if possible, deeper than her own. Beneath the tension of sorrow the cord snapped. His malady returned, which was never destined in this life to be rolled away. Mrs. Unwin died on the 17th of December, 1796. Cowper, with wandering brain and feeble as a child, was led into the room; the presence of the dead drew from him one wild passionate exclamation, he then relapsed into silence, and it is said never more uttered her name. The deepest dejection, alternating with fits of spiritual despair, hung over him to the end. Dropsy appeared in his limbs; and after being reduced to the last stage of feebleness, he died peacefully on the 25th of April, 1800. (A. S.)

The posthumous writings of Cowper, with a life by his friend Hayley, appeared in 1803-4. The best life, that by Southey, with an excellent edition of his works, was published in 1833-37, and with additional letters, in *Bohn's Standard Library* (1853-54). Other editions of his works, with memoirs, are those of Grimshawe (1835), Dr. Memes (1852), and George Gillilan. Lives have also been written by H. F. Cary, M'Diarmid, and Thomas Taylor. See, besides a study by Sainte-Beuve in the *Moniteur* (Nov. 13, 29, 27, and Dec. 4, 1854), Stopford Brook's *Theology in the English Poets*, and Léon Boucher, *William Cowper, sa correspondance et ses poésies*.

COWRY, the popular name of the shells of the *Cypræida*, a family of mollusks. Upwards of 100 species are recognized, and they are widely distributed over the world,—their habitat being the shallow water along the sea-shore. The best known is the money cowry or *Cypræa moneta*, a small shell about half an inch in length, white and straw-colored without and blue within, which derives its distinctive name from the fact that in various countries it has been employed as a kind of currency. It is most abundant in the Indian Ocean, and is collected more particularly in the Maldive Islands, in Ceylon, along the Malabar coast, in Borneo and other East Indian Islands, and in various parts of the African coast from Ras Hafun to Mozambique. It was formerly in familiar use in Bengal, where, though it required 3840 to make a rupee, the annual importation was valued at about £30,000. In the countries of Further India it is still in use; and in Siam, for example, 6400 cowries are equal to a *tical* or about 1s 6d. In Western Africa—Congo, Yoruba, &c.—it is the usual tender, and before the abolition of the slave trade there were large shipments of cowry shells to some of the English ports for reshipment to the slave coast. As the value of the cowry was very much greater in Western Africa than in the regions from which the supply was obtained, the trade was extremely lucrative, and in some cases the gains are said to have been 500 per cent. The use of the cowry currency has gradually spread inland in Africa, and Barth found it fairly recognized in Kanó, Kukawa, Muniyoma, Gando, and even Timbuktú. In Muniyoma he tells us the king's revenue was estimated at 30,000,000 shells, every full-grown man being required to pay annually 1000 shells for himself, 1000 for every

pack-ox, and 2000 for every slave in his possession. In the countries on the coast the shells are fastened together in strings of 40 or 100 each, so that fifty or twenty strings represent a dollar; but in the interior they are laboriously counted out one by one, or, if the trader be expert, five by five. The districts mentioned above receive their supply of *kardi*, as they are called, from the west coast; but the regions to the north of the Land of the Moon, where they are in use under the name of *simbi*, are dependent on Moslem traders from Zanzibar. Among the Niam-Niam and other tribes who do not recognize their monetary value, the shells are in demand as fashionable decorations, just as in Germany they were in use as an ornament for horses' harness, and were popular enough to acquire several native names, such as *Brustharnisch* or breastplates, and *Otterhöfchen* or little adder's heads. Besides the *Cypræa moneta* various species are employed in this decorative use. The *Cypræa aurora* is a mark of chieftainship among the natives of the Friendly Islands; the *Cypræa annulus* is a favorite with the Asiatic islanders; and several of the larger kinds have been used in Europe for the carving of cameos. The tiger cowry, *Cypræa tigris*, so well known as a mantelpiece ornament in England and America, is commonly used by the natives of the Sandwich Islands to sink their nets; and they have also an ingenious plan of cementing portions of several shells into a smooth oval ball which they then employ as a bait to catch the cuttle-fish. While the species already mentioned occur in myriads in their respective habitats, the *Cypræa princeps* and the *Cypræa umbilicata* are extremely rare. Of the former, indeed, perhaps not more than two or three specimens are known,—one of them being in the British Museum, and another having drawn £40 at the sale of the collection of the earl of Mountnorris.

(COX, DAVID (1783-1859). The remarkable development of the English school of landscape-painting during the first half of the present century gives importance to the name of David Cox. He is, indeed, to use a phrase now sufficiently common, a representative man, having practised his art through the entire period, outliving and overcoming public indifference, and reaping at last a harvest of appreciation that astonished himself. Besides, he dedicated his life to home scenery and its atmospheric conditions exclusively, so that his productions are truly English, while their artistic mastery, and their power to convey the impression he intended, are unsurpassed, perhaps unequalled, by the works of any of his contemporaries, even those of higher genius and much more general culture. It must be remembered, also, that in Cox's works we see our native art of water-color-painting in its purest condition, expressing only a direct, general, and honest sentiment by the simplest means, before the doctrine of "art for art's sake" had made our painters determined to show on their canvas more than they see in nature.

In a small house attached to the forge of his father, a hardworking master smith, in a mean suburb of Birmingham, Cox was born, 29th April, 1783. Turning his hand to what he could get to do, Joseph Cox, the father, was both blacksmith and whitesmith, and when the war began took to the making of bayonets and horse shoes, on wholesale commission, and immediately the boy David was thought able to assist he was taken from the poor elementary school in the neighborhood, and set to the anvil. The attempt to turn the boy to this kind of labor had, however, been made too early; it was too heavy for his strength, and he was sent to what was called by the cyclops of Birmingham a "toy trade," making lacquered buckles, painted lockets, tin snuff boxes, and other "fancy" articles. Here David very soon acquired some power of painting miniatures, and his talents might have been misdirected had his master, Fieldler by name, not released him from his apprenticeship by dying,—dying by his own hand; and David found an opening as color-grinder and scene-painter's fag in the theatre then leased, with several others, by the father of Macready, the tragedian.

This obscure step, not one of promotion at the time, was really the most important incident in the uneventful career of Cox. It may be remembered that scene-painting has been to our landscape-painters what the goldsmith education was to the masters of the Italian renaissance, and we are safe in saying that the habits of hard work on a large scale, and the rough and ready self-dependence thus cultivated, can never be too much commended. The boy, who

had inherited a rather weakly body, and had been trained with care by a pious mother, while intellectually negative and unable to cope with any kind of learning whatever, had endless perseverance, great strength of application, and all through life remained genial, gentle, simple-minded, and modest, his penetration and self-reliance being wholly professional, inspired by his love of nature and his knowledge of his subject. Not very quick, and with little versatility he went step by step in one line of study from the time he began to get the smallest remuneration for his pictures to the age of seventy-five, when he painted large in oil very much the same class of subjects he had of old produced small in water-colors, with the same impressive and unaffectedly noble sentiment, only increased by the mastery of almost infinite practice. He was never led astray by fictitious splendor of any kind, except once indeed in 1825, when he imitated Turner, and produced a classic subject he called Carthage, *Æneas*, and *Achates*. He never visited Venice or Egypt, or crossed the Channel except for a week or two in Belgium and Paris, and never even went to Scotland for painting purposes. Bettws-y-Coed and its neighborhood was everything to him, and characteristics most truly English were beloved by him with a sort of filial instinct. So completely did he love the country, that even London, where it was his interest to live, had few attractions, and did not retain him long.

This residence in the metropolis which began in 1804 was, however, of the most essential educational advantage to him. The Water-Color Society was established the year after he arrived, and was mainly supported by landscape-painters. He was not, of course, admitted at first into membership, not till 1813, before which time an attempt to establish a rival exhibition had been made. In this Cox joined, the result being very serious to him, an entire failure entailing the seizure and forced sale of all the pictures. At that time the tightest economy was the rule with him, and to save the trifling cost of new strainers or stretching boards, he covered up one picture by another. When these works were prepared for re-sale, fifty years afterwards, some of them yielded picture after picture, peeled off the boards like the waistcoats from the body of the gravedigger in Hamlet!

While lodging near Astley's Circus he married his landlady's daughter, and then took a modest cottage at Dulwich, where he gradually left off scene-painting and became teacher, giving lessons at ten shillings a lesson. This entailed walking to the pupils' homes, and the gift of the paintings done before the pupils. These have since been frequently sold for 30 or 40 guineas, but his own price, when lucky enough to sell his best works, was never over a few pounds, and more frequently about fifteen shillings. Sometimes, indeed, he sold them in quantities at two pounds a dozen to be resold to country teachers. By and by he resisted the leaving of the work done to the pupil, but with little advantage to himself, as he saw no end to the accumulation of his own productions, and actually tore them up, and threw them into areas, or pushed them into drains during his trudge homeward. A number of years after he pointed out a particular drain to a friend, and said, "Many a work of mine has gone down that way to the Thames!"

Shortly after he had turned thirty, his stay in London suddenly ended. He was offered the enormous sum of £100 per annum by a ladies' college in Hereford, and thither he went. This sum he supplemented by teaching in the Hereford grammar school for many years, at six guineas a year, and in other schools at better pay, but still, and up to his fortieth year, we find his prices for pictures from eight to twenty-five shillings. Cox has no history apart from his productions, and these particulars as to his remuneration possess an interest almost dramatic when we contrast them with the enormous sums realized by his later works, and with the "honors and observance, troops of friends," that accompanied old age with him, when settled down in his own home at Harborne, near his native town, where he died on June 7, 1859, aged seventy-six.

Cox's second short residence in London, dating from 1835 to 1840, marks the period of his highest powers. During those years, and for twelve years after, his productivity kept pace with his mastery, and it would be difficult to overrate the impressiveness of effect, and high feeling, within the narrow range of subject displayed by many of these works. He was now surrounded by dealers,

and wealth flowed in upon him. Still he remained the same, a man with few wants and scarcely any enjoyments except those furnished by his brush and his colors. The home at Harborne was a pleasant one, but the approach to the front was useless as the door was kept fastened up, the only entrance being through the garden at the back, and the principal room appropriated as his studio he was content to reach by a narrow stair from the kitchen. Neither in it nor elsewhere was there any luxury or even taste visible:—no *bric-a-brac*, no objects of interest, few or no books, no pictures except landscapes by his friends. When in winter, after his wife's death, the fire went out, and the cold at last surprised him, he lifted his easel into the little dining-room and began again. A union of his friends was formed in 1855 to procure a portrait of him, which was painted by Sir J. Watson Gordon; and an exhibition of his works was opened in London in 1858 and again another in 1859. This was actually open when the news of his death arrived.

The number of David Cox's works, great and small, is enormous. He produced hundreds annually for perhaps forty-five years. This being the case, it has been the interest of dealers to force their price. Mr. Flatou, himself an adept, used to boast that it took six horse-dealers to make one picture-dealer, so that it is difficult to say what is their intrinsic or permanent value. Before his death and for ten years thereafter, their prices were remarkable, as witness the following, obtained at auction—Going to the Mill, £1575; Old Mill at Bettws-y-Coed, £1575; Outskirts of a Wood, with Gipsies, £2305; Peace and War, £3430.

(W. B. 8C.)

COX, RICHARD (1499–1581), born at Whaddon, Buckinghamshire, was educated at Eton, and afterwards at King's College, Cambridge, of which he became a fellow in 1519. He was invited to Oxford by Cardinal Wolsey; but having adopted the Reformed opinions, he was stripped of his preferment, and thrown into prison. On his release, however, he was appointed master of Eton School, and in 1541 he was made prebendary of Ely Cathedral. Through the influence of Cranmer he was chosen tutor to Prince Edward, and on the accession of that prince he was sworn of the Privy Council, and made king's almoner. Under Mary he was stripped of his preferments, and committed to the Marshalsea; he escaped, however, to Strasburg, where he resided with Peter Martyr. By Elizabeth he was elevated to the see of Ely. Cox was a man of considerable learning. He was distinguished by the violence of the measures which he recommended for the extirpation of Popery and dissent.

He translated the four gospels, the Acts of the Apostles, and the Epistle to the Romans, in the Bishops' Bible, and had a considerable share in compiling and revising the liturgy; and he wrote *Two Latin Orations on the Disputes between Dr. Tresham and Peter Martyr*, London, 1549, and *Resolutions of some Questions concerning the Sacrament*, printed in the Collection of Records at the end of Burnet's *History of the Reformation*.

COXCIE, MICHAEL (1499–1592), was born at Malines, and studied under Bernard van Orley, who probably induced him to visit Italy. At Rome in 1532 he painted the chapel of Cardinal Enckenvoort in the church de Anima; and Vasari, who knew him personally, says with truth "that he fairly acquired the manner of an Italian." But Coxcie's chief business in Italy was not painting. His principal occupation was designing for engravers; and the fable of Psyche in thirty-two sheets by Agostino Veneziano and the Master of the Die are favorable specimens of his skill in this respect. During a subsequent residence in the Netherlands Coxcie greatly extended his practice in this branch of art. But his productions were till lately concealed under an interlaced monogram M.C.O.K.X.I.N. Coxcie, who married in Italy, displayed the peculiar bias of his taste by christening his eldest son Raphael. He returned in 1539 to Malines, where he matriculated, and painted for the chapel of the guild of St. Luke the wings of an altar-piece now in Sanct Veit of Prague. The centre of this altar-piece, by Mabuse, represents St. Luke portraying the Virgin; the side pieces contain the Martyrdom of St. Vitus and the Vision of St. John in Patmos. At Van Orley's death in 1541 Coxcie succeeded to the office of court painter to the regent Mary of Hungary, for whom he decorated the castle of Binche. He was subsequently patronized by Charles V., who often coupled his works with those of Titian; by

Philip II., who paid him royally for a copy of Van Eyck's *Agnus Dei*; and by the duke of Alva, who once protected him from the insults of Spanish soldiery at Malines. There are large and capital works of his (1587–88) in St. Rombard of Malines, in Ste. Gudule of Brussels, and in the museums of Brussels and Antwerp. His style is Raphaelesque grafted on the Flemish, but his imitation of Raphael, whilst it distantly recalls Giulio Romano, is never free from affectation and stiffness. Coxcie was working at a picture in Antwerp when he met with a fall. He was taken in an ailing state to Malines, where he died on the 5th of March, 1592.

COXE, WILLIAM (1747–1828), archdeacon of Wilts, traveller, and historian, was born at London in 1747. He was elected fellow of King's College, Cambridge, in 1768, and afterwards went abroad on a visit to the different Continental states, where he prosecuted the researches which were afterwards incorporated into his historical works. On his final return to England he was appointed to the rectory of Bemerton, and in 1808 was preferred to the archdeaconry of Wilts. Towards the close of his life his vision became seriously impaired, and for nearly seven years before his death he was totally blind. He died at Bemerton in 1828.

Of his numerous works the most important are—*Sketches of the Natural, Civil, and Political State of Switzerland* (1779); *Private Correspondence of Charles Talbot, Duke of Shrewsbury* (1821); *Travels in Switzerland* (1789); *Travels in Poland, Russia, Sweden, and Denmark* (1784); *Histories of the House of Austria, and of the Kings of Spain of the House of Bourbon; Memoirs of John, Duke of Marlborough; Memoirs of Sir Robert Walpole; Memoirs of the Administration of Henry Pelham* (posthumous, 1839); *Literary Life and Select Works of B. Stillingfleet*.

COYPEL, the name of a French family of painters. Noel Coypel (1628–1707), also called, from the fact that he was much influenced by Poussin, Coypel le Poussin, was the son of an unsuccessful artist. Having been employed by Edward to paint some of the pictures required for the Louvre, and having afterwards gained considerable fame by other pictures produced at the command of the king, in 1672 he was appointed rector of the French Academy at Rome, to which he is said to have done good service. After four years he returned to France, and not long after he became director of the Academy of Painting. The Martyrdom of St. James in Notre Dame is perhaps his finest work. His son, Antoine Coypel, was still more famous. Antoine studied under his father, with whom he spent four years at Rome. At the age of eighteen he was admitted into the Academy of Painting, of which he became professor and rector in 1707, and director in 1714. In 1716 he was appointed king's painter, and he was ennobled in the following year. Antoine Coypel received a careful literary education, the effects of which appear in his works; but the graceful imagination displayed by his pictures is marred by the fact that he was not superior to the artificial taste of his age. He was a clever etcher, and engraved several of his own works. His *Discours Prononcés dans les Conférences de l'Académie Royale de Peinture, etc.*, appeared in 1741. His half-brother, Noel Nicolas (1691–1734), was also a popular artist; and his son, Charles Antoine (1694–1752), was painter to the king and director of the Academy of Painting. The latter published interesting academical lectures in *Le Mercure*, and wrote several plays which were acted at court, but were never published.

COYSEVOX, ANTOINE (1640–1720), one of the most able and famous of French sculptors, born at Lyons in 1640, belonged to a family which had emigrated from Spain. He was only seventeen when he produced a statue of the Madonna of considerable merit; and having studied under Leranbert, and trained himself by taking copies in marble from the Greek masterpieces (among others from the Venus de Medici and the Castor and Pollux), he was engaged by the bishop of Strasburg, prince and cardinal Fürstenberg, to adorn with statuary the palace of Saverne. After four years spent on this work, he returned to Paris in 1671, having gained very considerable fame. He was now employed by Louis XIV. in producing a large number of statues for Versailles, and he afterwards worked with no less facility and success for the palace at Marly. His works are far too numerous to mention; but among them are the Mercury and Fame, placed first at Marly and afterwards in the gardens of the Tuileries;

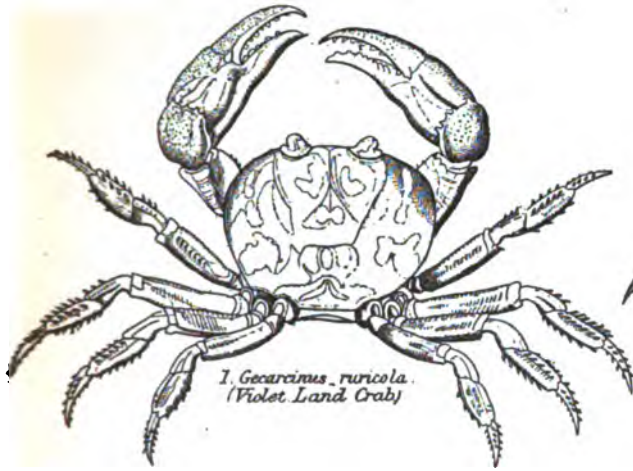

1. *Geocarinus ruficola*.  
(Violet Land Crab)

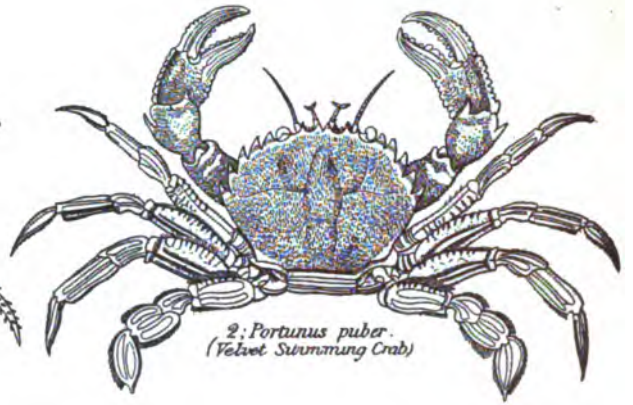

2. *Portunus puber*.  
(Velvet Swimming Crab)

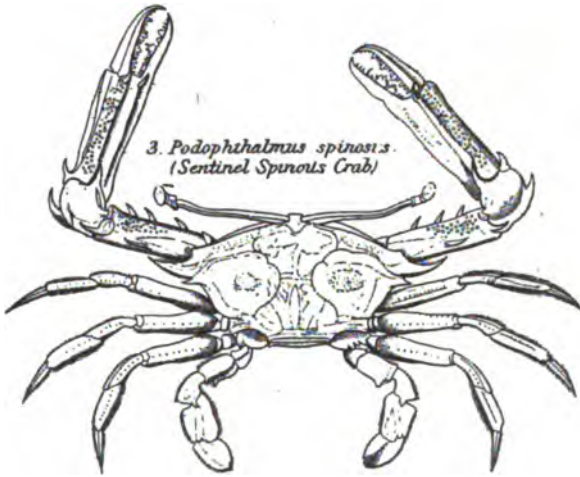

3. *Podophthalmus spinosus*.  
(Sentinel Spiny Crab)



4. *Pagurus Bernhardus*.  
(Soldier Crab)



5. *Pinnotheres pisum*.  
(Pea Crab)

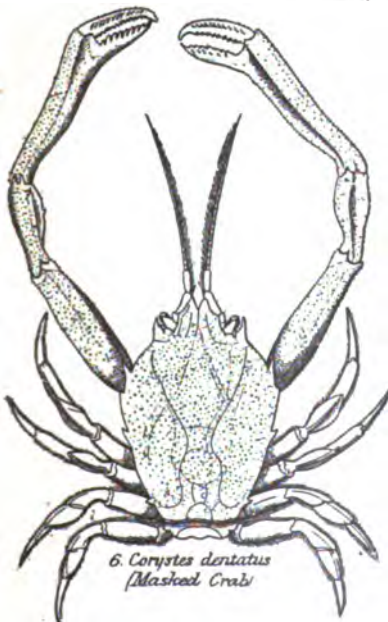

6. *Corystes dentatus*.  
(Masked Crab)

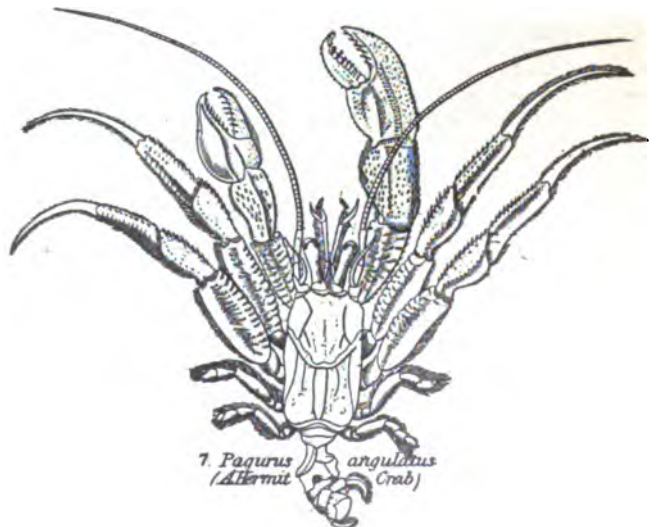

7. *Pagurus angulatus*.  
(Hermit Crab)





Neptune and Amphitrite, in the gardens at Marly; Justice and Force, at Versailles; and statues, in which the likenesses are said to have been remarkably successful, of most of the celebrated men of his age, including Louis XIV., Louis XV., Colbert (at Saint-Eustache), Mazarin (in the church des Quatre-Nations), Condé the Great, Maria Theresa of Austria, Luvois, Turenne, Vauban, Cardinals de Bouillon and de Polignac, Fénelon, Racine, Bossuet, Comte d'Harcourt, Prince de Fürstenberg, and Charles Lebrun.

CRAB, a name common to all the species of short-tailed Decapod Crustaceans (*Brachyura*), as well as to the forms intermediate between the short-tailed and long-tailed groups (*Anomoura*), and derived from the Latin *Crabrus*, the name by which the common edible species was known to the Romans. The abdomen in the true crabs is short, and is completely folded beneath the breast. In the female this part is broad and rounded, and bears certain leafy appendages to which the ova are attached before spawning; in the male the abdomen is much narrower and is somewhat triangular in shape. Like all other Decapod Crustaceans crabs are furnished with ten legs, of which the anterior pair are modified so as to form nippers—powerful prehensile organs and principal weapons of offence. These are largest in the male, and the right claw is generally larger than the left. The other limbs usually end in a single claw, which in the posterior pair in swimming-crabs is more or less flattened and paddle-like (Plate X. fig. 2). Their eyes, which are compound, are placed upon stalks, measuring in some instances an inch in length (Plate X. fig. 3), and these when not in use fit into cavities in the carapace or shell which covers the entire upper surface. Crabs, like insects, undergo metamorphosis. On emerging from the egg they are provided with long tails, swimming appendages, and sessile eyes, and bear so little resemblance to the parent form that until half a century ago their connection with the crab was altogether unsuspected. They were then known as *soëas*. After moulting, the eyes appear on stalks and nippers on the anterior pair of legs, but this form is still sufficiently uncrablike to have deceived early zoologists, who described it as forming a distinct genus (*Megalops*), and it is not till a further casting of the skin that the creature assumes the perfect form. As its internal parts continue to grow its external shell soon becomes too small, and is cast off,—the crab generally concealing itself until its new and greatly enlarged covering gets sufficiently hardened. This process of moulting takes place very frequently in the young crab, and gradually becomes rarer as the creature approaches its full growth, crabs being often found with oysters attached to the carapace which from their size must have grown there for three or four years. A still more remarkable power is that possessed by crabs of reproducing limbs which have been voluntarily thrown off, or have been lost by accident. This renewal only takes place when the limb has been severed at the second articulation; but when broken at any point nearer the extremity the creature generally succeeds in throwing off the part between.

Among the numerous species of crabs which abound everywhere on or near the sea-coast the following may be noticed.

(1) The Great or Edible Crab (*Cancer pagurus*), the *Carabus* of the Romans and the *Partian* of Scotland. This is one of the largest, and as an article of food is certainly the most valuable, of the short-tailed Decapoda, being everywhere esteemed for the delicacy of its flavor. It abounds chiefly on the rocky parts of the coasts of Europe, and often measures 12 inches across the carapace, weighing in the larger specimens fully 12 lb. The principal British crab-fisheries are off the north-east coast of Scotland, in the Firth of Forth, and off the Coast of Cornwall; and the home produce is largely supplemented by imports from Norway. In the capture of this crustacean "crab-pots," made of wicker-work, with the entrance at the top, and baited with dead fish, are employed. These are sunk in the proper localities, and their position indicated by a piece of cork attached to a line connected with the wicker trap. In the sheltered bays of the west of Scotland this crab is also caught in calm weather by poking it from behind with a long pole, which the crustacean immediately seizes, and which is then gently shaken, making the crab adhere all the more tenaciously, and giving the fisherman the opportunity he seeks of hoisting it into his boat. When caught, crabs are kept alive till wanted by being placed in per-

forated boxes which are then sunk at some convenient spot in the sea. Those caught off Lizard Point are conveyed to Falmouth Harbor, where they are individually branded, and put in boxes which are then placed under water. Recently it was stated on good authority, that one of those cases having gone to pieces, thus liberating the imprisoned crabs, many of them were shortly after caught again on their old feeding-ground—a distance of eleven miles from the place where they had been confined. As they had been conveyed to Falmouth by boat, it is impossible with our present knowledge to say by what sense they were thus unerringly guided on their return journey.<sup>1</sup>

(2) The Shore Crab (*Carcinus maenas*) is the species most commonly met with on all parts of the British coast. Although found in deep water, its favorite haunts are beneath the stones that lie between low and high water mark, and its awkward sidelong gait as it sidles off to its place of concealment must be familiar to the most casual observer of shore life. It is a shy creature, eluding observation beneath stones or buried in the sand, its telescopic eyes alone visible, and feigning death when unable otherwise to cope with danger. Unlike the former species, its legs, especially the posterior pair, are flattened and ciliated so as to form swimming organs. Owing probably to the small size of this species, it has obtained little prominence as an article of food, although in flavor it is said to rival the Great Crab. Large numbers, however, are eaten by the poorer classes in seaport towns, and they are also to be had in the London fish markets. They feed chiefly on the spawn of fish and the smaller crustaceans.

(3) Pea Crabs (*Pinnotheres*, Plate X. fig. 5) are small crustaceans in which the sexes so differ that the males and females were at one time described as separate species. The female is larger than the male, and its external covering is softer; and they are further remarkable in taking up their residence in the shells of living bivalve mollusks, especially in the pinna, the cockle, and the mussel. The soft-bodied female is never found outside of its adopted shell, although the harder cased male is thus occasionally met with. The Pinna Pea Crab (*Pinnotheres veterum*), which abounds in the Mediterranean, makes its home in the pinna shell, and ancient writers have given highly imaginative descriptions of the object of this alliance between crustacean and mollusk. It was believed that on the entrance of food "within the gaping circuit of the shell," the active little crab pricked the tender sides of its sluggish partner, who understanding the hint closed its shell upon the prey.

"Thus fed by mutual aid, the friendly pair  
Divide their gains, and all their plunder share."

(4) The *Inachus Kempferi*, found in Japanese waters, is the largest of known crabs. It measures 10 feet between the tips of its nippers, each of which is 5 feet in length. The body, however, is comparatively small and triangular in shape. It is said to be eaten by the Japanese.

(5) Land Crabs occur in various parts of the tropical world, and are especially abundant in the West Indies. The Violet Land Crab (*Gecarcinus ruficola*, Plate X. fig. 1) of Jamaica lives in communities and forms burrows in the ground, often two or three miles from the sea. These crabs are provided with powerful pincers, which they are not loath both to use and to lose, for when attacked they fix upon the enemy with their great claw, which is then thrown off, and as the muscles connected with it retain their tension for some time after the severance, the creature

<sup>1</sup> The male crab is generally larger than the female, especially in its claws, and is more sought after as a table delicacy; the flesh of both sexes immediately after the casting of the shell is watery and unwholesome. During moulting the female is generally guarded by a male, which if removed is shortly replaced by another, and it is after the completion of the moulting process in the female that the union of the sexes takes place. The spawn is carried for a considerable time on the abdominal appendages before being deposited, an operation which takes place in spring and summer. Recently fears were entertained that through over-fishing the stock of crabs in British waters was being seriously diminished, and a commission at present (1877) sitting was appointed to take evidence on this matter at the principal seats of the crab fishery. From the evidence already collected it appears that these fisheries are now much less productive than formerly, and that the size of the crabs has greatly diminished, while their cost has enormously increased; for while forty years ago a dozen of the largest crabs could be had for 10d., the same number of medium sized specimens now cost 3s. Those who have given evidence are generally in favor of a 5-inch gauge in order to prevent the wanton destruction of young crabs; and also of a close time; but great diversity of opinion exists as to the best season for this, although the period from the beginning of June to the end of August is that most generally recommended.

seeks to make its escape while pain is still being inflicted by the now independent claw. They remain in their burrows by day, and come forth at night in search of food, remaining about with great speed and retiring, when possible, to their holes, in the presence of danger. They renew their connection with the sea once a year, visiting it in order to deposit their spawn. They travel by night, directed by a powerful instinct which causes them to march straight for their destination, surmounting whatever difficulties may be in their way. At this season they are taken in great numbers, and their flesh is regarded as one of the chief delicacies of the island. Like their marine engorgers they cast their shell, but unlike these, it is immediately after the moulting process that they are in best condition for the table. The Calling Crab (*Galasinus tetragonon*) of Ceylon has its left claw exceedingly small, while its fellow is larger than all the rest of the body, and this it carries aloft as if brandishing a weapon (see CRUSTACEA, fig. 65); while the Racer Crab (*Ocypoda ceratophthalma*) digs deep burrows in the sandy roads of that island, sufficient to render them dangerous for horsemen, were the holes not regularly filled up by a band of laborers.

(6) The Robber Crab (*Baryx latro*) belongs to that division (*Anomura*) of the Decapod Crustaceans which forms a connecting link between crabs and lobsters, the abdominal segments not being folded beneath the breast as in true crabs. It is an inhabitant of the islands in the Indian Ocean, and makes its burrows under the cocoa-nut trees, the fruit of which forms its principal food. It was formerly supposed to ascend these trees and break off the nuts, but the researches of Darwin, Bennet, and others seem to prove that they only make use of the nuts which they find already fallen. In order to get at the edible contents of these, they strip off the fibrous envelope so as to lay bare the eye-spots, into one of which they insert the sharp edge of a claw, and by working this backward and forward they gradually scoop out the substance of the nut. According to another authority, after inserting the claw, they sometimes proceed to crack the hard shell by beating it against a stone. The fibre which they remove from the nut is employed by them in lining their burrows; it is also gathered by the natives and made into mats, etc. The Robber Crab attains a length of 2 feet, and has usually a mass of fat under the tail which, according to Darwin, often yields when melted as much as a quart of limpid oil.

(7) In the Hermit Crabs (*Pagurida*, Plate X. fig. 7) the abdomen is soft and pulpy and destitute of protecting plates, the safety of this defenceless part being provided for by the entrance of those creatures into univalve shells to which they become so closely attached by means of certain hooked appendages of the abdomen, that it is impossible to drag a Hermit Crab from its adopted shell without tearing the body asunder. The mouth of the shell is guarded by the claw, the larger pincers of some of these crabs being, says Darwin, "most beautifully adapted when drawn back to form an operculum to the shell nearly as perfect as the proper one." The most common and the largest of the British species is the Soldier Crab (*Pagurus bernhardus*, Plate X. fig. 4), to be seen at all seasons on our coasts, inhabiting a great variety of univalve shells from the tiny natica to the largest whelk, the latter being the shell usually chosen by the adult crab. It changes its residence so soon as it has outgrown the dimensions of the place, and its new premises seem to be generally selected with a view to the future growth of the creature. Dead shells appear in some cases to be thus employed, but it is believed that in most instances the crab kills the mollusk in order to secure its shell. Hermit Crabs are largely used as bait. See CRUSTACEA.

CRABBE, GEORGE (1754-1832), was born at Aldborough, in Suffolk, December 24, 1754, and was the son of an officer of the customs. He appears to have been designed by his father first for an employment similar to his own, and afterwards for the medical profession. He was apprenticed to an apothecary, and received an education merely sufficient to qualify him for such an occupation, and by no means to advance him in that literary career in which he became eventually distinguished. His poetical taste was first elicited by the casual perusal of some verses in the *Philosophical Magazine*, which his father, who was a mathematician and averse to poetry, had separated from the scientific portions of that periodical, and thrown aside, as unworthy. The spark thus kindled burnt steadily; and

even while a schoolboy he versified much, and made sundry ambitious attempts in the highest walks of composition. The attainment of a prize offered by the editor of the *Lady's Magazine* for a poem on Hope, although a humble specimen of success, sufficed to encourage him to renewed exertions; and in 1778 he quitted the profession of medicine, which he had always disliked, and repaired to London, determined to apply himself to literature. His early efforts in his new career were attended with disheartening circumstances. The first poem he offered for publication could find no publisher. From the first that was printed he obtained no profit, in consequence of the publisher's bankruptcy. It was entitled *The Candidate, a Poetical Epistle to the Authors of the Monthly Review*, and appeared anonymously in 1780. Soon afterwards he became acquainted with Burke, an acquaintance from which may be dated the dawn of his literary rise. Without an introduction, and impelled by distress, he applied to Burke, who kindly took him by the hand, afforded him the advantage of his criticism and advice, recommended him to Dodsley the publisher, invited him to his house, and made him known to many distinguished men of that time, among whom were Reynolds, Johnson, and Fox. Crabbe's first published poems, after the commencement of his acquaintance with Burke, were *The Library* and *The Village*, both of which received the benefit of Burke's observations, and the second of which was in a great measure composed at Beaconsfield. In 1784 Crabbe, who by the recommendation of Burke had been qualifying himself for holy orders, was ordained a deacon, and he took priest's orders the following year. After serving a short time as curate at Aldborough, through the influence of this generous and distinguished friend he was introduced to the duke of Rutland and became his domestic chaplain. Nor did Burke's kindness stop here; for he obtained for him from Lord Thurlow, in 1783, a presentation to the rectory of Frome St. Quintin, in Dorsetshire, which he held for six years. About this time he married, and resided for some time at Swefling, county of Suffolk, officiating as curate to the minister of Great Yarmouth. About 1789 he was presented, through the instrumentality of the duchess of Rutland, to the rectories of Muston, in Leicestershire, and West Allington, in Lincolnshire. In 1813 he was preferred to the Rectory of Trowbridge, county of Wilt, which, together with the smaller living of Croxton Kerrial, in Leicestershire, he held to the time of his death. After *The Village*, published in 1783, which had received the corrections and commendations of Dr. Johnson, Crabbe next produced *The Newspaper*, published in 1785. After this time his poetical labors were long suspended, owing probably to the dedication of his time to domestic affairs and the duties of his profession, or, as he himself ascribes it, to the loss of those early and distinguished friends who had given him the benefit of their criticism. He had, however, the satisfaction of seeing his next work, *The Parish Register*, published in 1809, read and approved by Fox. The success obtained by these poems, which far exceeded that which had attended his earlier efforts, encouraged him to write again; and in 1810 he published one of his best poems, *The Borough*, and in 1812 *Tales in Verse*. His last publication was entitled *Tales of the Hall*, and appeared in 1819. The latter years of his life he spent in the tranquil and amiable exercise of his domestic and clerical duties at his rectory of Trowbridge, esteemed and admired by his parishioners, among whom he died, after a short illness, on the 8th February, 1832, aged seventy-seven. He was buried in the chancel of Trowbridge church. Crabbe's only prose publications were a *Funeral Sermon on Charles, duke of Rutland*, preached at Belvoir, and an essay on the natural history of the vale of Belvoir, written for Nichols's *History of Leicestershire*, in which it is thankfully acknowledged. His fame rests solely on his poems, of which *The Parish Register* and *The Borough* are destined to a reputation, if not as brilliant, yet probably as enduring as that of any other contemporary productions.

Crabbe is one of the most original of our poets; and his originality is of that best kind, which displays itself not in tumid exaggeration or flighty extravagance—not in a wide departure from the sober standard of truth—but in a more rigid and uncompromising adherence to it than inferior writers venture to attempt. He is pre-eminently the poet of reality in humble life; and to its representation he has applied himself with a rigorous fidelity which

startled the timid fastidiousness of many readers. He discarded the aid of those pleasing illusions with which humble life had previously been enveloped; condemned as fictitious the prevalent representations, and in their stead fearlessly exhibited the stern, harsh, naked truth, and determined to rely for popularity on the fidelity and rigor of his delineations. His chief characteristics are force and accuracy, and through these and the originality of his style he compels us to bestow our attention on objects that are usually neglected. His poetry, unlike that of others, directs our sympathy where it is well for the cause of humanity that it should be directed, but whence the squalidness of misery and want too frequently repels it. Much of his success arises from his graphic delineation of external objects, but more from his knowledge of the human heart, and his powerful treatment of the passions. Both the milder and the more violent emotions are portrayed with ability, but in the latter he is most strikingly successful. Deep despair and remorse are exhibited with a tragic strength that has been rarely equalled; and madness has been seldom drawn with a more powerful hand than in his poem of *Sir Eustace Grey*. He has been called the satirist of the poor, but we must be careful lest we attach to this expression too harsh an acceptation. It is true he discourteously discounts those romantic day-dreams which associate virtue inseparably with poverty, and an Arcadian innocence with rural life. He shows that demoralization is the attendant of distress, and that villagers may be equally dissipated and more dishonest than the profligates of a wealthier class; but he shows this in a spirit rather of pity than of anger; and whilst he denounces and exposes crime, he makes us interested not so much in its punishment as, what is still better, in its prevention. He spares not the vices of the poorer classes, but at the same time he does more justice to their virtues, and renders them more important objects of consideration than perhaps any other imaginative writer.

With many sterling merits as a poet, Crabbe has numerous defects. His descriptions are forcible and exact, but they are too detailed. They have too much of the minuteness of a Dutch picture, and it is a minuteness exhibited in the representation of disgusting objects. He never shrinks from the irksome task of threading the details of vice and misery. Abject depravity is a too favorite object of his pen, and he does not seem sufficiently aware that there is a species of wickedness which counteracts our sympathy with suffering, and a degree of insignificance which extinguishes our interest in guilt. His skill in displaying the morbid anatomy of our moral nature has rendered him too prone to that unpleasing exercise of his talents, and his habit of tracing the deformities of character has given to his expositions too much the appearance of invective. His taste is very inferior to his other powers. Even with subjects naturally pleasing he is apt to blend disagreeable images. His descriptions of natural scenery, graphic as they are, have little in them of elevation. There is no genial glow about them as if the contemplation of nature had warmed and inspired him. His deficiency of taste displays itself also sometimes in his humor, which is apt to verge upon buffoonery. His style is little to be commended. It is too often clumsy and ungraceful,—diffuse without freedom, homely without being easy, and antithetical without being pointed. His diction is frequently harsh and quaint, and compels us to feel that the merit of his works resides rather in their ideas than in the dress in which he clothes them. His lines are deficient in refinement and polish, and frequently offend the ear by something uncouth and prosaic in the sound, and the absence of musical rhythm. Such are the defects which have conduced to deprive him of that popularity which his merits would otherwise have obtained for him.

(T. H. LI.)

A complete edition of Crabbe's works was published in 1834, in 8 volumes 12mo, the first volume containing his Life by his son, the Rev. George Crabbe. A reprint, in one volume royal 8vo, was issued in 1867.

**CRACOW** (Polish, *Krakow*; German, *Krakau*), a city of the crownland of Galicia, Austria, the capital anciently

of Poland, and more recently of a small Polish republic which bordered on the Prussian, Austrian, and Russian dominions where they meet. The city stands in a fertile plain on the left bank of the Vistula, where the stream of the Budowa joins it, nearly 200 miles north-east of Vienna, in latitude (of observatory) 50° 3' 50'' N., longitude 19° 57' 30'' E., and at an elevation of 650 feet above the sea. The main railway line of Galicia, called the Carl Ludwig's Bahn, uniting the system of Germany along the outskirts of the Carpathian range with the lines about the Lower Danube, crosses the Vistula at Cracow. A line of detached forts has been built round the city, and a castle on a height commands the town. Promenades occupying the place of the old walls, planted with trees, divide the old town from the seven extensive suburbs of Stradom, Ribaki, Kalepara, Piasek, Wesola, Smolensk, and Wielopole; and an arm of the Vistula cuts off the Jewish quarter of Kasimierz. In the old town the extensive castle of the Polish kings on the rock of Wawel, dating from the 14th century, has been for



Plan of Cracow.

- |                      |                        |
|----------------------|------------------------|
| 1. Floriane Gate.    | 8. Bishop's Palace.    |
| 2. Cloth Hall.       | 9. St. Peter's.        |
| 3. St. Mary's.       | 10. New Theatre.       |
| 4. St. Barbara's.    | 11. Summer Theatre.    |
| 5. University.       | 12. Observatory.       |
| 6. Dominican Church. | 13. Cathedral.         |
| 7. St. Francis's.    | 14. Military Hospital. |

the most part rebuilt to serve as barracks and for a hospital. The Stanislas Cathedral (Lady Church), built in 1359, contains many interesting antiquities relating to the kingdom of Poland; the monarchs were crowned in this edifice, which also holds the mausoleum of the Sigismunds, the silver coffin of the holy Stanislas, and the remains of John Sobieski, of Poniatowski, and of Kosciuszko; it is adorned by sculptures by Thorwaldsen, and a wooden carved altar (1472-1484) by Veit Stoss, who was a native of Cracow. There are forty churches in the city, with twenty-three convents of monks and nuns. In the Ringplatz stand the old Gothic cloth booths and the ancient Rathhaus with a fine tower. A relic of the old wall remains in the Floriane gate on the esplanade. The university of Cracow, founded by Casimir the Great, and carried out by Jagellon in 1401, has sixty-nine professors and about 450 students, and possesses a library of 140,000 volumes and numerous MSS. Attached to it are an observatory, botanic gardens, natural, historical, and medical museums, a labor

atory, and medical schools. Cloth, leather, and agricultural implements are manufactured to some extent in Cracow, and a busy traffic in grain, wood, salt, wine, linen, and pigs is carried on by the Vistula. In the neighborhood there are coal and zinc mines. Besides a bridge over the old Vistula, the Franz Joseph Bridge on five stone piers and the railway bridge cross the river to the villages of Podgorze and Stawisko on the opposite bank. Three miles north-west of Cracow a huge mound 125 feet in height was raised in 1824 to the memory of Kosciusko, and this has now been utilized as the site of a fort. The village of Krzeszowice in this direction is a favorite resort of Cracow people, and has a fine castle, a Gothic church, sulphur baths, and iron and zinc mines. Eight miles south-east of Cracow, united to it by a branch railway, are the village and famous salt-mines of Wieliczka; about 1000 miners are constantly employed here, and the annual yield of salt amounts to more than a million cwts. Population (1869), 49,835, including about 10,000 Jews.

Cracow takes its name from the Polish Prince Krak or Krakus, and dates from about the year 700. Perhaps no city has suffered greater vicissitudes. It was taken in 1039 by the Bohemians, in 1241 by the Mongols, by the Swedes in 1655 and in 1702, and by the Russians in 1768. It remained the capital of Poland from 1320 till 1609, when the seat of government was transferred to Warsaw, but the kings of Poland were crowned in it till 1764. On the third partition of Poland in 1795 Austria took possession of this portion; but in his campaign of 1809 Napoleon wrested it from that power, and incorporated it with the duchy of Warsaw, which was placed under the rule of Saxony. In the campaign of 1812 the Emperor Alexander made himself master of this and the other territory which formed the duchy of Warsaw. At the general settlement of the affairs of Europe by the great powers in 1815, it was agreed that Cracow and the adjoining territory should be formed into a free state; and, by the General Treaty of Congress signed at Vienna in 1815, "the town of Cracow with its territory, is declared to be for ever a free, independent, and strictly neutral city, under the protection of Russia, Austria, and Prussia." In February, 1846, however, an insurrection broke out in Cracow, apparently a ramifications of a widely-spread conspiracy throughout Poland. The senate and the other authorities of Cracow were unable to subdue the rebels or to maintain order, and, at their request, the city was occupied by a corps of Austrian troops for the protection of the inhabitants. The three powers, Russia, Austria, and Prussia, made this a pretext for extinguishing this independent state; and having established a conference at Vienna (November, 1846) the three courts after due deliberation, contrary to the assurance previously given, and in opposition to the expressed views of the British and French Governments, came to the conclusion to extinguish the state of Cracow and to incorporate it with the dominions of Austria.

CRAIG, JOHN (c. 1512-1600) one of the Scottish Reformers, was born about 1512. He was educated at the university of St. Andrews, and entered the Dominican order. But, being suspected of heresy, he was cast into prison. Retiring to the Continent, he obtained the patronage of Cardinal Pole, and for some years taught in Dominican schools, and performed other services for the order. He was converted to Protestantism by the *Institutes* of Calvin, and having made a brave confession of his heresy before the Inquisition, he was condemned to be burnt. But on the eve of his execution Pope Paul IV. died, and the mob broke open the prisons. Craig fled to Vienna, and the emperor, Maximilian II., refused to surrender him to the Inquisition. He now returned to his native country, and after preaching for some time in Edinburgh became coadjutor to Knox. It was he who proclaimed the banns of marriage between Queen Mary and Bothwell, but he openly denounced their union. On the death of Knox in 1572 he naturally succeeded to the leadership of the Scottish Church. He took the most prominent part in drawing up the *Second Book of Discipline*, and he was the author of the *First Covenant*, otherwise called the *King's Confession* (1581), and of *Craig's Catechism* (1592), which was for half a century in general use in Scotland. But though he was bold enough to rebuke the king in his sermons, he yielded to his commands, and signed a declaration, promising obedience to the bishops and submission to an Act that had been passed forbidding the assembling of church courts without royal license. Craig's coadjutor and successor was Andrew Melville.

CRAIG, SIR THOMAS (c. 1538-1608), of Ricarton, one of the earliest and one of the ablest writers on the law of Scotland, and a poet of some note, was born about the year

1538. It is probable that he was the eldest son of William Craig of Craigfintray, or Craigston, in Aberdeenshire, but beyond the fact that he was in some way related to the Craigfintray family nothing regarding his birth is known with certainty. He is first heard of as a student at St. Andrews, where he was entered at St. Leonard's College in 1552, and where he took the B. A. degree in 1555. From St. Andrews he went to France, like most of his countrymen of that day who were destined for the bar, to study the canon and the civil law. He himself makes more than one allusion in his works to what he had learned at Paris, but as the civil law was not at that time publicly taught there, it is more than probable that he attended the lectures of the great civilians of some of the other French schools. He returned to Scotland about 1561, and, after spending some time in acquiring a practical acquaintance with the forms of court procedure, was admitted advocate in February, 1563. In 1564 he was appointed justice-depute by the justice-general, Archibald, earl of Argyll; and in this capacity he presided at many of the criminal trials of the period. He is not mentioned as deputy of the justice-general after 1573; and in the course of the following year he appears as sheriff of Edinburgh, so that he probably resigned the one office on being nominated to the other. In 1606 he is described as procurator for the church; and this completes the list of his regular preferments, although his name is found in more than one commission of importance. He never became a Lord of Session, a circumstance that was unquestionably due to his own choice. His extensive practice, added to the emoluments of his various offices, no doubt, much exceeded what he would have had as a judge; but in truth he probably felt that his studious and retiring disposition unfitted him for the rough work, diplomatic and military as well as judicial, that was in those days expected of a Scotch judge. In this respect he presents a striking contrast to his contemporary Balfour, who was implicated in every conspiracy of his time, and to whom no office, judicial, ecclesiastical, or military, came amiss. Craig even, it is said, refused the honor of knighthood which the king wished to confer on him in 1604, when he came to London as one of the Scottish commissioners regarding the union between the kingdoms—the only political object he seems to have cared about; but in accordance with James's commands he has always been styled and reputed a knight. Craig was married to Helen, daughter of Heriot of Trabrown in Haddingtonshire, by whom he had four sons and three daughters. His eldest son, Sir Louis Craig, was raised to the bench in 1604, and among his other descendants are several well known names in the list of Scotch lawyers. He died on the 26th February, 1608.

The greatest of Craig's literary labors is his treatise on the feudal law. The object of the *Jus Feudale* was to assimilate the laws of England and Scotland, but instead of this, it is the first, and by no means the least, in the series of works which has built up and solidified that of Scotland into a separate system. Craig's anxiety to promote the union of the kingdoms led him to prepare two other elaborate treatises,—the *De Unionis Regnorum Britannia Tractatus*, and the *De Jure Successionis Regni Anglia*. But while he was alive to the benefits of union, his *De Hominio Disputatio*, in which he combats the assertion that Scotland was a fief of the English crown, shows that he was no less determined to maintain the historical independence of his country. Craig's first poem appeared in 1565. It is an *Epithalamium* in honor of the ill-fated marriage of the Queen and Darnley. It contains passages of real poetic feeling, but as a whole it is labored and heavy; and this fault, as perhaps might be expected of a learned feudal lawyer, more or less disfigures all Craig's subsequent efforts.

Except his poems, none of Craig's works appeared during his lifetime, and some of them exist even now only in manuscript. The first edition of the *Jus Feudale* was not published until 1655, nearly fifty years after its author's death. It was edited by Robert Burnet of Crimond, afterwards a judge in the Court of Session, who had married Craig's granddaughter, and was the father of the famous bishop of Salisbury. A second edition, edited by Menckenius, was published at Leipzig, 1716, while the last and best edition appeared at Edinburgh in 1732, with a short life by the editor, James Baillie. Manuscripts of the *De Jure Successionis* belong to the Advocates' Library and to the Edinburgh University Library, but the book itself has never been published. A translation of it by James Gethera

afterwards a Scotch bishop, appeared in 1703. The *De Unione* exists only in manuscript, in the Advocates' Library; and the same is true of the *De Homino*, although a translation of it, under the title *Scotland's Sovereignty asserted*, was published by George Ridpath, London, 1695. Most of the poems have been reprinted in the *Delicia Poetarum Sotorum*. There is an excellent life of Craik by Mr. Fraser Tytler, Edinburgh, 1823.

CRAIK, GEORGE LILLIE (1799—1866), professor of English literature at Queen's College, Belfast, was the son of a schoolmaster in Fifeshire. He studied at the university of St. Andrews with the intention of entering the church, but altering his plans, removed to London, at the age of twenty-five, to devote himself to literature. He became connected with a short-lived literary paper called the *Verulam*; in 1831 he published his *Pursuit of Knowledge under Difficulties* among the works of the Society for the Diffusion of Useful Knowledge; he contributed a considerable number of biographical and historical articles to the *Penny Cyclopædia*; and he edited the *Pictorial History of England*, himself writing much of the work. In 1844 he published his *History of Literature and Learning in England from the Norman Conquest to the Present Time*, illustrated by extracts, and in the same year his *History of British Commerce from the Earliest Times*. In the next year appeared his *Spenser and his Poetry*, an abstract of Spenser's poems, with historical and biographical notes and frequent quotations; and in 1837 his *Bacon, his Writings and his Philosophy*, a work of a similar kind. The four last-mentioned works appeared among *Knights' Weekly Volumes*. Two years later Craik obtained the chair of history and English literature at Queen's College, Belfast, a position which he held till his death, which took place on the 23d February, 1866. Besides the works already noticed, Craik published the *Romance of the Peerage, Outline of the History of the English Language, and The English of Shakespeare*.

CRAIL, formerly CARRAIL, a royal and parliamentary burgh and seaport of Scotland, in the county of Fife, nine miles south-east of St. Andrews. It is said to have been a town of some note as early as the ninth century; and its castle, of which there are hardly any remains, was the residence of David I. and others of the early Scottish kings. It was constituted a royal burgh by a charter of Robert Bruce in 1306, and had its privileges confirmed by Robert II. in 1371, by Mary in 1553, and by Charles I. in 1635. Of its priory, dedicated to St. Rufus, a few ruins are to be seen below the east end of the town; its principal church is of great antiquity, and was raised to the collegiate rank in 1517; and many of the ordinary houses are of a massive and antique description. It unites with St. Andrews and other burghs in returning a member to Parliament. Population of burough, 1112.

CRANE, a genus of birds belonging to the order *Grallæ* of which the Corn Crane (*Ortygometra crex*) is the most familiar example. This bird is a summer visitor to Britain and to Northern Europe generally, where its migrations extend as far north as Iceland. It reaches Britain in April, and leaves in October, having meanwhile raised a brood of young. It frequents rich meadows and green corn-fields in the neighborhood of water, where its presence is made known by the peculiar creaking sound emitted by the male as a call note to the female. After mating their *crek-crek*, not unlike the noise made by passing the nail of the finger over the teeth of a small comb, is much seldomer heard, and the work of building the nest, which is a simple structure formed of dried plants placed on the ground, is proceeded with. The eggs, from seven to fourteen in number, are about 1½ inches in length and an inch in breadth, and are of a slightly reddish-white color spotted and speckled with reddish-brown. The young cranes are covered at first with a black down, but soon assume their feathers, and are able to fly in six weeks. The upper plumage of the male is for the most part a yellowish brown, each feather being marked with a central streak of a darker color, and the under surface a pale buff transversely barred with reddish-white. The Corn Crane, or Land Rail, as it is sometimes called, feeds on snails, slugs, worms, and seeds. It is a shy and timid bird, seeking safety in concealment among the rank herbage which it frequents, and through which it runs with amazing rapidity; its note may thus be heard in quick succession proceeding from the most diverse parts of the same field, a circumstance which seems to have suggested the idea that the Crane possessed for protective purposes a certain

ventriloquial power. It seldom takes wing unless driven to it, and then flies slowly, with its legs hanging down, to the nearest place of concealment, and is thus much oftener heard than seen. In common with many other animals it is said to feign death as a means of avoiding a threatened danger. As an article of food the Corn Crane is regarded as a great delicacy. The Spotted Crane (*Ortygometra porzana*), a smaller and more aquatic species, is much less common in Britain than the former, from which it is readily distinguished by the numerous white spots on the upper surface of its plumage. It breeds on marshy ground, frequently at the water's edge. The Little Crane and Baillon' Crane both occur in Britain as rare summer visitors.

CRAMP, a painful spasmodic contraction of muscles, most frequently occurring in the limbs, but also apt to affect certain internal organs. This disorder belongs to the class of diseases known as local spasms, of which other varieties exist in such affections as spasmodic asthma and colic. The cause of these painful seizures resides in the nervous system, and operates either directly from the great nerve centres, or, as is generally the case, indirectly by reflex action, as, for example, when attacks are brought on by some derangement of the digestive organs.

In its most common form, that of cramp in the limbs, this disorder comes on suddenly, often during sleep, the patient being aroused by an agonizing feeling of pain in the calf of the leg or back of the thigh, accompanied in many instances with a sensation of sickness or faintness from the intensity of the suffering. During the paroxysm the muscular fibres affected can often be felt gathered up into a hard knot. The attack in general lasts but a few seconds, and then suddenly departs, the spasmodic contraction of the muscles ceasing entirely, or, on the other hand, relief may come more gradually during a period of minutes or even hours. A liability to cramp is often associated with a rheumatic or gouty tendency, but occasional attacks are common enough apart from this, and are often induced by some peculiar posture which a limb has assumed during sleep. Exposure of the limbs to cold will also bring on cramp, and to this is probably to be ascribed its frequent occurrence in swimmers. Cramp of the extremities is also well known as one of the most distressing accompaniments of cholera. It is likewise of frequent occurrence in the process of parturition, just before delivery.

This painful disorder can be greatly relieved and often entirely removed by firmly grasping or briskly rubbing the affected part with the hand, or by anything which makes an impression on the nerves, such as warm applications. Even a sudden and vigorous movement of the limb will often succeed in terminating the attack.

What is termed cramp of the stomach, or gastralgia, usually occurs as a symptom in connection with some form of gastric disorder, such as aggravated dyspepsia, or actual organic disease of the mucous membrane of the stomach, and must be dealt with in reference to those particular ailments.

The disease known as *Writer's Cramp*, or *Scrivener's Palsy*, is a spasm which affects certain muscles when engaged in the performance of acts, the result of education and long usage, and which does not occur when the same muscles are employed in acts of a different kind. This disorder owes its name to the relative frequency with which it is met with in persons who write much, although it is by no means confined to them, but is liable to occur in individuals of almost any handicraft. It has been termed by Dr. Duchenne *Functional Spasm*.

The symptoms are in the first instance a gradually increasing difficulty experienced in conducting the movements required for executing the work in hand. Taking, for example, the case of writers, there is a feeling that the pen cannot be moved with the same freedom as before, and the handwriting is more or less altered in consequence. At an early stage of the disease the difficulty may be to a large extent overcome by persevering efforts, but ultimately, when the attempt is persisted in, the muscles of the fingers and occasionally also those of the forearm, are seized with spasm or cramp, so that the act of writing is rendered impossible. Sometimes the fingers instead of being cramped move in a disorderly manner and the pen cannot be grasped, while in other rare instances a kind of paralysis affects the muscles of the fingers, and they are powerless to make the movements necessary for holding the pen. It is to be noted that it is only in the act of

writing that these phenomena present themselves, and that for all other movements the fingers and arms possess their natural power. The same symptoms are observed and the same remarks apply *mutatis mutandis* in the case of musicians, artists, composers, seamstresses, tailors, and many mechanics in whom this affection may occur. Indeed, although actually a rare disease, no muscle or group of muscles in the body which is specially called into action in any particular occupation is exempt from liability to this functional spasm. Hence the cause has been ascribed to over-use of the parts concerned, although this is regarded as doubtful by many high authorities, since cases have been observed where there had been no excessive strain upon the function of the affected muscles, while again in persons who pursue their special occupation, even to the utmost possible amount of fatigue, the symptoms of this disorder are exceedingly rare. It is, however, difficult to account for the phenomena on any other theory, and at all events the complaint is greatly aggravated by over-exertion of the parts.

In the treatment of this complaint the only effectual remedy is absolute cessation from the work with which the attack is associated. It is sometimes recommended that the opposite hand or limb be used so as to afford the affected part entire rest, but this is generally followed with the extension of the disease to that locality also. Peculiar forms of penholder and other mechanical contrivances have been suggested so as to enable the occupation to be carried on, but they do not afford any relief to the disease, for the cure of which the only means that can be relied on is entire rest. (J. O. A.)

CRANACH, LUCAS (1472-1553), one of the representative painters of Germany at the time of the Reformation, was born at Cronach in Upper Franconia, and learnt the art of drawing from his father. It has not been possible to trace his descent or the name of his parents. We are not informed as to the school in which he was taught, and it is a mere guess that he took lessons from the South German masters to whom Mathew Grunewald owed his education. But Grunewald practised at Bamberg and Aschaffenburg, and Bamberg is the capital of the diocese in which Cronach lies. According to Gunderam, the tutor of Cranach's children, Cranach signaled his talents as a painter before the close of the 15th century. He then drew upon himself the attention of the elector of Saxony, who attached him to his person in 1504. The records of Wittenberg confirm Gunderam's statement to this extent, that Cranach's name appears for the first time in the public accounts on the 24th of June, 1504, when he drew 50 gulden for the salary of half a year, as *pictor ducalis*. The only clue to Cranach's settlement previous to his Wittenberg appointment is afforded by the knowledge that he owned a house at Gotha, and that Barbara Brengbier, his wife, was the daughter of a burgher of that city. Of his skill as an artist we have sufficient evidence in a picture dated 1504 (Fiedler collection at Berlin), preserved till lately in the Sciarra Colonna Palace at Rome. But as to the development of his manner prior to that date we are altogether in ignorance. In contrast with this obscurity is the light thrown upon Cranach after 1504. We find him active in several branches of his profession,—sometimes a mere house-painter, more frequently producing portraits and altar-pieces, a designer on wood, an engraver of copper-plates, and draughtsman for the dies of the electoral mint. Early in the days of his official employment he startled his master's courtiers by the realism with which he painted still life, game, and antlers on the walls of the country palaces at Coburg and Lochau; his pictures of deer and wild boar were considered striking, and the duke fostered his passion for this form of art by taking him out to the hunting-field, where he sketched "his grace" running the stag, or Duke John sticking a boar. Before 1508 he had painted several altar-pieces for the Schlosskirche at Wittenberg in competition with Dürer, Burgkmair, and others; the duke and his brother John were portrayed in various attitudes, and a number of the best woodcuts and copper-plates were published. Great honor accrued to Cranach when he went in 1509 to the Netherlands, and took sittings from the Emperor Maximilian and the boy who afterwards became Charles V. Till 1508 Cranach signed his works with the initials of his name. In that year the elector gave him the winged snake as a motto, and this motto or *Kleinod*, as it was called, superseded the initials on all his pictures after that date.

Somewhat later the duke conferred on him the monopoly of the sale of medicines at Wittenberg, and a printer's patent with exclusive privileges as to copyright in Bibles. The presses of Cranach were used by Luther. His chemist's shop was open for centuries, and only perished by fire in 1871. Relations of friendship united the painter with the Reformers at a very early period; yet it is difficult to fix the time of his first acquaintance with Luther. The oldest notice of Cranach in the Reformer's correspondence dates from 1520. In a letter written from Worms in 1521, Luther calls him his gossip, warmly alluding to his "Gevaterin," the artist's wife. His first engraved portrait by Cranach represents an Augustine friar, and is dated 1520. Five years later the monk dropped the cowl, and Cranach was present as "one of the council" at the betrothal festival of Luther and Catherine Bora. The death at short intervals of the Electors Frederick and John (1525 and 1532) brought no change in the prosperous situation of the painter; he remained a favorite with John Frederick I., under whose administration he twice (1537 and 1540) filled the office of burgomaster of Wittenberg. But 1547 witnessed a remarkable change in these relations. John Frederick was taken prisoner at the battle of Mühlberg, and Wittenberg was subjected to stress of siege. As Cranach wrote from his house at the corner of the market-place to the Grand Master Albert of Brandenburg at Königsberg to tell him of John Frederick's capture, he showed his attachment by saying, "I cannot conceal from your Grace that we have been robbed of our dear prince, who from his youth upwards has been a true prince to us, but God will help him out of prison, for the Kaiser is bold enough to revive the Papacy, which God will certainly not allow." During the siege Charles bethought him of Cranach, whom he remembered from his childhood, and summoned him to his camp at Pistritz. Cranach came, reminded his majesty of his early sittings as a boy, and begged on his knees for kind treatment to the Kurfürst. Three years afterwards, when all the dignitaries of the empire met at Augsburg to receive commands from the emperor, and when Titian at Charles's bidding came to take the likeness of Philip of Spain, John Frederick asked Cranach to visit the Swabian capital; and here for a few months he was numbered amongst the household of the captive elector, whom he afterwards accompanied home in 1552. He died at Weimar, in October, 1553.

The oldest extant picture of Cranach, the Rest of the Virgin during the Flight in Egypt, marked with the initials L. C., and the date of 1504 (Mr. Fiedler, Berlin), is by far the most graceful creation of his pencil. It is enlivened by a host of angels ministering in the pleasant way to the wants of the infant Saviour. The scene is laid on the margin of a forest of pines, and discloses the habits of a painter familiar with the mountain scenery of Thuringia. There is more of gloom in landscapes of a later time; and this would point to a defect in the taste of Cranach, whose stag-hunts (Moritzburg, Madrid, Labouchere collection) are otherwise not unpleasing. Cranach's art in its prime was doubtless influenced by causes which but slightly affected the art of the Italians, but weighed with potent consequence on that of the Netherlands and Germany. The business of booksellers who sold woodcuts and engravings at fairs and markets in Germany naturally satisfied a craving which arose out of the paucity of wall-paintings in churches and secular edifices. Drawing for woodcuts and engraving of copper-plates became the occupation of artists of note, and the talents devoted in Italy to productions of the brush were here monopolized for designs on wood, or on copper. We have thus to account for the comparative unproductiveness as painters of Dürer and Holbein, and at the same time to explain the shallowness apparent in many of the later works of Cranach; but we attribute to the same cause also the tendency in Cranach to neglect effective color and light and shade for strong contrasts of flat tint. Constant attention to mere contour and to black and white appears to have affected his sight, and caused those curious transitions of pallid light into inky grey which often characterize his studies of flesh; whilst the mere outlining of form in black became a natural substitute for modelling and chiaroscuro. There are, no doubt, some few pictures by Cranach in which the flesh-tints display brightness and enamelled surface, but they are quite exceptional. As a composer Cranach was not greatly gifted. His ideal of the human

shape was low; but he showed some freshness in the delineation of incident, though he not unfrequently bordered on coarseness. His copper-plates and woodcuts are certainly the best outcome of his art; and the earlier they are in date the more conspicuous is their power. Striking evidence of this is the St. Christopher of 1506, or the plate of Elector Frederick praying before the Madonna (1509). It is curious to watch the changes which mark the development of his instincts as an artist during the struggles of the Reformation. At first we find him painting Madonnas. His first woodcut (1505) represents the Virgin and three saints in prayer before a crucifix. Later on he composes the marriage of St. Catherine, a series of martyrdoms, and scenes from the Passion. After 1517 he illustrates occasionally the old gospel themes, but he also gives expression to some of the thoughts of the Reformers. In a picture of 1518 at Leipzig, where a dying man offers "his soul to God, his body to earth, and his worldly goods to his relations," the soul rises to meet the Trinity in heaven, and salvation is clearly shown to depend on faith and not on good works. Again sin and grace become a familiar subject of pictorial delineation. Adam is observed sitting between John the Baptist and a prophet at the foot of a tree. To the left God produces the tables of the law, Adam and Eve partake of the forbidden fruit, the brazen serpent is reared aloft, and punishment supervenes in the shape of death and the realm of Satan. To the right, the Conception, Crucifixion, and Resurrection symbolize redemption, and this is duly impressed on Adam by John the Baptist, who points to the sacrifice of the crucified Saviour. There are two examples of this composition in the Galleries of Gotha and Prague, both of them dated 1529. One of the latest pieces with which the name of Cranach is connected is that which Cranach's son completed in 1555, and which is now in the cathedral of Weimar. It represents Christ in two forms, to the left trampling on Death and Satan, to the right crucified, with blood flowing from the lance wound. John the Baptist points to the suffering Christ, whilst the blood stream falls on the head of Cranach, and Luther reads from his book the words, "The blood of Christ cleanseth from all sin." Cranach sometimes composed gospel subjects with feeling and dignity. The Woman taken in Adultery at Munich is a favorable specimen of his skill, and various repetitions of Christ receiving little children show the kindness of his disposition. But he was not exclusively a religious painter. He was equally successful, and often comically naïve, in mythological scenes, as where Cupid, who has stolen a honeycomb, complains to Venus that he has been stung by a bee (Weimar, 1530, Berlin, 1534), or where Hercules sits at the spinning-wheel mocked by Omphale and her maids. Humor and pathos are combined at times with strong effect in pictures such as the Jealousy (Augsburg, 1527, Vienna, 1530), where women and children are huddled into telling groups as they watch the strife of men wildly fighting around them. Very realistic must have been a lost canvas of 1545, in which hares were catching and roasting sportmen. In 1546, possibly under Italian influence, Cranach composed the Fons Juventutis of the Berlin Gallery, executed by his son, a picture in which ugs are seen entering a Renaissance fountain, and are received as they issue from it with all the charms of youth y knights and pages.

Cranach's chief occupation was that of portrait-painting, and we are indebted to him chiefly for the preservation of the features of all the German Reformers and their princely adherents. But he sometimes condescended to depict such noted followers of the Papacy as Albert (Kur-Mainz) of Brandenburg, Anthony Granvelle, and the duke of Alva. A dozen of likenesses of Frederick III. and his brother John are found to bear the date of 1532. It is characteristic of Cranach's readiness, and a proof that he possessed ample material for mechanical reproduction, that he received payment at Wittenberg in 1533 for "sixty pairs of portraits of the elector and his brother" in one day. Amongst existing likenesses we should notice as the best that of Albert, elector of Mainz, in the Berlin museum, and that of John, elector of Saxony, in the museum of Weimar.

Cranach had three sons, all artists:—John Lucas, who died at Bologna in 1536; Hans Cranach, whose life is obscure; and Lucas, born in 1515, who died in 1586. Hans von Cranach, now commanding the fortress of

Cologne, is one of the last descendants of the painter of Wittenberg.

See Heller, *Leben und Werke Lukas Cranachs* (1821), and Schuchard, *Lukas Cranachs des Ältern Leben und Werke* (3 vols., 1851-71). (J. A. C.)

CRANBERRY, the fruit of plants of the genus *Oxycoccus*, natural order *Vacciniaceæ*. *O. palustris*, the common cranberry plant, is found in marshy land in northern and central Europe and North America. Its stems are wiry, creeping, and of varying length; the leaves are evergreen, dark and shining above, glaucous below, revolute at the margin, ovate, lanceolate, or elliptical in shape, and not more than half an inch long; the flowers, which appear in May or June, are small and pedunculate, and have a four-lobed, rose-tinted corolla, purplish filaments, and anther-cells forming two long tubes; the berries ripen in August and September; they are pear-shaped and about the size of currants, are crimson in color, and often spotted, and have an acid and astringent taste. The American species, *O. macrocarpus*, is found wild from Maine to the Carolinas. It attains a greater size than *O. palustris*, and bears bigger and finer berries, which are of three principal sorts, the cherry or round, the bugle or oblong, and the pear or bell-shaped, and vary in hue from light pink to dark purple, or may be mottled red and white. It was first cultivated in England for the sake of its fruit by Sir Joseph Banks. *O. erectus* is a species indigenous to Virginia and California, and is remarkable for the excellent flavor of its berry.

Air and moisture are the chief requisites for the thriving of the cranberry plant. It is cultivated in America on a soil of peat or vegetable mould, free from loam and clay, and cleared of turf, and having a surface layer of clean sand. The sand, which needs renewal every two or three years, is necessary for the vigorous existence of the plants, and serves both to keep the underlying soil cool and damp, and to check the growth of grass and weeds. The ground must be thoroughly drained, and should be provided with a supply of water and a dam for flooding the plants during winter to protect them from frost, and occasionally at other seasons to destroy insect pests; but the use of spring-water should be avoided. The flavor of the fruit is found to be improved by growing the plants in a soil enriched with well-rotted dung, and by supplying them with less moisture than they obtain in their natural habitats. Propagation is effected by means of cuttings, of which the wood should be wiry in texture, and the leaves of a greenish-brown color. In America, where, in the vicinity of Cape Cod, Massachusetts, the cultivation of the cranberry commenced early in the present century, wide tracts of waste land have been utilized for that purpose,—low, easily flooded, marshy ground, worth originally not more than from \$10 to \$20 an acre, having been made to yield annually \$200 or \$300 worth of the fruit per acre. The yield varies between 50 and 400 bushels an acre, but 100 bushels, or about 35 barrels, is estimated to be the average production when the plants have begun to bear well. In 1871 there were in New Jersey about 2000 acres in fruiting, which in the previous year had produced 150,000 bushels of cranberries, and 4000 acres more had been prepared and planted. A total of 75,000 barrels was obtained in 1869 in the States and Territories of America. Cranberries should be gathered when ripe and dry, otherwise they do not keep well. The darkest-colored berries are those which are most esteemed. The picking of the fruit begins in New Jersey in October, at the close of the blackberry and whortleberry season, and often lasts until the coming in of cold weather. From 3 to 4 bushels a day may be collected by good workers. New York, Philadelphia, Boston, and Baltimore are the leading American markets for cranberries, whence they are exported to the West Indies, England, and France in great quantities. England was formerly supplied by Lincolnshire and Norfolk with abundance of the common cranberry, which it now largely imports from Sweden and Russia. The fruit is much used for pies and tarts, and also for making an acid summer beverage. The Mount Ida berry, cowberry, or red whortleberry, *Vaccinium Vitis idæa*, is sometimes sold for the cranberry. The Tasmanian and the Australian cranberries are the produce respectively of *Astroloma humifusum* and *Lissanthe sapida*, plants of the order *Epacridaceæ*.

See Trowbridge, *The Cranberry Cultivist*, Newhaven, U. S., 1869; *Report of the Commissioner of Agriculture for 1869*, Wash-

ington, 1870; *Report of the American Institute of New York, for 1869-70*, Albany, 1870.

CRANBROOK, a town of England, in the county of Kent, six miles south of the Staplehurst station, on the South-Eastern Railway. It has a fine church dedicated to St. Dunstan, which is remarkable for a baptistry in which the ceremony used to be administered by immersion. As the central town of the agricultural district called the Weald of Kent, it carries on a pretty extensive trade in malt, hops, and general goods; but its present condition is in striking contrast to the activity it displayed from the 14th to the 17th century, when it was one of the principal seats of the broadcloth manufacture. In the neighborhood are the ruins of the old mansion house of Sissinghurst, or Saxonhurst, built by Sir John Baker in the time of Edward VI., and interesting as the birthplace of Sir Richard Baker the chronicler. Population of the parish in 1871, 4331.

CRANE (in Dutch, *Kraan*; Old German, *Kraem*; cognate, as also the Latin *Grus*, and consequently the French *Grue* and Spanish *Grulla*, with the Greek *γρᾰνος*), the *Grus communis* or *G. cinerea* of ornithologists, one of the largest Wading-birds, and formerly a native of England, where Turner, in 1544, said that he had very often seen its young ("*caerum pipiones sapsissime vidi*"). Notwithstanding the protection afforded it by sundry Acts of Parliament, it has long since ceased from breeding in this country. Sir T. Browne (*ob.* 1682) speaks of it as being found in the open parts of Norfolk in winter. In Ray's time it was only known as occurring at the same season in large flocks in the fens of Lincolnshire and Cambridgeshire; and though mention is made of Cranes' eggs and young in the fen-laws passed at a court held at Reveby in 1780, this was most likely but the formal repetition of an older edict; for in 1768 Pennant wrote that after the strictest inquiry he found the inhabitants of those counties to be wholly unacquainted with the bird, and hence concluded that it had forsaken our island. The Crane, however, no doubt then appeared in Britain, as it does now, at uncertain intervals and in unwonted places, showing that the examples occurring here (which usually meet the hostile reception commonly accorded to strange visitors) have strayed from the migrating bands whose movements have been remarked from almost the earliest æge. Indeed, the Crane's aerial journeys are of a very extended kind; and on its way from beyond the borders of the Tropic of Cancer to within the Arctic Circle, or on the return-voyage, its flocks may be described passing overhead at a marvellous height, or halting for rest and refreshment on the wide meadows that border some great river, while the seeming order with which its ranks are marshalled during flight has long attracted attention. The Crane takes up its winter-quarters under the burning sun of Central Africa and India, but early in spring returns northward. Not a few examples reach the chill polar soils of Lapland and Siberia, but some tarry in the south of Europe and breed in Spain, and, it is supposed, in Turkey. The greater number, however, occupy the intermediate zone and pass the summer in Russia, North Germany, and Scandinavia. Soon after their arrival in these countries the flocks break up into pairs, whose nuptial ceremonies are accompanied by loud and frequent trumpeting, and the respective breeding-places of each are chosen.

The nest is formed with little art on the ground in large open marshes, where the herbage is not very high—a tolerably dry spot being selected and used apparently year after year. Here the eggs, which are of a rich brown color with dark spots, and always two in number, are laid. The young are able to run soon after they are hatched, and are at first clothed with tawny down. In the course of the summer they assume nearly the same grey plumage that their parents wear, except that the elongated plumes, which in the adults form a graceful covering of the hinder parts of the body, are comparatively undeveloped, and the clear black, white, and red (the last being due to a patch of papillose skin of that color) of the head and neck are as yet indistinct. During this time they keep in the marshes, but as autumn approaches the different families unite by the rivers and lakes, and ultimately form the enormous bands which after much more trumpeting set out on their southward journey.

The Crane's power of uttering the sonorous and peculiar trumpet-like notes, of which mention has been made, is commonly and perhaps correctly ascribed to the formation of its trachea, which on quitting the lower end of the neck

passes backward between the branches of the furcula and is received into a hollow space formed by the bony walls of the carina or keel of the sternum. Herein it makes three turns, and then runs upwards and backwards to the lungs. The apparatus on the whole much resembles that found in the Whooping Swans (*Cygnus musicus*, *C. buccinator*, and others), though differing in some not unimportant details; but at the same time somewhat similar convolutions of the trachea occur in other birds which do not possess, so far as is known, the faculty of trumpeting. The Crane emits its notes both during flight and while on the ground. In the latter case the neck and bill are uplifted and the mouth kept open during the utterance of the blast, which may be often heard from birds in confinement, especially at the beginning of the year.

As usually happens in similar cases, the name of the once familiar British species is now used in a general sense, and applied to all others which are allied to it. Though by many systematists placed near or even among the Herons, there is no doubt that the Cranes have only a superficial resemblance and no real affinity to the *Ardeide*. In fact the *Gruidæ* form a somewhat isolated group. Professor Huxley has included them together with the *Rallidæ* in his *Geranomorphæ*; but a more extended view of their various characters would probably assign them rather as relatives of the Bustards—not that it must be thought that the two families have not been for a very long time distinct. *Grus*, indeed, is a very ancient form, its remains appearing in the Miocene of France and Greece, as well as in the Pliocene and Post-pliocene of North America. In France, too, during the "Reindeer Period" there existed a huge species—the *G. primigenia* of M. Alphonse Milne-Edwards—which has doubtless been long extinct. At the present time Cranes inhabit all the great zoogeographical Regions of the earth, except the Neotropical, and some sixteen or seventeen species are discriminated. In Europe, besides the *G. communis* already mentioned, we have as an inhabitant that which is generally known as the Numidian or Demoiselle-Crane (*G. virgo*), distinguished from every other by its long white ear-tufts. This bird is also widely distributed throughout Asia and Africa, and is said to have occurred in Orkney as a straggler. The eastern part of the Palearctic Region is inhabited by four other species that do not frequent Europe (*G. antigone*, *G. japonensis*, *G. monachus*, and *G. leucogeranus*), of which the last is perhaps the finest of the family, with nearly the whole plumage of a snowy white. The Indian Region, besides being visited in winter by four of the species already named, has two that are peculiar to it (*G. torquata* and *G. indica*—both commonly confounded under the name of *G. antigone*). The Australian Region possesses a large species known to the colonists as the "Native Companion" (*G. australis*); while the Nearctic is tenanted by three species (*G. americana*, *G. canadensis*, and *G. fraterculus*), to say nothing of the possibility of a fourth (*G. schlegelii*), a little-known and somewhat obscure bird, finding its habitat here. In the Ethiopian Region we have two species (*G. paradisea* and *G. carunculata*) which do not occur out of Africa, as well as two others forming the group known as "Crowned Cranes"—differing much from other members of the family, and justifiably placed in a separate genus, *Balearica*. One of these (*B. pavonina*) inhabits Northern and Western Africa, while the other (*B. regulorum*) is confined to the eastern and southern parts of that continent.

With regard to the literature of this species, a paper "On the Breeding of the Crane in Lapland" (*Ibis*, 1859, p. 191), by the late Mr. John Wolley, is one of the most pleasing contributions to natural history ever written, and an admirably succinct account of all the different species was communicated by the late Mr. Blyth to *The Field* newspaper in 1873 (vol. xl, p. 631, vol. xli, pp. 7, 61, 136, 189, 248, 384, 408, 418), which it is much to be regretted has not since been published in a more accessible form; while a beautiful picture representing a flock of Cranes, resting by the Rhine, during one of their annual migrations, is to be found in Mr. Wolf's *Zoological Sketches*. (A. N.)

CRANE, a machine for raising and lowering heavy weights, and removing them from one place to another. Its chief parts are the jib, an inclined or horizontal beam at the end of which the weight is suspended; the upright crane post or stalk, on which the crane turns; the stay

! There is, however, some doubt whether this be not a form of the preceding.



beneath and supporting the jib; the barrel, round which the chain attached to the weight is coiled; and the winch, pinion, and handles. In place of a stay, chains or tension-bars above the jib are commonly employed; the latter at their upper end form eyes for the pivot of the sheave, or are pinned to the socket of the jib; below they are fixed to the cast-iron framing that carries the wheel-work. To prevent the acceleration of the movement of descending weights breaks are employed, in one form of which a lever causes friction by bringing a piece of wood, strengthened with iron, into contact with a plain wheel attached to the barrel of the crane. The winch handle has given it a radius of about 18 inches, and its centre is placed at 3 feet or 3 feet 2 inches from the ground; the limit of the average stress on it to be allowed for each laborer, working constantly at the rate of 220 feet a minute, has been found to be 15 lb. The length of the journals of the axles is made  $1\frac{1}{2}$  to 2 times their diameter, which must be proportionate to the torsion of the wheels to be resisted. The diameter of the axles of the crane-barrel, if of cast-iron, should be proportional to the cube root of the strain upon them in cwts.; if of wrought-iron, to  $\frac{1}{2}$ ths of the same. The chain or rope ought not to be worked with more than one-half the weight which it is estimated to be capable of bearing. The strength of the jib varies almost directly as the fourth power of its diameter, and inversely as the square of its length. In cranes for lifting great weights the jib may be made to rest against a circular rail let into masonry, instead of bearing against the crane post. The ends of the jib should not be rounded, but should be cut square, so as to lie evenly against the iron sockets into which they fit. In iron cranes the post is a hollow pillar of cast-iron, fixed by means of cross-shaped framings of the same material into a block of masonry; the jib is of iron, or of wood with terminal sockets of that metal. A crane at Earl Grey's Dock, Dundee Harbor, when worked by eight men, is capable of lifting 30 tons; it can be moved round by one man by the application of horizontal gearing; its total weight is not above 60 tons. The double crane for wharfs and pier-heads is framed and braced so as to balance exactly when turned on its pivot. In another double crane, used in the building of breakwaters, one jib is employed in laying, while the other lifts a stone. The derrick is a temporary crane consisting of a spar supported by guys or stays; in this crane the iron beam or derrick can, by raising or lowering, be set at any required angle.

The cranes in general use in the earlier part of the last century were primitive contrivances worked by means of a large hollow wheel, within which a man walked forwards or backwards according as goods were to be raised or lowered; the jib of the crane was fixed on a pivot so as to turn round about  $\frac{1}{4}$ ths of a circle. After this a simpler form, still in use, was introduced, with the wheel fixed on a portion of the jib projecting behind the crane post. One of the first examples of traversing cranes was erected by Mr. Rennie in the Mahogany Sheds at the West India Docks. For this kind of crane a railway is constructed on parallel frames of timber reaching across the roof of a building, and on this is a carriage supported on wheels, and capable, therefore, of being moved backwards or forwards by means of the machinery attached to it. The chain that bears the weight is connected with the carriage, and hangs down between the two lines of rails. By making the framework supporting the railway movable, as well as the carriage, goods can be transported in any required direction. The frames of railway traversing cranes are composed of two triangular timber structures, mounted on strong wheels, these by toothed wheels and pinions are caused to move along the railroad on which they are placed. At one time vacuum cranes were employed, to work which small oscillating cylinders, similar to those of high-pressure steam engines, were put in communication with a receiver exhausted of air by steam pumps. Afterwards steam came to be applied immediately as the motive power of cranes. In the direct-acting steam crane, the crane post itself is the steam cylinder, and the steel wire rope for lifting the load constitutes the piston-rod; to turn the crane round, steam is admitted to a cylinder beneath and forming part of the bed-plate. The first crane worked by pistons acted on by water-power was established at Newcastle-on-Tyne in 1846. Reservoirs at great heights for providing water-pressure can be dispensed with by the use of Sir W. Armstrong's accumulator, an apparatus consisting of a cast-iron cylinder

in which the water supplied by an engine is pressed upon by a loaded plunger. The excess of water pumped into the accumulator at any time is employed in raising the plunger; this, on reaching a certain height, begins to close a throttle-valve in the steam-pipe of the engine, and thus lessens its rate, until fresh demands are made upon the contents of the accumulator. The water discharged by the cranes may be led by a return pipe to a cistern over the engine room, in order again to supply the force-pumps. To avoid jerks and concussions owing to the momentum of the jib after the closing of the water passages, a check-valve is provided which opens up into the supply-pipe whenever the pressure in the cylinder of the hydraulic press becomes greater than that in the accumulator. The tubular cranes of Fairbairn are made of wrought-iron plates riveted together. The jib, which is curved, is rectangular in cross-section, and tapers upwards to its extremity, and below the ground to a considerable depth, where it terminates in a shoe of cast-iron on which the crane revolves. The plates forming the edges of the jib are connected by means of angle iron, and those of its convex or upper side by chain riveting. The curvature of the jib allows of the raising of weights to its highest point. The chain-barrels and the spindles for the wheel-gearing are preferably enclosed within the jib.

See *Mechanics and Engineer's Magazine*, vol. II., 2d ser., pp. 169, 190; Glynn, *Rud. Treatise on the Construction of Cranes and Machinery*, 1865; Laboulaye, *Dictionnaire des Arts et Manuf.*, s. v. "Grue;" Cressy, *Ency. of Civil Engineering*.

CRANMER, THOMAS (1489–1556), archbishop of Canterbury, was born at Aslacton in Nottinghamshire on the 2d July, 1489. The second son of Thomas Cranmer and of his wife Anne Hatfield, he belonged to a family that had been settled in Nottinghamshire from the time of the Norman Conquest. He received his early education, according to Morice his secretary, from "a marvellous severe and cruel schoolmaster," whose discipline must have been severe indeed to deserve this special mention in an age when no schoolmaster bore the rod in vain. The same authority tells us that he was initiated by his father in those field sports, such as hunting and hawking, which formed one of his recreations in after life. To early training he also owed the skillful horsemanship for which he was conspicuous. At the age of fourteen he was sent by his mother, who had recently become a widow, to Cambridge, where he entered at Jesus College. Little is known with certainty of his university career beyond the facts that he became a fellow of his college in 1510 or 1511, that he had soon after to vacate his fellowship, owing to his marriage to "Black Joan," a relative of the landlady of the Dolphin Inn, and that he was reinstated in it on the death of his wife, which occurred in childbirth before the lapse of the year of grace allowed by the statutes. During the brief period of his married life he held the appointment of lecturer at Buckingham Hall, now Magdalene College. The fact of his marrying would seem to show that he did not at the time intend to enter the church, and there are indications that the profession of his choice was the law. It has been conjectured with some plausibility that the death of his wife caused him to change his intention and qualify himself for holy orders. He was ordained in 1523, and soon after he took his doctor's degree in divinity. According to Strype, he was invited about this time to become a fellow of the college founded by Cardinal Wolsey at Oxford; but Dean Hook shows that there is some reason to doubt this. If the offer was made it was declined, and Cranmer continued at Cambridge filling the offices of lecturer in divinity at his own college and of public examiner in divinity to the university. It is interesting, in view of his later efforts to spread the knowledge of the Bible among the people, to know that in the capacity of examiner he insisted on a thorough acquaintance with the Holy Scriptures, and rejected several candidates who were deficient in this qualification.

It was a somewhat curious concurrence of circumstances that transferred Cranmer, almost at one step, from the quiet seclusion of the university to the din and bustle of the court. In 1523 the plague known as the sweating sickness, which prevailed throughout the country, was specially severe at Cambridge, and all who had it in their power forsook the town for the country. Cranmer went with two of his pupils named Cressy, related to him through

their mother, to their father's house at Waltham in Essex. The king (Henry VIII.) happened at the time to be residing in the immediate neighborhood, and two of his chief counsellors, Gardyner, secretary of state, afterwards bishop of Winchester, and Fox, the lord high almoner, afterwards bishop of Hereford, were lodged at Cressy's house. Meeting with Cranmer, they were naturally led to discuss what was the absorbing question of the day, the king's meditated divorce from Catherine of Aragon. The opinion of the future archbishop was given with the modesty that befitted an unknown man. He professed not to have studied the cause as the others had done; but it seemed to him that if the canonists and the universities should decide that marriage with a deceased brother's widow was illegal, and if it were proved that Catherine had been married to Prince Arthur, her marriage to Henry could be declared null and void by the ordinary ecclesiastical courts. The necessity of an appeal to Rome was thus dispensed with, and this point was at once seen by the king, who, when Cranmer's opinion was reported to him, ordered him to be summoned in these terms:—"I will speak to him. Let him be sent for out of hand. This man, I trow, has got the right sow by the ear."

At their first interview Cranmer was commanded by the king to lay aside all other pursuits and to devote himself to the question of the divorce. He was to draw up a written treatise, stating the course he proposed, and defending it by arguments from scripture, the fathers, and the decrees of general councils. There is reason to believe that he entered upon the task somewhat reluctantly, but in the reign of Henry VIII. it was emphatically true that the king's will was law, and no refusal was possible. His material interests certainly did not suffer by compliance. He was commended to the hospitality of Anne Boleyn's father, the earl of Wiltshire, in whose house at Durham Place he resided for some time; the king appointed him archdeacon of Taunton and one of his chaplains; and he also held a parochial benefice, the name of which is unknown. When the treatise was finished Cranmer was called upon to defend its argument before the universities of Oxford and Cambridge, which he visited, accompanied by Fox and Gardyner. Immediately afterwards he was sent to plead the cause before a more powerful if not a higher tribunal. An embassy, with the earl of Wiltshire at its head, was despatched to Rome in 1530, that "the matter of the divorce should be disputed and ventilated," and Cranmer was an important member of it. He was received by the Pope with marked courtesy, and was appointed "Grand Penitentiary of England;" but his argument, if he ever had the opportunity of stating it, did not lead to any practical decision of the question. Returning home through France and Germany, he had interviews in the latter country with the elector of Saxony and other Protestant princes.

It is usual to attribute to the influence of this Continental visit a further recoil in Cranmer's mind from Roman Catholicism and an advance to what is now known as Protestantism. Now there are, it is true, indications that he was dissatisfied with much that he saw at Rome, and it is a probable conjecture that his intercourse with the German princes had some effect in modifying his doctrinal views. But it must be remembered that the modern idea of Protestantism and Roman Catholicism as two broadly marked, clearly divided, and antagonistic systems was only forming in Germany, and was all but unknown in England in Cranmer's day. It would be unnecessary to state so obvious a truth, were it not for the seemingly ineradicable tendency of hasty thinkers to throw back familiar distinctions in religion and politics to a period when such distinctions had not come into existence. The fact that Cranmer is persistently described as the "first Protestant archbishop of Canterbury," which, if true at all, is true only in a very modified sense, shows the necessity for this caution.

Cranmer had only been a few months in England when he received a second commission from the king appointing him "Conciliarius Regius et ad Cæsarem Orator." In the summer of 1531 he accordingly proceeded to Germany as sole ambassador to the emperor, with the design of furthering the divorce. His mission was fruitless, but he did not at once return to England. At Nuremberg he had become acquainted with Osiander, whose somewhat isolated theological position he probably found to be in many points analogous to his own. Both were convinced that the old

order must change; neither saw clearly what the new order should be to which it was to give place. They had frequent interviews, which had doubtless an important influence on Cranmer's opinions. But Osiander's house had another attraction of a different kind from theological sympathy. His niece Margaret won the heart of Cranmer, and early in 1532 they were married. In the case of a strong character like Luther, marriage implied an express practical rejection of the authority of Rome to impose celibacy upon priests; no such inference can safely be made in the case of Cranmer, whose character was weak and whose action was generally determined by the influences of the moment. Hook finds in the fact of the marriage corroboration of Cranmer's statement that he never expected or desired the primacy; and it seems probable enough that, if he had foreseen how soon the primacy was to be forced upon him, he would have avoided a disqualification which it was difficult to conceal and dangerous to disclose.

Expected or not, the primacy was forced upon him within a very few months of his marriage. In August, 1532, Archbishop Warham died, and the king almost immediately afterwards intimated to Cranmer, who was still in Germany, his nomination to the vacant see. Cranmer's conduct was certainly consistent with his profession that he did not desire, as he had not expected, the dangerous promotion. He sent his wife to England, but delayed his own return in the vain hope that another appointment might be made. How long he ventured to wait is uncertain, but when he arrived in England he found the arrangements matured for his consecration; his "nolo episcopari" being unavailing against the king's command. The papal bulls of confirmation were dated February and March, 1533, and the consecration took place on the 30th March. One peculiarity of the ceremony has occasioned considerable discussion. It was the custom for the archbishop elect to take two oaths, the first of episcopal allegiance to the Pope, and the second in recognition of the royal supremacy. The latter was so wide in its scope that it might fairly be held to supersede the former in so far as the two were inconsistent. Cranmer, however, was not satisfied with this. He had a special protest recorded, in which he formally declared that he swore allegiance to the Pope only in so far as that was consistent with his supreme duty to the king. The morality of this course has been much canvassed, though it seems really to involve nothing more than an express declaration of what the two oaths implied. It was the course that would readily suggest itself to a man of timid nature who wished to secure himself against such a fate as Wolsey's. It showed weakness, but it added nothing to whatever immorality there might be in successively taking two incompatible oaths.

In the last as in the first step of Cranmer's promotion Henry had been actuated by one and the same motive. The business of the divorce had now become very urgent, and in the new archbishop he had an agent who might be expected to forward it with the needful haste. The celerity and skill with which Cranmer did the work entrusted to him must have fully satisfied his master. During the first week of April, Convocation sat almost from day to day to determine questions of fact and law in relation to Catherine's marriage with Henry as affected by her previous marriage with his brother Arthur. Decisions favorable to the object of the king were given on these questions, though even the despotism of the most despotic of the Tudors failed to secure absolute unanimity. The next step was taken by Cranmer, who wrote a letter to the king, praying to be allowed to remove the anxiety of loyal subjects as to a possible case of disputed succession, by finally determining the validity of the marriage in his archiepiscopal court. There is evidence that the request was prompted by the king, and his consent was given as a matter of course. Queen Catherine was residing at Ampthill in Bedfordshire, and to suit her convenience the court was held at the priory of Dunstable in the immediate neighborhood. Declining to appear she was declared contumacious, and on the 23d May the archbishop gave judgment declaring the marriage null and void from the first, and so leaving the king free to marry whom he pleased. In the whole proceeding, which had as much of the form as it had little of the spirit of justice, the archbishop's subserviency was pitiful, and it is difficult to acquit him of the graver charge of knowingly pronouncing an unrighteous sentence.

The coronation of the new queen, Anne Boleyn, at which Cranmer officiated, took place on the 1st June, little more than a week after the sentence which deprived her predecessor of her rights. During that interval it is asserted by some authorities that the king and Anne were publicly married by the archbishop. This, however, seems unlikely. A private marriage had taken place in the previous November, or more probably in January. Hook conjectures that the later ceremony was not a repetition of the marriage, but merely an official and public recognition of it.

The splendid pageantry of the coronation made the marriage popular for a few days with the citizens of London, but a deeper current of feeling in the opposite direction soon set in. The deliberate judgment of the country was undoubtedly one of indignant disapproval, and it speedily found utterance through the pulpit—the chief organ of public opinion in the days when there was no press. So outspoken were the preachers in their denunciation of the king's conduct that it was deemed necessary to silence them by an arbitrary exercise of authority. Cranmer's very first act of episcopal jurisdiction was to prohibit all preaching within his own diocese, and to arrange for its restriction by the other bishops of his province. His conduct in this can, of course, only be fairly judged by the standard of his own time, but the forcible suppression of all preaching was a curiously inconsistent measure to be adopted, even from motives of political urgency, by the "first Protestant archbishop of Canterbury."

Cranmer was little at court during the three years of Anne Boleyn's ascendancy there. The period was eventful, and he found abundant occupation in his ecclesiastical and parliamentary duties. He was an active promoter of the measures which led to the final breach with Rome. These included the appointment of bishops by the king alone without bulls or licenses from the Pope, the prohibition of the payment of Peter's pence or other contributions to Rome, and the renunciation by the archbishop of the title of legate. The independence of the Church of England was finally asserted by the two Houses of Convocation in the declaration that "the bishop of Rome has no greater jurisdiction given him in this realm of England than any other foreign bishop," and this statement may be held to embody the general result of Cranmer's ecclesiastical policy as shown in the details just mentioned. It is to be noted to his credit that he pled for More and Fisher even after he had failed to persuade them to admit the royal supremacy.

Cranmer's share in the divorce of Anne Boleyn in 1536 is perhaps less obscure than most things connected with that very mysterious transaction. When the king had made up his mind, the archbishop was summoned from Kent to Lambeth, where he was kept a virtual prisoner until he had indicated that he would be compliant. In a letter to Henry he plead generously for the queen, but the plea was robbed of whatever force it might have had by a closing sentence in which he stated his willingness to obey the king's commands. The proceedings were gone through with the same hypocritical show of judicial formality as in the case of Queen Catherine, and on the 10th June, 1536, the archbishop fulfilled his promise of obedience by declaring the marriage he had himself sanctioned to have been null and void from the first. It is urged in his favor that before doing so he had received from Anne a confession of some impediment existing before her marriage with the king which rendered the marriage invalid, but it does not appear in what the impediment consisted, and the plea can scarcely be accepted. Even if it could, few would be inclined to question the judgment of Hook that "of Cranmer's conduct in the affair the less that his admirers say, the greater will be their discretion." And this was not the last time in Henry's reign that the archbishop stooped to act the same degrading part. In 1540 he presided over the Convocation that disannulled the marriage with Anne of Cleves, which he had celebrated almost immediately before. To his next and last interposition in the matrimonial affairs of the king no discredit attaches itself. When he was made cognizant of the charges against Catherine Howard, his duty to communicate them to the king was obvious, though painful; and his choice of the time and manner of his fulfilling it was both delicate to his royal master and considerate to the accused.

Meanwhile Cranmer was actively carrying out the policy which has associated his name more closely, perhaps, than

that of any other ecclesiastic with the Reformation in England. Its most important feature on the theological as distinct from the political side was the endeavor to promote the circulation of the Bible in the vernacular, by encouraging translation and procuring an order in 1538 that a copy of the Bible in English should be set up in every church in a convenient place for reading. Only second in importance to this was the readjustment of the creed and liturgy of the church, which formed Cranmer's principal work during the latter half of his life. The progress of the archbishop's opinion towards that middle Protestantism, if it may be so called, which he did so much to impress on the formularies of the Church of England, was gradual, as a brief enumeration of the successive steps in that progress will show. In 1535 he corrected a second edition of the book known as the *King's Primer*, the original composition of which has been attributed to him, and which was in several points Protestant in doctrine. In 1538 an embassy of German divines visited England with the design, among other things, of forming a common confession for the two countries. This proved impracticable, but the frequent conferences Cranmer had with the theologians composing the embassy had doubtless a great influence in modifying his views. He had not strength of conviction enough, however, to oppose out and out the reactionary statute of 1538, known as the Six Articles, or "whip with the six strings." Foxe and others following him have indeed asserted that he did so, but Hook shows that the archbishop was present at the first and second readings of the bill, and also when it received the royal assent, while the only method of opposing it was to have absented himself. No doubt he had and urged strong objections to it, but these must have been overcome in the end by the arguments or the authority of the king. During the period between 1540 and 1543 the archbishop was engaged at the head of a commission in the revision of the "Bishop's Book," or *Institution of a Christian Man*, and the preparation of the *Necessary Erudition*, known as the "King's Book," which was a modification of the former work in the direction of Roman Catholic doctrine. In 1543 was issued his translation of the Litany, which was substantially the same as that now in use, and shows his mastery of a rhythmical English style. In 1547 appeared the *Homilies* prepared under his direction. Four of them are attributed to the archbishop himself—those on Salvation, Faith, Good Works, and the Reading of Scripture. His translation of the German Catechism of Justus Jonas, known as Cranmer's Catechism, appeared in the following year. Important, as showing his views on a cardinal doctrine, was the *Defence of the True and Catholic Doctrine of the Sacrament*, which he published in 1550. It was immediately answered from the side of the "old learning" by Gardiner. From these and other works which need not be mentioned it is not difficult to fix Cranmer's theological position. It may be best described in general terms as that of the historical High Church party in the Church of England, of which indeed Cranmer may be regarded as one of the chief founders. Transubstantiation was the discriminating doctrine between Romanists and Protestants in England, just as justification by faith was the discriminating doctrine in Germany; and it is to be noted that Cranmer did not renounce the dogma until after the death of Henry VIII. Ultimately, after much thought and controversy, he rested content with the acceptance of the fact of real presence apart from any theory, whether of transubstantiation or consubstantiation; and this course has proved satisfactory to the most eminent theologians of his school in the Church of England down to the present day. If it be added that, on the questions on which they differ from the Roman see, he would have found himself in substantial harmony with the Old Catholics of Germany, his views of ecclesiastical polity will be understood by most readers.

In what may be called the external work of the English Reformation, Cranmer's part was secondary, the principal agent being naturally Cromwell. The dissolution of the monasteries was the work of the minister, not of the archbishop; but the latter showed a laudable zeal in trying to secure as much as possible of the confiscated monastic property for the benefit of religion and learning. Although the relations of Cranmer with Cromwell had never been very intimate, he was generous enough to intercede for the minister after his fall in June, 1540. But with his usual weakness he did not persist in his intercession after he saw

that the king was determined. In fact he was present in Parliament when the bill of attainder was read, and so consented to it.

The course taken by Cranmer in promoting the Reformation exposed him to the bitter hostility of the reactionary party or "men of the old learning," of whom Gardynere and Bonner were leaders, and on two occasions—in 1543 and 1545—conspiracies were formed in the council to effect his overthrow. The king, however, remained true to him, and both conspiracies signally failed. It illustrates a favorable trait in the archbishop's character that he forgave all the conspirators, though he might doubtless have secured their punishment through his influence with the king. He was, as his secretary Morice testifies, "a man that delighted not in revenging."

Cranmer was present with Henry VIII. when he died (1547), and did his duty as spiritual adviser faithfully and kindly. By the will of the king he was nominated head of a council of regency composed of sixteen persons, but he acquiesced in the arrangement by which Somerset became lord protector. He officiated at the coronation of the boy king Edward VI., and instituted a significant change in the order of the ceremony, by which the right of the monarch to reign was made to appear to depend upon inheritance alone, without the concurrent consent of the people. The fact deserves mention, as there are other indications that the archbishop was a firm believer in the doctrine of the "divine right."

During this reign the work of the Reformation made rapid progress, the sympathies both of the protector and of the young king being decidedly Protestant. Cranmer was therefore enabled without let or hindrance to complete the preparation of the church formularies, on which he had been for some time engaged. The first prayer-book of Edward VI. was finished in November, 1548, and received legal sanction in January, 1549; the second was completed and sanctioned in April, 1552. The archbishop presided over the commissions that compiled them, and much of the work was done by himself personally. The forty-two articles of Edward VI. published in 1553 were based upon a German source, but they owe their form and style almost entirely to the hand of Cranmer. The last great undertaking in which he was employed was the revision of his codification of the canon law, which had been all but completed before the death of Henry. The task was one eminently well suited to his powers, and the execution of it was marked by great skill in definition and arrangement. It never received any authoritative sanction, Edward VI. dying before the proclamation establishing it could be made, and it remained unpublished until 1571, when a Latin translation by Dr. Walter Haddon and Sir John Cheke appeared under the title *Reformatio Legum Ecclesiasticarum*. That it was never authorized is matter for satisfaction in view of the fact that it laid down the lawfulness and necessity of persecution to the death for heresy in the most absolute terms. That Cranmer in this matter practised what he preached, his conduct in the cases of Frith, Hewat, and others sufficiently testifies. If, however, he was a persecutor both in theory and practice, it must be remembered that no one of any party in his day had grasped the principle of religious toleration.

Cranmer stood by the dying bed of Edward as he had stood by that of his father, and he there suffered himself to be persuaded to take a step against his own convictions which may be said to have sealed his doom. He had pledged himself to respect the testamentary disposition of Henry VIII. by which the succession devolved upon Mary, and now he violated his oath by signing Edward's "device" of the crown to Lady Jane Grey. On grounds of policy and morality alike the act was quite indefensible; but it is perhaps some palliation of his perjury that it was committed to satisfy the last urgent wish of a dying man, and that he alone remained true to the "twelfth day queen," when the others who had with him signed Edward's device deserted her. On the accession of Mary he was summoned to the council, reprimanded for his conduct, and ordered to confine himself to his palace at Lambeth until the queen's pleasure was known. With a firmness unusual to his character he refused to follow the advice of his friends and avoid the fate that was clearly impending over him by flight to the Continent. Any chance of safety that lay in the friendliness of a strong party in the council was more than nullified by the bitter personal enmity of the queen.

On the 14th September, 1553, he was sent to the Tower, where Ridley and Latimer were also confined. The immediate occasion of his imprisonment was a strongly worded declaration he had written a few days previously against the mass, the celebration of which, he heard, had been re-established at Canterbury. He had not taken steps to publish this, but by some unknown channel a copy reached the council, and it could not be ignored. In March, 1554, he and his two illustrious fellow-prisoners were removed to Oxford, where they were confined in the Bocardo or common prison. Ridley and Latimer were unflinching, and suffered bravely at the stake on the 16th October, 1555; it was fated that Cranmer was to reach the same end by a longer and less honorable path. It is impossible to give all the details of the intricate process against him, which at first involved the double charge of treason and heresy. Against the former of these he emphatically protested, and it was on the latter alone that he was ultimately condemned. The pontifical authority having been restored in England his case was tried by a Papal commission. At his first appearance before the court he protested against the jurisdiction of the bishop of Rome both by a formal declaration and by the significant action of putting on his hat and standing upright before the Pope's commissioner, the bishop of Gloucester, after having bowed respectfully to the representative of the queen. On the expiration of eighty days from the issue of a summons to Rome, which of course it was not in his power to obey even had he been willing, he was excommunicated by a Papal consistory, and a commission was sent to England to degrade him from his office of archbishop. This was done with the usual humiliating ceremonies in Christ Church, Oxford, on the 14th February, 1556, and he was then handed over to the secular power. But before the secular power did its last and worst, Cranmer was to inflict upon himself a degradation deeper far than any that could be inflicted on him from without. The story of his recantations is so notorious as to be known to many who know almost nothing else of his life. Under the pressure of delusive promises by various agents, whose conduct cannot be too strongly condemned, he was induced to sign no less than six of these, each ampler and more abject in its terms than that which had gone before. The last was dated the 18th March. On the 20th Dr. Cole, the provost of Exon, visited Cranmer in his prison with the view of ascertaining whether he remained steadfast in his new purpose, and he received what seemed a satisfactory answer. Next day, Saturday, the 21st March, he was taken to St. Mary's Church, and asked to repeat his recantation in the hearing of the people as he had promised. To the surprise of all he declared with dignity and emphasis that what he had recently done troubled him more than anything he ever did or said in his whole life; that he renounced and refused all his recantations as things written with his hand, contrary to the truth which he thought in his heart; and that as his hand had offended, his hand should be first burned when he came to the fire. If, as Hook is inclined to think, he made this statement in the belief that his life would be spared if he persisted in his recantation, he seems all but entitled to the crown of martyrdom; if, as Macaulay maintains, he made it after learning that he was to die in any case, and that a lie would therefore serve him as little as the truth, then, as Macaulay says, he was no more a martyr than Dr. Dodd. The question is important, but there are no materials for settling it definitely.

Immediately after his unexpected declaration he was led to the stake at the same place where Ridley and Latimer had suffered a few months before. As he had said, his right hand was steadfastly exposed to the flames, and several times during the burning he was heard to exclaim with a loud voice, "This hand hath offended—this unworthy hand." The calm cheerfulness and resolution with which he met his fate show that he felt that he had cleared his conscience, and that his recantation of his recantations was a repentance that needed not to be repented of.

It was a noble end to what, in spite of its besetting sin of infirmity of moral purpose, was a not ignoble life. He was often pitifully, sometimes criminally, weak, and never so much both as in his last days. The key to his character is well given in what Hooper said of him in a letter to Bullinger, that he was "too fearful about what might happen to him." This weakness made him the tool of

Henry in the most scandalous transactions of his reign, and the tool of Edward in what he knew to be an unjust alteration of the succession, and it robs him of his undisputed claim to rank among the noble army of martyrs. But while one may not admit that claim, there is a grandeur in the circumstances of his death, and especially in the incident of the voluntary burning of the right hand, which the popular instinct has not failed to appreciate as all but redeeming him from disgrace. It is only, however, a hero in life who can be in the true sense a martyr in death; and the archbishop was as little the one as the other. And so it is that brave old Latimer wears the crown, while the timid Cranmer passed through the same fiery gates into the city without the martyr's glory, though also without the apostate's shame.

See *Foxe's Acts and Monuments* (the Book of Martyrs), *Strype's Memorials of Cranmer* (1694), *Anecdotes and Character of Archbishop Cranmer*, by Ralph Morice, and two contemporary biographies (Camden Society's publications), *Remains of Thomas Cranmer*, by Jenkyns (1833), *Lives of Cranmer* by Gilpin (1784), Todd (1831), and Le Bas, and Hook's *Lives of the Archbishops of Canterbury*, vols. vi. and vii. (1868). (W. B. S.)

**CRANNOGS** (Celtic, *crann*, a tree), the term applied in Scotland and Ireland to the stockaded islands so numerous in ancient times in the lochs of both countries. The existence of these lake-dwellings in Scotland was first made known by Mr. John Mackinlay, a fellow of the Society of Antiquaries of Scotland, in a letter sent to George Chalmers, the author of *Caledonia*, in 1813, describing two crannogs, or fortified islands in Bute. The crannog of Lagore, the first discovered in Ireland, was examined and described by Sir William Wilde in 1840. But it was not until after the discovery of the pile-villages of the Swiss lakes, in 1853, had drawn public attention to the subject of lake-dwellings, that the crannogs of Scotland and Ireland were systematically investigated. The results of these investigations show that they resemble the Swiss lake-dwellings in nothing, except that they are placed in lakes. The crannog is a type of stronghold peculiar to Celtic countries. No example is known in England, although over a hundred have been examined and described in Ireland, and perhaps about half that number in Scotland. As a rule they have been constructed on islets or shallows in the lochs, which have been adapted for occupation, and fortified by single or double lines of stockaded defences drawn round the margin. To enlarge the area, or raise the surface level where that was necessary, layers of logs, brushwood, feather, and ferns were piled on the shallow, and consolidated with gravel and stones. Over all there was laid a layer of earth, a floor of logs, or a pavement of flagstones. In rare instances the body of the work is entirely of stones, the stockaded defence and the huts within its inclosure being the only parts constructed of timber. Occasionally a bridge of logs, or a causeway of stones, formed a communication with the shore, but often the only means of getting to and from the island was by canoes. One or two of these hollowed out of a single tree are usually found in connection with a crannog. The stockade was commonly of piles of oak, but occasionally of pine, yew, or alder. Remains of huts of logs, or of wattled work, are often found within the inclosure. Three crannogs in Dowalton Loch, Wigtonshire, examined by Lord Lovaine in 1863, were found to be constructed of layers of fern and birch and hazel branches, mixed with boulders, and penetrated by oak piles, while above all there was a surface layer of stones and soil. The remains of the stockade round the margin were of vertical piles mortised into horizontal bars, and secured by pegs in the mortise holes. The crannog of Cloonfinlough in Connaught had a triple stockade of oak piles connected by horizontal stretchers, and inclosing an area 130 feet in diameter, laid with trunks of oak trees. In the crannog of Lagore there were about 150 cartloads of bones, chiefly of oxen, deer, sheep, and swine, the refuse of the food of the occupants. The implements, utensils, and weapons found in the Scottish and Irish crannogs are usually of iron, or, if objects of bronze and stone are found, they are commonly such as were in use in the Iron age, differing in form and ornamentation from the relics of the Stone and Bronze ages. Stone celts are said in one or two instances to have occurred in Irish crannogs, but such instances are rare and exceptional, and no object of stone or bronze similar to those usually assigned to the Stone or Bronze age has been found in any crannog in Scotland.

The objects usually found in the Irish crannogs are swords, spears, javelins, dagger-blades, knives, and axes of iron, mostly of the forms which are characteristic of the period of the Scandinavian invasions from the 9th to the 12th century. Besides these there are cauldrons, basins, and other utensils of thin hammered bronze; pins, brooches, and horse-trappings of cast-bronze; combs, pins, handles of implements, ornaments, and other objects of bone; pots, dishes, and bowls of coarse, unglazed, and hand-made pottery, often ornamented with zig-zag lines and rude impressed or incised patterns of crossed or parallel lines and triangular markings; quernstones, whetstones, pestle-stones, round stone balls, &c. Few objects have been found in the Scottish crannogs except at Dowalton, which yielded basins of thin bronze, sorely clouted, part of a large cauldron, beads of glass and amber, and bracelets of vitreous paste, iron slag, crucibles, large hammer-heads of iron, quernstones, whetstones, and a shoe of stamped leather. A saucepan of Roman make was found in the loch in the neighborhood of the crannogs, but it is not certainly connected with any of them. Crannogs are frequently referred to in the Irish annals. Under the year 848 the *Annals of the Four Masters* record the burning of the island of Loch Gabhor (the crannog of Lagore), and the same stronghold is noticed as again destroyed by the Danes in 933. Under the year 1246 it is recorded that Turlough O'Connor made his escape from the crannog of Lough Leisi, and drowned his keepers. Many other entries occur in the succeeding centuries. In the register of the Privy Council of Scotland, April 14, 1608, it is ordered that "the hail housia of defence, strongholds, and *crannokis* in the Yllis (the western isles) pertaining to Angus M'Connell of Dunnyvaig and Hector M'Cloyne of Dowart sal be delveryt to His Majestie." Judging from the historical evidence of their late continuance, and from the character of the relics found in them, the crannogs of Scotland and Ireland may be regarded as the very latest class of prehistoric strongholds, reaching their greatest development in early historic times, and surviving through the Middle Ages. In Ireland Sir William Wilde has assigned their range approximately to the period between the 9th and 16th centuries. See LAKE DWELLINGS.

Wilde's *Descriptive Catalogue of the Antiquities in the Museum of the Royal Irish Academy*, Article "Crannogs," pp. 220, 233; Wakeman on "the Crannogs of Fermanagh" in the *Journal of the Royal Historical and Archeological Association of Ireland*, 4th series, vol. 1., pp. 305-314, 360-370 and 553-564; "Notice of two Crannogs in Bute," by John Mackinlay, in the *Proceedings of the Society of Antiquaries of Scotland*, vol. iii., pp. 43-46; "Scottish Artificial Islands or Crannogs," by John Stuart, Secretary of the Society of Antiquaries of Scotland, in their *Proceedings*, vol. vi., pp. 114-178; *Catalogue of Antiquities in the National Museum of the Society of Antiquaries of Scotland*, p. 60. (J. A. M.)

**CRANTOR**, a Greek philosopher of the Old Academy, famous as the first commentator on Plato, was born, probably about the middle of the 4th century, at Soli in Cilicia, and was a fellow pupil of Polemo in the school of Xenocrates at Athens. His poems, which are said to have been deposited in the temple of Athena at Soli, have entirely perished; but of his celebrated work *On Grief*, numerous extracts have been preserved in Plutarch and in Cicero *De Consolatione*.

**CRAPE** is a silk fabric of a gauzy texture, having a peculiar crisp or crumpled appearance. It is woven of hard spun silk yarn "in the gum" or natural condition. There are two distinct varieties of the textile—1st, soft, Canton, or Oriental crape, and 2d, hard or crisped crape. The wavy appearance of Canton crape results from the peculiar manner in which the weft is prepared, the yarn from two bobbins being twisted together in the reverse way. The fabric when woven is smooth and even, having no *crepé* appearance, but when the gum is subsequently extracted by boiling it at once becomes soft, and the weft, losing its twist, gives the fabric the waved structure which constitutes its distinguishing feature. Canton crapes are used, either white or colored, for ladies' scarfs and shawls, bonnet trimmings, etc. The Chinese and Japanese excel in the manufacture of soft crapes. The crisp and elastic structure of hard crape is not produced either in the spinning or in the weaving, but is due to processes through which the gauze passes after it is woven. What the details of these processes are is known to only a few manufacturers, who so

jealously guard their secret that, in some cases, the different stages in the manufacture are conducted in towns far removed from each other. Commercially they are distinguished as single, double, three-ply, and four-ply crapes, according to the nature of the yarn used in their manufacture. They are almost exclusively dyed black and used in mourning dress, and among Roman Catholic communities for nuns' veils, etc. In Great Britain hard crapes are made at Braintree in Essex, Norwich, Yarmouth, Manchester, and Glasgow. A very successful imitation of real crape is made in Manchester of cotton yarn, and sold under the name of Victoria crape.

CRASHAW, RICHARD (1613-1650), the poet, styled "the divine," was born in London in 1613. He was the son of a strongly anti-papistical divine, Dr. William Crashaw, who distinguished himself, even in those times, by the excessive acerbity of his writings against the Catholics. Richard Crashaw was originally put to school at Charter House, but in July, 1631, he was admitted to Pembroke College, Cambridge, where he took the degree of B. A. in 1634. The publication of Herbert's *Temple* in 1633 seems to have finally determined the bias of his genius in favor of religious poetry, and next year he published his first book, *Epigrammatum Sacrorum Liber*, a volume of Latin verse. In March, 1636, he removed to Peterhouse, and was made a fellow of that college in 1637. It was about this time that he made the acquaintance and secured the lasting friendship of Cowley. In 1641 he is said to have gone to Oxford, but only for a short time; for when in 1643 Cowley left Cambridge to seek a refuge at Oxford, Crashaw remained behind, and was forcibly ejected from his fellowship in 1644. In the confusion of the civil wars he escaped to France, where he finally embraced the Catholic religion, towards which he had long been tending. During his exile his religious and secular poems were collected by an anonymous friend, and published under the title of *Steps to the Temple and The Delights of the Muses*, in one volume, in 1648. This same year Cowley found him in great destitution at Paris, and induced Queen Henrietta Maria to extend towards him what influence she still possessed. At her introduction he proceeded to Italy, where he became secretary at Rome to Cardinal Palotta. In 1648 he published two Latin hymns at Paris. He remained until 1649 in the service of the cardinal, to whom he had a great personal attachment; but his retinue contained persons whose violent and licentious behavior were a source of ceaseless vexation to the sensitive English mystic. At last his denunciation of their excesses became so public that the animosity of those persons was excited against him, and in order to shield him from their revenge, he was sent by the cardinal in 1650 to Loretto, where he was made a canon of the Holy House. In less than three weeks, however, he sickened of fever, and died, not without grave suspicion of having been poisoned. He was buried in the Lady Chapel at Loretto. A collection of his latest religious poems, entitled *Carmen Deo Nostro*, was brought out in 1652, dedicated to the dead poet's desire to the faithful friend of his sufferings, the countess of Denbigh. Crashaw excelled in all manner of graceful accomplishments; besides being an excellent Latinist and Hellenist, he had an intimate knowledge of Italian and Spanish; and his skill in music, painting, and engraving was no less admired in his lifetime than his skill in poetry. Cowley embalmed his memory in an elegy that ranks among the very finest in our language, in which he, a Protestant, well expressed the feeling left on the minds of contemporaries by the character of the young Catholic poet:—

His faith, perhaps, in some nice tenets might  
Be wrong; his life, I'm sure, was in the right:  
And I, myself, a Catholic will be,  
So far at least, dear saint, to pray to thee!

The poetry of Crashaw will be best appreciated by those who can with most success free themselves from the bondage of a traditional sense of the dignity of language. The custom of his age permitted the use of images and phrases which we now justly condemn as incongruous and unseemly, and the fervent fancy of Crashaw carried this license to the most roccoco excess. At the same time his verse is studded with fiery beauties and sudden felicities of language, unsurpassed by any lyrist between his own time and Shelley's. There is no religious poetry in English so full at once of gross and awkward images and imaginative touches of the most ethereal beauty. The temper of his

intellect seems to have been delicate and weak, fiery and uncertain; he has a morbid, almost hysterical, passion about him even when his ardor is most exquisitely expressed, and his adoring addresses to the saints have an effeminate falsetto that makes them almost repulsive. The faults and beauties of his very peculiar style can be studied nowhere to more advantage than in the *Hymn to Saint Theresa*. Among the secular poems of Crashaw the best are *Music's Duel*, which deals with that strife between the musician and the nightingale which has inspired so many poets, from Strada down to Coppée, and *Wishes to his supposed Mistress*. In his latest sacred poems, the *Carmen Deo Nostro*, sudden and eminent beauties are not wanting, but the mysticism has become more pronounced, and the ecclesiastical mannerism more harsh and repellent. The themes of Crashaw's verse are as distinct as possible from those of Shelley's, but it may, on the whole, be said that at his best moments he reminds the reader more closely of the author of *Epipsychidion* than of any earlier or later poet.

Crashaw's works were first collected, in one volume, in 1858 by W. B. Turnbull. In 1872 an edition in 2 vols. was printed for private subscription by the Rev. A. B. Grosart.

(z. w. c.)

CRASSUS, LUCIUS LICINIUS (140-91 B. C.), a celebrated Roman orator most highly praised by Cicero. He commenced his political career, at the age either of nineteen or of twenty-one, by bringing a charge against Carbo the friend of the Gracchi, who in consequence took poison. He took part in more than one of the most famous cases in the annals of Roman law, and attained a wonderful reputation. In 95 B. C. he became consul, and at the expiration of his term of office proconsul in Gaul. He was almost as much distinguished for his wealth and the elegant luxury in which he indulged as for his eloquence and wit.

CRASSUS, MARCUS LICINIUS, the triumvir, surnamed the Rich on account of his wealth, which he acquired by educating slaves and selling them at a high price, by working silver mines, and by skilful purchase of land and houses. The proscription of Cinna obliged him to flee to Spain; but after Cinna's death he passed into Africa, and thence to Italy, where he ingratiated himself with Sulla. Having been sent against Spartacus, he gained a decisive victory, in which 12,000 of the rebels were killed, and was honored with an ovation at his return. Soon afterwards he was elected consul with Pompey, 72 B. C., and he displayed his opulence by entertaining the populace at 10,000 tables. He was afterwards censor, and he joined Pompey and Caesar in forming the first triumvirate. As his love of riches was greater than his love of glory, Crassus was satisfied with the province of Syria, which promised to be an inexhaustible source of wealth. Having crossed the Euphrates he hastened to make himself master of Parthia; but he was defeated and taken prisoner by Surenra, the Parthian general, who put him to death by pouring molten gold down his throat. His head was then cut off and sent to Orodes. See ROMAN HISTORY.

CRATES, of Athens, an Athenian actor and author of comedies of the 5th century B. C. He acted in the comedies of Cratinus; and his own pieces are distinguished chiefly, first, by the fact that they did not depend for their interest upon political references, and secondly, by the fact that he introduced drunkards on the stage,—a class of characters that had never appeared there before, although very frequently after his time.

CRATES, of Mallus in Cilicia, a Greek grammarian and Stoic philosopher of the 2d century B. C., was leader of the literary school and head of the library of Pergamus. Almost the only event of his life with which we are acquainted is the visit which he made to Rome about 157 B. C. as ambassador of Attalus II., king of Pergamus, and which is said to have given an impulse to the study of Latin grammar. Crates wrote many works—commentaries on the *Theogony*, Euripides, and Aristophanes, a treatise on the Attic dialect, and works on agriculture and geography,—but some suppose the geographer to have been a different person.

CRATES, of Thebes, a Cynic philosopher of the 4th century B. C., was a pupil of Diogenes, whose extreme cynicism he rivaled. He gave up his large fortune, directing the banker to whom he intrusted it to give it to his sons if they should prove fools, but to the poor if his sons should prove philosophers. He besides attacked all who did not follow his example, not scrupling to force

himself into their houses, and thus he gained the nickname of the "door-opener." Poor and ugly as he was, he gained the affection of a young woman of good family, Hipparchia, who refused to marry the most eligible suitors, for his sake threatened to commit suicide, and at last was allowed by her parents to become his wife. Crates was the author of a number of philosophical letters; but those published under his name among the Aldine classics and by Boissonade are not genuine.

CRATINUS (519-423 B. C.), one of the greatest of the Athenian masters of comedy. Our knowledge of his personal history consists of only one or two facts:—he was the son of a certain Callimedes; he was triarch of the Ænean tribe; he died in 423 B. C., at the age (Lucian tells us) of ninety-seven; and the end of his life was devoted to drinking. His comedies also are now lost, with the exception of small fragments; but as to their character his contemporaries are in general agreement. They were distinguished by their direct and vigorous political satire, a marked exception being the burlesque *Oἰνοποιία*, which was probably written while a law was in force forbidding all political references on the stage, and which is also remarkable for the absence of the chorus. Persius calls their author "the bold;" and even Pericles, when at the height of his power, did not escape their vehement attacks. Of his last comedy the plot has come down to us. It was occasioned by the sneers of Aristophanes and others who declared that he was no better than a doting drunkard. Roused by the taunt Cratinus put forth all his strength, and in 423 B. C. produced the *Ilyvov*, or *Bottle*, which so completely vindicated his powers that he gained the first prize, and triumphed over the *Clouds* of Aristophanes. This victory, however, was very possibly determined partly by other than artistic considerations, for Aristophanes would have to struggle against the influence of the sophists, the rhetoricians, and the disciples of Socrates. In this comedy, good-humoredly making fun of his own weakness, Cratinus represents the comic muse as the faithful wife of his youth. His guilty fondness for a rival—the bottle—has aroused her jealousy. She demands a divorce from the archedon; but her husband's love is not dead, and he returns penitent to her side. The style of Cratinus has been likened to that of Æschylus; and Aristophanes, in the *Knights*, compares him to a rushing torrent. He appears to have been fond of lofty diction and bold figures, and he was most successful in the lyrical parts of his dramas, his choruses being the popular festal songs of his day. Cratinus is said to have been the first to fix the number of actors at three; but the statement is very doubtful, for Aristotle says that in his time the author of the rule was not known.

CRATIPPUS, a Peripatetic philosopher, belonging to Mtilene, was contemporary with Cicero, whose son he taught at Athens, and by whom he is praised in the *De Officiis* as the greatest of his school. He was also the friend of Pompey, whose flight after the battle of Pharsalia he shared, for the purpose, it is said, of convincing him of the justice of providence; and Brutus, while at Athens after the assassination of Cæsar, attended his lectures. The only work attributed to Cratippus is a treatise on divination. His view of the subject is given by Cicero in the *De Divinatione* (i. 32). He seems to have held that, while motion, sense, and appetite cannot exist apart from the body, thought reaches its greatest power when most free from bodily influence, and that divination is due to the direct action of the divine mind on that faculty of the human soul which is not dependent on the body.

CRATIPPUS, a contemporary of Thucydides, to whose history he made considerable additions, filling in omissions and continuing it to the time of Conon.

CRAUFORD, QUENTIN (1743-1819), an English author. In early life he went to India, where he entered the British army, and on the conclusion of peace devoted himself to commerce. Returning to Europe before the age of forty with a handsome fortune, he settled at Paris, where he gave himself to the cultivation of literature and art, and formed a good library and collection of paintings, coins, and other objects of antiquarian interest, and where he remained till his death, with the exception of ten years from the outbreak of the Revolution to the Peace of Amiens.

He wrote, among other works, *The History, Religion, Learning, and Manners of the Hindus* (London, 1790), *Researches Concerning the Laws, Theology, Learning, and Commerce of Ancient*

*and Modern India* (1817), *History of the Bastille* (London, 1792), *On Pericles and the Arts in Greece, Essay on Swift and his Influence on the British Government, Notice sur Marie Antoinette, with whom he had personal acquaintance* (Paris, 1809), *Mémoires de Mme. du Hausset*.

CRAWFORD, THOMAS (1814-1857), American sculptor, was born of Irish parents at New York, March 22, 1814. He showed at an early age great taste for art, and learnt to draw and to carve in wood. In his nineteenth year he entered the studio of a firm of monumental sculptors in his native city; and at the age of twenty he went to Rome and became a pupil of Thorwaldsen. The first work which made him generally known as a man of genius was his group of Orpheus entering Hades in search of Eurydice, executed in 1839. This was followed by other poetical sculptures, among which were the Babes in the Wood, Flora, Hebe and Ganymede, Sappho, Vesta, the Dancer, and the Hunter. Among his statues and busts are especially noteworthy the bust of Josiah Quincy, executed for Harvard University (now in the Boston Athenæum), the equestrian statue of Washington at Richmond, Virginia, the statue of Beethoven in the Boston music hall, statues of Channing and Henry Clay, and the colossal figure of Armed Liberty for the Capitol at Washington. For this building he executed also the figures for the pediment and the bronze doors. The groups of the pediment symbolize the progress of civilization in America. Crawford's works include a large number of bas-reliefs of Scriptural subjects taken from both the Old and the New Testaments. He made Rome his home, but he visited several times his native land,—first in 1844, in which year he married, next in 1849, and lastly in 1856. His studio at Rome was very attractive to visitors, and for some time he ranked as sculptor next after Gibson. His works always bore the stamp of original invention and freshness of thought, although in execution they were open to criticism. During his last years he suffered from a tumor on the brain, which deprived him of sight, and he was compelled to leave many works unfinished. He sought relief at Paris and in London, but in vain, and died in London on the 10th of October, 1857.

CRAWFURD, JOHN (1783-1868), a Scottish author, was born in the island of Islay, Scotland. After studying at Edinburgh he became surgeon in the East India Company's service. He afterwards resided for some time at Penang, and he was from 1811 to 1817 British representative at Java. In 1821 he served as envoy to Siam and Cochin-China, and in 1823 became governor of Singapore. In 1861 he was elected president of the Ethnological Society.

He wrote a *History of the Indian Archipelago* (1820), *Descriptive Dictionary of the Indian Islands and Adjacent Countries* (1856), *Journal of an Embassy to the Court of Ava in 1827* (1829), *Journal of an Embassy to the Courts of Siam and Cochin-China, exhibiting a View of the actual State of these Kingdoms* (1830), *Inquiry into the System of Taxation in India, Letters on the Interior of India, an attack on the newspaper stamp-tax and the duty on paper entitled Taxes on Knowledge* (1836), and a valuable Malay grammar and dictionary (1852).

CRAVER, GASPARD DE (1582-1669), was born at Antwerp, and learnt the art of painting from Raphael Coxcie. He matriculated in the guild of St. Luke at Brussels in 1607, resided in the capital of Brabant till after 1660, and finally settled at Ghent. Amongst the numerous pictures which he painted in the last of these cities, one in the town museum represents the Martyrdom of St. Blaise, and bears the inscription A° 1668 set. 86. Craver, one of the most productive yet one of the most conscientious artists of the later Flemish school, was second to Rubens in vigor and below Vandyck in refinement; but he very nearly equalled both in most of the essentials of painting; and it is probably true, as stated by modern critics, that his fame was unfairly overshadowed by that of two great contemporaries with whom he was on terms of intimacy. He was well known and always well treated by Albert and Isabella, governors of the Netherlands. The Cardinal-Infant Ferdinand made him a court-painter. His pictures abound in the churches and museums of Brussels and Ghent; and there is scarcely a country chapel in Flanders or Brabant that cannot boast of one or more of his canvases. But he was equally respected beyond his native country; and some important pictures of his composition are to be found as far south as Aix in Provence, and as far east as Amberg in the Upper Palatinate. His skill as a

decorative artist is shown in the panels executed for a triumphal arch at the entry of Cardinal Ferdinand into the Flemish capital, some of which are publicly exhibited in the museum of Ghent. Crayer died at Ghent. His best works are the Miraculous Draught of Fishes in the Gallery of Brussels, the Judgment of Solomon in the Gallery of Ghent, and Madonnas with Saints in the Louvre, the Munich Pinakothek, and the Belvedere at Vienna. His portrait by Vandyck was engraved by P. Pontius.

CRAYON, a colored material for drawing, employed generally in the form of pencils, but sometimes also as a powder, and consisting of native earthy and stony friable substances, or of artificially-prepared mixtures of a base of pipe or China clay with Prussian blue, orpiment, vermilion, umber, and other pigments. Calcined gypsum, talc, and compounds of magnesium, bismuth, and lead are occasionally used as bases. The required shades of tints are obtained by adding varying amounts of coloring-matter to equal quantities of the base. The ingredients of crayons or pastils are made into a paste with gum, turpentine, or alcoholic solution of shellac, and pulverized as finely as possible in a mill, which subjects them repeatedly to the action of a revolving cast-iron grinder. The paste is introduced into a copper cylinder, closed at one end by a plate pierced with holes of the diameter of the crayons to be made. Through these it is forced by means of a piston, and the vermicular pieces obtained are then cut into the required lengths, and dried in a furnace at a gentle heat. Black crayons may be manufactured from a mixture of one part of lampblack with about two-thirds of its bulk of clay; red crayons from powdered and elutriated hæmatite worked up into a paste with gum-arabic and a little soap. White crayons are commonly formed by sawing chalk of good quality into convenient shapes. Mixtures of soap, wax, and lampblack are employed for lithographic crayons or chalks. The late well-known zoological lithographer, George Ford, employed chalks made after the following recipe:—

Yellow wax, . . . . .	32 os.
Curd soap, . . . . .	24 "
Mutton tallow, . . . . .	4 "
Washing soda (dissolved in 7 oz. water), . . . . .	1 "
Paris black (sifted), . . . . .	7 "

The wax is gradually incorporated with the melted soap by heating, and as the resultant mass begins to burn, the soda is added; afterwards the black is by degrees stirred in. The melted tallow may be added at any stage in the operation.

Crayons are valuable to the artist in enabling him to make groupings of colors and to secure landscape and other effects with ease and rapidity. The outline as well as the rest of the picture is drawn in crayon. The colors are softened off and blended by the finger, with the assistance of a stump of leather or paper; and shading is produced by cross-hatching and stippling. The paper employed is of loose but not soft or spongy texture, and is of various tints, warm grey or yellowish being generally preferred. For portraits pumice-paper and red or brown crayons are considered most suitable. The colors are fixed by the process known as transudation. The drawing is supported face downwards by its edges or corners, and a solution of isinglass is applied to the back with a brush in quantity sufficient to penetrate to the colored surface of the paper, which may then be turned upwards to dry. The fixing-solution is prepared as follows:—three-quarters of an ounce of isinglass is infused for a day in 2½ ounces of pure vinegar; a pint of hot water is added, and the solution of isinglass is filtered and mixed with an equal volume of spirits of wine. The art of painting in crayons or pastils is supposed to have originated in Germany in the 17th century. By Johann Alexander Thiele (1685–1762) it was carried to great perfection, and in France it was early practised with much success. Amongst celebrated crayon-painters may be mentioned Carriera Rosalba (1675–1757), W. Hoare (1707–1792), F. Cotes (1726–1770), J. Russell (1744–1806), and the late Mr. Bright.

CREAM OF TARTAR, acid potassium tartrate, or "bitartrate of potash,"  $\text{HKC}_2\text{O}_6\text{H}_4$ , is obtained from argol or crude tartar, the crust or deposit formed by wines in bottles and casks in which they are undergoing fermentation. Red are usually richer in argol than white wines. A ton of grapes yields, according to the nature of the fruit,

quantities varying between 1 and 2 lb of argol, of which, in good samples, an average of about 83 per cent. is cream of tartar. French red wines examined by M. Fauré contained from '06664 to '19728 per cent. by weight of this salt, and white wines from '09172 to '15208 per cent.; M. Jacob found from '7 to 1'201 grammes per litre in the wines of Tonnerre. The manufacture of cream of tartar is conducted as follows. Ground granulated argol is wetted and then dissolved in water at a temperature of 100° C.; after two or three days, during which insoluble impurities subside, the clear liquid is drawn off into earthen vessels. The crystals it deposits are re-dissolved in boiling water holding finely comminuted pipe-clay and animal-charcoal in suspension. The solution after standing till a thin film of crystals appears on its surface is run into conical coolers, the sides of which become in eight or nine days coated with fine clear crystals, coloring matters having been precipitated by the clay and charcoal. The crystals are then bleached and dried by exposure to sunlight and air. In Venice the impurities of the crude tartar are separated by repeated crystallizations, and finally by adding white of egg and wood-ashes to the boiling solution, and removing the scum formed. The name "cream of tartar" was originally given to the crust of minute pure white crystals formed on the surface of cooling solutions. Cream of tartar is a colorless, transparent salt, crystallizing in four-sided prisms belonging to the trimetric system, and having a specific gravity of about 1'96. It is precipitated when a potassium salt is added to a solution of free tartaric acid. It is soluble in alkalies, alkaline carbonates, and mineral acids, but insoluble in acetic acid and alcohol. Its insolubility in the last-mentioned is the cause of its separation from wines as they mature. One part by weight of the salt is soluble at 0° C. in about 416 (Chancel), and at 100° C. in about fifteen parts of water. The solution has an acid reaction, and dissolves many metallic oxides, furnishing double tartrates. When heated, cream of tartar is decomposed, with the formation of potassium carbonate (the *sal fixum tartari* of the older chemists) and carbon, inflammable gases possessing an odor of burnt bread being at the same time evolved. Potassium carbonate is produced also when the salt is kept moist or in a solution for some years. Cream of tartar—*potassæ tartras acidæ*—is used in medicine as a refrigerant, diuretic, and mild purgative; in dyeing as a mordant for wool; in the manufacture of tartaric acid and potassium carbonate; and with powdered chalk and alum for cleaning silver. *Rochelle salt*,  $\text{KNaC}_4\text{O}_6\text{H}_4$ , is made by neutralizing cream of tartar with sodium carbonate; *tartar emetic*,  $\text{K(SbO)C}_4\text{O}_6\text{H}_4$ , by boiling it with three-fourths of its weight of antimony trioxide, filtering the hot solution and crystallizing. *Black flux*, the result of the incineration of tartar, is much employed in assaying, and may be prepared by deflagrating two or three parts of the salt with one of nitre; for *white flux* equal weights of the two salts are required. Tartars, even those intended for the manufacture of tartaric acid, should be free from any considerable quantity of calcium tartrate, as the moisture of the air soon converts that salt into calcium carbonate. The substances most used to adulterate cream of tartar are calcium chloride and sulphate, and the chloride and acid sulphate of potassium.

CREASOTE, CREOSOTE, or KREASOTE (*κρεας*, flesh, and *σωζειν*, to save), is a product of the distillation of wood-tar, more especially that made from beech-wood; tar from the wood of conifers contains it in but small quantity. The distillation of the tar is carried on till only a thick pitchy substance is left. From the lowermost layer of the distillate is obtained by the action of sodium carbonate a yellowish oil, the heavier part of which is isolated by rectification in a glass retort, and mixed with potash solution to dissolve out its creasote. The creasote is separated from the filtered potash solution by sulphuric acid, is distilled with alkaline water, and again treated with potash and acid, till its purification is effected; it is then distilled at 200° C. (392° Fahr.), and dried by means of calcium chloride. Creasote is a highly refractive, colorless, oily liquid, first obtained by Reichenbach, in 1832, from beech-wood tar. It consists mainly of a mixture of the compounds—phenol  $\text{C}_6\text{H}_5\text{OH}$ , cresol,  $\text{C}_6\text{H}_4\text{CH}_3\text{OH}$ , phlorol,  $\text{C}_6\text{H}_3(\text{CH}_3)_2\text{OH}$ , guaiacol,  $\text{C}_6\text{H}_3\text{OCH}_2\text{OH}$ , and creosol,  $\text{C}_6\text{H}_3\text{CH}_2\text{OCH}_2\text{OH}$ . The so-called coal-tar creasote is more or less impure carbolic acid, containing paracresol and other bodies. Creasote has a strong odor and hot



taste, is a non-conductor of electricity, and burns with a smoky flame. Its specific gravity is 1.037 at 20° C.; its boiling point is 203° C. (397° Fahr.); and it is still liquid at -27° C. (-16.6° Fahr.). Rhenish creasote can be distilled for the most part between 199° and 208° C., giving a liquid of specific gravity 1.077 at 14° C. Creasote dissolves sulphur, phosphorus, resins, and many acids and coloring matters; and is soluble in alcohol, ether, and carbon disulphide; and in 80 parts by volume of water. It is distinguished from carbolic acid or phenol by the following qualities:—It turns the plane of a ray of polarized light to the right, forms with collodion a transparent fluid, and is nearly insoluble in glycerine; whereas carbolic acid has no effect on polarized light, gives with about two-thirds of its volume of collodion a gelatinous mass, and is soluble in all proportions in glycerine; further, alcoholic and ferric chloride produce with creasote a green solution, turned brown by water, with carbolic acid a brown, and on the addition of water a blue solution. Creasote, like carbolic acid, is a powerful antiseptic, and readily coagulates albuminous matter; wood-smoke and pyroligneous acid or wood-vinegar owe to its presence their efficacy in preserving animal and vegetable substances from putrefaction. Creasote is given in medicine combined with acetic acid, syrup, spirit of juniper, and water. In small quantities it acts as a sedative of the stomach, but in over-doses it is a violent poison, causing severe pain in the abdomen, nausea, headache, giddiness, and stupor. It is administered in cases of vomiting, diarrhoea, cholera, intestinal bleeding, and chronic gleet, and to assuage hunger and thirst in diabetes; in the form of a gargle it is of service in excessive salivation, and its vapor, mixed with that of water, is sometimes recommended for inhalation. Externally it is applied as a stimulant and styptic, and for the treatment of decayed teeth; and an ointment containing it is used as a remedy for ring-worm. Creasote is also employed for preserving timber from dry-rot, and for the curing of fish and hams. The principal supplies of creasote are brought from Archangel, Stockholm, and America.

CRÉBILLON, CLAUDE PROSPER JOLYOT (1707-1777), a French novelist and wit of the 18th century, was the only son of Crébillon, the tragic poet. His life was spent at Paris, except about five years, during which, on account of certain political references made in his novels, he was first imprisoned and afterwards forced to live in exile in England and elsewhere. He married an English lady of noble family, Lady Stafford, who is said to have been captivated by his person and his books, and to have offered herself as his bride. Their life is said to have been passed in much affection and mutual fidelity; and it would be unjust to judge Crébillon's private life from his novels, the immorality of which is not surpassed in literature. For some years Crébillon held the incongruous office of censor.

CRÉBILLON, PROSPER JOLYOT DE (1674-1762), a famous French tragic poet, was born at Dijon, where his father was notary-royal. Having been educated at the Jesuits' school of the town, and at the Collège Mazarin, he became an advocate, and was placed in the office of a lawyer named Prieur at Paris. The encouragement of his master, an old friend of Scarron's, induced him to continue with more serious intention his youthful habit of rhyming, and he soon produced a *Mort des Enfants de Brutus*, which, however, he failed to bring upon the stage. But in 1705 he succeeded with *Idoménée*, the representation of which gained him considerable fame; in 1707 his *Atrée et Thyeste* was repeatedly acted at court; and in 1711 he produced his finest play, the *Rhadamiste et Zénobie*, which is one of the masterpieces of the French classical tragedy. But his *Xerxes* (1714) was only once played, and his *Sémiramis* was an absolute failure. Meanwhile, in 1707, Crébillon had married a girl without fortune, who had since died, leaving him an infant son. His father also had died, insolvent. His three years' attendance at court had been fruitless. Envy had circulated innumerable slanders against him. Oppressed with melancholy, he removed to a garret, where he surrounded himself with a number of dogs, cats, and ravens, which he had befriended; he became utterly careless of cleanliness or food, and solaced himself with constant smoking. But in 1731 he was elected member of the French Academy; in 1735 he was appointed royal censor; and in 1745 Mme. de Pompadour, in her enmity to

his rival Voltaire, presented him with a pension of 1000 francs and a post in the royal library. In 1748 his *Catilina* was played with great success before the court; and in 1754, eight years before his death, appeared his last tragedy, *Le Triumvirat*. Such was the rivalry of Voltaire, that to prove his own superiority he took the subjects of no less than five of Crébillon's tragedies—*Sémiramis*, *Electre*, *Catilina*, *Le Triumvirat*, *Atrée*—as subjects for tragedies of his own. For vigor and passion Crébillon is unsurpassed in the French classical drama; his faults are want of culture and the consequent absence of classical correctness, and a want of care which displays itself in his style and even in the mechanism of his verse.

See D'Alembert, *Éloge de Crébillon*; La Harpe, *Littérature*; L'Abbé de la Porte, *Biographie de Crébillon*. There are numerous editions of his works.

CRÉCY, or CRESSY, a town of France, department of Somme, on the Maye, 12 miles N. by E. of Abbeville; though an ancient place it has now only about 1300 inhabitants. It is famous in history for the great victory gained here on the 26th of August, 1346, by Edward III., with about 30,000 men, over the French of Philip of Valois, said to be 100,000 strong, commanded by the Comte d'Alençon. The flower of French chivalry, and the king of Bohemia, fighting for France, were slain in the battle. Here it was that the Black Prince gained his spurs, and that he adopted the triple feather crest of the fallen Bohemian king, with the motto *Jeh Dieu*, still worn by our princes of Wales. This battle was one of the earliest in which cannon were used by the English. This Crécy must not be mistaken for another small town of the same name in the department of Seine-et-Marne, on the Grand Morin, 25 miles east of Paris, also an ancient place formerly fortified with double ramparts and towers.

CREDI, LORENZO DI (1459-1537), was the least gifted of three artists who began life as journeymen with Andrea del Verrocchio at Florence. Though he was the companion and friend of Leonardo da Vinci and Perugino, and closely allied in style to both, he had neither the genius of the one nor the facility of the other. We admire in Da Vinci's heads a heavenly contentment and smile, in his technical execution great gloss and smoothness of finish. Credi's faces disclose a smiling beatitude; his pigments have the polish of enamel. But Da Vinci imparted life to his creations and modulation to his colors, and these are qualities which hardly existed in Credi. Perugino displayed a well-known form of tenderness in heads, moulded on the models of the old Umbrian school. Peculiarities of movement and attitude become stereotyped in his compositions; but when put on his mettle, he could still exhibit power, passion, pathos. Credi often repeated himself in Perugino's way; but being of a pious and resigned spirit, he generally embodied in his pictures a feeling which is yielding and gentle to the verge of coldness. Credi had a respectable local practice at Florence. He was consulted on most occasions when the opinion of his profession was required on public grounds, e. g., in 1491 as to the fronting, and in 1498 as to the lantern of the Florentine Cathedral, in 1504 as to the place due to Michelangelo's David. He never painted frescoes; at rare intervals only he produced large ecclesiastical pictures. The greater part of his time was spent on easel pieces upon which he expended minute and patient labor. But he worked with such industry that numbers of his Madonnas exist in European galleries. The best of his altar-pieces is that which represents the Virgin and Child with Saints in the cathedral of Pistoia. A fine example of his easel rounds is in the gallery of Mayence. Credi rivalled Fra Bartolommeo in his attachment to Savonarola; but he felt no inclination for the retirement of a monastery. Still, in his old age, and after he had outlived the perils of the siege of Florence (1527), he withdrew on an annuity into the hospital of Santa Maria Nuova, where he died.

CRÉDIT FONCIER AND CRÉDIT MOBILIER are finance institutions, which had their origin in the joint-stock speculation and sanguine promotion of public works which marked many years of the second empire in France, and to which the introduction of limited liability in England has given a great stimulus on the British side of the Channel. The parent institutions in Paris were followed by similar establishments in some other capitals. As the terms imply, the *crédit foncier* contemplates loans and

advances on real securities, and the *crédit mobilier* on what is called with us personal or movable estate. Whether such limits and distinctions have been ever strictly observed in the practical working of these credit banks is doubtful. The *crédit mobilier* of France has had a more unfortunate experience than the *crédit foncier*, though the latter has by no means sustained the promise of its early years. While the mania of launching new projects continued, enormous profits were made, which could only be the result of heavy promotion charges, and the shares rose in value with the extraordinary liberality of the dividends. But the system of business pursued had the result of mixing the credit banks very closely with the various companies and undertakings they were promoting, and of throwing back upon them a growing mass of depreciated or unsalable securities; while the abatement or collapse of speculation restricted the business from which the main part of the former income had been derived. The rules of dividend and the value of the shares consequently fell as rapidly as they had risen. This has been the practical experience of the *crédit foncier* and the *crédit mobilier* of France, which were the first, and remain the greatest, examples of the finance companies so named. The *crédit foncier* of England (there has been no *crédit mobilier* in London) has had much the same course as the French companies; large profits for a few years were followed by increasing difficulties, and the locking up of large amounts of capital in hopeless undertakings. The Imperial Land Company of Marseilles has absorbed £260,000, the Santiago and Carril Railway £193,000, and both are failures. The directors in these circumstances have been applying the annual profits to a reserve fund, and addressing themselves to a class of loans and advances on securities differing little from that of ordinary bankers and many finance companies under various names.

CREDITON, a market town of England, county of Devon, on the Creedy, near its junction with the Exe, eight miles north-west of Exeter. Population (1871), 4222. It is situated in a narrow vale, between two steep hills, and is divided into two parts, the east or old town, and the west or new town. The church, formerly collegiate, is a noble edifice, in the later Pointed style, with a fine tower 100 feet in height springing from the centre. There are places of worship for Baptists, independents, Methodists, and Unitarians, a free grammar school with exhibitions to both universities, blue-coat, national, and infant schools, a mechanics' institution, a public library, and a newsroom. There were formerly extensive woollen and serge manufactories there, but the inhabitants are now chiefly engaged in shoemaking and agriculture. Crediton was the birthplace, about 680, of the Anglo-Saxon Winfrid, better known as St. Boniface, "the Apostle of Germany." It returned two members to the Parliament at Carlisle in the reign of Edward I., and from 909 to 1049 was the seat of a bishopric, which was afterwards removed to Exeter. Fairfax with Cromwell took possession of Crediton in 1645. The present modern appearance of the town is mainly due to the removal of the old houses by fires which occurred in 1743 and 1769.

CREECH, THOMAS (1659-1701), an English translator from the classics, was born at Blandford near Sherborne in Dorsetshire. He studied at Wadham College, Oxford, and obtained a fellowship first in that college and afterwards at All Souls'. In 1699 he received a college living, but not more than two years after he hanged himself. The immediate cause of the act was not improbably a money difficulty, though according to some it was a love disappointment; but Creech was naturally of a melancholic temper. Creech's fame rests on his translation of Lucretius, in which, according to Otway, the pure ore of the original "somewhat seems refined." But in truth the commonplace equality of its rhymed heroic couplets, the chief merit of which is their straightforward simplicity, is very far from being an adequate translation of the powerful poetry of Lucretius; and even the easy mechanism of the rhyme is faulty in innumerable cases. Creech's version of Horace, which is still less adequate, was a failure from the first. He also translated the *Idylls of Theocritus*, the *Thirteenth Satire* of Juvenal, the *Astronomicon* of Manilius, and parts of Plutarch, Virgil, and Ovid. Creech's edition of the text of Lucretius, with notes borrowed from Lambinus and Faber, has been much used.

CREEDS, or CONFESSIONS OF FAITH, may be defined

as authorized formularies of Christian doctrine. The three ancient or, as they are sometimes called, oecumenical creeds are the most important, although the briefest, of such documents, and mainly call for attention in such an article as this. The more detailed confessions since the time of the Reformation will also be enumerated. But their special description belongs to the history of theology, or what the Germans call "Symbolik." Our aim is not to deal with the substance or theological import of the creeds, but only to present to the reader the most recent and satisfactory information as to their origin, history, and acceptance by the church.

Creeds are a gradual growth in the history of the Christian church, but their rudiments may be said to have existed from its first foundation,—from the answer of St. Peter to our Lord, when asked "Whom do men say that I am?" "Thou art the Christ" (Mark viii. 27-29); or the statement of St. Paul in the Epistle to the Romans (x. 9), "If thou shalt confess with thy mouth the Lord Jesus, and shalt believe in thine heart that God hath raised Him from the dead, thou shalt be saved." All subsequent confessions of faith are in fact more or less expanded developments of the original baptismal formula, derived from the commission given by Christ to the apostles in the conclusion of St. Matthew's Gospel (xxviii. 19):—"Go ye therefore and teach (make disciples of) all nations, baptizing them in the name of the Father, and of the Son, and of the Holy Ghost." From this simple acknowledgment of the threefold Name, possibly from the still simpler acknowledgment of Jesus as "the Christ" or Messiah, have sprung all the more elaborate *credena* of the Christian church.

I. Writers on the creeds have professed to find in the later writings of the New Testament traces of a more definite summary of belief: as in the allusions of the 2d Epistle to Timothy (i. 13) to a "form of sound words;" and "the deposit," or "good deposit," which was to be kept (1 Tim. vi. 20; 2 Tim. i. 14); also in the "faithful words" or "sayings" enumerated in the first and second of these epistles (1 Tim. i. 15; ii. 1; iv. 8, 9; 2 Tim. ii. 11), and a remarkable passage in the opening of the sixth chapter of the Epistle to the Hebrews. But it may be questioned how far any of these passages have anything beyond a general meaning. It must certainly be held doubtful whether, supposing they did point to any articles of faith beyond the original statement of the baptismal formula, they could be held to apply to the first apostolic age. All such inferences are two-edged,—the presumption of articulated dogma in any part of the New Testament Scriptures being one of the strongest evidences of the later or non-apostolic origin of these Scriptures.

It is not till a much later age—the age of Irenæus and Tertullian (175-200)—that we meet with any definite summaries of Christian belief. We may presume, and rightfully presume, that such summaries existed before, and were even rendered to the candidates for baptism under the form of *Traditio Symboli*; but no such summaries are traceable in Christian literature before this period. Not to speak of the doubtful genuineness of the writings appealed to—such as the alleged Epistle of Ignatius to the Trallians (c. iv.)—it is admitted by those most anxious "to demonstrate that from the earliest times there existed some form of words in the church of the character of a creed," that the passages quoted either from the writings of the Apostolic Fathers or Justin Martyr, "do not seem to have been meant to be used in this way, if we take them in conjunction with their context" (Lumby's *History of the Creeds*, p. 12). "Some fancy," says Bingham (*Origines*, b. x. c. iv.), "that the creed may be found in the writings of Ignatius, Clemens Romanus, Polycarp, and Justin Martyr. But Bishop Pearson has rightly observed that these writers, however they may incidentally mention some articles of faith, do not formally deliver any rule of faith used in their times."

It is not, then, till a good deal more than a century after the death of St. Paul and only somewhat less than a century after the death of St. John, that we meet with any definite summaries of dogmatic belief in Christian literature, and even then there is no evidence that these summaries had any authoritative character. They expressed, no doubt, the belief of the churches to which the writers belonged; but half a century after the time of Irenæus (250), it is evident from the statements of Cyprian, then bishop of Carthage, that the baptismal creed of the North African Church, which was at this period more dogmatic

In its tendencies than any other church in the East or the West, was of a comparatively brief character. The passage of Cyprian is found in one of his letters (*Ep.* 76), addressed "to Magnus, his son," on baptizing the Novatians, and implies plainly that the only addition to the original baptismal formula which had then obtained any authority in the Church of Carthage, was a clause as follows:—"Dost thou believe in the remission of sins and eternal life through the holy church?"—a clause of interrogation which, he adds, they (the Novatians) could not honestly answer "because they have no church."

The creed which is found in the well-known treatise of Irenæus against Heresies (*Adv. Hæreses*) in three different forms (i. 10, iii. 4, iv. 33) is of a far more elaborate character even in its simplest form, which is all that can be quoted here. It particularizes on the part of the true or spiritual disciple a "complete faith (*πίστις ὁλόκληρος*) in one God Almighty, of whom are all things; and in the Son of God, Jesus Christ our Lord, by whom are all things, and His dispensations by which the Son of God became man; also a firm trust in the Spirit of God, who hath sent forth the dispensations of the Father and the Son, dwelling with each successive race of men, as the Father willed" (iv. 33, § 7). The creed of Tertullian is also found in three several forms in his writings—(1) *De Præscript. Hæret.*, c. xiii.; (2) *De Virg. Veland.*, c. i.; (3) *Adv. Prax.*, c. ii.),—in the first mentioned of these writings in a more detailed form than in the others. The shortest of the three, or the creed in the treatise *De Virginibus Velandis*, may be held to be the most primitive in form. We give it as an abbreviated specimen of the others. "The rule of faith is indeed altogether one, irremovable, and irreformable—the rule, to wit, in believing in one only God omnipotent, the Maker of the universe, and His Son Jesus Christ, born of the Virgin Mary, crucified under Pontius Pilate, raised again from the dead on the third day, received in the heavens, sitting now at the right hand of the Father, about to come to judge the quick and the dead through the resurrection of the flesh as well [as of the spirit]."

In the preface to Origen's great work *De Principiis* there is also a summary of articles of faith professing to have been "clearly delivered in the teaching of the apostles," which, no doubt, fairly represents the faith of the Alexandrian Church in his time. The amplified and explanatory language of the creed, however, bears clearly the trace of Origen's own hand, and gives it even less a character of general authority than those previously mentioned.

Turning to the Church of Rome in the second half of the 3d century, we meet with the fragments of a creed in a treatise of Novatian (*De Trin.*, Migne, iii. 886) of a more simple and popular character, and corresponding, therefore, more nearly to the form which the creed ultimately assumed in the West. It only requires faith "in God the Father and Lord omnipotent, the most perfect Maker of all things; . . . also in the Son of God, Christ Jesus, our Lord God, but Son of God; . . . also in the Holy Spirit." Novatian, at first a presbyter of the Church of Rome, was afterwards a schismatic bishop, whose followers, we have seen, were placed by Cyprian beyond the pale of the church, but there seems no reason to doubt that his "Regula Veritatis" (the same form of expression, it deserves to be noticed, as that used by Tertullian) represents the Roman creed of his time.

These may be said to represent all the distinctive authorities in creed literature before the formation of an authorized creed at Nicaea in 325. There is sometimes also quoted a creed of Gregory Thaumaturgus, who was a pupil of Origen at Cæsarea in Palestine—a creed both more elaborate and precise in its theological terms than that of his great teacher; but besides that its form is rather oratorical than confessional, this creed cannot be said to present any distinctive features. It is sufficiently evident that "confessions of faith," or "rules or standards of truth," existed in the Ante-Nicene Church from the age of Irenæus, or the last quarter of the 2d century, and there is every reason to conclude that they existed even before this, although we get no trace of them in Christian literature. Candidates for baptism were, no doubt, always required to profess their belief in the name of the Father, the Son, and the Holy Ghost. But it is equally evident that there was no rule of faith universally accepted by the church or au-

thoritatively imposed by any Catholic body up to the time of the Nicene Council. Each church seems to have had its own "regula veritatis," or "confessio fidei," identical in substance, but varying in form and language, and varying even in the same church in completeness. The simpler, less detailed, or less theological forms are plainly at once the more original and the more generally or popularly accepted forms.

There is further supposed to be a marked distinction between the creeds of the Eastern and the creeds of the Western Church, although the division of Latin or Western Church is only beginning to emerge at the period we have reached. Irenæus, although a bishop of the West, was an Oriental Greek in language and theology. Hippolytus, who was bishop in or near Rome in the second half of the 3d century, still wrote and taught in Greek. Tertullian and Cyprian of the North African Church are the only representatives of Latin theology. Even thus early, however, the creeds of the Oriental Church are supposed to show a tendency to theological expansion or dogmatic adaptation which is not observable in the Western—the creed of Novatian, for example, which has been already quoted. "The Eastern creeds, while they have all along retained their characteristic notes, were at first by far the more flexible, readily adapting themselves to meet the exigencies of the church, in her maintenance of the faith once delivered to the saints against the perversions of heretics, with which the East, owing to the genius of its subtle-witted people, was infested much more than the West. . . . The case of the Western creeds was widely different. With them no council ever interfered. They were left to the custody of the several churches, while at the same time each church seems to have felt itself at liberty to make additions or alterations to some extent where occasion required." These remarks of Professor Heurtly in his *Harmonia Symbolica* (1858) point mainly to a later period than the end of the 3d century, and to a classification which he himself makes of the creeds into a Western group typified by the "Apostles' Creed," and an Eastern represented by the creed of Nicaea. But the distinction, to some extent, underlies the inchoate creeds of the Ante-Nicene Church as well, and helps us to understand the true historical order of the creeds, which has been disturbed by the traditional prestige assigned to what is known as the Apostles' Creed. There was no such creed as yet, nor till long afterwards, in the familiar form in which it is now held by the Western churches. In simplicity of structure and of thought the Apostles' may, indeed, be called the oldest of the creeds. It takes us back to the most primitive stratum of Christian belief. But as a matter of fact and chronology, what is now known as the "Apostles' Creed" is not found in anything like its present form, till four centuries after the faith of the Eastern Church was definitely settled in the Nicene Symbol. It is to this latter creed, therefore, that we must first turn our attention in historical order.

II. The circumstances in which the council of Nicaea was assembled have already been briefly sketched in the articles ARIUS and ATHANASIOS. The opinions of Arius promulgated in the commencement of the 4th century made such commotion in the church as to call forth not only the admonition of bishops, but the intervention of the imperial government in the hands of Constantine, who had professed himself a Christian, and become the patron of the peace and prosperity of the church. The distractions of the Donatist schism on the one hand, and of the Arian heresy on the other, were subjects of grave anxiety to a prince, one of whose motives in joining the rapidly increasing influence of the Christian church, as he himself professes in a letter addressed to Alexander (bishop of Alexandria) and Arius jointly, was the establishment throughout his dominions "of some one definite and complete form of religious worship." In the same letter he gave some very good advice on the subject of the prevailing religious contentions. "My advice," he says, "is neither to ask nor answer questions which, instead of being scriptural, are the mere sport of idleness or an exercise of ability; at best keep them to yourself and do not publish them. You agree in fundamentals (*περὶ τοῦ κορυφαίου*)." (Euseb., *Vit. Const.* iii. 66.) The epistolary efforts of Constantine, however, had no effect in allaying the theological dissensions of the Church of Alexandria, which, on the contrary, with the banishment of Arius spread widely throughout all the Eastern churches. The con-

<sup>1</sup> *Credis remissionem peccatorum et vitam eternam per sanctam ecclesiam?*

clusion was accordingly formed of convoking a general council of bishops in which the Catholic doctrine should be formally declared. This the first œcumenical council met at Nicæa in Bithynia in the summer of the year 325. It contained about 300 bishops. The traditional number is 318; but there is no clear evidence of the actual number, which has been variously estimated from 218 to 320. Besides prelates there was a large number of presbyters and attendants. Hosius, bishop of Cordova, the chief councillor of Constantine in the Western Church, who had been the bearer of his letters to Arius and Alexander, is supposed to have acted as president, although others probably shared this office. Eusebius, in speaking of the presidency, uses the plural number. Among the most renowned of the assembled bishops may be mentioned Alexander of Alexandria (attended by his more celebrated deacon, and subsequently his successor in the Alexandrian bishopric, Athanasius), Eustathius of Antioch, Eusebius of Cæsarea in Palestine, his namesake, and some suppose his brother, of Nicomedia, Macarius of Jerusalem, Leontius of Cæsarea in Cappadocia, Cæcilian of Carthage, Marcellus of Ancyra, Spyridion of Cyprus, and other known although less distinguished names.

There is no detailed record of the proceedings of the council. Eusebius of Cæsarea and Athanasius both wrote about it, but it is impossible to trace out in any continuous form the actual proceedings of the council, from anything that they say. "We know not," Dean Stanley says, "whether it lasted weeks or days" (*Eastern Church*, p. 129). So far as can be gathered, however, there was much discussion, untrammelled by the exercise of any external authority. Arius himself, being only a presbyter, had no seat in the conclave, but he appears to have been frequently called upon or allowed to express his opinions, his chief opponent in argument being Athanasius. At first the Arian party seem to have made a bold defence of their opinions, and to have found considerable support in the council; but ultimately they formed but a small minority. After an unsuccessful effort on their part to submit the draft of a creed, which only called forth violent disapprobation, and was in fact torn in pieces by the excited assemblage, Eusebius of Cæsarea produced a confession of faith which he had been taught in his youth as the confession of the Church of Palestine. It was favored by the emperor, and would have been accepted by the Arians; but the very fact that the Arians were disposed to accept the creed introduced by Eusebius, indisposed the orthodox party to its adoption. An expression used by his namesake of Nicomedia with the view of characterizing unfavorably the extreme orthodox position—the expression *Homoousion* (*ὁμοούσιον*)—at length became the battleground betwixt the parties. The Arians violently condemned it; the Eusebians or semi-Arians also at first strongly disapproved of it; but to the majority it became the very term they were in search of in order to discriminate their view of the relation of the Father and Son from Arianism, and accordingly it was adopted. The assent of the emperor was gained; Hosius of Cordova announced the creed of the church at length settled, and even the two Eusebii after a time gave in their adhesion to the expression, although reluctantly, and in the case of Eusebius of Nicomedia apparently with an amount of reserve which led to future difficulties.

The following are the terms of the creed as issued by the council:—

"We believe in one God, the Father Almighty, maker of all things, both visible and invisible; and in one Lord, Jesus Christ, the Son of God, begotten of the Father, *only begotten*, that is to say of the substance of the Father, God of God and Light of Light, very God of very God, begotten, not made, being of one substance with the Father (*ὁμοούσιον τῷ πατρί*), by whom all things were made, *both things in heaven and things on earth*; who, for us men and for our salvation, came down and was made flesh, made man, suffered and rose again on the third day, went up into the heavens, and is to come again to judge the quick and the dead; and in the Holy Ghost."

Then followed the clauses anathematizing the several assertions of the Arians, that "there was a time when He (Jesus Christ) was not"—"before He was begotten He was not,"—"He came into existence from what was not," and that He is of a different "person" or "substance" (*ἕτερος ὑποστάσεως ἢ οὐσίας*).

This the original form of the Nicene Creed, it will be

observed, differs considerably from what is popularly known as the Nicene Creed. Afterwards certain clauses (which we have marked in italics) were omitted, and others of more importance added, especially the present conclusion of the creed, following the simple statement in the original of belief in the Holy Ghost.

"I believe in the Holy Ghost [the Lord and Giver of life, who proceeded from the Father (and the Son), who with the Father and the Son are worshipped and glorified, who spake by the prophets. And I believe one Catholic and Apostolic Church. I acknowledge one baptism for the remission of sins. And I look for the resurrection of the dead, and the life of the world to come]."

The history of the addition of these clauses is involved in some obscurity. They have been often attributed to the Council of Constantinople which in 381 followed that of Nicæa, and the existing creed has been consequently called by the special title of the Nicæno-Constantinopolitan Creed. But, on the one hand, the enlarged creed is found in a work written by Epiphanius seven years before the date of this council (Migne, xliii. col. 232), and on the other hand there is nothing said in the canons of the Constantinopolitan Council respecting the enlargement of the creed. On the contrary, it is said in the first canon of the council that "the creed of the 318 bishops assembled at Nicæa shall not be made void, but remain for ever." The probable explanation is that the original Nicene Creed became gradually enlarged in the East, as the dogmatic instinct of the church developed under the pressure of the varying forms of Arian, Apollinarian, and semi-Arian heresy. It was deemed necessary to meet the growth of heretical opinions by additional growth of authoritative Catholic opinion, and as the additions to the creed were really expansions of its implied thought—and not in any sense arbitrary external supplements—they came to be identified with the original creed, and to pass under its name. This view of the matter is favored by the fact that the third œcumenical council, held at Ephesus in 431, chiefly for the condemnation of the Nestorian heresy, which was supposed to separate not only the natures but the person of Christ, enjoined in its seventh canon "that no person shall be allowed to bring forward, or to write, or to compose any other creed besides that which was settled by the Holy Fathers who were assembled in the city of Nicæa." As the fuller creed was almost certainly well known by this time (it having been already in existence before 381), such a statement seems only consistent with the idea that the two creeds were regarded by the Ephesian fathers as virtually identical. For the first time, at the Council of Chalcedon, which was held twenty years later, or in 451, the enlarged creed is found following the original and simpler form of the creed. It is appended as forming a ratification of "the same faith," and is distinctly attributed to "the 150 fathers who afterwards assembled in the great city of Constantinople" (in 381). The shorter form, or the exposition (*ἐκθεσις*) of the 318, is assigned the first place, but the other is added,—"that those things also should be maintained which were defined by the 150 Holy Fathers of Constantinople for the taking away of the heresies which had then sprung up, and the confirmation of the same, our Catholic and apostolic faith."

At the same time there is evidence, from what took place at the council, that there was still a large number of bishops who greatly preferred the creed in its original and simpler form, and it appears long to have maintained its ground alongside of the others in the Eastern churches. In the same churches the clause "God of God" which, appearing in the original, had dropped out of the expanded creed, was restored in course of time, although the real date of the restoration is unknown; and in addition to this clause the well-known "filioque" clause was added by the Western churches at the Council of Toledo in the year 589. From this date no changes have been made in the "Nicene" Creed. It has remained without the "filioque" clause the œcumenical creed of the Eastern Church; and with the addition of this clause it has taken its place amongst the three great creeds of the Western Church.

III. What is known as the "Apostles" Creed claims our notice next as the second of the three œcumenical creeds in chronological order. The growth of this creed is involved in considerable obscurity. The tradition which ascribes it to the apostles themselves, it is needless to say, has no

authority, and does not reach beyond the 5th century, if it can be carried back so far. The definite source of the legend is supposed to be two sermons spuriously attributed to St. Augustine, and found in the appendix to his works. In point of fact, as we have already seen, the creeds prevalent in the Roman and North African Churches, the original representatives of Latin Christendom, were of the briefest character up to the end of the 3d century. The creeds of Cyprian and Novatian already quoted are specimens. The first example of a more expanded creed after the manner of the "Apostles" is to be found singularly enough in a Greek writer, Epiphanius, who in the 72d book of his *Treatise on Heresies* quotes the confession of faith presented by Marcellus, bishop of Ancyra in Galatia, to Julius, bishop of Rome, as follows,—“I believe in God the Father Almighty; . . . and in Jesus Christ, His only begotten Son, our Lord, who was born of the Holy Ghost and the Virgin Mary, who under Pontius Pilate was crucified and buried, and on the third day rose from the dead, ascended into heaven, and sitteth at the right hand of the Father, whence He is coming to judge the quick and the dead; and in the Holy Ghost, the Holy Church, the remission of sins, the resurrection of the flesh, everlasting life” (Epiphanius, *Hær.* 52).

Marcellus had been one of the most active of the orthodox party at the Council of Nicea, and on his return to his diocese had distinguished himself with such zeal against the Arians that he was accused of having fallen into the opposite error of the Sabellians. He was accordingly deposed from his see by a synod held at Constantinople in 336, and betook himself to Rome. It was while there, and with the view of exhibiting his orthodoxy, that he addressed to Julius the above profession of faith, which he describes as the faith which he “learnt and was taught from the Holy Scriptures.” As he was himself a Greek he probably expressed himself in the Greek language. In any case, it is in Greek that the creed has been preserved to us.

It has been doubted from this circumstance, as well as from the position of Marcellus himself, whether his creed can be taken as representing the Roman creed of the time to which it belongs. It has been supposed too expanded for this, as it is beyond question that “the Roman Church used at baptism, and still uses, a much less elaborate form.” It is not improbable, however, that while the earlier and briefer form was retained in the baptismal service, a larger formulæ of faith had also grown up from the original simplicity of this form, in obedience to the general growth of the dogmatic sentiment in the West as in the East. It is certain that within half a century from this date, or about the year 390, there is to be found a creed equally detailed—the creed not merely of the Church of Aquileia of which Rufinus was a presbyter, but of the Church of Rome, with which he compares the other, pointing out the differences betwixt the two. Still in neither of these creed-forms, nor yet in those found in the writings of St. Augustine, do we approach the complete detail presented by the Apostles’ Creed as now received. The chief clauses wanting are those relating to the descent into hell and the communion of saints. Generally also, the expression descriptive of the church is simply “The Holy Church,” instead of the “Holy Catholic Church.” “The earliest creed to be met with entirely identical with the present formula occurs in a short treatise published by Mabillon from an ancient manuscript entitled ‘*Libellus Pirminii de singulis libris canonicis Scarapsus (scriptis?)*.’ . . . “The creed occurs twice in Pirminius’s treatise. In the first instance the story is repeated of the several articles having been contributed each by a several apostle, and each article is assigned to its supposed contributor. The other creed, which is identical with the former, is given as it was used in the baptismal service” (Heurtly, *Harmonia Symb.* pp. 70-71). There is little known of the life of Pirminius, but he seems to have been active as a missionary in France and Germany in the 8th century, and the date of his death is “about the year 758.” Although the “Apostles’” Creed was no doubt substantially in existence long before this, probably from the end of the 4th century, there is no historical evidence of its reception in its completed form till this period, or about the middle of the 8th century, or more than four centuries later than the original form of the Nicene Creed.

IV. The history of the “Athanasian” Creed, or the

“Symbolum Quicumque,” as it is often called, opens up a more doubtful inquiry than that of either of the preceding creeds. The evidence before us is of an entirely different character. “Here,” as it is said by a recent writer on the subject (Lumby, in his *Hist. of the Creeds*, p. 186), “is neither the synodical authority of the former, nor the gradual growth of the latter; but when the composition appears for the first time as a document of authority, it is cited in its completeness, and as the work of the father whose name it has since for the most part borne, although it was not brought to light for many centuries after his death.”

In one opinion all investigators are now agreed,—that the so-called “Athanasian” Creed is not the production of the famous father of the 4th century whose name it bears. The conclusive reasons against this supposition may be stated as follows:—(1) There is no trace of such a creed in any of the older MSS. of the works of Athanasius; (2) Athanasius himself (*Ep. ad Antioch.*, i. 2.), in consistency with the prevailing church sentiment of his time, expressly disclaims as superfluous the use of any creed except the Nicene; (3) the original language of the “Athanasian” symbol is clearly Latin and not Greek; (4) the symbol was entirely unknown to the Greek Church up to the year 1000; and (5) there is no evidence of its existence even in the Latin Church before the end of the 8th or the commencement of the 9th century.

This last and all-important fact has been completely established by recent investigations. Dr. Swainson particularly, in his elaborate volume on the Creeds (1875), has exhausted all the historical evidence on the subject, and, while not venturing to assign the creed to a definite author, has proved in the most conclusive manner that the existence of the creed cannot be traced before the age of Charlemagne, and that its origin is almost certainly to be ascribed to the demand then existing for a more detailed exposition of the faith than was to be found in the Apostles’ Creed. Nor does he hesitate to ascribe its origin to a deliberate purpose of imposture similar to that which led in the same age to the forgery of the famous “false Decretals,” and the equally famous “Donation of Constantine.” He expresses himself as follows:—“We have four or five independent lines of witnesses agreeing in bringing forward the Quicumque into notice within five and twenty years before or after the death of Charlemagne:—i. the testimony of quotation; ii. testimony of canons; iii. testimony of literary collections of creeds or rules of faith; iv. testimony of psalters; v. testimony of versions. . . . That the production of this work under the name of Athanasius was an intentional and deliberate attempt to deceive, no reasonable person can question. It was analogous to the production of the forged Decretals. And it is doubtless to the skill with which the imposture was wrought out that we owe the difficulty that has been felt in discovering the author” (Swainson, pp. 380-381). Other writers, such as the Rev. E. S. Ffoulkes (*On the Athanasian Creed*), and Mr. Lumby, whose compact and interesting volume on *The History of the Creeds* has been already quoted, come virtually to the same conclusion as to the date of the Athanasian symbol. Mr. Ffoulkes has formed, indeed, a peculiar theory as to its authorship by Paulinus, bishop of Aquileia, in the end of the 8th century,—a conclusion which is repudiated by Dr. Swainson. They agree, however, that there is no evidence of its existence before this time. It may be useful to give a brief summary of the reasons for this conclusion.

And first a distinction must be made. What these writers, of course, mean is that there is no satisfactory evidence of the existence of the Athanasian symbol as constituting a distinct creed before the time to which they refer its origin. Many of the dogmatic expressions or formulæ of the creed by themselves must be admitted to have been in existence long before. The expressions were, in fact, current in the schools of the Western Church, more or less from the time of Augustine, to whose famous treatise *De Trinitate*, not a few of them have been specially attributed. This is the real explanation of the supposed traces of the Athanasian symbol in these earlier times. Language, similar to that which it ultimately embodied had been accumulating for centuries as the natural result of the study of Augustine and the increasing pressure of Arian modes of thought from many quarters. This process of theological definition had been advanced by such

men as Hilary, bishop of Arles (429), Vicentius of Lerins (434), and Vigilius of Thapsus (500), to whom severally the authorship of the Quicunque has been ascribed. The ascription rests in each case on certain plausibilities arising, among other things, out of a common stratum of dogmatic phraseology. But such phraseology had really become a common property of the church of that time, and is to be found in the confessions of synods and collections of sermons and books of devotion from the 5th century downwards. Nothing definite as to the authorship of the Quicunque can be rested on such resemblances, or even on the use of the name of Athanasius. The fact remains that during all this time, and long afterwards, there is no evidence of such a *creed being in existence or having any authority.*

The first traces of such a creed are reached in the 8th century. Then in distinct quarters there come before us the two parts of the creed now in use. The first part, down to the end of the 26th clause, which specially deals with the doctrine of the Trinity, seems then to have existed by itself under the general title of "Fides Sanctæ Trinitatis," and "Fides Catholica Sanctæ Trinitatis." The second part, which treats of the incarnation of our Lord, is in a similar manner found by itself in a MS. known as the Colbertine MS., which cannot be placed earlier than 730. But the two parts are not as yet found in combination, nor as claiming any distinctive symbolic authority. They seem rather put forward as expositions or explanations of the original Nicene doctrine than as new creeds having any authority by themselves. The two documents not only exist apart, but they are evidently regarded by those who use them as separately independent and complete.

That there was no authoritative "Athanasian" Creed, such as we now have, even at the end of the 8th century, is held to be clearly proved by what occurred at the several councils of the church, which were held both in the East and the West at this time. In 787 there was held once more at Nicea what is reckoned by the Church of Rome the seventh oecumenical council. At this council there were recited three several confessions amplifying in several details what is known as the Niceno-Constantinopolitan Creed. These amplified confessions, attributed to different bishops, all indicate the prevailing need that was felt for some more detailed exposition of the doctrine of the Trinity; but the fact, not only that the "Athanasian" symbol does not make its appearance amongst them, but that, when the synod at last comes to recite its own belief, it does so in a form quite distinct from the "Athanasian," and finally falls back upon the old Creed of Constantinople, to which it refuses to make any addition, plainly serves to show that this symbol or exposition could not even have been known to the Eastern Church at this time, and still less have acquired any authority.

But the Councils of Frankfort (794) and of Friuli (796) are still more decisive. For here in the West and in the centres of ecclesiastical activity which marked the age of Charlemagne, the Quicunque, if known anywhere, may be supposed to have been known and recognized. All the prominent characters of Western Christendom—the Emperor Charles himself, and his two chief counsellors, Alcuin and Paulinus of Aquileia—took part more or less in these councils. Paulinus was "the episcopal soul of the Council of Frankfort, and president as well as soul of that of Friuli. No movement could have taken place in Italy, France, or Germany in matters ecclesiastic, nor any document have been set forth of such importance as the Quicunque, that could have escaped the knowledge of Paulinus and Alcuin." In these circumstances the absence of all allusion to the Quicunque in the records of these councils is fatal to the idea of its authoritative acceptance as a creed at that time. Not only so, but a form of faith which is found in the records of the Council of Frankfort, and which is supposed to have been composed either by Paulinus himself or under his guidance, shows by its language that he could not have been familiar with any such document as the Quicunque, for the obvious reason that it would have served his purpose better than the form which he uses. In this document "he deals both with the doctrine of the Trinity and the Incarnation, and puts his expressions on one occasion into the exact language used in the Athanasian Creed, which language was, no doubt, current in a separate form long before; but he never attains to anything like the pre-

cision which is exhibited in the creed, and which had it been known to him, must have commended that work to his use. And there is not to be found the slightest notice of Athanasius in the whole proceedings of the council." From a further document of the same council, a synodical letter which the bishops of Gaul and Germany addressed to those of Spain, it is also evident that they were equally with Paulinus ignorant of any such authoritative exposition of the Catholic faith as the Quicunque. And to complete the evidence on the subject there is a letter of Charlemagne himself to the bishops of Spain, which indicates with equal clearness that, while his mind was full of many expressions similar to those in the creed, he yet had no knowledge of such an authoritative document to which he could appeal in advising them as to the details of the Trinitarian doctrine.

In summing up the subject we cannot do better than quote the words of Mr. Lumby, whom we have already so far quoted:—

"The evidence which presents itself two years later seems to make it more clear that the Quicunque was unknown to the great minds of the West. The Council of Friuli met 796 A.D., and, as we have before said, its assembly was for the discussion of the doctrines of the Trinity and the Incarnation. The president and summoner of the council was Paulinus, and it is with his speech that we are concerned. After some preamble, in which he observes that his first idea is to set forth 'the very text of the creed' as a law and rule for the direction of their proceedings, he goes on to consider what the next step is to be. And he would first clear away some objections. 'For I believe,' says he, 'that in the records of some synods it is laid down . . . that no one may lawfully teach or frame another symbol of our faith. Far be it from us, as far be it from every faithful heart, to frame or teach another symbol of faith, or in another manner than they (the holy fathers of Nicea) appointed. But according to their meaning we have decreed to deliver in exposition these matters which haply on account of the brief statement of the truth are less understood by the simple and unlearned than they ought to be.'

"Here then is the definite confession of a want which the Quicunque would have supplied. The symbol by itself is too compendious—it needs exposition—the unlearned and simple do not sufficiently understand it; and for their sakes a longer and more explanatory treatise is to be prepared, adhering to the meaning of the fathers, who put forth the full creed. *In half a century or little more after these words were uttered, it can be shown that our form of the Athanasian Creed was known and used and looked upon as a most satisfactory exposition of the doctrines in debate at Friuli.* Can it be believed, that if it had been known to Paulinus and the fathers there assembled, they would not have welcomed it as a most excellent comment on the Trinity and the Incarnation, and as the most opportune solution of all their difficulties?"

The address or exposition with which Paulinus followed up his announcement is then given. It is too long to insert here, but it lays down the lines on which the Quicunque may be said to have been fashioned. "Many attributes and qualities are predicated of the Father, then a repetition of the same, and their predication of the Son and of the Holy Ghost,—not indeed in the detached way in which each separate predication is dealt with in the Quicunque, but yet evidently a step in the direction of that greater elaboration and distinctness."

The results, therefore, of the most recent investigations into the subject may be stated as follows. In the very end of the 8th century the Quicunque is unknown as a creed-document. It is nowhere mentioned at synods whose special business was to discuss the subject matter which it afterwards sets forth with such elaborate and authoritative detail. But during this century there are found in separate forms two documents which, when combined, constitute the framework of our present creed. The discussions of the time had a tendency to bring forward all contributions towards the explanation or fuller settlement of the doctrines of the Trinity and the Incarnation. Addresses like those of Paulinus, and the correspondence betwixt him and Alcuin and Charlemagne himself, all point to the necessity of some authoritative exposition of the old and simpler creed. The demand seems to have created the supply; and accordingly, before the end of the following century, in its third quarter there is evidence of the existence of the Athanasian symbol in the very words as nearly as possible which are now used. This evidence is found in a prayer-book of Charles the Bald, written about 870. "The Quicunque then had not only been compiled.

but had by this time made itself reputation enough to be included in the service-book. If twenty years be allowed for the gaining of acceptance, the date is carried back to the middle of the century, or 850 A. D." But there are two earlier MSS., showing more variations from the present form than is presented by the copy in the prayer-book of Charles the Bald. These point to an earlier stage of growth in the document, and the limits of the period during which the two parts of the Quicumque, previously, as we have seen, in separate existence, were probably combined and moulded into a creed claiming general acceptance, may be therefore carried back to the first quarter of the century, 800-825. The creed, in short, appears to have been the response of the Christian consciousness of the age immediately following that of Charlemagne to the necessity for such an authoritative exposition of the faith to which this age everywhere testifies. So far, of course, there is no question of imposture in its origin. Imposture is not the name to give to such a natural and inevitable result of the working of the mind of the Western Church towards a more elaborate and detailed confession of its Trinitarian faith. The imposture consists not in the rise of the creed, nor yet in the acceptance of its ambitious formula, but in the ascription of it, probably not without the concurrence of the heads of the church, to a name with which it must have been known to have nothing to do. This was done, no doubt, with the view of securing to it credit and authority, and was supposed to be justified by its special doctrinal import, but it was none the less an assumption, the fictitious character of which could hardly have been unknown to those who first used the creed and gave it currency in the church.

With the adoption of the "Athanasian" symbol the creed-formations of the early and mediæval church terminate. Nor is it to be forgotten of the three so-called "Catholic" creeds, that only one of them is in the broadest sense "Catholic" or "Œcumenical." Neither the "Apostles'" nor the "Athanasian" Creed is known to the Greek or Oriental Church, which remained faithful to the faith "settled by the Holy Fathers" at Nicæa, or at least to the faith as subsequently enlarged to its present form (with the exception of the "filioque" clause). No doubt, in the East as well there were in circulation many expositions of the Nicene doctrine, called forth by the same doctrinal necessities as prevailed in the West. The proceedings of the Second Council of Nicæa (787), to which we have already adverted, sufficiently show this. But none of these expositions attained to any general acceptance, or rose as in the West to the same authoritative level as the ancient creed. It remained alone in its eminence, protected by the denunciations which the third council, which assembled at Ephesus in 431, directed against clergymen or laymen "who shall dare to compose any other creed." Of all Christian creeds, therefore, the Nicene or Niceno-Constantinopolitan is the only really "Catholic" or Œcumenical creed, deliberately discussed and adopted by the representatives of the universal church. The two others associated with it in the services of the Western Church have not only never had acceptance beyond the range of that church, but are very gradual *growths* within it, without any definite parentage or deliberate and consultative authority. They emerge gradually during many centuries from the confusions and variations of Christian opinion, slowly crystallising into definite shape; and such authority as belongs to them is neither primitive nor patristic. It is the reflected assent of the later church in the West, and the uncritical patronage of a comparatively ignorant age, which have alone elevated them to the same position as the faith defined at Nicæa, which is the only truly Catholic or universal symbol of the universal church.

V. After the Reformation a new era of creed-formations, or confessions of faith, set in. The process of exposition out of which we have seen the "Athanasian" symbol to have gradually risen, became once more urgent, not only in the disrupted branches of the church, which were called into existence by the activity of the several Reformers, but also in the Roman Church, from which the churches of the Reformation were broken off. As we said at the outset, we cannot do more here than present a summary of the many confessions which then sprung up. And here, as in the previous part of this article, the best principle of arrangement will be the chronological, not merely because this order is most suitable to our plan, but because

it really sheds most light on the formation of the several documents, and alone brings them into rightly intelligent relation to one another. We will hardly be able to do more than enumerate the titles and the dates of the multiplied confessions of the Reformed churches. But even this will be more than the English reader can readily find elsewhere in a complete form.

1. The confessions of the Lutheran church claim the first attention in chronological order. The first of these is the *Confessio Augustana*, or Confession of Augsburg, compiled by Melancthon, and presented in German and Latin to the Emperor Charles V., in 1530, in the name of the evangelical states of Germany. It consists of twenty-one articles, beginning (1) De Deo; (2) De Peccato Originis; (3) De Filio Dei; (4) De Justificatione, etc.; and ending (21) De Cultu Sanctorum. The articles are terse and significant, and express with clearness and brevity the doctrinal position of the Lutheran church. In addition to the twenty-one more positive articles, there are seven of a more controversial character, treating of the ecclesiastical abuses which Lutheranism had corrected, or, as they are called, *Abusus mutatos*, viz., (1) De Utraque Specie; (2) De Conjugio Sacerdotum; (3) De Missa; (4) De Confectione; (5) De Discrimine Ciborum; (6) De Votis Monachorum; and (7) De Potestate Ecclesiastica. Secondly, immediately following the Confession of Augsburg appeared the *Apologia Confessionis Augustanæ*, also prepared by Melancthon, in reply to a professed confutation of the original document by certain Roman Catholic divines. The Apology follows the order of the confession, but sometimes several articles are grouped together when referring to one main topic; and the Apology is thus divided into only sixteen sections, although greatly more extended, nearly five times larger, in fact, than the Confession itself. To these two primary documents were afterwards added, thirdly, the Articles of Smalkald—*Articuli Smalkaldici*—prepared by Luther himself in 1536, and signed at Smalkald by an assembly of evangelical theologians, and fourthly, the *Formula Concordiæ*, composed in 1576 after considerable doctrinal divisions had broken out in Lutheranism. This latter document was not so universally accepted as the others by the Lutheran churches, but it has always been reckoned along with them as of confessional authority. To these remain to be added Luther's two catechisms, which have also a confessional position among the Lutherans. The *Catechismus Major* and the *Catechismus Minor* were both issued in 1529, and take their place in the list of symbolic books betwixt the Smalkald Articles and the Formula Concordiæ. The collective documents are issued as a *Concordia*, or *Liber Concordiæ*, printed with the three older creeds in advance, and together they sum up the confessional theology of Lutheranism.

2. The course of the Reformation, as is well known, evoked not only the ecclesiastical but the dogmatic activity of the Roman Catholic Church, and the Council of Trent, reckoned by that church as the eighteenth Œcumenical council, was summoned in the end of 1545, in order to formulate more distinctly the doctrinal position of Roman Catholicism in opposition to Protestantism. This council sat at intervals for eighteen years, from the 13th December, 1545, to the 4th December, 1563, sometimes at Bologna, but chiefly at Trent. Its results are arranged in the forms of twenty-five sessions, each session generally dealing with an important head of doctrine in the shape of a "decretum," followed, but not always, by a series of "canons," "ut omnes sciant, non solum quid tenere et sequi, sed etiam quid vitare et fugere debeant." Hence the title under which the results of the synod are known—"Canones et Decreta Sacrosancti Œcumenici Concilii Tridentini." The *Professio Fidei Tridentinæ*, which was drawn up under Pius IV. (1564), and the *Catechismus Romanus*, published under the authority of his successor, Pius V. (1566), are considered by the Roman Catholic Church as symbolical writings of the second rank.

3. Passing to the confessions of the Reformed churches, we encounter more symbolic documents than there are churches. Nimeyer's *Collectio Confessionum in Ecclesiis Reformatis Publicatarum* contains twenty-eight confessions the most important of which may be classified as follows:—(a) Pre-Calvinian: the *Confessio Tetrapolitana*, or the confession of the four cities,—Strasbourg, Constance, Meiningen, and Landau,—composed by Martin Bucer in twenty-three articles, and presented to the Emperor Charles

V. in 1530, the same year as the Augsburg Confession was presented; the *Confessio Basiliensis*, supposed to be drawn up by Myconius at Basel in 1534; and the *Confessio Helvetica*, prepared in the same city by a company of theologians, amongst whom were Bullinger and Myconius, and presented to the Lutheran divines assembled at Smalkald in 1537; and (b) Post-Calvinian; the *Consensus Tigurinus*, and the *Confessiones Gallicana, Belgica, and Helvetica II*. The *Confessio Tigurinus*, or "Consensus mutua in re sacramentaria ministrorum Tigurinae Ecclesiae et D. J. Calvini," was intended, as its title bears, to mediate betwixt the Zwinglian and the Genevese or Calvinian doctrine of the Sacraments. It was drawn up in 1549, and consisted of twenty-six articles. The *Confessio Gallicana* has been attributed, although doubtfully, to Calvin himself. It was accepted by a Reformed synod in France in 1559, and presented in the following year to Francis II. It was confirmed at a synod in Rochelle in 1571, and remained up to modern times the confession of the French Reformed Church. The *Confessio Belgica* is said to have been composed originally as a private document by Guido of Bres in 1562. First printed in French, it soon appeared in Dutch, and gradually gained such general acceptance among the congregations in the Netherlands that it was confirmed at the Synod of Dort, 1618, as the confession of the Dutch Reformed Church. The *Confessio Helvetica II* was drawn up by Bullinger in 1564, and held in great esteem not only by the Swiss churches but by the Reformed congregations of Poland, Hungary, and Scotland. The well-known *Decrees of the Synod of Dort*, printed in 1619, also claim to be added to the series, and a host of Catechisms, which also possessed more or less confessional authority—the famous Heidelberg Catechism and the Genevese Catechism, amongst others. The Arminians had their *Confessio* or *Declaratio*, composed by Simon Episcopius about 1622, and the Socinians their Racovian Catechism, adopted, as the name bears, at Racow in Poland in 1605.

4. To this long series of Protestant confessions there remain to be added the *Thirty-nine Articles* of the Church of England, and the *Westminster Confession of Faith*, which is the doctrinal standard, not only of the Church of Scotland, but of the chief Presbyterian churches both in Britain and in America. The former were gradually prepared, chiefly it is said by Cranmer, and passed through various phases, beginning with the *ten* articles of 1536, and attaining the number of forty-two in 1552, till they were finally settled as thirty-nine (1562-1571). To this series of confessional documents also belong what are known as the *Lambeth Articles*, composed by Archbishop Whitgift in 1575, but which were never accepted as authoritative, and the *Irish Articles*, supposed to have been chiefly composed by Archbishop Ussher in 1615.

The Irish Articles form an appropriate transition to the *Westminster Confession of Faith*, which is said to have borrowed from the former some of its special phraseology. The Westminster document was the outcome of the great Puritan agitation of the 17th century, and as it is the last, so it is one of the most elaborate and finished, of the long series of Protestant confessions. The Westminster Assembly met in the autumn of 1643, and sat for upwards of five years. The Confession of Faith was completed in the third year of its existence in 1646, and laid before the English Parliament in the same year. It never attained to any position of legal authority in England. But in Scotland it was accepted in the year following its composition by the General Assembly of the Kirk, as "agreeable to the Word of God, and in nothing contrary to the received doctrine, worship, discipline, and government of this Kirk," and two years afterwards, on the 7th February, 1649, it was ratified and approved by the Estates of the Scottish Parliament. The Westminster Confession thus took the place in Scotland of the old *Scotianna Confessio Fidei* of John Knox. It retained this position of authority in 1690, when Presbyterianism was finally established in Scotland, and possesses, as we have said, symbolical authority, not only for Scottish Presbyterianism, but for the large Presbyterian churches in America and Australia which have sprung from it or own connection with it. The *Confession of Faith* extends to thirty-three chapters, ranging over the most abstruse topics of theology; and along with it are generally printed the Larger and Shorter Catechisms, which have also been approved by the General Assembly of the Church of Scotland,

but which do not possess the legal or statutory authority of the *Confession*.

The study of creeds and confessions in their theological import is known as the study of symbolical theology, a name familiar to all students of German theological literature. Winer's *Confessions of Christendom* (translated in Clark's Foreign Theological Library, 1873) and Malher's *Comparative Symbolik* (Leipzig, 1853) are specimens of this branch of theological study. For the literature of the creeds with which the article has chiefly dealt, the student may be recommended to Lumby's *History*, more than once quoted, but above all to Dr. Swainson's elaborate volume, to which we have also referred. A forthcoming work by Dr. Schaff, in three volumes, entitled *The Creeds of Christendom, with a History and Critical Notes*, will probably contain the most exhaustive discussion of the subject in English literature. (J. T.)

CREEK INDIANS. See INDIANS.

CREFELD, or KREFELD, a town of Germany, capital of a circle of the same name, in the province of Düsseldorf, twelve miles north-west of the town of that name, 125 feet above the sea. This town is one of the finest in Rhenish Prussia, being well and regularly built, while the surrounding fertile district is almost entirely laid out in gardens. It is the most important seat of the silk and velvet manufactures in Germany, and in this industry the greater part of the population of town and neighborhood is employed. There are upwards of 200 silk factories, and large quantities of silk goods are exported, chiefly to the United States. The other industries of the town, especially cotton and woollen weaving, are very considerable, and about 2000 gardens in the neighborhood give employment to a large number of workers. The manufactures to which Crefeld owes its prosperity were introduced by religious refugees from the neighboring duchy of Juliers about the close of the 17th century. Population (1875), 62,905.

CREMA, an ancient town of Lombardy, in the province of Cremona, on the right bank of the Serio and on the railway from Bergamo to Cremona, twenty-five miles E. S. E. of Milan. Population (1871), 8154. It is well built in the midst of a rich agricultural district, is inclosed by a ditch and old fortifications, and has a castle, a cathedral (of date about 1400) and numerous other churches, and several palaces. It has manufactures of lace, hats, thread, and silk; and the vicinity produces excellent flax.

CREMATION, or the burning of human corpses, may be said to have been the general practice of the ancient world, with the important exceptions of Egypt, where bodies were embalmed, Judaea, where they were buried in sepulchres, and China, where they were buried in the earth. In Greece, for instance, so well ascertained was the law that only suicides, unteethed children, and persons struck by lightning were denied the right to be burned. At Rome, one of the XII. Tables said, "Hominem mortuum in urbe ne sepelito, neve urito;" and in fact, from the close of the republic to the end of the 4th Christian century, burning on the pyre or *rogus* was the general rule.<sup>1</sup> Whether, in any of these cases, cremation was adopted or rejected for sanitary or for superstitious reasons, it is difficult to say. Embalming would probably not succeed in climates less warm and dry than the Egyptian. The scarcity of fuel might also be a consideration. The Chinese are influenced by the doctrine of Feng-Shui, or incomprehensible wind water; they must have a properly placed grave in their own land, and with this view corpses are often sent home from California. Even the Jews used cremation in the vale of Tophet when a plague came; and the modern Jews of Berlin and the Spanish and Portuguese Jews at Mile End Cemetery have been among the first to welcome the lately revived process. Probably also, some nations had religious objections to the pollution of the sacred principle of fire, and therefore practised exposure, suspension, throwing into the sea, cave-burial, desiccation, or envelopment.<sup>2</sup> Some at least of these methods must obviously have been suggested simply by the readiest means at hand. Cremation is still practised over a great part of Asia and America, but not always in the same form. Thus, the ashes may be stored in urns, or buried in the earth, or thrown to the wind, or (as among the Digger Indians) smeared with gum

<sup>1</sup> Macrobius says it was disused in the reign of the younger Theodosius. (Gibbon, v. 411.)

<sup>2</sup> The Colchians, says Sir Thos. Browne, made their graves in the air, &c., on trees.



on the heads of the mourners. In one case the three processes of embalming, burning, and burying are gone through; and in another, if a member of the tribe die at a great distance from home, some of his money and clothes are nevertheless burned by the family. As food, weapons, etc., are sometimes buried with the body, so they are sometimes burned with the body, the whole ashes being collected.<sup>1</sup> The Siamese have a singular institution, according to which, before burning, the embalmed body lies in a temple for a period determined by the rank of the dead man,—the king for six months, and so downwards. If the poor relatives cannot afford fuel and the other necessary preparations, they bury the body, but exhume it for burning when an opportunity occurs. There can be little doubt that the practice of cremation in modern Europe was at first stopped, and has since been prevented in great measure, by the Christian doctrine of the resurrection of the body; partly also by the notion that the Christian's body was redeemed and purified.<sup>2</sup> Science has shown that burning merely produces quickly what putrefaction takes a long time to accomplish; but the feeling of opposition still lingers among the clergy of more than one nation. Some clergymen, however, as Mr. Hawsis in his *Ashes to Ashes, a Cremation Prelude*, London, 1874, have been prominent in the reforming movement. The objection was disposed of by Lord Shaftesbury when he asked, "What would in such a case become of the blessed martyrs?" The very general practice of burying bodies in the precincts of a church in order that the dead might take benefit from the prayers of persons resorting to the church, and the religious ceremony which precedes both European burials and Asiatic cremations, have given the question a religious aspect. It is really a sanitary one. The disgusting results of pit-burial made cemeteries necessary. But cemeteries are equally liable to overcrowding, and are often nearer to inhabited houses than the old churchyards. There is indeed a disposition to build villas near ornamental cemeteries. It is possible to make a cemetery safe approximately by selecting a soil which is dry, close, and porous, by careful drainage, and by rigid enforcement of the rules prescribing a certain depth (8 to 10 feet), and a certain superficies (4 yards) for graves. But one has only to read such a work as Baker's *Laws Relating to Burial* to see how many dangers burial legislation has to contend with. A certain amount of irreparable gas will escape into the air, or into sewage drains, and thus reach houses, or will percolate so as to contaminate water which is afterwards used. The great Paris cemeteries inflict headache, diarrhoea, and ulcerated sore throat on their immediate neighbors; and a great mass of similar well-authenticated facts may be brought against even recent cemeteries in various countries. A dense clay, the best soil for preventing the levitation of gas, is the worst for the process of decomposition. The danger is strikingly illustrated in the careful planting of trees and shrubs to absorb the carbonic acid. Vault-burial in metallic coffins, even when sawdust charcoal is used, is still more dangerous than ordinary burial. It must also be remembered that the cemetery system can only be temporary. The soil is gradually filled with bones; houses crowd round; the law itself permits the re-opening of graves at the expiry of fourteen years. We shall not, indeed, as Browne says, "be knaved out of our graves to have our skulls made drinking bowls and our bones turned into pipes!" But on this ground of sentiment cremation would certainly prevent any interruption of that "sweet sleep and calm rest" which the old prayer that the earth might lie lightly has associated with the grave. And in the meantime we should escape the horror of putrefaction and of the "small cold worm that fretteth the enshrouded form."

For the last ten years many distinguished physicians and chemists in Italy have warmly advocated the general adoption of cremation, and in 1874, a congress called to consider the matter at Milan resolved to petition the Chamber of Deputies for a clause in the new sanitary code, permitting cremation under the supervision of the syndics of the commune. In Switzerland Dr. Vegmann Ercolani is the champion of the cause (see his *Cremation the most Rational Method of Disposing of the Dead*, 4th ed., Zurich, 1874), and there are two associations for its support. So long ago as 1797

cremation was seriously discussed by the French Assembly under the Directory, and the events of the Franco-Prussian war have again brought the subject under the notice of the medical press and the sanitary authorities. The military experiments at Sédan, Chalons, and Metz, of burying large numbers of bodies with quicklime, or pitch and straw, were not successful, but very dangerous. The matter was considered by the municipal council of Paris in connection with the new cemetery at Méry-sur-Oise; and the prefect of the Seine in 1874 sent a circular asking information to all the cremation societies in Europe. The municipality of Vienna has actually made cremation permissive. There is a propagandist society, called the "Urne," and the main difficulty for the poor seems to be the cost of conveying the bodies five miles. To overcome this a pneumatic tube has been proposed. Dresden, Leipsic, and Berlin are the centres of the German movement, and Professor Reclam's *De la Crémation des Cadavres* seems to be the most important work. In Britain the subject has slumbered for two centuries, since in 1658 Sir Thomas Browne published his quaint *Hydrotophia, or Urn-burial* (see edition by St. John, London, 1838), which was mainly founded on the *De Funere Romanorum* of the learned Kirchnermann. In 1817 Dr. J. Jamieson gave a sketch of the "Origin of Cremation" (*Proc. Royal Soc. Edin.*, 1817), and for many years prior to 1874 Dr. Lord, medical officer of health for Hampstead, continued to urge the practical necessity for the introduction of the system. It was Sir Henry Thompson, however, who first brought the question prominently before the public, and started in 1874 the Cremation Society of London. Its object is to introduce through the agency of cemetery companies, and parochial and municipal authorities, and burial boards, some rapid process of disposing of the dead, "which cannot offend the living and shall render the remains absolutely innocuous." Thompson's problem was—"Given a dead body, to resolve it into carbonic acid, water, and ammonia, rapidly, safely, and not unpleasantly." Relying on the evidence which suggested recent burial legislation (see *Report to the General Board of Health on a General Scheme for Extra-mural Sepulture*, Clowes and Son, 1860, signed by Lord Shaftesbury, Chadwick, and Southwood Smith; also Walker *On Graveyards*, Longmans, 1839), he pointed out that in the neighborhood of cemeteries there is a constantly increasing risk of contaminated air and water. The problem he solved by the Siemens process of cremation, which, when generally employed, would effect a great saving in the cost of funerals, and would also leave a quantity of bone earth equal in value to the bones imported into this country chiefly for manure. The British authorities in India have already had much practical experience of cremation. Poor Hindus often did not supply wood and oil (ghee) enough for the total consumption of the body, and hence Sir Cecil Beadon at Calcutta, and the sanitary commissioner of Madras, both found it necessary in the public interest to erect cinerators on the burning ghat or ground (Latin, *ustrina*), which might be used on payment of a fee. So also at Poonah, Colonel Martin struck with the high cost (above 12 rupees) of even a poor funeral, constructed in 1864 a pentagonal cinerator for the use of Brahmans and the other Hindu castes. The idea is spreading rapidly in New York.

Among the practical methods of cremation which have recently been attempted, we may mention, in the first place, the experiments of Dr. Polli at the Milan gas works, which have been fully described in Dr. Pietra Santa's book, *La cremation des morts en France et à l'étranger*, and those of Professor Brunetti, who exhibited an apparatus at the Vienna Exhibition of 1873, and who states his results in *La Crematione dei Cadaveri*, Padua, 1873. Polli obtained complete incineration or calcination of dogs by the use of coal-gas mixed with atmospheric air, applied to a cylindrical retort of refracting clay, so as to consume the gaseous products of combustion. The process was complete in two hours, and the ashes weighed about 5 p. c. of the weight before cremation. Brunetti used an oblong furnace of refracting brick with side-doors to regulate the draught, and above a cast-iron dome with movable shutters. The body was placed on a metallic plate suspended on iron wires. The gas generated escapes by the shutters, and in two hours carbonisation is complete. The heat is then raised and concentrated, and at the end of four hours the operation is over; 180 lb. of wood costing 2s. 4d. sterling was burned. In the reverberating furnace used by Sir Henry Thompson a body, weighing 144 lb. was reduced in fifty minutes to about 4 lb. of limadust. The noxious gases, which were undoubtedly produced during the first five minutes of combustion, passed through a

<sup>1</sup> In the case of a great man there was often a burnt offering of animals and even of slaves. (See Cæsar, *De Bell. Gall.* iv.)

<sup>2</sup> A temple of the Holy Ghost (see Tertullian, *De Anima*, c. 61, cited in Müller, *Les des Kirchenrechts*, s. v. "Begräbnisse").

flue into a second furnace and were entirely consumed. In the ordinary Siemens regenerative furnace (which has been adapted by Reclam in Germany for cremation, and also by Sir Henry Thompson) only the hot-blast is used, the body supplying hydrogen and carbon; or a stream of heated hydrocarbon mixed with heated air is sent from a gasometer supplied with coal, charcoal, peat, or wood,—the brick or iron-cased chamber being thus heated to a high degree before cremation begins. In one arrangement both gas and air are at a white heat before they meet and burst into flame in the furnace. The advantages of the Siemens furnace and gas producer (which would cost about £800 in construction) are that the heat of the expended fuel is nearly all retained by the regenerators, and that the gas retort admits of the production being stopped without much loss. Some difficulty has been felt about keeping the ashes free from foreign material. The Greeks used a shroud of asbestos, the Egyptians one of amianth. Mr. Eassie suggests a zinc coffin,—that metal being volatile. It is also suggested that the ashes might be deposited in urns, and these placed in a columbarium which might be in the church or at home.

See Eassie, *Cremation of the Dead*, London, 1875,—a valuable book in which nearly every source of information on the subject is indicated. (w. c. a.)

CREMONA, a province of Lombardy, Italy, lying between the Rivers Oglio and Adda, north of the Po, which separates it from Parma and Piacenza. It is conterminous along the Oglio on the north-east with Mantua and Brescia, and with Bergamo on the north; the Adda separates it from Milan on the west. It is about fifty miles in extreme length from north-west to south-east, and fifteen miles in width, containing 632 square miles, and (in 1871) 300,595 inhabitants. The surface is level, and the soil very fertile, producing abundant crops of wheat, rice, maize, and flax. Horses and black cattle are numerous, and silk is an extensive production, but the sheep are few. There are no important manufactures carried on except the spinning of silk.

CREMONA, the capital of the above province and the seat of a bishop, is situated on the north bank of the Po, crossed there by a bridge, 46 miles south-east of Milan; lines of railway unite it north and westward with Brescia, Bergamo, Pavia, and Milan, and eastward with Mantua. It is well built, of an oval shape, about six miles in circumference, and surrounded by walls flanked with towers and wet ditches. It possesses many good buildings, principally churches, richly adorned with frescoes and paintings by native artists. The cathedral is an ancient structure, begun in 1107 and completed in 1606, thus including very various styles of architecture. The interior is composed of a nave, with two aisles, divided by eight immense pillars, and is gorgeously colored and gilded. Near the cathedral is the great tower, the *Torrazzo*, erected 1261–1284, the highest in northern Italy, being 396 feet in height. In the third story is an enormous astronomical or astrological clock. The *Palazzo Pubblico*, also a relic of old Cremona, begun in 1206, contains a few paintings by old masters. Cremona has also civil, criminal, and commercial tribunals, a lyceum, a gymnasium, a theatre, a public library, hospitals, asylums, and other charitable institutions, and numerous schools. Its manufactures include silks, cottons, porcelain, earthenware, and chemical products. It has a considerable trade by the Po, which is navigable thence to the Adriatic, in agricultural produce, oil, wax, honey, and silk; and the surrounding district is noted for its superior flax. It was formerly celebrated for its violins and other musical instruments, but the manufacture of these has now declined. Violins of Cremona have been known to sell at from 100 to 200 guineas each. Population, with suburbs (1871), 30,508. The site of Cremona was taken by the Romans from the Gallic Cenomani, and colonized by them at various periods. The town suffered in the invasions of the Goths and Lombards, and subsequently in the conflicts of the Guelphs and Ghibellines. In 1799 the Austrians defeated the French at Cremona.

CREOLE (Spanish, *Criollo*), is a term which primarily was used to denote an inhabitant of the Spanish colonies who was descended from the European settlers, as distinguished from the aborigines, the negroes, and mulattoes. It is now more loosely employed, the name being frequently applied to a native of the West Indies, whose descent is partly but not entirely European. A part of the colored population of Cuba are at times designated creole negroes, in contradistinction to those who were brought direct from Africa. The creole whites, owing to the enervating influence of the climate, are not a robust race, but

exhibit an elegance of gait and a suppleness of joint that are rare among Europeans.

CREON, in Greek fable, son of Lycæthus, king of Corinth, and father of Glaucus, who was beloved by Jason, and whose tragical fate he shared. See JASON and MEDEA.

CREON, in Greek fable, son of Menæceus, became king of Thebes at the death of Laius, the husband of his daughter Jocasta. Thebes was then trembling before the cruelty of the Sphinx, and Creon offered his crown and his daughter to whoever should solve the fatal enigma proposed by the monster. Oedipus, the son of Laius, ignorant of his parentage (see OEDIPUS), having accomplished the task, received the reward, and married Jocasta, his mother. By her he had two sons, Eteocles and Polynices, who mutually agreed after their father's death to reign in alternate years. Eteocles first ascended the throne, being the elder, but at the appointed time he refused to resign, and his brother attacked him at the head of an army of Argives. The war was to be decided by a single combat between the brothers, but both fell. Creon, now resuming the government during the nonage of Leodamus, the son of Eteocles, commanded that the Argives, and above all Polynices, the cause of all the bloodshed, should not receive the rites of sepulture, and that any one who infringed this decree should be buried alive. Antigone, the sister of Polynices, refused to obey, and sprinkled dust upon her brother's corpse. The threatened penalty was inflicted; but Creon's crime did not escape unpunished. His son, Hæmon, the lover of Antigone, killed himself on her grave, and Thebes was attacked by Theseus, by whose hand Creon fell. See ANTIGONE.

CREOSOTE. See CREASOTE.

CRESCIMBENI, GIOVANNI MARIO (1663–1728), critic and poet, was born at Macerata in 1663. Having been educated by a French priest at Rome, he entered the Jesuits' College of his native town, where he produced a tragedy on the story of Darius, and versified the *Pharsalia*. In 1679 he received the degree of doctor of laws, and in 1680 he removed again to Rome. The study of Filicaja and Leonio having convinced him that he and all his contemporaries were working in a wrong direction, he resolved to attempt a general reform. In 1690, in conjunction with fourteen others, he founded the celebrated academy of the Arcadians, and began the contest against false taste and its adherents. The academy was most successful; branch societies were opened in all the principal cities of Italy; and the influence of Marini, opposed by the simplicity and elegance of such models as Costanzo, soon died away. Crescimbeni officiated as secretary to the Arcadians for thirty-eight years. In 1705 he was made canon of Santa Maria; in 1715 he obtained the chief curacy attached to the same church; and about two months before he died (1728) he was admitted a member of the Order of Jesus.

His principal work is the *Istoria della volgar Poesia*, Rome, 1698, an estimate of all the poets of Italy, past and contemporary, which may yet be consulted with advantage. The most important of his numerous other publications are the *Commentarij*, 5 vols., Rome, 1702–1711, and *La Bellezza della volgar Poesia*, Rome, 1700.

CRESPI, DANIELE (1590–1630), an Italian historical painter, born at Milan, studied under Giovanni Battista Crespi and Procaccini. He was an excellent colorist; his drawing was correct and vigorous, and he grouped his compositions with much ability. His best work, a series of pictures from the life of Saint Bruno, is in the monastery of the Carthusians at Milan. Among the most famous of his paintings is a Stoning of St. Stephen at Brera, and there are several excellent examples of his work in the city of his birth and at Pavia.

CRESPI, GIOVANNI BATTISTA (1557–1663), an Italian painter, sculptor, and architect, was born at Cerano. He was a scholar of considerable attainments, and held a position of dignity in his native city. He was head of the Milanese Academy founded by Cardinal Frederick Borromeo, and he was the teacher of Guercino. He is most famous as a painter; and, though his figures are neither natural nor graceful, his coloring is good, and his designs full of ideal beauty.

CRESPI, GIUSEPPE MARIA (1666–1747), an Italian painter, called "Il Spagnuolo" from his fondness for rich apparel, was born at Bologna, and was trained under Angelo Toni, Domenico Canuti, and Carlo Cignani. He then went through a course of copying from Correggio and Barocci;

this he followed up with a journey to Venice for the sake of Titian and Paul Veronese; and late in life he proclaimed himself a follower of Guercino and Pietro da Cortona. He was a good colorist and a facile executant, and was wont to employ the camera obscura with great success in the treatment of light and shadow; but he was careless and unconscientious. He was a clever portrait painter and a brilliant caricaturist, and his etchings after Rembrandt and Salvator are in some demand. His greatest work, a *Massacre of the Innocents*, is at Bologna; but the Dresden Gallery possesses twelve examples of him, among which is his celebrated series of the Seven Sacraments.

CRESWELL, SIR CRESSWELL (1793-1863), the first judge of the English Divorce Court, was a descendant of an old Northumberland family, and was born in 1793. He was educated at the Charter House and at Emmanuel College, Cambridge, the latter of which he entered in 1810. He graduated B. A. in 1814, and M. A. four years later. Having chosen the profession of the law he studied at the Middle Temple, and was called to the bar in 1819. He joined the northern circuit, and was not long in earning a distinguished position among his professional brethren. In 1837 he entered Parliament as Conservative member for Liverpool, and he soon gained a reputation as an acute and learned debater on all constitutional questions. In January, 1842, he took his seat on the bench of the Common Pleas, being knighted at the same time; and this post he occupied for sixteen years. When the new court for probate, divorces, and matrimonial causes was established (1858), Sir Cresswell Cresswell was requested by the Liberal Government to become its first judge and undertake the arduous task of its organization. Although he had already earned a right to retire, and possessed large private wealth, he accepted this new task, and during the rest of his life devoted himself to it most assiduously and conscientiously, with complete satisfaction to the public. In one case only, out of the very large number on which he pronounced judgment, was his decision reversed. His death was sudden. By a fall from his horse, July 17, 1863, his knee cap was injured. He was recovering from this when on the 29th of the same month he died of disease of the heart.

CRESSY. See CRECY.

CREST. See HERALDRY.

CREST, a town of France, in the department of Drôme and arrondissement of Die, situated on the right bank of the River Drôme, there crossed by a fine stone bridge. It carries on the manufacture of woollens, cotton, and beetroot sugar. On the curious rock which commands the town there are some remains of the ancient castle to which it was indebted for its importance in the Middle Ages. It ranked for a time as the capital of the duchy of Valentinois, and in that capacity belonged before the Revolution to the prince of Monaco. The communal charter, dating from the 12th century, is preserved in the public archives. Population in 1872, 5568.

CRESWICK, THOMAS, an English landscape painter (1811-1869), was born at Sheffield, and educated at Hazelwood, near Birmingham. At Birmingham he first began to paint. His earliest appearance as an exhibitor was in 1827, at the Society of British Artists in London; in the ensuing year he sent to the Royal Academy the two pictures named *Llyn Gwynant, Morning*, and *Carnarvon Castle*. About the same time he settled in London, and in 1836 he took a house in Bayswater. He soon attracted some attention as a landscape-painter, and had a career of uniform and encouraging, though not signal, success. In 1842 he was elected an associate, and in 1850 a full member, of the Royal Academy, which, for several years before his death, numbered hardly any other full members representing this branch of art. In his early practice he set an example, then too much needed, of diligent study of nature out of doors, painting on the spot all the substantial part of several of his pictures. English and Welsh streams may be said to have formed his favorite subjects, and generally British rural scenery, mostly under its cheerful, calm, and pleasurable aspects, in open daylight. This he rendered with elegant and equable skill, color rather grey in tint, especially in his later years, and more than average technical accomplishment; his works have little to excite, but would, in most conditions of public taste, retain their power to attract. Creswick was industrious

and extremely prolific; he produced, besides a steady outpouring of paintings, numerous illustrations for books. He was personally genial,—a dark, bulky man, somewhat heavy and graceless in aspect in his later years. He died at his house in Bayswater, Linden Grove, December 28, 1869, after a few years of declining health. Among his principal works may be named *England, 1847*; *Home by the Sands*, and a *Squally Day, 1848*; *Passing Showers, 1849*; the *Wind on Shore*, a *First Glimpse of the Sea*, and *Old Trees, 1850*; a *Mountain Lake, Moonrise, 1852*; *Changeable Weather, 1865*; also the *London Road*, a *Hundred Years ago*; the *Weald of Kent*; the *Valley Mill* (a Cornish subject); a *Shady Glen*; the *Windings of a River*; the *Shade of the Beech Trees*; and the *Course of the Greta*; the *Wharfe*; *Glendalough*, and other Irish subjects, 1836 to 1840; the *Forest Farm*. Mr. Frith for figures, and Mr. Ansdell for animals, occasionally worked in collaboration with Creswick.

CRETE, or CANDIA, one of the largest islands in the Mediterranean, situated between 34° 50' and 35° 40' N lat., and between 23° 30' and 26° 20' E. long. It is thus the most southerly portion of Europe. By its position south of the *Ægean Sea* or Archipelago, extending to the north-west to within 60 miles of Cape Malea in the Peloponnesus,

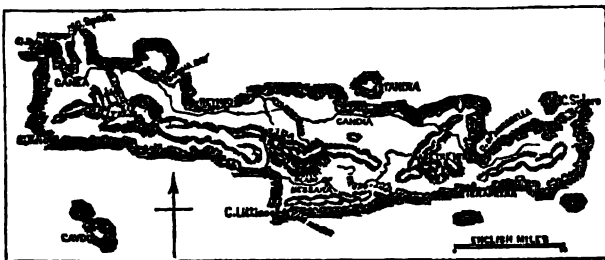

Island of Crete.

while its north-east angle is distant only about 110 miles from Cape Krio in Asia Minor (a great part of which interval is filled up by the large islands of Carpathus and Rhodes), it forms the natural limit between the Archipelago and the Mediterranean, as well as one of the chief lines of natural connection between the southern shores of Europe and Asia. The island is of a very elongated form, being not less than 160 miles in length, while its breadth does not anywhere exceed thirty-five miles, and is in some places narrowed to only ten or twelve miles.

*Mountains.*—By far the greater part of the surface of the island is occupied by ranges of mountains, some of which attain to a very considerable height. Nearly in the centre of the island rises the lofty group, or rather mass, of Mount Ida, now called Psiloriti (a corruption of *ὕψηλορείον*, "the high mountain"), which is not less than 8060 feet in height, forming a nearly isolated mass, separated by tracts of comparatively low elevation from the mountain ranges to the east and west of it. In the western portion of the island is found the range of the White Mountains (called by the natives *Madara Vouna*), the central group of which is nearly if not quite as elevated as Mount Ida, rising to a height of at least 8000 feet, and of considerably greater extent, sending down spurs to the west and north-west, which fill up almost the whole of that portion of the island, while the main mass abuts directly upon the south coast for a space of twenty-five to thirty miles, and is then continued by a ridge of inferior elevation, but still ranging from 5000 to 6000 feet in height, till it sinks into the plain of the Messara nearly due south of Mount Ida, from which it is separated only by the valley of Sulia. The eastern half of the island is less mountainous, and none of the summits attain so great an elevation; but the central group of the Lasethi Mountains rises to the height of 7100 feet, and its summits, like those of Mount Ida and the White Mountains, are covered with snow throughout the greater part of the year. The range of Mount Kophino, which separates the plain of the Messara from the south coast, rises abruptly from the sea to a height of 3750 feet, while the subordinate ranges, that fill up the extreme eastern portion of the island, nowhere attain to the elevation of 4000 feet. The isolated peak of Mount Luktas, nearly due south of the city of Candia, though not exceeding 2700

feet in height, has attained great celebrity from its being reputed in ancient times to contain the burial-place of Zeus, which continued to be regarded with veneration by the Cretans till after the time of Constantine.

The intervals between these mountain groups are filled up for the most part by undulating tracts, consisting of hills of Tertiary formation and comparatively low elevation, but still rising occasionally to a height of from 2000 to 3000 feet. Such a tract is that which extends across the island from the neighborhood of Candia to the plain of Messara in the south; and a similar one, though of less extent, between Hierapytna on the south and the Gulf of Mirabella on the north, forms a kind of isthmus not more than seven miles across by which the easternmost portion of Crete is united with the rest of the island. Very few plains of any considerable extent occur. Much the largest of these is that called the plain of Messara, in the south of the island, which extends inland from the sea at the foot of Mount Ida, between the slopes of that mountain and the range of Mount Kophino, which, as already stated, separates it from the sea. It is about thirty-five miles in length, with a breadth of from six to ten miles. The plain which adjoins the city of Canea is of great fertility but of small extent, not exceeding seven or eight miles in width.

One leading characteristic of the mountain regions of Crete is the occurrence of depressed valleys or basins at a considerable height above the sea, forming crater-like hollows without any outlet for their waters, and containing plains of considerable extent, which afford admirable pasturage in spring and early summer. The most remarkable of these upland basins (which appear to answer precisely to the Yailahs of the Lycian Taurus) are that called Nida, on the flanks of Mount Ida, at an elevation of between 5000 and 6000 feet; the more extensive one called Omalo, in the White Mountains, at a height of about 4000 feet; and one in the Lasethi Mountains about 3000 feet above the sea, which is the most extensive of the three, and incloses a beautiful plain, containing no less than fifteen villages, with a population of between 3000 and 4000 souls.

*Rivers.*—From its peculiar conformation it naturally results that Crete contains no rivers of any importance. The most considerable stream is that called the Ieropotamo (the ancient Electra), which flows through the plain of the Messara and falls into the sea on the south coast. The Mylopotamo (the ancient Oaxes), which traverses the fertile district north of Mount Ida, is the most important of those on the north coast; while the Platania, a small stream which falls into the sea a few miles west of Canea, deserves notice chiefly as being mentioned by Homer under the name of Iardanus.

*Coast-lines.*—The coasts of Crete, in consequence of its mountainous character, present a very broken and varied outline. In the west especially they form a number of rugged and lofty promontories, of which the north-west extremity is the headland now called Cape Busa, the ancient Corycus, and the south-west angle is formed by Cape Krio, the Kriu Metopon of ancient geographers. East of Cape Busa the lofty mountain headland of Capa Spada projects more than twelve miles from the general coastline; and again, beyond Canea, the mountainous peninsula called Akrotiri bounds the Bay of Sudha, which constitutes a naturally sheltered harbor of sufficient size to afford protection to all the fleets of Europe. The north coast is again deeply indented, in the eastern portion of the island, by the Gulf of Mirabella, beyond which the coast runs out far to the north-east, ending in the narrow and rocky promontory of Cape Sidaro, the Sammonium of the ancients. The south coast is less broken and irregular, and contains few good harbors,—the mountains in many parts rising almost like a wall directly from the sea. There is, however, one small but well-sheltered bay, about five miles east of Cape Littinos, still called Kaloi Limenes, or "the Fair Havens," under which name it is mentioned in the voyage of St. Paul.

*Islands.*—The islands which are found around the coasts of Crete are for the most part mere rocks, unworthy of notice. The largest is that of Gavdo, the ancient Claudia, which is also mentioned in the Acts of the Apostles, and (probably on that account) became in the Middle Ages the see of a bishop, though it is only about five miles long by three in breadth, and contains at the present day only about seventy families. The small island of Dia, now called

Standia, which lies about eight miles north of the city of Candia, has a good port, and in consequence bore an important part during the memorable siege of that city. The isolated rock of Grabusa, off the north-west angle of the island, has obtained celebrity from its having been converted by the Venetians into a fortress, long reputed impregnable, which did not fall into the hands of the Turks until long after the capture of Candia. For the same reason it became a stronghold of the Greeks during the war of independence, and at that period afforded shelter to a considerable population.

*Vegetation.*—Though so large a part of Crete is occupied by mountains, the rest of the island is of great fertility, and there can be no doubt that, under a better system of government, it would become one of the richest and most productive islands in the Mediterranean. The forests which once covered the mountains have indeed for the most part disappeared, but the cypress still grows wild in the higher regions, while the lower hills are covered with olive woods. Oranges and lemons also abound, and are of excellent quality, so as to furnish almost the whole supply of continental Greece and Constantinople. Chestnut woods, as in Greece itself, are local and exceptional; the same is the case with the valonia oak; while in some districts the carob tree is so abundant as to form an important article of consumption. Pears, apples, quinces, mulberries, and other fruit-trees flourish in abundance, as well as vines, though the Cretan wines no longer enjoy the reputation which they possessed in the time of the Venetians. Tobacco and cotton succeed well in the plains and low grounds, though not at present cultivated to any great extent.

*Animals.*—Of the wild animals of Crete, the only one that deserves special notice is the wild goat, which is still found in considerable numbers on the higher summits of Mount Ida and the White Mountains. It is the same species (*Capra aegagrus*) which is found in the Caucasus and Mount Taurus, and is distinct from the ibex or bouquetin of the Alps. Crete enjoys the same immunity which is possessed by several other large islands from the presence of serpents of all kinds,—a privilege ascribed by popular belief to the intercession of Titus, the companion of St. Paul, who according to tradition was the first bishop of the island, and became in consequence its patron saint, previous to its conquest by the Venetians. Wolves also are not found in the island, though so common in Greece and Asia Minor.

*History.*—The earliest history of Crete, like that of most parts of continental Greece, is to so great an extent mixed up with mythology and fable as to render it impossible to arrive at any clear conclusions concerning it. The Cretans themselves claimed for their island to be the birthplace of Zeus, as well as the parent of all the other divinities usually worshipped in Greece as the Olympian deities. But passing from this region of pure mythology to the semi-mythic or heroic age, we find almost all the early legends and traditions of the island grouped around the name of Minos, one of those personages of the earliest Greek history of whom it is impossible to say whether any element of truth underlies the mass of mythical and poetical fable by which it has been surrounded. According to the received tradition, Minos was a king of Knossos in Crete, who was a son of Zeus, and enjoyed through life the privilege of habitual intercourse with his divine father. It was from this source that he derived the wisdom which enabled him to give to the Cretans the excellent system of laws and governments that earned for him the reputation of being the greatest legislator of antiquity. At the same time he was reported to have been the first monarch who established a naval power, and acquired what was termed by the Greeks the *Thalassokraty*, or dominion of the sea.

Whatever truth there may have been in this last tradition (which was received as an undoubted fact both by Thucydides and by Aristotle), it is certain that when we first hear of the Cretans, in the Homeric poems, they appear as a seafaring race, and apparently the only Greek people who at that early period attempted to compete with the Phœnicians as bold and adventurous navigators. The position of their island was moreover such as to give them great natural facilities for the command of the Ægean and the surrounding islands, as well as for communication with Phœnicia and Egypt.

Even at the earliest period when we have any information concerning it, the population of Crete was of a very

mixed character, and we are told in the *Odyssey* (xix. 175) that besides the Eteocretes, who, as their name imports, must have been the original inhabitants, the island contained Achæans, Pelasgians, Dorians, and Cydonians. Subsequently the Dorian element became greatly strengthened by fresh immigrations from the Peloponnesus, and during the historical period all the principal cities of the island were either Dorian colonies, or had adopted the Dorian dialect and institutions. It is certain that at a very early period the Cretan cities were celebrated for their laws and system of government, the origin of which was of course attributed to Minos, but which had much in common with those of the other Dorian states, as well as with those of Lycurgus at Sparta, which were, indeed, according to one tradition, copied in great measure from those already existing in Crete.<sup>1</sup>

It is certain that whatever merits the Cretan laws may have possessed for the internal regulation of the different cities, they had the one glaring defect, that they made no provision for any federal bond or union among them, or for the government of the island as a whole. It was owing to the want of this that the Cretans scarcely figure in Greek history as a people, though the island, as observed by Aristotle, would seem from its natural position calculated to exercise a preponderating influence over Greek affairs. Thus they took no part either in the Persian or the Peloponnesian war, or in any of the subsequent civil contests in which so many of the cities and islands of Greece were engaged. At the same time they were so far from enjoying tranquillity on this account that the few notices we find of them in history always represent them as engaged in local wars among one another, and Polybius tells us that the history of Crete was one continued series of civil wars, which were carried on with a bitterness of animosity exceeding all that was known in the rest of Greece.

In these domestic contests the three cities that generally took the lead and claimed to exercise a kind of *hegemony* or supremacy over the whole island were Cnossus, Gortyna, and Cydonia. But besides these three there were many other independent cities, which, though they generally followed the lead of one or other of these more powerful rivals, enjoyed complete autonomy, and were able to shift at will from the alliance of one to the other. Among the most important of these were—Lyttus, or Lyc-tus, in the interior, south-east of Cnossus; Rhaucus, between Cnossus and Gortyna; Phœstus, in the plain of Messara, between Gortyna and the sea; Polyrrenia, near the north-west angle of the island; Aptera, a few miles inland from the Bay of Sudha; Eleutherna and Axus, on the northern slopes of Mount Ida; and Lappa, between the White Mountains and the sea. Phalasarua on the west coast, and Chersonesus on the north, seem to have been dependencies, and served as the ports of Polyrrenia and Lyttus. Elyrus stood at the foot of the White Mountains, just above the south coast. In the eastern portion of the island were Proesus in the interior, and Itanus on the coast, facing the east, while Hierapytna on the south coast was the only place of importance on the side facing Africa, and on this account rose under the Romans to be one of the principal cities of the island.<sup>2</sup>

Though it was continually torn by civil dissensions, the island maintained its independence of the various Macedonian monarchs by whom it was surrounded; but having

<sup>1</sup> Among the features common to the two were the *syssitia*, or public tables, at which all the citizens dined in common. Indeed, the Cretan system, like that of Sparta, appears to have aimed at training up the young, and controlling them, as well as the citizens of more mature age, in all their habits and relations of life. The supreme governing authority was vested in magistrates called Cosmi, answering in some measure to the Spartan Ephori, but there was nothing corresponding to the two kings at Sparta. These Cretan institutions were much extolled by some writers of antiquity, but receive only qualified praise from the judicious criticisms of Aristotle (*Polit. ii. 10*).

<sup>2</sup> But besides these there were many small towns, which still enjoyed or claimed the privileges of autonomy. In the earliest times, indeed, Crete was said to have contained a hundred cities, and though this was doubtless a mere poetical exaggeration, the existing remains show that the whole island was studded with numerous fortified strongholds, each of which may at times have asserted its independence. Such petty fortresses were well suited to a people of the predatory habits which distinguished the Cretans in all ages, notwithstanding the boasted excellence of their government. Throughout the flourishing period of Greece, indeed, the Cretans were principally known as furnishing mercenary troops, who were distinguished for their skill in the use of the bow, so that a force of Cretan archers became almost a necessary addition to every Greek army.

incurred the enmity of Rome, first by an alliance with the great Mithridates, and afterwards by taking active part with their neighbors, the pirates of Cilicia, the Cretans were at length attacked by the Roman arms, and, after a resistance protracted for more than three years, were finally subdued by Q. Metellus, who earned by this success the surname of Creticus (67 B. C.). The island was now reduced to a Roman province, but by a very singular arrangement was united for administrative purposes with the district of Cyrenaica, or the Pentapolis, on the opposite coast of Africa, a disposition which continued unchanged till the time of Constantine. Thenceforth Crete constituted a separate province under a governor of consular rank, and continued to form part of the Byzantine empire till the 9th century, when it fell into the hands of the Saracens (823). It then became a formidable nest of pirates, but defied all the efforts of the Byzantine sovereigns to recover it till the year 960, when it was reconquered by Nicephorus Phocas. In the partition of the Greek empire after the capture of Constantinople by the Latins in 1204, Crete fell to the lot of Boniface, marquis of Montferat, but was sold by him to the Venetians, and thus passed under the dominion of that great republic, to which it continued subject for more than four centuries.

Under the Venetian Government Candia, a fortress originally built by the Saracens, and called by them "Khandax," became the seat of government, and not only rose to be the capital and chief city of the island, but actually gave name to it, so that it was called in the official language of Venice "the island of Candia," a designation which from thence passed into modern maps, where it retained its position down to our own days. The ancient name of Kreta or Kriti was, however, always retained in use among the Greeks, and is gradually resuming its place in the usage of literary Europe. The government of Crete by the Venetian aristocracy was, like that of their other dependencies, very arbitrary and oppressive, and numerous insurrections were the consequence. But with all its defects their administration did much to promote the material prosperity of the country, and to encourage commerce and industry; and it is probable that the island enjoyed during this period a more prosperous condition than it has done at any subsequent time. Their Venetian masters at least secured to the islanders external tranquillity, and it is singular that the Turks were content to leave them in undisturbed possession of this opulent and important island for nearly two centuries after the fall of Constantinople. It was not till 1645 that the Turks made any serious attempt to effect its conquest; but in that year they landed with an army of 50,000 men, and speedily reduced the important city of Canea. Retimo fell the following year, and in 1648 they laid siege to the capital city of Candia. This was the longest siege on record, having been protracted for more than twenty years; but in 1667 it was pressed with renewed vigor by the Turks under the grand vizier Achmet Kiuprili, and the city was at length compelled to surrender (September, 1669). Its fall was followed by the submission of the whole island. (See Daru, *Histoire de Venise*, chap. xxxiii.)

From this time the island continued subject to the Ottoman rule without interruption till the outbreak of the Greek revolution. After the conquest a large part of the inhabitants embraced Mahometanism, and thus secured to themselves the chief share in the administration of the island. But far from this having a favorable effect upon the condition of the population, the result was just the contrary, and according to the testimony of an intelligent traveller, Crete was the worst governed province of the Turkish empire. The regular authorities sent from Constantinople were wholly unable to control the excesses of the janissaries, who exercised without restraint every kind of violence and oppression. Hence, when in 1821 the revolution broke out in continental Greece, the Cretans, headed by the Sfakiot mountaineers, at once raised the standard of insurrection, and carried on hostilities with such success that they soon made themselves masters of the whole of the open country, and drove the Turks and Mahometan population to take refuge in the fortified cities. These, however, defied all the efforts of the insurgents, and the contest was prolonged without any decisive result, until in 1830 the allied powers (France, England, and Russia) who had intervened in the contest between Greece and Turkey, transferred the island of Crete to the

government of Mehemet Ali, viceroy of Egypt. This change of masters brought some relief to the unfortunate Cretans, who at least exchanged the license of local misrule for the oppression of an organized despotism; and the government of Mustafa Pasha, the ruler of the island for a considerable period, was more enlightened and intelligent than that of most Turkish governors.

In 1840 Crete was again taken from Mehemet Ali, and replaced under the dominion of the Turks, as it has continued ever since. Great improvement has undoubtedly taken place in the administration, and the island is said to be now the best governed and the most lightly taxed of all the provinces of the Turkish empire. But the strong desire of the Cretans for freedom and union with the Greek monarchy has given rise to two successive revolts; the first of which in 1859 was speedily repressed; but the second, in 1866, lasted for a considerable period, and required great exertions on the part of the Porte to put it down. It was followed by the concession of additional privileges to the Christian inhabitants, and a kind of constitutional government, which has placed the island in quite an exceptional position among Turkish provinces.

In all these insurrections, as well as in those against the Venetians in former days, a leading part has been borne by the people known as Sfakiots, a race of hardy mountaineers inhabiting the highlands and upland plains of the White Mountains, and who, from the rugged and inaccessible nature of their country, have always enjoyed a condition of semi-independence, while their active and warlike habits have rendered them formidable neighbors to the inhabitants of the plains. There is, however, no ground for supposing them to be in any respect a distinct race from the other population of the island; they appear to be, on the contrary, the lineal representatives of the ancient Cretans, who have preserved comparatively unimpaired the character and manners of their forefathers. A curious proof of this is found in their still wearing high boots, a fashion noticed by ancient writers as characteristic of the Cretans, and which was then, as now, wholly unknown to the Greeks of the mainland. It is mentioned also by Venetian writers, that as late as the 17th century the Sfakiots retained that skill in the use of the bow for which the Cretans were so celebrated in antiquity, and were with difficulty induced to lay it aside for the more civilized firearms of their rulers.

**Population.**—The inhabitants of Crete under the Venetians were estimated at about 250,000 souls. After the Turkish conquest the population was for a time greatly reduced, but afterwards gradually rose, till it was supposed again to have attained to about 260,000 at the time of the outbreak of the Greek revolution in 1821, of whom about half were Mahometans. The ravages of the war from 1821 to 1830, and the emigration that followed, produced a great diminution, and the population of the island was estimated by Mr. Pashley in 1836 at only about 130,000. Since then it has again materially increased; it was calculated by Captain Spratt in 1865 as amounting to 210,000, and this nearly agrees with the latest official estimate, which gives 200,000 inhabitants in all, of whom less than 40,000 are Mahometans. It must be observed that very few of these are Turks,—the Mussulman population being almost entirely of native Cretan origin. Hence the Greek language is the only one spoken throughout the island, even in the towns and among the Mahometans.

**Towns.**—The only considerable towns in Crete are Candia, so long the capital of the island; Canea, which has succeeded to that dignity since the renewal of the Turkish dominion in 1840; and Retimo, or Rhithymno, also on the north coast, a small fortified town, with a good port and about 10,000 inhabitants. Ierapetra, on the south coast, on the site of the ancient Hierapytna, though reckoned the fourth city of the island and the capital of the eastern district, is a very poor place, with not more than about 2000 inhabitants.

Crete has of late years been carefully examined and explored. The older descriptions of the island by Tournefort, Pococke, Olivier, and other travellers may now be considered as obsolete, and superseded by the more recent works of Pashley (*Travels in Crete*, 2 vols. 8vo, London, 1837), and Captain Spratt (*Travels and Researches in Crete*, 2 vols. 8vo, London, 1865), which between them contain a full description of the whole island. At the same time its geography has been placed on a satisfactory basis by the admirable survey executed, under the orders of the British admiralty, by Captain Graves and Captain

(now Admiral) Spratt. A curious and interesting addition to its archæology has been also made by the publication of a description of the island, drawn up under the Venetians (about 1538), and preserved in manuscript in the Library of St. Mark, whence it has been published by Mr. Falkener in the *Museum of Classical Antiquities*, vol. ii., pp. 263–303. From this treatise we learn how many architectural remains of the ancient cities were still visible in the 16th century, which have long since disappeared. All that can be gathered from ancient authors concerning the mythology and early history of the island is brought together by Meursius (*Crete*, etc., in the 3d vol. of his works) and Hoeck (*Kreta*, 3 vols. 8vo, Göttingen, 1823–29), but the latter work was published before the recent researches which have thrown so much light on the topography and antiquities of the island. (E. H. N.)

CRETINISM may be defined as an endemic idiocy, of which the characteristic is an arrested development of body as well as mind. The origin of the word is doubtful. Its southern French form *chrestina* suggested to Michel a derivation from *creta* (*crête*), the goose foot of red cloth worn by the *Cagots* of the Pyrenees. The *Cagots*, however, were not cretins. Again *Christianus* (which appears in the Lombard *cristanei*, and the Savoyard *innocents* and *gens du bon dieu*) is merely a translation of the older *cretis*, which is probably connected with *creta* (*cræie*)—a sallow or yellow-earthly complexion being a common mark of cretinism. Many other symptoms show that the whole organism is stunted. We quote the vivid picture by Beaupré (*Disertation sur les Crétins*, translated in Blackie on *Cretinism*, Edin. 1855):—

“I see a head of unusual form and size, a squat and bloated figure, a stupid look, bleared hollow and heavy eyes, thick projecting eyelids, and a flat nose. His face is of a leaden hue, his skin dirty, flabby, covered with warts, and his thick tongue hangs down over his moist livid lips. His mouth, always open and full of saliva, shows teeth going to decay. His chest is narrow, his back curved, his breath asthmatic, his limbs short, misshapen, without power. The knees are thick and inclined inward, the feet flat. The large head drops listlessly on the breast; the abdomen is like a bag.”

Generally the cretin is deaf and dumb, or able to utter only a hoarse cry. He is indifferent to heat, cold, blows, and even the most revolting odors. Some appear to want intelligence altogether, and even the power of articulation. Others acquire the rudiments of language, and are able to perform simple tasks. There are, indeed, several distinct varieties of cretinism which have been noticed by Abercrombie, founding on the descriptions of Fodéré and De Saussure (*De Fatuitate Alpina*, Edin. 1803), Wenzel (*Ueber d. Cretinismus*, Vienna, 1802), and Guggenbühl of the Abendberg at Interlaken. The abnormal cranial development has been studied by Virchow (*Der Cretinismus in Unterfranken*, Würzburg, 1852) and Vogt (*Mémoires sur les Microcéphales*, Geneva, 1867). Many cretins are hydrocephalic; but more frequently the skull is microcephalic, with premature ossification of the sutures and induration of portions of the brain matter. The anterior lobes are said to be much lighter than in healthy brains, but this difference does not extend to the cerebellum. Vogt maintains that the *microcéphale* has a pithecoïd skull at the crown, and a human skull at the base and crown. But his suggestion that this is a case of atavism, and that cretins represent a stage through which the human race passed in its evolution from the ape, is generally repudiated. (See the *Races of Man* by Oscar Peschel, London, 1867, p. 66, and a paper by Dr. Ireland of Larbert on the Reports of Drs. Lombroso and Valenti of Bologna, *Edin. Med. Journal*, xx. p. 109). It is said too that the respiration of cretins reaches only 15 instead of the normal 18 per minute. Many die very young in epileptic convulsions, and survival to old age is extremely rare. But the most striking sign of cretinism is the *goitre*, variously known as bronchocele and struma, kropf (German), wen or derby neck (English), mumps or branks (Scotch). From this must be distinguished the weaver's goitre, caused by the emanations from steeped flax; the exophthalmic goitre, also called Grave's disease, which is marked by palpitations of the heart and prominence of the eyeballs; and the smaller goitre which is sometimes connected with uterine affections. We should also mention the epidemic goitre, such as that which attacked Captain Cook's crew in 1772, when they drank water from a melting iceberg. The endemic goitre is a tumor of the thyroid gland of varying size, sometimes filled with a viscous fluid, sometimes containing

pus cysts and calcareous deposits. There is a large body of evidence to the effect that goitre and cretinism are causally related,—that they are at least effects of the same causes; or, as Maffei expresses it, “goitre is the beginning of that degeneration of which cretinism is the end.” No doubt, perfectly sane and healthy persons have goitres. For instance Fodéré, an eminent man of science who published an *Essai sur le Goitre* at Turin in 1792, himself suffered from this deformity when a boy, and re-caught it when lecturing at Strasburg. But these cases are few, and the statistical inquiries of Roesch in Würtemberg (*Ueber d. Cretinismus*, Erlangen, 1844), and of Niepce in Dauphiné (*Traité du Goitre et du Cretinisme*, Paris, 1852) have established that the great mass of cretins have goitres, and that goitre generally appears at the age when development is arrested, that is, seven or eight years. Of Acosta, the home and centre of cretinism, Malacarne wrote in 1789, *Un mentecatto senza gozzo è una cosa rarissima*. The two things have been observed together in Africa and both Americas by Park, Richardson, Humboldt, and other distinguished travellers. Again cretinism is found in certain districts; it is in these districts also that the non-cretinous cases of goitre are for the most part found. Healthy parents, coming to an endemic district, produce children with goitres, or cretins; parents with goitres, removing to an untainted neighborhood, often lose their own goitres, and seldom produce children subject to the deformity. Nor does intermarriage with a healthy stranger avert the danger, if the household remain subject to the endemic conditions. It may be added that in both Europe and the United States deaf-mutism, a form of arrested development, is found in local contact with cretinism and goitre. Deaf-mutes are often found in families of which the other members are cretins, and they are found as a class in the neighborhood of a cretin district. What then are the causes of cretinism, of which we shall take goitre as a symptom? In the first place, the phenomenon is not confined to any one race. The whites, the Indians, the negroes, and the half breeds of Central and South Africa all exhibit the disease in certain localities. So do the Malays and the Dyaks of Borneo, the Mongolians of Nepal, Siberia, and the Kwang Tung Mountains in China, the Berbers of Mount Atlas. Nor is it confined to one elevation or character of surface. It appears on the sea shore, as at Viborg, and at the mouth of the St. Lawrence; on inland plains, like those of Lombardy and Alsace; at the moderate elevations of La Barthe and Luz in the Pyrenees; and on the high Peruvian plateau of Pasco, and in the Himalayan valley of the Jumna. Nor can any thermic conditions be laid down; for the symptoms range from the deserts of Algeria to Irkutsk in Siberia, from an average temperature of 80° Fahr. to one of 14° Fahr. The idea of Fodéré that cretinism is caused by a humid atmosphere does not receive much encouragement from the facts. Peru has a very dry climate, and goitre is the principal endemic; the British Isles with much rain and fog have little or no cretinism; at Cuzco, where it rains, as the inhabitants say, thirteen months in the year, the disease is unknown. Morel, Virchow, and Koeberlé (in his *Essai sur Cretinisme*, Strasburg, 1862) have maintained that cretinism is caused by a special form of marsh-fever, malaria, or even a special organic poison-germ in the atmosphere. The maximum of miasmatic fever, however, has a geographical habitat very different from that of cretinism, which frequently occurs in a rare atmosphere, impregnated with ozone. Hygienic regulation, too, successfully resists cretinism, while respiration is sufficient to let in the atmospheric poison. The favorite explanation of De Saussure, that cretinism is caused by the stagnation of air in the deep valleys of the Alps and Pyrenees, overlooks the well-known fact that morning and evening winds regularly ventilate these valleys. Proceeding on this error, the Sardinian commission recommended that trees near dwelling-houses should be cut down (see *Rapport de la Commission Sarde*, Turin, 1848). Milk and vegetable diet, various kinds of farinaceous food, and defective hygiene have also been made responsible for the disease. But it is not only the poor, the ill-fed, and ill-clad who contract goitre and become idiots; persons in comfortable circumstances, living with every regard to cleanliness, in a fertile country under a fine climate, are subject to the ailment. In Piedmont, for instance, it was calculated that more than three-fifths of the cretins belonged to the poor

people; of course poverty aggravates every disease. The general result of these abortive theories is that some local conditions must be ascertained. There are fragments of evidence showing the persistence of cretinism in particular localities, the inhabitants of which have changed from time to time. Every one knows Juvenal's line—“Quis tumidum guttur miratur in Alpibus?” and Shakespeare's “mountaineers, dewlapped like bulls, whose throats had hanging at 'em wallets of flesh.” Catholic legends tell how in the 5th and 7th centuries Champagne and Liège were condemned for some sacrilege to have women with goitres. The *Life of Charlemagne* states that in 772 his soldiers caught the goitre on the banks of the Rhine. It has always been a popular as well as a scientific belief that water is the vehicle of the poison. “Struma oritur ex metallicis et mineralibus aquis,” says Paracelsus. Endemic goitre has been observed to increase when the summer heats altered the chemical character of the water used for drinking and cooking; and it sometimes disappears before modern arrangements for water supply. Goitre has in fact been artificially produced by the use of water, for the purpose of evading the conscription. But the question remains what is the poison thus conveyed? One opinion was that there might be too little iodine. The old practice of eating the ashes of sea-sponge led Coindet of Geneva to apply iodine to goitre with success. It was also maintained that there might be a deficiency of the phosphates of lime and magnesium. These views apparently proceeded on the principle that the human body required a certain normal proportion in the chemical elements which it consumed. The whole subject has been elaborately treated by M. St. Lager in *Études sur les causes du cretinisme et du goitre endémique*, Paris, 1867. He takes the pathology of cretinism as illustrating the wider question of the dependence of the human organism on the chemical constitution of the soil. He has made an inquiry into the geological features of the districts in which cretinism is endemic, compared with the statistics of the cretin population. He finds that cretinism is confined to metalliferous districts, and occurs most frequently where iron pyrites and copper pyrites predominate.

Although dogs, pigs, and probably also horses, oxen, and sheep have been affected by goitre, there is no reliable evidence of a connection between goitre and feeble or stunted organization in any of the lower animals.

Pronounced cretinism seems to be incurable. Dr. Guggenbühl's treatment of the Abendberg was chiefly psychological, and belongs to the general theory of the treatment of idiots. But the Swiss commission, who reported on the Abendberg on 15th May, 1849, say that the greater part of the inmates were not cretins at all, but merely scrofulous children. Accordingly on Guggenbühl's death the Bern Government declined any longer to support the establishment. Similar establishments have been founded at Marienberg in Würtemberg by Dr. Roesch, at Aosta in Piedmont, Basseno in Savoy, at Abbiatragrasso in Lombardy, at Albany, Utica, and other places in the United States. (See, for a list of idiot schools, *Die Heil und Pflege Anstalten für psychisch. Kranke*, by Dr. H. Laehr, Berlin, 1875.) An institution at Highgate, London, was founded in imitation of the Abendberg. It may be interesting to note the places in which cretins have been found in the United Kingdom. In England these are Oldham, Sholver Moor, Crompton, Duffield, Cromford (near Matlock), and other points in Derbyshire; endemic goitre has been seen near Nottingham, Chesterfield, Pontefract, Ripon, and the mountainous parts of Staffordshire and Yorkshire, the east of Cumberland, certain parts of Worcester, Warwick, Cheshire, Monmouth, and Leicester, near Horsham in Hampshire, near Haslemere in Surrey, and near Beaconsfield in Buckingham. There are cretins at Chiselborough in Somerset. In Scotland cretins and cases of goitre have been seen in Perthshire, on the east coast of Fife, in Roxburgh, the upper portions of Peebles and Selkirk, near Lanark and Dumfries, in the east of Ayrshire, in the west of Berwick, and the east of Wigton, and in Kirkcudbright.

See Inglis, *Treatise of English Bronchocela*, 1844; *Cretinism in Scotland*, by Coldstream, 1847; Mitchell on the Nithsdale neck or goitre in Scotland, in *Med. and Chir. Review*, 1862. See also Virchow, *Pathologie des Tumours*, Paris, 1863; Maffei, *Der Cret. in den Norischen Alpen*, Erlangen, 1844; Morel, *Traité des Dégénérescences*, Paris, 1857; *Report of Royal Commission of Cretinism in Lombardy*, Milan, 1864; *Report of Austrian Commission*, Vienna, 1861. (W. C. S.)

CREUSE, a department of central France, comprising the greater portion of the old province of Marche, bounded N. by the departments of Indre and Cher, E. by Allier

and Puy-de-Dôme, S. by Corrèze, and W. by Haute-Vienne, with an area of 2150 square miles. The surface is hilly, with a general inclination north-westward in the direction of the valley of the Creuse, sloping from the mountains of Auvergne and Limousin, which rise southward and branch into the department. The highest point within its limits is in the forest of Châteauevert, 3050 feet above the sea. Rivers, streams, and lakes are numerous, but none are navigable; the principal is the Creuse, which rises on the north side of the mass of Mount Odouze on the border of the department of Corrèze, and passes through the department, dividing it into two nearly equal portions, receiving the Petite Creuse from the right, and afterwards flowing on to join the Vienne. The valleys of the head-streams of the Cher and of its tributary the Tardes occupy the eastern side; those of the heads of the Vienne and its tributary the Thion, and of the Gartempe joining the Creuse, are in the west of the department. The climate is in general cold, moist, and variable; the rigorous winter covers the higher cantons with snow; rain is abundant in spring, and storms are frequent in summer, but the autumn is always fine. Except in the valleys the soil is poor and infertile, so that agriculture is not in an advanced state, and the produce of corn, chiefly rye, oats, and buckwheat or "sarrasin," is not sufficient for home consumption. The chestnut abounds in the north and west, and its fruit is largely used. Cattle rearing and sheep breeding are the chief industries of the department. Creuse supplies Poitou and Vendée with draught oxen. Coal is mined to some extent, chiefly in the basin of Ahun, but though iron ore, antimony, and kaolin are known, they are not worked. Millstones are quarried at Léogny. There are thermal springs at Evaux in the east of the department. A railway uniting the systems of the Loire and Garonne basins crosses the department from east to west, and a branch line leads up the valley of the Creuse to Aubusson. With Haute-Vienne Creuse forms the diocese of Limoges. The department is divided into the four arrondissements of Guéret, the capital (population, 4899), Aubusson, the largest place (population, 6034), Bourgneuf, and Broussac, and further into twenty-five cantons. Population of department (1872), 274,633. Home labor is not sufficient for the support of the population, and from 20,000 to 25,000 of the inhabitants of the department go yearly to other parts of France in search of employment.

CREUTZ, GUSTAF PHILIP, COUNT, a Swedish poet, was born in Finland in 1729. After concluding his studies in Abo he received a post in the Court of Chancery at Stockholm in 1751. Here he met Count Gyllenberg, with whom his name is as firmly united as Beaumont's with Fletcher's. Their friendship woke the poetic vein in each of the young men, and they formed, in unison, the one great figure in the poetic literature of Sweden in the 18th century. Under the patronage of the eminent poetess, Fru Nordenflycht, the volumes they published together became widely admired; to their own generation they seemed equal in fame, but posterity has given the palm of genius to Creutz. His greatest work is contained in the 1762 volume, the idyll of *Atis and Camilla*; the exquisite little pastoral entitled *Daphne* was published at the same time, and the generous and loving Gyllenberg was the first to proclaim and to delight in the supremacy of his friend. In 1763 Creutz practically closed his poetical career; he went to Spain as ambassador, and after three years to Paris in the same capacity. In France he enjoyed the friendship of all the great literati of the day, especially of Marmontel. In 1783 Gustavus III. recalled him and heaped honors upon him, but he died soon after, on the 30th of October, 1785. *Atis and Camilla* was long the most admired poem in the Swedish language; it is written in a spirit of pastoral which is now to some degree faded, but in comparison with most of the other productions of the time it is freshness itself. Creutz introduced a melody and grace into the Swedish tongue which it lacked before, and he has been styled "the last artificer of the language."

CREUZER, GEORG FRIEDRICH (1771-1858), a German philologist and archaeologist, born on March 10, 1771, at Marburg, was the son of a bookbinder of that town. Having studied at Marburg and Jena, he for some time lived at Leipsic as a private tutor; but in 1802 he was appointed professor at Marburg, and two years later professor of philology and ancient history at Heidelberg. The latter position he held for nearly forty-five years, with the

exception of a short time spent at the university of Leyden where he was unable to remain on account of the injurious effect produced upon his health by the Dutch climate. He had the honor of being one of the principal founders of the Philological Seminary established at Heidelberg in 1807. The Academy of Inscriptions of Paris appointed him one of its members, and from the grand duke of Baden he received the dignity of privy councillor. He died at the age of eighty-seven, February 16, 1858. Creuzer's first and most famous work was his *Symbolik und Mythologie der alten Völker, besonders der Griechen* (Leipsic, 1810-12), in which he maintained that the mythology of Homer and Hesiod came from an Eastern source through the Pelasgians, and was the remains of the symbolism of an ancient revelation. This work was vigorously attacked by Hermann, in his *Briefen über Homer und Hesiod*, and his letter, addressed to Creuzer, *Ueber das Wesen und die Behandlung der Mythologie*; by Voss, in his *Antisymbolik*; and by Loebek, in his *Aglaophamos*. Of Creuzer's other works, the principal are an edition of Plotinus; a partial edition of Cicero, in preparing which he was assisted by Moser; *Die Historische Kunst der Griechen* (Leips. 1803); *Epochen der Griech. Literaturgeschichte* (Marburg, 1802); *Abriß der römischen Antiquitäten* (Leips. 1824); *Zur Geschichte altrömischer Cultur am Oberrhein und Neckar* (Leips. 1833); *Zur Gemmenkunde* (Darmstadt, 1834); *Das Mithreum von Neuenheim* (Heidelberg, 1838); *Zur Galerie der alten Dramatiker* (Heidelberg, 1839); *Zur Geschichte der classischen Philologie* (Leips. 1854).

See the autobiographical *Aus dem Leben eines alten Professors* (Leips. and Darmstadt, 1848), to which was added in the year of his death *Paratipomena der Lebenskisse eines alten Professors* (Frankfort, 1858); also Starck, *Friedrich Creuzer, sein Bildungsgang und seine bleibende Bedeutung* (Heidelberg, 1875).

CREUZOT, LE, a town of France, department of Saône-et-Loire, 12 miles S. E. of Autun, on the high ground which extends between the Cevennes and the Côte d'Or, 1355 feet above the sea. Situated in a district which is rich in coal and iron, it has the most extensive iron works in France, rivalling those of Birmingham, Essen, or Liège, and since 1837 has gathered round these a population amounting in 1872 to 21,408. Three distinct though connected industries are in full activity about Creuzot,—the mining of coal in the Creuzot-Blanzy basin, the smelting of iron ore, and the manufacture of all kinds of machinery. The factories occupy about 300 acres, of which 50 are covered with workshops, where locomotives and marine engines are constructed for all parts of the world. About 100,000 tons of rails are turned out annually. Besides its immediate supply Creuzot draws to it a large part of the coal taken from the central basin of France; excepting the mineral from Change, near Épinac, little native French iron is used in the factories, which are chiefly provided from Elba and Algeria. Railways connect Creuzot with the Canal du Centre and the Saône, and westward with the navigation of the Loire.

CREVIER, JEAN BAPTISTE LOUIS (1693-1765), a French author, was born at Paris, where his father was a printer. He studied under Rollin, and held the professorship of rhetoric in the college of Beauvais for twenty years. He completed Rollin's *Histoire Romaine* by the addition of eight volumes; he also published two editions of Livy, with notes; *L'Histoire des Empereurs des Romains, jusqu'à Constantin*, 1749, 12 vols. 12mo; *Histoire de l'Université de Paris*, 7 vols. 12mo; and a *Rhétorique Française*, which enjoyed much popularity.

CREWE, a town of Cheshire, and an important station on the London and North-Western Railway, to which it is altogether indebted for its importance. It is the centre of six lines of railway, connecting it with Manchester, Chester, Birmingham, and other large towns, and is 21 miles east by south of Chester, and 54 miles north-west of Birmingham. It is inhabited principally by persons in the employment of the railway companies, and is well laid out. Crewe is not only one of the busiest railway junctions in the world, but possesses an enormous establishment for the manufacture of everything used in railways, steelworks, and engine and carriage factories on a great scale. It has a mechanics' institute, library, schools, baths, etc. The country round is flat and uninteresting. The town was built on an estate called Oak Farm, in the parish of Monk's Copenhall, and takes its name from the



original stations having been placed in the township of Crewe, in which the seat of Lord Crewe is situated. Population (1871), 17,810.

CRIBBAGE, a game at cards, of uncertain etymology. A very similar game called nobby was formerly played: the game was fifteen or twenty-one up, marked with counters, occasionally by means of a nobby-board. Cribbage seems to be an improved form of nobby.

A complete pack of fifty-two cards is required, and a *cribbage-board* and *four pegs*. The board is drilled with sixty holes for each player (see diagram), and one hole (called the *game hole*) common to both. The divisions into spaces of ten holes each are to facilitate counting. The game is marked by inserting the pegs in the holes, commencing with the outer row at the game-hole end, and going up the board. When the thirtieth hole is reached,

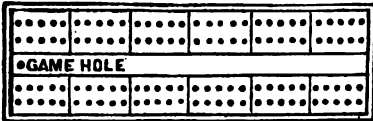

Cribbage Board.

the player comes *down* the board, using the inner row of holes. The pegs belonging to one player should differ in color from those belonging to the other. When one peg has been used, and another score is made by the same player, the second peg of the same color is inserted ahead of the first, according to the number of holes to be scored. This peg is called the *foremost* peg, the other the *hindmost* peg. When a fresh score accrues, the hindmost peg is taken out and placed in front of the foremost (which now becomes the hindmost), and so on until one player scores sixty-one holes or more, when he wins, and places his foremost peg in the game hole. If the losing player fails to obtain thirty holes, his adversary wins a *double* when so agreed.

The game may be played by two players, five or six cards being dealt to each, and each putting out two for crib; or by three players (with an extra board), five cards being dealt to each, each putting out one for crib, and a card from the top of the pack being dealt to complete the crib; or by four players (two being partners against the other two, sitting and playing as at whist, and one partner scoring for both), five cards being dealt to each, and each putting out one card for crib. Two-handed five-card cribbage is the most scientific game. It is played in the following manner:

The players cut for deal. In cutting, whether for deal, to the dealer, or for start, at least four cards must be cut, and at least four left in the bottom packet. The player who cuts the lower card deals. The cards rank king (highest), queen, knave, ten, down to the ace (lowest). At the two-handed five-card game only the non-dealer is entitled to score three holes (called *three for last*) at any time during the game. Three for last is usually scored while the dealer is dealing the first hand.

The non-dealer cuts the pack; the dealer re-unites the packets, and gives one card to his adversary, and then one to himself, and so on alternately until each has five cards. The undealt portion of the pack is placed face downwards on the table.

The players then look at their hands and *lay out*, each putting two cards face downwards on the table, on the side of the board nearest to the dealer. The four cards so laid out are called the *crib*. A player must not take back into his hand a card he has laid out, nor must the crib be touched during the play of the hand.

After laying out, the non-dealer cuts the pack (when more than two play, the player to the dealer's left), and the dealer turns up the top card of the lower packet, called the *start*. If the start is a knave, the dealer marks two (called *two for his heels*). The score is forfeited if not marked before the dealer plays a card.

The hands are then played. The non-dealer lays face upwards on the table on his side of the board any card from his hand he pleases; the dealer then does the same on his side of the board, and so on alternately. When more than two play, the player to the leader's left plays the second card, and so on round to the dealer. As soon

as the first card is laid down the player calls out the number of pips on it; if a picture card, ten. When the second card is laid down, the player calls out the sum of the pips on the two cards played, and so on until all the cards are played, or until neither player has a card which will come in, *i. e.*, which can be played without passing the number thirty-one. If one player has a card or cards that will come in and the other has not, he is at liberty to play them; at the six-card game he is bound to play as long as they can come in. When more than two play, the player next in rotation is bound to play, and so on until no one can come in. At the two-handed five-card game, when neither can come in the play is at an end; but at the other games the cards already played are turned face down, and the remainder of the hands are played in rotation, and so on until all the cards are played out.

The object of the play is to make pairs, fifteens, sequences, or the go, or to prevent the adversary from scoring. Flushes formerly counted in play; but now they do not.

*Pairs*.—If a card is put down of the same denomination as the one last played, the player *pairing* is entitled to score two holes. If a third card of the same denomination is next played a *pair royal* is made, and the maker of the pair royal is entitled to score six holes. If a fourth card of the same denomination is next played, twelve holes are similarly scored for the *double pair royal*. Kings pair only with kings, queens with queens, and so on with knaves and tens, notwithstanding that they are all *tenth cards* in play, *i. e.*, that the number called when playing any of them is ten.

*Fifteens*.—If either player during the play reaches fifteen exactly, by reckoning the pips and tens of all the played cards, he is entitled to mark two.

*Sequences*.—If during the play of the hand three or more cards are consecutively played which make an ascending or descending sequence, the maker of the sequence marks one hole for each card forming the sequence or *run*. King, queen, knave, and ten reckon in sequence in this order, notwithstanding that they are all tenth cards in play. The other cards reckon in sequence according to the number of their pips. The ace is not in sequence with king, queen. If one player obtains a run of three, and his adversary puts down a card that is in sequence, he marks four, and so on. And, be it observed, if there is a break in the sequence, and the break is filled up during the play, without the intervention of a card not in sequence, the player of the card that fills the break scores a run. An example will render this clear. The cards are played in this order (A playing the first card, B the second, and so on alternately), A B A B

4, 3, 2, ace. A gets a run of three, B a run of four. Had B's last card been a five he would similarly have scored a run of four, as there is no break. Had B's last card been a four, he would have scored a run of three. The cards need not be played in order; it is sufficient that the card last played completes a sequence, although it may be an intermediate card. Thus the cards being played in this order, A B A B A B marks a run of four for his last card played, A a run of five. But suppose the cards played thus, A B A B A B B takes a run of four for the fourth card played, but there is no run for any one else, as the second five (which forms no part of the sequence) intervenes. Again, if the cards at six-card cribbage are thus played, 4, 2, 3, ace 5, 2, 4, ace, A takes a run of three, B a run of four, A a run of five. B then playing the deuce has no run, as the deuce he previously played intervenes. A then makes a run of five, and lastly B has no run, the ace previously played blocking the three.

The *go, end hole, or last card* is scored by the player who approaches most nearly to thirty-one during the play, and entitles to a score of one. If thirty-one is reached exactly, it is a go of two instead of one.

*Compound Scores*.—It often happens that more than one of the above scores are made at the same time, when the player reckons both. Thus a player pairing with the last card that will come in scores both pair and go. Similarly a pair and a fifteen, or a sequence and a fifteen, can be reckoned together.

When the play is over, the hands are *shown* and counted aloud. The non-dealer has *first show*, and scores first; the dealer afterwards counts and scores what he has in hand, and then what he has in crib. In counting the hands and crib, the start is made use of by both players to assist in forming combinations.

The combinations in hand or crib, which entitle to a score are fifteens, pairs or pairs royal, sequences, flushes, and his nob.

*Fifteens*.—All the different cards that, taken together, make fifteen exactly, without counting all the same cards twice over

in one fifteen, entitle the holder to a score of two. Tenth cards count ten towards a fifteen. For example a tenth card and a five reckon two, or *fifteen-two* as it is often called. Another five in the hand or turned up, would again combine with the tenth card, and entitle to another fifteen, or *fifteen-four*, if the other cards were a two and a three, two other fifteens would be counted,—one for the combination of the three and two with the tenth card, and one for the combination of the two fives with the three and two. Similarly, two tenth cards and two fives reckon fifteen-eight; a nine and three threes give three different combinations, and reckon fifteen-six; and so on for other cards.

*Pairs*.—Pairs are reckoned as in play.

*Sequences*.—Three or more cards in sequence count as in play, one for each card. If one sequence card can be substituted for another of the same denomination, the sequence reckons again. For example 3, 4, 5, and a 3 turned up, reckon two sequences of three. At the six-card game or in crib, with another 3 there would be three sequences of three, and so on for all cards that can make a fresh combination.

*Flushes*.—If all the cards in hand are of the same suit, one is reckoned for each card. If the start is also of the same suit, one is reckoned for that also. In crib, no flush is reckoned, unless the start is of the same suit as the cards in crib.

*His nob*.—If a player holds the knave of the suit turned up he counts one for his nob.

A couple of examples will render the counting clear. Say the crib consists of 6, 7, 7, 8, 8. The score would be four fifteens (eight), two pairs (four), four sequences of three (twelve); total twenty-four. Again, a hand of 4, 5, 6 (same suit) and a 5 turned up counts two fifteens (four), a pair (two), two sequences of three (six), and a flush (three); total fifteen.

The points accrue in the following order:—Two for his heels; points made in play as soon as declared; non-dealer's show; dealer's show (hand and crib).

After the points in hand and crib are reckoned, the cards are put together and shuffled, and the opponent of the last dealer deals, and so on alternately until the game is won.

**HINTS TO PLAYERS**.—In laying out, the non-dealer should discard such cards as are not likely to score in crib; the dealer should put out good cards for his own crib. It is so important to *baulk* the crib that the non-dealer should often sacrifice scores in his own hand. Thus with queen, knave, ten, four, ace, the dealer should put out the four and the ace; the non-dealer the queen and ten. But towards the end of the game, if the non-dealer has cards that will probably take him out, the consideration of baulking the crib need not influence him. The best baulks are a king or an ace, as those cards only reckon one way in sequences. King with ten, nine (best baulk), eight, seven, six, or ace, are good baulks; so is queen, with any of these cards except the ten. Next to these wide even cards are good baulks (even cards being less likely to score in fifteens than odd ones); and lastly cards that are not in sequence. Two cards of the same suit should not be put out by the non-dealer if there is as good a discard of cards of different suits. The best cards for the dealer to put out (and therefore those to be avoided by the non-dealer), are fives, five and six, five and a tenth card, three and two, seven and eight, four and one, nine and six, pairs (especially low pairs), and close cards. It is generally right to keep a sequence in hand, as if the start is of the same denomination as one of those kept, the dealer reckons eight at least. A pair royal is a good hand to keep.

In playing the best card to begin with is ace, two, three, or four as the only chance of an adverse score is by pairing, and pairing is always dangerous on account of the possibility of its being capped by a pair royal. Pairing is often declined, as it is common to open the play with a card of which a duplicate is held (except with two fives). When leading from a sequence, the middle card should not be led. If a close card is played to the one led it often happens that the adversary wishes a run of three to be made against him, he holding a card that will complete a run of four. Having the choice of pairing or of making fifteen, prefer the latter; but if a seven or eight is led, and a fifteen is made, the adversary has the chance of a run of three. During the play, a four should not be added to a call of seven (making eleven), as if paired the opponent scores four. All similar combinations should be avoided, as twelve made with a three, twenty-seven with a four, twenty-eight with a three, and twenty-one with any card, as then a tenth card (of which there are sixteen) comes in for two. It is very desirable to win the go, as this makes a difference of at least two in the score in each deal. The

best chance of winning the go with two low cards and a high one is to begin with a low card, with two high cards and a low one to begin with a high one. The dealer has the best chance of making the go.

The most important guide to the play is the score. The player who is ahead in the game should endeavor to keep so by playing wide cards, declining pairs, and declining to make fifteen with close cards. This is called *playing off*. The one who is behind in the game should *play on*, i. e., score whenever he can, running the risk of a larger score being made against him. To calculate whether to play on or play off, the average points scored should be kept in mind. Each player ought to reckon slightly over six in hand and play and five in crib, or seventeen and a half in two deals to be *at home*. A player who scores more than the average and leaves his adversary six or seven points in arrear is *safe at home*. When at home it is best to play off; when the adversary is safe at home it is best to play on.

Near the end of the game and wanting points in play to play out, it is advisable to keep two low cards and one high one.

At six-card cribbage it is not so important to baulk the crib as at five-card. The average scores are twelve for the non-dealer, seventeen for the dealer. At the end of the second deal a player is at home at twenty-nine holes. In the first deal it is an advantage to exceed the average, consequently both players with fair hands should play on; but with poor hands they should play off.

**LAWs**.—*Cutting*.—1. There must be a fresh cut for deal after every game, unless rubbers are played. 2. If in cutting for deal or start more than one card is exposed, adversary may choose which card he pleases. 3. Errors in cutting to the dealer necessitate a fresh cut. *Dealing*.—4. Cards must be dealt by one at a time. If two are dealt together, error may be rectified, if it can be done by moving one card only; otherwise non-dealer marks two holes, and there must be a fresh deal. 5. If dealer exposes his own cards, no penalty. 6. Faced card in pack necessitates a fresh deal. 7. Player dealing out of turn, error can be rectified prior to start being turned up; otherwise not; 8. Non-dealer marks two holes and has the option of a fresh deal—(a) if dealer exposes any of non-dealer's cards, and (b) if dealer gives too many or too few cards to either player. In b cases non-dealer may look at his hand before electing; if he elects to stand the deal when he has a surplus card he returns a card unshown to the pack; if, when the dealer has a surplus card, he draws one and looks at it; if when either has too few cards, imperfect hand is completed from pack. *Laying out*.—9. If either player lays out when he holds too many cards, adversary marks two holes, and has option of a fresh deal. If he stands the deal he draws surplus card from offender's hand and looks at it. 10. If either player lays out with too few cards he must play with his hand short. 11. If a player takes back a card laid out, adversary marks two holes, and has option of fresh deal. 12. Crib must not be touched before hand is played. *Playing*.—13. Player playing with too many cards, same penalty as in law 9. Playing with too few cards, no penalty. 14. Card once played that will come in cannot be taken up again. Card that will not come in shown in play, no penalty. 15. If two cards are played together the one counted is deemed to be played. 16. If a player at six-card cribbage or at three or four handed cribbage neglects to play a card that will come in, adversary may require it to be played, or may mark two holes. 17. Miscounting during play no penalty. *Showing and scoring*.—18. When reckoning, cards must remain exposed until adversary is satisfied. If a player mixes his cards with the pack, or hand and crib together, before adversary is satisfied, he forfeits score. 19. If a player scores more than he is entitled to, adversary may correct his score, and add points overscored to his own. This law applies also to placing peg in game hole in error. Scoring too few, no penalty. Player is not entitled to any assistance in reckoning. 20. If a player touches his opponent's pegs except to correct an overscore, or touches his own pegs when he has no score to make, his adversary marks two holes. 21. If a player displaces his foremost peg he must put it behind the other. If he displaces both, adversary may place hindmost peg where he believes it to have been, and the other peg behind it. (H. J.)

CRICHTON, JAMES (1560–1582), commonly called "the Admirable Crichton," was the son of Robert Crichton, lord-advocate of Scotland in the reign of James VI, and was born at Elixock, in Dumfriesshire. He was sent when ten years old to St. Salvator's College, St. Andrew's, where he took his master's degree at fifteen. In 1577 he was still living in Scotland; some time after that date, however, a quarrel with his father, who had become a Protestant, drove him to France. In Paris his disjunct

and his sword-play are said to have gained him equal admiration; and, according to Urquhart's very doubtful story, a contest in twelve languages resulted in an easy victory over the whole staff of the Sorbonne. His Parisian triumphs were followed by a couple of years of obscure campaigning in the French army, but in 1580 he appeared at Venice. A Latin poem addressed to Aldus Manutius laid the foundation of a lasting friendship with the great printer, who dedicated his edition of Cicero's *Paradoxa* to Crichton, and, according to some, conferred on him still more substantial favors; he also became intimate with Sperone Speroni, and with Lorenzo Massa and Giovanni Donati. His first public display was the delivery of an address to the doge and senate, whom he astonished with his eloquence and oratorical grace; and he followed this up with a series of disputations on mathematical, theological, and philosophical subjects, which so extended his fame that it was reckoned the highest honor to Mazzoni, a famous dialectician, thrice to have met and vanquished him in argument. But these exertions produced an illness which held him prostrate for four months. At Padua, the scene of his next exhibition, he astonished the assembled professors by extemporizing in succession a Latin poem, a daring onslaught on certain Aristotelian errors, and an impassioned oration in praise of ignorance. His return to Venice was signalized by the publication of the challenge preserved by Aldus Manutius, in which he undertook not only to refute innumerable errors in Aristotelians, mathematicians, and schoolmen, but to meet his opponents on any ground, and to conduct the dispute either logically, or according to the secret doctrine of numbers, or in a hundred sorts of verse; and in the church of San Paolo and San Giovanni the young Scotsman held his own for three days against all comers. He then seems to have quitted the republic for Mantua, where he had been appointed tutor to Vincenzo Gonzaga, heir to the dukedom. There he distinguished himself, according to Urquhart, by killing a professional duellist, who had challenged and vanquished many of the best swordsmen of Italy, and by playing before the court some fifteen characters in succession, keeping the stage for five hours. His brilliance made men envious, and he is said to have supplanted the prince in the affections of his mistress. One July evening in 1582 he was attacked by three masquers in the streets of Mantua. But he fought so well that their leader, to save his life, was forced to discover himself. It was Vincenzo Gonzaga himself. The tutor fell on his knee, and presenting his sword, asked pardon; but the prince basely run him through the body.

The standard biography is that of Patrick Fraser Tytler,—*Life of James Crichton of Cluny*, 1819. See also David Irving's notice in earlier editions of the present work, and "The Discovery of a Most Exquisite Jewel," in the *Works of Sir Thomas Urquhart of Cromarty* (Maitland Club), Edinburgh, 1834.

CRICKET (*Achetidae*), a family of saltatory Orthopterous Insects, characterized by the great length and slenderness of the antennæ, and by the horizontal position of the wings and wing-covers when at rest. The wings when folded form long slender filaments, which often reach beyond the extremity of the body, and give the appearance of a bifid tail, while in the male they are provided with a stridulating apparatus by which the well-known chirping sound, to which the insect owes its name, is produced. The abdomen of the female ends in a long slender ovipositor, which, however, is not exerted in the Mole Cricket. The House Cricket (*Acheta domestica*) is of a greyish-yellow color marked with brown. It frequents houses, especially in rural districts, where its lively, if somewhat monotonous, chirp may be heard nightly in the neighborhood of the fireplace. It is particularly fond of warmth, and is thus frequently found in bakeries, where its burrows are often sunk to within a few inches of the oven. In the hot summer it goes out of doors, and frequents the walls of gardens, but returns again to its place by the hearth on the first approach of cold, where, should the heat of the fire be withdrawn, it becomes dormant. It is nocturnal, coming forth at the evening twilight in search of food, which consists of bread crumbs and other refuse of the kitchen. The Field Cricket (*Acheta campestris*) is a larger insect than the former, and of a darker color. It burrows in the ground to a depth of from 6 to 12 inches, and in the evening the male may be observed sitting at the mouth of its hole noisily stridulating until a female approaches, "when," says Bates, "the louder notes are succeeded by a more subdued tone, whilst the successful mu-

sician carcases with his antennæ the mate he has won." The musical apparatus in this species consists of upwards of 130 transverse ridges on the under side of one of the nervures of the wing cover, which are rapidly scraped over a smooth, projecting nervure on the opposite wing. The female deposits her eggs—about 200 in number—on the ground, and when hatched the larvæ, which resemble the perfect insect except in the absence of wings, form burrows for themselves in which they pass the winter. The Mole Cricket (*Gryllotalpa vulgaris*) owes its name to the striking analogy in its habits and structure to those of the common mole. Its body is thick and cylindrical in shape, and it burrows by means of its front legs, which are short and greatly flattened out and thickened, with the outer edge partly notched so as somewhat to resemble a hand. It prefers loose and sandy ground in which to dig, its burrow consisting of a vertical shaft from which long horizontal galleries are given off; and in making those excavations it does immense injury to gardens and vineyards by destroying the tender roots of plants, which form its principal food. It also feeds upon other insects, and even upon the weak of its own species in the absence of other food. It is exceedingly fierce and voracious, and is usually caught by inserting a stem of grass into its hole, which being seized, is retained until the insect is brought to the surface. The female deposits her eggs in a neatly constructed subterranean chamber, about the size of a hen's egg, and sufficiently near the surface to allow of the eggs being hatched by the heat of the sun.

CRICKET is the national game of Englishmen. The prevalent love of the pastime may perhaps be cited as an instance of the development of the national character, requiring, as it does, such a combination of intellectual and physical qualities—broad and open shoulders, stout arms and quick legs, with patience, calculation, and promptness of execution.

In the infancy of the game stumps did not exist. A circular hole in the turf supplied their place, and it is surmised that the batsman was put out either by being caught, or, when running, by the outside returning the ball into the cavity ere the striker placed the base of his bat therein. This led to unseemly tussles between the batsmen and fielders, often to the detriment of the latter's hands. It is surmised from the old records of the Hambledon Club that the first description of wicket comprised one stump only, 18 inches high, which was displaced with the ball, in lieu of "holing" the same in order to put the runner out, but absolute proof on this point is wanting. The date of a second stump being added is buried in obscurity. It is only known that they were placed 2 feet apart, with a connecting cross-bar on the top, the height being 1 foot; and a large hole for putting the ball into was excavated between the stumps. The dimensions of 22 inches by 6 inches were adopted in 1702, and thus, as far as is known, matters remained till, in 1775, at a Hambledon Club match, the ball was observed to pass thrice between the two stumps without dislodging the cross-bar. To obviate this a third stump was added in the middle, and the modern bails were substituted for the cross-bar. The next alteration was to 24 inches by 7 inches in 1798, and in 1817 another inch was added to the height; at which dimensions, viz., 27 inches by 8 inches, the wicket remains in 1877. It is possible that there were other intermediate alterations from time to time; but as each year's laws have not been preserved, this is uncertain. From the earliest days, however, the wickets have always been placed one chain or 22 yards apart.

Cricket bats were at first made with a sweeping curve at the base, which made them available for hitting only. They were broader and far more cumbersome than the lithe spring-handled implements of the present day,—the shape now in use appearing to have become prevalent about 1825, when round arm bowling came permanently into vogue. A sketch of the various shapes in use from early times downwards, will be found in the frontispiece of Mr. Frederick Gale's *Echoes from the old Cricket Fields*. No evidence exists as to the size and weight of the first balls used. At the end of the 18th century they were much of the same dimensions as now, but both materials and workmanship have vastly improved even since the first "treble sewn" was manufactured.

Cricket is divided into single and double wicket, and it is a moot point which of the two was the parent

game. Judging, however, from the earliest evidence extant, it seems probable that single wicket was the first instituted, as it is less complicated and requires fewer players. In their pavilion at the Kennington Oval the Surrey County Cricket Club possesses the earliest known picture of the game in anything like its present form. The date is 1743, and the stumps are aptly described by Mr. Frederick Gale as "a skeleton hurdle of about 2 feet wide and 1 foot high." The bat is of the old-fashioned curved shape, and the score was kept by notching each individual run on a stick. With the exception that all play was evidently forward of the wicket (the same is the case now in single wicket matches with less than five a side), the leading features of the game are identical with those of the present day. Single wicket, however, was never much practised after a knowledge of the game became thoroughly diffused, except by great players for a large stake or a championship. It is with the double wicket game that we are more immediately concerned, that being the now universally accepted form.

The most radical change that has ever taken place in the development of the game is the introduction of round or straight arm bowling in lieu of the underhand. That the new style was first discovered (about 1785) by Tom

wicket, and the object of the fielders is to dislodge them according to the rules of the game. The other strikers go in by rotation as arranged by their captain. When a ball is hit the striker may, if possible, score a run by reaching the opposite popping crease ere the wicket is put down, each time he successfully traverses the distance between the two popping creases counting as one run. When sufficient time is available each side has two innings, and that scoring the largest number of runs is the winner. Otherwise both sides may agree to decide the issue on the result of one innings apiece, and it is sometimes arranged to allow six balls in each over, instead of four. At the end of each over, the whole of the outside change their positions; another bowler delivers an over from the opposite wicket, and so on alternately. A general idea of the position of the players may be formed from the accompanying diagram, but variations take place according to the description of bowling in use.

A captain is chosen on each side, who has the entire management of his eleven. In conjunction with the opposing captain he makes the necessary arrangements for the match. He should be a thorough judge of all points of the game, and able to place the field to the best advantage according to the description of the bowling and peculiarities of the strike. Constant practice is necessary to become a good bowler, and obtain such a thorough command of the ball as to vary the pace and pitch as well as to impart twist. The two chief varieties of balls are "lengths" and "not lengths," according as their pitch deceives the striker's eye as much as possible or not. A batsman's first rule is to play with a straight bat, as he thereby gains most protection for his stumps; and he should make the most of his stature. Batting is divided into "forward" and "back play," according as the batsman stretches forward to meet the ball, or keeps the body perpendicular or slightly inclined backwards. The fielders should ever be on the alert, their business being to stop or catch the ball, and return it to one of the wickets with all possible haste. For further details of each player's duties and full instructions how to play the game correctly, we must refer our readers to the Rev. James Pycroft's excellent work, *The Cricket Field*. Single wicket is sufficiently explained by the laws, the only material difference being that the batsman has to reach the bowling stump and return to the popping crease—a distance of 44 yards in place of 22 yards—for every run he scores. The laws of the game as now constituted by the Marylebone Cricket Club are as follows:—

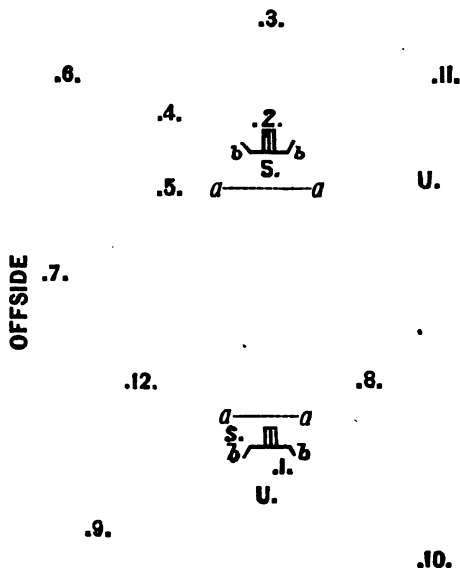

Diagram of Cricket-field.

- |  |   |
|--|---|
| <p>S, S. Batsmen.<br/>U, U. Umpires.<br/>a, a. Popping Creases.<br/>b, b. Bowling Creases.<br/>1. Bowler.<br/>2. Wicket Keeper.<br/>3. Long Stop.<br/>4. Slip.<br/>5. Point.</p> | <p>6. Long Slip.<br/>7. Cover Point.<br/>8. Mid On (sometimes placed at 12 and termed Mid Off).<br/>9. Long Field Off.<br/>10. Long Field On.<br/>11. Leg.<br/>12. See 8.</p> |
|--|---|

Walker, a professional of the old Hambledon Club, is now generally admitted; but the dogged conservatism of the day pronounced it to be unfair, and successfully repressed the innovation. About 1805 the style was revived by Mr. John Wiles, a great Kentish amateur. It was not, however, until 1825, when Mr. G. T. Knight of Alton strenuously took up the cudgels on behalf of the so-called "throwing bowling," that it became a permanent institution, and then only after many bickerings and much controversy. The new style created a great revolution in cricket, as it afforded the bowlers much greater command over their delivery both in strength and in direction. From time to time various other new points have arisen requiring special legislation, and changes have taken place in the mode of conducting the game.

Much labor and careful attention are required in laying out a good cricket ground and maintaining the same in proper order. As a general rule the shorter and more level the turf can be got the better. Double wicket requires two sides of eleven players each, the choice of first innings being decided by lot. Two strikers go in, one at each

1. The ball must weigh not less than 5½ nor more than 5½ ounces. It must measure not less than 9 nor more than 9½ inches in circumference. At the beginning of each innings, either party may call for a new ball.
2. The bat must not exceed 4½ inches in the widest part; it must not be more than 38 inches in length.
3. The stumps must be 3 in number, 27 inches out of the ground; the balls 8 inches in length; the stumps of equal and of sufficient thickness to prevent the ball from passing through.
4. The bowling crease must be in a line with the stumps, and 6 feet 8 inches in length, the stumps in the centre,—with a return crease at each end towards the bowler at right angles.
5. The popping crease must be 4 feet from the wicket, and parallel to it, unlimited in length, but not shorter than the bowling crease.
6. The wickets must be pitched opposite to each other by the umpires, at the distance of 22 yards.
7. It shall not be lawful for either party during the match, without the consent of the other, to alter the ground by rolling, watering, covering, mowing, or beating, except at the commencement of each innings, when the ground shall be swept and rolled unless the next side going in object to it. This rule is not meant to prevent the striker from beating the ground with his bat near to the spot where he stands during the innings, nor to prevent the bowler from filling up holes with saw-dust, etc., when the ground shall be wet.
8. After rain the wickets may be changed with the consent of both parties.
9. The bowler shall deliver the ball with one foot on the ground behind the bowling-crease, and within the return crease, and shall bowl one over before he change wickets, which he shall be permitted to do twice in the same innings, and no bowler shall bowl more than two overs in succession.
10. The ball must be bowled. If thrown or jerked the umpire shall call "no ball."
11. The bowler may require the striker at the wicket from which he is bowling to stand on that side of it which he may direct.
12. If the bowler shall toss the ball over the striker's head, &c

bowled so wide that, in the opinion of the umpire, it shall not be fairly within the reach of the batsman, he shall adjudge one run to the party receiving the innings, either with or without an appeal, which shall be put down to the score of wide balls; such ball shall not be reckoned as one of the four balls; but if the batsman shall by any means bring himself within the reach of the ball, the run shall not be adjudged.

13. If the bowler shall deliver a "no ball," or a "wide ball," the striker shall be allowed as many runs as he can get, and he shall not be put out except by running out. In the event of no run being obtained by any other means, then one run shall be added to score of "no balls" or "wide balls" as the case may be. All runs obtained for "wide balls" to be scored to "wide balls." The names of the bowlers who bowl "wide balls," or "no balls," in future to be placed on the score, to show the parties by whom either score is made. If the ball shall first touch any part of the striker's dress or person (except his hands), the umpire shall call "leg bye."

14. At the beginning of each innings the umpire shall call "play;" from that time to the end of each innings no trial ball shall be allowed to any bowler.

15. The striker is out if either of the balls be bowled off, or if a stump be bowled out of the ground;

16. Or if the ball from the stroke of the bat or hand, but not the wrist, be held before it touch the ground, although it be hugged to the body of the catcher;

17. Or if in striking, or at any other time while the ball shall be in play, both his feet shall be over the popping crease, and his wicket put down, except his bat be grounded within it;

18. Or if in striking at the ball he hit down his wicket;

19. Or if, under pretence of running or otherwise, either of the strikers prevent a ball from being caught, the striker of the ball is out;

20. Or if the ball be struck and he wilfully strike it again;

21. Or if in running the wicket be struck down by a throw, or by the hand or arm (with the ball in hand), before his bat (in hand) or some part of his person be grounded over the popping crease; but if both balls be off, a stump must be struck out of the ground;

22. Or if any part of the striker's dress knock down the wicket;

23. Or if the striker touch or take up the ball while in play, unless at the request of the opposite party;

24. Or if with any part of his person he stop the ball, which, in the opinion of the umpire at the bowler's wicket, shall have been pitched in a straight line from it to the striker's wicket and would have hit it.

25. If the players have crossed each other, he that runs for the wicket which is put down is out.

26. A ball being caught, no run shall be reckoned,

27. The striker being run out, the run which he and his partner were attempting shall not be reckoned.

28. If a lost ball be called, the striker shall be allowed six runs, but if more than six shall have been run before lost ball shall have been called, then the striker shall have all that have been run.

29. After the ball shall have been finally settled in the wicket-keeper's or bowler's hand, it shall be considered dead; but when the bowler is about to deliver a ball, if the striker at his wicket go outside the popping crease before such actual delivery, the said bowler may put him out, unless (with reference to the 21st law) his bat in hand, or some part of his person, be within the popping crease.

30. The striker shall not retire from his wicket and return to it to complete his innings after another has been in, without the consent of the opposite party.

31. No substitute shall in any case be allowed to stand out or run between the wickets for another person without the consent of the opposite party; and in case any person shall be allowed to run for another, the striker shall be out if either he or his substitute be off the ground in manner mentioned in laws 17 and 21, while the ball is in play.

32. In all cases where a substitute shall be allowed, the consent of the opposite party shall also be obtained as to the person to act as substitute, and the place in the field which he shall take.

33. If any fieldsman stop the ball with his hat, the ball shall be considered dead, and the opposite party shall add five to their score. If any be run they shall have five in all.

34. The ball having been hit, the striker may guard his wicket with his bat, or with any part of his body except his hands, that the 23d law may not be disobeyed.

35. The wicket-keeper shall not take the ball for stumping until it has passed the wicket; he shall not move until the ball be out of the bowler's hand; he shall not by any noise incommode the striker; and if any part of his person be over or before the wicket, although the ball hit it, the striker shall not be out.

36. The umpires are the sole judges of fair and unfair play; and all disputes shall be determined by them, each at his own wicket; but in case of a catch which the umpire at the wicket

bowled from cannot see sufficiently to decide upon, he may apply to the other umpire, whose opinion shall be conclusive.

37. The umpires in all matches shall pitch fair wickets; and the parties shall toss up for choice of innings. The umpires shall change wickets after each party has had one innings.

38. They shall allow two minutes for each striker to come in and ten minutes between each innings. When the umpire shall call "play" the party, refusing to play shall lose the match.

39. They are not to order a striker out unless applied to by the adversaries.

40. But if one of the bowler's feet be not on the ground behind the bowling crease and within the return crease when he shall deliver the ball, the umpire at his wicket, unasked, must call "no ball."

41. If either of the strikers run a short run the umpire shall call "one short."

42. No umpire shall be allowed to bet.

43. No umpire is to be changed during the match, unless with the consent of both parties, except in case of violation of 42d law; then either party may dismiss the transgressor.

44. After the delivery of four balls the umpire must call "over," but not until the ball shall be finally settled in the wicket-keeper's or bowler's hand; the ball shall then be considered dead; nevertheless, if any idea be entertained that either of the strikers is out, a question may be put previously to, but not after, the delivery of the next ball.

45. The umpire must take especial care to call "no ball" instantly upon delivery, "wide ball" as soon as it shall pass the striker.

46. The players who go in second shall follow their innings if they have obtained eighty runs less than their antagonists, except in all matches limited to one day's play, when the number shall be limited to sixty instead of eighty.

47. When one of the strikers shall have been put out, the use of the bat shall not be allowed to any person until the next striker shall come in.

*Nota.*—The committee of the Marylebone Club think it desirable that previously to the commencement of a match, one of each side should be declared the manager of it; and that the new laws with respect to substitutes may be carried out in a spirit of fairness and mutual concession, it is their wish that such substitutes be allowed in all reasonable cases, and that the umpire should inquire if it is done with consent of the manager of the opposite side.

Complaints having been made that it is the practice of some players when at the wicket to make holes in the ground for a footing, the committee are of opinion that umpires should be empowered to prevent it.

#### *Single Wicket.*

1. When there shall be less than five players on a side, bounds shall be placed twenty-two yards each in a line from the off and leg stump.

2. The ball must be hit before the bounds to entitle the striker to a run, which run cannot be obtained unless he touch the bowling stump or crease in a line with it with his bat, or some part of his person, or go beyond them, returning to the popping crease as a double wicket, according to the 21st law.

3. When the striker shall hit the ball one of his feet must be on the ground and behind the popping crease, otherwise the umpire shall call "no hit."

4. When there shall be less than five players on a side neither eyes nor overthrows shall be allowed, nor shall the striker be caught out behind the wicket, nor stumped out.

5. The fieldsman must return the ball so that it shall cross the play between the wicket and the bowling stump, or between the bowling stump and the bounds; the striker may run till the ball be so returned.

6. After the striker shall have made one run, if he start again he must touch the bowling stump, and turn before the ball cross the play to entitle him to another.

7. The striker shall be entitled to three runs for lost ball, and the same number for ball stopped with hat, with reference to the 28th and 33d laws of double wicket.

8. When there shall be more than four players on a side there shall be no bounds. All hits, byes, and overthrows shall then be allowed.

9. The bowler is subject to the same laws as at double wicket.

10. No more than one minute shall be allowed between each ball.

#### *Bets.*

1. No bet upon any match is payable unless played out or given up.

2. If the runs of one player be betted against those of another, the bet depends on the first innings unless otherwise specified.

3. If the bet be made on both innings, and one party beat the other in one innings, the runs of the first innings shall determine it.

4. If the other party go in a second time, then the bet must be determined by the number on the score.

#### *County Cricket.*

The following laws of county qualification were estab-

lished at a meeting held in the Surrey County Pavilion, Kennington Oval, on June 9, 1873:—

1. That no cricketer, whether amateur or professional, shall play for more than one county during the same season.
2. Every cricketer born in one county and residing in another shall be free to choose at the commencement of each season for which of those counties he will play, and shall, during that season, play for that county only.
3. A cricketer shall be qualified to play for any county in which he is residing and has resided for the previous two years, or a cricketer may elect to play for the county in which his family home is, so long as it remains open to him as an occasional residence.
4. That, should any question arise as to the residential qualifications, the same should be left to the decision of the committee of the Marylebone Club.

*History.*—The name cricket is cognate to the Saxon *cric* or *wyc*, a crooked stick. This germ of the modern bat is seen in the earliest representation of the pastime about the middle of the 13th century. In a MS. in the King's Library, 14 Bv, entitled *Chronique d'Angleterre, depuis Ethelbert jusqu'à Henry III.*, there is found a grotesque delineation of two male figures playing a game with a bat and ball. This is undoubtedly the first known drawing of what was destined to develop into the scientific cricket of modern times. The left-hand figure is that of the batsman, who holds his weapon perpendicularly in the right hand with the handle downwards. The right-hand figure shows the catcher, whose duty is at once apparent by the extension of his hands. In another portion of the same MS., however, there is a male figure pointing a bat, with the base curved like a leopard's head, towards a female figure in the attitude of catching, but the ball is absent. On p. 126 of King Edward I.'s wardrobe account for the year 1300, there occurs the following entry, viz., "Domino Johanni de Leek capellano Domini Edwardi filii Regis, pro den' per ipsum liberat' eidem Domino suo ad ludendum ad *creag*, et alios ludos per vios, per manus proprias apud Westm', 10 die Martii, 100s. Et per manus Hugonis camerarii sui apud Newtonon mense Martii, 20s.—summa, £6." Here is found the earliest allusion to the game as designated by a term analogous to the modern word "cricket," as well as indisputable proof that even in these early times the game was followed by the first personages in the realm, who of course spoke French. In a Bodleian Library MS., No. 264, dated 18th April, 1344, and entitled *Romançe of the Good King Alexander*, fielders for the first time appear in addition to the batsman and bowler. All the players are monks with their cowls up and down alternately, the former having been erroneously taken for female figures by Strutt in his *Sports and Pastimes*. On the extreme left of the picture the bowler, with his cowl up, poises the ball in the right hand with the arm nearly horizontal. The batsman comes next with his cowl down, a little way only to the right, standing sideways to the bowler with a long roughly-hewn and slightly-curved bat, held vertically, handle downwards in the left hand. On the extreme right come four figures—with cowls alternately down and up, and all having their hands raised in an attitude to catch the ball should it be missed by the batsman, or be tipped in their direction. Judging, however, from the positions of bowler and batter, the out players are not placed so as to field a direct, but a side, hit. But the want of perspective in the composition renders any estimate of their object uncertain. It is evident, however, that the bat was always held in the left hand at this date, since on the opposite page of the same MS. a solitary monk is figured, with his cowl down, and so holding a somewhat elongated oval-shaped implement. The close roll of 89 Edw. III. (1365), Mon. 23, disparages certain games on account of their interfering with the practice of archery, where the game of cricket is probably included among the pastimes denounced as "*ludos inhonestos, et minus utiles aut valentes.*" In this instance cricket was clearly considered fit for the lower orders only. Judging from the drawings, it can only be conjectured that the game consisted of bowling, batting, and fielding, though it is known that there was an inside and an outside, for some time during the 15th century the game was called "*Hondyn* or *Hondoute*," or "*Hand* in and *Hand* out." Under this title it was interdicted by 17 Edw. IV. c. 3 (1477-78), as one of those illegal games which still continued to be so detrimental to the practice of archery. By this statute any one allowing the game to be played on his premises was liable to three years' imprisonment and £20 fine, any player to two years' imprisonment and £10 fine, and the implements to be burnt. The inference that hand in and hand out was analogous to cricket is made from a passage in the Hon. Daines Barrington's *Observations on the more Ancient Statutes from Magna Charta to 21 James I. cap. 27*. Writing in 1766, he comments thus on the above statute, viz.: "This is, perhaps, the most severe law ever made against gaming, and some of these forbidden sports seem to have been manly exercises, particularly the *handyn* and *handoute*, which I should suppose to be a kind of cricket, as the term *hande* is still retained in that game."

The word "cricket" first occurs about the year 1556. In Russell's *History of Guildford* (p. 203), it appears there was a piece of waste land in the parish of Holy Trinity, in that city, which was enclosed by one John Parish, an innholder, some five years before Queen Elizabeth came to the throne. In 35 Elizabeth (1593), evidence was taken before a jury and a verdict returned, ordering the garden to be laid waste again and disinclosed. Amongst other witnesses, John Derrick, gent., and one of H. M.'s coroners for Surrey, *ætas* fifty-nine, deposed he had known the ground for fifty years or more, "and when he was a scholler in the free school of Guildford, he and several of his feloes did runne and play there at *cricket* and other plaies." In the original edition of Stow's *Survey of London* (1598), the word does not occur, though he says, "The ball is used by noblemen and gentlemen in Tennis courts, and by people of the meaner sort in the open fields and streets." It might justly be surmised that such a national game as cricket would soon be introduced at public schools. Accordingly, the first trace of it is found at Winchester College in 1656, since Lisle Bowles, writing of the good Bishop Ken, who was admitted to Winchester 13th January, 1650-51, says, "on the 6th or 6th day our junior . . . is found for the first time attempting to wield a cricket bat." In 1688 we find a "ram and bat" charged in an Etonian's school bill. Two other noteworthy references to the game are found during the last quarter of the 17th century. The first is in a somewhat ribald poem (1688), entitled, *The Mysteries of Love and Eloquence, or the Arts of Wooing and Complimenting*, by Edward Phillips, John Milton's nephew, who, in a dialogue between a country bumpkin and his mistress going to a fair, makes the latter say, "Would my eyes had been beat out of my head with a cricket-ball!" The second occurs in the diary of the Rev. Henry Teonge, a naval chaplain to H. M. ship "Assistance," and states that during a visit to Antioch on 6th May, 1676, several of the ship's company, accompanied by the consul, rode out of the city early, and amongst other pastimes indulged in "krickett." During the first half of the 18th century the game became popular, and is repeatedly noticed by writers of the time, such as Swift, D'Urfey, Pope, Soame Jenyns, and Styrpe in his edition of *Stow's Survey of London*.

In 1748 it was decided that cricket was not an illegal game under the well-known statute 9 Anne cap. 19, the Court of King's Bench holding "that it was a very manly game, not bad in itself, but only in the ill use made of it by betting more than ten pounds on it; but that was bad and against the law." In these early times even the pastime was followed by all classes, and Frederick, prince of Wales, died in 1751 from internal injuries caused by a blow from a cricket-ball whilst playing at Cliefden House. Nevertheless, this commingling of aristocrats and plebeians on the cricket sward was viewed with apprehension, and repeatedly discountenanced by writers of the day. Games were played for large stakes. Ground proprietors and tavern-keepers farmed and advertised matches, the results whereof were not always above suspicion. The old artillery ground at Finsbury appears to have been the earliest scene of action of this class of matches. But the true birthplace of the game in its developed state was no cockney inclosure, but the broad open downs of the southern counties of England, and more especially in the great hop-growing districts. The large hop fairs, notably that of Weyhill, were the rendezvous for all comers from the southern counties, and it is probable that the great county matches were arranged on these occasions. The first record preserved of a match is between Kent and All England, which, judging from an advertisement in the *General Advertiser* of the day, was played on August 4, 1746, at the Artillery Ground, the score being kept in the modern fashion.

The old Hambledon Club was the first founded in England, and lasted from 1750 to 1791. Its playing-fields were Broad Half Penny and Windmill Downs. When at its zenith the club frequently contended with success against All England. Their great players were more or less retained by noblemen and wealthy patrons of the game, and this club remained invincible for some forty years. Though a cricket club existed at Hambledon down to 1825, the original society was broken up in 1791, owing to the distance from the metropolis. A dispersion of its famous players through neighboring counties took place, and was naturally accompanied with a diffusion of the precepts of the game, which gradually extended northward and westward till, at the end of the 18th century, cricket had become established as the national game of England. The famous Marylebone Cricket Club now justly ranks as the leading club of the world, frames the laws governing the game, and arbitrates on all disputes connected therewith. This society sprang out of the old Artillery Ground Club, which played at Finsbury till about 1750, when they moved to White Conduit Fields, and became the White Conduit Cricket Club. In 1787 they were remodelled under their present title, and moved to Old Lord's Ground, on the site of Dorset square, thence in 1824 to Middle Lord's Ground at South Bank, on the site of the Regent's Canal, and finally in 1827 to the present Lord's Ground, which in 1864 became their freehold property. The Surrey County

Club, with the Kennington Oval as their headquarters, was formed in 1845. In the same year the famous I Zingari Club, confined exclusively to amateurs, first saw light, and commenced its Bohemian wanderings throughout Great Britain, and often into foreign countries. In 1846 an "All England Eleven," under the captaincy of Clarke, "The Nottingham Bowler," commenced playing matches against odds in various parts of the country. Since then several professional elevens annually play what may be termed exhibition matches in all parts of Great Britain. Such contests are often detrimental to the professionals engaged in them, but on the other hand they have done much to diffuse a seal for cricket, and at the present time there is not a county, large city, university, or public school, town or village, in England, which does not possess its cricket club, without mentioning the British colonies, and wherever Englishmen assemble abroad in sufficient numbers.

The chief works on cricket are—H. Bentley's *Scores from 1786 to 1822*, published in 1823; John Nyren's *Young Cricketer's Tutor*, 1833; N. Wanoostrocht's *Felix on the Bat*, various editions, 1845-1855; *Cricket Notes*, by W. Bolland (Hon. S. Pausonby), 1851; F. Lillywhite's *English Cricketers' Trip to Canada and the United States*, 1860; F. Lillywhite's *Cricket Scores and Biographies*, 1746 to 1840, 1862; Rev. J. Pyeroff's *Cricket Tutor*, 1862; Rev. J. Pyeroff's *Cricket Field*, various editions, 1862-1873; Rev. J. Pyeroff's *Cricketiana*, 1865; *Jerks in from Short Leg*, by Quid (R. A. Fitzgerald), 1866; G. H. Selkirk's *Guide to the Cricket Ground*, 1867; C. Box's *Theory and Practice of Cricket*, 1868; F. Gale's *Echoes from Old Cricket Fields*, 1871; *Cricketers in Council*, by Thomsonby (H. P. Thomas), 1871; R. A. Fitzgerald's *Wickets in the West*, 1873; *Marylebone Cricket Club Scores and Biographies*, 1876, a continuation of Lillywhite's *Scores and Biographies*; and C. Box's *English Game of Cricket*, 1877. (N. P. W.)

CRICKLADE, a town and parliamentary borough of England on the northern borders of the county of Wilts, situated in a flat stretch of country on the right bank of the Thames, not far from the Thames and Severn Canal. The town consists of one rather mean-looking street; and its principal buildings are St. Sampson's Church restored in 1864, St. Mary's with a fine Gothic cross in the churchyard, and public chambers built in 1861. The trade is purely agricultural and local. The position of the town at the passage of the Thames gave it some little importance in the Saxon period, and it sent representatives to Parliament as early as the reign of Edward I. The present parliamentary borough, which extends partly into Gloucestershire, and includes no fewer than fifty-two parishes or parts of parishes, with an area of 26,694 acres, had in 1871 a population of 43,622, of whom less than 2000 were in the town.

CRIEFF, a town in Perthshire, Scotland, on the north bank of the Earn, seventeen miles west of Perth by rail. It is situated on a declivity rising from the river, which is here crossed by a bridge. It consists of a main street with narrower streets branching off at right angles, and contains several churches, an endowed academy for boys, an industrial institution, and a mechanics' institute. The town is comparatively modern, but an ancient sculptured stone still stands in the High Street and also the old town cross. Crieff owes its growth mainly to the central position it occupies in the district of upper Strathearn, which is noted for its beauty and salubrity. Strathearn House, a large hydropathic establishment on the slope of a hill above the town, attracts many visitors. Population in 1871, 4027.

CRIME is a word which, in every-day speech, is sometimes made to include more and sometimes less than the subject of the present article. On the one hand, the breach of a moral principle, with which the law has never concerned itself, is sometimes loosely described as criminal; on the other hand, a distinction is sometimes drawn between crimes and minor offences, though the law prescribes a punishment for minor offences as well as for crimes. But if moral theories and slender shades of difference in guilt are disregarded, crime is simply conduct (either in commission or in omission) of which the state disapproves, and for which it demands a penalty.

Though, however, it is possible to give a definition of crime which may hold good for all times and for all countries, it by no means follows that crime is always and everywhere the same. On the contrary, the growth and the changes of criminal laws are among the most curious monuments of revolutions in public opinion as displayed by legislation. Nor can the study of morals be altogether dissociated from the study of crime, because the moralist

may and frequently does influence the legislator, and that which is but a moral lapse in one generation may become a criminal offence in another. So also deeds which have been considered praiseworthy at one period, may at another be punishable; and new conditions of society may cause penalties to be exacted for action or for negligence which would be altogether inconceivable to the savage.

It is obvious that no moral philosopher or legislator, no one even uniting in himself the functions of both, would be able to devise a penal code which would be all-sufficient, and which would be applicable to every possible detail in the development of an ever-expanding civilization. New circumstances demand new laws; and the adaptation of new laws to new circumstances is not the least interesting feature in the history of any country. Religious beliefs, religious and other theories of ethics, the attacks of foreign enemies, the growth of commerce, the progress of science, everything which affects the condition of the community, may affect its criminal legislation.

In very primitive tribes murder, robbery, and rape are not crimes—not, at least, in the modern sense. For one tribe to attack another by surprise, to slaughter its men, to appropriate its land, and to ravish or enslave its women was, and in some places still is, very meritorious conduct. The first approach towards the reprobation of murder is to be found in the ancient blood-feud, which, however, resembles quite as much the ferocity of the wild beast deprived of its young as the indignation of the civilized human being at an attack upon the general security of life. The family of the slain assumed the right to exact vengeance of the slayer and his kin if members of the same tribe as themselves; and the earliest form of vengeance was bloodshed. This was not modified until men had arrived at the notion of property distinguishable from that which was held in common by the tribe—a very important stage in the progress of human affairs.

It is well established that the tenure of land in severalty is of later date than tenure by the tribe or community at large; and as soon as the claim of any individual to any particular piece of land was recognized, in any form, the right of property in movables must have been recognized also, if indeed the latter did not precede the former. Sooner or later the ownership of certain families was admitted in the case of plots of ground and flocks and herds, the ownership of particular persons in the case of arms and armor and the implements of agriculture. Hence arose the practice of compounding with the avengers of blood. The relatives of the slain agreed to accept cattle, or any movable goods of which they might stand in need, as an equivalent for the life of the kinsman whom they had lost. But Governments which had advanced very little on the path of civilization perceived that the loss of a tribesman was a loss to the community, because—if for no other reason—it represented a diminution of force in a conflict with a rival tribe. When a fine was paid for murder, therefore, a portion of it only was allotted to the kin of the person murdered, and the remainder to the king or other governing power.

As soon as the state had thus claimed a share of the blood-fine, *werg*, or *werg*, the foundation of the criminal law had been laid—a distinction had been drawn between injuries affecting the individual alone and injuries affecting the community also. It was perhaps only natural that when movables were accepted as compensation for a life held to be forfeited for murder, the wrongful appropriation of movables should be punishable by death—a not uncommon penalty in many primitive laws. Extreme severity of punishment for all offences (except homicide) committed within the boundaries of the tribe is indeed the characteristic of all the earliest attempts to deal with crime. The idea of the uncivilized man is that the most ferocious chastisement is the most certain deterrent; and as he has won most of that which he possesses by taking it forcibly from others, he is not disposed to attribute to his fellow tribesmen any very high respect for property in the abstract.

Nevertheless, with the tenure of land in severalty, and the acquisition of some personalty, was necessarily developed, in one form or other, the idea of protection for life and property in general. But small tribes continued to be engaged in frequent conflicts with their neighbors; and the principles of right and wrong which were applied to the various individuals composing any one tribe were in prac-

tice, if not in theory, long disregarded in dealings with the stranger. Outside a certain circle of no very great extent killing was still no murder, taking no theft or robbery, capture or violation of a woman no rape, in the modern sense. When tribes became united into nations, the rivalry of clan against clan was not immediately extinguished; and the sentiments of the robber chieftain coexisted with governments which sanctioned laws for the repression of robbers and their deeds of violence. National growth out of these discordant elements is to be traced, with the greatest clearness, in the marvellously complete series of records preserved in the English Public Record Office, and not least in those which concern the Scottish and Welsh borders.

The law of development is not restricted to one island, or to races speaking one particular language. Its range appears to be as wide as history, and is sometimes to be detected even where history can hardly be said to exist. If, for instance, we compare the Latin word *virtus*, the Greek word *ἀρετή*, and the Cymric word *gwroldeb*, with the English word *virtue*, we find a curious light thrown upon the progress of human opinion. The first three all had originally the same meaning—"virility;" and all three acquired precisely the same secondary signification—"courage." The reason, of course, was that in the most primitive times courage was the one great quality which above all others commanded approbation. The want of a moral attribute so universally approved was in those days a crime, and the *imbelles*, or cowards, were, if Tacitus is to be believed, subjected by the Germans to a punishment sufficiently horrible. They were thrown under a hurdle and smothered in filth. But now the word *virtue*, which once had the special meaning of strength of muscle and nerve in the man, has (if any special meaning at all) that of chastity in the woman.

Brave law-breakers, in past times, have not only believed themselves to be good men and true, but have also had the sympathy of great numbers of their fellow-countrymen. Indeed, if we regard the history of criminal legislation and of crime in England, we find the ideas of the primitive tribesman steadily resisting the advance of civilization, retreating very slowly from position to position, and rarely yielding one without a long and desperate struggle. A most prominent example of this tenacity was in the crime of forcible entry, which hardly ceased to be common before the 18th century. When valor was the greatest or only virtue, one clan took land by force from another, and clansman differed from clansman only in the greater or less vigor and courage shown in making the appropriation. Long after this half-savage condition of society, it remained a maxim of the English law that there was no legal possession of land without actual seisin. The law, indeed, would not allow its right hand to know that which was done by its left. It forbade forcible entries in the reign of Richard II., while forcible entries were an essential part of its theory. As late even as the reign of William IV. the fiction of a forcible entry continued to be one of the chief implements of the conveyancer's art. Without the "common recovery" he would have been unable to carry on the ordinary routine of his business; and the basis of that fictitious action at law was that one person had wrongfully dispossessed another of his land.

The much abused Court of Star-Chamber owed its definite constitution under the Tudors to a very laudable desire for the repression of forcible entries and certain other kindred offences. Nor was it altogether unsuccessful in attaining the object for which it was established. Those private feuds in which the nobles, like the heads of tribes, had previously delighted, began to die out when private armies could no longer be kept on foot under the name of retainers, or supplied with uniforms under the name of liveries and tokens. Yet the fact that the Star-Chamber did not entirely put an end to forcible entries is a proof that even the most vigorous legislation is not all-powerful against the human nature and the surrounding circumstances with which it may have to deal. Those circumstances, and even that nature, may to some extent be changed, for were it otherwise the British empire and British civilization could now have no existence. But there is a reciprocal action and reaction of laws upon society and of society upon laws. No edict or statute ever made a sudden and complete alteration in the manners of a whole nation, though the growing wisdom of a nation may frequently have suggested a law, and though a well-devised law may have gradually fostered

the growth of national wisdom. If it is true that *nemo repente fuit turpissimus* it is no less true that *nemo repente fuit honestissimus*.

The modern security of life and property of every description represents the triumph of new ideas over old. There is or was a popular delusion that the savage was noble, that while his manners were simple his nature was honest, and that he abhorred all such mean arts as those commonly attributed to the huckster and the trader. The truth is that his misdeeds were limited to his own particular sphere of action, which was excessively small, and that if he did not commit some of the offences known in our own time it was because he had not the opportunity. Fraud has never increased in equal proportion with the increase of trade and civilization. It infected commerce at the very beginning, and existed during the darkness of the Middle Ages in every form then possible. It may and it sometimes does assume new shapes as society groups itself anew, as occupations and the relations of man to man are changed. But force is its near relative and ally, and it flourishes in times of violence and anarchy. It made itself conspicuous throughout the age of chivalry, though poets and romance writers have attempted to hide it away. With infinite difficulty has civilized mankind so far gained the victory over its own primitive nature as to concur, with some approach to unanimity, in reprobation of the forger-monk, the brigand-knight, and the man who regarded a woman as a chattel and a tempting object for appropriation.

It is most necessary to bear in mind the contrast between the habits or ideas of one period and of another, if we wish to estimate correctly the position of the criminal in modern society, or the alleged uniformity of human actions to be discovered in statistics. There is, no doubt, some truth in the statement that in a modern civilized country—Great Britain, for example—the statistics of one year bear a very strong resemblance to the statistics of another in many particulars. But a little reflection leads to the conclusion that there is nothing at all marvellous in such coincidences, and that they do not prove human nature to be unalterable, or circumstances to be unchangeable. They only show what might have been predicted beforehand, that human beings of the same race, remaining in circumstances approximately the same, continue to act upon nearly the same motives and to display nearly the same weaknesses.

The statistics of a quarter of a century, of half a century, even of a whole century (if we had them complete for so long a period), could tell us but little of those subtle changes in human organization which have come to pass in the lapse of ages, and the sum of which has rendered life in Britain in the 19th century so different as it is from life in the 6th. Some of the earliest statisticians, indeed (and their science is of very recent origin), did an injustice both to themselves and to their favorite study through their own enthusiasm. They were eager to claim for numbers all and more than all that had been claimed by the Pythagoreans of old. Not content with praising the virtues of numbers in general, they appeared to believe that the particular numbers of a particular period would suffice for the discovery of social and political principles of universal application. They found certain uniformities in an area so bounded, and a time so short, as to bear to the previous existence of the whole earth and its inhabitants about the same proportion that a drop of water bears to the ocean; and they assumed that they had found a law or laws of a range co-extensive with human existence. But this exaggeration does not impair the real value of the statistical method or of some of the facts which it has brought to light. It has supplied us with some generalizations which are demonstrably true within certain limits, and which constitute useful elements of comparison with others discoverable elsewhere. It has not established that human conduct, regarded as a great whole, is absolutely invariable, but it has supplied a powerful instrument for an inquiry into the conditions by which variation may be determined.

If, for instance, we look at the statistics of homicide and suicide in England during any ten recent years we perceive that the figures of any one year very little exceed or fall below the general average. Yet no inference could be more erroneous than that homicide has always borne the same proportion to population in England as at present, for in the reign of Edward III. there were in proportion to population at least sixteen cases of homicide to every one which occurs in our own time. On the other hand,



according to modern statistics, the number of male suicides is far greater than the number of female; and the inference that the number of male suicides always has been greater is at least supported by records as early as the middle of the 17th century. Again, the homicides in one country may be and are far more numerous than in another, among equal populations; but nowhere does there exist any exception to the rule that there are more male suicides than female. Thus it is clear that any suggestion of uniformity offered by statistics requires the most careful verification before being accepted as even approximately true; but it is also clear that the suggestion may be of the highest value in leading us to distinguish those cases in which uniformity really exists from those in which uniformity is only apparent.

The criminal statistics of any one country and period should be carefully examined by the light of history, and of any relevant details which can be procured from other parts of the world. Only by the aid of the adequate information thus to be acquired can criminal legislation ever be wise and effective, no matter what definition of crime may be accepted by the legislators. A knowledge of human nature in the widest sense, not excepting, indeed, some of the principles of physiology, may give some power of discriminating between the mutable and the immutable, the possible and the impossible, in human affairs. Without it, well-meaning efforts to improve the condition of society may be not only unsuccessful but even mischievous. Without it, disappointment is apt to follow upon the failure of some apparently well-conceived law to effect the purpose for which it was devised. The disposition inherited from past ages can (in some fields of action and in some individuals at least) as little be changed by the fiat of a Government, as the ebb and flow of the sea can be controlled by the word of a king. But, nevertheless, there is good reason to believe that judicious lawgivers may gradually effect a salutary change in the manners of a people.

One of the most remarkable illustrations of uniformity in the phenomena of crime is one which may be regarded also as an illustration of the influence of past conditions of society upon the present. As the human embryo passes through sundry stages of an inferior state of existence, so, after birth, the human being is before the age of thirty more apt to fall into courses which we now regard as criminal (but which the savage considered laudable) than the human being of more advanced years. This, like the rule of the sexes in suicide, is a rule having no exception at any time or in any country concerning which it is possible to obtain information. But even here the proportions are not absolutely invariable, though the general law holds universally good. From various causes, of which one is the abolition of transportation, another the establishment of reformatories, the criminal age has perceptibly risen in England since the year 1851. So also, although the general law that men are more prone to commit suicide than women is altogether beyond dispute, the proportions of the sexes vary considerably in suicide and in various crimes in different countries, and apparently also at different times in the same country. Hence we may infer that there is hardly any social change of which the human species need absolutely despair, though some changes may be far more easily brought about, and may more reasonably be the subject of legislation, than others. But all legislation should be adapted to the possibilities of the existing generation.

A very curious feature of crimes in the modern sense, though one susceptible of very easy explanation, is the effect upon them of the seasons. Those which are prompted by the animal passions are most common in the summer months; larceny, and offences wholly or partly prompted by want, in the winter months. As might also have been predicted *a priori*, theft increases in times of adversity, and various minor offences, such as drunkenness, in times of prosperity. The metropolitan police returns, indeed, show a very complete descending scale of drunkenness, beginning with a maximum on that day of the week on which wages are paid, and ending with a minimum six days afterwards.

Insanity, in its relation to crime, is a subject which might appropriately be considered in connection with the tendencies inherited by each human being at birth, but cannot be adequately discussed here. Suffice it to say that as youth, when the instincts and passions are at their

strongest, is the period at which the human being is most inclined to commit crimes in general (as now understood), so old age, when both the bodily powers and the intellect are decaying, is the period at which one particular class of sexual offences is most frequently committed; and there is good reason to suppose that persons committing them in earlier years are weak-minded also. Kleptomania and homicidal monomania are asserted by medical theorists to be forms of mental aberration. This doctrine, however, though perhaps sufficiently well-founded, can hardly be established upon the basis of a very wide induction, but only by a subtle reasoning from particular instances upon which it is now impossible to enter.

With regard to the very complex subjects of the prevention and punishment of crime, it may be suggested that the broader the view taken by legislators the more likely is their legislation to be successful. Crime, as defined at any period, may be considered a recognized disease of the body social. But as well might the physician concentrate his whole attention upon each individual pustule of an eruptive fever, one after the other, as the criminal legislator upon actual criminals alone. The symptoms of a malady are of course not to be neglected, and it is necessary to be careful in the treatment of persons who have already fallen into crime. Prison management and every form of punishment are important subjects; but the preservation from guilt of the great majority who are as yet guiltless is of an importance infinitely higher. There is one golden rule taught by history with respect to punishments—let them not afford an evil example of cruelty to the spectators. There is one great preventive of crime, one great antidote to instincts inherited from the past, and that is education. But the education which is effectual is not simply that of the school-room; it is the sum of the external circumstances which can in any way affect the character of any individual in the state. So far, therefore, as legislation has the power of diminishing crime, it can exercise its power by indirect means quite as much as by direct—indeed far more. If the crimes of the English in the 19th century are different both in quantity and in kind from those of the 14th, the difference, we may be quite sure, is not wholly nor even principally caused by changes in the criminal law.

See various passages in the books of Numbers, Deuteronomy, and Joshua, in Homer's *Iliad* (especially book xviii.), in *Cæsar De Bello Gallico*, in the *Germania* of Tacitus, in the *Codex Theodosianus* (especially lib. ix.), in the *Ancient Laws and Institutes of England*, and the *Ancient Laws and Institutes of Wales* (both published by the Record Commission), in the *Ancient Laws and Institutes of Ireland*, *Senchus Mor* (published by commissioners), in *Maine's Ancient Law and Village Communities*, in *M'Lennan's Primitive Marriage*, in *Savigny's Geschichte des römischen Rechts im Mittelalter*, and (so far as natural or inherited tendencies are concerned) in *Darwin's Descent of Man*, and *Herbert Spencer's Principles of Psychology*.

See also the *Rotuli Curie Regis* (published in part by Palgrave), the *Records of the Court of Queen's Bench and of the Star Chamber*, the *State Papers* relating to the Scottish Border, the *Criminal Papers*, and various other Records and State Papers preserved in the Public Record Office in London, the *Records* of the various circuits, the *Statutes* relating to criminal affairs, the *Year Books* and other legal Reports, various collections of *Criminal Trials*, the *Criminal Tables* (England and Wales, 1810-1855), the *Judicial Statistics* of England and Wales, of Scotland, and of Ireland, the *Reports of the Inspectors of Prisons* for England and Wales, for Scotland, and for Ireland, the *Reports of the Directors of Convict Prisons*, the *Compte général de l'administration de la justice criminelle en France* (published annually), the *Statistik der preussischen Schwurgerichte*, *Quetelet's Sur l'Homme*, *Guerry's Statistique morale de la France* and *Statistique morale de l'Angleterre comparée avec la statistique morale de la France*, various papers in the *Journal of the Statistical Society*, and in the *Transactions of the Association for the Promotion of Social Science*, *Becaria's Dei Delitti e delle Pene*, *Bentham's works*, *Livingstone's Systeme de legislation criminelle*, the *Indian Penal Code*, *Taylor's Medical Jurisprudence*, *Chever's Indian Medical Jurisprudence*, *Maudsley's Responsibility in Mental Disease*, and other sources indicated in *Pike's History of Crime in England*. (L. O. P.)

CRIMEA, the ancient Tauric Chersonese, called by the Russians by the Tatar name Krym, or Crim, a peninsula in the Black Sea forming part of the Russian government of Taurida, with the mainland of which it is connected by the Isthmus of Perekop, about six miles wide. It is situated between 44° 22' and 46° 10' N. lat. and 32° 30' and 36°

40' E. long.; is rhomboid in form, the angles being directed to the cardinal points; measures 125 miles from N. to S. and 200 miles from W. to the E. extremity of the peninsula of Kertch, at the east angle of the quadrilateral, and contains an area of between 9000 and 10,000 English square miles. Its coasts are washed by the Black Sea, except to the north-east, where is the Sivash, "Putrid Sea," a shallow lagoon connected with the Sea of Azoff by a very narrow opening, and separated from it by a low sandy tongue of land called the Tonga or Arabat Spit.

#### Physical features.

Three parts of the Crimea are a continuation of the steppe of South Russia, the remainder on the south and south-east coast consisting of hills and mountains of calcareous rocks that have been disturbed by volcanic agency, and exhibit in various parts diorite, melaphyre, apfrite, diabase, amygdaloid, and diorite porphyry. The volcanic eruptions are more manifest near Cape St. George, and at Cape Laspy, Kastropolo, Aloupka, Yalta, and Byouk Lambat, and have formed the eminences at Ayoun-dagh, Kastel, Ouragon, and Kara-dagh, and to the south of Sympheropol and Kara-soubazar. The mountains rise almost abruptly from the sea to an altitude in some parts of fully 4000 feet, the highest, called by the ancients Trapezus, "the Table Mountain," from the flatness of its summit, and now called by the Tatars Tchadyr-dagh, "Tent Mountain," being 4800 feet above the level of the sea. Stalactite and stalagmite caverns are numerous, two of the most remarkable being on the Tchadyr-dagh. Crimmetopon, the "ram's head" of Strabo, was at the south part of the range, and may have been Cape Aia to the east of Balaclava, or the range of cliffs that extends from that promontory to Aitodor. The coast of the mountainous region is exceedingly picturesque, and numerous vineyards have been formed along its sunny slopes; the soil consists of decomposed rock, the chief component part being slate clay. The mud baths on the sea shore at Saky are celebrated for the relief they afford in cases of rheumatism, paralysis, skin diseases, etc.; there is a hospital for naval and military patients, and a private bathing establishment. In the peninsula of Kertch are clusters of mud volcanoes near the town of Kertch and village of Yeny-Kaleh, where the mud, quite cold and black, bubbles actively but silently out of the earth; it is not utilized.

The principal rivers are the Salghyr, its tributary the Kara-sou, the Belbeck, Katcha, Alma, and Boulganack. They all rise on the northern slopes of the mountain range; their beds are almost dry in autumn, but they become rapid and dangerous torrents in spring.

**Climate.** The general climate from the end of March to December is most salubrious and delightful, the heat being moderate and the nights cool and serene; but the summers are irregular, the thermometer sometimes rising to 90° and 100° Fahr. in the shade—the mean annual temperature at Sympheropol being 50°, at Sevastopol 55°, and at Yalta 58°. The weather in the steppe and mountainous parts differs, the former being subject to high winds, hail-storms (sometimes destructive), snow-storms, and frost. In summer long droughts prevail, completely parching up the verdure, which in July and August is quite burnt up. In some winters the mountain tops are covered with snow, which continues on the higher summits until May, yet their temperature is moderate. Ice is rarely seen on the south slopes, and snow seldom falls, the winters throughout being mild, though rains are heavy and winds variable. The greater heats, which last from May to September, are endurable owing to sea and land breezes, the prevalent winds being S.E. and E., when the weather is clear and dry; S. and S.W. winds are invariably accompanied with rain. The autumn, particularly in August and September, is unhealthy on the seashore of the south coast, fever and ague being prevalent but not dangerous; at an altitude, however, of 40 feet or 50 feet is security against attack. Dense fogs occur in March, April, and May, sometimes lasting many hours, but they seldom overspread the land.

**Vegetable products.** In ancient times the Crimea, the Tauric Chersonese, produced a great quantity of corn, which was exported to various parts of Greece; we read that 2,100,000 *medimni* (a *medimnus* = 12 gallons) were sent in one year from Theodosia to Athens by Leucon, king of the Bosphorus (393–353 B. C.). The population is now in some measure supplied with corn from Russia, the drought that has prevailed for many years preventing the district from being a grain-producing country; but where

the land is capable of irrigation it is grown, and there is rich pasturage; much good land, however, remains uncultivated from a dearth of manual labor. The grains sown are wheat, barley, oats, rye, maize, millet, and peas; fax and tobacco are also planted. The vine overspreads the declivities of the south coast, from the valley of the Boulganack to Aloushta, and again at Soudak and Theodosia, 13,500 acres yielding annually about 3,050,000 gallons of wine, sold new at 4s. 10d. to 5s. 6d. the *vedro* (2·36 gallons). A small proportion is exported. Orchards are interspersed with the vineyards, but the best apples are the produce of the valleys of the Alma, Belbeck, Katcha, and Salghyr, the estimated value of the supply sent yearly into Russia being £150,000. The more common indigenous trees and shrubs are the Tauric pine, juniper, yew, oak, beech, which is abundant and attains a large size, elm, wych elm, maple, ash, poplar, and fir; the last grows well on the highlands and on the south slopes, where it reaches a great height; the Babylonian willow and tamarind grow thickly by the side of streams; there is also the hide sumach (*Rhus coriaria*), hawthorn, honey-suckle, barbaris, and the dog-rose, which becomes quite a tree, bearing white, pink, and yellow blossoms. The wild fruit-bearing trees are the mountain ash, *kyzyl*, a small red plum, the apple, pear, and vine; it is said that the wild olive is occasionally to be found. In the gardens of the south coast large numbers of plants have been acclimatized, and trees of all kinds grow to perfection, especially the cypress and magnolia. Wild flowers, such as the white and violet crocus and sweet-scented violet, appear as early as February, lilies of the valley and white and sweet peas being plentiful in May, and in summer the woods are filled with peonies, *Asphodelus luteus*, veronica, geranium, and orchids. In the highlands the vegetation is always vigorous. In July they are covered with *Thymus*, *Sideritis*, *Galium*, *Myrtis*, and *Odontarrhena*, *Gentiana cruciata*, and *Symphyltum tauricum*. In the gardens are cultivated the following fruits:—melons, *karpous*, "water-melon," large, of excellent flavor, and greatly consumed; strawberries, gooseberries, raspberries, and currants; pomegranates, pears, figs, plums, peaches, apricots, cherries, mulberries, quinces, walnuts, almonds, hazelnuts, and chestnuts; also many sorts of vegetables.

**Wolves, foxes, weasels, and hares** are about the steppe and in the mountains, where are also the Persian and roe deer; while the steppe is infested with the soulyk (*Spermophilus*). The forests of Tchadyr-dagh are preserved for the crown, but permission to shoot, from June 29 (July 11), may be obtained. Domesticated animals include double-humped camels, buffaloes, beeves, and several kinds of sheep, one sort being distinguished by short curly hair of a bluish-grey color; the merino sheep was introduced in 1804, and the breed is well maintained. The horses are small, hardy, and intelligent, but uncouth in appearance. The birds consist of eagles, vultures, hawks, ospreys, storks, herons, and some other birds of prey; partridges, which on the steppe are strong on the wing by the end of July; the ordinary, double, and jack snipe, quail, pigeons, bustards, swans, geese, bitterns, and wildfowl of every description, especially on the Sivash and north-west coast; also crows, owls, thrushes, blackbirds, king-fishes, etc. Serpents that are harmless, lizards, and frogs are abundant. The scorpion, mentioned by Pallas, is now very rare, but tarantula spiders and scolopendra, both noxious, frequently make their appearance in dwellings. Caterpillars and the mole cricket (*Gryllo Valpa vulgaris*) are very destructive in gardens. Bees are abundant, and produce excellent honey and a great deal of wax. In the rivers are taken trout, roach, dace, and cray-fish, and at their estuaries the sturgeon is sometimes found, and the salmon is speared. A great variety of fish haunt the coast, such as red and grey mullet, herring, mackerel, turbot, soles (at Eupatoria), plaice, whiting, bream, haddock, pilchard, *soudak* (the pike perch), whitebait, eels, and a variety of shell-fish, crabs, etc., but no lobsters.

The Tatar population, the largest in the peninsula, amounted in 1874 to 127,682, according to the census taken a few months after the promulgation of the *oukas* on the new system of general conscription, in which Tatars were included. There are also Russians, Armenians, Gypsies, Greeks, Jews, and some Germans. The Nogai of the steppe have long since disappeared as natives, and are replaced by Tatars of

Inhabitants.

almost pure Turkish descent, and speaking a language closely assimilating the Turkish. The Tatars on the south coast are a mixed race, largely alloyed with Greek, Italian, and Ottoman blood, and greatly despised by the former; but all are Mahometans, and strict observers of the Koran. The Tatars are extremely indolent, and never think of learning a trade; they busy themselves about their fields and gardens from the end of May to about the third week in August, but remain quite idle throughout the rest of the year. They are most hospitable to strangers, every Tatar of means keeping an *ôda*, or house of call for travellers, the first duty of a Tatar being the exercise of hospitality, on which he prides himself. Their cottages are constructed, when possible, on the slopes of rising ground, the rock forming the back of the habitation, which is usually white-washed and kept scrupulously clean, ensconced by fruit trees and verdure. The Tatars are very abstemious, drinking milk and *boussa*, a fermented liquor made of millet; *tsoungas*, "mare's milk," is much employed by them medicinally. The men wear baggy trowsers, a short embroidered jacket, and a cap of lamb skin; the women color their nails, eyebrows, and frequently their hair, made up into numerous thin plaits, with *tsaa*, a mineral dye, and wear loose trowsers tightened at the ankles, a loose coat, and a red cap ornamented with numerous coins; they tie a kerchief round the waist, the opposite corners hanging down behind. The females, more especially on the south coast, have quite given up wearing the *yashmak*, "veil," since the occupation of the country by the Allies in 1854-56. The *monsias*, "nobles," live in retirement, shunning intercourse with Christians, but their women are not kept in seclusion; every village has its *solla*, who is also the "elder," and responsible to the authorities. The Armenians and Greeks hold the trade, as do also the Jews who are Karaims, "readers" of the Holy Scriptures, adhering strictly to the text of the Old Testament, and rejecting all oral traditions and rabbinical writings, keeping themselves quite apart from the Talmudists, to whom they are most odious. There are about 5000 Karaims in the peninsula. Russians and Germans are chiefly engaged in agriculture, while the gypsies are the artificers. The Russian language is very general throughout the peninsula.

**Towns.** Sympheropol, the chief town and seat of government (population, 17,000), is situated on the Salghyr, where was Ak-mesjid, the second capital of the khanate. Like all Russian towns, it has fine broad streets at right angles to each other, and the usual whitewashed churches with green domes. Baghtchasarai and Kara-soubazar were given up by Catharine II. to the exclusive occupation of the Tatars, and have remained purely Oriental towns. Baghtchasarai, "garden palace," was the capital of the khans after the destruction of Solkhat, now Esky-Crim; heir palace is preserved to this day. Kertch, at the east end of the peninsula, is a fairly thriving port of transit for produce from ports in the Sea of Azoff, and imports into Russia of cattle and horses from the plains of the Kouban and of Circassia. It is a military station of some importance, the entrance to the straits of Kertch, or Yeny-Kaleh, the ancient Cimmerian Bosphorus, being protected by the formidable Pavlovsky fortress, a combination of masked batteries and covered ways over an extent of two miles. Theodosia, formerly Caffa, where a small export and import trade is carried on, thrives as a favorite watering-place. Sevastopol, in the superb harbor that bears its name, created a military port and fortress by Catherine II., was bombarded and occupied by the Allies in September, 1855. Eupatoria, formerly Khezlevé and Kozloff, is the great emporium for salt, and during Turkish occupation was the principal port in the Crimea; its inhabitants are chiefly Karaims, who have here a "spiritual institution" under their *Gakans*. Balaclava, the *Symvolon limen* of Strabo, *Cembalo* of the Genoese, is a small Greek fishing-village in a splendid land-locked harbor to the east of Sevastopol, remarkable as being occupied by the British during the war. Yalta is a small but fashionable watering-place on the south coast, with excellent hotels and many inducements to visitors, the season lasting from May to September. Near Yalta is Livadia, the residence of the empress, and other imperial properties.

**Commerce.** The most valuable commercial production is salt, of which the yearly supply is 15,000,000 *pounds* (a pound—36 lb English). Salt entering Russia is excised at 30 copecks (9d.) per pound, and the entire revenue

to the Government from the salt-lakes in the Crimea is estimated at £1,785,714. There are no manufactures, but the principal articles of export are wine, *bû* (i. e., fuller's earth), honey, wax, hides, lambkins, and wool. A reddish marble from quarries near Tchadyr-dagh is exported in small quantities. Communications in the peninsula are maintained by excellent post-roads and bridle-paths, and a railroad which connects Sevastopol, Baghtchasarai, and Sympheropol with the south of Russia was opened for traffic in January, 1875.

The earliest known inhabitants of the Crimea History. were the Cimmerians, who were driven out by the Scythians about 680-631 B. C., and fled into Asia Minor, leaving only a remnant, who took refuge in the mountains, and were afterwards known as the Tauri. These appear to have been a savage people, from the fact that all strangers that landed or were cast on their coast were sacrificed to the virgin goddess Iphigenia, afterwards apparently identified with a goddess of their own mythology by the Grecians, who named the country the Tauric peninsula after their predecessors, whence the Russian name Taurida. The numerous crypts existing about the rocky heights were in all probability the troglodyte caves of the Tauri; in some parts they were converted into hermitages and retreats by the Greeks during Byzantine occupation, and were again so utilized by their successors in the last century; these caves are to be seen at Ak-Kaya, Tepe-Kerman, Katch-Kalen, Tcherkess-Kerman, Mangoup, Mangoush, Tchyfou-Kalen, Inkerman, etc.

In the year 668 B. C. the Heracleotes crossed the Axine, as the Black Sea was then called, and founded a colony near where is now Sevastopol, the territory they occupied becoming known as the Heracleotic Chersonese, to distinguish it from the Tauric Chersonese. The city of Chersonesus flourished under its own free institutions during the space of 1000 years, and even longer, though it became a dependency of the Eastern empire; it was taken in 988 by the Russian grand-prince Vladimir, who there received baptism, and was completely destroyed in 1363 by Olgerd, grand-prince of Lithuania. In the 7th century B. C. other Grecians, the Milesians, settled at Theodosia, and later at Nymphæum and Panticapeum (Kertch), which last city became their metropolis under the authority of an archon, and afterwards of a king, whose dominion, the kingdom of the Bosphorus, included Phanagoria on the eastern shore of the Cimmerian Bosphorus, a city founded with others at the same time as Panticapeum, and the emporium of the people on the Asiatic shores of the strait. Parisades, sovereign in 115 B. C., being hard pressed by the Scythians, voluntarily ceded his dominion to Mithridates, king of the Pontus, whose son Pharnaces, after his own downfall, was permitted by Rome to assume the sovereignty of the Bosphorus, a sovereignty that continued until a late period under the protection of the Roman empire. The peninsula was overrun successively by the Alans (62 A. D.), the Goths, whose descendants, peaceably employed in agriculture, remained until the early part of the 14th century, the Huns in 376, the Khosars in the 8th century, expelled by the Byzantines in 1016, and the Kiptchaks, who possessed themselves, about 1050, of Khazary, by which name the peninsula was called, after the Khosars, they being in their turn expelled by the Mongols about 1237. Panticapeum, or Cerchio (Kertch), was for a time (1343) occupied by the Venetians, their successors being the Genoese, who had established themselves at Caffa (Theodosia) in 1263-67, and to whom the seaboard known as Gothia, extending to Cembalo (Balaclava), was ceded in 1315. Cembalo, Soldaia (Soudak), and Caffa were strongly fortified by them, Caffa being the centre of an extensive Asiatic trade that included Persia, India, and China. The ruins of the Genoese fortifications still remain.

After the destruction of the Golden Horde by Tamerlane, the Tatars of the Crimea elected, about 1423, a khan for themselves, a descendant through Toktamish of Jinghis Khan, one Hadgy, who assumed the name of Ghyrey, his capital being at Solkhat, now Esky-Crim. This khanate continued independent until the conquest of Krim by Mahomet II. (1475), who made the khan prisoner, and sent the Genoese and other Christians into servitude and slavery. The khans, thenceforth the vassals of the sultans, were at the head of a warlike race, by whom the Russian provinces were being continually devastated until

the year 1777, when Suwaroff dispersed the troops of Dvylett Ghyrey, who fled to the Caucasus, and the usurper Selim Ghyrey ascended the throne under the protection of Catherine II. He was, however, forced to appeal to Russia for succor against revolt amongst his own subjects, and the Crimea was eventually annexed to the Russian empire by order of the empress, August 1, 1783, the treaty for cession by the Porte being signed January 9, 1784.

The Crimea was occupied by the allied forces of Great Britain, France, and Sardinia during the Russo-Turkish war of 1853-56. The British and French troops landed near Eupatoria September 14, 1854, and did not evacuate the peninsula until July 12, 1856, during which period were fought the battles of the Alma, Tchornaya, Balaclava, and Inkerman, and the formidable fortress of Sevastopol was reduced by siege.

See Dubois de Montpéroux, *Voyage autour du Caucase, etc.*, 6 vols., Paris, 1839; Kohl, *Reisen in Sudrusland*, 2 vols., Dresden, 1841; Bossoli, *Scenery of the Crimea* (52 large drawings), 1855; Ph. Brunn, *Notices Hist. et Top. concernant les colonies Italiennes Gasarie*, St. Petersburg, 1866; Commr. J. Buchan Telfer, R. N., *The Crimea and Transcaucasia*, 2 vols. London, 1876.

(J. B. TR.)

**CRIMINAL LAW.** A crime is an offence which the law punishes directly, as distinguished from an offence which it punishes indirectly by giving an action for damages to the person injured. The criminal or penal law is that portion of the law which deals with crimes. Sometimes it is attempted to distinguish crimes from civil injuries by saying that the former are offences against the state, the latter offences against individuals, or again, by saying that the former are prosecuted by the state, the latter by private persons. But all illegal acts are offences against the state, and in England the state is not, nominally at least, the prosecutor of criminal offences. Civil injuries, or torts, as they are called in the law of England, are offences for which the injured person may sue in a court of justice. Torts and crimes do not therefore necessarily exclude each other, for the same act may be both a tort and a crime in the sense that the injured person may sue for damages, and the offender may likewise be prosecuted and punished. Further, it should be observed that many offences which are crimes in the sense of being directly punishable, are, so far as the morality of the act is concerned, far removed from the class of crimes. To allow your chimney to go on fire is a crime in the sense that it is punishable by fine, but it is not a crime in the sense of the preceding article, or in the ordinary acceptation of the term.

The law of England on the subject of crimes is, like the rest of the law, composed of a large number of enactments, resting on a basis of common law. Its leading definitions and distinctions are derived from the common law, modified by judicial interpretation and by statute. A few of the general principles of the criminal law of England will be stated here; for information as to the law relating to specific crimes reference should be made to the respective heads.

The absence of systematic arrangement and of any precise definition of crimes is due to the historical character of the criminal law. "It is founded," says a high authority, "on a set of loose definitions and descriptions of crimes, the most important of which are as old as Bracton. Upon this foundation there was built, principally in the course of the 18th century, an entire and irregular superstructure of Acts of Parliament, the enactments of which were for the most part intended to supply the deficiencies of the original system. These Acts have been re-enacted twice over in the present generation—once between 1826 and 1832 and once in 1861; besides which they were all amended in 1837. Finally, every part of the whole system has been made the subject of judicial comments and constructions occasioned by particular cases, the great mass of which have arisen within the last fifty years" (*View of the Criminal Law of England*, by J. Fitzjames Stephen).

A crime being defined as an action specifically forbidden under penalty of direct punishment, it may be stated, without entering into a minute analysis, that to render a person liable to punishment he must have a guilty intention, or, as it is called in English law, malice. This malice will be inferred from the fact that the forbidden action has been done; a man will be presumed to have intended the nat-

ural consequences of his own acts. The inference, however, may be rebutted by evidence showing that the criminal intention required to constitute a crime was not as a matter of fact present. And there are certain conditions from which the law will infer the impossibility of any such intention. A child under seven is held to be incapable of committing a crime. If a married woman commits an alleged crime in presence of her husband, she will be held to have acted under his compulsion. The state of mind described as insanity, also excludes the possibility of criminal intention.

Crimes are divided into treasons, felonies, and misdemeanors. The first class includes offences against the state, e. g., violence to the person of the king, or resistance to the authority of the sovereign power. The distinction between felonies and misdemeanors is not so easily drawn, and is founded if anything on the nature of the punishment and not of the crime in such case. In the definitions of crime in Bracton, misdemeanors appear as a less serious class of crimes, after the graver crimes of treason, crimen falsi, homicide, mayhem, arson, rape, and theft have been described. They are "minor or lighter crimes, prosecuted civilly as in personal actions for injuries." They are regarded as of the nature of wrongs done to the sovereign power. In a trial for felony the jury are required to make true deliverance between the queen and the prisoner at the bar. In a trial for misdemeanor they are to try the issue joined between the queen and the defendant. The principal common law misdemeanors—libel, conspiracy, and nuisance—have an obviously direct reference to the public peace, and may without much violence be regarded as grievances to the sovereign power itself. In Russell *On Crimes*, a misdemeanor is said to be the name generally applied to offences for which the law has not provided a particular name. But so many crimes have been created misdemeanors by statute which do not differ in character from felonies, that no distinction founded on the nature of the crime can be drawn between them. Nor can they be distinguished by the greater or less severity of the punishment, for some misdemeanors are punished more severely than felonies. Besides, however, the differences in the mode of trial noted above, felonies differed from misdemeanors inasmuch as they involved a forfeiture of property—a distinction which no longer exists, since forfeiture for felony was abolished by 33 and 34 Vict. c. 23. And in general there are greater facilities for arresting the criminal in case of felony than in misdemeanors.<sup>1</sup> It is unfortunate that a distinction so fundamental should be so utterly vague. All the crimes known to the law may be divided into felonies and misdemeanors, for treason is after all a case of felony, but it is impossible to say what felony is or what a misdemeanor is without an enumeration of the specific crimes which are ranked under each head. The Consolidation Acts form a classification of crimes which is more easily understood, although it does not cover the whole of the criminal law. Thus the Acts of 1861 (24 and 25 Vict. cc. 96, 97, 98, 99, and 100) relate respectively to larceny, malicious injuries to real property, forgery, coinage, and offences against the person.

The definitions of particular crimes are still to be sought in the common law and the decisions of the judges. The Consolidation Acts for the most part leave them as they stood, e. g., the Larceny Act does not define the crime of larceny. The consequence is that exact definitions are very difficult to frame, and the technical view of a crime sometimes includes more, sometimes less, than it ought. Thus the crime of murder, as settled by the existing law, would include offences of such very different moral gravity as killing a man deliberately for the sake of robbing him, and killing a man accidentally in an attempt to rob him. On the other hand, offences which ought to have been criminal were constantly set aside by the judges as not being within their definition of the particular crimes alleged, and the legislature has constantly had to interfere. In this way the penalties of larceny were gradually extended to embezzlement, frauds by trustees, etc.

Attempts to commit crimes are themselves crimes. It is laid down in Russell *On Crimes* (vol. i. p. 189) that "as

<sup>1</sup> Any one who has obtained a drove of oxen or a flock of sheep by false pretences may go quietly on his way and no one, not even a peace officer, can apprehend him without a warrant, but if a man offers to sell another a bit of dead fence supposed to have been stolen, he not only may but is required to be apprehended by that person (Greaves, *Criminal Law Consolidation Acts*).

attempt to commit a felony is a misdemeanor, and an attempt to commit a misdemeanor is a misdemeanor, whether the offence be so by common law or by statute." An attempt to murder was at common law no more than a misdemeanor punishable by two years' imprisonment. This was the case until 1861; but now by the 24 and 25 Vic. c. 100 (Offences against the Person Act), any person attempting by the means specified therein, or by any other means, to commit murder, is guilty of felony and punishable by penal servitude for life or for any term not less than three years, etc., or to be imprisoned for not less than two years with or without hard labor or solitary confinement.

Persons accused of a crime may be either principals or accessories, and these are further distinguished into principals of the first and second degree, and accessories before and after the fact. Principals in the first degree are those who *have actually and with their own hands committed the fact*. Principals in the second degree are those who were present *aiding and abetting* at the commission. An accessory before the fact is one who, being absent at the time of the offence committed, doth yet procure, counsel, command, or abet another to commit a felony. And an accessory after the fact is one who, knowing a felony to have been committed by another, receives, relieves, comforts, or assists the felon. Participation in the commission of a felonious act in any of these ways is a felony (*Russell On Crimes*, vol. i. p. 156). By the Accessories and Abettors Act (24 and 25 Vic. c. 94) accessories before the fact may be tried and punished as principals, and accessories after the fact may be indicted as such or as substantive felons.

Criminal procedure in England is distinguished by several special features, the most remarkable of which is its close similarity to procedure in ordinary civil cases. Crimes are left, like civil injuries or breaches of contract, to be prosecuted by the persons injured, and the nature of the trial, the character of the tribunal, and the rules of evidence are the same as in an ordinary litigation at common law. Mr. J. F. Stephen, in the excellent treatise already quoted, aptly distinguishes the English system as "litigious" from the "inquisitorial" system prevailing in France and other countries.

Preliminary jurisdiction in criminal cases is possessed by the justices of the peace, who may also under special Acts convict in a summary manner for offences of minor importance. When the justices are satisfied that there is a *prima facie* case they commit the prisoner for trial either at the quarter sessions or at the assizes. (See COURTS.) The following cases are not liable at quarter sessions:—Misprision of treason; offences against the queen's person, prerogative, etc., or against Parliament; offences subject to the penalties of *præmunire*; blasphemy; unlawful oaths (administering or taking); perjury and false affirmation; setting fire to crops of grain, wood, heath, etc.; bigamy; abduction; concealment of birth; bankruptcy offences; blasphemous libels; bribery; conspiracies for offences not triable at sessions; stealing records or documents, etc. A trial at quarter sessions or assizes begins by the presentation of an indictment to the grand jury, who are selected for the occasion, to the number of from twelve to twenty-three, from the gentlemen of standing within the district for which the court is sitting. The judge delivers a charge to the grand jury, shortly pointing out the nature of their duties, and directing their attention to any peculiarities in the cases that are to come before them. The grand jury discuss each case *seriatim*, and hear witnesses in private (in general only those for the prosecution), and if they are satisfied that there is a *prima facie* case against the prisoner they return a true bill, and the case goes to trial before the judge and a common jury. If the grand jury do not return a true bill, the case is at an end, unless there has been a verdict on a coroner's inquisition, or unless it is a case which may be proceeded on by way of information. A criminal trial in open court now differs in very few points from any ordinary civil cause. For a long time prisoners were not allowed to have the benefit of professional advocacy except in cases of high treason, and the privilege was not conceded until the Prisoners' Counsel Act of 1836. Sir J. Stephen fixes at the same date the entire exemption of prisoners from interrogation,—a practice which would appear to be connected, in legal reason, with the rule which made a party to a cause an incompetent witness. In this respect the contrast between a criminal trial in England and a criminal trial in France is

very striking. The constant interrogation and browbeating of the prisoner by the judge, consistent as it may be with the inquisitorial theory of their procedure, is always revolting to Englishmen, accustomed to see in every criminal trial a fair fight between the prisoner and the prosecution. Confessions, which are the object of many proceedings in a French inquisition, are regarded with suspicion by the English law. During the spring assizes of 1877 a prisoner was charged with having committed a murder twenty years ago, and the counsel for the prosecution, with the consent of the judge, withdrew from the case because the only evidence, besides the prisoner's own confession, was that of persons who had either never known him personally or could not identify him.<sup>1</sup> Although a prisoner may have counsel to defend him if he can afford to pay the customary fee, no provision is made by law for his being so represented. But the custom of the courts has imposed upon judges exceptional care for the prisoner's interests, and on the prosecuting counsel exceptional forbearance when the prisoner is undefended. It was often said before the Prisoners' Counsel Act (and it is still true) that the judge is the prisoner's counsel. In exceptional circumstances the judge will call on some member of the bar to undertake the prisoner's defence.

As there is no provision made by law for the prisoner's defence, so there is no public prosecutor. The absence of such an officer has long been an admitted defect in the English system, but no successful attempt has yet been made to deal with it. It is generally agreed that an official staff of prosecuting counsel would not be desirable. But there certainly ought to be some public officer charged with the preparation, if not of all criminal cases, at least of those which the injured person does not wish to conduct himself. At present a private person is bound over by the magistrates to prosecute at his own expense, and the consequence often is that many persons will forego an injury rather than submit to the trouble and risk of a prosecution. The prosecutor can recover his costs from the county, unless they are disallowed by the judge. The county again is entitled to be recouped by the Treasury, and between these two bodies there has been a standing feud on the subject of criminal costs for some years.

Properly speaking there is no appeal in criminal trials. The verdict of the jury is final. Any substantial defect or informality in the procedure may be taken before the Queen's Bench by writ of error, but such cases are not now of frequent occurrence. And if any question of law arises at the trial, the judge may reserve it for the opinion of the court for the consideration of crown cases reserved, by whom the conviction may be either quashed or confirmed.

Punishments under the common law were excessively severe, but their operation was mitigated by the singular privilege of *BENEFIT OF CLERGY* (*q.v.*) Blackstone laments that "among the variety of actions which men are daily liable to commit, no less than 160 have been declared by Act of Parliament to be felonies without benefit of clergy, or, in other words, to be worthy of instant death." The more atrocious punishments have disappeared from the law, and the penalty of death is now practically restricted to murder. Fine, imprisonment with or without hard labor and with or without solitary confinement, and penal servitude,<sup>2</sup> are the most usual punishments, and a wide discretion is left to the judges.

By the Penal Servitude Act, 1864, the shortest period of penal servitude for an offence committed after the passing of the Act is five years, and where any previous Act had fixed a maximum of less than five years, the period of five years is to be substituted for such shorter term. The same Act gives the form of license under which a convict may be allowed to be at large during the remaining portion of his time, subject to the condition of abstaining from crime and from association with criminal characters, etc., and of preserving and producing his license when called upon by a magistrate or officer. By the Prevention of Crimes Act, 1871, every holder of a license under the Penal Servitude

<sup>1</sup> "No confession made by the prisoner is admissible which is made in consequence of any inducement of a temporal nature, having reference to the charge against the prisoner, held out by a person in authority" (*Roscoe's Digest of Criminal Evidence*). Notwithstanding the general bearing of the law against confessions, it is held that a confession obtained by artifice or by spiritual solicitation may be used in evidence.

<sup>2</sup> By 16 and 17 Vic. c. 99, all sentences of transportation were converted into penal servitude.

Acts must notify his residence and any change of residence to the police (section 6). The Prevention of Crimes Act, 1871, likewise repeals the Habitual Criminals Act of 1869, and substitutes new provisions, of which the following are the most important. Section 5 provides for the registering and photographing of criminals.<sup>1</sup> Section 7 specifies circumstances under which a person who has been twice convicted on indictment may, within seven years of the expiration of the last of the two sentences, subject himself to imprisonment with or without hard labor for a term not exceeding one year,—*a. g.*, if it appears to a magistrate that "there are reasonable grounds for believing that he is getting his livelihood by dishonest means;" or if he refuses to give his name and address when charged with an offence before the magistrates; or if he is found in any place public or private under circumstances which satisfy the court that he was about to commit, or waiting for an opportunity to commit, an offence; or if he is found in a dwelling-house, etc., without being able to give a satisfactory account of his presence. By section 8, "where any person is convicted on indictment of a crime, and a previous conviction of a crime is proved against him, the court having cognizance of such indictment may, in addition to any other punishment which it may award to him, direct that he is to be subject to the supervision of the police for a period of seven years, or such less period as the court may direct, commencing immediately on the expiration of the sentence passed on him for the last of such crimes." Persons subject to police supervision, like convicts out on ticket-of-leave, must notify their residence to the police, and males must report themselves once a month. The Larceny Act of 1861 had made a previous conviction for felony or indictable misdemeanor, or two summary convictions, matter of aggravation on a charge of simple larceny; and section 116 of that Act provides for the trial of the question whether there has been such a previous conviction. It is only after the prisoner has been found guilty of the subsequent offence that the question whether he has been previously convicted can be gone into, unless he offers evidence of good character in the trial for the offence, in which case the prosecutor may prove the previous conviction. This section is adopted in the Prevention of Crimes Act, 1871.

The prerogative of pardon, as exercised by the Home Secretary, occasionally has the effect of a rehearing of the case, *e. g.*, when new evidence is discovered after the trial, or the verdict of the jury gives dissatisfaction to the public. In such cases the Home Secretary, after consultation with the judge, or if necessary with such skilled persons as he may select, decides on his own responsibility to grant or withhold a pardon.<sup>2</sup> This is not perhaps the most satisfactory way of reviewing the sentence of a criminal court.

The distinguishing feature of Scotch criminal law is the existence of a public prosecutor. At common law persons injured have the right to prosecute, but "private prosecution, except in the most trifling summary complaints, is now wholly unknown in practice" (Macdonald's *Criminal Law of Scotland*). The lord advocate and his deputies are the public prosecutors in the Supreme Court; in the inferior courts the procurator-fiscal prosecutes. The public prosecutor cannot be compelled to prosecute, nor can he be prevented from prosecuting. (E. R.)

CRIMMITZSCHAU, or KRIMMITZSCHAU, a manufacturing town of Saxony, in the circle of Zwickau, and seven miles N.N.W. of the town of that name, on both banks of the Pleisse, and on the Saxon Western State Railway, 760 feet above the sea. Brewing was formerly the most

important industry, but woollen weaving and cotton weaving have now taken the chief place; the manufacture of machinery has also become very considerable. Lime-burning is carried on in the neighborhood, and the surrounding district is noted for its wheat growing. Population (1875), 17,649.

CRISPIN AND CRISPINIAN, two saints whose festival, as marked in the calendar, is on the 25th of October. According to the tradition they were brothers, born at Rome, whence they travelled in company with St. Denis to Soissons, in France, towards the close of the 3d century, to propagate the Christian religion; and that they might not be chargeable to others for their maintenance, they exercised at night the trade of shoemakers, while preaching during the day. The shoes they made were sold at a low price to the poor, an angel miraculously furnishing the leather. According to another version of the story, the saints stole the leather so as to enable them to benefit the poor. When it was known that they were Christians, the governor of the town, after subjecting them to cruel tortures, ordered them to be beheaded. The date of their martyrdom is usually given as 287, though the Roman legend gives 300. They are regarded as the tutelary saints of shoemakers.

CRISSA, or CRISA, in ancient geography, one of the oldest cities of Greece, was situated in Phocia, at the foot of one of the spurs of Mount Parnassus. Its name occurs both in the *Iliad* and in the Homeric *Hymns*, where it is described as a powerful place, with a rich and fertile territory, reaching to the sea, and including within its limits the sanctuary of Pytho. As the town of Delphi grew up around the shrine, and the seaport of Cirrha arose on the Crissean Gulf, Crissa gradually lost much of its importance. By the ancients themselves the name of Cirrha was so often substituted for that of Crissa, that it soon became doubtful whether these names indicated the same city or two different cities. The question was practically settled by the investigations of Ulrichs, who unravelled with much care the history of the towns. From its position Cirrha commanded the approach to Delphi, and its inhabitants became obnoxious to the Greeks from the heavy tolls which they exacted from the devotees who thronged to the shrine. The Amphictyonic Council declared war against the Cirrheans in 595 B. C., and having taken the town, razed it to the ground, and consecrated its territory to the temple at Delphi. The plunder of the town was sold to defray the expenses of the Pythian games. In 339 the people of Amphissa began to rebuild the city, and to cultivate the plain. This act brought on the second Sacred War, the conduct of which was intrusted by the Amphictyons to Philip of Macedon, who took Amphissa in the following year. Cirrha was afterwards rebuilt, but never regained its former importance. Crissa is probably represented by the modern Chryso, and the ruins of Cirrha, including extensive remains of its port, are to be seen in the neighborhood of the Pleistus.

CRITIAS, an Athenian orator and poet, and one of the thirty tyrants. In his youth he habitually listened to the conversations of Socrates, but his manhood was devoted to selfish political intrigues. He stirred up the Penestæ of Thessaly against their masters, and made himself so troublesome at home that he was banished by the people. Returning to Athens, he was made ephor by the oligarchical party; and he was the most cruel and unscrupulous of the thirty tyrants who in 404 B. C. were appointed by the Lacedæmonians. See GREECE.

CRIVELLI, CARLO CAVALIERE, a Venetian painter, was born in the earlier part of the 15th century. The only dates that can with certainty be given are 1468 and 1493; these are respectively the earliest and the latest years signed on his pictures—the former on an altar-piece in the church of San Silvestro at Massa near Fermo, and the latter on a picture in the Oggioni collection in Milan. Though born in Venice, Crivelli seems to have worked chiefly in the March of Ancona, and especially in and near Ascoli; there are only two pictures of his proper to a Venetian building, both of these being in the church of San Sebastian. He is said to have studied under Jacobello del Fiore, who was painting as late as any date as 1436; at that time Crivelli was probably only a boy. The latter always signed as "Carolus Crivellus Venetus;" from 1490 he added "Miles," having then been knighted by Ferdinand II. of Naples. He painted in tempora only, and is

<sup>1</sup> A register of Habitual Criminals in England and Wales for the years 1869-76 has recently been printed in the printing works of Her Majesty's prison, Brixton. "The list," says the *Times* of March 7, 1877, "has been framed by separating from the great mass of returns those which refer to persons who have been convicted on indictment of a crime, and thereupon have had a previous conviction proved against them. It is thus a complete register of habitual and professional criminals, and has been printed for circulation among the police and the authorities of prisons, in order to enable them to identify persons who come under their charge." The proportion of habitual criminals born in different localities gives some curious results. Thus the town of Stafford heads the list with 1881 to every 1000, followed closely by Worcester, Taunton, and Lancaster, all of them towns with under 20,000 inhabitants. On the other hand, London, which produces the largest number (1608), stands at the rate of only 461 to the 1000. Of the habitual criminals on the list, 1062 come from Ireland, and 158 from Scotland.

<sup>2</sup> A good example will be found in the case of Smethurst, reported at length in Stephen's *View of the Criminal Law*.

seen to most advantage in subject-pictures of moderate size. He introduced agreeable landscape backgrounds; and was particularly partial to giving fruits and flowers (the peach is one of his favorite fruits) as accessories, often in pendent festoons. The National Gallery in London is well supplied with examples of Crivelli; the Annunciation, and the Beato Ferretti (of the same family as Pope Pius IX.) in religious ecstasy, may be specified. Another of his principal pictures is in San Francesco di Matelica; in the Vatican Gallery is a Dead Christ, and in the Brera of Milan the painter's own portrait. Crivelli is a painter of marked individuality,—hard in form, crudely definite in contour; stern, forced, energetic, almost grotesque and repellent, in feature and expression; simply vigorous in his effect of detachment and relief, and sometimes admitting into his pictures objects actually raised in surface; distinct and warm in color, with an effect at once harsh and harmonious. His pictures gain by being seen in half-light, and at some little distance; under favoring conditions, they grip the spectator with uncommon power. Few artists seem to have worked with more uniformity of purpose, or more forthright command of his materials, so far as they go. It is surmised that Carlo was of the same family as the painters Donato Crivelli (who was working in 1459, and was also a scholar of Jacobello) and Vittorio Crivelli. Pietro Alamanni was his pupil.

**CROATIA AND SLAVONIA**, a crown-land of the Hungarian kingdom, which extends from 14° 25' to 20° 25' E. long., and is bounded on the N. W. by Carniola and Styria, N. by Hungary, S. by Servia, Bosnia, and Dalmatia, and W. by Dalmatia and the Adriatic, on which it has a coast-line of about 88 miles. Inclusive of the districts belonging to the Military Frontier, it has a total area of about 16,785 English square miles; and according to the census of 1869 its total population amounted to 1,864,021, of whom 695,997 are assigned to the military portion.

**Mountains.**—The whole country may be divided into two great natural sections, of which the more important belongs to the basin of the Danube, and is mainly defined by that river and its two extensive tributaries, the Drave and the Save, while the other consists of the highlands of the Adriatic coast. The mountains are partly outrunners of the Alpine system, and partly prolongations of the Karst; but the line of demarcation has not as yet been clearly defined. The former, known chiefly as the Warasdin Mountains, stretch eastward with gradually diminishing elevation through more than half the length of the country to the neighborhood of Diakovar, and attain their greatest height of 3483 feet in Mount Ivanica. The latter consist of three more or less distinct chains running north-west and south-east:—the Velebit or Velebitch, with a mean height of 3318 feet, which gives its steep and barren character to the southern part of the coast; the Kapela, with a mean height of 2488 feet, lying further inland, and connecting itself with the mountains of Carniola; and the Plisevica, with a mean height of 3214 feet, which forms the boundary between Bosnia and Croatia. The mean height of the whole of the plateau to which these ranges belong is estimated at 2074 feet. Many parts of the mountain-regions are richly wooded with pine, beech, and chestnut, and many of the smaller valleys and glens are abundantly fertile. The richest part of Croatia, indeed, is not the valley of the Drave or the Save, but the hilly district between the Kostel, the Ivanica, and the Agram Mountains, called by the natives Zagorje, or the Land behind the Hills. A small group known as the Vrdnik Mountains rises in the east of Slavonia.

**Rivers, etc.**—From the point where it begins to form the Croatian boundary, to its junction with the Danube below Esseg, the Drave receives only one important tributary, the Bednya; but the Save is the recipient of a large number of considerable affluents:—the Sotla, the Krapina, the Zelina, the Lonya, the Ilova, the Pakra, and the Olyava from the Warasdin Mountains; and the Kulpa, the Korana, and the Unna from the Karst. The Becina falls into the sea; the Gaska loses itself in swampy hollows; and the Lika plunges into a rocky abyss not far from Gospich. Extensive marshes occur along the main rivers in Slavonia; and there is an interesting cluster of seven lakes—called the Lakes of Plitvica—in connection with the Korana. Warm mineral springs rise at Krapina, at Toplice near Warasdin, at Stubica near Agram, at Daruvar, and at Topusko near Glina; and there is a sulphurous spring at Lipik near Pakrac.

**Climate.**—The climate of the lowlands is equable and temperate; but the Karst district is exposed to very violent and sudden changes. The mean temperature throughout the year for Agram is 52° Fahr., and throughout the hottest month 72°. At Fiume it is very much warmer. The rain comes mainly with the south-west wind, and the annual fall varies from 23 inches in the lowlands to 51 in the Karst. The coast districts are exposed to the violent wind called the Bora, which, while it lasts, is strong enough to render all locomotion impossible.

**Agriculture.**—About 16 per cent. of the whole country is unproductive, and in the eastern districts a considerable proportion of the rest is assigned to pasture. The chief crops are wheat, oats, rye, potatoes, flax, and hemp; tobacco is also grown; and a good deal of attention is bestowed on the vine, though the national beverage is prepared from the damson plum. Horses are raised in Slavonia; the oak and beech woods furnish food to great herds of swine; and the heath districts give excellent opportunity for the keeping of bees.

**Manufactures and Commerce.**—With the exception of a few establishments for silk-spinning, two or three glass-works, and the distilleries which are scattered throughout the country, the only manufactories are at the seaport towns of Fiume, Buccari, and Porto Re. Iron-ore is worked at Rude, Buyevac, and Brod, sulphur at Radoboy, and coal at Pregrada; but none of the mines are of great importance. The traffic of the country is furthered not only by its 580 miles of navigable rivers, but by upwards of 2000 miles of regular road and several lines of railway meeting at Agram. Among the roads the most famous are the Maria Louisa, which connects Carlstadt with Fiume, and the Josephina, which passes inland from Zengg.

**Divisions.**—The territory of Croatia and Slavonia is divided into eight comitats named after their respective administrative centres.—Agram, Fiume, Kreutz, Warasdin, Bellovar, Esseg, Pozsega, and Bukovar. The city of Agram or Zagrab is the capital of the crown-land, and is rapidly rising in importance. Of the other towns it is sufficient to mention, in Croatia, Siseck, with its grain-trade, Carlstadt, the seat of a Greek Church bishop, Kopreinitz, Buccari, with its free port, St. Georgen, and Zengg; and in Slavonia, Diakovar, the seat of the famous bishop Strossmayer, and Semlin, one of the most valuable military and commercial ports on the Danube. Sluin, Glina, and Petrinja were respectively the centres of the 1st, 2d, and 3d banal regiments; and Brod, Gradiska, Likka, Ogulin, Ottocsan, and Peterwardein give their names to the other military districts.

**Government.**—The united kingdom of Croatia and Slavonia is represented by a separate minister, without a portfolio, and in the Hungarian diet by thirty-four members on the table of deputies, and two envoys from the national diet on the table of magnates. The national diet is composed of the Roman Catholic bishop, the Greek Catholic bishop, the prior of Aurana, the magnates, counts, and barons, and seventy-seven deputies of towns, districts, etc. The kingdom is autonomous in domestic affairs, public worship, education, and justice; and by the law of November, 1874, the administrative and the judicial departments are to be kept completely distinct. At the head of the Government is the Ban or Banus, who also ranks as a privy councillor. The highest court is the so-called septemviral table at Agram; and next in order is the banal table. According to a law of 1873, 55 per cent. of the taxes of the kingdom fall to the Hungarian treasury, and the remainder is assigned to domestic expenses.

The Croats proper form about 74 per cent. of the total population, Serbs about 23 per cent., and the small remaining portion is composed of Germans, Magyars, Jews, Italians, and Albanians. The Croats are Catholics, and employ the Latin alphabet for their Slavonic language, which is closely connected with the Serbian, and breaks up into two main dialects—the Sloveno-Croatian and the Serbo-Croatian. The Serbs are members of the Greek Church, and employ the Cyrillic alphabet.

The principal educational institution in the country is the university established in 1874 at Agram, where there is also the South Slavonian Academy of Sciences and Arts, founded in 1866, as well as a Society of Agriculture, Literature, and History. Diocesan seminaries for Catholic theologians are maintained at Agram, Diakovar, and Zengg; and the priests of the Greek Church have institutions at

Carlowitz, Pakrac, and Plaski. General education is still much neglected, and about six-sevenths of the population can neither read nor write.

*History.*—Croatia and Slavonia were, for the most part at least, included in the ancient Pannonia; and remains dating from the Roman period are still to be seen at Mitrovits, Illuk, Sotin, and Tovarnik. After the Ostrogoths and the Avars had come and gone, the territory was in 640 taken possession of by the Slavonic races to which it owes its name—the Chrovats, Chorvats, or Horvats, and the Slavs. Temporary recognition of the Frankish kings, and the Byzantine emperors, was followed by the establishment of a more independent kingdom, which included not only Croatia and Slavonia, but also Dalmatia. In 1075, Zvonimir Demetrius, to whom the national party looks back as to the national hero, formally rejected the Byzantine overlordship, and received from Gregory VII. of Rome the title of king. In the 12th and 13th centuries the land was the object of frequent contest between the Byzantines and the Hungarians; and in the 14th and 15th it was still more harassed by the rivalry of Hungary with Venice. In 1524 the whole country fell into the hands of the Turks; but in 1526, after the battle of Mohacs, the districts of Agram, Kreutz, and Warasdin were attached to the Austrian crown, and by the Carlowitz peace of 1699, the whole of the country to the north of the Unna was resigned by the sultan. In 1767 the three kingdoms of Croatia, Dalmatia, and Slavonia were united under the name of Illyria, but the union was broken in 1777. Croatia and Slavonia continued to be regarded as part of the Hungarian kingdom; but a strong national reaction took place in 1848-9 against the Magyar supremacy, and in reward for the service rendered against the Magyar revolt by the ban Jellachich, Austria declared the country independent of Hungary. In 1860, however, the policy of Vienna was altered, and Croatia and Slavonia were again obliged, in spite of the strong opposition of a large party, to resume their former connection with Hungary, which was not recognised by the national diet till 1868, and then only after the central administration had interfered with the elections in a most arbitrary manner.

See Csaplovicz, *Slawonien und Kroatien*, 1819; Paton's *Highlands and Islands of the Adriatic*, 1849; Neigebaur, *Die Südländer und deren Länder*, 1851; A. O. Zeithammer, "Zur physikalischen Geographie Kroatiens und Slawoniens" in Petermann's *Mittheilungen*, 1859, and "Die Wagrechte und Senkrechte Gliederung Oesterreichisch-Kroatiens," ditto, 1861; "Sugli antichi ghiacciaj della Drava," in *Atti di Accademia di Milano*, 1871; Steinhäuser, *Geographie von Oesterreich-Ungarn*, 1872; Dr. P. Matkovic, *Kroatien-Slawonien nach seinen physischen und geistigen Verhältnissen*, Agram, 1873; and a paper from the same authority on "Die Orographische Gruppierung der Süd-Croatischen Hochebene," in Petermann's *Mitth.*, 1873.

**CROCODILE** (*Crocodylia*), an order of Reptiles which, in the possession of a four-chambered heart, and of distinct sockets for the teeth, and in the traces of a diaphragm, differs from the other reptilian orders, and shows an approach in organization to warm-blooded animals. The presence of a four-chambered heart does not prevent that commingling of venous and arterial blood previous to its entrance into the system, which is common to all reptiles, as this is effected in the present order by means of a communication between the main arterial and venous tubes, immediately outside the heart. Crocodiles are further characterized by the presence of a partial dermal skeleton, developed in the leathery integument, consisting of numerous square bony plates, keeled in the centre, and forming a complete dorsal shield. The vertebrae of the neck bear upon each other by means of rib-like processes, the neck being thus deprived to a great extent of its mobility; hence the difficulty experienced by crocodiles in turning. The limbs are short and insufficient to support its entire weight; it consequently drags its body somewhat along the ground. The toes, of which there are five on each of the posterior limbs, and four on the anterior pair, are more or less webbed, while the three inner ones only are provided with claws. The nostrils, eyes, and ears have lids or valves by which they can be closed at will, and the nostrils do not open into the cavity of the mouth, but are carried back to the pharynx, which can also be shut off from the outside by means of a valvular apparatus—an arrangement of the greatest possible service to these reptiles in preventing suffocation while seizing and holding their prey beneath the surface of the water. The tongue is attached all round to the bottom of the mouth, and for this reason the crocodile was formerly supposed to be destitute of that organ. The teeth, which are numerous, sharp, and conical, are arranged in a single row in both jaws, each tooth having its own socket, and the hollow at its base containing the

germ of a larger one, which by its growth gradually displaces the other. Three and even four generations of teeth, incased within each other, are often thus contained in a single socket, but the number of teeth above the surface remains the same at all ages. The fourth tooth on each side of the lower jaw is larger than the others, and fits into a notch or pit in the upper surface. As in snakes, the lower jaw is attached to a process connected with and extending backwards from the skull, which greatly adds to the animal's gape, while giving it the appearance, in opening its mouth, of moving both jaws. Beneath the lower jaw are two orifices connected with glands which secrete a musky substance.

Crocodiles are amphibious, leaving the water to bask in the sun on the mud-banks of rivers and marshes, or to devour the prey they have previously drowned. They are oviparous, depositing their eggs—from twenty to sixty in number, and inclosed in a calcareous shell—in holes made in the sand or mud of the river side, where they are left to be hatched by the heat of the sun, or as is the case with certain American species, in hillocks formed by themselves, which they hollow out and fill with leaves and other decaying vegetable matter, where the eggs are hatched by the heat generated in the decomposing mass. On quitting the egg the young crocodiles are led to the water by the female parent, who feeds them for some time with food which she herself disgorges, and otherwise shows the greatest solicitude for their safety. The male takes no part in rearing the young, but is said on the contrary to attack and devour them when not prevented by his mate. Large numbers also fall victims to the rapacity of fishes and turtles, while the smaller Carnivora and certain birds destroy great quantities of the eggs. The eggs, which in the common crocodile are nearly as large as those of a goose, are in spite of their musky flavor held in great estimation as an article of food in the regions where they occur, and this leads to a still further diminution of the crocodilian progeny. During the first year the young are said to feed on the larvae of insects and on small fishes. Crocodiles are inhabitants of the rivers and marshy lagoons of tropical and sub-tropical regions, a few only frequenting the brackish water of estuaries. One species—the Alligator of North America—has a range sufficiently north of the tropics to encounter ice in winter, while one of the Indian crocodiles ascends the courses of the rivers it frequents to such a height above the sea that the water it occupies is often frozen. During the dry season these reptiles bury themselves in the mud and remain dormant until the return of moister conditions, and they have thus been known to exist without food for a whole year. Tennent states that in Ceylon he has met with the mud case from which the Marsh Crocodile of that island had recently withdrawn, and he also tells of an officer who, camping out one night, was disturbed by a strange motion of the earth beneath his bed—a phenomenon explained in the morning by the emergence of a crocodile. They also bury themselves in the mud on the approach of danger, and when taken unawares they feign death as a means of escape. The writer above alluded to states that on one occasion his party came upon a sleeping crocodile which on being struck, after it had awakened and seen itself surrounded, lay perfectly quiet and apparently dead; in a little while it was seen to glance furtively about, and then make a rush towards the water. On receiving a second blow it again feigned death, and this time no amount of poking could elicit the slightest sign of life, until a lad by gently tickling it under the fore leg caused the reptile so far to forget itself as to draw up its limb. They resort to a somewhat similar stratagem in order the more readily to reach their prey. Lowering their head and tail they allow themselves to be carried down by the current of the stream, and in this position are said to bear the closest resemblance to floating logs of wood—a disguise well fitted to allay suspicion in the animal they are seeking to approach. They feed on fishes, and on the numerous quadrupeds which visit their haunts in order to drink. The latter they seize and drag into the water, holding them under the surface till life is extinct, and afterwards conveying the dead body to the nearest sand-bank or river island, where it is often hidden until putrefaction has rendered it sufficiently digestible. Although timid they do not hesitate to attack man, when off his guard, and bathing in tropical rivers is rendered dangerous by their presence. There are three families of living crocodiles—Caviac,



**True Crocodiles and Alligators.** The Gavials are readily distinguished by their greatly elongated and narrow snout, and by the uniform size of their teeth (the five or six front pairs excepted), of which the Gangetic species has fifty-two or fifty-four above, and fifty or fifty-two below. It inhabits the lower parts of Indian rivers, especially the Ganges, where it performs the useful office of devouring the carcasses of animals that otherwise would pollute the sacred river. It attains a length of over 17 feet, and the male is furnished with a large and prominent swelling in front of the nostrils.

The true Crocodiles have the so-called canine tooth of the lower jaw fitting into a notch or furrow in the upper surface; the hind legs are bordered by a serrated fringe, and the toes are almost completely webbed. Of these there are twelve species, four of which are Asiatic, occurring eastward from the rivers and estuaries of India to Australia; three are African, one ranging from Egypt to the Cape, the others confined to the rivers of West Africa; while four belong to the Neotropical Region of Central and South America. The Common Crocodile (*Crocodilus vulgaris*) may be taken as typical of the family. It inhabits the chief rivers of Africa, but is best known as a denizen of the Nile, where in ancient times the Egyptians regarded it as a divinity. At Memphis and other cities temples were raised in its honor, in which live crocodiles were kept,—these sacred reptiles being reared with the greatest care, fed luxuriously, and adorned with costly trinkets. They were thus rendered perfectly tame, and took part in the religious processions and other ceremonies performed in their honor. When dead their bodies were embalmed, and extensive grottoes have been discovered at Maabdeh containing large numbers of these reptilian mummies. The inhabitants of several Egyptian cities, however, regarded the crocodile with entirely opposite sentiments, considering it to be the incarnation of Typho, the genius of evil; and among these the ichneumon, as the deadliest foe of the crocodile, was thought worthy of divine honors. Once a year the people of Apollinopolis had a solemn hunt, in which they killed as many crocodiles as possible, casting the dead bodies before the temple of their god; and so expert had they grown in this sport that they did not hesitate to enter the Nile, and bring the crocodile ashore by force. Crocodiles appear to have been formerly abundant in all the known parts of the Nile, but have now disappeared from the delta, and according to a recent authority are rarely seen to the north of Beni Hassan, and are evidently receding from below the second cataract. This is largely owing to the constant persecution they are subjected to by the passengers on board the Nile steamers, to which also must be attributed their exceeding wildness, for it is now almost impossible to come within rifle shot of them. A small black-headed plover (*Charadrius melanocephalus*) may often be seen perched on the reptile's back, attracted by the numerous insects which find a congenial residence there; and this active little bird, by rising in the air and uttering a shrill cry, give its bulky patron timely warning of the approach of man. Towards the sources of the Nile the crocodile is still abundant. Sir Samuel Baker states that when navigating the Albert Nyanza he observed every basking place covered with them, the creatures lying parallel to each other like trunks of trees prepared for shipment, and that on one bank he counted twenty-seven of large size. The flesh of this species is eaten by the natives, but it does not seem suited to the European palate. "To my taste," says the authority just referred to, "nothing can be more disgusting than crocodile flesh. I have eaten almost everything, but although I have tasted crocodile I could never succeed in swallowing it. The combined flavor of bad fish, rotten flesh, and musk is the *carte de diner* offered to the epicure." In Siam the flesh of another species is regularly sold in the market as human food. The Common Crocodile usually measures about 15 feet in length.

Alligators differ from the preceding group in having the canine tooth fitting into a pit in the upper jaw; the hind legs are also destitute of fringe, and the toes are less completely webbed. They are found in America only, and with one exception are confined to its tropical parts. The Alligator (*Alligator mississippiensis*) occurs in the rivers and swamps of Mexico and the United States, where it is a source of danger to all animals venturing to enter the water. In winter this species retires into holes on the

river banks, and there hibernates. While thus dormant it is often got at by the negroes, who unearth it for the sake of the tail, which they reckon a delicacy. It is said to attain a length of 15 to 18 feet. The remaining eight species of alligators are found chiefly in South America, where they are known as Caymans and Jacarés. They abound in the Amazon and the Orinoco, the silence of whose lonely banks is seldom broken except by their nocturnal bellowings. According to Humboldt they resemble their Old World allies in lying basking in the sunshine, wherever a shallow in the river discloses a sand-bank, "with open jaws, motionless, their uncouth bodies often covered with birds."

Fossil remains referable to the order *Crocodylia* occur for the first time in the Trias, and continue to appear in allied forms during succeeding periods. These have been very fully investigated, and Professor Huxley has given a remarkably complete sketch of the life-history of the entire order, recent and fossil. This he divides into three sub-orders. I. In the *Parasuchia*, among other characters, both pterygoid and palatine bones are destitute of bony plates to prolong the nasal passages, and the centra of the vertebrae are amphicoelian, as in fishes. To this group belongs the earliest of the crocodiles—the Triassic *Stagonolepis* of the Elgin sandstone, which somewhat resembled a cayman, with the snout of a gavial. II. In the *Mesosuchia*, the bony plates of the palatine bones prolong the nasal passages and give rise to posterior nares, and the vertebral centra are amphicoelian. This group includes such forms as *Teloneurus* and *Stenocoelus*, ranging from the Liassic to the Cretaceous formations. III. In the *Eusuchia*, both pterygoid and palatine bones give off plates which prolong the nasal passages, and the centra of the vertebrae are mostly procoelian. The species contained in this group make their appearance in the Greensand of North America and in the Eocene of Europe, and to it belongs all the existing crocodiles. This group was at one time much more generally distributed than it is at present, representatives of gavials, crocodiles, and alligators, now so widely apart, and altogether absent from Europe, being found together in the Eocene beds of the south-west of England. The greatly restricted range which characterizes their present distribution seems to mark the crocodiles as a declining group. (J. G.)

CRÆSUS, king of Lydia, was the son and successor of Alyattes. It was supposed by Clinton and Bähr that for fifteen years he shared the throne with his father; however that may be, he became sole king on the death of Alyattes, about 568 B. C. (according to the computation of Rawlinson), when, Herodotus tells us, he was thirty-five years old. He speedily reduced all the Greek cities in Asia Minor, and soon most of the tribes to the west of the River Halys (the Kizil Irmak) were subject to him. The wealth, meanwhile, which he had inherited from his father had been enormously increased, until it far surpassed that of any other sovereign with whom the Greeks were acquainted. He was therefore to them the type of human prosperity; and the bitter contrast of his fall powerfully impressed itself on their imagination, which became in part the creator of the vividly dramatic story so finely told by Herodotus. The most famous incident in that story was the visit of Solon. After ostentatiously displaying all his treasures, the king asked the sage who was the happiest man he had ever known. Tellus of Athens, was the reply, for he lived while his country was prosperous; he was surrounded with children and children's children, who were both beautiful and good; and he died upon the field of battle after having gained a gallant victory over the enemy. And next to him Solon counted two Argive youths, Cleobis and Biton, whose strength and skill won prizes at the games, who, when the oxen failed to appear from the fields in time, piously drew their mother's car forty-five furlongs to the festival of Juno, and as reward received the praises of all men, and were allowed to die in the very temple of the goddess, after offering their sacrifices and feasting at the holy banquet in her honor. For two reasons, added the wise man, Croesus with all his fortune was not to be held so fortunate as these,—the gods are jealous of human prosperity, and no man can be called fully happy till a happy death has closed a happy life. Soon after misfortunes began to thicken about Croesus. His son, despite all the care with which, being warned in a dream, he drew him from the dangers of battle, and sought to shield him even from accident, was unintentionally slain at a boar-hunt by Adrastus. News came also of the conquests of Cyrus, who had overcome Astyages, the brother-in-law of Croesus. The oracle of Delphi prophesied that if Croesus went to war he would "destroy a mighty empire,"

and that he was to flee when a "mule" sat on the throne of Media; and, secure in what appeared to him the most unambiguous of prophecies, Croesus invaded Cappadocia. But the mighty empire he was to destroy proved to be his own; he was repulsed, and soon Sardis was stormed and taken by Cyrus. Croesus, careless of life, was about to be slain, when one of his sons, hitherto dumb, in his fear overcame his infirmity, and made known his father's rank. Croesus was therefore spared to be taken as a prisoner before Cyrus. He was placed on a funeral pyre, and, as he watched the rising flames, he thought of Solon, whose name burst from his lips. When questioned, he repeated the warning of the sage, which so powerfully affected the mind of Cyrus that he ordered the flames to be extinguished. The efforts of the soldiers, however, were in vain; but, as Herodotus narrates, the prayers of Croesus prevailed upon Apollo, whose temples he had formerly enriched with costly gifts, to send a heavy fall of rain which quenched the fire. The wisdom of Croesus gained the friendship of Cyrus, who also made him minister to his son, Cambyses. But, having ventured to reprove Cambyses for an act of cruelty, Croesus was forced to seek safety in flight; and here ends the story of his life. It is said that, when he reproached the oracle which had led to his fall, he received the convincing answer that Cyrus was the "mule" foretold, as he was the son of a Median princess and a Persian subject. Apollo, it was added, had done what he could by prevailing on the fates to delay the fall of Croesus full three years.

See Herodotus (bk. 1.), in Rawlinson's edition of which (1875) there is a discussion of the historical facts of the story, an amplified version of which is given in Damascenus.

CROFT, WILLIAM (1677-1727), doctor of music, was born in 1677, at Nether Easington in Warwickshire. He received his musical education in the Chapel Royal under Dr. Blow. He early obtained the place of organist of St. Anne's, Westminster, and in 1700 was admitted a gentleman extraordinary of the Chapel Royal. In 1707 he was appointed joint-organist with Blow; and upon the death of the latter in 1708 he became sole organist, and also master of the children and composer of the Chapel Royal, besides being made organist of Westminster Abbey. In 1715 he obtained his degree of doctor of music in the university of Oxford. In 1724 he published an edition of his choral music, in 2 vols. folio, under the name of *Musica Sacra, or Select Anthems in score, for two, three, four, five, six, seven, and eight voices, to which is added the Burial Service, as it is occasionally performed in Westminster Abbey*. This handsome work was the first of the kind executed on pewter plates and in score. John Page, in his *Harmonia Sacra*, published in 1800 in 3 vols. folio, gives seven of Croft's anthems. Of instrumental music, Croft published six sets of airs for two violins and a bass, six sonatas for two flutes, six solos for a flute and bass. He died in August, 1727, and was buried in the north aisle of Westminster Abbey, where a monument was erected to his memory by his friend and admirer Humphrey Wyrley Birch. Burney in his *History of Music* devotes several pages of his third volume (pp. 603-612) to Dr. Croft's life, and criticisms of some of his anthems.

CROKER, JOHN WILSON (1780-1857), statesman and author, was born at Galway on the 20th December, 1780. He belonged to a respectable family of English origin that had been settled in Ireland for several generations, being the only son of John Croker, well known and popular as the surveyor-general of Ireland. He was educated at Trinity College, Dublin, where he graduated in 1800. Immediately afterwards he was entered as a student of Lincoln's Inn, and in 1802 he was called to the Irish bar. In 1803 he published anonymously *Familiar Epistles to J. F. Jones, Esquire, on the State of the Irish Stage*, a series of witty and caustic criticisms in verse on the leading dramatists of the day, which passed through several editions in a short time. Equally successful was the *Intercepted Letter from China* (1805), also anonymous, a satire on Dublin society. In 1807 he published a pamphlet on *The State of Ireland, Past and Present*, in which he advocated Catholic emancipation. In the following year he entered Parliament as member for Downpatrick, obtaining the seat on petition, though he had been unsuccessful at the poll. The notorious case of the duke of York furnished him with an opportunity of obtaining patronage and place of which

he skillfully availed himself. The speech which he delivered on the 14th March, 1809, in answer to the charges of Colonel Wardle, was generally regarded as the most able and ingenious defence of the duke that was made in the debate; and to the gratitude of the latter for this service was probably due Croker's appointment in the close of the year to the office of secretary to the Admiralty, which he held without interruption under various administrations for more than twenty years. In 1827 he became the representative of the university of Dublin, having previously sat successively for the boroughs of Athlone, Yarmouth, and Bodmin. He was a determined opponent of the Reform Bill, and vowed that he would never sit in a reformed Parliament; his parliamentary career accordingly terminated in 1832. Two years earlier he had retired from his post at the Admiralty on a pension of £1500 a year. Many of his political speeches were published in a pamphlet form, and they show him to have been a vigorous and effective, though somewhat unscrupulous and often virulently personal, party debater. The same character attaches to him in his capacity as a political writer. He was one of the founders of the *Quarterly Review*, and for many years was one of its leading contributors on political and historical subjects. The rancorous spirit in which many of his articles were written did much to embitter party feeling, and to cause men on both sides of greater eminence than himself to stoop to unworthy controversy. It also reacted unfavorably on Croker's reputation as a worker in the department of pure literature by bringing political animosities into literary criticism. No reply is possible to the majority of the criticisms which Macaulay in his unsparing review brings against Croker's *magnum opus*, his edition of Boswell's *Life of Johnson* (1831), but with all these defects the work had merits which Macaulay was of course not concerned to point out. It certainly possessed whatever evidence of excellence is afforded by the fact of a very extensive circulation. Its success in this respect led the publisher to propose to Croker the preparation of an annotated edition of Pope's works, on which he was occupied for several years. It was left unfinished at the time of his death, but it has since been completed by Peter Cunningham and the Rev. W. Elwin, and published. A list of Croker's other chief works is given below. Special mention, however, may be made of his *Stories from the History of England for Children*, not only because it had a very large circulation, but because it was taken by Scott as the model for his *Tales of a Grandfather*. In an amusing letter to Croker accompanying a presentation copy of the latter work, Sir Walter speaks of it as "a sample of the *swag*."

Croker did good service to the cause of literature and art by other means besides his pen. He was one of the founders of the Athenaeum Club. In his place in Parliament he advocated the claims of the fine arts upon state recognition and aid at a time when these claims had fewer supporters than they have now. In his later years his house at West Molesey near Hampton Court was the resort of many eminent literary men, chiefly of his own party. He died at St. Albans Bank, Hampton, on the 10th August, 1857.

The chief works of Croker not already mentioned were his *Letters on the Naval War with America; A Reply to the Letters of Malachi Malagrowther; Military Events of the French Revolution of 1830; a translation of Bassompierre's Embassy to England; and several lyrical pieces of some merit, such as the Songs of Trafalgar*. He also edited the *Suffolk Papers, Hervey's Memoirs of the Court of George II., the Letters of Lady Hervey, and Walpole's Letters to Lord Hertford*.

CROKER, THOMAS CROFTON (1798-1854), an antiquary and humorist, was born in Cork in 1798. He was apprenticed to a merchant, but in 1819, through the interest of John Wilson Croker, who had been a friend of his father, he became a junior clerk in the Admiralty, where he afterwards obtained one of the first clerkships. In 1825 he produced his most popular book, the *Fairy Legends of the South of Ireland* (reprinted in 1834), which he followed up by the publication of his *Legends of the Lakes, his Adventures of Barney Mahoney, and an edition of the Popular Songs of Ireland*. In 1827 he was made a member of the Irish Academy; and in 1839 and 1840 he helped to found the Camden and Percy Societies, for the former of which he published (1841) an edition of certain *Narratives Illustrative of the Contest in Ireland in 1641 and 1690, and*

for the latter his *Revolution in Ireland* in 1688, and several other works. He was also a member of the Hakluyt, Archæological, and Antiquarian Societies. He died in London, August 8, 1854.

CROLY, GEORGE (1785-1860), a distinguished literary divine of the Church of England, was born in Dublin about 1785, and received his education at Trinity College there. Croly, although a staunch unbending Tory, owed to Lord Brougham his promotion to the living of St. Stephen's, Walbrook, London. The appointment conferred honor on Brougham, as the presentee was a keen partisan, and had zealously served his political friends with his pen. He was neglected by the Tories very much as Sydney Smith was by the Whigs. Croly was a great pulpit orator, and continued, not unworthily, the illustrious school of Irish eloquence, which boasts such names as Burke, Sheridan, and Grattan. He was also a ripe classical scholar, and in early life showed no common aptitude for music. He died on November 24, 1860. Croly was a man of restless energy, and won laurels in many fields. It is as a literary man, however, that he claims attention. And here the first thing that strikes us is his extraordinary versatility. Poems, biographies, dramas, sermons, novels, satires, magazine articles, newspaper leaders, and theological works were dashed off by his facile pen; and, according to Hogg, the Ettrick Shepherd, he was great in conversation. While a young man, Croly wrote dramatic criticism for a short-lived paper called the *New Times*. His genuine satiric vein was seen in one of his earliest works, *The Times*, and in one of his latest, the *Modern Orlando*, which appeared in 1854. His poems were first issued in a collected form by Henry Colburn and Richard Bentley, in 1830. The principal are—*Paris in 1815*, which embodies a description of the works of art then to be found in the Louvre; *The Angel of the World*, an Arabian tale; a collection of short poems, with corresponding engravings, entitled *Gems from the Antique*; *Catiline*, a tragedy; and *Sebastian*, a Spanish tale. *Pride shall have a Fall*, a comedy, is not included in this edition. His poetry, although of a high order, suffered from being contemporaneous with that singularly rich outburst of song in virtue of which the early years of the present century almost rival the Elizabethan era. The pieces, too, are remarkable rather for fine passages than for sustaining the interest of the reader throughout. *Paris in 1815*, however, achieved a temporary popularity; some of his lyrics inspire enthusiasm; and he is particularly successful in his conception of Catiline's character. Croly's prose writings cover a wide field. He was one of the earliest contributors to *Blackwood's Magazine*; he edited the *Universal Review*, and wrote a number of leaders for the *Britannia*, a Conservative organ, which supported the system of protection. To theology he contributed, in 1827, *The Apocalypse of St. John, a new Interpretation*; and volumes of sermons were issued by him from time to time. He is the author, too, of a number of sketches, a *Life of Edmund Burke*, a character of Curran, a history of King George IV., and an able review of Napoleon's career. Croly, however, was most successful as a novelist. His chief fictions are—*Tales of the Great St. Bernard*; *Marston, or the Soldier and Statesman*; and his masterpiece, *Salathiel, The Immortal*. Salathiel is the character better known as the Wandering Jew. This legend has been treated poetically by various writers, including A. W. von Schlegel, Schubert, Goethe, and Mrs. Norton, and is the subject of Eugène Sue's famous work, *Le Juif errant*. Croly's book gives us vivid pictures of scenery in the East, and is full of striking imagery and noble bursts of eloquence. Indeed the language, as well as the scenery, is Asiatic in character; and its Oriental luxuriance sometimes passes into extravagance. Croly's works, as a whole, exhibit strong sense, a fertile imagination, and a genuine, if somewhat too showy, eloquence. He is a signal instance of great professional success, joined to high distinction in other fields.

CROMARTY, a county in the north of Scotland, consisting of eleven detached portions scattered throughout Rose-shire, with which county it is for most purposes incorporated. One of these portions, that which is situated on the south shore of the Cromarty Firth (from which it takes its name *cromachty*, or crooked bay), is the original county; and this district still preserves for Cromarty a separate lord-tenancy and commission of supply. As a county, it was originally very inconsiderable in extent; but by the additions which were made to it towards the end of the

17th century it was increased to fifteen times its former size. Of these additions, one is a small district surrounding Tarbat House, on the northern shore of Cromarty Bay; and a second runs from the south side of Tain Firth to the Moray Firth, cutting off that portion of the county of Ross which terminates in Tarbat Ness, the extremity of which also belongs to Cromarty. Two more fragments lie on the south of the River Carron, in the parish of Kincardine; the sixth extends northward from the burgh of Dingwall, situated chiefly in the parish of Fodderty, and occupied in great part by the peak and slopes of Ben Wyvis; the seventh lies to the north of Loch Fannich in the parish of Contin, at some distance to the north-west of which a triangular morsel is found to the north of Loch Nid; the ninth is that which stretches along the southern shore of Little Loch Broom; and the tenth is the district of Ullapool and Coygach, with the adjacent islets, lying between the northern shore of Loch Broom and Sutherlandshire. This district, which is the largest portion of the county, occupies an area of about 20 miles in length by 9 in breadth. The straggling arrangement of Cromarty was produced by the influence of George, Viscount Tarbat, afterwards earl of Cromarty, who, wishing to have all his various lands included in one shire, got them annexed to his own county in 1685 and 1698. The total extent of the county is estimated at 220,800 acres, or 345 square miles, equal to about a tenth of the area of the united county of Ross and Cromarty. The Cromarty Firth forms one of the finest harbors on the east coast of Scotland, securely sheltered at its mouth by two remarkable crags called the "Soutars." See Ross.

CROMARTY, the county town, is situated near the mouth of the firth of that name on its southern shore, 16 miles N.N.E. of Inverness. It is a small irregularly built town, and carries on some trade in herring and white fish. The corporation consists of a provost and nine councillors, and the town forms one of the Wick group of burghs, which returns one member to Parliament. Population, 1476.

CROME, JOHN (1769-1821), English landscape painter, founder and chief representative of the "Norwich School," often called Old Crome, to distinguish him from his son, was born at Norwich, December, 21, 1769. His father was a weaver, and could give him only the scantiest education. His early years were spent in work of the humblest kind; and at a fit age he became apprentice to a house-painter. To this step he appears to have been led by an inborn love of art and the desire to acquaint himself by any means with its materials and processes. During his apprenticeship he sometimes painted signboards, and devoted what leisure time he had to sketching from nature. Through the influence of a rich art-loving friend he was enabled to exchange his occupation of house-painter for that of drawing-master; and in this he was engaged throughout his life. He took great delight in a collection of Dutch pictures to which he had access, and these he carefully studied. About 1790 he was introduced to Sir William Beechey, whose house in London he frequently visited, and from whom he gathered additional knowledge and help in his art. In 1805 the Norwich Society of Artists took definite shape, its origin being traceable a year or two further back. Crome was its president and the largest contributor to its annual exhibitions. Among his pupils were Stark, Vincent, Thirle, and Bernay Crome, his son. Cotman too, a greater artist than any of these, was associated with him. Crome continued to reside at Norwich, and with the exception of his short visits to London had little or no communication with the great artists of his own time. He first exhibited at the Royal Academy in 1806; but in this and the following twelve years he exhibited there only fourteen of his works. With very few exceptions Crome's subjects are taken from the familiar scenery of his native county. Fidelity to nature was his dominant aim. "The bit of heath, the boat, and the slow water of the flattish land, trees most of all—the single tree in elaborate study, the group of trees, and how the growth of one affects that of another, and the characteristics of each,"—these, says Mr. Wedmore, are the things to which he is most constant. He still remains, says the same critic, of many trees the greatest draughtsman, and is especially the master of the oak. His most important works are—*Mousehold Heath*, near Norwich, now in the National Gallery; *Clump of Trees*, Hautbois Common; *Oak at Poringland*; the *Willow*; *Coast Scene*

near Yarmouth; Bruges, on the Ostend River; Slate Quarries; the Italian Boulevards; and the Fishmarket at Boulogne. He executed a good many etchings, and the great charm of these is in the beautiful and faithful representation of trees. Crome enjoyed a very limited reputation during his life, and his pictures were sold at low prices; but since his death they have been more and more appreciated, and have given him a high place among English painters of landscapes. He died at Norwich after a few days' illness, April 22, 1821. A collection of his etchings, entitled *Norfolk Picturesque Scenery*, was published in 1834, and was re-issued with a memoir by Dawson Turner in 1838, but in this issue the prints were retouched by other hands. For a genial and appreciative critique on this attractive painter, see Mr. Frederick Wedmore's *Studies in English Art* (1876).

CROMLECH (Gaelic or Welsh *Crom*, curved, vaulted, and *leac* or *llech*, a monumental stone) is the name given in Britain to those megalithic monuments exclusively which consist of a great stone supported on three or more stones set on end in the ground. In France, however, and on the Continent generally, it is exclusively employed to denote a totally different class of monument, for which in this country we only use the descriptive names of "stone circles," or "circles of standing stones." This application of the term in different countries to different classes of monuments has given rise to much confusion. The earliest known use of the word occurs in Bishop Morgan's translation of the Bible into Welsh (1588), where "the clefts of the rocks" of our translation is rendered by *cromlechydd y creigiau*. Its earliest occurrence in the special sense in which it has continued to be used by antiquarians is in a description of some ancient remains by Rev. John Griffith of Llanddnyfan (1650), in which he says, "There is a crooked little cell of stone not far from Alaw, where, according to tradition, Bronwen Leir was buried; such little houses, which are common in this country, are called by the apposite name *cromlechau*." The restricted sense in which the term has been applied in recent times in this country has given rise to the notion that a *cromlech*, or great stone supported on props of smaller size, is a species of structure complete in itself, and distinct from the *dolmen* or chambered cairn. Mr. Fergusson, in his recent work on *Rude Stone Monuments*, has described the monuments usually known by the term *cromlech* as "free-standing dolmens," and maintains that they were never intended to be covered with a mound or cairn. It is evident that the removal of the loose stones of the enveloping cairn would leave its megalithic chamber exposed as a *cromlech*, and undeniable that many of the examples adduced as "free-standing dolmens" in England do exhibit traces of such removal. But on the other hand the *steendysser*, or "Giants' Graves," of Denmark and Sweden, which are perfectly analogous to the *cromlechs* of this country, are never wholly hidden in the mounds which envelop their bases. The present tendency is towards the entire disuse of the term *cromlech*, and the adoption of the term *dolmen* for all the varieties of tombs with megalithic chambers, whether "free-standing" or partially or wholly enveloped in mounds of stone and earth.

CROMPTON, SAMUEL (1753-1827), the inventor of the spinning-mule, was born at Firwood, near Bolton-le-Moors, Lancashire, of poor parents. While yet a boy he lost his father, and removed with the rest of his family to Hall-in-the-Wood, near Bolton, where he educated himself as well as circumstances would allow, maintaining himself by working as a cotton-spinner. His musical capacity—he had sufficient taste and knowledge to compose several hymn-tunes—enabled him to earn a little money by playing the violin at the Bolton Theatre. Meanwhile he was working hard to perfect his invention for spinning yarn for the manufacture of muslin, and he had brought it into working order before his marriage, which took place in 1780. The expense of a patent proving too costly for his limited means, he was glad to make known the construction of his machine to a few manufacturers for very small sums of money. Several refused to fulfil their agreement, and all he received was about £60. The use of his invention spread rapidly, and he constantly made improvements upon it; but though in 1801 he had, with the aid of £500 lent him by a friend, extended his business by employing a number of hands besides his own family, he was nearly sixty years of age before he obtained

any important pecuniary recompense. Urged by the monetary difficulties in which he had involved himself through his somewhat shy and unbusiness-like temperament, he drew up a paper showing how marvellously extensive and useful was the employment of the mule, and £5000 was allowed him by Parliament. In 1826, however, his business had again failed, and another attempt was made to obtain a second Government grant, but without success. He died on the 26th June, 1827. (See his *Life* by G. French.)

CROMWELL, OLIVER, Lord Protector of the British Commonwealth, was born at Huntingdon, 25th April, 1599. His father, Robert Cromwell, was the second son of Sir Henry Cromwell of Hinchinbrook, surnamed for his munificence *The Golden Knight*. His mother, Elizabeth Steward, was the daughter of a gentleman of some property in the city of Ely. The connection of the Cromwell family with that of the celebrated Thomas Cromwell, earl of Essex, and of the Stewards with the royal line of Scotland, is not without interest.<sup>1</sup> The stories of Cromwell's youthful visions and adventures, his violence and profligacy, are derived from the most questionable authority, and are little worthy of serious notice. The authentic facts of his early history seem to be confined to these:—that he was educated at Huntingdon grammar-school, under a rigid and pious instructor, Dr. Thomas Beard; on 22d April, 1616, he was admitted a fellow-commoner of Sidney Sussex College, Cambridge; on his father's death in June, 1617, he left the university, carrying away at least as much Latin as enabled him in after years to make occasional use of that language; and soon after he proceeded to London to gain some knowledge of law. There is no proof that he ever attended any of the inns of court; and regarding his life in London, and the limits of his residence there, we are equally destitute of information. On 22d August, 1620, he was married at St. Giles's Church, Cripplegate, to Elizabeth, daughter of Sir James Bouchier of Felsted, in Essex, a woman of very amiable and prudent character, whose gentle virtues sweetened his domestic life to its close, amid all outward vicissitudes.<sup>2</sup> He now returned to Huntingdon, and assumed the management of his patrimonial estate; and in the quiet routine of a farmer's life fulfilled for nearly ten years, without any incident chronicled in history, the ordinary duties of a country gentleman. We are left to imagine so far as we can, the silent and unnoticed growth of a great soul, limited as yet in its outgoings to the cares of a farm,—the thoughts that struggled and sank to rest in the stillness of home,—the powerful religious convictions, the "splenetic fancies," the deep fits of melancholy, that ultimately resulted in an open profession of Christianity, and a steady adherence thenceforward to that strict and earnest form of it which had received from its enemies the derisive name of Puritanism. The house of Oliver Cromwell became from this time a resort of "godly men;" and in their prayers and preachings, their interests and their grievances, he took a zealous and active part. On 17th March, 1628, he took his seat in the House of Commons as member for Huntingdon. The increasing influence of Puritanism, reacting against the arbitrary and ceremonious tendencies of the king, was powerfully exhibited in the transactions of this brief but memorable Parliament. On 11th February,

<sup>1</sup> The character of Cromwell, in some of its noblest aspects, seems to have been inherited from his mother. She died at Whitehall, November 16, 1654, in her ninetieth year. "A little before her death," says Thurloe, "she gave my lord her blessing in these words:—"The Lord cause His face to shine upon you, and comfort you in all your adversities, and enable you to do great things for the glory of your Most High God, and to be a relief unto his people. My dear son, I leave my heart with thee. A good night!"

<sup>2</sup> See the proofs adduced in Foster's *British Statesmen*, vi. 2; Carlyle's *Letters and Speeches of Cromwell*, i. 32, 40.

<sup>3</sup> She died in the house of her son-in-law Claypole, October 8, 1671. The following letter from her husband, penned the day after the battle of Dunbar, may be taken as a specimen of his private correspondence. "For my beloved wife, Elizabeth Cromwell, at the Cockpit; these, Dunbar, 4th September 1650.—My Dear-est,—I have not leisure to write much. But I could chide thee that in many of thy letters thou writest to me, that I should not be unmindful of thee and thy little ones. Truly, if I love you not too well, I think I err not on the other hand much. Thou art dearer to me than any creature; let that suffice. The Lord hath showed us an exceeding mercy; who can tell how great it is? My weak faith hath been marvellously upheld. I have been in my inward man marvellously supported; though I assure thee, I grow an old man, and feel infirmities of age stealing upon me. Would my corruptions did as fast decrease! The particulars of our late success Harry Vane or Gilbert Pickering will impart to thee. My love to all dear friends. I rest thine, Oliver Cromwell." (*Letters and Speeches*, iii. 67.)

1629, a few weeks before the close of its second session, Cromwell made his first recorded speech,—calling the attention of the House to the scandalous fact “that Dr. Alabaster had preached flat popery at Paul’s Cross,” and even been encouraged therein by his diocesan; while “Mainwaring, so justly censured by this House for his sermons, was by the same bishop’s means preferred to a rich living.” “If these,” he said, “are the steps to church preferment, what are we to expect?” “It is amusing,” remarks Mr. Hume, “to observe the first words of this fanatical hypocrite, corresponding so exactly to his character.” The correspondence is remarkable enough; but those who have formed a different estimate of Cromwell from that of the sceptical historian may find more than amusement in this first sound of “the imperial voice” which in after days “arrested the sails of the Libyan pirates and the persecuting fires of Rome.”<sup>1</sup>

About two years after this Cromwell sold his lands in Huntingdon, and stocked a grazing farm at St. Ives, where he resided for five years. In 1636 he removed to Ely, where he had succeeded to the property of his uncle, Sir Thomas Steward. Events meantime were tending to a great crisis. His first cousin, John Hampden, had on the 11th January in this year refused to pay his “ship-money,” in the streets of London, in the midst of pale crowds, good men were being mutilated, branded, and pilloried; Scotland had risen in a flame against a forced episcopacy, and the patience of England was drawing near exhaustion. In April, 1638, sentence was delivered against Hampden. The spirit of resistance rose with each new check. In his own district Cromwell had now some opportunity for its exercise, and that victoriously. The great work of draining the fens and completing the Bedford Level had proceeded successfully, till the interference of royal commissioners excited a general outcry of dissatisfaction. Cromwell took an active part in the opposition; and his successful zeal in the business procured him the popular title of “Lord of the Fens.” In April, 1640, a new Parliament met, in which he took his seat as member for Cambridge. In three weeks it was dissolved. Another was summoned for the 3d November, which became ever memorable in history as the “Long Parliament.” Cromwell again sat for Cambridge. Of his share in its proceedings for about two years there is little record. That he was an active member there can be no question. One interesting glimpse we obtain from the graphic narrative of Sir Philip Warwick. It brings before us a Monday morning, early in November, 1640, when the writer, then “a courtly young gentleman,” came into the House, “well clad,” and found a remarkable figure in possession of the House, “a gentleman whom I knew not, very ordinarily apparelled,” his linen “plain and not very clean,” his stature “of a good size, his sword stuck close to his side, his countenance swoln and reddish, his voice sharp and untunable, and his eloquence full of fervor.” This personage was pleading, amid considerable attention, on behalf of a troublesome young man of the name of Lilburne, amanuensis to Mr. Prynne, “who had disperst libels against the queen for her dancing and such like innocent and courtly sports.” The impression made on the gay young courtier was anything but favorable. “I sincerely profess,” he says, “it lessened much my reverence unto that great council, for this gentleman was very much hearkened unto.”

The inevitable rupture at length took place, and the king and Parliament made their appeal to the sword. On 12th January, 1642, Charles left Whitehall to return no more till the day of his execution. Military preparations on both sides began; and now, at the mature age of forty-three, Oliver Cromwell girded on his armor, and, with his eldest son Oliver<sup>2</sup> by his side, left his quiet home and farm

to fight for England’s liberty. With no knowledge of the art of war, but much of himself, of men, and of the Bible, this stout English squire had made up his mind in no hasty or factious spirit to draw the sword against his king, and venture his life for what he believed with his whole heart and soul to be the cause of “freedom and the truth in Christ.” Out of his moderate fortune he subscribed £500 “for the service of the commonwealth;” £100 more he expended on arms; and during the summer he was actively engaged in raising volunteers. His first exploit was to seize the magazine in the castle at Cambridge, and prevent the carrying away of the university plate to help the royal exchequer. In September he received his commission as captain of a troop of horse. In the first campaign the royal troops generally had the advantage. Cromwell already knew in his own person wherein lay the strength of Puritanism, and the secret of its success. He spoke on the subject to his cousin Hampden. “Old decayed serving-men and tapsters,” and such “base mean fellows,” he said, “could never encounter gentlemen and persons of quality.” To match “men of honor” they must have “men who had the fear of God before them,” and would “make some conscience of what they did.” “A few honest men,” he elsewhere said, “are better than numbers.” Mr. Hampden thought his cousin “talked a good notion, but an impracticable one.” To turn “good notions” into facts, however, was the characteristic work of Cromwell,—“impracticable” being a word for which we may suppose him to have had as little tolerance as Napoleon. On this principle of selection, accordingly, he gradually enlisted around him a regiment of 1000 men, whose title of “Ironsides” has become famous in history. “They never were beaten.” “Had his history,” says Mr. Forester, “closed with the raising and disciplining of these men, it would have left a sufficient warrant of his greatness to posterity.”

During the winter associations for mutual defence were formed among the counties. Of these the “Eastern Association” alone, through the prompt and indefatigable activity of Cromwell, proved really efficient. During the spring of 1643, having now attained the rank of colonel, he employed himself in quelling all royalist attempts throughout the association, giving them the final blow by the capture of Lowestoft, with a considerable body of influential royalists and a large supply of warlike stores. His services were next devoted to Lincolnshire, and with similar success. Towards the end of July the marquis of Newcastle, after his victory at Atherton Moor, advanced with a large army against Gainsborough, which was garrisoned by a small Parliamentary force under Lord Willoughby. Cromwell threw himself between the town and the enemy’s van, under General Cavendish, forced his way up a sandy eminence, in the face of a body three times superior in number to his own, and drove them in total rout down the other side. Their commander, an accomplished young nobleman, was killed on the spot. “This victory,” says Whitelocke, “was the beginning of Cromwell’s great fortunes, and now he began to appear in the world.” The other Parliamentary leaders, meantime, had met with a series of humiliating reverses, and at the close of the summer the popular cause seemed in imminent peril. In August the earl of Manchester took the command of the Eastern Association, with Cromwell as one of his colonels. On 9th October they effected a junction with Fairfax at Boston, and on the 11th Cromwell and Fairfax encountered the royal force under Sir John Henderson on the field of Winceby, near Horncastle. Cromwell led the van, which advanced to the battle singing psalms. His horse was killed in the first charge, and fell upon him. As he rose he was again struck down, but recovering himself he mounted a “sorry horse” belonging to a trooper, and mingled in the fight. The enemy gave way at the first onset, and were pursued with terrible slaughter for many miles. During the remainder of this season Cromwell was occupied in attending to the security of the Eastern Association, in raising funds, and settling public affairs in Ely, of which he had some months previously been appointed governor.

On 10th April, 1644, the Scotch Covenanted army of became Master of the Horse to the Protector. Mr. Carlyle calls her “a graceful, brave, and amiable woman.” Mary, born 1637, died 1712, was married to Lord Fauconberg. Dean Swift called her “handsome and like her father.” Frances, born 1638, died 1721, was married first to Mr. Rich, again to Sir John Russel. Charles II. at one time entertained the idea of allying himself with Cromwell by marrying her.

<sup>1</sup> Macaulay, *Essay on Hallam’s Constitutional History*.

<sup>2</sup> We may here subjoin a brief notice of Cromwell’s family, gathered from a note by Mr. Carlyle. Oliver (born in 1623) entered as a cornet in the same division of cavalry with his father, who seems to have regarded him with deep affection and hope. He was killed shortly before the battle of Marston Moor. The Protector, on his death-bed, alludes to this Oliver’s death: “It went to my heart like a dagger, indeed it did.” Richard was born in 1626, and died in 1712, a man of mild and indolent character, unfit for any office requiring strong powers of mind. Henry, born in 1628, died in 1674. He entered the army at sixteen, and greatly distinguished himself by his courage, prudence, and resolution. He accompanied his father to Ireland in 1649, and in 1657 was appointed lord deputy there. He governed with great ability. “He is a governor,” said Cromwell, “of whom I myself might learn.” Of the daughters, the eldest, Bridget, born 1624, died 1681, was married first to Ireton, afterwards to Fleetwood. Elizabeth, born 1629, died 1658, was married to Mr. Claypole, who

21,000 men under Lesley, earl of Leven, united with Fairfax at Wetherby, and proceeded to invest York. They were presently joined by Manchester and Cromwell, now lieutenant-general and second in command. On hearing of this, Prince Rupert hurried from Lancashire at the head of 20,000 men, and relieved York. The Parliamentary army raised the siege, drew out to meet the enemy on Marston Moor, and on the evening of the 2d July gave a death-blow to the royal cause in the north of England. To Cromwell belonged the chief glory of the victory. While the right wing under Fairfax was overpowered by the furious onset of Prince Rupert, Cromwell carried all before him on the left, and, suddenly wheeling round, charged the victorious cavalry of Rupert with such overwhelming force that they were "swept off the field,"—"God made them as stubble to our swords." In the west, on the other hand, Essex and Waller succeeded only in losing their armies. The Parliament, still confiding in these generals, granted them fresh forces, and summoned Manchester and Cromwell to join them. On 27th October they met the king at Newbury, and a sanguinary conflict ensued, with dubious success. During the night the king effected a safe retreat. Cromwell urged Manchester to pursue him, but in vain. Twelve days thereafter, the king and Prince Rupert returned, revictualled Dennington Castle, and carried off their artillery. Cromwell again pressed Manchester to attack them, but the timid earl was immovable. The fruit of these disagreements was a rupture, ending in important results. On 25th November Cromwell, having been called upon to give an account of the affair at Newbury, charged Manchester in the House of Commons with neglect of the Parliamentary interests; and on the 9th December openly urged the necessity of remodelling the army. The "self-denying ordinance," discharging members of Parliament from military offices, and permitting enlistment without the signing of the Covenant, was finally passed on 3d April, 1645. Meantime Fairfax had been nominated general, the "new model" was passed, and the raising of troops and remodelling of the old army proceeded with activity.

The wisdom of these changes was proved by the triumphant result of the next campaign. Cromwell's services were by this time felt to be indispensable. He accordingly received a dispensation from the self-denying ordinance, and was hastily despatched (April, 23) to intercept a force of 2000 men sent by Rupert to convoy the king from Oxford to Worcester. On the second day he attacked and routed them at Islip Bridge, took Blethington House on the same day, and on the 26th gained another victory at Radcot Bridge. On 31st May the king suddenly stormed Leicester; the southward movement of his army exposed the eastern counties to imminent danger; and Fairfax, appealed to for help, immediately solicited the appointment of Cromwell as his lieutenant-general. The request was granted, and Cromwell, collecting 6000 chosen horse, joined the camp at Northampton without the loss of an hour, amid the acclamations of the whole army. Decisive action attended his presence; on the very day following, June 14, 1645, the royal army was beaten to pieces on the field of Naseby, and the first civil war virtually brought to an end. Cromwell and his Ironsides decided, as usual, the fate of the day. Proceeding victoriously south-westward, the Parliamentary army encountered the "Clubmen," a new and somewhat formidable party in the royal interest. At Shaftesbury Cromwell dispersed a large body of them, after which they appeared no more. On 11th September Bristol was stormed; and again turning southward the army took every town and stronghold in its way. Cromwell particularly distinguished himself by his sieges. Basing House, the residence of the marquis of Winchester, had for four years defied all besiegers, and was regarded by the royalists as impregnable. On 14th October Cromwell wrote to the speaker—"I thank God I can give you a good account of Basing." He had stormed it that morning at 6 o'clock, having, says Hugh Peters, "spent much time with God in prayer the night before." A few more such successes ended the campaign and the war. On 22d April, 1646, Cromwell returned to his place in Parliament, and was received with the most distinguished honors.

During the next two years he resided for the most part in London, taking a due share in the negotiations with the king, and in the important contest between the Presbyterians and Independents, represented respectively by the

city and army, which ended in the triumph of the latter. On the one side the support of the army was felt to be now an unnecessary burden, while the fact that so many of the soldiers had never taken the Covenant was displeasing to the strict Presbyterians, especially to those who had held commands in the old army. On the other side it was regarded as a most hazardous policy to disband the army without any surer guarantee for the nation's peace than the promises of the king. The formal claims of the soldiers, however, were forty-three weeks' arrears of pay, indemnity for acts done in the war, and discharge according to contract. After much unsatisfactory negotiation, the celebrated rendezvous or army convocation took place (June 10, 1647) on Triploe Heath near Cambridge. The Parliamentary commissioners were saluted in every regiment with the cry "Justice! Justice!" On the same day a letter signed by the general (Fairfax) and chief officers was despatched to the mayor and corporation of London. It expressed in moderate language their desires, containing at the same time the significant intimation that "for the obtaining of these things we are drawing near your city." A succession of events varied by the advance and retreat of the army as the Parliament resisted or yielded, ended in the entry of the army into London, Aug. 6, after having received full satisfaction of all its demands. On 12th November the king escaped from Hampton Court, leaving the Parliamentary leaders convinced, after months of fruitless negotiation, of the hopelessness of further treating with him. On 3d January, 1648, it was decided that there should be no more addresses to his Majesty. In March news came from Scotland that a royalist army under the duke of Hamilton was preparing to invade England. The smouldering elements of insurrection now broke out. In London an alarming riot was only crushed by "a desperate charge of cavalry." Similar risings in Norwich, Canterbury, Exeter, etc., were put down by Fairfax. A more formidable revolt took place in Wales, and thither Cromwell was ordered to hasten. On 11th May he took the town of Chpstow, and after a protracted siege Pembroke Castle was surrendered to him on 11th July. Having settled Wales, Cromwell now hastened northwards and joined Lambert in Yorkshire. Hamilton, with 17,000 Scots, and Sir Marmaduke Langdale, with 4000 Yorkshiremen, were advancing in loose combination into Lancashire. Cromwell, marching westward at the head of 8600 men, attacked them at Preston on 17th August. The rout and chase extended over three days, at the end of which Hamilton's army was a total wreck. 2000 men were slain, and 10,000 (the duke himself in the number) made prisoners. So rapid and unexpected had been the movement of Cromwell, that Hamilton did not know till the close of the first day with what enemy he had been engaged. Following up this amazing success, Cromwell proceeded northward by Durham and Berwick across the border. On 4th October he entered Edinburgh, where he was welcomed with enthusiasm. During two days he lodged in "the earl of Murrie's house, in the Cannigate," receiving visits from persons of distinction; and on the day of his departure he was entertained to a sumptuous banquet in the castle. Having received satisfactory guarantees of future amity, he took his departure on the 7th October, leaving Scotland "in a thriving posture," and "like to be a better neighbor than when the great pretenders to the Covenant, and religion, and treaties, had the power in their hands." Returning by Carlisle, which was delivered up according to agreement with the Scots, he laid siege to Pontefract Castle. It held out stubbornly. On 6th December, the day of "Pride's Purge," having left Lambert to conduct the siege, Cromwell arrived in London, and on the morrow received the thanks of the House for his services. During the following month he sat assiduously in the High Court of Justice for trying the king; and after the execution was nominated to the new council of state.

The critical state of Ireland now demanded the most vigorous measures,—the whole country, with the exception of Dublin and Derry, having, through the exertions of Ormond, being roused into open war against the Commonwealth. On 16th March, 1649, Cromwell was nominated lord-lieutenant for Ireland. Some work, however, still remained to be done at home. The wild doctrines of the Levellers, propagated mainly through the restless activity of John Lilburne, had made dangerous way in the army. The flame of discontent soon broke out into open mutiny

at the various headquarters. By prompt activity, and a just exercise of "vigour and clemency," Cromwell and Fairfax quelled this alarming insurrection; two or three of the ringleaders were shot; the rest were admonished and submitted. On 10th July Cromwell left London in great state, and after some weeks spent in preparations at Bristol, embarked at Milford Haven, August 13,—“followed,” as Milton tells us, “by the well-wishes of the people, and the prayers of all good men.” He landed in Dublin on the 18th, and was received with the most lively demonstrations of joy. On 3d September he appeared before Tredah (Drogheda), which Ormond had garrisoned with 3000 of his best troops. On the 10th Cromwell's batteries began to play, and the governor received a summons to surrender. It was rejected, and the bombardment proceeded. Next day a breach was made, and the storming party entered, but met with a vigorous repulse. Cromwell, witnessing this from the batteries, hastily headed a second assault, drove in the enemy, and, “being in the heat of the action,” put the whole garrison without mercy to the sword. “I am persuaded,” he wrote in his despatch, “that this is a righteous judgment of God upon these barbarous wretches, who have imbrued their hands in so much innocent blood; and that it will tend to prevent the effusion of blood in the future. Which are the satisfactory grounds to such actions, which otherwise cannot but work regret and remorse.”

The execrable policy of that regicide,” says Carte, “had the effect he proposed. It spread abroad the terror of his name.” Towns and garrisons were yielded up in rapid succession; and, with the exception of Wexford, where a similar slaughter took place (October 11), the subsequent effusion of blood in Ireland was comparatively small. The arm of resistance had been thoroughly paralyzed. On 2d December Cromwell retired to winter quarters. Before resuming the campaign, he issued, in answer to a manifesto from an assembly of the Popish hierarchy at Clonmacnoise, a “Declaration for the Undeceiving of Deluded and Seduced People.” In this remarkable document Cromwell, with rude but masterly hand, tears up the sounding pretences of the hierarchy, points to the true causes of Ireland's miseries, rebuts the charges of “massacre” and “extirpation,” and invites the inhabitants of Ireland to submit peaceably to the Commonwealth, with assurances of inviolate protection in their just rights and liberties. These promises were no empty words; the results of Cromwell's conquest and government in Ireland were a general peace and prosperity, admitted, even by his bitterest enemies, to be without example in the previous history of that misgoverned country. On 29th January, 1650, he again took the field. Success everywhere attended him and his lieutenants. At Clonmel 2000 men of Ulster made a last desperate effort in the royal cause. After a fierce and gallant resistance the place was stormed, and surrendered on 9th May. Cromwell had some time previously received orders to return to England; and having thus, within the brief space of nine months, reduced a hostile kingdom to comparative obedience, he sailed for England, leaving Ireton as his deputy, and entered London in triumph on 31st May.

The threatening aspect of affairs in Scotland had hastened his recall. Charles, willing “to sign anything,” had taken the Covenant, and forces were being raised against the Commonwealth. The command of the northern expedition was offered to Fairfax, but he declined to act against the Scottish Presbyterians, save in the event of their invading England; and on 26th June Cromwell was nominated captain-general of all the forces of the Commonwealth. He made his preparations with his usual promptitude, and on the 29th marched from London,—Lambert, Fleetwood, Whalley, Monk, Pride, and Overton commanding under him. On 23d July he crossed the border at Berwick. The inhabitants everywhere fled at his approach, the clergy having represented the English invaders as “sectaries and blasphemers,” “monsters of the world,” who would “put all the men to the sword, and thrust hot irons through the women's breasts.” By dint, however, of encouraging proclamations, combined with the extreme discipline preserved in the army, the confidence of the people was gradually restored. On 28th July Cromwell encamped at Musselburgh. The Scotch army, commanded by David Lesley, as superior to the English in numbers as it was inferior in discipline, lay strongly fortified between Edinburgh and Leith. On the second day after the arrival of Cromwell the enemy made a vigorous sally, but were re-

pulsed with loss. “This,” wrote Cromwell to the president of the council, “is a sweet beginning of your business, or rather the Lord's.” Lesley, however, was not to be drawn into an open encounter. Fabius himself was not more skilful in wearing out by cautious manœuvring the patience of an enemy. During a whole month Cromwell marched and countermarched round Edinburgh, in vain attempting to provoke a battle, his supplies failing, the season advancing, and sickness reducing his men “beyond imagination.” Declarations and responses, with no satisfaction on either side, had meanwhile passed between him and the Scotch commissioners. On 31st August he left Musselburgh, and fell back upon Dunbar, where his ships lay. Lesley immediately hastened to cut off his retreat, and, pressing closely in the rear, took possession of the heights above Dunbar, and the only pass that left a southward opening to the enemy. Thus hemmed in, the sea behind, the enemy encircling him on the hills, 23,000 strong, his own men reduced by sickness from 14,000 to 11,000, Cromwell's good fortune seemed, on the 2d September, 1650, to have at length forsaken him. “Before the fight,” he afterwards wrote to Ireton, “our condition was made very sad, the enemy greatly insulted and menaced us.” Not even then, however, did his strong trust in God and in himself for a moment desert him. “He was a strong man,” said one who knew him; “in the dark perils of war, in the high places of the field, hope shone in him like a pillar of fire, when it had gone out in all the others.” “In the mount the Lord would be seen; He would find out a way of deliverance and salvation.” On the afternoon of that gloomy day, Cromwell, reconnoitring the enemy's position, saw that Lesley was moving his forces to the right, and “shogging” down his right wing to more open ground. At once recognising the advantage this offered for “attempting upon the enemy,” he decided, after consulting his officers, to begin the attack on the morrow before dawn. The battle, however, did not begin till six. The “dispute” was hot on the right for about an hour, when Cromwell's own regiment came to the charge, and “at the push of pike” drove in “the stoutest regiment” of the enemy. At that moment the sun's beams broke out through the morning mist over the hills and the sea, and the flashing lines of steel. Then was Oliver heard to say, in the words of the Psalmist, “Let God arise, let his enemies be scattered!” Horse and foot now charged resistlessly on every side; the Scottish ranks fell back in wild confusion, wrecked and scattered in tumultuous flight. Before 9 o'clock 3000 of them were slain, and 10,000 prisoners, with all their baggage, train, and artillery, were in the hands of the English, who “lost not thirty men.”

He now took possession of Edinburgh, where he spent the most of the winter and spring. The city clergy had shut themselves up in the castle, and refused on his invitation to return to their flocks. Some correspondence ensued, in the course of which the general showed himself rather more than a match for the theologians even on their own ground. In February a deputation from Oxford came to inform him of his election as chancellor of the university. Shortly after, we find him pleading in behalf of a “pious and laudable scheme” for establishing a college at Durham. About this time he was seized with a dangerous illness, brought on by exposure to wet and cold, which, after a temporary convalescence, broke out in several severe relapses. The Council of State expressed their consideration by sending two physicians from London to attend him. In the interval he spent ten days in Glasgow, where he held a friendly conference with some of the leading Presbyterian ministers. The Scotch army meantime lay intrenched at Torwood near Stirling. Towards the end of June, Cromwell having recovered from his illness, moved westward. Finding the enemy too strong to be dislodged, he sent a portion of his army under Lambert across the Firth. At Inverkeithing they defeated a large body of the enemy, killing about 2000 men. Inchgarvie and Burntisland soon after surrendered to Monk; and Cromwell, crossing with his army to Fife, marched upon Perth, which surrendered on the second day. Charles, finding his supplies thus cut off, determined on a bold stroke, and, breaking up his camp, marched into England. Cromwell, leaving Monk behind him, sent his light horse in advance, under Lambert, joined by Harrison, and followed at some distance. The tidings of the royal movement excited great alarm in

<sup>1</sup> *Letters and Speeches*, iii. 40, 52.

London, and it was even suspected that the general had betrayed the Commonwealth. Cromwell, not unaware that such fears would arise, wrote to the Parliament simply relating the facts, and expressing full confidence of success. The militia flocked to his standard all along his march; and by the time he reached Worcester he found himself at the head of upwards of 30,000 men. There, on the 3d of September, 1654, the anniversary of Dunbar, after a fierce and unequal contest, the Scotch army was shivered into ruin, and the last hope of royalism buried. "The dimensions of this mercy," said Cromwell in his despatch, "are above my thoughts. It is, for aught I know, a crowning mercy."

At this point Cromwell's career as a soldier ends, and the events of his life become identified with the general history of Britain. After the battle of Worcester, the management of Scotland, where his deputy Monk had been completely successful in crushing royalism, naturally fell under the chief direction of Cromwell. That country was now united to the Commonwealth by Act of Parliament; a small army distributed in garrisons preserved the peace of the country; justice was strictly administered; the affairs of the church were committed to a commission of pious and judicious ministers; and during the whole period of Cromwell's government Scotland prospered under a strict but beneficent rule. In the interval between the battle of Worcester and the dismissal of the "Rump" Parliament, Cromwell took no continuously visible part in public affairs. The general opinion among historians seems to be that during these nineteen months the ambitious general was busily occupied in the course of profound dissimulation and intrigue which had marked his whole career, and that as the premeditated result of the selfish scheme of usurpation which had lurked darkly in his bosom even on the banks of the Ouse, he entered the House of Commons on 20th April, 1653, expelled the Parliament, and assumed the reins of power. These views may be left untouched; certain it is that the great assembly that moulded the Commonwealth had now, at the end of twelve years, exhausted its vitality, and dwindled into a numerical fragment of a Parliament, and a mere mockery of representative government. It had become in fact an oligarchy, which absorbed to itself not merely the whole administration of public affairs, but the control of many private interests. Their "only serious occupation to maintain themselves in power, and defend themselves against their enemies,"<sup>1</sup> these men wasted months in debating questions of mere technicality, and prolonged time after time the duration of their power, after the voice of the nation, so far as it was capable of being interpreted, had pronounced it intolerable. After months of discussion and delay, they had completed their measure for electing a new Parliament, professedly with the view of laying down their power into the hands of their successors, when it was found that by this act the members of the existing Parliament were to be *de jure* members of the new, and to constitute a committee for deciding on the admission of their successors. On the morning of 20th April Cromwell, being informed that this measure was getting hurried through the House, entered with his troopers, and dissolved the Parliament. By that daring act he became the sole head of power in the nation, and nothing was left him but to use it as wisely and firmly as he could. The consequences of that act left him thenceforth no honorable retreat had he desired it. One strong hand was needed to give consistency and unity to the action of the state, alike in its internal and its foreign relations; and, from the hour that Cromwell seized the helm, the ship of the Commonwealth rode the waves, if not without straining or accident, yet with a proud and steady march. Few tears were shed for the departed "statesmen;" the nation quietly submitted, if it did not positively approve; the business of the state went on without interruption; the leaders of the army and navy, many of them ardent republicans, continued at their posts, sinking their private opinions in their concern for the country's good. As soon as possible, summonses were issued in Cromwell's name to 140 "persons of approved fidelity and honesty," selected from the nation by himself and his council to act as a Parliament in the existing emergency. This extraordinary assembly met on the 4th of July. The old and vulgar charge against them, as a herd of mean and contemptible fanatics, is of a piece with the general run of historic portraits of Cromwell himself,

<sup>1</sup> Guizot, *History of Cromwell and the English Commonwealth*.

and has been sufficiently answered even by writers who have little favor for him. They were in fact a body of most sincere and earnest men, only too eager and comprehensive in their efforts to accomplish a national reformation. They attempted too much; they aroused a storm of hostility from the classes whose interests they threatened; they bowed before it; internal dissensions and intrigue hastened their fall; and on 12th December they resigned their power into the hands of Cromwell, who now found himself in the solemn position of being the uncontrolled arbiter of the peace and safety of Britain. Earnestly desirous, as he throughout evinced himself, of giving his country a stable and constitutional government, he was willing now, rather than that England should sink into the abyss of anarchy, to brave the dangers and the odium that attach to the name of a usurper. Four days after the resignation of the "Little Parliament," it was openly proclaimed that Oliver Cromwell had been invested with the office of supreme governor of the British Commonwealth under the title of "Lord Protector," and on 16th December, 1653, he was solemnly installed in Westminster Hall.

All the chief courts of Europe sent their congratulations to the new sovereign, and soon they were made to feel and bow to his power. A Parliament was summoned for the 3d of September, 1654, and in the meantime Oliver and his council proceeded with vigor in the settlement of domestic and foreign affairs. "In less than nine months," says M. Guizot, "eighty-two ordinances, bearing upon almost every part of the social organization of the country, bore witness to the intelligent activity and to the character, at once conservative and reformatory, of the Government." Of these it is sufficient to mention the partial reform of the Court of Chancery, and the settlement of ecclesiastical affairs by the commission of "Triers," a body of able and pious men who, by the impartial testimony of Baxter, "did abundance of good to the church." A plot, the first of many, to assassinate the Protector, was discovered in the month of July. The principal conspirators, Gerard and Vowel, were executed; and on the same day, as a terrible example to Europe of British justice, Don Pantaleon Sa, brother of the Portuguese ambassador, was publicly beheaded for his share in the murder of an English citizen. On the 3d September the Parliament met. The Protector had already concluded peace with the Netherlands, Sweden, Denmark, and Portugal, and a treaty with France was proceeding hopefully towards settlement. The Parliament began business by deliberating whether they should approve the newly-established frame of government—in other words, by calling in question the authority which had called them together. Oliver at once hastened to set them right. "I told you," he said, "that you were a 'free Parliament,' but I thought it was understood withal that I was the Protector and the authority that called you." He concluded an earnest and powerful address by requiring them to sign a document pledging themselves to acknowledge the existing Government. One hundred and fifty of the republican members refused to sign, and withdrew. The rest resumed their sitting; but their subsequent proceedings were scarcely more satisfactory than their inauspicious commencement. Instead of accepting as a fact the power of the Protector, and aiding him in the work of government, they occupied themselves in interposing as many checks as they could to his influence. Deeply grieved at the failure of each successive attempt to govern by constitutional means, Cromwell was not therefore discouraged. If Parliaments would not help him, he was determined to govern without them. His scheme of "Major-generals" followed,—a little poor invention," as he called it, for preserving order in the country, and crushing the now imminent attempt at a combination between the Royalists and the Levellers. Though arbitrary, and in many instances oppressive, this scheme accomplished the great end of its establishment—the preservation of the country's peace.

But while the enemies of peace and order at home were made to feel the invincible power of his government, it was in his relations with foreign states that the commanding genius of Oliver was most conspicuously displayed. No monarch ever so sustained in the eyes of Europe the majesty of the British power. The grand object of his foreign policy was to unite the Protestant states, with Britain at their head, in a defensive league against Popery, then as now the enemy of civil and religious liberty.



Spain, "the great underpropper of the Roman Babylon," the "natural enemy of the honest interest," he determined to humble, and in due time he did. With France, less subject to the yoke of Rome, he allied himself, making such terms as he pleased, extorting from the crafty Mazarin, a prince of the Church of Rome, protection for Rome's enemies, and full pardon for offences committed against her in the heart of France itself! In the summer of 1655 the persecution of the Protestants in the valleys of Piedmont afforded an occasion for displaying in the noblest light the greatness of the Protector and of the nation which he represented. The tidings of these cruel oppressions affected the stern conqueror to tears. The treaty with France was ready to be signed that day. He refused to put his name to it until he received assurance of protection for the persecuted Piedmontese; and immediately wrote, not only to the duke of Savoy himself, but to Louis XIV., to Cardinal Mazarin, the kings of Sweden and Denmark, the States-General, the Swiss cantons, and even to Ragotski, prince of Transylvania, pleading for their interposition. Had his remonstrances proved unsuccessful, he had fully prepared to exact compliance at the point of the sword. A Protector not of the British realms only, but of the Protestantism of Europe, this "usurper" might claim, without fiction, the title "Defender of the Faith." Meantime the supremacy of England on the seas was upheld by Blake, whose guns thundered along the shores of the Mediterranean, exacting justice and submission from every hostile power. The duke of Tuscany, the Pope, the deys of Tunis, Tripoli, and Algiers, each in succession, were forced to make reparation for injuries to English commerce and liberty. The Mediterranean was cleared of pirates, and the confidence of peaceful merchants was restored. "By such means as these," said Cromwell, "we shall make the name of Englishman as great as that of Roman was in Rome's most palmy days."

After a lapse of nearly two years, Cromwell, still clinging to the wish of restoring the ancient constitution, now made another experiment at governing with a Parliament. It met on 17th September, 1656. About a hundred of the inveterate republicans were excluded, and the House, now tolerably in harmony with the Protector's views, proceeded to a settlement of the nation. The major-generals were abolished early in spring; the form of a new constitution, with two Houses of Parliament, and one governing person, with the title of "King," was proposed; and during three months the subject was discussed amidst the intense expectation of the whole people. That Cromwell was willing and even desirous to add this element of stability to his government there can be no doubt; but seeing that the dangers that threatened to accompany the assumption of the title were likely to overbalance its advantages, he finally declined it. The remaining points of the constitution were agreed on, and on 26th June, 1657, he was again, with additional solemnity and increased power, invested with the Protectorate. The new Parliament assembled on 20th January, 1658. The Commons refused to acknowledge the Protector's House of Peers, and on 4th February he dissolved them, concluding his last speech with the solemn words—"God be judge between me and you!" The whole weight of government again rested on his shoulders, and with unabated energy he went on with his work, crushing the designs of domestic enemies, and maintaining abroad the full prestige of his power. His struggles were now drawing to an end. "He being compelled," says Maidston,<sup>3</sup> "to wrestle with the difficulties of his place, so well as he could, without parliamentary assistance, in it met with so great a burthen as (I doubt not to say) it drank up his spirits, of which his natural constitution yielded a vast stock, and brought him to his grave; his interment being

the seed-time of his glory and England's calamity." On the 6th August his favorite daughter, Elizabeth, died after a lingering illness, during which the Protector had watched unremittingly by her side. His health, already declining, now visibly broke down. On Friday, the 3d of September, 1658, the anniversary of his Fortunate Day, the spirit of Cromwell was released from its earthly toils,—Nature herself seeming to prophesy, in the voice of the tempest that had swept over England, that a great power was passing away.

"It has often been affirmed," says Lord Macaulay, "but apparently with little reason, that Oliver died at a time fortunate for his renown, and that, if his life had been prolonged, it would probably have closed amidst disgraces and disasters. It is certain that he was to the last honored by his soldiers, obeyed by the whole population of the British Islands, and dreaded by all foreign powers, that he was laid among the ancient sovereigns of England with funeral pomp, such as London had never before seen, and that he was succeeded by his son Richard as quietly as any king had ever been succeeded by any prince of Wales."<sup>4</sup>

Historians, till within a comparatively recent period, have been nearly unanimous in their judgment on the character of Cromwell. That he was a man of extraordinary abilities was a necessary and universal admission, but served for the most part only "to point the moral" as an aggravation of his crimes. The only question concerning so terrible a prodigy seemed to be, how far a selfish and unscrupulous ambition may have been modified in him by a blind fanaticism, how far in deceiving others he may gradually have fallen into deception of himself. That his history should have been so interpreted admits of easy explanation. The recoil of sentiment that followed the death of Cromwell, and with him of Puritanism as a visible power, was great in proportion to the intensity of the previous strain; and a man who attempted to realize Christianity as a practical element in the government of nations, and addressed armies and parliaments in the language of the Bible, was not likely to be looked upon with sympathy in the age of Bolingbroke and Hume. Had Cromwell been less of a Christian and more of a Pagan, historians might have accorded to him some of that leniency with which they have spoken of the vices of a Caesar or a Peter the Great. But the same office which cowardly hands had done for his bones, servility, ignorance, and prejudice did for his memory; and during most part of two centuries, the name of the greatest man of his own age, and one of the noblest of any age, has been associated with all the infamy that belongs to a life-long career of unmitigated hypocrisy and insatiable ambition. Truth, however, at length begins to prevail, and Cromwell's own prophetic hope is attaining fulfilment—"I know God has been above all ill reports, and will in his own time vindicate me." "In speaking," said Milton, "of a man so great, and who has deserved so signally of this commonwealth, I shall have done nothing if I merely acquit him of having committed any crime, especially since it concerns, not only the commonwealth, but myself individually, as one so closely conjoined in the same infamy, to show to all nations and ages, as far as I can, the supreme excellence of his character, and his supreme worthiness of all praise." The most eloquent of English historians has defended, in pages read by all the world, both the Puritans and their king; and another historian, with still deeper love and admiration, has paid his "tribute to the memory of a hero," in a work which will henceforth enable posterity to know what kind of man Oliver Cromwell really was.<sup>4</sup>

There is no severer test of a man's character than the use he makes of absolute power. Tried by this test Cromwell bears comparison favorably with any of the greatest names in history. Elevated into supremacy, regal save only in name, he still preserved the plain simplicity of his former life. Armed with more than regal power, he limited himself within the strict bounds of necessity. Personally he

<sup>3</sup> *History of England*, vol. i. p. 189.

<sup>4</sup> "The collection of all his speeches, letters, and sermons," says Hume, "would make a great curiosity, and, with a few exceptions, might pass for one of the most nonsensical books in the world." How the *Letters and Speeches of Oliver Cromwell, with Eulogiums by Thomas Otway*, reply to this remarkable verdict, readers must judge for themselves. No such noble service was ever rendered to the memory of a great man by a single hand. For an able biography in which a very opposite view is taken of the character of Cromwell, the reader is referred to Mr. Forster's *Statesmen of the British Commonwealth*, vol. vi. vii.

<sup>1</sup> It was said that Mazarin "feared Oliver more than the devil," and changed color at the mention of his name.

<sup>2</sup> Letter to Winthrop, governor of Connecticut (Thurloe, i. 763). From the same source we take this description of the Protector's personal appearance and character. "His body was well-built, compact, and strong, his stature under six feet (I believe about two inches), his head so shaped as you might see in it a storehouse and shop both of a vast treasury of natural parts. His temper exceedingly fiery, as I have known, but the flame of it kept down for the most part or soon allayed with those moral endowments he had. He was naturally compassionate towards objects in distress, even to an effeminate measure; though God had made him a heart wherein was soft little room for any fear, but what was due to Himself, of which there was a large proportion, yet did he exceed in tenderness towards sufferers. A larger soul I think hath seldom dwelt in a house of clay than his was."

cared little for the outward shows of royalty, but he stinted no pomp or ceremony so far as it seemed to involve the nation's dignity. Too great to be jealous or vindictive for himself, he was swift and stern in crushing the enemies of public tranquillity. He was truly a terror to evil-doers, a praise to them that did well. He fostered learning, though himself not learned, and allied with some to whom learning was profanity. "If there was a man in England who excelled in any faculty or science, the Protector would find him out, and reward him according to his merit." The head of a triumphant cause, he was so little of a fanatic that he tolerated all sects, so long as they meddled not to disturb the state. His large and healthy spirit was bound by no party sympathies, but yearned towards all good men, of whatever name. At an era when toleration was looked upon by many as foolish in politics and criminal in religion, he stood out in glorious prominence as the earnest advocate of the rights of conscience, and proclaimed all men answerable to God alone for their faith. Popery and prelacy he proscribed, on grounds political rather than religious; to the adherents of both he showed private lenity; under his rule men no more suffered at the stake or the pillory. So far did his thoughts reach beyond his age, that he desired, and earnestly attempted, to extend the rights of citizenship to the outcast and persecuted Jews. Himself the greatest, "the most English of Englishmen"—he was determined that England should be the greatest of states. He encouraged trade, planted colonies, made wise peace with whom he would, or waged just and successful war. All Europe trembled at his voice, and the flag of Britain thenceforth waved triumphant over every sea. In fine, considering the comparative position of Britain in the times that preceded and followed him, the circumstances of his life, and the difficulties with which he had to contend, making all allowance for his errors and his failings, he was a man for all ages to admire, for all Britons to honor in proud remembrance. No royal name, at least since Alfred's, is more worthy of our veneration than that of the "Usurper," Oliver Cromwell. (A. XI.)

CROMWELL, or CRUMWELL, THOMAS, earl of Essex. Of the life of Thomas Cromwell before he entered the service of Henry VIII., crowded with stirring incident as we know it was, the accounts that we possess are meagre and far from authentic. Even the year of his birth is unknown, but 1490 has been fixed upon as a probable approximate date. His childhood was passed near London—perhaps, as Foxe says, close by Putney—where his father, according to Foxe, and also according to the stronger evidence of Chappuys, the ambassador from Charles V.,<sup>1</sup> carried on the trade of a blacksmith. During his boyhood he lost his father, and his mother then married a fuller, whence Pole's assertion, "pater ejus pannis verrendis victum queritabat."<sup>2</sup> It has been conjectured that, as a boy, Cromwell entered the household of Cecily, marchioness of Dorset, and that therefore his family must have possessed some influence; but the letter referred to by Sir Henry Ellis is the only evidence of connection with the house of Dorset belongs in all probability to the period when he was engaged in the cloth trade.<sup>3</sup>

While still in his teens Cromwell made his way to Italy, where he was to read Machiavelli, and acquire those views of conduct and statesmanship which determined his career. He first passed over to Flanders, and obtained a situation as clerk in the English factory at Antwerp. He then took service, there is good reason to believe, as a soldier in Italy; but the story narrated by Foxe, that he was one of the duke of Bourbon's followers at the siege of Rome in May, 1527, is extremely doubtful. The inaccuracy of Foxe is notorious, and there is evidence in letters of his own that Cromwell was in England in January, 1527, and again in 1528. It nevertheless remains possible that during the interval he was at Rome on some diplomatic mission. Some time also he spent in the office of a merchant at Venice, with whom Pole claims to have had personal acquaintance; and Foxe asserts that, subsequently to his return to England, he paid another visit to Italy, being engaged by the leading merchants of Boston in Lincolnshire to procure certain privileges from the Pope. The

well-known story of the kindly help which he received while in distress from the Florentine banker Frescobaldi, and the noble gratitude which he displayed in his prosperity, rests apparently on no more certain authority than a novel of Bandello and the statement of Foxe, though it is an interesting illustration of the fame which he acquired as a man who never failed to remember a kindness.

From his signature on the title-deed of a manor in Buckinghamshire, dated 1512,<sup>4</sup> it appears that Cromwell was then practising, as we know he afterwards practised, as a scrivener—a combination of attorney and money-lender. He also for a time followed his step-father's trade of cloth-merchant. In 1523 he obtained a seat in Parliament; and he had most likely already entered the service of Cardinal Wolsey. That he had done so within two or three years after there is positive evidence to prove.<sup>5</sup> His principal employment was to collect the confiscated property of the monasteries granted by the Pope to Wolsey for the endowment of his colleges at Ipswich and Oxford; and the manner in which he performed this task, while it added very considerably to his purse, aroused numerous and vehement complaints. Indeed, many expected to see him mount the scaffold when his master's protection ceased to be of avail.

Among the followers of Wolsey, however, he had made himself of the first importance; and when ruin overtook the cardinal, it was on Cromwell that he leant. There are letters extant in Wolsey's handwriting, addressing Cromwell as a familiar friend, and earnestly begging his presence and advice; and there is one in the handwriting of Cromwell, containing such counsel as might have been given by an equal, and, with an air that savors somewhat of hypocrisy, congratulating the fallen minister on being now "at liberty to serve God," and "banish and exile the vain desires of this unstable world." For his fidelity, and especially for his defence of Wolsey in the House of Commons,<sup>6</sup> Cromwell received from his contemporaries the highest praise. His conduct appears to have been simply that of a man who, not forgetful of his own interests, was honorably desirous of serving a patron to whom he was deeply indebted. At first he remained with the cardinal, whom he accompanied to his uncomfortable exile at Esher. But he was not long content to serve in unprofitable obscurity, and he was besides in some alarm for his personal safety. New and aspiring projects began to fill his mind. Cavendish, Wolsey's gentleman-usher and biographer, tells how on All-Hallows day he found him gazing out of a window at Esher, with his primer in his hand, employed, unlike his wont, in saying his matins. He complained with tears to Cavendish that, while he had received no promotion from the cardinal, he was like to share his fall, and announced his intention of riding to the court that very afternoon to stake his fortunes on an interview with the king. An account of that interview has been given by Pole,<sup>7</sup> who asserts that he received his information from some of the courtiers present. Trusting in Henry's love of power and his bitter irritation against the Pope, Crom-

<sup>4</sup> Brewer, *Calendar of State Papers of the Reign of Henry VIII.* vol. i. p. 446.

<sup>5</sup> The signature of Cromwell as witness is affixed to a paper drawn up to prove the transfer of certain letters from Sir W. Gascoyne, the treasurer of Wolsey's household, to John Higden, dean of Cardinal College, and dated the 29th October of the seventeenth year of Henry VIII., i. e. 1525. (See Brewer, *Calendar, etc.*, vol. iv. part 1, p. 763.) And there are extant two letters written in 1526, and addressed to Cromwell as "one of my Lord Cardinal's Council," and "counsellor to my Lord Cardinal's grace" (Brewer, *Calendar*, vol. iv. part 1, pp. 1048-9). Sir Henry Ellis (*Original Letters*, 2d ser. 2d vol. p. 117) expresses the opinion that "he must have been in Wolsey's service at least as early as 1524."

<sup>6</sup> Cavendish (*Life of Wolsey*, p. 276), says that a bill had been passed in the House of Lords to "have my Lord Cardinal condemned of treason, . . . against which Master Cromwell inveighed so discretely, with such witty persuasions and deep reasons that the same would take there no effect." But Herbert quotes the articles of the bill, because, he says, "our vulgar chronicles misreport them," and proves that it was not a bill of impeachment, but one intended to disqualify Wolsey from being restored to office (*Life of Henry VIII.*, pp. 290-16, Murray's ed.). He adds, "These articles were presented to the Lords, and then sent down to the Lower House, where Thomas Cromwell (obtaining the place of a Burgess) so wittily defended his master that no treason could be laid to his charge. And upon this honest beginning Cromwell obtained his first reputation." Mr. Brewer (*Calendar, etc.*, vol. iv. Introd. p. 583), however, is inclined to believe that Cromwell risked nothing by his defence of Wolsey. The bill was dated 1st Dec., when Cromwell was already in the king's service; and there is no reason to believe that Henry was in favor of the measure, which, on the contrary, was likely to be distasteful to him as intended to limit his prerogative.

<sup>7</sup> *Apologia ad Carolum V.*, pp. 120-121, quoted by Tytler, *Life of Henry VIII.* p. 306.

<sup>1</sup> Quoted by Froude, *History*, vol. i. p. 585.

<sup>2</sup> *Apologia R. Poli ad Carolum V.* p. 128.

<sup>3</sup> Ellis, *Original Letters*, 1st series, vol. i. p. 218. It is made up of directions to Cromwell concerning a bed and certain other articles of furniture.

well ventured to reveal the daring policy which he had conceived. The authority of the Papacy in England was to be altogether abolished; and thus, not only was the painful question of the divorce to be easily settled, but the allegiance of the clergy, then divided, as Cromwell proved by reference to the bishops' oaths, between their sovereign and their spiritual head, was all to be claimed by the former. And, besides, Cromwell appealed to the king's cupidity by showing that all the wealth of the clergy was at the disposal of the king, since they (in common, indeed, with the whole nation) had, by receiving Wolsey as Papal legate, fallen under the penalties of *præmunire*. The boldness and originality of this advice, and the reputation for ability, address, and fidelity which he had gained, pointed Cromwell out to Henry as likely to prove a minister of no ordinary value; and he was at once taken into favor. The way, however, had been previously prepared. The duke of Bedford, whose life Cromwell had saved in Italy, spoke in his behalf; and he had recently laid several of the other courtiers under obligations. He had advised the cardinal to advance his interest at court by conferring handsome presents on those who had the greatest influence with the king, and had himself undertaken to fix the amounts, and choose the recipients, of these gifts.

Thus Cromwell gained entrance into the king's service. His rise was rapid, for he possessed qualities which admirably fitted him for success as a minister of Henry VIII. He was capable of carrying on a strong and arbitrary government with a hand that shrank from no measure that seemed necessary, and an eye that never failed in its vigilance; and, whenever the king chose to act independently, he was supple enough to bend, and to bend gracefully, to the inevitable. In him also the king found a servant who did not scorn to offer the flattery which he expected, who performed with seal and care any service, however trivial, and who was ever ready to join heartily in the hunting, gambling, and other pastimes in which he delighted. That, with these qualities, he was of obscure birth was a circumstance in his favor; for the policy of humbling the nobility, which had been steadily pursued by Henry VII., had not been reversed by his son. Immediately, or almost immediately, after his interview with the king, Cromwell was appointed privy councillor. One more service he rendered to Wolsey, as the bearer of the king's gift of a thousand pounds; but his fortunes were no longer linked with those of the cardinal. By 1532 he had obtained the posts of master of the jewels and clerk of the hanaper; in 1533 he was raised to the office of chancellor of the exchequer for life. By 1535 he had become master of the rolls, secretary of state, and, most important of all, had been appointed to the highest office in the church as vicar-general in ecclesiastical affairs,—a title which was afterwards changed (with what change of power, if any, is now unknown) for that of vicegerent. In 1536 he was made lord privy seal. In 1537 he received the Order of the Garter. And, besides these dignities and offices, he held those of great chamberlain, dean of Wells, chancellor of the university of Cambridge, justice of the forests north of the Trent, and Baron Cromwell of Okeham. On the 17th April, 1540, he was created earl of Essex.

To narrate the details and trace out the effects of Cromwell's policy belongs to history. In this biography it is sufficient to consider the general character of the measures for which he was responsible, to estimate his aims and motives, and discuss the means which he employed.

A great scheme, consistently carried out, is manifest throughout the whole of his political career. All power was to be centralized in the hands of the king, or in those of the ministers whom he appointed; for the present, that is, in the hands of Cromwell himself. In secular affairs this centralisation was already almost complete. Parliament voted, and the judges decided, as the king wished; and juries could be readily frightened into abject submission. The power of the nobles, which of old had been the national safeguard against despotism, had been laid in the dust by the Wars of the Roses and the successful policy of Henry VII. The church alone retained a species of independence. That independence it was therefore Cromwell's first aim to destroy. The momentous contemporary events which suggested his scheme gave him the opportunity of effecting its accomplishment. It was the support of the Papacy which alone enabled the English clergy to make

any stand against their sovereign; and on the Continent that authority had been repudiated by several states. In England the king's mind was ripe for a breach with Rome; and the new learning had spread a general desire for ecclesiastical reform. Henry was soon persuaded to sever every bond that united England with Rome. Parliament complied with its usual facility. The clergy were forced, as the price of escape from the penalties of *præmunire*, to acknowledge the king's headship of the church. And all Cromwell's foreign policy was directed to support this great revolution; England was to be placed at the head of a Protestant league which should defy the emperor and the Pope.

Such being Cromwell's policy, it was natural that he should make himself the recognized protector of Protestant heretics. He was unable to offer the slightest resistance to the passing of the Six Articles, by which Henry sought to fix the faith of England and terrify all parties into order, but he allowed no Lutheran to pay the penalties which the Articles enacted. He was the patron of Coverdale; and to him was due that version of the English Bible known as the *Great Bible*, the first edition of which has taken his name. In 1539 he obtained the office of licenser of Bibles; and he distributed copies all over England, commanding that in every parish church whoever desired to read should have free opportunity. Whether he had any sympathy with doctrinal Protestantism is very doubtful. Foxe is a most insufficient authority for the statement that he abjured the errors of Rome on the perusal, while in Italy, of the Latin New Testament of Erasmus; it may, nevertheless, be true that he did read the New Testament, not without after results.<sup>1</sup> But his stay in Italy, while it would tend to make him the enemy of the Papacy, would equally tend to make him altogether anti-theological in his habits of thought. Distress, however, seems to have driven him to the consolations afforded by the doctrines of the old religion. In his perplexity at Escher, he is said to have betaken himself to the repetition of prayers to the Virgin; and his will, dated 1529, also goes to show that he was doctrinally no heretic. In it he orders the appointment of a priest at a salary of £6, 13s. 4d. per annum, to sing masses for his soul; for the same object he saddles a bequest to his brother-in-law and sister with £8 year, and leaves 20s. to each of the five orders of friars in London; and he directs £20 to be divided among poor householders that they may act as his beadmen. It is possible, however, that this may merely have been a politic deference to custom. Both the last speech of Cromwell, which announces his return to Catholicism, and his last prayer, which is Protestant in its tone, are of very doubtful authenticity.

The work for which Cromwell is popularly remembered, that which earned him his distinctive title of "malleus monachorum," was the abolition of the monasteries. The means he employed to accomplish this measure were characteristic. Commissioners were sent to visit the monks and nuns, and give reports of whatever irregularities could be discovered in their conduct. The juggleries of pretended miracles were exposed; rough farces in ridicule of the priests, and even of the sacraments, were allowed to be acted in place of the mysteries or miracle-plays. Every shrine was destroyed, all its costly gifts being seized by the king. The bones of St. Thomas à Becket, the hero of a signal triumph of the Papacy over the Crown, were dug up and burnt as those of a traitor; his name was removed from the service-book; his festival ordered to be neglected; every window erected to his memory ruthlessly destroyed; Cromwell even thought it worth while to publish a proclamation giving an official account of his treasons. A grant of the monastic property to the king was obtained from the Commons, who expected that the pressure of taxation would thus be relieved. And the nobles and wealthier commoners were conciliated by the chances that offered of cheap purchases of land.

For seven years Cromwell was supreme in the royal council, and supreme in all the departments of the admin-

<sup>1</sup> Dean Hook (*Lives of the Archbishops of Canterbury*, vol. 1. p. 129) asserts of Cromwell that it is "more than doubtful whether he ever understood Latin at all." But the evidence points decidedly in the opposite direction. Latimer writes to him partly in Latin (*Strype*, vol. 1. pt. 1. p. 512); in a letter to Henry VIII. he quotes in that language part of a letter from Melancthon which he had received (*Strype*, vol. 1. pt. 11. p. 408); and Coverdale addresses him in terms which could not have been applied in those days except as an insult to any man ignorant of so common an accomplishment.

istration. He was not altogether independent; every measure of importance had to be approved, and many were modified, by the king, who, moreover, often chose to act for himself in matters of the greatest moment, without even seeking his minister's advice. Yet during the period of his ministry Cromwell was certainly responsible for the general character of the government. The servant of a master who spared no life that endangered his authority or even disturbed his tranquillity, living in an age when to allow any to escape whose acts or avowed opinions were inconsistent with the policy of the Government would have been considered mere weak-minded lenity, he carried out the principles of his master, he followed the practice of his age, with stern and unvarying regularity. A position of unparalleled danger, both from traitors at home and from foreign attacks, had been assumed by the Government. The greatest promptitude and vigor were essential to safety. But during Cromwell's ministry vigor and promptitude were carried to an extreme. Laws never equalled for severity in the history of England were enacted. No opposition was allowed to endure for a moment. It is true that the blood of More and Fisher, of the marquis of Exeter, Lord Montague, and the countess of Salisbury (the last of whom, indeed, was executed ten months after the death of Cromwell) was shed in no private quarrel. Cromwell's policy had been adopted by the king; and in some cases he was no more than the king's official agent. Yet that he fully sympathized with these severities is past a doubt. The condemnation of Exeter, Montague, and the countess of Salisbury by attainder without trial was due to his suggestion. It was he, as numerous memoranda of his remain to prove, who enforced the execution of the laws of treason upon minor offenders. It was he who doomed "the Abbott Redyng to be sent down to be tried and executed at Redyng with his complycs,"—"the Abbott of Glaston to be tried at Glaston and also to be executed there with his complycs," and who ordered "that the evydens be well sortyd and the indytmnts well drawn against the said abbotts and their complycs," and "to send Gendon to the Towre to be rakkyd." He also—all attempts at persuasion proving futile—superintended the trial of the seven noble Carthusians of the Charterhouse, whom, breaking through the hitherto unbroken custom, he hanged in their clerical garb, that it might be vividly impressed upon the imagination of the people that there was no longer any law in England higher than loyalty. And that he had not visited Italy in vain is proved by a very characteristic letter<sup>1</sup> written in August, 1537, to Michael Throgmorton, once a spy of his own, now a follower of Cardinal Pole's, in which, after hinting that both master and servant may yet obtain mercy by submission, he breaks into a threat—"There may be found ways enough in Italy to rid a traitorous subject. Surely let him not think but, when justice can take no place by process of law at home, sometimes she may be enforced to take new means abroad." In private matters Cromwell's temper was equally arbitrary. Stowe's father, for instance, as the chronicler himself narrates, had his house removed upon rollers, without his consent or even knowledge, to make room for Cromwell's buildings in Throgmorton Street, London; and Foxe, partisan as he was, gives other instances.

Such a career could not fail to surround Cromwell with numerous and implacable enemies, and to afford many real grounds of accusation. His private expenditure had been splendid; he was fond of adding house to house; and two hundred poor persons were daily fed at his door. The cost of the system by which he supported his power had been enormous. Presents had been freely lavished upon men of influence, and an army of spies and agents had been maintained and generously rewarded. Such expenses his private fortune and the grants he had received from the king were quite inadequate to support; and it was easy to prove, not only that he had been in the regular habit of receiving gifts from suitors and others who desired his favor, but that much of the public money had been used by him without passing through the public treasury. He was the patron of heretics. His promises of a full treasury and relieved taxation had not been fulfilled; taxation,

indeed, had been increased; and, for that and many other reasons, his government was now extremely unpopular. The nobles, almost to a man, and most of the clergy, were his foes; but perhaps his deadliest enemy was his old companion in the service of Wolsey, Stephen Gardiner, bishop of Winchester, whom he had in vain attempted to crush under the Act of Supremacy. That part of his policy of which the accomplishment was desired by Henry was completely achieved, and Henry had no longer any interest in supporting him. He had, besides, committed a fatal mistake. His enemies had potent means in their possession for kindling against him all the fury of which Henry's nature was capable. It could be proved, beyond the possibility of doubt, that he had been long engaged in negotiations with the German Protestant princes without the knowledge of the king, whom, besides, to further his plans, he had involved in the hateful marriage with Anne of Cleves. His danger had not been unforeseen; and two years before his fall he is said to have arranged his affairs, so that his family and his servants, to whom he was always a thoughtful and generous master, should not be left unprovided for. But the blow fell unexpectedly. On the 10th of June, 1540, at the council table, the duke of Norfolk rose and accused him of high treason. Witnesses were present to swear that he had declared that he would fight in support of his opinions, "sword in hand, against the king and all others," and that in a year or two he would have so far carried out his policy that the king should no longer be able to resist it. In vain he passionately exclaimed against the absurdity of charging him with treason. His enemies had attained their revenge. In rude triumph the duke of Suffolk stripped him of his George; the earl of Southampton tore the Garter from his knee. He was immediately removed to the Tower. That night in the city the bells of the churches rang out peals of joy, bonfires blazed, and many of the citizens held exultant revel. His friend Crammer alone uttered a word in his favor. A bill of attainder, accusing him of peculation, extortion, bribery, contempt for the nobility, heresy, and treason, was passed with acclamation. Twice in vain he appealed to the king for mercy in terms of the most pitiful entreaty. Having drawn up a statement concerning Henry's relations with Anne of Cleves, adapted to facilitate her divorce, he took the opportunity to protest against the injustice and illegality of condemning him unheard, and concluded with a piteous cry for "Mercy! mercy! mercy!" And again, in a letter, which he contrived to convey to the king by the hands of his old servant, Sir Ralph Sadler, he attempted to defend himself, especially against the charge—which he well knew would be one of the most fatal brought against him—of having divulged certain of the royal secrets, and once more, in humble but passionate language, besought pardon. Henry was moved, but remained inexorable; and on the 23rd July, 1540, Thomas Cromwell was beheaded.

Original information concerning the career of Thomas Cromwell is to be found in Brewer, *Calendar of State Papers of the Reign of Henry VIII.*; Sir Henry Ellis, *Original Letters*; Reginald Pole, *Apologia ad Carolum V.*; and Strype, *Ecclesiastical Memorials*, and *Memorials of Abp. Crammer*. Foxe and Burnet, on one side, and Lingard, on the other, are partisans; and even their statements of fact are most inaccurate. (T. N. W.)

CRONSTADT, or KRONSTADT, a strongly fortified seaport town of Russia, and the great naval station of the Russian fleet in the northern seas, the seat of the Russian admiralty and of a military governor, is situated on the island of Kotlin, near the head of the Gulf of Finland, twenty miles west of St. Petersburg, of which it is the chief port, in 59° 59' 30" N. lat., and 29° 46' 30" E. long. The island of Kotlin, or Kettle (Finn., *Keisuusari*, or Rat Island) is of calcareous formation, and in general outline forms an elongated triangle, seven miles in length by about one in breadth, with its base towards St. Petersburg and the mouths of the Neva, and its apex extending obliquely seawards. The eastern or broad end is occupied by the town of Cronstadt, and shoals extend for a mile and a half from the western point of the island to the rock on which the Tolbaaken lighthouse is built. The island thus divides the approach by sea to St. Petersburg into two channels; that on the northern side is obstructed by shoals which extend across it from Kotlin to Lisi-ness on the mainland, and is only passable by vessels drawing less than 15 feet; the southern channel, the highway to the capital,

<sup>1</sup> Ellis, *Original Letters*, 2d series, vol. II. p. 121. Such entries, it must in fairness be remembered, do not imply that the cases had been prejudged; as to the facts of the charges there was no doubt.

<sup>2</sup> Froude, *History*, vol. III. p. 44-45.

is narrowed by a spit which projects from opposite Oranienbaum on the mainland, and, lying close to Cronstadt, has been strongly guarded by batteries. The town of Cronstadt is built on level ground, and is thus exposed to inundations, from one of which it suffered in 1824. Its streets are regular and well paved; the houses, with the exception of those belonging to the Government, are chiefly of one story. On the south side of the town there are three harbors—the large western or merchant harbor, capable of containing 1000 ships, the western flank of which is formed by a great mole joining the fortifications which traverse the breadth of the island on this side, the middle harbor used chiefly for fitting out and repairing vessels, and the eastern or war harbor for vessels of the Russian navy. The Peter and Catherine Canals, com-

the stream of the Burze, a tributary of the Alt, which waters it, a rich agricultural and pastoral country, though high-lying and with a cold climate, inhabited by an industrious population of Germans, Hungarians, Wallachs, Armenians, and Greeks. The town stands in a narrow valley, shut in by mountains, and consists of a well-built inner town, dating from the 13th century, and surrounded by walls, with suburbs named Altstadt, Blumenau, and Bulgarei. Cronstadt is the most populous centre of Transylvania: three-fifths of the people of the inner town are Germans; the suburbs are chiefly inhabited by Magyar Szeklers and by Wallachs. Its principal buildings are the Gothic Protestant church, the finest in the principality, other Lutheran churches, a Gothic Catholic church, the Rathhaus with high tower, and a market-house built in 1545. On a height over the town rises a strong old castle of the German knights. After Hermannstadt this is the most important manufacturing and trading town of Transylvania. Iron and copper-working, paper manufacture, and printing (Cronstadt was the first place in Transylvania at which a printing-press was established), wax-bleaching, turkey-red dyeing, wool-spinning, linen-weaving, leather and bottle-making are its chief industries, and it possesses at least sixty large trading-houses. Its communications are kept up by a railway uniting it with the Hungarian system, and by passes over the mountains into Wallachia. The nearest of these passes are those of Tömösch, nine miles south, with a summit elevation of 3645 feet, and that which leads through the village of Törzburg, 20 miles south-west of the town. Population of commune (1869), 27,766.

CROQUET, Fr. from *croc*, a crook, or crooked stick (Du Cange, *Glossarium*). The game has been derived by some writers from *paille-maille* (mall), which was played in Languedoc at least as early as the 13th century. Malt was fashionable in England in the time of the Stuarts. It was played with a ball (*pila*) and a mallet, very similar to the mallets now in use, and with two hoops, or a hoop and a peg, the game being won by the player who ran the hoop or hoops and touched the peg under certain conditions in the fewest number of strokes. Croquet certainly has some resemblance to *paille-maille*, played with more hoops and more balls.

It is said that the game was brought to Ireland from the south of France by the eldest daughter of Sir Edward Macnaughten some twenty-five years ago; but Mr. Dickson, an ivory-turner of Gracechurch Street, London, remembers having made a set of croquet implements for Ireland over forty years ago. At all events, the re-introduction of the game by Miss Macnaughten, under whose auspices it was first played on the lawn of the late Lord Lonsdale in 1852, marks the time when it became of sufficient importance to find a regular maker of croquet implements in London. Shortly afterwards, in 1856, Mr. Jaques, of Hatton Garden, London, saw the game in Ireland, and commenced manufacturing it in England, where it soon became very popular.

One of the first symptoms that the game had taken root was the playing of a public match on the bowling-green at Evesham, in Worcestershire, in 1867. In 1868 the first all-comers' meeting was held on the cricket-ground at Moreton-in-Marsh. In the same year the All England Croquet Club was formed, and on the grounds of this club at Wimbledon the annual contest for the championship takes place. The laws of the game, which are used in all public matches, were settled by a conference of delegates from the principal croquet clubs in 1869, 1870, and 1873 (*Conference Laws*, De la Rue & Co.). In addition to these, laws for the regulation of prize-meetings (Horace Cox) were issued by the A. E. C. C., which are the authority for the management of such meetings. According to these laws, match-games are played on a ground measuring 40 yards by 30, with four balls, two forming a side against the other two,—one player owning two balls, or four players each taking one ball. In match-play the hoops and pegs are set and run as in the diagram (fig. 1).

The hoops are of  $\frac{3}{4}$ -inch round iron, painted blue, and are 4 inches in width (inside measurement) for handicaps and for ladies and ordinary matches, and  $3\frac{1}{2}$  inches wide, steel braced, with oak sockets, for championship matches for gentlemen. They and the pegs are thus named in order—i. e., in the order in which they are to be run or made. First hoop, second, third; three to peg, two to peg, one to

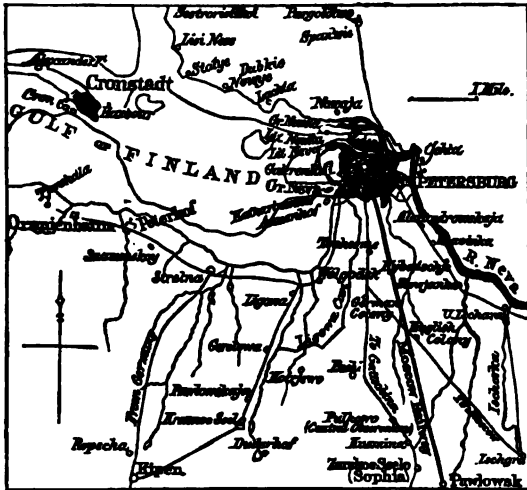

Environs of St. Petersburg, showing position of Cronstadt.

municating with the merchant and middle harbors, traverse the town. Between them stood the old Italian palace of Prince Menschikoff—the site of which is now occupied by a large building used as a school for pilots. Among other public buildings may be mentioned the extensive naval hospital, the British seamen's hospital, established in 1867, the civic hospital, admiralty, arsenal, dockyards and foundries, custom-house, barracks, exchange, several Greek churches, a Lutheran church, and English and Roman Catholic chapels. Defending the navigable passages are Forts Alexander, Risbank, Constantine, Peter the Great, Menschikoff, and Cronslott, all built of granite and armed with heavy guns. During the Russian war of 1854–55 Cronstadt was considered impregnable. Almost all vessels bound for St. Petersburg touch at Cronstadt, and those drawing more than 8 to 10 feet of water load and unload here, the goods being conveyed to and from the capital in lighters. The port is ice-bound during the winter months from November till April; but in other months about 3000 vessels enter and clear. There is regular steam communication with St. Petersburg, Peterhof and Oranienbaum, Revel, Helsingfors, Stockholm, Stettin, Lubeck, and Havre. The exports consist chiefly of tallow, corn, hemp, and flax, brought from the surrounding districts of the mainland. A very large proportion of the inhabitants are sailors, and large numbers of artisans are employed in the dockyards. The ironclad turret-ship "Peter the Great" (9600 tons) and the "Duke of Edinburgh" were built at Cronstadt in 1874–75. Cronstadt was founded in 1710 by Peter the Great, who took the island of Kotlin from the Swedes in 1703. The population at the census of 1867 was 45,115, but this varies very considerably at different times of the year, the town being very full in summer and partially deserted in winter.

CRONSTADT, KRONSTADT, or KRUNEN (Romanic *Brasiow*, Magyar, *Brassó*), a town of Transylvania, Austria, situated on the slope of the Transylvanian Alps, near the south-eastern corner of the principality, at an elevation of 1830 feet above the sea. It is the capital of a district of the same name, also known as Burzenland, from

peg; turning peg; first, second, and third back; three, two, and one to go out or last hoop; winning peg.

The height of the hoops and pegs and various minor matters have been also settled by the same authorities. The balls are of boxwood,  $3\frac{1}{2}$  inches in diameter, and should weigh not less than  $14\frac{1}{2}$  oz. There is no restriction as to the size, weight, number, or material of the mallets employed; in striking, the cue and mace strokes are not allowed, and the head of the mallet only must be used. The most approved mallets have boxwood heads and ash handles; they weigh from 3 lb to 4 lb, and are from 32 inches to 35 inches in length. The patterns vary considerably.

In playing the game, the objects are to make all the points (hoops and pegs) of the balls belonging to one side, in the order shown in the diagram, and to prevent the adversaries from doing the same. The side that first succeeds in making all its points in order wins the game. The striker is entitled to another stroke, or to continue his turn so long as he succeeds in making his next point, or in causing his ball by a stroke of the mallet to hit another ball (called making a roquet), when he must place his ball in contact with the one roqueted, and striking his own ball with the mallet he must move the two balls which are in contact, sending them in any directions he pleases, called taking croquet. If in his stroke after taking croquet he hits another ball or makes his next point, he similarly contin-

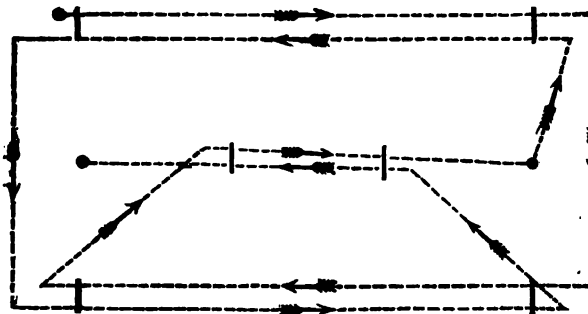

FIG. 1.—Croquet Ground—Setting of Hoops.

*Distances on a full-sized ground.*—Pegs in centre line of ground, 8 yards from nearest boundary. Hoops up centre line of ground 8 yards apart and 8 yards from pegs. Corner hoops 7 yards from centre and in a line with pegs. Starting spot 1 foot from left-hand corner hoop and opposite its centre.

ues until he fails to do either, when it is his adversary's turn. Each ball can only be roqueted once during each turn, unless a point in order is made, when each ball can again be roqueted as at first. This rule does not apply to the winning peg, as when that is hit in order the ball is out of the game.

The striker should stand with the feet about 15 inches apart, with the toe of the right foot at right angles to the line of aim, the other being somewhat turned out. The body should be inclined over the ball, so that the player can look down upon it. The mallet should be grasped with both hands, and the striking face placed close to the ball, so that a line drawn through the mallet head and centre of the ball gives the line of aim. The striker, having taken his aim, should keep his eye on his own ball, and should then lift the mallet, and strike the ball quietly and without hurry, in the line of aim. For gentle strokes the wrist is mainly used; harder strokes are played more from the arm and shoulder.

When able to make a roquet at several yards with tolerable certainty, the learner should next practise rushing, i. e., roqueting with such force as to move the ball aimed at some distance, and cutting, which is a rush played fine instead of full. To avoid accidentally jumping over in playing rushes, care must be taken not to hit down on the striker's ball; this is effected by carrying the mallet up towards the left shoulder after striking,—just the stroke that would be called badly hit at cricket.

When able to rush, the strokes made in taking croquet, viz., splitting, taking off, rolling, passing, and stopping, should be practised.

The split, which sends the two balls in different given

directions, may be made to a certainty by dividing the angle, as in the half push at billiards. Thus, if the striker wishes to croquet his own ball in the direction A (fig. 2), and the other ball in the direction B, he must aim in the direction C, and strike, not push his ball.

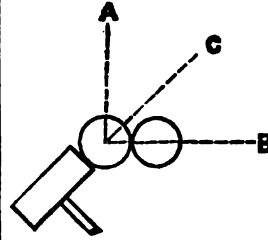

FIG. 2.—Illustrating the "split" at croquet.

other ball to C. When taking off from the side of the ball furthest from the striker, the aim must be slightly to the left of the line of aim.

*Rolling croquet*, in which the balls are sent together in nearly the same line, is made by trailing the mallet after the balls as soon as the stroke or tap is made. Care must be taken not to make a second tap, or the stroke is foul.

*Passing croquet* is a sort of roll. The front ball must be placed about 30 degrees out of the line along which it is intended to pass the striker's ball, in order to avoid a kiss, and, after the stroke, the mallet must remain in contact with the striker's ball, and its rate of going must be accelerated by a push. If the ball is hit twice the stroke is foul.

The stop stroke is made by means of a sharp clean tap, the mallet being arrested in its onward course as soon as it has struck the ball. For stop strokes, where it is desired to move the striker's ball very little and to send the other ball a considerable distance, a light mallet (called a stop mallet) is required.

In addition to the mastery of these strokes and also of the jump stroke, which is played by striking down on the ball, and is very useful for running narrow hoops at an angle, strength has to be learned in order to obtain position. Judging strength is mainly a matter of practice.

When the above strokes can be played with tolerable certainty, they should be made use of in practising breaks. A break is made when two or more points are scored in order. To practise the break, place the striker's ball on the starting spot (see diagram of setting); place a ball several feet on the other side of the first hoop, a ball near the second hoop, and one in the middle of the ground. Make the first hoop, and then roquet the ball placed near. Drive this ball by a medium roll near the third hoop, and leave the striker's ball near the ball in the middle of the ground. Roquet this ball and take off to the second hoop. Use the ball placed there to make that hoop; then roquet it after running the hoop and send it to the hoop three to peg, going to the middle of the ground with the striker's ball. Take off to the third hoop, make it with the ball



FIG. 3.—Illustrating the "take off" at croquet.

placed there to help, and then send it to the hoop one to peg, going with the striker's ball to the one in the middle of the ground. Then rush it to hoop two to peg, and take off to the hoop three to peg, or failing a rush, roll or split it to two to peg, and the striker's ball to three to peg. Make that hoop, and split, roll, or rush the ball placed there to help to hoop second back, going to ball placed near hoop two to peg

By judicious repetition of these or similar tactics there is no limit to the number of points that can be made. The practice should be continued until, on good ground, with 4-inch hoops and three balls to help, the break of fourteen points becomes a feat easy of accomplishment.

In order to become an adept at the game, judgment must be added to mere execution. Judgment cannot be taught in writing, further than by laying down certain principles of play. They are briefly as under:—

1. Keep the partner balls together, the adverse balls apart.

It is clear, from the remarks on the break, that at most one or two points can be made without a ball or balls to help; hence going to the next hoop in order is very poor tactics, if we regard the advantages gained by helping partner by keeping near him, and by separating the adversaries, or at least giving partner the opportunity of separating them.

2. When out of the break, it is often a nice point whether to go to partner, or to finesse to the boundary, or to take a shot at the opponents. As a rule a long shot should not be attempted if failure would leave the ball in the adversary's game, where it may be brought into play to help him in his break. Also the question often arises whether to separate the adversaries at once or to continue the break. The answers to these questions must depend on the striker's estimate of his ability and of his adversary's ability, and on the state of the game.

The principal exception to playing to partner's ball is when the ball played with is a rover and the adversary is also a rover, and has a fair probability of making a roquet next time. For, under these circumstances, the opponent will take off to the two adverse balls and rush the rover up to the winning peg, and very probably peg it out.

3. Keep the last player in your game.

The object of this is to prevent the adversaries from combining at their next stroke. It compels the next player either to take an uncertain shot which may bring him into the game, or to finesse.

The last player may be kept, either by sending him to partner during or at the end of the turn, or by putting him near partner's hoop and then going to partner.

The striker should, if the opportunity offers during his break, pick up the last player for the reasons already given.

When sending the next player away, choose such part of the ground to send him that if he takes a shot it brings him into partner's game.

4. Make the break with two or three balls to help, in preference to one.

The reason is obvious to those who have practised the break. Skilful players endeavor to keep all the balls in the break; but the safe plan for novices is to dismiss the next player and to make the break with two balls to help.

5. When in the break do not play uncertain strokes on the next player.

For any mistake made then gives the break to the adversary. It is, however, a matter of judgment how far risks may be run, varying with the amount of skill and nerve of the striker.

When partner's ball is a long way off, using the last player to help is just as dangerous as using the next player.

6. At the end of the break play partner's game.

This is accomplished by leaving him the last player's ball to help and going to his hoop, or *vice versa*, or by leaving him a rush to his hoop and a ball at his next hoop but one, and in several other ways, which will be apparent to any thoughtful player.

See Walter Jones Whitmore, *Croquet Tactics*, London, 1868; Arthur Lillie, *The Book of Croquet*, London, 1872; R. C. A. Prier, M. D., *Croquet Notes*, London, 1872; James Dunbar Heath, *The Complete Croquet Player*, London, 1874. (H. J.)

**CROSS** (Latin, *crux*; Greek, *κρῶς*). In its simplest aspect, a figure produced by the intersection of two lines at right angles, the cross in its primary signification is understood to denote an instrument for inflicting capital punishment, or a gibbet formed of two pieces of wood fixed together cross-wise without any reference to their relative proportions. Metaphorically, the term cross implies death thus inflicted, and so it becomes synonymous with crucifixion, and is often used to denote any exceptionally severe pain or heavy trial. The manner in which Christ suffered has caused the cross, as the instrument for crucifixion, either to be associated directly or indirectly with his death, or to be regarded as having a reference to that fundamental fact of Christian history. And the same fact may be assumed to be symbolized by the cross in every modification of form and variety of adornment in use, for whatsoever purpose, throughout Christendom.

The ancient practice of execution by hanging criminals on trees apparently led to the adoption of crosses constructed for a similar purpose. Hence, hanging from some part of a tree and the being fixed to a cross appear to have

conveyed to the Romans the same import; accordingly the expressions *infelix arbor* and *infelix lignum*, each of which may consistently be rendered "the accursed tree," alike denoted crucifixion (Cicero, *Pro Rabir.*, 3; Seneca, *Ep.*, 101; Tertull., *Ap.* viii. 16).

The barbarous execution by crucifixion, of which traces are to be found from remote times among the nations of the East and North, was carried into effect in two forms—(1) when the sufferer was left to perish bound to a tree or an upright stake, sometimes after being impaled; and (2) when by nails driven through his hands and feet, his limbs also sometimes further secured by cords, the sufferer was fixed with outstretched arms to a cross having a horizontal bar as well as a vertical stake. The terms employed in the Gospel narratives render it certain that Christ thus was crucified. According to Lipsius (*De Cruce*, i. 5-9) and Greiser (*De Cruce Christi*, vol. i. c. 1), a single upright stake was distinguished as *crux simplex*, while to the actual cross, formed of two pieces of wood, the name *crux composita* or *compacta* was applied. The *crux composita*, compound cross, or "cross" properly so called, appears under the following modifications of form:—*Crux immixta* or *capitata*, formed as in this figure,  $\dagger$ ; *crux commissa* or *ansata*, thus formed,  $\ddagger$ ; and *crux decussata*, when the cruciform figure is set diagonally after the manner of the Roman letter X. It was upon a *crux immixta* that Christ is generally believed to have died. This cross is a "Latin cross," when the shaft below the transverse bar is longer than that part which rises above the transverse bar, as  $\dagger$ ; and when the four limbs are of equal length, as in  $\dagger$ , it is a "Greek cross." The  $\times$ , or *crux decussata*, is further distinguished as the "St. Andrew's cross," in consequence of the apostle Andrew, according to a tradition, having been crucified on a cross of this form. The *crux commissa*,  $\ddagger$ , is also entitled the "Cross Tau," from the Greek capital T; and in the Middle Ages it was distinguished as the "cross of St. Anthony."

The gratuitous barbarity of scourging as a prelude to crucifixion, and of compelling the condemned sufferer to carry his cross, or one of the parts of it, to the place of execution, were but too strictly in keeping with the cruel character of the Romans. Crucifixion with the head downwards, of which Seneca speaks (*Consolat. ad Marc.*, c. xx.), the mode in which St. Peter is said to have chosen to suffer, was a refinement on the barbarity of the cross no less consistent with Roman cruelty.

The well-known legend of the "Invention of the Cross" (commemorated on the 3d of May), or the finding of the actual cross on which Christ had suffered, by the Empress Helena, the mother of Constantine the Great, rests on the concurrent testimony of four Byzantine ecclesiastical historians (Rufinus, i. 7; Socrates, i. 13; Theodoret, i. 18; and Sozomen, ii. 1), who all wrote between 75 and 100 years after the incidents related, and whose story was accepted and supported by Cyril of Jerusalem, Ambrose, and Chrysostom (see also Tillemont, *Mém. Écclésiast.*, the chapter on Helena, and Jortin's *Remarks*, vol. iii.). The story is to the effect that the empress, when visiting the scenes hallowed by the Saviour's ministry and sufferings, in the seventy-ninth year of her age (326), was guided to the site of Calvary by an aged Jew who had treasured those local traditions which the anti-Christian animosity of the heathen conquerors of Jerusalem had not been able to obliterate. On excavation at a considerable depth three crosses were found; and with them was the title placed by Pilate's command on the cross of Christ, lying apart by itself. The cross of Christ was identified by a miracle, one only of the three crosses found having proved to be endowed with the power of instantaneous healing conveyed by a touch. This test by miracle was applied at the suggestion of Macarius, bishop of Jerusalem; and its result, of course, was held to be conclusive. Having built a church over the site of the "Invention," where she deposited the greater part of the supposed real cross, Helena took the remainder to Byzantium, whence a portion of it was sent by Constantine to Rome, where it was placed in the church of Santa Croce in Gerusalemme, built expressly to receive so precious a relic. A festival to commemorate the discovery of this relic soon was established; pilgrimages, undertaken in order to obtain a sight of it, next followed; then fragments of the sacred wood were sold at high prices to wealthy votaries; and, after a while, in order

to meet the exigences of the case, the Roman ecclesiastical authorities assured the increasing crowds of anxious purchasers that the wood, if no longer working miracles of healing, exercised a power of miraculous self-multiplication, *ut detrimenta non sentiret, et quasi intacta permaneret* (Paulinus, *Ep. xi. ad Lev.*). In the 13th century, what remained of the portion of the cross taken by Helena to Constantinople is said to have been removed, during the reign of St. Louis, to Paris, and to be still preserved in the Sainte Chapelle.

After the capture of Jerusalem by the Persians, in 614, the remains of the cross were taken to his capital by Chosroes II.; but having been recovered by Heraclius (628), they were brought by him to Constantinople, and afterwards to their former resting-place in Jerusalem, where their reappearance was said to be hailed with a miraculous welcome. In after times this restoration was commemorated by the festival of the "Exaltation of the Cross," held on the 14th of September. The transient revival of the Christian power in Jerusalem was speedily followed (637) by the conquest of the Holy City by the Saracens, by whom the cross relic may be assumed to have been destroyed; at all events, after the Saracen conquest nothing more is heard of that relic in connection with Jerusalem. A subterranean chapel, however, said to have been built upon the site of Helena's church, and which bears the title of the "Chapel of the Invention of the Cross," still exists, and is connected by a flight of steps with the so-called Church of the Holy Sepulchre.

The piece of wood supposed to have been inscribed with the title placed upon the cross of Christ, and found with the three crosses by Helena, and retaining traces of Hebrew and Roman letters, is said to be still preserved at Rome, whither it was sent by Constantine. After having been long lost to sight and apparently to remembrance also, this relic—so goes its history—was accidentally discovered in the leaden chest in which it had been deposited by Constantine; and both the fact of its discovery and the genuineness of the relic itself were attested by a Bull of Pope Alexander III. The earliest writers are silent as to the kind of wood of which the title-board and also the three crosses were made; but a tradition, which notwithstanding its extreme improbability may be traced to a very early era, represents the true cross to have been formed either of cypress, pine, and cedar, or of cedar, cypress, palm, and olive. (See facsimile reproduction, 1863, 4to, by J. P. Berjeau, of the *History of the Holy Cross*, originally printed by J. Veldeuer in 1483.)

In connection with the discovery of the cross itself and its attendant title, the nails used at the crucifixion, and asserted to have been included in the "Invention" by Helena, have a legendary history of their own. One of the original four is declared to have been thrown by the Empress herself into the Adriatic when agitated by a violent storm, with the effect of producing an instantaneous calm. A second nail, after having been placed either in his crown or in his helm by Constantine, is said to have been found in a mutilated state in the church of Santa Croce. The Duomo of Milan claims the possession of the third nail, and Treves that of the fourth. It must be added that some early traditions limit the number of the nails to three; while, on the other hand, certain writers have raised the number of the nails as high as fourteen, for the safe keeping of each one of which places have been found. In the illustrations of the crucifixion given by Lady Eastlake (*History of our Lord*, vol. ii.), sometimes we find a single nail, and at other times two nails, used for the feet. That accomplished lady seems to consider the separation of the feet with a nail for each to be characteristic of the earlier conceptions of the crucifixion, which present Christ after He had been nailed on the cross as still "alive and erect, and apparently elate; His feet always separate, and with two nails upon the footboard, or *suppedaneum* (a Greek feature), to which they were attached; the arms at right angles with the body, the hands straight, the eyes open." The *suppedaneum* is supposed to have been a piece of wood projecting slightly from the shaft of the cross beneath the feet of the sufferer, with a view to afford some support to his body. It is in the later representations that one of Christ's feet appear placed over the other, the ankles being crossed, when a single nail pierces both the feet, or both the ankles. For many curious particulars concerning representations of the cruci-

fixion and its attendant incidents in early and mediæval art, readers are referred to Lady Eastlake's volume; also to Mrs. Jameson's *Legends of the Madonna and Sacred and Legendary Art*. Early writers all incline to the more probable opinion that Christ was attached to the cross while it lay on the ground; Bonaventura, however (born 1221), states that he ascended a ladder, and was nailed to the cross standing, after the cross itself had been erected and fixed in its position. "The impress of each opinion is seen in art," writes Lady Eastlake (*Hist. of our Lord*, ii. pp. 130-133), "that of our Lord ascending the ladder on the cross being the earliest, that of His extending himself on the ground being the most frequent." A remarkable example of the latter opinion occurs in the sculpture of one of the bosses in the vaulting of the twelfth bay of the nave of Norwich Cathedral, where the figure of Christ is further represented as having the extremities of the limbs drawn by cords to the shaft and the ends of the transverse beam of the cross, as a preliminary to the driving the nails. The cross, when raised and fixed erect, doubtless elevated the sufferer to no unnecessary height, his feet then probably being not more than 18 or 20 inches above the surface of the ground. In comparatively late mediæval heraldry the cross, with the other instruments connected with crucifixion—as the hammer, nails, ladder, crown of thorns, spear, hyssop, scourge, seamless coat, and dice—were often blazoned on shields introduced in Gothic edifices and upon monumental memorials, as "Symbols of the Passion."

The name *crucifix* is applied to a Latin cross, in size either small or large, to which a human figure, designed to represent the body of Christ when suffering crucifixion, is affixed.

As a symbol of the Christian faith at once pre-eminently characteristic and significant, the cross in various modifications of its form would naturally be adopted on very many occasions, and used in a diversity of ways throughout the Christian world. Scarcely less natural also was it that from an early era Christian writers should have treated the symbolism of the cross with fanciful and even extravagant refinement, and endowed it with mysterious attributes; while superstition, which as time advanced threw so baneful a shadow over Christianity itself, would not fail to deal after its own fashion with the sign of the cross. It is curious, on the other hand, that a cruciform device having diverse significations should have occupied a prominent position among the many sacred and mystic figures and symbols connected with the mythologies of heathen antiquity. Such certainly was the case in Egypt, Assyria, Persia, and India, and also among the Scandinavian races of the North. Possibly the cross figure sometimes may have found its way among heathen symbols in early Christian times; and, again, the presence of the great symbol of Christianity in such an alliance on other occasions may have suggested an early Christian influence that never had any real existence. In the Middle Ages the cross sign was universally held to be the special and distinctive symbol of Christianity, as, to the present day, the cross and the crescent are symbols which distinguish the faith of the Christian from that of the Moslem.

In the great art of Christian architecture, and throughout the entire range of mediæval decorative art, the cross sign has exercised a most powerful influence. The ground on which the grandest churches, as well as many others of a less aspiring order were erected, was made to assume a cruciform plan, so that the very walls from their foundations upwards might carry with them, as they rose, the image of the sacred sign, to receive its crowning figure displayed in the ridge-lines of their roofs. Crosses, exhibiting an endless variety of form, proportion, and adornment, surmounted the loftiest and most important architectural members of cathedrals and churches; and here and there upon the masonry they attested the consecration for Christian worship of the buildings which bore them; five crosses, in like manner (their number determined by the five wounds of the crucified Christ), gave similar witness to the consecration of every altar slab; and monumental stones of every kind in the pavements of the churches repeated the same great sign, to proclaim that each one of the dead who rested there had died in the faith. With the triumph of Christianity, the cross at once was recognized as a universal symbol of the highest dignity and honor. It was made of the most precious materials, enriched with the most costly



gems, and adorned with most exquisite art. The cross became the proudest ensign upon royal diadems; and it gave both their form and their name to the noblest insignia of knightly rank. The cross crowned the sceptres of princes; and the greatest warriors were proud to see the cross as well in the hilts of their swords as in the banners under which they fought. In private life also the cross was held in corresponding estimation; and, accordingly, the most beautiful and most highly prized personal ornaments appeared in some cruciform type. Thus was art taught to aid in realizing the enthusiastic sentiment of Justin Martyr, when he said (*Apol. i. 72*)—"The sign of the cross is impressed upon the whole of nature. There is hardly a handicraftsman, also, but uses the figure of it among the implements of his industry. It forms a part of man himself, as may be seen when he raises his hands in prayer."

The simplest treatment of the plain rectangular cross (fig. 1), with a view to its enrichment, may be assumed to have consisted either in expanding each limb from the point of their common intersection, and so forming a "Maltese cross" (fig. 2), or by giving some ornamentation to each limb at its extremity (fig. 3). The expanded cross, when of Greek proportions (fig. 2), would readily suggest having its extremities bounded by curved lines, and then the inclosure of such a cross within a circle would naturally follow (fig. 4). The next step would be either to place a circular disc upon the cross, as at Iona (fig. 5), or to extend the limbs of the cross beyond the circle, as in fig. 10, the west gable cross of Washburn Church in Worcestershire, or in fig. 6, also at Iona. In any of these cases the addition of a shaft would produce a Latin cross. The circular band, again, thus associated with a cross would naturally lead to the introduction of decorative accessories specially connected with itself, as in fig. 11, from the gable cross of the nave of the church at Castle-acre, Norfolk. The com-

monial crosses, usually consisting of a tall shaft raised on steps and often much enriched, and either surmounted by a bold cruciform figure, or having a canopied head with statuettes and a cross finial; and *wayside crosses*, in their general character resembling those erected in churchyards, designed to commemorate some memorable incident on the spot



Fig. 10.

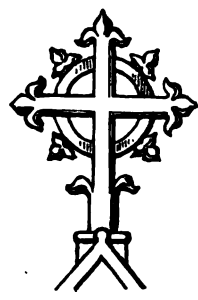

Fig. 11.

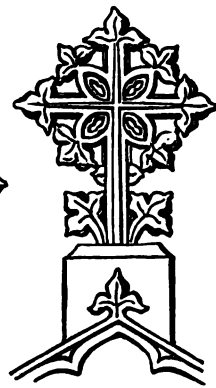
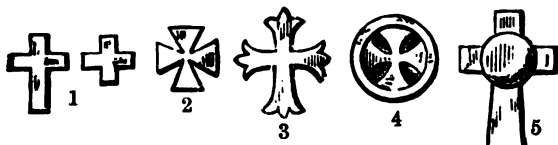

Fig. 12.

Figs. 10-12.—Finial Crosses.



Figs. 1-6.—Varieties of Cross.

Combination of an erect cross with a diagonal one would be another modification, producing a cross of eight points, easy of attainment, and one that in its turn would suggest and lead to a variety of further modifications of construction, with many diversified enrichments. From known examples still in existence, and in fair if not perfect preservation, it is evident that the mediæval artists delighted to expatiate in the wide field opened out before them for designing the cross sign under fresh conditions of both form and decoration. They wrought leaves and flowers into cruciform figures, and adorned their crosses with foliage in

where it took place. Many of these crosses still exist in different parts of England, and some are of very early date; the Irish crosses, also, are eminently curious and interesting. Upright architectural crosses of memorial, erected with a view to their being expressly associated with sepulchral commemoration, may be considered to form a distinct class. Such are the beautiful and justly famous *Eleanor crosses*, originally nine in number,—at Lincoln, Northampton, Stony Stratford, Woburn, Dunstable, St. Alban's, Waltham, and Cheap and Charing in London. From the accounts of the executors of Queen Eleanor it appears that the whole of these crosses, designed to mark the places where the funeral procession of the first Edward's first consort halted for rest, were executed and erected between 1291 and 1294. The cross at Geddington, generally considered one of the "Eleanor" series, is not recorded in the roll; and of the nine therein specified two only now are standing,—those at Northampton and Waltham.

*Monumental crosses* upon stone coffin lids or sepulchral slabs, which in England first appear at the close of the 11th century, and from that period gradually become general, are executed either in low relief or by incised lines; in some instances the two methods of treatment are combined. Occasionally repeated in the same example, the cross sign, exhibiting a truly wonderful variety of design, at first appears alone, the shaft or stem almost always considerably elongated, and often enriched with sprouting foliage, or some other ornamentation. Fig. 13, from Stradsett church, Norfolk, and fig. 14, from Bosbury, Herefordshire, are characteristic examples of enriched monumental crosses. When the elongated shaft of a cross on a slab rises from two or more steps at its base, it is said to be a *Calvary cross*. After a while, a brief inscription is found to have been added. Then the further addition appears to have been introduced of some device or figure, which might symbolize the profession, occupation, rank, or office of the person commemorated,—such as a pastoral staff for a prelate, a chalice for a priest, a sword for a knight, a trumpet for a trumpeter, a bell for a bell-founder, a hammer and pincers with a sword for an armorer, a horse-shoe and hammer for a smith, etc. In a few instances, a knightly sword placed erect in the centre of a slab either acts as the shaft of a cross, or with its cruciform guard to the hilt the figure of the weapon itself becomes the cross symbol. There are also occasionally found early monumental stones, upon which both a cross and the head or bust and the feet of a human figure are so treated as to form a single composition. Kneeling figures, again, are sometimes introduced either at the foot of a monumental cross, or on each side of the shaft of such a cross; and full length figures, and sometimes half figures, in other examples appear placed within the expanded floriated heads of monumental crosses. (See Walter's and Boutell's *Monumental Brasses*; Boutell's *Christian Monuments*; and Cutts's *Manual of Sepulchral Slabs*.)



Fig. 6.



Fig. 7.



Fig. 8.

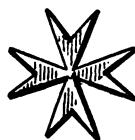

Fig. 9.

every degree of richness. They made the cross both simple and compound; they introduced it in combination with other figures and devices; and they composed it from figures and devices, each one of them having some definite motive or significance of its own.

*Market and other Crosses.*—In addition to acting as a finial to gables, as in figs. 10 and 11, and in fig. 12 from the east gable of the nave of Hethersett Church in Norfolk, and also to various other architectural members of edifices, the symbol which surmounted them gave its name in the Middle Ages to certain structures well known as "crosses." These include *market-place crosses*, open arched and vaulted structures, sometimes of considerable size; *churchyard*

In the heraldry of the Middle Ages the cross, its form and enrichment treated in many ways, as a charge is second to none in rank and estimation (see HERALDRY). The English cross of St. George is a plain red cross set erect on a white ground; the Scottish cross of St. Andrew is a plain diagonal white cross on a blue ground; and the Irish cross of St. Patrick is a plain diagonal red cross on a white ground. The "Tau" cross, which occasionally is found in English heraldry, is blazoned as in fig. 7. Another form of cross, shown in fig. 8, bears the name of "Fylfot," and

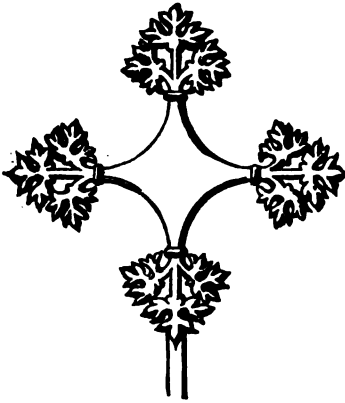

Fig. 13.  
Figs. 13 and 14.—Monumental Crosses.

is one of the most singular, as it is one of the most ancient, of the many forms and modifications of this symbol. Considered by some writers to be composed of four Greek capital "Gammas" conjoined, this mystic figure, which was in high favor with early secret societies, sometimes was called "Gammadion." In the mythology of the North, again, it was held to symbolize "Mjolnir," the formidable cross-formed hammer of Thor, and is accordingly known by the third title of "Thor's hammer." It occurs in both Scandinavian and Roman relics; and it was in frequent use as a decorative device in the Middle Ages, especially as a mark upon bells. On the monument of Bishop Broncomb, 1281, in Exeter Cathedral, the fylfot has its limbs alternately yellow and red.

**Initial crosses** were placed in the Middle Ages at the commencement of inscriptions, and occupied a similar position in written documents of all kinds. The initial cross of the inscription to Abbot Thomas Delamere, upon his brass at St. Alban's (1360), is an interesting example, since it is formed of a delicate erect cross floriated at its extremities, which surmounts a bolder diagonal cross, or cross saltire, the armorial ensign of the abbey of St. Alban.

**Knightly crosses.**—The cross worn, as distinctive of their order, by the Knights Templars, was a red cross of eight points (fig. 9) upon white. The cross of the Knights Hospitalers, or Knights of St. John, was of similar form, but white and worn on a black ground; from the years 1278 and 1289, however, when engaged with military duties, the Knights of St. John wore a plain straight white cross upon red. (For the crosses of the monastic orders, see COSTUME, p. 410.) The cross of the Danish order of the Dannebrog (fig. 15), a white cross surmounting a red one, with the royal crown, the cipher of reigning sovereign, and the motto "For God and the King," is a characteristic example of the use of the great Christian symbol in the insignia of the knighthood of the present day. In the highest class of British insignia the cross appears on the circlets only of the imperial crown and of the coronets of princes and princesses of the blood royal.

A **pectoral cross**, formed of rich and costly materials, was



Fig. 15.—Cross of the Dannebrog.

worn at times by ecclesiastics of the highest rank. In the East pectoral crosses were worn, suspended about the neck and resting on the breast, as both imperial and episcopal ornaments. Characteristic examples of the *pectorale* occur in the effigies of Bishops Kilkenny, 1255, at Ely; Giffard, 1301, at Worcester; and Langton, 1321, at Lichfield. This same term "*pectorale*" may consistently be applied to all crosses, worn under similar conditions by personages of exalted rank. Of such crosses a specimen of singular interest and great beauty, now well known from fac-simile reproductions of it as the "Dagmar cross" (fig. 16 shows both sides of it), was found about 1690 (when her tomb was opened), lying on the breast of the remains of Dagmar, "the bright day," the queen of Waldemar II., king of Denmark, who died in 1213. This jewel, certainly of Byzantine design and workmanship, is of gold, enamelled, having on one side a crucifix, and on the other side portraits of Christ (in the centre), of St. Basil, St. John Chrysostom, St. Mary the Virgin, and St. John the Apostle-Evangelist.

**Crosier** or **Crosier** is the title given to the official staff of an archbishop, which has a cross-head, and so is distinguished from the "pastoral staff" of bishops and abbots, the head of which is curved and resembles that of a shepherd's crook. Examples of the crosier occur in the brasses to Archbishops de Waldeby, 1397, in Westminster Abbey, and Cranley, 1417, in New College Chapel, Oxford; the latter example has a crucifix for its head, which is the case also in a remarkable drawing of an archbishop in the *Lambeth Psalter* (c. 1300) in the library at Lambeth. The fine effigy of Archbishop Walter de Gray at York, 1255, has a crook-head staff of great beauty; in his brass, too, at Chigwell, Essex, Archbishop Harnett, 1631, is represented, not with a crosier, but with a pastoral staff. Instead of having crook-heads, the crosiers of the prelates of the Greek Church have heads of the "Tau" form, and the extremities of the horizontal bar are curved upwards. The staff of a patriarch has a double cross-head; and the head of the pontifical staff of the Pope has a triple cross. Good examples of the pastoral staves of bishops



Fig. 16.—Dagmar Cross.

and abbots abound in their monumental effigies, of which one of the most admirable is in the brass to Abbot Delamere (c. 1360), at St. Alban's. The magnificent enamelled staff of Bishop William of Wykeham, as is well known, is still preserved at New College, Oxford. (C. B.)

**CROSSBILL** (Fr. *Bec-croisé*; Germ. *Kreuzschnabel*), the name given to a genus of birds belonging to the family *Fringillidae*, or Finches, from the unique peculiarity they possess among the whole class of having the horny sheaths of the bill crossing one another obliquely,<sup>1</sup> whence the appellation *Loxia* (*λοξός, obliquus*), conferred by Gesner on the group and continued by Linnaeus. At first sight this singular structure appears so like a deformity that writers have not been wanting to account it such,<sup>2</sup> ignorant of its

<sup>1</sup> As an accidental malformation, however, the peculiarity has been many times observed in other groups of birds, and especially in the Crows (*Corvidae*). Such cases may be well compared to the monstrosity often seen in Rabbits and other members of the Order *Girres*, wherein the incisor teeth grow to inordinate length.

<sup>2</sup> The special animosity of De Buffon on this point may perhaps be

being a piece of mechanism most beautifully adapted to the habits of the bird, enabling it to extract with the greatest ease, from fir-cones or fleshy fruits, the seeds which form its usual and almost invariable food. Its mode of using this unique instrument seems to have been first described by Townson (*Tracts on Nat. Hist.*, p. 116, London: 1799), but only partially, and it was Yarrell who, in 1829 (*Zool. Journ.*, iv. pp. 457-465, pl. xiv. figs. 1-7), explained fully the means whereby the jaws and the muscles which direct their movements become so effective in riving asunder cones or apples, while at the proper moment the scoop-like tongue is instantaneously thrust out and withdrawn, conveying the hitherto protected seed to the bird's mouth. Without going into details, it may be observed that in the Crossbills the articulation of the mandible to the quadratebone is such as to allow of a very considerable amount of lateral play, and, by a particular arrangement of the muscles which move the former, it comes to pass that so soon as the bird opens its mouth the point of the mandible is brought immediately opposite to that of the maxilla (which itself is movable vertically), instead of crossing or overlapping it—the usual position when the mouth is closed. The two points thus meeting, the bill is inserted between the scales or into the pome, but on opening the mouth still more widely, the lateral motion of the mandible is once more brought to bear with great force to wrench aside the portion of the fruit attacked, and then the action of the tongue completes the operation, which is so rapidly performed as to defy scrutiny, except on very close inspection. Fortunately, the birds soon become tame in confinement, and a little patience will enable an attentive observer to satisfy himself as to the process, the result of which at first seems almost as unaccountable as that of a clever conjuring trick.

The Common Crossbill of the Palearctic Region (*Loxia curvirostra*) is about the size of a skylark, but more stoutly built. The young (which on leaving the nest have not the tips of the bill crossed) are of a dull olive color with indistinct dark stripes on the lower parts, and the quills of the wings and tail dusky. After the first moult the difference between the sexes is shown by the hens inclining to yellowish-green, while the cocks become diversified by orange-yellow and red, their plumage finally deepening into a rich crimson-red, varied in places by a flame-color. Their glowing hues are, however, speedily lost by examples which may be kept in confinement, and are replaced by a dull orange, or in some cases by a bright golden-yellow, and specimens have, though rarely, occurred in a wild state exhibiting the same tints. The cause of these changes is at present obscure, if not unknown, and it must be admitted that their sequence has been disputed by some excellent authorities, but the balance of evidence is certainly in favor of the above statement. Depending mainly for food on the seeds of conifers, the movements of Crossbills are irregular beyond those of most birds, and they would seem to rove in any direction and at any season in quest of their staple sustenance. But the pips of apples are also a favorite dainty, and it stands recorded by the old chronicler Matthew Paris (*Hist. Angl.* MS. fol. 252), that in 1251 the orchards of England were ravaged by birds, "pomorum grana, & non aliud de eisdem pomis comedentes," which, from his description, "Habebant autem partes rostri cancellatas, per quas poma quasi forcipi vel cutello dividebant," could be none other but Crossbills. Notice of a like visitation in 1593 was published by Wats (*Viz. 2 Offer.* etc., 1640, p. 262), but of late it has become vident that not a year passes without Crossbills being observed in some part or other of England, while in certain localities in Scotland they seem to breed annually. The nest is rather rudely constructed, and the eggs, generally four in number, resemble those of the Greenfinch, but are larger in size. This species ranges throughout the continent of Europe,<sup>1</sup> and occurs in the islands of the Mediterranean and in the fir-woods of the Atlas. In Asia it would seem to extend to Kamschatka and Japan, keeping mainly to the forest-tracts.

explained by the existence of a medieval legend (of which, however, he it said, he takes no notice), best known to English readers by Mr. Longfellow's pretty version of Moses's poem, to the effect that the bird acquired its peculiar conformation of bill and coloration of plumage in recognition of the pity it bestowed on the suffering Saviour at the crucifixion.

<sup>1</sup> Dr. Malmgren found a small flock on Bear Island (lat. 74° N.), but to this barren spot they must have been driven by stress of weather.

Three other forms of the genus also inhabit the Old World—two of them so closely resembling the common-bird that their specific validity has been often questioned. The first of these, of large stature, the Parrot-Crossbill (*L. ptyopittacus*), comes occasionally to Great Britain, presumably from Scandinavia, where it is known to breed. The second (*L. himalayana*), which is a good deal smaller is only known from the Himalaya Mountains. The third, the Two-barred Crossbill (*L. tenuirostris*), is very distinct, and its proper home seems to be the most northern forests of the Russian empire, but it has occasionally occurred in Western Europe and even in England.

The New World has two birds of the genus. The first (*L. americana*), representing our common species, but with a smaller bill, and the males easily recognizable by their more scarlet plumage, ranges from the northern limit of coniferous trees to the highlands of Mexico, or even further. The other (*L. leucoptera*) is the equivalent of the Two-barred Crossbill, but smaller. It has twice occurred in England. (A. N.)

CROTCH, WILLIAM (1775-1847), doctor of music, was born at Norwich, on 5th July, 1775. When only three years and a half old, he was able to play tunes with their bases on the organ with great correctness. Dr. Charles Burney, the English historian of music, gave an interesting account of the infant Crotch in the *Philosophical Transactions of the Royal Society* (vol. lx. pt. i. for 1779). Crotch also exhibited in his childhood a talent for drawing, which he afterwards cultivated so far as to become a very respectable amateur painter of landscapes. At the early age of twenty-two he was appointed professor of music in the university of Oxford, and there in 1799 he took his degree of doctor in that art. In 1800 and the four following years he read lectures on music at Oxford. Next he was appointed lecturer on music to the Royal Institution, and subsequently, in 1822, principal of the London Royal Academy of Music. His last years were passed at Taunton in the house of his son, the Rev. W. R. Crotch, where he died suddenly on the 29th December, 1847. He published a number of vocal and instrumental compositions, of which the best is his oratorio of *Palestine*. In 1831 appeared an 8vo volume containing the substance of his lectures on music, delivered at Oxford and in London. Previously, he had published three volumes of *Specimens of Various Styles of Music*, referred to in his lectures. Among his didactic works is *Elements of Musical Composition and Thorough-Bass* (London, 1812). He arranged for the pianoforte a number of Handel's oratorios and operas, besides symphonies and quartets of Haydn, Mozart, and Beethoven. The great expectations excited by his infant precocity were not fulfilled; for he manifested no extraordinary genius for musical composition. But he was a hard student and a sound musician, and justly holds a high place among English cultivators of his art.

CROTON OIL (*Croton Oleum*) is prepared from the seeds of *Croton Tiglium*, a euphorbiaceous tree indigenous to the Malabar coast and Tavoy, and grown in many parts of the East Indies. The tree is from 15 to 20 feet in height, and has few and spreading branches; alternate, oval-oblong leaves, acuminate at the point, and covered when young with stellate hairs, and small, downy, greenish-yellow, monocious flowers. The male blossoms have five petals and fifteen stamens; the females are petalous, but bear three bifid styles. The fruit or capsule is obtusely three-cornered, and  $\frac{1}{4}$ ths of an inch long; it consists of three carpels each inclosing a seed. The seeds resemble those of the castor-oil plant; they are about half an inch long, and  $\frac{1}{4}$ ths of an inch broad, and have a cinnamon-brown, brittle integument; between the two halves of the kernel lie the large cotyledons and radicle. The kernels contain from 50 to 60 per cent. of oil, which is obtained by pressing them, when bruised to a pulp, between hot plates. Croton oil is a transparent and viscid liquid of a brownish or pale-yellow tinge, an acrid, peculiar, and persistent taste, a disagreeable odor, and acid reaction. It is soluble in volatile oils, carbon disulphide, and ether, and to some extent in alcohol. It contains acetic, butyric, and valeric acids, with glycerides of acids of the same series, and a volatile body,  $C_8H_{16}O_2$ , metameric with angelic acid, termed by Geuther and Fröhlich *tiglic acid*, and considered by them as possibly identical with Frankland and Duppa's methylcrotonic acid,  $C(C_2H_5)''CH_2.CO.OH$ . According to the chemists before-mentioned the crotonic acid of

Schlippe,  $C_4H_6O_2$ , is not present in croton oil. To what the oil owes its medicinal properties has not yet been certainly determined. It is a rapidly-acting and strong purgative. A single drop is a sufficient dose, and need only be placed on the tongue to insure its action. It is employed in cases of obstinate constipation, paralysis, apoplexy, and dropsy. It may be added to castor oil to increase the effect of that drug. Nausea and vomiting sometimes follow its administration, and over-doses are extremely poisonous, and bring on intestinal inflammation. The best antidote is an emetic of copper sulphate. Applied to the skin croton oil produces pustulation. It is used externally in gout, neuralgia, rheumatism, and tumors; and with oil of cajeput and rectified spirit it is employed as a liniment in lung and laryngeal diseases. Croton oil has long been known in India as a medicine, and has been in use in England since 1813. Seeds for manufacturing it are imported mostly from Cochlin and Bombay. It is occasionally adulterated with olive, castor, and nut oil.

CROTONA, or CROTON, now COTRONE, a celebrated city of Magna Græcia, at the mouth of the small river *Æarus*, in the country of the Bruttii, on the western shore of the Ionian Sea. It was founded in the year 710 B.C. by a colony of Achæans under the command of Myscellus, in accordance with a decree of the oracle at Delphi. The first well-established fact in its history is its friendship with Sybaris; and till the arrival of Pythagoras the two cities continued advancing in material prosperity and cultivating the arts of war and peace with much success. The Crotoniats regarded Hercules as their tutelary divinity, and were renowned for their skill in all athletic exercises; the Sybarites were distinguished by luxury and effeminacy. The government of Crotona, oligarchical in form, had hitherto been confined to the council of 1000, who traced their descent from the Achæan founders of the city. But a secret society of 300 of the disciples of Pythagoras contrived to guide and even overawe the supreme council, till the people, who were excluded from all share in the government, expelled the Pythagoreans from the city, and established a democracy. Before this revolution, however, the Crotoniats, under the command of the celebrated athlete Milo, had marched against Sybaris, and, though opposed by an army three times their own in number, had taken it and levelled it with the ground. This event is usually dated 510 B.C. Before thirty years had elapsed, the Crotoniats themselves sustained a still more disgraceful defeat from the united forces of the Locrians and Rhegghians, which, however, was not attended with such disastrous consequences to their city. During the Athenian invasion of Sicily, Crotona remained neutral; it supplied the Athenians with provisions, but refused to allow them a passage through its territory. In 389 B.C. the city fell into the hands of the elder Dionysius; but on his death in 377 it recovered its independence. Its prosperity, however, was greatly impaired by intestine feuds and the growing power of external foes. Being hard pressed by the Bruttians, Crotona sought and received assistance from the Syracusans, but had ultimately to conclude a treaty with the enemy, as it was now in danger from its own exiles. Mendemus, their general, defeated the exiles, and established a tyranny which lasted for some time. In the beginning of the 3d century B.C., the city was held for some years by Agathocles; and in the wars of the Romans with Pyrrhus it suffered so severely that more than half the area within its walls ceased to be inhabited. In the absence of Pyrrhus in Sicily, it was seized by the Roman consul Cornelius Rufinus (277 B.C.); but during the latter years of the second Punic War it was the headquarters of Hannibal for three successive winters. This completed the ruin of the town, which, though colonized a few years after from Rome, sank into obscurity, and is not again mentioned in history till the wars of Narses and Belisarius against the Goths. After that it remained subject to the Byzantine emperors till it passed into the hands of the Normans.

The medical school of Crotona was, in the days of Herodotus, and long after, the most renowned in Greece,—its proudest name being that of Alcmeon. It is not known whether there was anything remarkable about the architecture of Crotona; but the temple of the Læcinian Juno, six miles from the city, was the most sacred and magnificent work of the kind in the whole of Magna Græcia, and contained, among other ornaments, the "Helen" of Zeuxis.

One column of this great edifice still stands amid a mass of shapeless ruin.

About a mile from the site of the old Crotona is the modern town of Cotrone, in the Bay of Tarento, with a small but excellent harbor. It is the seat of a bishop and retains the castle and walls that were erected in the time of Charles V. It surrendered to the English in 1806, but was again occupied by the French. Population, 7700.

CROUP (synonym, *Cynanche trachealis*), a common and dangerous form of disease, occurring chiefly in young children. Its essential nature is an acute inflammation of the air passages, particularly the larynx and trachea, accompanied with the exudation of a fibrinous material or "false membrane" which spreads over the interior of the tube, narrowing its calibre, and thus obstructing respiration.

Croup occurs most frequently in the second and third years of life, although it may affect children of any age. It is exceedingly rare in adults.

The attack sometimes comes on suddenly in the night without previous warning, but in general some premonitory symptoms exist in the shape of the phenomena of a common cold or catarrh, which may precede the onset of the croup for several days. There is a slight hoarseness of the voice and an occasional cough of a peculiarly harsh or brassy sound, together with a feeling of pain in the throat and breast, and a high degree of feverishness and general disturbance. The disease soon assumes its characteristic features. The loud croupy cough comes on in frequent paroxysms, and is attended with an increasing difficulty of breathing, the respirations partaking of the shrill metallic noise of the cough, while the voice is reduced to a hoarse whisper. The child lies with the head thrown back, making strong efforts to breathe, the countenance indicating intense suffering and anxiety. At first little or nothing is expectorated with the cough, but as the latter increases, fragments of the so-called false membrane are brought up into the mouth, with the effect of affording some temporary relief to the breathing. The power of swallowing is not much impaired. Should the attack undergo no abatement, symptoms of asphyxia soon make their appearance. The surface of the body becomes livid, the respiration long drawn out and labored, while the cough continues to recur in fits which threaten instant suffocation. Drowsiness or coma succeeds; and death takes place, either gradually from exhaustion, or suddenly in the midst of a suffocative paroxysm. Throughout the whole course of the disease remissions in the severity of the symptoms are common, and generally occur during the daytime, the attack returning with all its violence as night approaches. In favorable cases the symptoms undergo gradual abatement, and there is a speedy return to health, but it is to be borne in mind that one attack of croup appears to predispose to another, and relapses are not uncommon.

The inflammatory product, or false membrane formed in the air passages in the course of an attack of croup, varies both as to its amount and the extent of its distribution. It may consist merely of a thin white film covering portions of the windpipe, or on the other hand it may have the character of a tough compact membrane of several lines in thickness, and may extend from the upper part of the larynx down to the ramifications of the bronchial tubes. It adheres closely to the mucous surface, and although large portions are occasionally detached by coughing or vomiting, the false membrane appears to be reproduced with great rapidity. It is the chief source of danger in the disease, and where it has spread downwards into the bronchial tubes death by asphyxia is the rapid result.

Croup is apt to be complicated with other serious diseases, such as bronchitis and inflammation of the lungs, and it may also be accompanied with many of the phenomena of diphtheria, in which case it has been named diphtheritic croup. This latter form of the disease is sometimes observed when croup occurs in connection with some of the infectious diseases, such as measles, scarlet fever, or small-pox. On this point it ought to be stated that much discussion has from time to time taken place respecting the relation of croup to diphtheria, not a few eminent authorities holding that in all essential points they are one and the same disease. The generally prevailing opinion, however, among physicians who have had extensive oppor-

tinities of observation, is, that while many points of similarity exist between croup and diphtheria they cannot be regarded as identical. See DIPHTHERIA.

Croup has sometimes appeared in an epidemic form. This was the case in the year 1805-7, when it spread over a large portion of the continent of Europe. In the last-named year an inquiry into the nature of the disease by the faculty of medicine of Paris was ordered by Napoleon I., whose nephew, the crown-prince of Holland, had fallen a victim to the epidemic, and who offered a prize for the best essay on the subject. Besides the two prize essays of MM. Jurine and Albers, many valuable treatises were written, and it is to the information thus obtained that much of our present knowledge of this malady is due.

Croup is a disease of northern climates, and of low-lying, damp, and cold localities. The exciting cause of an attack is generally exposure to cold, particularly cold winds, such as prevail in winter and spring. There appears to be in some families a special liability to this disease, as shown in the readiness with which the children are attacked on slight exposure. Male children appear to be more frequently affected than female. Croup is not contagious.

The mortality from croup is very great, and it has been computed that about one-half of those in whom the attack is developed die. Its course is in general rapid, seldom exceeding three or four days. It sometimes proves fatal in less than one day, while again recovery may take place after several days' severe suffering.

With respect to the treatment of croup, it may be stated that in few acute diseases are greater vigilance and more prompt and energetic measures requisite. The disease in many cases hastens on with such rapidity that as regards treatment the loss of a few hours may be fatal to the patient. In the early or premonitory stage, when the only symptoms present are hoarseness and some amount of croupy cough, it is essential that the child should be kept in a warm temperature, while warm baths and medicines to promote perspiration, such as small doses of antimonial or ipecacuanha wine should be administered. The abstraction of blood by one or two leeches over the upper part of the breast-bone is recommended by many physicians when the child is robust and the attack violent. When the breathing becomes embarrassed the administration of emetic doses of the above-named medicines, or of the sulphate of zinc or of copper, are of great use, as in the act of vomiting portions of false membrane may be dislodged and expelled from the air passages. The child should be surrounded with an atmosphere of steam (see BRONCHITIS), and fomentations, by means of a sponge or piece of flannel dipped in hot water, applied to the neck. Abundance of liquid nutriment may be given, thirst being always present. When remedies such as those now indicated fail to afford relief, and the child threatens to die from asphyxia, the question of tracheotomy has to be considered as a last resource. This operation has so often succeeded in croup as to justify its being resorted to in the circumstances now described. Indeed, in the opinion of many competent authorities, more lives might be saved were the operation performed earlier in the course of the attack than is commonly the case. However this may be, it is certain that not only are many children thus rescued from death, but even where the operation fails to accomplish this, suffering is greatly mitigated and death rendered easier.

What is known as SPASMODIC CROUP (synonyms, *Falax Croup*, *Laryngismus stridulus*, *Spasm of the Glottis*, *Child-Crowing*) bears some resemblance to the disease above described as regards its chief symptom, but differs from it entirely as to its pathology. This affection occurs mostly in young infants during dentition, and manifests itself by a sudden and violent interruption to the breathing, during which the attempts to inspire are accompanied with a noise resembling the crowing of a cock. Unlike true croup this disease is unattended with fever or inflammation of the air passages, and is a purely nervous ailment depending on the irritation of the nerves which regulate the closing of the aperture of the glottis (the upper part of the larynx). This irritation is usually of reflex origin, being due to some disturbance at some distance from the part, as teething or disorders of the stomach or bowels, all of which, as first shown by Dr. Marshall Hall, have the effect of bringing on attacks of this kind. The attack is sometimes precipitated in a child liable to it by exposure to a cold wind, or by its being violently tossed in the arms of a nurse. The

nervous origin of the seizure is further proved by the fact that the child-crowing is often accompanied by marked contraction of the muscles of the fingers and toes, and also sometimes by convulsions. During the spasm all the symptoms of asphyxia are rapidly developed, and unless relief is speedily obtained death may suddenly take place. The attack often passes off with a forcible expiratory effort, after which the child lies quite exhausted. The paroxysm, however, is apt to return. Like croup, a liability to this disease may run in families, and sometimes with disastrous results. The treatment must bear reference to any cause likely to have given rise to the attack. For relief during the paroxysm efforts to make a sudden impression on the nervous system should be used, such as warm baths or cold affusion to the surface of the body. Artificial respiration ought to be tried where death threatens from asphyxia, and tracheotomy performed, if time be sufficient to make the attempt. (J. O. A.)

CROUSAZ, JEAN PIERRE DE (1663-1748), professor of philosophy and mathematics, was born at Lausanne, of a noble Protestant family. He was destined by his father for the profession of arms, but his tastes were literary. Instead of joining the army, he went to study at Geneva, especially devoting himself to mathematics and the Cartesian philosophy, which he adopted. After some time spent in travelling, he returned to his native place, where he was successively appointed pastor, professor of philosophy, and rector of the academy. In 1724 he was called to Groningen to teach mathematics, and appointed governor to the young Prince Frederick of Hesse-Cassel. The king of Sweden also conferred upon him the title of counsellor of embassies.

His works are exceedingly voluminous, but seldom rise above mediocrity. The most important are *Système des Réflexions qui peuvent contribuer à la netteté et à l'étendue de nos Connoissances*, *ou nouvel Essai de Logique*; *Traité du Beau*, in which he maintains the view that beauty entirely consists of unity in diversity; *De l'Education des Enfants*; *Examen du Traité de la Liberté de Penser d'Antoine Collins*; *Géométrie des Lignes et des Surfaces rectilignes et circulaires*; *Examen du Pyrrhoniisme ancien et moderne*, an attack chiefly on Bayle; *Oeuvres diverses*; *Traité de l'Esprit Humain*; *Réflexions sur la belle Voltaire*; and an attack on the Leibnitzian theory of Pope's *Essay on Man*.

CROW (Holland. *Kraai*, Germ. *Kräh*e, Fr. *Corbeau*, Lat. *Corvus*), a name most commonly applied in Britain to the bird properly called a Rook (*Corvus frugilegus*), but perhaps originally peculiar to its congener, now-a-days usually distinguished as the Black or Carrion-Crow (*C. corone*). By ornithologists it is also used in a far wider sense, as under the title Crows, or *Corvidæ*, is included a vast number of birds from almost all parts of the world, and this family is probably the most highly developed of the whole Class *Aves*. Leaving out of account the best known of these, as the Raven, Rook, Daw, Pie, and Jay, with their immediate allies, our attention will here be confined to the Crows in general; and then the species of the Family to which the appellation is more strictly applicable may be briefly considered. Of the limits and subdivisions of this Family it is at present desirable to speak with great caution, if not doubt. All authorities admit that it is very extensive, and is capable of being parted into several groups, but scarcely any two agree on either head. Especially must reserve be exercised as regards the group *Streperinæ*, or Piping Crows, belonging to the Australian Region, and referred by some writers to the Shrikes (*Laniidæ*); and the Jays too have been erected into a distinct Family (*Garrulidæ*), though it seems hardly possible to separate them even as a Subfamily from the Pies (*Picæ* and its neighbors), which lead almost insensibly to the typical Crows (*Corvinæ*). Dismissing these subjects for the present, it will perhaps be most convenient to treat of the three groups which are represented by the genera *Pyrrhocorax* or Choughs, *Nucifraga* or Nutcrackers, and *Corvus* or True Crows in the most limited sense.

*Pyrrhocorax* comprehends at least two very good species, which have been needlessly divided generically. The best known of them is the Cornish Chough (*P. graculus*), formerly a denizen of the precipitous cliffs of the south coast of England, of Wales, of the west and north coasts of Ireland, and some of the Hebrides, but now greatly reduced in numbers, and only found in such places as are most free from the intrusion of man or of Daws (*Corvus monedula*), which last seem to be gradually dispossessing it of its sea-

girl strongholds, and its present scarcity is probably in the main due to its persecution by its kindred. In Britain, indeed, it would appear to be only one of the survivors of a more ancient fauna, for in other countries where it is found it has been driven inland, and inhabits the higher mountains of Europe and North Africa. In the Himalayas a larger form occurs, which has been specifically distinguished (*P. himalayanus*), but whether justifiably so may be doubted. The general color is a glossy black with steel-blue reflections, and it has the bill and legs bright red.<sup>1</sup> The remaining species (*P. alpinus*) is altogether a mountaineer, and does not affect a sea-shore life. Otherwise it frequents much the same kind of localities, but it does not occur in Britain. The Alpine Chough is somewhat smaller than its congener, and is easily distinguished by its shorter and bright yellow bill. Remains of both have been found in French caverns, the deposits in which were formed during the "Reindeer Age." Commonly placed by systematists next to *Pyrrhocorax* is the Australian genus *Corcorax*, represented by a single species (*C. melanorhamphus*), but osteologists must be further consulted before this assignment of the bird, which is chiefly a frequenter of woodlands, can be admitted without hesitation.

*Nucifraga* is another very distinct form of *Corvidæ*, peculiar to the Old World, and best exemplified by the European Nutcracker (*N. caryocatactes*), while in the New World it is somewhat remotely represented by the genus *Picicorvus*, of which only one species (*P. columbianus*), until lately very rare in collections, and only inhabiting the western slopes of the Rocky Mountains, is known. The Common Nutcracker has a wide range in the Palearctic Region, chiefly keeping to subalpine or subarctic pine-forests, and feeding on the seeds of one or another species of fir. It seems nowhere to be numerous, though roving bands of seventy or a hundred have been occasionally observed. It has long been known as a rare straggler to the British Islands, but little was ascertained of its economy till some fifteen years ago. It has now been discovered to breed, though in small numbers, in some of the denser forests of Middle Sweden, on the island of Bornholm, and in the Bavarian and Tyrolean mountains. It appears to build its nest and lay its eggs very early in the year, long before the snows have disappeared, and this fact, coupled with that of its becoming in the breeding season one of the most silent of birds, when at other times it is rather noisy than not, will account for the mystery which enwrapped its domestic arrangements not having been sooner dispelled. Considerable difference has been observed in the form and size of the bill of examples of this species, but this is now supposed to depend on the sex—that of the cock being stout and short, while in the hen it is long and thin.<sup>2</sup> The bird is about the size of a Jay, and of a dark sooty-brown color spangled with white, nearly each body-feather ending in a tear-shaped patch of that color. Besides the European species, which also extends into Northern or Central Asia, three others, very nearly akin to it, have been described from the Himalayas. Of their American cousin, Clarke's Crow, as it is called (*Picicorvus columbianus*), an excellent account has been given by Dr. Coues (*Ibis*, 1872, pp. 52-59).

Coming now to what may be literally considered Crows, attention must be mainly directed to the Black or Carrion-Crow (*Corvus corone*) and the Grey, Hooded, or Royston Crow (*C. cornix*). Both these inhabit Europe, but their range and the time of their appearance are very different. Without going into minute details, it will suffice to say that the former is, speaking generally, a summer visitant to the south-western part of this quarter of the globe, and that the latter occupies the north-eastern portion—an irregular line drawn diagonally from about the Firth of Clyde to the head of the Adriatic roughly marking their respective distribution. But both are essentially emigrants, and hence it follows that when the Black Crow, as summer comes to an end, retires southward, the Grey Crow moves downward, and in many districts replaces it during winter. Further than this, it has now been incontestably proved that along or near the boundary where these two birds march they not

infrequently interbreed, and it is believed that the hybrids, which sometimes wholly resemble one or other of the parents and at other times assume an intermediate plumage, pair indiscriminately among themselves, or with the pure stock. Hence it has of late seemed to many ornithologists who have studied the subject, that these two kinds so long unhesitatingly regarded as distinct species, are only local races of one and the same dimorphic species. The structural difference—or indeed any difference except that of range (already spoken of) and color—can be detected, and the problem they offer is one of which the solution is exceedingly interesting if not important to zoology in general.<sup>3</sup> The mode of life of the Crows needs not be described. Almost omnivorous in their diet, they are little edible that comes amiss to them, and, except in South America, they are mostly omnipresent. The number of species described is considerable, but doubtless should will be ruthlessly curtailed when a revision of the group is undertaken by any ornithologist working with good materials. The Fish-Crow of North America (*C. angulus*) demands a few words, since it betrays a taste for maritime habits beyond that of other species, but our Crows of Europe are not averse on occasion to prey upon the waters, though they will hardly draw it out for themselves. The so-called "Hooded Crow" of India (*C. splendens*) is not very nearly allied to its European namesake, from which it can be readily distinguished by its smaller size and the lustrous tints of its dark feathers, while its confidence in the human race has been so long encouraged by its intercourse with an armed and inoffensive population, that it becomes a plague to the European abiding or travelling where it is abundant. Hardly a station or camp in British India free from a crowd of feathered followers of this species ready to dispute with the Kites and the crows the meat at the fire; and when any lengthened settlement established the crows will build their nests of the wire of the Englishman's soda-water bottles. (A. S. CROWE, EYRE EVANS (1799-1868), journalist and author, was born about the year 1799. He commenced work as a writer for the London newspaper press in connection with the now defunct *Morning Chronicle*, and afterwards became a leading contributor to the *Evening Standard* and the *Daily News*. Of the latter journal he was principal editor for some time previous to his death. The department he specially cultivated was that of Continental history and politics, with which he made himself intimately acquainted by means of study, travel, and correspondence with leading public men abroad. To permanent literature he made contributions of considerable value in his *Lessons to Foreign Statesmen* (1830), *The Greek and the Turk* (1831), and *Reigns of Louis XVIII. and Charles X.* (1854). They were followed by his most important work, the *History of France* (5 vols., 1858-68), which is full, impartial, laborious, and written in a clear though somewhat colorless and unimpassioned style. It is founded upon original sources, in order to consult which the author resided for considerable time in Paris. He died in London on the 25th February, 1868.

CROWLAND, or CROYLAND, an ancient town and parish of Lincolnshire, situated in a low flat district, about eight miles north-east from Peterborough. It stands at the confluence of the Welland and the Catwater drain; and at their junction there is a curious triangular bridge (figured in art. BRIDGES, vol. iv. p. 298), passable only on foot. The origin of Crowland was in a hermitage founded in the 7th century by St. Guthloc; an abbey was founded in 714 by King Ethelbald, which was burnt in 870 by the Danes, restored by Ethelred II., burnt again in 1091, and again rebuilt in 1112. Of this there are still some interesting remains. Among its abbots was the historian Ingulphus. Weekly markets are held at Crowland, and there are three fairs annually. Population (1871), 2459.

CROWN, a circular ornament worn around the head. The name is applied, at present, only to the head-dress worn by kings or emperors as a badge of their dignity. Originally it was of much wider meaning. The simplest and earliest form of the crown appears to have been a fillet or band, tied about the head, and serving for use, as well

<sup>1</sup> Hence the "russet pated boughs" of Shakespeare, an expression which has much exercised many of his commentators, who did not see that "pated" meant "patted" or footed (cf. the heraldic *crots pates*), instead of having anything to do with the bird's head, which is as black as that of a Raven. See *Nature*, v. p. 160.

<sup>2</sup> An exactly similar sexual distinction is observable in the Hula of New Zealand (*Heterochea*), which was for a long time included among the *Corvidæ*, but is now referred to the Starlings (*Sturnida*).

<sup>3</sup> As bearing upon this question may be mentioned the fact that the Crow of Australia (*C. australis*) is divisible into two forms or races, one having the irides white, the other of a dark color. It is stated that they keep apart and do not intermix.

ornament, by keeping up the hair. The name of crown was given to garlands of leaves or branches, worn by the nobles at private banquets, and on almost any occasion of more than common festivity. It was natural that those who wished to mark a distinction between themselves and their fellows should adopt a head-dress differing from that in general use, just as they adopted different and distinctive ornaments. In countries governed by a king, a special head-dress was, at a very early period, one of the recognized symbols of royalty. A very simple form of the royal crown was a diadem or fillet of gold fastened round the head and behind. This by degrees became more and more elaborate in its structure and ornament, and assumed a variety of forms, in most of which the original diadem is to be traced, just as the diadem itself is a clear advance of the original ribbon or garland.

Crowns are often mentioned in Scripture; but the term is applied to other ornaments for the head besides those worn exclusively by royal personages. For example, the head-dress of the Jewish high-priest—a linen band with a wreath of gold fastened in front—is also called a crown.

Among the kings of Egypt and of the East crowns were in common use. The crowns of the Ptolemies were, in general, plain fillets of gold encircling the head, but we find them sometimes making use of the more ornate radiated crown. The Selencidæ of Syria used the plain golden fillet. The crowns of the Oriental kings have usually been much more ornate, sometimes of very massive construction, and profusely adorned with pearls and gems.

In the republics of historical Greece and Rome the crown was continued in use in its first and most simple form. There is no mention made by Homer of the crown as a royal distinction, nor does he seem to have known it at all except as an ornamental wreath or garland. The most celebrated crowns among the Greeks were the wreaths gained at the great inter-Hellenic games, by the victors in the races and athletic contests. In the course of later Athenian history, we find crowns of gold frequently bestowed in recognition of distinguished public services. It was by Alexander the Great, and the successors of Alexander, that the crown was first worn in Greece as the symbol of royal rank. The form used was generally that of a simple band of gold.

The early Roman kings are commonly represented with plain bands of gold encircling their heads. During the historical period of Roman history, besides the crown in private use at feasts and funerals, there were several kinds of crowns bestowed for public services, and indeed in recognition of almost any kind of honorable distinction. These were frequently so designed in shape or material as to be symbolical of the service they commemorated. The corona muralis, for instance, was a crown of gold, decorated with turrets, given to him who had first scaled the walls of a besieged place; the corona vallaris, decorated with pales, to him who had first forced an entrenchment; the corona navalis, decorated in general with little figures of the prows of ships, to him who had gained a single victory at sea. The corona obsidionalis, given to a general who had delivered a Roman army from blockade, was a crown of grass or herbs plucked at the spot where this important service had been rendered. The crowns of the Roman emperors were of several forms, regulated by the fancy of the wearer, from the simple golden fillet to the radiated crown which marked an admitted claim to divine honors.

In the nations of modern Europe crowns have always been in general use among personages of the highest rank. The most remarkable are the papal and the imperial crowns. The papal crown is a lofty uncleft mitre, encircled by three coronets rising one above the other, surmounted by a ball and cross, and with ribbons at each side, similar to those of the mitre of an Italian bishop. This form of crown was first assumed by Pope Benedict XII., 1344.

The crowns that are most celebrated in connection with the imperial dignity are the Imperial crown proper, the German crown, and the Italian or Lombard crown. The first of these was of gold, rising into a semicircle above the head, surmounted by a small cross, and adorned with pearls and precious stones. The second is always spoken of as the silver crown, but it appears from the evidence of eye-witnesses that its material was, in fact, gold. The third was known as the iron crown, though it appears that the only iron in it was one of the nails used or said to have been used at the crucifixion, and that in this case too the rest of

the material was gold. It was with this, or with a later imitation of it, that Napoleon I. was crowned as king of Italy at Milan in 1805. The Imperial crown now in use in the empires of the Continent, in its form is very remarkable, being cleft somewhat after the manner of a mitre, having also the general contour of a modern convex mitre in its elevated part which rises above the golden leafage that heightens the gemmed circlet. In the open space between the two divisions formed by the cleft a single arch rises, surmounted by a mound and cross.

The English royal crown has gradually grown up from its early simple form into various aspects of elaborate splendor. Before the Norman Conquest the headdress which appears to have been habitually worn by the Anglo-Saxon princes was a fillet of pearls; their coins, however, and illuminations in MSS. of their era, show them to have been by no means unfamiliar with a nearer approach to a true crown, in the form of a radiated diadem. The great seals, the coinage, monumental effigies, and various other contemporary representations, supply a complete series of examples of the crown in its varieties of design and enrichment, from the time of the Conqueror.

In addition to several modifications in both the treatment and the grouping of the adornment of the regal circlet, the English crown has undergone a complete change in the character of the figures with which the circlet has been heightened; and it also has had its original aspect of an open crown completely altered by its enriched circlet being arched over with jewelled bands of gold, when the diadem thus inclosed was surmounted by a mound and cross.

The crown worn by William I. and his successors was a plain circlet heightened with four spikes having trefoil-heads (fig. 1). Henry I. appears to have enriched the

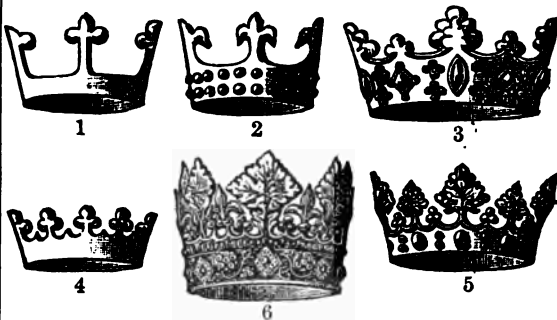

Figs. 1-6.—Royal Crowns—William I. to Henry IV.

circlet with gems (fig. 2), and on his great seal the trefoils of his father's crown assume a form resembling that of fleurs-de-lys. The effigies of Henry II., Richard I., John, and their queens, show the crown to have made such an advance in the dignity of its aspect as is shown in fig. 3. The crowns of Richard and Berengaria, however, have four large leaves only heightening the circlets, while the crowns of Henry, Alianore, John, and Isabella have four smaller leaves alternating with the four larger ones. The crown of Henry III. has a plain circlet heightened with trefoils, a slightly raised point intervening between each pair of the leaves (fig. 4). A similar crown was worn by Edward I., the trefoil-leaves being alternately large and comparatively small. The truly beautiful crown of Edward II. (fig. 5), as it is represented in his effigy, was formed of four large and as many smaller leaves of a deeply serrated type, rising with graceful curves from the jewelled circlet, and having eight small flowers alternating with the leaves. This form of crown appears to have remained unchanged during the reigns of Edward III. and Richard II.

It would seem from the crown, fig. 6, sculptured with elaborate care upon the head of his effigy at Canterbury, that Henry IV. determined to distinguish the accession of a Lancastrian prince by displaying an unprecedented magnificence in the emblem of his sovereignty. The splendidly jewelled circlet of this crown is heightened with eight large and rich leaves, and as many true fleurs-de-lys—their first appearance on an English crown,—the whole alternating with sixteen small clusters of pearls, three in each. The famous "Harry crown," of which this may be assumed to be a faithful representation, was broken

up and employed as security for the loan required by Henry V., when he was about to embark on his expedition to France; but the costly fragments are recorded to have been redeemed in the 8th and 9th years of Henry VI. The arched crown in its earliest form (fig. 7), was introduced by Henry V.; and, with the arched crosses, which from the time of Henry VI. always have been crosses patées, appeared to supersede the earlier foliage upon the circlet. The arches at different periods have varied both in number and in contour. At first they were elevated almost to a point; then they were somewhat depressed at their intersection; still later this depression was increased, the arches themselves thus having an ogee contour, as in fig. 13; and finally, in the coronation crown of Queen Victoria (fig. 16), the arches, which bend over almost at right angles, are

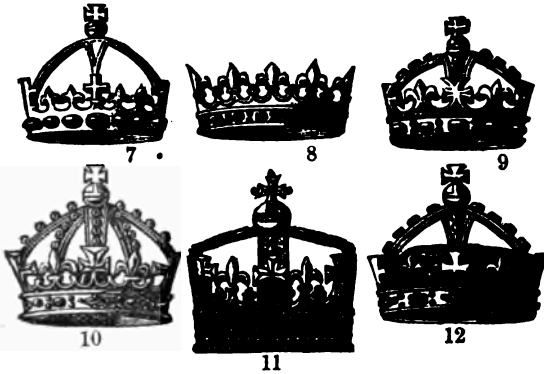

Figs. 7-12.—Royal Crowns—Henry V. to Charles I.

flattened where the mound rests on them at their intersection. The crown of Henry VI. appears to have had three arches, or six semi-arches; and there are the same number in the crown that ensigns the hawthorn-bush badge of Henry VII. The crown of Edward IV. had two arches, or four semi-arches; and a crown arched in the same manner (fig. 9) appears on the great seal of Richard III. Both arched and open crowns are represented in sculpture, illuminations, and other works, until the close of the reign of Edward IV.; and, occasionally, as late as the reign of Henry VIII. a royal shield displays an unarched crown. Whatever other changes or modifications the English crown may have experienced since the time of Henry V., the circlet has always been heightened with alternate crosses patées and fleurs-de-lys, with some minor accessories of jewels; also when the crown has two arches, each of the four semi-arches always has risen from within one of the crosses upon the circlet. Edward IV. sometimes has his royal shield of arms ensigned with an open crown, its circlet



Figs. 13-15.—Recent forms of the English Crown.

heightened with eight crosses and eight fleurs-de-lys. Upon his seal as earl of Chester, the same sovereign has the circlet of his open crown heightened with fleurs-de-lys only, alternating with small clusters of pearls (fig. 8). The crown actually worn by Henry VII. appears, from his monument at Westminster, to have had two arches, its circlet being heightened with four crosses and four fleurs-de-lys. A similar crown (fig. 9) appears on the great seal of Henry VIII. During the reigns of Edward VI., Mary, and Elizabeth, the crown experienced no change; but in her great seal Elizabeth is represented wearing a small diadem having eight semi-arches. In fig. 11, drawn from the royal achievement of Henry VII., sculptured with great

spirit above the south entrance to King's College Chapel, Cambridge, the royal motto is inscribed upon the circlet. The interior of the same noble building is enriched with numerous other splendid crowns executed in full relief. In these examples of the crowns of Tudor sovereigns there are four crosses and as many fleurs-de-lys; it must be added, however, that eight crosses and the same number of fleurs-de-lys are commonly represented, though certainly only as variations from the more authoritative number, on Tudor crowns. The form of arches shown in fig. 12 for the first time appears upon the great seal of Edward VI.

The crown of the Stuart sovereigns, the first kings of Great Britain, James I. and Charles I., had four arches, each of the eight semi-arches springing from the alternating crosses and fleurs-de-lys of the circlet (fig. 10). This crown, described to have been formed of massive gold, weighing 7 lb 6 oz., and valued at £1110, was in 1649 broken up and defaced, with other royal insignia. The crown made for Charles II. (fig. 13), and also worn by James II., William III., and Anne, closely resembled an earlier type; and, indeed, it differed only in its proportions



Fig. 16.—Coronation Crown of Queen Victoria.

from the crown of more recent times (fig. 14),—the crown of Her Majesty's immediate predecessors on the throne, which still forms a part of the regalia of the British empire. The crown (fig. 16), made for the coronation of Queen Victoria, has its entire surface completely covered with jewels,—its circlet, crosses, fleurs-de-lys, arches, and mound being alike in displaying varieties of the same precious constructive materials. This coronation crown is lined with a cap of violet velvet, in accordance with a usage that first appeared upon the great seal of Henry

VIII.; but in all the earlier crowns the caps were of crimson or purple velvet. It only remains to direct attention to the form, fig. 15, under which, with Her Majesty's sanction, the crown of Queen Victoria is represented, happily for its effective appearance without any cap or lining, on all occasions of the ordinary use of the symbol of regal dignity and power.

The crown introduced into the English coinage by Henry VIII. in both gold and silver, bears a crowned rose and crowned shield of arms, with the royal cipher. The silver crown of Edward VI. has the king on horseback and the royal shield; but that of Elizabeth substitutes a crowned bust for the equestrian figure. In both these silver coins the royal shield is charged in pretence with a floriated cross, which, extending beyond the shield, divides the legend into four parts. The crown of Charles II. has four crowned shields of England, Scotland, France, and Ireland in cross. The crown of recent years, that bears the device of St. George and the dragon, strangely represents the Christian champion under the aspect of a nude classic warrior armed with a sword, instead of his appearing in mediæval armor, and piercing his adversary with a lance. See HERALDRY. (C. B.)

CROYDON, a town, parish, and district of England in the north-east of the county of Surrey, nine miles south of London, with stations on several lines of railway. It stands near the sources of the River Wandle, under Banstead Downs, and is a place of great antiquity. The original site, further west than the present town, is supposed to have been that of the *Noviomagus* of the Antonine Itinerary, and it is the *Croindone* (French, *crois dune*, chalk-hill) of the Domesday Book. In the neighborhood there are distinct traces of Roman occupation, and several gold coins bearing the stamp of the later emperors have been found. A cluster of twenty-five tumuli between the town and Addington Park, and a circular encampment with a double moat, form the most interesting portion of the remains. The manor of Croydon was presented by William the Conqueror to Archbishop Lanfranc, who is believed to have founded the archiepiscopal palace there, which was the occasional residence of his successors till about 1750,



and of which the chapel and hall still remain. The newer town of Croydon consists principally of a well-built street extending along the high road to Brighton with branch streets. The principal buildings are the parish church, close to the palace, a large and handsome structure in perpendicular style, with an ancient flint and stone tower; several newer churches; the town hall, a semi-classical edifice built in 1809; a public hall built in 1862, and the market-house, water-works, and prison. Considerable weekly corn and cattle markets are the chief business of the town. The summer asizes for Surrey are held alternately there and at Guildford. Its site is remarkable for the number of springs which issue from the soil. One of these, called the "Bourne," bursts forth a short way above the town at irregular intervals of from one to ten years or more; and after running as a torrent for two or three months, it as quickly vanishes. This phenomenon seems to arise from rains which, falling on the chalk hills, sink into the porous soil and reappear after a time from crevices at lower levels. Population (1871), 55,652.

CRUCIFIX AND CRUCIFIXION. See CROSS.

CRUDEN, ALEXANDER (1701-1770), author of the well-known *Concordance* to the English Bible, was born at Aberdeen in 1701. He studied at Marischal College with the intention of entering the church, and took his M.A. degree after the usual curriculum of four years. He was prevented from fulfilling his purpose, however, by an attack of insanity, caused by a disappointment in love. After being for some time in confinement he partially recovered, and removed to London, where he employed himself as a private tutor and a corrector of the press. In 1732 he opened a bookseller's shop near the Royal Exchange, but met with little success. His *Concordance*, a laborious, comprehensive, and accurate work, which has been of the utmost service to biblical students, was commenced in 1733. The first edition appeared in 1737, and was dedicated to Queen Caroline, who died a few days after the work was presented to her, leaving its author without the acknowledgment he had been led to expect. A second and revised edition appeared in 1761. In the interval between the publication of the two editions he was twice confined in a lunatic asylum, where he seems to have been treated with great cruelty. His chief delusion was that he had received a special divine commission to reform all manner of abuses, and he accordingly assumed the title of Alexander the Corrector. He was in the habit of carrying a sponge with which he effaced all inscriptions that seemed to him contrary to good morals, and in particular he showed his detestation of Wilkes by obliterating the number 45 (the offensive number of the *North Briton*) wherever he found it. Besides laboring constantly at the improvement of his *Concordance*, he prepared a number of other works, including a *Brief Compendium of the Bible*, a *Scripture Dictionary*, and an elaborate index to Newton's edition of Milton. He also wrote a curious autobiography, in which his delusions are very apparent, under the title *Adventures of Alexander the Corrector*. He was found dead in the attitude of prayer on the 1st November, 1770.

CRUSADES. The Crusades were a series of wars undertaken professedly for the purpose of delivering the Holy Land from the dominion of the infidel, and so named from the cross worn as a badge by those who devoted themselves to the enterprise. These wars, it was held, were rendered necessary, not only by the profanation involved in the fact of Mahometan rule over the country which had been the birthplace and cradle of Christianity, but by the insults and injuries constantly inflicted on Christian pilgrims. From age to age the belief had been growing that no work could conduce more to the soul's health than a visit to the holy places of Palestine. In proportion to the rapidity with which this belief had spread over the Christian world, a feeling of vehement indignation was awakened by the likelihood, if not the certainty, that the Saracen conqueror would put his ban on the performance of that which was deemed to be an act of the highest Christian duty.

It is scarcely necessary to say that this was not a notion which can be traced back to the earliest ages of the Christian church, and that the creed of the first believers was in this respect in complete antagonism with the idea which brought the Jews year by year to Jerusalem for the celebration of the Passover. The local ritual which belonged to the only temple known to the Jews had for them been

displaced by a purely spiritual worship, which proclaimed that men were as near to God in one place as in another. In whatever channel their feelings might otherwise have run, the circumstances of the Christian Church in the first century left absolutely no room for the development of local association. Yet a few years and the history of this weary world would be closed by the return of the Son of Man to judgment, and by the summons which should call the dead from their graves. But the course of events which led to the establishment of Christianity as the religion of the Roman empire insured the growth of a sentiment far more nearly allied to that of the Jewish pilgrims, when gathered for the great annual feast in the city of David. The Christian converts in Rome and Corinth, in Athens and Alexandria, had been worshippers of the Capitoline Jupiter, or the Olympian Zeus, of Isis and Osiris, of Phœbus, Artemis, or Mithras. That these converts had undergone a vast change for the better we need not and we cannot doubt; but the framework of their old associations had not been broken, and the men who had followed the journeyings of Phœbus from his birthplace in Delos to his final home in Delphi, might now with feelings immeasurably deeper and more earnest move from spot to spot noted in the gospel narratives, until the pilgrimage, begun in the grotto of Bethlehem, ended on the mount of the ascension. The whole of Palestine thus became sacred soil, but for a time the rapid growth of this local veneration called forth something like remonstrance or warning. Teachers like Augustine could remind their hearers that they were not to seek righteousness in the East, nor mercy in the West, and that a voyage to the Holy Land was a useless task for men whose faith placed them at once in the immediate presence of their Lord. But the practice of some among them was not altogether consistent with their precepts. Jerome could insist that heaven was not more easily approached from Palestine than from Britain; but the saint had crossed the sea to take up his abode in a cave at Bethlehem, and had no rebuke to offer to the Roman ladies who followed him, partly to feast upon his eloquence, and in part to derive strength and comfort from contemplating the scenes of the Saviour's ministry. Such feelings seldom fail to provide their own nourishment. The vehement devotion stirred by the sight of Calvary would impart a priceless value to that instrument which, by bearing the body of Jesus, had become veritably a tree of life; and in due time the yearning for this relic was rewarded by its discovery. Its genuineness had been attested

Teaching of Augustine and Jerome.

by the healing of a dying woman, who derived no benefit from touching the crosses to which the two thieves had been fastened; and the great churches built by the first Christian emperor and his mother over the Holy Sepulchre and the Cave of the Nativity became sanctuaries which the Christians regarded with a devotion immeasurably more passionate than that which the Jews felt for the temple at Jerusalem. The stream of pilgrims, which probably had long been gathering volume, now swelled into something like the proportions of a flood, and each man found not merely that he could worship on spots which brought him nearer to heaven, but that the devotion of the faithful had done or was doing much to smooth the difficulties or lessen the dangers of his journey. It was not wonderful that the enthusiasm thus fostered should give birth to convictions which no calamities could destroy or even shake. According to this new belief the shirt which the pilgrim wore when he entered Jerusalem would, if used as his winding-sheet, carry him straight to heaven. His death, if it happened during his sojourn in Palestine, made him an object of envy to his kinsfolk and friends. If he returned home, he was treated as one whose sins had been washed away, and perhaps as the bearer of relics whose virtues were so potent as to make the weary journey to Jerusalem a work of supererogation.

Discovery of the true cross.

The tide of pilgrimage thus flowing steadily onwards was first arrested by the armies of the Persian king, Khosru II., the grandson of Nushirvan. Jerusalem was taken, 611 A. D.; 90,000 Christians, it is said, were slaughtered; and the disaster was crowned by the carrying away of the true cross into Persia. Marching on into Egypt, Khosru received a letter from a citizen of Mecca, charging him to acknowledge Mahomet as the prophet of the one God. He tore

Capture of Jerusalem by Khosru II.

the letter into shreds. Mahomet replied only by warning him that his treatment of the letter was a sign of the way in which his kingdom would be treated by and by. The punishment of Khoeru was to come, however, not from Mahomet, but from the Emperor Heraclius, who, waking from the sluggish inactivity of the earlier part of his reign, defeated the Persians in the passes of Mount Taurus, and destroyed the birthplace of Zoroaster. In the end Khoeru was murdered by his son Siroea, from whom Heraclius recovered the true cross by a treaty which also delivered those of his subjects who had been taken prisoners by the Persians. In the following year, 629, Heraclius himself knelt among the worshippers in the church of the Holy Sepulchre. Eight years later, 637, the disciples of Mahomet, now lords of Damascus, laid siege to Jerusalem; but after a blockade of four months a treaty

The caliph Omar at Jerusalem.

made with the caliph Omar in person secured to the Christians not merely the safety of their persons and goods, but the free exercise of their religion, subject only to the conditions that Mahometans should have the right of admission to their churches at all hours; that the cross should not be seen on the exterior of any building, or be carried about the streets; and finally, that the Christians should be disarmed, and should show respect to their conquerors by wearing a distinguishing dress and by rising up at the approach of true believers. The hardships thus imposed may have been sensibly felt; but pilgrims and merchants still came and went practically without let or hindrance; and even the attack of the Fatimite caliph Hakem, four centuries later, 1010, scarcely changed things for the worse. The rule of his predecessors in Egypt had for the Christians been lighter than that of the Abbasside caliphs of Baghdad; but the object on which the mad Hakem had set his heart was nothing less than the destruction of the great Christian sanctuary. Such persecution as there was fell on the Jews only, and the tax imposed on each pilgrim and levied on his entering Jerusalem was probably not resented as a wrong. To the wealthier Christians it brought an opportunity for securing a higher degree of merit by paying the charge for their poorer brethren; while the completion of the first Christian millennium removed a burden which had lain with increasing heaviness on the spirits and energies of men, and gave a fresh impetus to the feeling which carried the devout to the Holy Land.

Revival of pilgrimage after the 10th century.

The end of the 10th century, it was almost universally believed, would be the end of the world. The beginning of a new age relieved them of this mental incubus, and the stream of pilgrims became larger than ever. The path followed by these devotees was not always strewn with roses. Inclement seasons, poverty, and sickness proved fatal to many; but these disasters were not caused by the attack of open enemies, and the conversion of Hungary removed a formidable obstacle for those who had to traverse the heart of Europe in order to reach Palestine.

Conquests of the Seljukian Turks.

A few years later these fairer prospects were permanently clouded by the advance of the Seljukian Turks, who in their inroads into the Eastern empire found themselves effectually aided by the subjects of the emperor. The causes of discontent were indeed many and deep. Extortion and tyranny, both secular and ecclesiastical, had alienated thousands, while the population was seriously lessened by the accumulation of land in the hands of a few owners. Before the close of the 11th century, 1078, Jerusalem had opened her gates to the Seljukian Toucush; and in place of a legal toll the pilgrims found themselves subjected henceforth to indefinite extortion, to wanton insult, and to massacre. The sanctuaries of the Christians were profaned, their worship was interrupted, their patriarchs were thrown into dungeons. The effect of these changes was felt not by the devout only. The supplying of their wants had called forth the energies of merchants; and the fleets of Genoa, Pisa and Amalfi hurried to the ports of the Holy Land for the great Easter fair at Jerusalem. All these were now driven away, and there remained only the miserable train of pilgrims, who returned to Europe, if they returned at all, with tales of dire indignities done to men, women, and children alike.

The recital of these wrongs went far towards fanning into flame the feelings which the popes had hitherto failed to waken in sufficient strength. The idea of an armed host

which should inflict summary vengeance on the oppressors of the Christians had already dawned on the mind of the great Hildebrand, Gregory VII.; it had been vehemently urged by his successor Victor III.; but neither had struck the right chord. Such enterprises can never be set in motion, with any solid results, except when the flood-tide of popular feeling gives its own weight to the sanction of religious authority. Nor was this result more satisfactory when, in 1081, Robert Guiscard set out from Brundisium (Brindisi) with a fleet of 150 ships and a force of 30,000 men. Guiscard himself besieged Dyrrhachium (Durazzo) in vain; under his son Bohemond his fleet was miserably defeated. Four years later Guiscard made another attempt, which was frustrated by his death at Cefalonia (Kephallenia). But Hildebrand had been dead only ten years when a vast throng of clerks and laymen was gathered to meet Urban II. at Piacenza (Placentia). In Italy, however, Urban felt that he could not look for the enthusiasm which would justify him in making the final venture. From Piacenza he made his way to his old home in the great abbey of Cluny, and in the autumn of 1095 appeared at Clermont, in the territories of the count of Auvergne.

Efforts of Hildebrand (Gregory VII.).

Here he found that there was no longer any need of holding back. To the north of the Alps the indignation of the people had been roused to fever heat by the preaching of Peter the Hermit. With the stature and ungainliness of a dwarf, emaciated by the austerities of his self-imposed discipline, this man, who had forsaken his wife and abandoned his military standard under the counts of Boulogne, had returned from the Holy Land with his heart on fire, not so much from the memory of the hardships which he had himself undergone as for the cruelties and tortures which he had seen inflicted on his fellow-Christians. Simeon, the patriarch of Jerusalem, to whom he first betook himself, could only bewail the weakness of the emperor and of his government. "The nations of the West shall take up arms in your cause," was the reply of the hermit, who soon afterwards, armed with the special blessing of Urban II., mounted his ass, and with bare head and feet, carrying a huge crucifix, traversed the Teutonic lands, rousing everywhere the uncontrollable indignation which devoured his own soul.

Preaching of Peter the Hermit.

His vehemence carried all before him, none the less, perhaps, because he bade them remember that no sins were too heinous to be washed away by the waters of the Jordan, no evil habits too deadly to be condoned for the one good work which should make them champions of the cross. Urban, however, and his counsellors, knew well that before the fatal die could be prudently cast a serious task lay before them. The system of feudalism substituted personal ascendancy for the dominion of law; and wherever the personal bond failed, the resort was inevitably to private war. The practice of such wars had become virtually an organized trade; and if a large proportion of the population should be drawn away to fight against the infidel in Palestine, those who remained at home would be without defence. Such wars were therefore formally condemned; the women and the clergy, merchants and husbandmen, were placed under the special protection of the church, and the Truce of God was solemnly confirmed. The nearer and more immediate dangers being thus guarded against, Urban from a lofty scaffold addressed the assembled multitude, dwelling in the

Speech of Pope Urban II. at Clermont.

first place, and perhaps not altogether prudently, on the cowardice of the Turks, and on the title to victory which birth in a temperate climate conferred on the Christians. They were thus sure of success, and sure, too, to win an infinitely higher blessing—the remission of their sins. Sufferings and torments more excruciating than any which they could picture to themselves might indeed await them; but the agonies of their bodies would redeem their souls. "Go then," he said, "on your errand of love, which will put out of sight all the ties that bind you to the spots which you have called your homes. Your homes, in truth, they are not. For the Christian all the world is exile, and all the world is at the same time his country. If you leave a rich patrimony here, a better patrimony awaits you in the Holy Land. They who die will enter the mansions of heaven, while the living shall pay their vows before the sepulchre of their Lord. Blessed are they who, taking this vow upon them, shall obtain such a recompense; happy they who are led to such a conflict, that they may share

In such rewards." With the passionate outburst, "It is the will of God, it is the will of God," the vast throng broke in upon the Pontiff's words. "It is, indeed, His will," the Pope went on, "and let these words be your war-cry when you find yourselves in presence of the enemy. You are soldiers of the cross; wear then on your breasts or on your shoulders the blood-red sign of Him who died for the salvation of your souls."

So was sanctioned the mighty enterprise which hurled the forces of Latin Christendom on the infidels who had crushed the East under the yoke of Islam; and so it received its name. Of the thousands who hastened to put on the badge the greater number were animated probably by the most disinterested motives, while some had their eyes fixed on the results of more politic calculations. For the multitude at large there was the paramount attraction of an enterprise which the abbot Guibert boldly put before them as a new mode of salvation, which enabled the layman without laying aside his habits of wild license to reach a height of perfection scarcely to be attained by the most austere monk or the most devoted priest. Nay more, the assumption of the cross set the debtor free from his creditor so long as he wore the sacred badge, opened the prison door for the malefactor, annulled the jurisdiction of the lord over the burgher or the peasant, and enabled the priest and the monk to escape from the monotony of the parish and the cloister. It might be thought that these privileges would tell hardly on the creditor, the capitalist, and the usurer; but these reaped the most solid benefits. The princes who bound themselves by the vow must provide equipments for themselves and their followers, and carry with them sums of money sufficient for their needs. These sums must be raised by loan or mortgage; and as all wished to get horses, arms, and money in exchange for lands, the former became inordinately dear, the latter absurdly cheap. Thus the real gain lay on the side of the merchant and the trader, or of the landowner who was prudent enough to add to his own domains by availing himself of the necessities of his neighbor. All this, however, had been effected by the authority and sanction of the Holy See, which had

taken under its protection the dominions of all crusading princes. It was for the Pope to decide whether those who had taken the vow should set off at once, whether some grace time should be allowed, or whether the vow should be remitted altogether. The Pope became therefore possessed of a dispensing power which placed him virtually above all other sovereigns. His gains, moreover, were immediate. The crusades tended, beyond doubt, to merge the smaller into larger fiefs, which again were absorbed into the royal domain, thus largely promoting that growth of the sovereign power which in the end broke up the feudal system. Those results belonged to the distant future; but the Pope was enabled, rather he was constrained, to send his legates into every land, both to enlist soldiers under the standard of the cross, and to collect money for their support. He became thus at once the administrator of vast revenues which were raised partly by subsidies imposed as a necessary obligation on the clergy, and in part by the voluntary contributions of the laity. With the Pope the ecclesiastical body generally acquired enormous power. The lands of the church, though money might be borrowed upon them, could not be alienated; but it was only in comparatively a few instances that it was necessary to burden them at all. The monastic houses might send some of their members to the Holy Land; the rest remained at home, and became mortgagees or trustees of estates belonging to the crusaders. If these died without heirs, the guardians became absolute owners; and of those who returned not a few withdrew into the cloister, and endowed with their worldly goods the community which they joined.

In the enterprise sanctioned by the Council of Clermont, no nation, as such, took any part; and this fact serves perhaps to explain the measure of its success and its failure. Had it been necessary to wait for strictly national action, the work perhaps would never have been done at all; but had it been a national undertaking some attempt must have been made to establish a commissariat, and to insure something like harmonious and efficient generalship. As it was, the crusading army was simply a gathering of individual adven-

turers who depended on their own resources, or of reckless pilgrims who neither possessed nor cared to provide any. The contributions made to this army by the different countries of Europe varied largely. From Italy, where the charm was in great part dispelled by the struggle between Pope and anti-Pope, few came besides the Normans who had fought under the standards of Robert Guiscard. The Spaniards were fully occupied with a crusade nearer home, which was to turn the tide of Mahometan conquest that had once passed the barriers of the Pyrenees and threatened to flow onwards to the shores of the Baltic. In Germany there was no great eagerness among partisans of emperors whom popes had sought to humble, to undertake a difficult and dangerous pilgrimage. In England the condition of things which followed the victory of William over Harold prevented both the conquerors and their subjects from committing themselves to distant enterprises, while the Red King was more anxious to have the duchy of his brother Robert in pledge than ready to run the risk of losing his own kingdom. Thus the task of reconquering Palestine fell to princes of the second order. Foremost among these was Godfrey of Bouillon in the Ardennes, duke of Lothringen (Lorraine), whose high personal character brought to his standard, we are told, not less than 10,000 horsemen and 80,000 infantry, and who was accompanied by his brothers Baldwin and Eustace count of Boulogne. Next to him, perhaps, may be placed (1) Hugh, count of Vermandois, surnamed the Great, according to some, as being the brother of Philip I., the French king, or as others would have it, simply from his stature; (2) Robert, duke of Normandy, who had pawned his duchy to his brother the English king, and who was destined to end his days in the dungeons of Cardiff castle; (3) Robert, count of Flanders, celebrated by his followers as the Sword and Lance of the Christians; (4) Stephen, count of Chartres, Troyes, and Blois; (5) Adhemar (Aymer), bishop of Puy, the first of the clergy who assumed the cross, and rewarded as such with the office of Papal legate; (6) Raymond, count of Toulouse, lord of Auvergne and Languedoc, the leader, it is said, of 160,000 horse and foot, and widely known for his haughtiness and his avarice not less than for his courage and his wisdom; (7) the politic and ambitious Bohemond, son of Robert Guiscard, who had left to him, not his Apulian domains, but only the principality of Tarentum, to which Bohemond was resolved to add a kingdom stretching from the Dalmatian coast to the northern shore of the *Ægean* Sea; (8) Tancred, son of the Marquis Odo the Good and of Emma, the sister of Robert Guiscard, the hero who beyond all his colleagues appears as the embodiment of those peculiar sentiments which gave rise to the crusades, and who approaches nearest to the idea of Chaucer's "very perfect gentle knight."

The Feast of the Assumption, August 15, 1096, had been fixed at the Council of Clermont as the day on which the crusaders should set off for Constantinople; but little more than half the interval had gone by, when the hermit Peter undertook the task of leading to Palestine a motley crowd of men and women. Peter was accompanied as far as Cologne by Walter the Penniless, who thence led his followers to Hungary, while another multitude marched under Emico, count of Leiningen, and a fourth followed the guidance of the monk Gotschalk. Behind these came, we are told, a throng of men, women, and children, amounting to 200,000, under standards on which were painted a goose and a goat, symbols of the mysterious faith of Gnostics and Paulicians. These undisciplined multitudes turned fiercely upon the Jews, who were massacred in the streets of Verdun, Treves, and the great Rhenish cities, until the emperor interfered and took them under his protection. Of the followers of Peter 7000 only, it is said, reached Constantinople. These by the orders of the Emperor Alexius were at once conveyed across the Bosphorus, and there, with the bands of Walter the Penniless, fell into a trap laid for them by the Seljukian Sultan David, surnamed Kilidj Arslan, the Sword of the Lion. A heap of bones alone remained to tell the story of their destruction, when the hosts under Godfrey came thither on their march to Palestine. These had advanced unopposed as far as the Hungarian border, where three weeks were lost

General condition of Europe.

The chiefs of the first crusade.

Departure of the pilgrims under Peter the Hermit.

March of the main body under Godfrey.

in negotiations with the Hungarian king, who dreaded a repetition of the violence which his people had suffered at the hands of the rabble led by Peter and the moneyless Walter. With Stephen of Chartres, Robert of Flanders, and Robert of Normandy, Hugh of Vermandois had set out to make his way through Italy, and taken ship at Bari. Wrecked on the coast between Paos and Durazzo, he was detained at the latter place until the pleasure of the Emperor Alexius should be known. Alexius at once ordered that he should be brought to Constantinople, and so charmed his prisoner by the gracious manner which he could put on or off at will, that Hugh not only paid him homage and declared himself his man, but promised so far as he could to get his colleagues to follow his example.

The tidings of Hugh's detention roused the wrath of Godfrey, who, having in vain demanded his release, marched from Philippopolis, and appeared before the walls of Constantinople at Christmas 1096. Alexius saw before him a mighty host; another not less formidable was on its way, he was told, under Bohemond and Tancred; and Bohemond, as he knew, claimed by right of inheritance no small part of his empire. These swarms he had brought upon his land by his appeals for the aid of Western Christendom, and he was now anxious at one moment to rid himself of their presence, at another to win the submission of the crusading chiefs, and so obtain a hold on their future conquests. At length a compact was made by which they gave him their fealty so long only as they remained within his borders, and pledged themselves to restore those of their conquests which had been recently wrested from the empire, while on his part he promised to supply them with food and to protect all pilgrims passing through his dominions. Bohemond, on reaching Constantinople, was indignant when he learnt that his colleagues had become vassals of the emperor; but he soon found that he must at least appear to follow their example, and he was repaid by a splendid bribe from Alexius, who adopted Godfrey as his son. With Raymond of Toulouse Alexius had a harder task. This chief, who scarcely regarded himself as the vassal even of the French king, refused to do more than be the emperor's friend on equal terms, even though Bohemond threatened that, if the quarrel came to blows, he should be on the side of Alexius. The latter, however, soon saw through the temper of Raymond; and the harmony which followed this dispute was so thorough that Anna Comnena could speak of him as shining among the barbarians as the sun among the stars of heaven.

It was not until the Feast of Pentecost, 1097, that the last of the bands of Latin pilgrims was conveyed to the Asiatic shore. During the whole interval the risk of conflict between the Latins and Greeks had been great. Between them there was in truth a radical opposition. The crusading chiefs hated the idea of a central authority, and clung to the right of private war as the dearest of their privileges. Of public law they could scarcely be said to know anything. The Greeks, on the other hand, were ready to put up with a large amount of corruption in their rulers so long as these secured to them the protection of person and property. Among the Latins, again, the clergy, having been brought by Hildebrand and Damiani under the yoke of celibacy, had become a close order or caste, which shrunk from the notion of allegiance to any temporal master. As a rule the Greek priests were married; and as they owned the authority of the emperor, they were despised by their Western brethren for their cowardice. In short, there was nothing to bring the two peoples together, and everything to exasperate the suspicion and hatred which had grown up between them.

Whatever may have been the numbers of the crusaders (and the chaplain of Count Baldwin could speak of them as six millions), they found themselves on the eastern shore of the Bosphorus confronted by a formidable adversary in Kiliđj Arslan, who, retreating with his horsemen to the mountains, swooped down upon the Christians, by whom his capital city of Nice (Nikaia) was vainly invested for seven weeks. At length the city was surrendered, not to the crusaders but to Alexius, and the former, advancing on their eastward march, were again confronted by the Turks near the Phrygian Dorylseum. The battle, desperately contested, ended in the complete defeat of the latter; but the son of Kiliđj

Arslan, hastening on before the crusaders as they marched to Cogni, Ereklj, and the Pisidian Antioch, gave out before the gates of each city that he was come as a conqueror. On his way he had ravaged the land; in the towns the houses had been plundered and the granaries emptied; and the crusaders had to journey through a country which could supply nothing. The burning heat caused fatal sickness; and as if these miseries were not enough, the acquisition of Tarsus was followed by an attempt at private war between Tancred and Baldwin, owing to a dispute for the precedence of their banners. The remissness of the enemy who might easily have cut them off in the passes of Mount Taurus, allowed them to march safely through the defiles; and Baldwin, Godfrey's brother, was enabled to comply with a request for help made by the Greek or Armenian ruler of Edessa. Welcomed into the city Baldwin made himself master, and the Latin principality of Edessa thus established lasted for fifty-four or, as some have supposed, forty-seven years.

In the Syrian Antioch the crusaders hoped to win a splendid prize at the cost of little effort or none. Its walls were mostly in ruins; but the Seljukian governor, Baghasian, had resolved on determined resistance. The siege which followed has no interest for the military historian. At no time was the blockade complete, and it was brought to a successful issue only by treachery. Three months had already passed when the crusaders found themselves in desperate straits for want of food. They had wasted with frantic folly the cattle, the corn, and the wine which had fallen into their hands; and when this first famine was relieved by a foraging expedition under Tancred, the supplies so brought in were wasted with equal recklessness. A second famine drove away not only Taticius, the lieutenant of the Greek emperor, but William of Melun, whose sledge-hammer blows dealt in battle had won him the surname of the Carpenter, and even the hermit Peter. Taticius made his way to Cyprus; the other two were caught and brought back to the camp by Tancred. It was at this time, when the general prospect seemed so discouraging, that envoys from the Fatimite caliph of Egypt offered to guarantee to all unarmed pilgrims an unmolested sojourn of one month in Jerusalem, and to aid the crusaders on their march to the Holy City; if they would acknowledge his supremacy within the bounds of his Syrian empire. The reply of the crusaders was brief and definite. God had destined Jerusalem for Christians; if any others held it, they were invaders who must be cast out. This defiance was followed by a victory won over some reinforcements which were hastening from Cesarea and other cities to the aid of Baghasian. But the time went on; the siege was still protracted; and there were rumors that a Persian army was approaching. To Bohemond it seemed that there was no hope of success except from fraud, and that from fraud he might reap a goodly harvest. In a renegade Christian named Phiroux he found a traitor ready to do his work; and he was able now to announce in the council that he could place the city in their hands, and that he would do so if they would allow him to rule in Antioch as Baldwin ruled in Edessa. In spite of a protest from Raymond of Toulouse the compact was accepted, 1098; and on the same night Bohemond with a few followers climbed the wall, and having seized ten towers, of which they killed all the guards, opened a gate, and admitted the Christian hosts. In the confusion which followed their entrance some of the besieged shut themselves up in the citadel. Of the rest 10,000, it is said, were massacred. Baghasian escaped beyond the besiegers' lines; but he fell from his horse, and a Syrian Christian, cutting off his head, carried it to the camp of the crusaders, who now passed from famine to plenty, from extreme hunger to wild riot. They were committing a blunder as well as a sin. The Persians were at hand; and the Turks in the citadel found that the crusaders lay between themselves and the hosts of Kerboga, prince of Mosul, and Kiliđj Arslan. The Latin camp was again wasted with famine. Stephen of Chartres, who had deserted it before the betrayal of the city to Bohemond, had on his westward journey met the Emperor Alexius, who was marching to the aid of the crusaders with a large body of pilgrims from Europe. Stephen's tidings were followed by an order for retreat, and the pilgrims were compelled to turn back with their companions. Protesting in vain against this shameful breach

Latin principality of Edessa.

Siege of Antioch.

of his duty and his vow, Guy, a brother of Bohemond, said in the vehemence of his rage that if God were all-powerful He would not suffer such things to be done.

**Miraculous discovery of the Holy Lance.** In Antioch the desperation of the crusaders made them listen eagerly to stories of dreams and revelations from heaven. A Lombard priest had learnt in a vision that the third year of the crusade should see the conquest of Jerusalem; and those who had heard from the lips of the Saviour Himself a rebuke of the vices which had caused all their disasters, had also been assured that in five days the needful help would be granted to them. The impulse, once given, gained strength. Peter Barthelemy, the chaplain of Raymond of Toulouse, related a revelation made to him by St. Andrew. The steel head of the spear which had pierced the side of the Redeemer as He hung on the cross had been hidden, according to this tale, in the church of St. Peter; and the recovery of this lance would be followed by immediate and decisive success. Two days were to be spent in special devotion; on the third they were to search for the long-lost weapon. The night had come, and their toil had thus far gone for nothing, when the priest stepped down into the pit. After some strokes of his spade he came upon the holy relic, which was carefully wrapped in a cloth of silk and gold. The priest displayed the lance head; and in a few minutes the wonderful tidings had been spread through the city. A few months later Arnold, the chaplain of Bohemond, publicly denied the genuineness of the relic, and charged the chaplain of Raymond with deliberate imposture. Barthelemy appealed to the ordeal of fire, and passed it, to all appearance, successfully. The bystanders were loud in their exultation; but Peter had been fatally injured, and in a few days he died.

**Defeat of Kerboga and fall of Antioch.** Meanwhile the holy lance, borne by the Papal legate Adhemar, had effectually aided the crusaders in the decisive struggle with Kerboga, before whom Peter the Hermit had appeared as an envoy charged to submit to him the alternative of baptism or of retreat from a land which St. Peter had bestowed upon the Christians. The answer was a curt refusal, and a battle followed in which Bohemond was severely pressed by Kilidj Arslan, and Kerboga was bearing down the forces of Godfrey and Hugh of Vermandois, when some knights, clothed in white armor and mounted on white horses, were seen riding along the slopes of the neighboring hills. "The saints are come to our help," cried the Papal legate, and the imagination of the people at once beheld in these strangers the martyrs St. George, St. Theodore, and St. Maurice. The impulse imparted by this conviction was irresistible. The complete defeat of Kerboga and Arslan was followed by the surrender of the garrison in the citadel, and Bohemond remained lord of Antioch.

**Sufferings of the crusaders.** The crusaders as a body wished to set off at once on their march to Jerusalem; but their leaders shrank from the danger of traversing waterless wastes at the end of a Syrian summer.

While some of the crusaders were busied with expeditions against neighboring cities, many more were pressed by more anxious cares, arising from an outbreak of plague which proved fatal, among others, to the Papal legate Adhemar.

**March of the crusaders to Jerusalem.** Ten months after the fall of Antioch the crusaders having become masters of Laodicea, were bidden by the Emperor Alexius to await his coming in June. But with him their forbearance had reached its limit, and they bade him remember that, having broken his compact, he had no longer any claim on their obedience. Marching across the plain of Berytus and along the narrow strip of country once celebrated for the wealth and splendor of the great Phœnician cities, the army at length reached Jaffa, and thence turned inland to Ramlah, a town only sixteen miles distant from Jerusalem. Two days later they came in view of the holy city. At the sight of the distant walls and towers all fell on their knees, in an outburst of thankfulness which could express itself only in sighs and tears, while they stooped to kiss the sacred soil. The rest of the march they performed with bare feet and in the garb of pilgrims; but their armor was again put on, when Raymond of Toulouse with his followers invested the city from the western side, while Godfrey and Tancred, with Robert of Normandy and Robert of Flanders, blockaded it from the north. On the fifth day a desperate attempt was made to storm the walls,

with a single ladder and with no siege instruments. It was no wonder that in spite of all their efforts the assailants should be beaten back and hurled from the ramparts. Thirty days more

Siege and conquest of the holy city

passed away, while Gaston of Bearn was busily occupied in directing the construction of siege engines of timber brought from the woods of Shechem. During the whole of this time the besiegers were in the greatest distress from lack of water. All the cisterns and receptacles of any kind had been carefully destroyed by the enemy, whose horsemen harassed or cut off the parties of Christians who were sent about the country to search for it. Nor was the discipline of the camp by any means what it should be; and the phantom of Adhemar of Puy appeared, it was said, to denounce the license which was provoking the divine judgments. But if there was wild riot in some quarters, there was devotion and enthusiasm in others. Tancred generously made up his quarrel with Bohemond, and like the Levites round the walls of Jericho, the clergy moved round the city in procession singing hymns and followed by the laity. The Saracens, it is said, insulted them from the walls by throwing dirt upon crucifixes. On the second day of the final assault, when it seemed that in spite of almost superhuman efforts the crusaders must fail, a horseman was seen, or supposed to be seen, waving his shield on Mount Olivet. "St. George the Martyr has again come to help us," shouted Godfrey, and the cry, taken up and carried along the ranks, banished every feeling of weariness, and sent them forth with overwhelming strength for the supreme effort. It was Friday; and at the moment in the afternoon when the last cry was uttered by the Saviour on His cross Letold of Tournay, it is said, stood on the walls of Jerusalem, followed first by his brother Engelbert, and then by Godfrey. The gate of St. Stephen was stormed, by Tancred; the Provençals climbed up the ramparts by ladders; and the city was in the hands of the Christians. So terrible, it is said, was the carnage which followed that the horses of the crusaders who rode up to the mosque of Omar

Slaughter of the infidels.

were knee-deep in the stream of blood. Infants were seized by their feet and dashed against the walls or whirled over the battlements, while the Jews were all burnt alive in their synagogue. In the midst of these horrors Godfrey entered the church of the Sepulchre, clothed in a robe of pure white, but bare-footed as well as bare-headed, and knelt at the tomb to offer his thanksgiving for the divine goodness which had suffered them to realize the yearning of their hearts. In the profound enthusiasm and devotion of the moment his followers beheld the dead take part in the solemn ritual, and heard the voice of Adhemar rejoicing in the prayers and resolutions of penitence offered by the prostrate warriors of the cross. Among the living, too, there were those who called forth the deepest gratitude; and the vast throng fell at the feet of the hermit Peter, who thus saw the consummation of the enterprise which was mainly his work, and of whom after the completion of his task we hear no more. On the next day the horrors of that which had preceded it were deliberately repeated on a larger scale. Tancred had given a guarantee of safety to 300 captives. In spite of his indignant protest these were all brought out and killed; and a massacre followed in which the bodies of men, women, and children were hacked and hewn until their fragments lay tossed together in heaps. The work of slaughter ended, the streets of the city were washed by Saracen prisoners.

So ended the first and the most important of the crusades. Its history shows us clearly the nature of these religious wars and the mode in which they were carried on. Those which follow may be more briefly noticed, as they tend generally to assume more and more of a political character. The first crusade had to all appearance fully attained its object. Godfrey was really king of Jerusalem, although he would not bear the title in a city where his Lord had won the crown of thorns. His reign lasted barely one year, and this year was signalized less by his victory over the Fatimite caliph of Egypt than by the promulgation of the code of laws known as the Assize of Jerusalem. These laws embodied the main principles of feudalism, while they added a new feature in the judicial courts, the king presiding in the court of the barons, his viscount in that of the burgesses. On Godfrey's death his brother Baldwin was summoned from his principality of Edessa, 1100, and crowned king by the Patriarch Daim-

Latin kingdom of Jerusalem.

Assize of Jerusalem.

bert. During his reign of eighteen years most of the old crusading chiefs passed away. Stephen of Chartres was slain at Ramleh in 1101.

Four years later Raymond died on the sea-coast. In 1112 Tancred was cut off in the prime of manhood, three years after Bohemond had ended his stormy career at Antioch. The Emperor Alexius, the only man who derived lasting benefit from these expeditions, outlived them all. If his empire was to last, the Turks must be drawn off from the nearer regions of Asia Minor. This result the crusades accomplished, and thus prolonged the existence of the empire for three centuries and a half. The second successor of Godfrey was his kinsman Baldwin du Bourg, in whose reign, 1118-31, Tyre became the seat of a Latin archbishopric. After Baldwin II, the uneventful reign of Fulk of Anjou (1131-44) was followed by that of his son Baldwin III, a boy thirteen years of age (1144-62), in whose days the fall of Edessa called forth again the religious enterprise of the West. Of this second crusade St.

Bernard was the apostle, as the hermit Peter had been of the first. In the Council of Vezelai, 1146, Louis VII, the French king, put on the blood-red cross, and his example was reluctantly followed some months later by the Emperor Conrad. The story of this expedition brings before us a long series of disasters. Conrad lost thousands in an attempted march across Asia Minor; Louis took ship at Attalia and succeeded in making his way to Jerusalem. Conrad at length reached Ptolemais; and the two sovereigns, abandoning the project of rescuing Edessa, resolved to turn their arms against Damascus, 1148. The siege was a miserable failure, brought about, it is said, by the treachery of the barons of Palestine. Bernard himself was for the moment overwhelmed by the completeness of the catastrophe; but the conviction of the reality of his own mission soon assured him that the fault lay in the sinfulness of the pilgrims—an idea which, having fixed itself in some minds, had its issue in the pathetic and awful tragedies called the Children's Crusades. None but innocent hands, it was thought, could accomplish the work of conquest in the Holy Land; and in 1212 the great experiment was tried, with 30,000 children, so the tale went, under the boy Stephen, and 20,000 German boys and girls under the peasant lad Nicholas, to end in death by sea or on land, or in the more fearful horrors of the slave-market. For the present this notion was only in embryo; and the monk John had more success in reviving old feelings by declaring that the places of the fallen angels had been filled by the spirits of those who had died as champions of the cross in Bernard's crusade. In 1162 Baldwin III. died at the early age of thirty-three. The great aim of his brother Amalric, who succeeded him, 1162, was to obtain possession of Egypt and thus prevent Noureddin, the sultan of Aleppo, from establishing himself in a country which would enable him to attack the Latin kingdom from the south as he already could from the north. It may be said that nothing but his own greed for money stood in the way of his success; and Saladin, the nephew of Noureddin, was thus enabled to rise to power in Egypt, and finally, by setting aside the Fatimite caliph, to put an end to a schism which had lasted 200 years. Nor was this all. Amalric's son and successor, Baldwin IV., was a leper, who, being obliged by his disease to appoint another as his delegate, fixed on Guy of Lusignan, the husband of his sister Sibylla. For the time the arrangement came to naught; but when in 1186 the death of Baldwin IV. was followed in a few months by that of Baldwin V., the infant son of Sibylla by her first marriage, Guy managed to establish himself by right of his wife as king of Jerusalem. Over his kingdom the storm was now ready to burst. The army of Saladin assailed Tiberias; and Raymond, count of Tripolis, the son of Raymond of Toulouse, although he had refused to own his allegiance to Guy, hastened to Jerusalem to beg the king to confine himself to a defensive warfare, which could not fail to be crowned with success. His advice was rejected; and the fatal battle of Tiberias, 1187, almost destroyed the army which should have defended the capital, while the true cross fell into the hands of the conquerors. Against the comparatively defenceless city Saladin now advanced; but he pledged himself that, if it

were surrendered, he would provide for the inhabitants new homes in Syria, and would supply them with the money which they might need. His offer was refused, and Saladin made a vow that he would take ample vengeance. But when at length the issue was seen to be inevitable and the besieged threw themselves on his mercy, Saladin agreed that the nobles and fighting men should be sent to Tyre, and that the Latin inhabitants should be reduced to slavery only if they failed to pay a ransom fixed according to age and sex. Having entered the city, Saladin advanced to the mosque of Omar. As he approached, the cross, which still flashed on its summit, was hurled to the ground and trailed through the mire. Thus fell the Latin kingdom eighty-eight years after Godfrey became the Defender of the Holy Sepulchre. At no time had it exhibited any signs of real stability. Resting on the rule that no faith was to be kept with the unbeliever, it justified treachery. It recognized no title to property except in the Christians, and the temptation thus held out to robbery went far to demoralize the people. It kept up constant irritation by petty forays, while it did little to promote military science or discipline. Its leaders were for the most part devoid of statesmanship. As banded together rather for a religion than a political purpose, they could withdraw from the enterprise as soon as they had fulfilled their vows, and thus the cohesion needed for its permanent success was unattainable. More than all, it had to put up with, if it did not sanction, the growth of societies, each of which claimed independent jurisdiction over its own members. The great military orders of the Hospital and the Temple had come into existence as fraternities devoted to works of mercy in behalf of poor pilgrims. But under the conditions of their sojourn in Palestine it was necessary to bear arms; the bearing of arms involved the need of discipline; and the military discipline of a brotherhood animated by monastic enthusiasm became formidable. These orders were further strengthened by privileges and immunities conferred, some by the kings of Jerusalem, some by the popes. Their freedom from tithe brought them into direct antagonism with the clergy, and the clergy in their turn complained that these orders gave shelter to excommunicated persons, while the fiercest enmity of the Temple was reserved for his brother of the order of the Hospital of St. John. On a kingdom composed of such elements as these the old curse of the house divided against itself cannot fail to descend.

It may have been something like the insight of a statesman which led King Amalric to fix his thoughts on the conquest of Egypt, as the means, not only of preventing the co-operation of hostile powers to the north and the south of the Latin kingdom, but of opening a country of vast resources to the merchant and the trader. There can be no doubt that these considerations prompted the Lateran Council, 1179, to declare that the first object of every crusade should be the conquest of Damietta; but with this determination these enterprises ceased to be strictly crusades, and the old spirit is seen again only in the royal saint, Louis IX. For the time the fall of Jerusalem seemed to waken again the impulse which had stirred the hearts of Godfrey and Tancred. On the plain between Gisors and Trie the pleadings of William, archbishop of Tyre, prevailed with Henry II. of England and Philip Augustus of France to assume the cross, 1188. Having thus far shown a marked reluctance to the undertaking, Henry may now have really meant to fulfil his promise; but the quarrels and treachery of his sons interposed a fatal hindrance, and soon brought him to his grave. For his son and successor, Richard, the idea of rescuing the holy city from the Turk had an irresistible attraction, and his whole mind was bent on raising money for the purpose. This task done, he met the French king at Vezelai, where forty-four years ago Louis VII. had listened to the vehement eloquence of Bernard. The two sovereigns made their way to Sicily, while the Emperor Frederick I. (Barbarossa) was advancing with his host to Constantinople. Frederick himself was drowned in a Cilician river, 1190, and of those whom he had brought across the Bosphorus not a tenth, it is said, reached Antioch. The efforts of the Latins of Palestine were now directed chiefly against Acre, which had been besieged for two years before Richard and

Conquest of Jerusalem by Saladin.

Causes leading to the fall of the Latin kingdom.

The third crusade.

Death of Frederick I.

Philip set foot on the Holy Land. The former was prostrated with fever; but his fiery zeal proved stronger than his sickness, and Saladin was compelled, 1191, to assent to a compact which bound him to surrender the true cross, and to give hostages for the payment of 200,000 pieces of gold within forty days. The money was not paid in time, and the hostages, numbering 3000 or more, were all, it is said, slaughtered on the summit of a hill from which the tragedy might be seen in the camp of Saladin. The sequel of the story tells us of battles won and lost to little purpose. The victory of Richard at Azotus opened

the road to Jaffa and Jerusalem, and the army had advanced as far as Ramlah, when the men of Pisa, with the knights of the Hospital and the Temple, insisted that the troops could never be kept together after the recovery of Jerusalem, and thus that its re-conquest would really be fatal to the crusade. In June, 1192, Richard again led his forces towards the holy city, and was again foiled by the lack of a commissariat and the destruction of the wells and cisterns, which for miles round had been shattered by the enemy. His prowess was signally shown in the relief of Jaffa; but in the issue he obtained from Saladin simply a truce for three years and eight months, which insured to pilgrims the right of entering Jerusalem untaxed; and thus, leaving the Holy Land, he set out on the homeward journey which was to be interrupted by a long captivity in a Tyrolese castle as the prisoner of Henry VI. Although this third crusade had been marked by the woeful waste of splendid opportunities, it had still secured to the Christians the possession of a long strip of coast, bounded by two important cities, which might serve as a base of operation in future enterprises, while it had also done much to neutralize the results which Saladin had looked for from his earlier victories.

The fourth crusade may be dismissed in a few words. It was an enterprise set on foot by the knights of St. John, 1193, seconded by Pope Celestine III., in the hopes of getting rid of the Emperor Henry VI., the son of Barbarossa, who claimed the island of Sicily, and encouraged by Henry as a means for promoting his own designs. Henry had no intention of going on the errand himself; but his barons with their followers defeated the Turks between Tyre and Sidon, 1196, recovered Jaffa, which had been taken after Richard's departure, obtained possession of Berytus, and lost all that they had gained by their folly and disunion in the siege of the castle of Thoron, 1197. Jaffa was again taken by the Saracens; and the Latin kingdom became little more than a title with which Isabella, the sister of Baldwin IV., linked that of Cyprus on her marriage with Amalric of Lusignan, who had succeeded his brother Guy as sovereign of that island.

The fifth crusade was an undertaking of vastly greater importance. Innocent III., who now sat in St. Peter's chair, was a man of incomparably loftier genius than Urban II., and he was raised to the Pontifical throne, 1198, at a time when the European world generally seemed in a state of dissolution. He saw at once how in such a state of things the crusades had served and would serve to promote the Papal power. But if the popes had thus the means and the justification for interfering in the affairs of every kingdom, and acquired the power of demanding contributions, levying subsidies, and dispensing with or enforcing vows, the mode in which the revenues so raised had been administered had roused a wide and deep suspicion which might more than counterbalance all the gains. Hence it came to pass that Innocent, even in the plentitude of his spiritual pretensions, was compelled to defend himself against charges of personal corruption; and when in Fulk of Neuilly he had found an apostle not less devoted and only less eloquent than Bernard, the same suspicion came in to chill enthusiasm and lead men to criticise rather than to worship. Nevertheless, a goodly company prepared for the great work was at length brought together, 1201, the most prominent among the leaders being Simon of Montfort, Walter of Brienne, and Geoffrey of Villehardouin, the historian of the crusade. But the story of previous crusades had at least opened men's eyes to the fearful risks of a march across Asia Minor, and the army wholly lacked the means of transport by sea. In this strait whither could they betake themselves but to Venice? For 85,000 silver marks the doge, Henry Dandolo, covenanted to convey them to the Holy Land; but when the fleet was ready, 51,000 marks only were

forthcoming, although the counts of Flanders and St. Pol had sold all their plate and strained their credit to the utmost. To the amazement of the crusaders the doge announced that the 34,000 marks would be remitted if they would conquer for the republic the town of Zara, which had been unjustly taken from her by the Hungarian king. To Venice at this

Conquest of Zara.

time came Alexius, the son of the Byzantine Emperor Isaac Angelus, whom his brother Alexius had blinded and thrust into a dungeon. The pleadings of the younger Alexius may have awakened in the mind of Dandolo some thought of what was soon to be achieved at Constantinople; but for the present he stuck to his bargain about Zara with inflexible pertinacity. Zara was taken, November 15, 1202; and the crusaders expressed their wish to hasten at once to the Holy Land. Dandolo replied that the new conquest must be guarded against the king of Hungary, and that famine in Western Asia rendered the eastward voyage during the winter impracticable. Envoys from Byzantium were also earnest in insisting that the ends of the crusade would be best promoted by placing Alexius on the imperial throne, and that the crusaders' mission was rather the establishment

The crusaders invited to Constantinople.

of right everywhere than the wresting of a particular spot from the grasp of the Infidel. They added that the first care of Alexius would be to bring the Eastern Church into submission to the Roman See, while his second would be to provide 400,000 marks for the service of the crusaders, and to accompany them himself to the Holy Land. On hearing these tidings Innocent professed amazement and indignation; but Dandolo was resolved that neither threats nor interdicts should interfere with the execution of his will. The Venetian fleet at length, 1203, reached Scutari, where they received a message from the usurper Alexius promising help if during their stay they would do his subjects no harm. The reply was a summons to come down from his throne; and the appeal lay only to the sword. With ordinary courage Alexius must have carried the day; by giving the order for retreat he sealed his own doom, and on his flight from the city the blinded Isaac Angelus, drawn from his prison, was again wrapped in the imperial robes, and his son Alexius raised to share his dignity. But fresh disappointments were in store for the crusaders. Alexius gave them to understand that the winter must be spent in Constantinople; and Dandolo effectually supported him by saying that until the spring the Venetian fleet should not move. In the meantime feuds and factions were doing their old work in Constantinople. The young Alexius, offended at the plainness of speech which told him that solemn compacts must be adhered to, sent a squadron of fire ships against the Venetians. The project failed; and in a little while his throne was filled by Alexius Ducas, called Mourzoufle from the darkness and shagginess of his eye-brows. Dandolo insisted on the restoration of Alexius; and Mourzoufle had him killed in prison. This deed was held to justify the crusaders in placing a Latin emperor on the Byzantine throne; and this task was achieved after a second siege, 1204, which was followed by riot and carnage altogether disgraceful to Western chivalry. Innocent III. might well ask how the return of the Greek Church to ecclesiastical unity was to be looked for when they saw in the Latins only works of darkness for which they might justly loathe them worse than dogs. The committee of twelve—half French, half Venetian—charged with the election of an emperor, fixed their choice on Dandolo; but the old man, who had well-nigh completed his tale of a hundred winters, cared little for the office, while the Venetians had no wish to see one man at once doge and emperor. Two only remained who could well be made competitors for the throne—the marquis of Montferrat, and Baldwin of Flanders. The choice of the electors fell on the latter, who was a descendant of Charles the Great, and a cousin of the French king; and Baldwin was crowned by the Papal legate in the great church of Justinian.

Latin conquest of Constantinople.

The crusaders had thus done great things, although not precisely the things which at the outset Innocent would have had them do. The old schism of the Greek Church had been brought to an end, and the dominion of the Holy See vastly enlarged. But the benefits secured to

Baldwin emperor of the East.

Effect of the crusade on the power of Venice.

Effect of the crusade on the power of Venice.

Venice were at least more enduring. The conquest of Zara was the first step only toward the establishment of a great maritime empire; the factories at Pera were exposed only to attacks by sea, and here her ships could guard them. Her settlements were seen in the richest islands of the *Ægean*; and this development of her greatness seemed to foster a spirit of independence which Innocent III. regarded with instinctive suspicion. It was the fault of the Venetians, he said, that the whole enterprise had not been brought already to a brilliant consummation. What might not an army which had done so much at Zara and Byzantium have achieved in the Holy Land?

The Latin empire thus set up was not more durable than the kingdom of Jerusalem. Baldwin, as emperor, was really nothing more than a chief among his peers; and although he thus

lacked the authority of the sovereigns whose title he bore, he attempted tasks which even they must have failed to accomplish. By the Crusaders the Greek people were regarded as barbarians or heathens, and their clergy as the ministers of a false faith. The former were excluded from all offices and dignities; the *Assize of Jerusalem* was substituted for the Code of Justinian; and no native was allowed to take part in the administration of this law. Such changes could portend nothing but future evil; nor were other signs of speedy downfall wanting. The conquerors began to quarrel, and Baldwin found himself at open war with Boniface of Montferrat, now lord of Thessalonica. Like Boniface, the other chiefs of the crusade had been splendidly rewarded. The count of Blois received the dukedom of Nice; and the Venetian Dandolo became the sovereign of Romania, with Geoffrey of Villehardouin as his marshal. But the power of the Eastern Cæsars was rather divided than crushed. New empires sprung up at Nice, Trebizond, and Durazzo; and the Latins encountered an enemy still more formidable in the Bulgarian Calo-John, who ordered a massacre of the Latins in Thrace, 1205. Eager for vengeance, Baldwin marched against him; but he was taken prisoner, and the army was saved only by the skill and heroism of Villehardouin, who has left us a narrative of the campaign. The liberation of Baldwin was demanded by the Pope; the reply was that he had died. The cause was never known; and for a year his brother Henry, who was elected to succeed him, refused to take the title of emperor. The ten years of Henry's reign, 1206-1216, stand out in pleasant contrast with the lives of the emperors who were to follow him. Henry at the least saw that his brother had made a fatal mistake

Wise policy of Henry I.

in confining the work of government exclusively to the Latins. Greeks were again admitted to public offices and honors. To the imposition of a foreign liturgy or of a foreign dogma Henry offered a passive resistance, while his throne, placed on the right hand of the patriarch's chair in the church of Santa Sophia, was significant of his thoughts on the question of Papal supremacy. With his death the male line of the counts of Flanders came to an end. In a fatal moment the offer of his crown was accepted by Peter of Courtenay, count of Auxerre, the husband of Henry's sister Yolande. Like Baldwin, Peter fell into the hands of his enemies on his eastward journey, and died without seeing the city of which he was the sovereign, 1213. During the reign of his successor, Robert, the second son of Yolande, the range of Latin dominion was rapidly narrowed. When Robert died, Baldwin, Yolande's youngest son, was still a child only seven years old; and John of Brienne, the titular king of Jerusalem, was raised to the imperial throne. At length, after his death, the second Baldwin became emperor; but the twenty-five years of his reign he spent chiefly in distant lands, begging for help in money. In vain the Pope proclaimed a crusade in his behalf. The end was drawing nigh. The envoys sent by him to Michael Paleologus were bidden to tell their master that he might have peace on the payment of an annual tribute amounting to the whole revenue from customs and excise at Constantinople. A few years later, 1261, Baldwin was driven from the imperial city, and spent the rest of his days wandering over Europe and telling

Fall of the Latin empire of the East.

ing the story of his misfortunes. So fell the Latin empire, having dealt the death-blow to the hopes which were dearest to the heart of Pope Innocent III. The reconciliation of the Eastern with the Western Church would, he knew, be best

achieved by a close union between the subjects of the Eastern and the Western empires. The policy of the Latin emperors had opened a gulf of separation which has not to this day been closed, and had converted the dislike and suspicion of former generations into vehement jealousy or furious hatred.

When the Latin empire fell, the era of the crusades was fast drawing to its close; and of the expeditions which had been undertaken before its downfall one only was prompted by the spirit which had animated the hearers of Urban II. at Clermont. The conditions of the conflict were widely changed, and the course adopted by the Christian leaders showed their conviction that the surest road to Jerusalem was by way of Egypt. Again and again this plan might have been carried out successfully, and again and again the crusaders threw the chance away. Thus, in the year 1219, the Syrian sultan, Coradin, had offered peace to the besiegers of Damietta, pledging himself to surrender not merely the true cross, but the whole of Palestine, with the exception of two forts for the protection of pilgrims bound to Mecca. The offer was rejected; Damietta was taken and plundered; and in the spring of 1220 the army insisted on attempting the conquest of Egypt. The sultan, Kameel, offered them terms as favorable as those of Coradin, and these were also refused. The Nile rose, and the Egyptians inundated the camp of their enemies, who in their turn were compelled to sue for peace by surrendering Damietta. This disaster made the Pope, Honorius III., who had been elected on the death of Innocent, still more anxious for the fulfilment of the crusading vow which had long since been taken by the emperor, Frederick II., the grandson of Barbarossa. In a conference at Ferentino, 1223, it was agreed that Frederick should marry Iolante, the daughter of the titular king of Jerusalem, and thus go forth as his heir to recover his own inheritance. Two years were allowed for preparation, but it was found necessary at San Germano to grant two more. When at length Frederick married Iolante in 1225, he declared that his father-in-law, John of Brienne, was king only by right of his wife, on whose death the title had passed to her daughter, and that thus Frederick was now king of Naples, Sicily, and Jerusalem. Still the months rolled away, and the vow of Frederick remained unfulfilled. Honorius had already

The sixth crusade.

Assumption of the cross by Frederick II.

been obliged to remonstrate. His successor, Gregory IX., 1227, found himself constrained to use sharper weapons. The contrast between the two men was marked indeed. In Gregory IX., chosen Pope at the age of fourscore years, the ascetic severity of Gregory the Great was united with the iron will of Gregory VII. Frederick was a young man of thirty-three, born and bred in Sicily, steeped in the luxury of a gorgeous and voluptuous court, where the charms of art and the refinements of literature and philosophy in some measure redeemed the sensuous indulgence at which Gregory would have stood aghast. The Pope had indeed enough to disquiet him in the reports which came to him from this Sicilian paradise. Frederick was spending his days amongst a motley company gathered from all the countries of Europe,—a company in which Christians, Jews, and Saracens mingled freely. A society such as this could exist only in an atmosphere of tolerance, and tolerance in Gregory's eyes was only another name for indifference, and indifference of heresy. The spell, therefore, must be broken, and Frederick must be sent forth to do battle in distant lands with the infidels, to whom he showed so dangerous a liking in his own. At length his forces were gathered at Brindisi, 1228; but fever broke out among them, and Frederick, having embarked, was compelled after three days to put into the harbor of Otranto. Gregory could endure no more. Frederick was solemnly excommunicated, and the excommunication was followed by interdict. Papal messengers forbade him now to leave

Relations of Frederick with Gregory IX.

Excommunication of Frederick.

Italy until he had made satisfaction for his offences against the church. Frederick retorted by sending his own envoys to demand the removal of the interdict, and then sailed to Ptolemais. Here he found friends in the Teutonic Knights and their grand-master Herman of Salza; and although he was ready to fight, he was still more willing to gain his ends without bloodshed. At length a treaty, signed by the Sultan Kameel, 1229, surrendered to Frederick the



**Frederick and the Sultan Kameel.**

whole of Jerusalem with the exception of the mosque of Omar, and restored to the Christians the towns of Jaffa, Nazareth, and Bethlehem. Success thus achieved exasperated rather than appeased the Pontiff. The interdict followed him to the holy city, and when he went to his coronation as king of Jerusalem in the Church of the Sepulchre, not a single priest took part in the rite, and Frederick was compelled to crown himself. The letters which he wrote to announce a success which he regarded as splendid roused only a storm of indignation. Gregory charged him with a monstrous attempt to reconcile Christ and Belial, and to set up the impostor Mahomet as an object of veneration or worship.

**The seventh crusade.**

The treaty with Kameel, which closed the sixth crusade, was for ten years. On neither side, probably, was it strictly kept, and the injuries done to pilgrims on their way from Acre to Jerusalem were alleged as a sufficient reason for sending out the expedition headed by Richard, earl of Cornwall (brother of the English Henry III., and afterwards king of the Romans). This expedition may be regarded as the seventh in the list of the crusades, and deserves notice as having been brought to an end, like that of Frederick, by a treaty, 1240. The terms of the later covenant were even more favorable to the Christians; but two years later the Latin power, such as it was, was swept away by the inroad of Korasmians, pushed onwards by the hordes of Jenghiz Khan. The awful havoc thus caused was alleged by Pope Innocent IV. as a reason for again summoning Christendom to the rescue of the Holy Land.

**The eighth crusade.**

But nearly seven years passed away before the French king, Louis IX., was able to set sail for Egypt on the eighth crusade. This royal saint, who lives for us in the quaint and graphic chronicle of his seneschal Joinville, may with truth be said to have been animated by a spirit of devotion and self-sacrifice which no other crusading leader manifested in anything like the same measure. Intolerant in theory, if he could be said to have any theory, and bigoted in language, Louis had that true charity which would make him succor his enemies not less readily than his friends. Nor was his bravery less signal than his gentleness. It was displayed not only on the battle-field, but during the prolonged miseries of a captivity in which he underwent keener pain for the sufferings of others than for his own. He had, indeed, the highest virtues of the monk, the most ardent love of justice and truth, the most vehement hatred of wrong; but as he laid no claim to the qualities of a general, so most assuredly it cannot be said that he possessed them. His dauntless courage saved his army from complete destruction at Mansourah, 1249; but his offer to exchange Damietta for Jerusalem was rejected, and in the retreat, during which they were compelled to fight at desperate disadvantage, Louis was taken prisoner.

**Captivity of St. Louis.**

With serene patience, with unwavering firmness, and with an unclouded trust in God, he underwent sufferings for which the Saracens, so Joinville tells us, frankly confessed that they would have renounced Mahomet; and when the payment of his ransom set him free, he made a pilgrimage in sackcloth to Nazareth, 1250. With a firmness which nothing could shake he denied himself the solace of looking on the holy city. His sense of duty would not allow him to reap the fruits of an enterprise in which he had failed, and so to set an evil example to others. As a general he had achieved nothing, but his humiliation involved no dishonor; and the genuineness of his faith, his devotion, and his love had been fully tested in the furnace of affliction.

**The ninth crusade.**

The crusading fire was now rapidly burning itself out. In the West there was nothing to awaken again the enthusiasm which had been stirred by Peter the Hermit and by Bernard; while in Palestine itself almost the only signs of genuine activity were furnished by the antagonism of the religious military orders. There was, in truth, disunion and schism everywhere. The relations between the Venetians and the men of Genoa and Pisa were at best those of a hollow truce; and the quarrels of the Templars and Hospitaliers led in 1259 to a pitched battle, in which almost all the Templars were slain. Some eight years later the tidings that Antioch had been taken by the Infidels revived in St. Louis the old yearning for the rescue of the holy places; but he modestly expressed his fear that his sins might again bring on the Christian arms the disasters of his Egyptian expedition.

Cheered by the sympathy of the Pope Clement IV., he embarked with an army of 60,000 men, 1270; but a storm drove his ships to Sardinia, and thence they sailed for Tunis. They had encamped, it is said, on the site of Carthage, when a plague broke out. The saintly king was among the victims; and this trust of all crusaders died, uttering the words, "I will enter Thy house, O Lord; I will worship in Thy sanctuary." The arrival of the English Edward, who was soon to succeed to the throne on the death of Henry III., brought about no immediate change in the circumstances of the crusaders. In the following year Edward reached Acre, took Nazareth—the inhabitants of which he massacred—fell sick, and during his sickness narrowly escaped being murdered by an assassin sent by the emir of Joppa. Having made a peace for ten years, he returned to Europe; and the ninth and last crusade was at an end. An earnest attempt to renew the struggle was made in the Council of Lyons, 1274, by Gregory X., Edward's friend; and Rodolf of Hapsburg pledged himself to join the expedition then decreed; but in less than two years Gregory died, and the scheme fell to the ground. Of the attempts made in succeeding years to rekindle the old enthusiasm it is enough to say that all proved abortive. The Holy Land could no longer, as it seemed, furnish a home even for the military orders. The Teutonic Knights made their way to Lithuania and Poland, the Hospitaliers to Cyprus and to Rhodes. The Templars fell victims to a plot as iniquitous and treacherous as any that has disgraced the annals of mankind. When their services had ceased to be useful in Palestine the French king found that much benefit might be derived from a confiscation of their vast possessions. The proceedings against the order in England are scarcely to be compared with the surpassing horrors of the proscription in France which ended in the burning of the grand-master Du Molay; but in both countries the power of falsehood in compassing the destruction of men innocent of the particular crimes laid against them was seen as perhaps it had never been seen before. The fury with which they were persecuted was indeed a legitimate result of the crusades, for which the unbelief of the enemy supplied the primary motive. The theory of putting down error by force had received a sanction which was applied in the dealings of the popes with Albigensian and other heretics.

**Death of St. Louis at Tunis.**

**Decay of the crusading spirit.**

**Suppression of the Knights Templars.**

**General review of the causes and consequences of the crusades.**

The narrative of the crusades brings out with sufficient clearness both their causes and their consequences. We have seen that, while the popular impulse which led to them could not issue in vigorous action without the sanction of religion, the mere authority even of the popes was wholly powerless to set Latin Christendom in motion until popular indignation had reached the fever heat. We have been able to watch the effect of these enterprises in changing the face not only of the East but of the West, securing to the popes the exaction and administration of vast revenues and of a dispensing power still more momentous in its issue, strengthening and extending royal authority by the absorption of fiefs, but for the moment increasing in incomparably larger measure the wealth and influence of the clergy. We have seen the introduction of feudal principles into Jerusalem and Constantinople, and have marked the effects which followed the substitution of the Assize of Jerusalem for the Code of Justinian. The story has shown us that the contact of Western with Eastern Christendom brought about in some respects results precisely opposite to those which were anticipated from it, and that the establishment of the Latin empire of Constantinople rendered hopeless that union of the churches which Innocent III. had regarded as its certain fruit. But if the crusades thus disappointed the expectations of their promoters, they achieved some results the benefits of which have been felt from that day to the present. They failed, indeed, to establish the permanent dominion of Latin Christendom, whether in New Rome or in Jerusalem; but they prolonged for nearly four centuries the life of the Eastern empire, and by so doing they arrested the tide of Mahometan conquests as effectually as it was arrested for Western Europe by Charles Martel on the plain of Tours. They saved the Italian and perhaps even the Teutonic and the Scandinavian lands from a tyranny which has blasted the fairest regions of the earth.

and if they added fuel to the flame of theological hatred between the Orthodox and the Latin churches, if they intensified the feelings of suspicion and dislike between the Eastern and the Western Christians, they yet opened the way for an interchange of thought and learning which had its result in the revival of letters and in the religious reformation which followed that revival. If, again, of their leaders some showed themselves men of merciless cruelty and insatiable greed, there were others who like Tancred approached the ideal of the knightly chivalry of a later generation, and others again whose self-sacrifice, charity, and heroic patience furnish an example for all time. The ulterior results of the crusades were the breaking up of the feudal system, the abolition of serfdom, the supremacy of a common law over the independent jurisdiction of chiefs who claimed the right of private wars; and if for the time they led to deeds of iniquity which it would be monstrous even to palliate, it must yet be admitted that in their influence on later ages the evil has been assuredly outweighed by the good.

Gibbon, *History of the Decline and Fall of the Roman Empire*; Michaud, *Histoire des Croisades*; Mills, *History of the Crusades*; William of Malmesbury; Joinville, *Memoirs of the Crusades of St. Louis*; Richard of Devizes; Geoffrey of Vinsauf; Geoffrey of Villehardouin; Wilken, *Geschichte der Kreuzstige*; Haken, *Gemälde der Kreuzstige*; Milman, *Latin Christianity*, book vii. ch. vi.; Hallam, *Middle Ages*, ch. i. part 1.; Mainbourg, *Histoire des Croisades*; Finlay, *History of the Byzantine and Greek Empires, from 1057 to 1453*; James de Vitry, *Historia Orientalis*; Choiseul d'Aillecourt, *Mémoires sur les Croisades*; Heeren, *Essay on the Influence of the Crusades*.

(G. W. C.)

CRUSENSTOLPE, MAGNUS JAKOB, a Swedish historian, was born in 1795. He became early famous both as a political and an historical writer. His first important work was a *History of the Early Years of the Life of King Gustavus IV. Adolphus*, which was followed by a series of monographs and by some politico-historical novels, of which *The House of Holstein-Gottorp in Sweden* is considered the best. He obtained a great personal influence over King Karl Johan, who during the years 1830-33 gave him his fullest confidence, and sanctioned the official character of Crusenstolpe's newspaper *Fäderneslandet*. In the last-mentioned year, however, the historian suddenly became the king's bitterest enemy, and used his acrid pen on all occasions in attacking him. In 1838 he was condemned, for one of these angry utterances, to be imprisoned three years in the castle of Waxholm. He continued his literary labors until his death in 1865. Few Swedish writers have wielded so pure and so incisive a style as Crusenstolpe, and it is by virtue of the elegance of his writings that he will survive, for his historical worth is injured by the passionate bias of his political and personal antipathies.

CRUSIUS, CHRISTIAN AUGUST (1715-1775), after Budæus the most distinguished theological opponent of the Wolfian philosophy and critical methods, was born on the 10th of January, 1715, at Leuna, in Merseburg, a division of Prussian Saxony, and passed to the university of Leipsic in 1734. After attending the usual classes, he became extraordinary professor of philosophy in Leipsic in 1744, professor of theology in 1750, and theological principal in 1755. He died on the 18th of October, 1775. Two of the great objects of his life were to place philosophy on a thoroughly satisfactory basis for the future, and to bring philosophical conclusions into harmony with orthodox theology. The university was divided by the disputes that were rife into two parties—the "Ernestianer" and the "Crusianer." The former contended for a purely grammatical interpretation of Scripture, and carried out their theory to its logical consequences. They thus subjected the sacred writings to the same laws of exposition as are applied to other ancient books. Ernesti, adopting the principles he had employed in dealing with the classics, looked at the Bible from a purely philological standpoint. Crusius, on the other hand, explained Scripture in the light of the labors of the church and the usually received theological system. This had great influence on his philosophical position. He had inherited a bias against the Wolfian views from his teacher Rüdiger; and numerous works were issued by him on logic, metaphysics, psychology, and moral philosophy—all with a direct controversial bearing. The system of Crusius was not successful, but it had a few very enthusiastic supporters. His mysticism and sincere religious spirit endeared him to the Pietists

and the followers of Zinzendorf, who would naturally regard him as an able opponent of the extreme rationalizing tendencies (*Aufklärung*) of the time. His views of prophecy, too, and of its important connection with the Christian economy, had considerable influence on Hengstenberg and Delitzsch. The principal works of Crusius are *Hypomnemata ad theologiam propheticaam* and his *Moral Theology*. The latter is in two parts. In the first, taking revelation as his starting point, he combats the Wolfian idea of human perfection, and treats of the depravity, conversion, and sanctification of man. He seems to have held, like Dr. Wardlaw, that natural, as distinguished from Christian, ethics are not legitimate. The second part is devoted more specially to morals. The book, although prolix, is animated by genuine religious feeling. Although Crusius had great influence on many of his contemporaries, he unfortunately outlived his reputation. He was a profound subtle, and original thinker, and was, perhaps, drawn into mysticism by his attempts to reconcile theology and philosophy. His works have fallen into the background; but he is still remembered for his profound learning, unfeigned piety, and purity and earnestness of character. Few controversialists have left behind them so stainless a name.

CRUSTACEA. There is probably no class among the Invertebrata which offers so many striking family and individual peculiarities as are to be met with among the Crustacea. Having a special type of structure, and possessed of numerous characteristics in common, they nevertheless put on such diverse appearances both in the young and adult stages of their existence as frequently to have baffled the most able investigators, whilst many of the vagrant members of the class still challenge further research.

The masterly and exhaustive labors of Charles Darwin on the Cirripedia have rescued that aberrant group from obscurity, and many of the parasitic forms have been relegated to the various orders of which they are in reality only degenerated members, their organs having suffered atrophy, and frequently their entire structure having undergone modification, in consequence of the peculiar existences which they lead. But our advance towards a more correct knowledge of the class, as a whole, has been mainly derived from the accumulated store of embryological and developmental studies which—commenced in 1823 by Vaughan Thompson—have in these later years been so successfully prosecuted by Audouin and Milne-Edwards, Darwin, Spence Bate, Van Beneden, Claus, Anton Dohrn, A. S. Packard, O. F. Müller, Fritz Müller, and very many other naturalists. Much, however, still remains to be accomplished.

The CRUSTACEA belong to the sub-kingdom ANNULOSA, and to the division ARTHROPODA, in which are also included the INSECTA, the MYRIAPODA, and the ARACHNIDA; they are known also as ARTICULATA, from the body being composed of a series of distinct rings or segments, each segment usually possessing a pair of jointed appendages or limbs articulated to it. They may be defined to be those Articulata which, whenever respiratory organs are specially developed, possess branchiæ and not tracheæ. By this definition they are at once separated from all insects and myriapods, which invariably possess tracheæ. But it remains a difficulty, if it be not altogether impossible in the present state of science, to frame any definition which shall similarly include all CRUSTACEA and exclude all ARACHNIDA. In both classes, in fact, there are forms which possess no special respiratory organs; and if in these cases we resort to other characters, none which are of universal application have as yet been discovered.

It may be said, however, that as a rule these exceptional Crustacea possess more than four pairs of locomotive appendages, have two pairs of antennary organs, and possess a simple alimentary canal; while the Arachnida generally have not more than four pairs of locomotive appendages, possess at most one pair of antennary organs, and have their alimentary canal produced into cœca (Huxley).

EXTERNAL STRUCTURE.—The skin of the Crustacea is more or less completely hardened by a horny deposit called "chitine," with or without the addition of lime,<sup>1</sup> thus forms

<sup>1</sup> Chevreul gives the following analysis of the shell of the common crab:

Animal matter.....	28½
Phosphate of lime.....	60
Carbonate of lime.....	62½
Phosphate of magnesia.....	19
Soda salts, etc.....	19
	100 0

ing a defensive covering to the softer tissues of the animal. This hardened envelope serves also as an external skeleton, giving rigidity and support to the internal organs; and to its inflexions, projections, and rugosities the muscles and membranes of the body and appendages are attached.

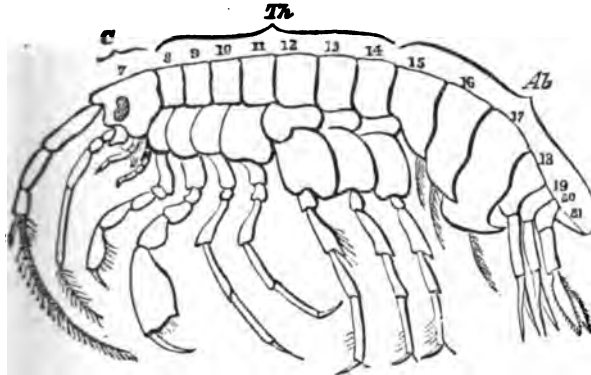

FIG. 1.—Diagram figure of *Gammarus locusta*, Fabr. (after Spence Bate and J. O. Westwood).

C = cephalon or head; Th = thorax; Ab = abdomen. (See Table of Appendages, next page.)

**BODY-SEGMENTS.**—The crustacean exo-skeleton consists of a series of rings, usually a repetition of each other, and differing only in modification according to the necessity of the various portions of the animal. Each of these divisions is called a *somite* (Huxley).

The normal number of *somites*, or segments, is twenty-one;<sup>1</sup> but instances occur among the extinct Trilobita and the recent Phyllopora and Branchiopoda, in which a larger number of segments than twenty-one are to be met with. On the other hand, many recent and fossil forms offer examples of Crustacea in which one or more segments are never developed; but this apparent absence is generally due to their coalescence, and we shall not unfrequently find indications of this if we bear in mind the theory of Oken, that each pair of appendages indicates a separate segment. A knowledge, too, of the earlier (larval) stages of some of these forms<sup>2</sup> has revealed the presence of the normal number of free segments in the young individual, which in later life are permanently soldered together.

Although the segments of the Crustacea are greatly modified in the different orders, yet they can nevertheless be shown to be all composed of two lateral moieties resembling each other; we can also distinguish two arcs, the one superior, the other inferior, as shown in the annexed figure (fig. 2).

The superior central pair united constitute the *tergum* (t, t), and the lateral are called the *epimera* (ep, ep). The inferior arc is composed of the same number of pieces. The two median pieces unite to form the *sternum* (s, s), and the latero-inferior pair are called the *episternum* (es, es). They are always united at the sternum; but there generally exists, between the inferior arc and the epimera situated above, a wide space destined for the articulation of the corresponding appendage (Milne-Edwards).

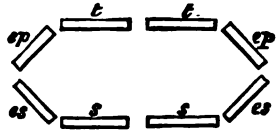

FIG. 2.—Ideal segment.

Mr. C. Spence Bate, in his "Report on the British Edriophthalmia" (*Brit. Assoc. Repts.*, 1855), differs from Milne-Edwards and other previous writers who had considered the series of scale-like plates at the sides of the

<sup>1</sup> In all the higher Crustacea the body is normally composed of twenty-one segments, but, of these, the last never bears true appendages, and is developed subsequently to the others from the dorsal surface of the body. Hence we are justified in regarding it, not as a *somite* or primitive typical segment of the body, but as a peculiar median appendage, to which the special name of "telson" (Spence Bate) may be applied. Thus the number of *somites* becomes reduced to twenty, each bearing its pair of appendages (Huxley, *Medical Times and Gazette*, 1867, p. 607). Professor Bell considers the extremely minute and movable points attached to the extremity of this segment in *Palaemon serratus* to be a pair of rudimentary appendages (*Hist. Brit. Shell-eyed Crustacea*, p. xx., 1853).

<sup>2</sup> As, for instance, the larval stages of *Limulus polyphemus*.

body-segments of the Amphipoda as representing the "epimeral pieces" of each *somite*; on the contrary, he considers them to be the dilated coxal joint (or *protopodite*) of each limb. This view he adheres to in his chief work<sup>3</sup> (1863, p. 3) on the sessile-eyed Crustacea, and reiterates in his Report<sup>4</sup> (1875, p. 47), where he writes the *epimera* as sectional pieces in a theoretical construction of a *somite cannot exist*; they are really portions of the integument of the appendages. That they are present in the Amphipoda attached to the coxal joint of seven pairs of the limbs is readily seen; but in the Decapoda, Stomatopoda and Isopoda it cannot by any means be so easily demonstrated. "We know of no example of a ring in which we are able to distinguish all the pieces that we desire to enumerate. In some there is an absence of certain pieces from the places they should occupy; sometimes they are very intimately soldered together, so that we cannot detect even a trace of separation; but in studying each of them separately, where it is most distinct, we shall be able to form a clear idea, and recognize its character in spite of its union with its neighboring pieces. Moreover, although this analysis of the ring may not be always practicable, it is none the less true that it facilitates much the study of the exterior skeleton of articulated animals, and that it will permit us often to establish analogies where the greatest difference would at first sight appear to exist" (Milne-Edwards).

Professor Huxley in his lectures<sup>5</sup> has somewhat simplified Milne-Edwards's view of the crustacean segment. Taking for his type one of the body rings, or *somites*, of the common lobster (fig. 3), he points out that it consists of a convex upper part called the *tergum* (t), and a flatter inferior side, the *sternum* (s), the angle of junction on each side of the tergum and sternum being produced downwards, forming what is termed the *pleuron* (or *epimera*) (pl.). For ordinary studies this view of a *somite* will be found sufficiently clear

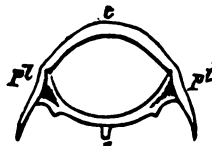

FIG. 3.

and simple.

From the inner surface of these tegumentary rings in the Crustacea various plates are given off which project into the internal cavity, constituting in some instances cells and canals. According to Milne-Edwards, these processes are always developed at the points of union of two rings or of two neighboring pieces of the same segment; and this disposition has obtained for them the name of *apodema* (fig. 4).

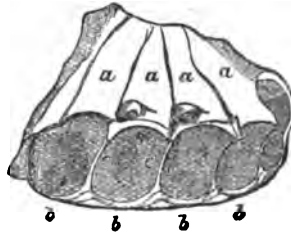

FIG. 4.—Lateral portion of the thorax of a crab (*Portunus marmoratus*).

a, a, a, the epimera; b, b, b, the sternum; c, c, c, the apodemata rising from the sternum and separating the insertions of the legs.

They are the result of a fold of the integumentary membrane which penetrates more or less deeply between the organs, and which is strengthened with calcareous matter like the rest of the external structure, and always formed of two thin plates soldered together. They serve the office fulfilled by the bones in the Vertebrata, *vis.*, that of affording solid surfaces to which the muscles are attached.

**DIVISIONS OF THE BODY IN THE CRUSTACEA.**—By general consent and usage the body of a crustacean is divided into three regions, namely, that of *cephalon*, *thorax*, and *abdomen* (see figs. 1 and 6), to each of which divisions seven out of the twenty-one segments are attributed. These terms are used as a matter of convenience, and are not assumed to be homologous with the grand divisions of *head*, *thorax*, and *abdomen*, in the Vertebrata.<sup>6</sup> All writers

<sup>3</sup> *History of British Sessile-eyed Crustacea*, 2 vols., Spence Bate and J. O. Westwood, 1863.

<sup>4</sup> *British Association Reports*, Bristol, 1875, published 1876.

<sup>5</sup> *Medical Times and Gazette*, 1867.

<sup>6</sup> Mr. C. Spence Bate, F.R.S., has, since 1855, earnestly advocated the adoption of the terms "*periton*" and "*pleon*" as less objectionable and more expressive than *thorax* and *abdomen* for the second and third

agree in considering the last seven<sup>1</sup> segments to be abdominal. The only difference of opinion is as to the division of the first fourteen,—how many are cephalic and how many thoracic.

Dr. Dana is of opinion that Crustacea have no distinct head, but only a *cephalothorax* composed of the fourteen anterior segments, yet he admits that in the *Ediophthalmia* the seven most anterior pairs of appendages are devoted to the mouth and organs of sensation, and in the extinct *Pterygotus* and in the *Trilobita* a distinct head certainly exists.

Professor Huxley considers that the division in the *Podophthalmia* is indicated by the cervical fold and by the sudden change in the character of the appendages between the sixth and seventh somites, and an equally marked similarity between the latter and those of the eighth and ninth pair. So that according to this view we should have six *cephalic*, eight *thoracic*, and six *abdominal* somites (for Professor Huxley regards the *telson* as not being a true somite, but a median appendage, like the post-oral plate in *Pterygotus*). But, as Dana well observes, the mouth organs may become legs, or the legs may become mouth organs by slight variations, therefore this line of division can hardly be maintained on the character of the appendages alone, seeing it does not hold good for other groups equally entitled to consideration as is the *Podophthalmia*.<sup>2</sup>

The subjoined table may serve to show these several views more clearly:—

*Arrangement and Nomenclature of the Somites or Body-rings of the Crustacea, with their Appendages.*

1st. Somite bearing the eyes.	VII.	"Segments of Head" "Thorax" (Edwards, Edwards Bell, etc.), "Cephalon" (C. Spence Bates).	"Cephalic somites" (Huxley).
2. " bearing antennules, or 1st (internal) antenna.			
3. " bearing antenna, or 2nd (external) antenna.			
4. " bearing mandibles.			
5. " bearing 1st maxillæ.			
6. " bearing 2d maxillæ.			
7. " bearing 1st maxillipeds.			
8. " bearing 2d "			
9. " bearing 3d "			
10. " bearing organs of prehension, ambulatory legs, or natatory appendages.	VII.	"Segments of Abdomen" "Telson" (Edwards, Bell, etc.), "Pleon" (C. Spence Bates).	"Thoracic somites" (Huxley).
11. " "			
12. " "			
13. " "			
14. " "	VIII.	"Abdominal somites" (C. S. Bates, Huxley).	"Segments of the Cephalothorax" (Dana).
15. " "			
16. " "			
17. " "			
18. " "	VII.	"Telson" (C. S. Bates, Huxley).	"Segments of the Cephalothorax" (Dana).
19. " "			
20. " "			
(21.) " Caudal somite destitute of appendages, "telson," or median appendage.	VII.		

**THE APPENDAGES.**—Just as we find a typical number of twenty-one body segments to prevail among the Crustacea, so also in the appendages the type number of joints is seven, any departure from which is disguised by fusion of one or more joints together, the obsolete condition of others, or the depauperization of the limb into numerous *articuli* (see fig. 5). At the coxal joint, or *protopodite*, each limb usually bifurcates; firstly, there arises the external limb proper, or *exopodite*, which is normally seven-jointed; and secondly, the internal branch, or *endopodite*, which may serve as a mouth organ, a branchial appendix, a swimming organ, or a protection for the ova or the young. The appendages belonging to the three divisions of the body differ from

divisions of the body (the term *cephalon* for the head being, of course, generally adopted). In his recent paper "On the Anatomy of the American King-Crab (*Limulus polyphemus*)" *Trans. Linn. Soc.* 1872, vol. xviii. pp. 462-3, Prof. Owen has proposed the terms "*cephalotron*" and "*thoracotron*" for the anterior and posterior divisions of the body in *Limulus*, and "*pleon*" for the "tail-spine." As other carcinologists are not agreed in regarding the long ensiform tail-spine of *Limulus* as representing the abdomen, we are still left in doubt, and have come to the conclusion that any satisfactory revision of the existing nomenclature must comprehend not one class only but the entire group of the Arthropoda, in the several classes of which the terms proposed to be altered are now in general use.

<sup>1</sup> That is—reckoning the *telson* as the twenty-first segment.  
<sup>2</sup> In the *Ediophthalmia* the normal arrangement mostly is maintained, the fourth to the seventh pairs being epitomial appendages, and the eighth to the fourteenth ambulatory organs.

each other in a greater or less degree in proportion to the higher or lower grade which we examine. Thus among the Decapoda (crabs and lobsters) the cephalic, thoracic, and abdominal somites all possess appendages with well marked characters, each series being highly differentiated for the functions to be performed by it. Among the En-

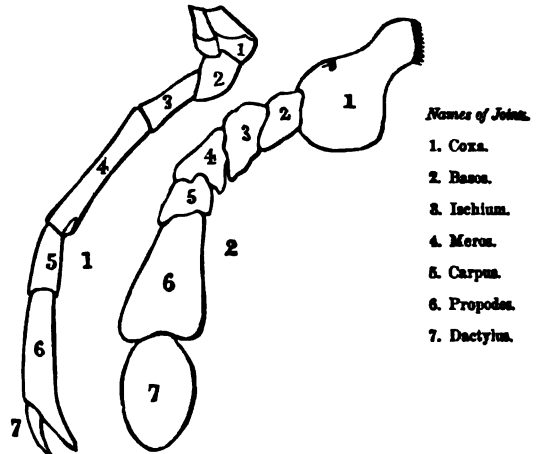

FIG. 5.—(1.) Walking-foot of Lobster (*Homarus vulgaris*), Edw.; (2.) Swimming Jaw-foot of *Pterygotus*.

tomotraca, the appendages of the anterior cephalic somites alone are highly specialized, the others being either mere vegetative repetitions of one another, or else altogether wanting.

**First Pair.**—The first cephalic somite supports the eyes, the most constant of all the organs, and probably the only pair of appendages which are never diverted from their normal use, though sometimes atrophied. In the more highly cephalized forms, the Decapoda-Brachyura (crabs), the eyes are placed on the outer side of the two pairs of antennæ, but the anatomical evidence shows that the most anterior pair of nerves, in this as in all other orders of Crustacea, is that which is connected with the ophthalmic organs.

**Second pair.**—The second somite bears the first pair of antennæ (or *antennules*), called the inner pair in the higher forms, and the upper pair among the lower Crustacea. Ordinarily they are slender, tapering, freely-moving, multi-articulate organs. In the lobster both the endopodite and exopodite are equally developed from a common basal-joint or *protopodite* (see 2 in fig. 6).

**Third pair.**—The third somite supports the second or posterior pair of antennæ, sometimes called the outer pair in the higher, and the inferior pair in the lower forms of Crustacea. In the lobster these are represented by a basal-joint or *protopodite*, and a long filamentary, multi-segmented endopodite, to the outer base of which a small scale is attached representing the exopodite. In all the higher Crustacea the three most anterior somites are always *praoral*, being in front of the buccal orifice, and in most genera, moreover, they are specially set apart as bearing the organs of sense. Generally they are so closely blended together, both in the earlier stages of development and also in the adult forms, as to defy separation, the presence of three somites being only demonstrable by dissection, and by a knowledge of the fact that each pair of appendages, wherever it exists, presupposes a segment or ring to which it belongs. The genus *Squilla* affords, perhaps, the best evidence of the separate existence of these cephalic rings. In it the first, or ophthalmic somite, is quite distinct from the second and third antennary, which are also separable from one another, although the latter blends with the next somite, and the succeeding ones can only be distinguished by dissection. Usually the antennæ or feelers are constant appendages; but still, the number and disposition of these organs varies extremely. Some of the lowest forms are wholly without antennæ, or are furnished with them in a merely rudimentary state. Some species have only a single pair, the normal number, however, as we have already pointed out, is two pairs. In position they are inserted on the superior or inferior surface of the head, according to the development of the somites composing the cephalon. Ordinarily they are slender flexible multi-articulate appendages, but even among the higher forms they are subject to extraordinary modifications; thus in the Scyllaridae, the external pair are developed into broad flat organs of natation, and probably also for burrowing. In *Arcturus*, an Isopod, they are the nursery for the young; in the Entomostraca they are usually

natory organs; in *Pterygotus* and *Limulus* they are chelate, serving, as in the Copepoda, as clasping organs for the male. In the last free condition of the Cirripedia and Rhizocephala they serve as the organs for attachment,—being converted into cement-ducts in the former, and into root-like organs of nutrition in the latter. The second pair of antennae and sometimes even the first pair become mouth organs in the Merostomata.

**Fourth to Ninth pairs. Epistomial or Mouth Organs.**—In the Decapoda the six succeeding pairs may be called mouth-organs or epistomial appendages, being all engaged in duties subservient to nutrition. The fourth somite bears the actual jaws or mandibles proper with their palpi, outside which lie two pairs of maxillae, followed by three pairs of maxillipeds

say, the five pairs of *pereiopodites* or “walking-feet,” and the three pairs of maxillipeds or “jaw-feet”) are all furnished with two branches, one the *endopodite*, the other the *exopodite*, as in the larval Decapod.

**Fifteenth to Twentieth pairs.**—The next six somites bear each a pair of swimming-feet (or *pleopodites*). In the Decapoda-Brachyura these remain (like the segments on which they are borne) as extremely rudimentary organs furnished with hairs which serve for the protection of the eggs after extrusion. In the Macroura they assist in swimming, and are composed of a simple exopodite and endopodite. The sixth pair are developed into broad plates, forming the lateral lobes to the tail.

The **Twenty-first** or caudal segment is destitute of appendages, and has therefore been considered by Prof. Huxley and others as a “median appendage,” and not as a somite.<sup>1</sup> It varies in form, being sometimes a broad flat plate in the Decapoda, or a minute terminal one in the Amphipoda, or greatly developed as a roof to the branchiae in some Isopoda, or forming a long terminal spine in the Xiphosura.

**INTERNAL STRUCTURE—NERVOUS SYSTEM.**—The typical form of the nervous system in the young of all the Articulata is a chain of ganglions placed along the ventral surface of the body, and traversed in front by the gullet. This typical arrangement, however, undergoes great modifications in the several orders of Crustacea. Taking the Edriophthalmia, for example (fig. 7), we find the nervous system to consist of two parallel chords traversing the length of the body, each having its own ganglionic enlargement in each somite in juxtaposition, but not confluent; so that there is a distinct pair of ganglions for each segment. These are again united by transverse commissures, and each ganglionic knot gives off nervous filaments to the limbs of its particular somite.

In the lobster (Decapoda-Macrura), the nervous system consists of a longitudinally disposed series of different-sized ganglions connected together by commissural cords (fig. 8).

Primitively there is a pair of ganglions to each somite, but the three first pairs are fused together in the adult so as to form a large cerebral ganglion placed in front of the mouth, and called the supra-oesophageal ganglion. From this a nervous chord passes back on each side of the gullet to the large postoral ganglion, which is made up of six pairs of primitive ganglions fused together. Then follow five pairs of thoracic and six abdominal ganglions all distinct, but connected one with another by a nervous band formed of the primitive commissural chords which have coalesced along the middle line.<sup>2</sup>

No solid internal skeleton separates this nervous axis from the alimentary system, though reflections of the external integument (*apodemata*) pass inwards, and more or

<sup>1</sup> Prof. Bell writes:—“Normally there are twenty-one pairs of appendages or limbs; generally speaking, even in the higher forms, twenty only are perceived, as the terminal joint of the abdomen, which forms the central piece of the fan-like fin, has none which are perceptible. I have, however, observed them frequently in the common prawn, *Palaeomon serratus*, in the form of extremely minute points attached to the very extremity of the segment, and movable.” Mr. A. H. Garrod, F.R.S., is also of opinion that the telson should be regarded as the twenty-first segment, having its appendages modified by cohesion and adhesion. See Humphrey's *Journal of Anatomy and Physiology*, vol. v., p. 271 (1871).

<sup>2</sup> This double ganglionic chain of the lobster was found by Newport to be composed of two orders of fibres, forming distinct and superposed fasciculi or columns, which the author designates *columns of sensation and of motion*, analogous to the fasciculi of the anterior and posterior columns of the spinal chord of the higher animals. These fasciculi are but indistinctly discernible in the interganglionic chords, but become extremely apparent in the ganglions themselves, for these enlargements belong exclusively to the inferior or *sensitives* fasciculi, and the superior or *motor* fasciculi pass over their dorsal surface without penetrating their substance at all.

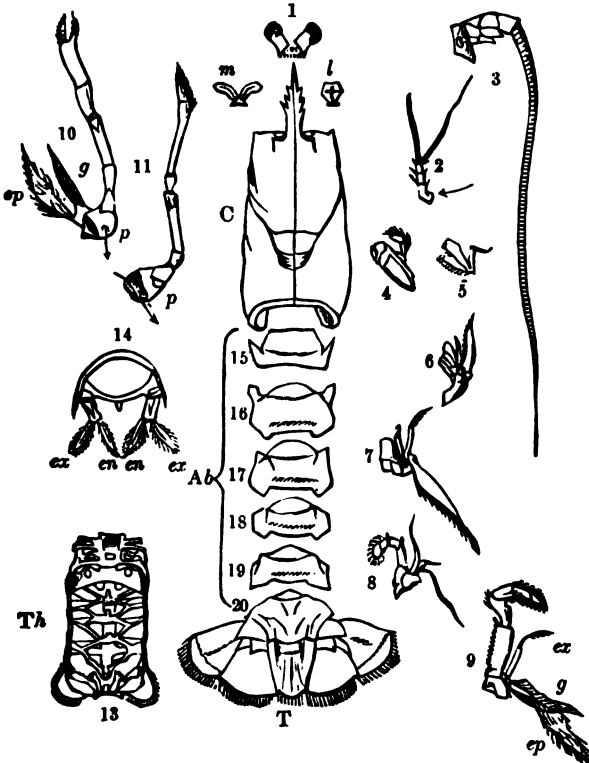

FIG. 6.—Diagram of the segments and appendages of the Common Lobster (*Homarus vulgaris*).

C = cephalon; 13, Th = thorax, showing the apodemata; Ab = abdomen. 1, Eyes; 2, antennules; 3, antennae; 4, mandibles; 5, first maxillae; 6, second maxillae; 7, first maxillipeds; 8, second maxillipeds; 9, third pair maxillipeds. 10, One of the antepenultimate pair of thoracic legs of female; p, protopodite; ep, epipodite; g, gill. 11, One of the last pair of thoracic limbs in male; p, protopodite. 14, Third abdominal somite; ex, exopodite; en, endopodite. l = labrum; m = metastoma. 15-20, abdominal segments; T, 21st segment, or telson.

or jaw-feet. In each successive somite, these organs become less highly specialised mouth-organs, and betray the fact that they are after all only simple feet modified. Thus in *Squilla* (a Stomapod) the eighth somite (first thoracic) bears a pair of robust claws, the terminal joint of which is furnished with long and sharp teeth, these forming the principal organs of prehension; whilst the ninth somite bears a pair of ordinary feet like the two following pairs (see fig. 71).

In most of the Edriophthalmia the mouth-organs extend only to the seventh somite, the eighth and ninth being included with the ambulatory members.

In the Decapoda we can detect the more or less rudimentary endopodite and exopodite in the fifth pair of appendages, and in each succeeding pair to the ninth; the eighth and ninth pairs also bear a third organ called an *epipodite*, and a gill or branchial organ.

**Tenth to Fourteenth pairs.**—In the higher forms the five somites which follow (and which might be termed the postoral somites) bear the true walking limbs (*pereiopoda*, Spence Bate), the first pair of which in the Decapoda are usually developed into powerful chelae, and serve as the chief organs of prehension.

These podites are usually seven-jointed, and each bears a gill on its basal-joint. They are formed by the endopodite, the exopodite being present only in the larval-limb of the Decapoda; but in the adult *Mysis* (Stomapoda), eight pairs of limbs (that is to



FIG. 7a.—Nerves of *Tetraodon*.  
FIG. 7b.—Nerves of *Oymothoa*.  
FIG. 8.—Nerves of *Homarus*.

less protect it. From this nervous axis all the nerves are given off, but none arise by two distinct roots like the spinal nerves of man.

In the prawn (*Palaeon*) and spiny lobster (*Palinurus*) the thoracic ganglia coalesce to form a long, elliptical, perforated nervous mass. In the hermit crab (*Pagurus*) the cephalic ganglion presents a transversely quadrate form, sending off the usual nerves to the eyes, antennæ, etc. The lateral oesophageal chords, after supplying the digestive system with the stomato-gastric nerves, unite below to form the ganglion which distributes nerves to the maxillary apparatus and pharynx. This is succeeded by a large oblong ganglion situated at the base of the great nippers, and of the second pair of feet, both of which pairs it supplies. The lateral chords, diverging for the passage of the artery, re-unite to form a third thoracic ganglion, smaller than the second, supplying the third pair of thoracic feet, and sending off three pairs of nerves posteriorly. Of these the lateral pair goes to the fourth diminutive pair of feet; the median pair supplies the fifth pair of feet; the two remaining dorsal nerves, which are of minute size, form the continuations of the abdominal chords, and pass along the under or concave side of the soft, membranous, and highly sensitive abdomen to the anus, anterior to which the last small ganglion is situated; this supplies the nerves to the muscles of the caudal plates, here converted into claspers for enabling the animal to adhere to the columella of the spiral shell which it may have selected to protect the portion of its body undefended by the usual dense and insensible crustaceous covering (Owen).

The general progress of the development of the nervous system in the Crustacea has been, as we have seen, attended with increased size and diminished numbers of its central or ganglionic masses. The divisions of each pair of ganglions first coalesce by transverse approximation; distinct pairs of ganglions approximate longitudinally, conjoining as usual from behind forwards; confluent groups of ganglions are next found in definite parts of the body as on the thorax of those species which have special developments and uses for particular legs. In the crab, in which the general form of the body attains most compactness, the ventral nervous trunks are concentrated into one large oval ganglion, from which the nerves radiate to all parts of the trunk, the legs, and the short tail.

A corresponding structure of the nervous system is also well displayed in *Maia* (fig. 9). An analogous concentration, but not an homologous one, obtains in *Limulus*. Here the nervous substance is chiefly massed round the oesophagus, the fore part of the ring expanding into a pair of ganglions, from which the nerves are sent off to the small median ocelli and the large lateral eyes; the nerves to the latter are of great length, wind round the anterior apodemata, and bend back to their termination, breaking up into a fasciculus of minute filaments before penetrating the large compound eye. Two stomato-gastric nerves arise from the upper and fore part of the ring. From the under surface of the fore part of the ring a small pair of nerves pass to the first short pair of forcipated antennules; five large nerves proceed from each side of the ring to the five succeeding jaw-feet. A pair of slender nerves pass to the spiny-edged lamelliform appendage. The posterior part of the nervous ring is prolonged backwards in the form of a chord having four ganglionic enlargements on its ventral surface, and terminates opposite the penultimate post-abdominal plate in a fifth slight ganglionic enlargement which bifurcates; each division sends off a few nerves as it proceeds to the caudal appendage, on entering which it is resolved into a plexus or kind of *cauda equina*. Besides the principal nerves above mentioned many smaller

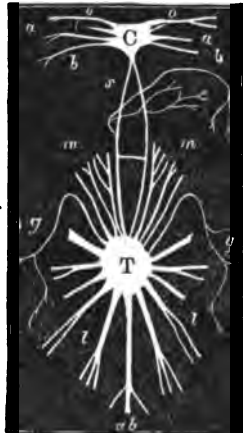

FIG. 9.—Nerves of *Maia squinado*, Latr.

C = cephalic ganglion; T = thoracic ganglion; o, o, optic nerves; a, a, antennary nerves; b, b, c, stomato-gastric nerves; d, d, medullary cords uniting C and T; m, maxillary nerves; g, g, nerves of the flanks; l, l, nerves of the legs; ab, abdominal nerves.

nerves are given off to other parts of the body. The sides of the great oesophageal ring are united by two transverse commissural bands; but the most remarkable feature of the nervous axis of this crustacean is its envelopment by an arterial trunk. A pair of aorta from the forepart of the heart arch over each side of the stomach, and seem to terminate by intimately blending with the sides of the oesophageal nervous ring. They, in fact, expand upon, and seem to form its neurilemma; a fine injection thrown into them coats the whole central mass of the nervous system with its red color (Owen, *Lectures—Invertebrata*, 1855).

Tracing the nervous system in the Crustacea from its simplest type, a vermiform cord with a series of independent nerve centres, we see these becoming successively conjoined in a greater and greater degree, as if in obedience to some law of attraction, until in the crab the maximum centralization of the class is attained. But in whatever form it exists in this section of the Arthropoda we may bear in mind the conclusion that

“the nervous system of the Crustacea consists uniformly of medullary nuclei (ganglions) the normal number of which is the same as that of the members or rings of the body, and that all the modifications encountered, whether at different periods of the incubation, or in different species of the series, depend especially on the approximation, more or less complete, of these nuclei (an approximation which takes place from the sides towards the median line, as well as in the longitudinal direction), and to an arrest of development occurring in a variable number of the nuclei.”—(Milne-Edwards.)

**DIVISIONS OF THE NERVES IN THE CRUSTACEA.**—Three principal divisions have been recognized in the nervous system of the Crustacea:—

(1.) All those nervous filaments which take their rise in, and are exclusively connected with, the supra-oesophageal nerve-centre, forming the true *sensori-olfactory* system. (2.) Other ganglions superadded to the abdominal columns with their nervous filaments, serving for the automatic reception and reflection of stimuli, forming the *motor* system. (3.) The stomato-gastric nerves, connected partly with the brain and partly with the oesophageal columns (analogous to the great sympathetic or organic nerves of the Vertebrata), forming a third group, the *ganglionic* system.

**SEAT OF THE SENSES IN THE CRUSTACEA.**—Although, as regards the relative size of the several ganglions in the nervous chain of the Crustacea generally, there is little difference between the anterior and posterior masses, and often a disparity between the supra- compared with the infra-oesophageal ganglions,<sup>1</sup> yet, nevertheless, it is generally admitted that in these animals there is an evident tendency observable towards a centralization of the nervous functions in the anterior portion of the ganglionic chain, viz., the supra-oesophageal ganglion. But still there is a wide interval between this first indication and the concentration of the faculties of perception and of will in a single organ—the brain—of which every other portion of the nervous system then becomes a mere dependency.

**ORGANS OF FEELING.**—As regards the development of the individual senses, one may reasonably conjecture that the sense of touch can be but feebly exercised by the common integument of the Crustacea, if indeed it can be said to exist at all, except in those parts of the body which remain soft and undefended by a calcareous crust, such as the under side of the abdomen or the soft body of the hermit-crabs. The hairs with which many of the Crustacea are indued may to some extent compensate for this low endowment of the tactile sense.

There can be no doubt, however, that the sense of touch is mainly concentrated in the two pairs of long, many-jointed, and highly flexible antennæ with which numbers of this class are provided. These special organs of touch are directly connected with the cephalic ganglion, and are well adapted, both by actual exploration and as media for conveying vibratory sensations, to furnish to the brain most correct and rapid ideas of surrounding objects.

The smaller but similarly-formed flabelliform appendages attached to the maxilla and maxillipedes doubtless perform a similar office in the testing of all objects brought near to the mouth; these latter, however, are not directly connected with the supra-oesophageal, but with the mandibular ganglion.

<sup>1</sup> In *Maia squinado*, for example, although the supra-oesophageal or cephalic ganglion is large, yet, in consequence of the union of the cephalo-thoracic somites, the thoracic ganglion is fully three times its size. See *supra*, fig. 9.

**ORGANS OF SIGHT.**—The eyes of Crustacea present a greater variety in their gradation than is to be found in any other class of the Arthropoda.

Commencing with only a median fixed (bifid?) eye-spot in the larval and simpler forms, we see these organs advance progressively, through all the stages of sessile-eyed development in the Merostomata and Edriophthalmia, to the highest condition in the Podophthalmia, that of two distinct compound eyes, endowed with all the essential optical apparatus, and placed on movable peduncles.

It has been doubted by some naturalists whether the eyes are organs of so much importance in the economy of the Crustacea as are the antennæ or organs of touch; but experiments performed on the eye of the living lobster, when out of water, or even in a shallow aquarium, can hardly be deemed as either a conclusive or a satisfactory test of the sensitiveness of the cornea in an eye accustomed to convey impressions of surrounding objects to the optic nerve when at a depth of several fathoms beneath the water.

If the open air experiments as to the sensitiveness of the lobster's eye had been made instead on a living shore or land crab, of the genus *Grapsus*, *Gelasimus*, *Gecarcinus*, or *Ocyropa*, it would speedily have been found that

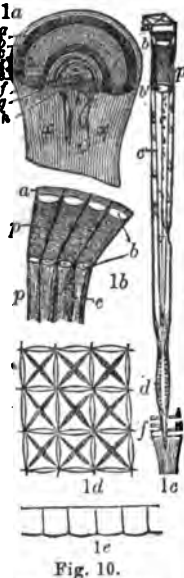

Fig. 10.

FIG. 10.—Structure of Eye of Lobster (*Homarus vulgaris*). After Newton.

- 1a. Longitudinal and horizontal section of a right eye seen by reflected light (X 4). a, cornea; b, first band of pigment, beneath which are the crystalline cones; c, a broad band of radiating fibres free from pigment; d, second black band composed of the pigmented spindle-shaped bodies, the lower ends of these bodies are covered with an opaque white pigment which forms e, the first white band; f, bundles of radiating fibres; g, enlarged end of the optic nerve, x. The muscles and connective tissue which naturally fill the cavity have been omitted in this figure.
- 1b. A group of elements showing the relation of the pigment to the cones. The cornea is not present. a, substance intermediate between cornea and cone; b, crystalline cone; c, nerve rod; p, pigment.
- 1c. A partly diagrammatic view of one of the elements of the eye from the cornea to the optic ganglion. a, cornea; b, substance between cornea and cone; c, lower end of crystalline cone; e, nerve rod, around which is seen the investing membrane with its nuclei; d, spindle-shaped or transversely striated body; f, perforated membrane at surface of optic ganglion; p, pigment.
- 1d. A portion of cornea as seen by reflected light, showing the cross and central spot.
- 1e. Perpendicular section from the middle of the cornea, showing the smooth outer and slightly convex inner surfaces.

In point of rapidity of perception and movement, guided by sight, these shore and land crabs are quite equal to the most sharp-sighted insect, or the most agile of lizards.

As already stated, the eyes are the most constant and persistent organs possessed by the Crustacea as a class; indeed, if we except certain parasitic Isopodous forms and the Cirripedia and Rhizocephala, we shall find that the faculty of sight is possessed by the whole class.<sup>1</sup> Even in those exceptional cases in which the eyes are aborted, we find that in the earlier and larval stages of their existence the parasitic and sedentary forms possessed eyes, and it is only as an effect of a kind of retrograde metamorphosis which the animal undergoes that the organs of vision disappear in the adult.<sup>2</sup> Two forms of visual organs are met with in the Crustacea, namely, smooth or simple eyes (*ocelli* or *stemmata*) and compound eyes; but though there are some few forms in which (as in *Apus* and *Limulus*) both ocelli and compound eyes are present, the latter form of eyes is that most generally met with in the class.

The structure of the simple eye does not differ greatly

<sup>1</sup> The fact that *Niphargus*, *Orangonyx*, and some other dwellers in subterranean waters, as well as *Callinassa Macandrei*, a burrowing marine crustacean, are blind, is certainly the result of their habitats, not a normal state of the organs of vision. In the Mammoth Cave, Kentucky, and the caves of Carniola and Adelsberg, Crustacea, Insects, and other animals have been met with, all blind or with but imperfect organs of vision.

<sup>2</sup> In the Cirripedia the individuals are *hermaphrodite*, fixed when adult, and all blind (unless the complementary male of *Ibla Cunninghamii* be an exception,—see Darwin's *Mon. Cirripedia*, Ray Soc., p. 196), but in the parasitic Isopoda, and in many of the Copepoda, it is the female alone which is so remarkably transformed, whilst the male retains his powers of sight, his freedom, and his normal aspect.

from that observed among higher animals. There is, firstly a transparent cornea, smooth and rounded, which is, in fact, only a part of the general tegumentary covering modified. Immediately behind the cornea is the crystalline lens, generally of a spherical form; this is again followed by a gelatinous mass analogous to the vitreous humor, and this mass is, in its turn, in contact with the extremity of the optic nerve. A layer of pigment of a deep color envelops the whole of these parts, lining the internal wall of the globe of the eye up to the point at which the cornea begins to be formed by the thinning of the tegumentary envelope rendering it transparent. The number of these simple eyes does not exceed two or three.

In the Branchiopoda (*Nebalia*, *Branchipus*, *Daphnia*) behind a simple cornea, undivided externally, we find a variable number of distinct crystalline lenses and vitreous humors, each included in a pigimentary cell, and terminating by contact with the optic nerve. These are, no doubt, an aggregation of stemmata under a common cornea.

In some of the Edriophthalmia a still further advance to a true compound eye is met with. In these the cornea appears to consist of two transparent laminae, the external layer being smooth and the internal one faceted, each facet being a distinct cornea resting on a separate crystalline lens of its own. In the compound eye, properly so called, the two membranes, external and internal, constituting the cornea, are both divided into facets, each facet seemingly being equivalent to a distinct ocellus, furnished with its own crystalline cone (or lens) and nerve rod; each invested with its own pigment coating, which, being darker at intervals, gives to a section through the compound eye as a whole the appearance of pigment-bands repeated at various depths beneath the cornea, and in front of the expanded termination of the optic nerve (*retina*). Although these facets are always hexagonal in the eye of an insect, they are variable in form among the Crustacea. Thus in *Homarus*, *Astacus*, *Penaeus*, *Galathea*, and *Scyllarus*, the facets are square; whilst in *Pagurus*, *Squilla*, *Gebia*, *Callinassa*, and the crabs, they are hexagonal. In *Limulus* and the Trilobites the lenses are round, not being in actual close contact with each other. Milne-Edwards mentions that in *Idotea* each facet has a kind of supplemental lens of a circular shape set within the cornea in front of each proper crystalline lens, and equal in size to the corneal facet, and apparently involved in the substance of the cornea itself, but under favorable circumstances capable of being detached from it. In *Phacops caudatus* the small circular lenses of the external compound eyes drop out, leaving a corresponding concavity beneath.

Emmerich long since proposed to use the external characters of the eyes of Trilobites as a means of classification, dividing them into "hyaline"-eyed and "faceted"-eyed groups; but he does not seem to have been aware of the perfect analogy which the structure of the eyes of the modern Edriophthalmia affords in illustration of this ancient and extinct group.

*Stemmata* or *ocelli* are always immovable and sessile; the compound eyes with smooth cornea, although usually sessile, are, however, occasionally supported on pedicles, as in *Nebalia* and *Branchipus*.

The compound faceted eyes are subject to the same variations,—genera being found with hyaline and faceted cornea in the same order. In some of the compound sessile eyes the facets are round; but in all the pedunculated compound eyes they are either square or hexagonal.

The peduncles supporting the eyes in the Stomapoda and Decapoda vary greatly in length, but every consideration tends to the conclusion that these movable eye-stalks are really the pair of appendages of the first cephalic ring. Indeed, in *Squilla* one is actually able to separate the eye-stalks with the segment upon which they are borne from the cephalic shield.



FIG. 11.—Eye of Trilobites (*Phacops caudatus*), U. Silurian. (After Buckland.) a, the entire eye; b, the genal border of head; c, a portion of the faceted surface, much enlarged.

In *Macrophthalmus* and some other crabs the eye-stalk is of very considerable length (see fig. 65), extending even to the outer angle of the front of the carapace, which is furnished with a long groove or furrow into which the eye can be folded down, and so placed out of reach of injury when not in active use. This furrow is called the *orbital fossa*.

**ORGAN OF HEARING.**—Milne-Edwards, Owen, Bell, and others consider the external organ connected with the sense of hearing to be situated on the first joint of the outer and larger antennæ in the lobster and other *Macroura*, and to consist of a conical process beneath which is a cavity having a round orifice closed by a membrane. Behind the process, and connected with the cavity, is a large sac filled with a clear liquor; a nerve arising in common with the external antennal nerve is spread upon the delicate walls of the supposed acoustic sac.

In *Maia* and other crabs the membrane is replaced by a movable calcareous disc pierced by a small oval opening, over which is stretched a thin elastic membrane (which might be termed the internal auditory membrane), near to which the auditory nerve appears to terminate.

The auditory apparatus of the Crustacea consequently consists essentially of a cavity full of fluid, over which a nerve adapted to perceive sonorous impulses is distributed, assisted by an elastic membrane, and placed near the base of the antennæ which, like a rigid stem, assists in rendering certain vibrations perceptible.

In both the lobster and the crab a gland filled with a greenish substance is connected with the membranous sac. This structure and the absence of otoliths has led Farre to suggest that the organ may be olfactory; but the chief parts of the structure bear a close correspondence with an auditory vesicle and a tympanic membrane.<sup>1</sup>

**ORGAN OF SMELL.**—Professor Owen<sup>2</sup> refers the sense of smell to a small sac, fringed with fine hairs, opening externally by a narrow cleft in the basal joint of the first or median antennæ. A branch of the antennal nerve terminates in a small prominence at the bottom of this sac. From the presence of some minute siliceous particles within the cavity (although it is admitted that these must have found their way in from the exterior fortuitously) Dr. Farre<sup>3</sup> has been led to suggest that the small antennæ are acoustic organs, and that the grains of sand may act as otoliths.

Milne-Edwards admits as indubitable the presence of well-developed organs of smell, but considers we are reduced to conjecture when we are required to point out the precise seat of those organs.<sup>4</sup>

**ORGANS OF TASTE.**—Like almost all other animals the Crustacea select their food, showing decided preference for particular kinds; this selection is doubtless actuated by two senses, *smell* and *taste*. Whether we are correct in assigning to the inner pair of antennæ the duties of the olfactory organ or not, it cannot be doubted that the sense of taste is distributed over that portion of the tegumentary membrane which lines the interior of the mouth and œsophagus, but there is no modification of these parts which needs to be specially noticed here.

**ORGANS OF NUTRITION.**—In the larval stages of the higher Crustacea, and also among the adult lower and simpler forms, fewer of the somites have their paired appendages differentiated to perform special offices. Thus in the larval Decapod the chief natatory organs are the maxillipeds; this is also the case in the Merostomata. In *Limulus* (fig. 12) all the locomotory organs are also subservient to the duties of nutrition, being organs of locomotion at their distal and mandibles and maxillæ at their proximal extremity.

In fact, as already stated, we have abundant evidence to prove that the maxillary organs of the Malacostraca are but modifications of entire limbs, translated from the locomotive series and set apart as special mouth-organs. By far the larger proportion of the Crustacea have a proper normal mouth furnished with suitable organs of mastication, but among the parasitic Copepoda and certain aberrant parasitic Isopods, etc., they become merely organs of attachment, the mouth being suctorial; or (as in the

Rhizocephala) it may be altogether wanting, and the limbs completely lost, and from the point of attachment root-like tubes may be developed, which, sinking deep into the body of the host, convey to the parasite its nutriment ready digested and prepared.

If instead of these latter we examine the Decapoda we shall find the mouth placed centrally near the front and upon the under side of the cephalon. It is provided with

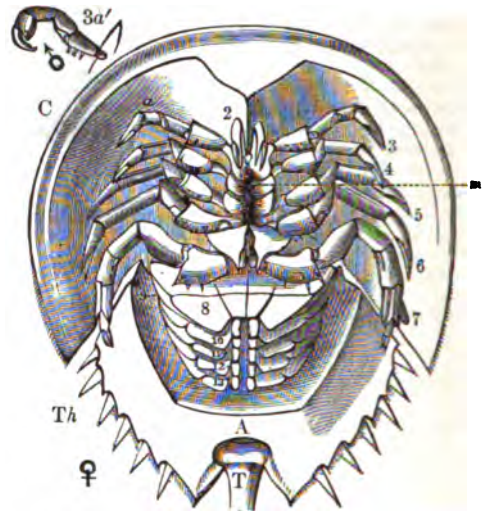

FIG. 12.—Underside of *Limulus polyphemus*, Latr. ?  
C = cephalon; Th = thorax; A, rudimentary abdomen; T = telson. (The eyes 1, cannot be seen in this figure, being on the upper surface of head-shield.) 2, The chelate antennules; 3a, antennæ (3a' detached antenna of male); 4-7, mandibles, maxillæ, and maxilliped; m, the mouth; 8, operculum, bearing on its inner and upper surface the ovaries and reproductive organs; 9-12, branchiæ feet.

a small simple median piece, called a *labrum*, or upper lip, in front, and a bifid *mentotoma*, or lower lip, behind; the paired appendages (mandibles, maxillæ, etc.) being placed on either side of the buccal orifice.

The food, whether living or dead, being first seized by the forcipated thoracic feet, is brought near to the maxillipeds, and by the help of these external organs of prehension portions are separated and introduced by the maxillæ to the trenchant and powerful mandibles, when having undergone further subdivision they are swallowed.

No organ corresponding to a tongue exists in the Crustacea, the mouth being only the anterior and outward expansion of the œsophagus, which is short, rises vertically, and terminates directly in the stomach.

The wall of the stomach is composed of two membranous layers, separated by one of muscular fibres, which increase in thickness at the openings leading from the œsophagus and into the intestine.

The stomach is globular in form and of great capacity, and may be divided into an anterior or "cardiac" part, and a posterior or "pyloric" region. The food on reaching the "cardiac" region

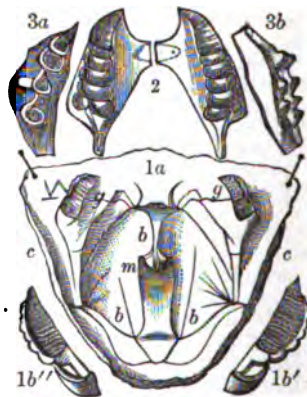

FIG. 13.—Gastric Teeth of Crab and Lobster.

1a, Stomach of common crab, *Cancer pagurus*, laid open, showing b, b, b, some of the calcareous plates inserted in its muscular coat; g, g, the gastric teeth, which when in use are brought in contact with the sides of the smooth fixed plate m; c, c, the muscular coat; 1 b' and 1 b'', the gastric teeth enlarged to show their grinding surfaces; 2, gastric teeth of common lobster, *Homarus vulgaris*; 3a and 3b, two crustacean teeth (of *Dityrostris*) from the Carboniferous series of Renfrewshire.

<sup>1</sup> Spence Bate marks this organ as "olfactory" in the crab (*Br. Assoc. Reports*, Bristol, 1876, pl. 1, fig. 10, and explanation). Mivart calls the green gland the kidney of the lobster, and says "no organ of smell has been determined" (*Pop. Sci. Rev.*, vol. vii., 1868, p. 355). See Frits Müller's suggestions as to this green gland, p. 576.

<sup>2</sup> *Lectures Comp. Anat.*, 1855, 2d edition, p. 311.

<sup>3</sup> *Phil. Trans.*, 1843.

<sup>4</sup> Milne-Edwards, in Todd's *Cyclopaedia of Anatomy*, vol. 1, p. 768.



of the stomach is subjected to a further process of mastication, by means of a complex apparatus composed of several calcareous pieces, moved by appropriate muscles, inserted in the membranous wall of the stomach (fig. 13, 1a), armed with a smooth median plate and two lateral molar-like-organs, having a singular *mimetic* and superficial resemblance to the molar teeth of some small marsupial rodent. Two smaller points (bicuspid in the lobster, tricuspid in the crab) complete the calcareous apparatus; in the pylorus a series of fine hairs are placed, which, doubtless, act like a strainer, preventing the escape of the coarser particles of the food until they have repeatedly been subjected to the molar-like action of the gastric teeth. A long and straight intestine continues from the stomach backwards, and terminates beneath the telson.

Two coecal salivary glands of a greenish color are situated on either side of the oesophagus.

The liver in the Decapoda is of large size, and bilaterally symmetrical; its structure is highly ramified, not solid like the human liver. The secreted fluid or bile is poured by two openings into the pylorus.

This organ, so large in the crab, undergoes great modifications in the various orders; in the Edriophthalmia only three pairs of biliary vessels, analogous to those of insects, remain. No vessels have as yet been detected by which the chyle or nutritious fluid elaborated by the digestive processes is taken up, as it passes along the intestinal canal, and transferred to the circulatory system; we can only, therefore, conclude that it is transferred by absorption to the irregular venous receptacles which are in contact with the walls of the intestines.

**CIRCULATORY SYSTEM.**—In most of the Crustacea the circulation is of the same simple character as that observed

pairs of fissures, and is situated in the last segment of the thorax and the first of the abdomen. Lastly, in the young *Anilocera* the heart (fig. 16) extends through the whole length of the abdomen, and is furnished with four or five fissures which are not placed in pairs, but alternately to the right and left in successive segments (Frits Müller, *Für Darwin*, pp. 41–42).

In the Decapoda the heart is placed near the dorsal surface of the cephalic shield immediately beneath the integument above the intestinal tube, and is retained in its place by lateral pyramidal muscles. It consists of a single chamber or ventricle, suspended in a large sac, called the *pericardium*, but wholly distinct from the part so named in man. The structure of the heart is made up of the interlacement of numerous muscular fibres fixed by their extremities to neighboring parts, and passing for some distance over the aggregate at each end, the whole structure reminding one of a number of stars superposed on each other, the rays of which do not correspond (Milne-Edwards). The ventricle has three pairs of apertures so closed by valves as to readily allow the entrance of blood from the pericardium, but to hinder its regurgitation. It has three other pairs of openings, each of which is the commencement of an arterial trunk conveying blood all over the body. These arteries have valves at their origin and ramify and end ultimately in capillaries, which open into what are called venous sinuses, because they are channels without any definite shape. The venous blood collects in a great sternal sinus, and thence passes up into the gills to be oxygenated, after which it proceeds to the pericardium to find its way into the ventricle (fig. 17). From the researches of MM. Audouin and Milne-Edwards,<sup>2</sup> it had been considered as conclusively proved that in the Decapod Crustacean only aerated or arterial blood found its way into the heart, to be distributed by it over the general system. But Professor Owen has shown<sup>3</sup> that in addition to the two great branchial trunks which pour their streams of aerated blood into the heart from the gills, four other valvular orifices, two connected with the series of caudal, and two with the series of lateral sinuses, communicate with the ventricle, and return a portion of carbonized or venous blood to the heart; the circulation is, therefore, to some extent mixed, and as both venous and arterial blood reach the ventricle, they are propelled thence through the system (see fig. 18). The re-



Fig. 14.

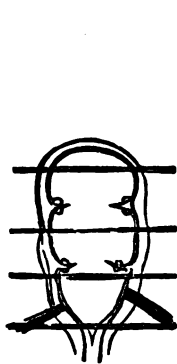

Fig. 15.

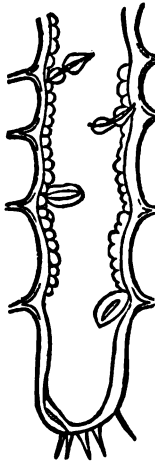

Fig. 16.

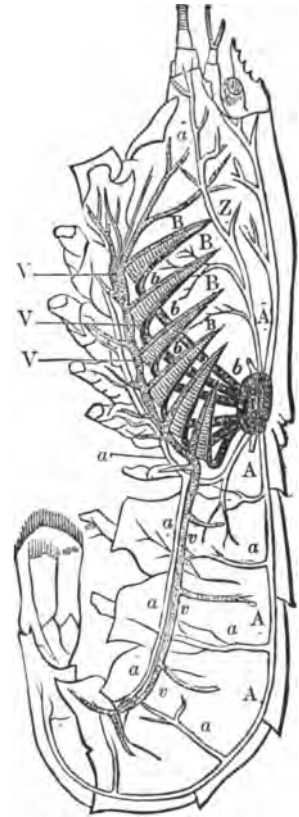

Fig. 17.—Diagram of Circulation of Lobster (*Homarus vulgaris*). (After Allen Thomson.)

H—heart. The aortic heart consisting of a single ventricular cavity, and situated below the posterior margin of the thoracic shield, gives off six systemic arteries (A, a), which convey the arterial blood to the various organs of the body and to the liver (L). The venous blood returning thence in the systemic veins (v, v) is collected on the lower surface of the body into sinuses (V, V), from which the branchial arteries (B, B) take their origin; the branchial veins (b) return the blood which has passed through the gills to the heart. See also fig. 18.

Fig. 14.—Abdomen of the male of *Eutoniscus cancrorum*. A, heart; L, liver. (Frits Müller.)  
Fig. 15.—Heart of a young *Cassidina*. (Frits Müller.)  
Fig. 16.—Heart of a young male *Anilocera*. (Frits Müller.)

in the aquatic larvae of insects, save that in the Crustacea the blood is conveyed to the gills for the purpose of oxygenation; but where no special respiratory organs are developed, the fine hairs and filamentous appendages attached to the feet doubtless subserve that office, or in some the entire surface of the body. The heart consists of an elongated contractile dorsal vessel, larger behind than before, connected anteriorly and posteriorly by several branches with the inferior or returning vessels, which running along the whole body receive the blood from the anterior extremity, and carry it into the posterior extremity of the dorsal vessel.

In the male *Eutoniscus Cancrorum* the heart (fig. 14) is situated in the third abdominal segment. In the *Cassidina* the heart (fig. 15) is likewise short and furnished with two

<sup>1</sup> By the kindness of his friend, Mr. Charles Darwin, M.A., F.R.S., etc., etc., the present writer has been permitted to use a large number of the illustrations from the English edition of Frits Müller's admirable little book, entitled *Facts and Arguments for Darwin*, translated from the German by W. S. Dallas, F.L.S., Assistant Secretary Geol. Soc., Lond. From Frits Müller's store of interesting facts and observations the writer has also largely drawn, especially in regard to his researches in the larval development of the Crustacea, and he takes occasion at once to acknowledge the same with thanks.

rial blood found its way into the heart, to be distributed by it over the general system. But Professor Owen has shown<sup>3</sup> that in addition to the two great branchial trunks which pour their streams of aerated blood into the heart from the gills, four other valvular orifices, two connected with the series of caudal, and two with the series of lateral sinuses, communicate with the ventricle, and return a portion of carbonized or venous blood to the heart; the circulation is, therefore, to some extent mixed, and as both venous and arterial blood reach the ventricle, they are propelled thence through the system (see fig. 18). The re-

<sup>2</sup> Recherches Anatomiques et Physiologiques sur la Circulation dans les Crustacés, *Ann. des Sciences Nat.*, t. II.  
<sup>3</sup> Lectures on Comp. Anatomy and Physiology of the Invertebrata, 2d edition, 1856, p. 318.

turning blood is not redistributed through the liver, as in man, &c., there is no portal circulation. There are no lymphatic vessels. The blood is a slightly dusky fluid, containing numerous nucleated corpuscles, which change their form with remarkable rapidity.

**RESPIRATORY ORGANS.**—As the type upon which the Crustacean class is constructed is specially fitted for aquatic existence, branchial organs or gills in some form are essential for the aëration of the blood. The appendages which fulfil this office are attached either to the thoracic or abdominal members or to both. Where they are most highly developed, as in the crab and lobster, they assume the form of pyramidal bodies, each consisting of a central ascending stem, with numerous horizontal branches or plates folded close together through which the blood circulates. There are twenty-two such structures in the lobster, eleven on each side of the thorax, attached to the basal joints of the thoracic limbs,<sup>1</sup> each pair of gills being furnished with its epipodite, or upper footlet, which serves to keep the gills apart from each other. In their most simple form they consist of a mere sac-like appendage held by a small neck pendent from the coxal joint, and exposed in the water without protection.

In the Decapoda they become more complex in structure and more voluminous, and would be extremely liable to

injury if not protected by some means. But, as Spence Bate<sup>2</sup> truly observes, being external to it, they could not be covered or protected by their own somite, as, if it had passed over them, the branchial appendages would have become internal, their character and constitution would therefore be changed; they would cease to be external; in fact, they would cease to be branchiæ. These appendages, however, exist as branchiæ, and are nevertheless securely covered and protected; not, indeed, by their own somite, but by the great development of the mandibular and poste-

rior antennal somites incorporated together, forming the carapace so characteristic of the typical Crustacean.

The branchial appendages are thus external in relation of the body of the animal, but covered over and protected by the lateral walls of the carapace. To complete this so as effectually to protect these organs without pressing on them or interfering with their functions, a very considerable amount of lateral development has taken place, and a peculiar reflection so as to bring the margin of the carapace below the branchial appendages, and to protect them from rude contact with the limbs. Externally, the carapace covers and protects both the hepatic and branchial organs; but, internally, a calcareous wall of demarcation exists between the two. This wall, which Milne-Edwards terms the *apodema*, is continued into a thin membranous tissue that makes a distinct and well-

<sup>1</sup> "The number of branchial pyramids," says Milne-Edwards, "varies greatly, especially in the Macrourea; at the most it is twenty-two, as in *Astacus*, and nearly allied species; in other Macrourea the number is eighteen, as in *Palaemon*, *Scyllarus*, *Penaeus*; fifteen in *Gobio*; twelve in *Pandanus*; ten in *Callinassa*; eight in *Palaemon*; seven only in *Orangon*, *Hippolyte*, *Sergestes*. In the Anomourea the number also varies very much. In the Brachyura we can almost always reckon nine branchiæ on each side; two of this number are, however, merely rudimentary. Sometimes one or more of the last, or last but one, are entirely wanting" (Todd's *Encyclop.*, vol. I., p. 781).

<sup>2</sup> Report on the present state of our knowledge of the Crustacea, part I., *British Assoc. Reports*, Bristol, 1876, p. 49.

defined separation between the branchial appendages and the internal system, so that the aqueous element so necessary for the aëration of the blood as it passes through the branchiæ may have full power to play upon the gills, and yet leaving no passage that would admit it to the internal viscera so as to derange the general economy of the animal (Spence Bate). The gills are not ciliated, and thus they require that the water within the branchial cavity in which they are placed should be incessantly renewed by other means. In the crabs two passages communicate with the branchial chamber, one for the entrance, the other for the exit of the water necessary to respiration. The efferent orifice always opens on each side in front of the mouth under the posterior maxilliped. The afferent opening varies greatly in position in the different groups.

In the Macrourea (lobsters), and in some of the Anomourea (hermit-crabs), the margin of the carapace is not accurately fitted to the thorax along its lower lateral border; the branchial cavity is thus opened along the whole extent of its inferior edge, and so the water finds its way readily into the respiratory chamber.

In the Brachyura (crabs), the afferent orifice is more circumscribed, but varies in a still greater degree. In nearly all it exists as a cleft of considerable breadth in front of the base of the first pair of ambulatory appendages between the carapace and the thorax.

In the Ocyпода, the third and fourth pair of feet are more closely approximated than the rest, and their margins bear a dense border of long silky peculiarly-formed hairs. Between the basal-joints of these feet, Frits Müller has discovered a round orifice opening into the branchial cavity, and he finds this to be a true incurrent orifice for the admission of air or water into the branchial chamber.<sup>3</sup>

In the genus *Ranaia*, according to Milne-Edwards, the ordinary anterior incurrent orifice to the gill-cavity is altogether wanting; it is placed instead at the origin of the abdomen.

In *Grapsus*, Frits Müller<sup>4</sup> has observed that, when under water, the respiratory in-current enters near the front in the usual manner, but when air is breathed, the anterior incurrent orifice being closed, and the hinder border of the carapace elevated, a wide fissure is opened upon each side above the last pair of feet leading directly into the branchial chamber.

In *Leucosia* the two apertures are close together, the incurrent opening being situated in front of the mouth, and the water passing in by a conduit parallel to the excurrent canal. The circulation of the medium within the respiratory atrium is brought about partly by the movements of the legs to which the branchiæ are attached, and partly by the epipodites which ascend between the gills. The main agent, however, is the "scaphognathite," a flabelliform appendage of the second pair of maxillipeds, which, rising and falling continually, occasions a rapid current from behind forwards in the water, filling the branchial chamber.

Branchiæ such as we have described, inclosed beneath the overreaching lateral walls of the carapace, are specially characteristic of the Decapoda (crabs and lobsters).

In the Amphipoda the head shield is small, and no longer covers the thoracic somites, as in the Decapoda. The branchiæ, however, are still borne on the coxal joint of the thoracic legs, but they depend unprotected from each limb, and are bathed in the surrounding medium, which is made to pass rapidly over them by the action of the abdominal flabellæ.

In *Squilla* we find the appendages of the first five pairs of abdominal somites devoted to the office of aërating the blood; the branchiæ, however, are not included in a cavity, but float freely in the water which bathes the entire surface of the animal.

In the Isopoda the abdominal appendages are all devoted to respiration, the anterior and outer pair in *Idotea* (fig. 19) being specially modified into a strong operculum (*op*), opening laterally and shutting over the five pairs of delicate branchial appendages within.

In *Limulus* five pairs of thoracic feet are modified into broad lamellæ, to the inner and upper surfaces of which the gills are attached, whilst the most robust and anterior pair is modified into a broad operculum covering the succeeding five branchigerous pairs, and also the reproductive organs (see fig. 12).

In *Apus* (Branchiopoda), save the antennæ and oral appendages of the head,

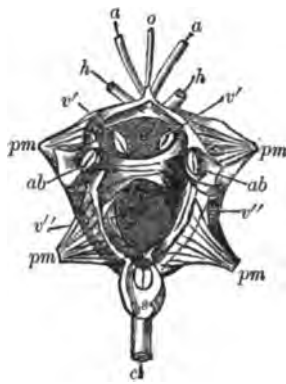

FIG. 18.—Heart of *Homarus vulgaris*, Edw., laid open. (Copied from Owen's Lectures, p. 318.)

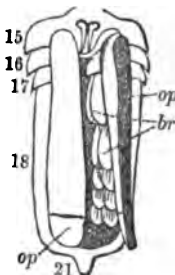

FIG. 19.—Branchiæ of *Idotea*.

*op*, operculum; *br*, branchia. The numbers indicate the segments.

<sup>3</sup> *Facts and Arguments for Darwin*, by Frits Müller. Translated by W. S. Dallas (Murray), 1869, p. 34.

<sup>4</sup> *Op. cit.*, p. 21.

all the other somites bear simple lamelliform gill-feet, of which there are, according to Baird, about sixty pairs, affording an excellent illustration of mere vegetative repetition of parts.

Although the act of respiration by gills seems a peculiarly aquatic method of aerating the blood, yet in both the Podophthalmia and the Edriophthalmia we meet with numerous amphibian and terrestrial forms.

No Macrouran Decapod, so far as ascertained, voluntarily quits the water, although the common lobster, the river crayfish, and the spiny lobster, all display great tenacity of life when removed from their native element. Their inability to leave the water is, no doubt, due to the fact that the carapace is less accurately fitted to the thorax than in the crabs. Certain of the Anomoura, or hermit-crabs, however,



FIG. 20.—Hermit-Crab (*Cenobita*) in shell. (After Morse.)

find no difficulty in adapting themselves to terrestrial conditions. The writer has kept the *Cenobita Diogenes* from the Antilles, tenanted an *Achatina* shell, alive in a Wardian case for three months, during which period he displayed great activity and most remarkable powers as a climber. These West Indian crabs are not infrequently brought over alive to England with cargoes of guano and other natural products (fig. 20).

Darwin refers to the abundance of hermit-crabs on Kneeling Island in the Indian Ocean (*Voyage of the Beagle*, p.



FIG. 21.—*Gecarcinus ruficola*, Land-crab of Montserrat, West Indies.

544), all living on the cocoa-nut, and each ensconced in some shell obtained from the neighboring beach. On the same island is found another most remarkable and very large terrestrial Anomourous Crustacean, the *Birgus latro*, living in burrows at the base of the cocoa-nut trees, upon the fruit of which it subsists. This large hermit-crab seeks no artificial covering for its fleshy body, the integument of which is chiefly membranous, but has the tergal pieces of its abdominal somites calcified. It is said (by Darwin) to visit the sea nightly for the purpose of moistening its

gills, and the young are hatched in the water, and pass there their earlier stages of existence.

Many of the shore-crabs, as *Grapsus*, and the fresh-water crab, *Thelphusa*, are not only able to leave the water temporarily; the former *habitually* lives out of that element, whilst many sub-tropical forms, as *Gecarcinus*, *Gelasimus*, etc., frequently live at a distance from the sea, and certainly possess the power of breathing air. But in all land-crabs it seems essential that the gills should, if not immersed in water, at least have the air surrounding them saturated with moisture. Milne-Edwards found that *Gecarcinus* (fig. 21) has the membrane lining the walls of the respiratory cavity modified in a manner analogous to that observed in fishes of the order Acanthopterygia. Sometimes this provision consisted of folds and lacunae serving as reservoirs for the water; sometimes, as in *Birgus*, of a spongy mass well calculated to store up the fluid necessary to keep the branchiæ sufficiently moistened to enable them to perform their functions.

The swift-footed sand-crabs (Ocypoda) are exclusively terrestrial, and can scarcely live for a single day in water; in a much shorter period, a state of complete relaxation occurs, and all voluntary movements cease. In fact, these land-dwelling crabs are as truly asphyxiated by immersion in water, as the aquatic species of *Cancer* become when taken from that element and left in the air.

Among the Amphipoda, *Talitrus* and *Orchestia* both live out of the sea, the former making a burrow for itself, the latter choosing moist places under sea-weed, or hiding in the damp sand. With us *Orchestia* lives within reach of the sea-spray, but in the southern hemisphere species have been met with many miles inland, choosing terrestrial plants for their abode, sometimes at an elevation of 1500 feet above the sea.

Among the Isopoda *Spharoma* is quite a littoral form, ranging from the equator to the colder temperate shores. The genus *Ligia* also lives above high-water mark, but never far away from the sea.

All the Oniscidea are terrestrial in their habits, living under stones, moss, or decaying wood, and in similar damp situations; they breathe air (which, however, must be saturated with moisture) by the aid of a series of respiratory branchial plates on the under side of the abdominal somites, in the same manner as in *Idotea* (already noticed), and in addition to this by the inspiration of air by means of certain spiracular orifices on several of the basal pairs of these same appendages (fig. 22).

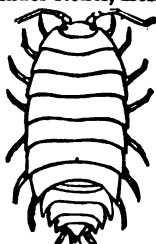

FIG. 22.—Common Woodlouse, *Oniscus asellus*.

In a large number of the lower and simple forms, including also the parasitic Crustacea and the Cirripedia, no special organs of respiration exist, and we are led to conclude that this office is performed by the surface of the body and its appendages generally.

**MUSCULAR SYSTEM.**—All the muscles of the body, even those of the intestine, are composed of striated fibres.

**REPRODUCTIVE ORGANS.**—The organs of generation are easily to be discerned in most of the Crustacea, but the analogy between these parts in the male and female is so great in many genera as to need the most careful examination in order to discriminate between the two. Generally, however, the males may be discerned by their having one or more pairs of limbs especially modified to assist in the marital act.

With the exception of the Cirripedia the two sexes appear never to exist together in the same individual among the Crustacea.

The small size and great dissimilarity of the males of some of the parasitic genera caused them to remain long unknown, and led to the error of supposing the females to be hermaphrodite, as Darwin has shown to be really the case in the Cirripedes. But even in this division Darwin has found small males parasitic on the female which he has named "complemental males." They are destitute of a mouth, and appear to exist only for the performance of this one function of reproduction (Darwin, *Cirripedia*, Ray Soc. 1851).

Bilateral symmetry generally prevails among the members of this class, and as a consequence we find always a pair of these organs arranged one on either side of the

body, perfectly distinct, and often wholly independent of each other. The male is provided with a paired gland or testes, and two excretory ducts, by which the spermatozoa are discharged on reaching the efferent openings, usually situated on either side in the basal joints of the seventh pair of thoracic appendages, or the first pair of abdominal limbs. In both the Crab and Lobster the first pair of abdominal appendages of the male are specially modified to take part in the process of fecundating the female.

Milne-Edwards denies that these appendages have any claim to be considered as fulfilling the office of conveying the fecundating fluid to the body of the female, but Spence

shows the method of attachment of the eggs. Here they are retained securely until the period of hatching has arrived, when the brood in most cases is dispersed.

This is not, however, always the case, for whilst examining a female *Dromia* from Australia, the writer discovered more than a dozen young ones adhering to the false abdominal feet of the parent,—the young, except in size, agreeing perfectly with the parent.

In *Mysis* the two endopodites of the hinder pair of thoracic feet in the female are developed into a broad plate on either side, and bent under the sternum, thus forming together an incubatory pouch or marsupium, in which the eggs are first deposited, and within which the young are secluded during their minority. In *Thysanopoda* the eggs and young are contained in a pair of oval sacs dependent from the posterior feet, forcibly reminding one of the ovarian sacs in *Cyclops*.

In the Amphipoda the ova are nurtured by the female within a pouch formed by a series of foliaceous plates, one of which is attached to each of the four anterior pairs of legs of the thorax. In the genus *Podocerus* the parent builds a nest in a very bird-like manner, amid the branches of the submarine scopophyte forests, and in one of these Mr. Spence Bate met with two broods of different ages, clearly demonstrating that the maternal care for their young is continued long after birth.<sup>1</sup> Similar ovigerous plates are developed in the fore-legs of females of the Isopoda. In all these sessile-eyed forms the parent seems specially solicitous for the safety of its young. In *Asellus*, *Talitrus*, and *Gammarus*, they appear to quit the maternal pouch and return to it as a place of safety. *Caprella* carries its young attached to its body; the female *Arcturus* supports them adhering to her large antennae.

In *Daphnia*, besides the several groups of ova which are successively hatched within the bivalved shell, and excluded during the spring and summer, giving rise to fertile females, there is formed each autumn an opaque layer within the incubatory cavity of the female, which hardens in two pieces like a small bivalved-shell, and is called the *ephippium* or saddle, and is placed on the dorsal surface of the *Daphnia*, but within the shell of the parent. Another structure, similar to the *ephippium*, and called the "internal ephippium," placed within it, is found to contain two bivalved capsules, in each of which a fertilized egg is lodged, which remains in a passive state through the winter, but hatches by the first warmth of spring, giving rise to females only (no males being hatched till autumn), these females in turn giving rise also to as many as six generations of fertile females. Their fecundity is so great as to be almost beyond the power of figures to express.<sup>2</sup>

**DEVELOPMENT OF THE CRUSTACEA.**—In nearly all the Crustacea, the young undergo a series of metamorphoses after quitting the egg. This rule appears to apply more constantly among the truly marine forms. Among the stalk-eyed Crustacea some few species at least quit the egg in the form of their parents, with the full number of jointed appendages to the body. This is the case, according to Rathke,<sup>3</sup> with *Astacus fluviatilis*, the common river crayfish (fig. 25), and according to Westwood<sup>4</sup> in a West Indian land crab (*Gecarcinus*). The present writer has also found an Australian *Dromia* protecting its brood on its false abdominal feet, the young differing from the parent only in point of size.

The young of the terrestrial Isopoda (*Oniscus*, *Porcellio*, and *Armadillo*) likewise nearly resemble their parents at birth.

In the king-crabs (*Limulus*) the young undergo their principal moults before quitting the egg, when they differ but little in aspect from the adult. The metamorphosis undergone by the common lobster appears to be but slight. The young, according to Van Beneden, are distinguished from the adult by having their feet provided like those of *Mysis* with a swimming branch projecting freely outwards,



FIG. 23.—Side view of Crab (Morse), the abdomen extended and carrying a mass of eggs beneath it; e, eggs.

Bate has frequently taken *Carcinus maenas* with these styli-form appendages deeply inserted within the vulvæ of the female. He has also shown the existence of a *vas deferens* in these false feet (*Ann. and Mag. Nat. Hist.*, 2d series, vol. vi. p. 109).

The ovaries in the crab resemble four cylindrical tubes placed longitudinally in the thorax, and divided into two symmetrical pairs, each opening into a distinct oviduct, yet communicating with each other by a transverse canal and by the intimate union of the two posterior tubes. The oviducts and ovaries are of a whitish color, and become united to a kind of sac<sup>1</sup> on each side, the neck of which opens externally in the sternal pieces of the fifth thoracic somite, which bears the third pair of walking appendages.

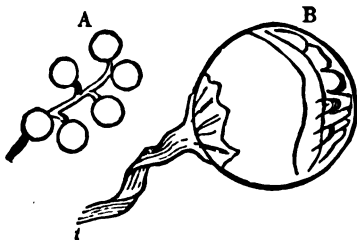

FIG. 24.—A, a few eggs of the Common Crab enlarged; B, a single egg greatly enlarged, showing more plainly the hardened thread (t) by which they are attached to each other. This egg also shows the commencement of the development of the embryo. (Morse's Zoology.)

In the *Anomura* and *Macroura* there are no copulatory pouches, and the vulvæ open on the basal joint of the third pair of ambulatory legs. It is possible, therefore, that in these forms the fecundation of the ova does not take place until the eggs are actually extruded, which we know to be the case in *Limulus*, and probably in some other forms, and as is also the case in fishes.

If we except *Gecarcinus*, certain other land-crabs, and *Limulus*, the female does not abandon her eggs after their extrusion. Those of the Decapoda when extruded are coated with a viscous secretion which thickens into threads, and causes the eggs to adhere to each other and to the fine hairs with which the swimmerets of the abdomen of the lobster and the female crab are fringed (fig. 23). Fig. 24

<sup>1</sup> The copulatory pouches of Milne-Edwards.

<sup>1</sup> Spence Bate, 1858, *Annals and Mag. Nat. Hist.*, and Bate and Westwood, *Sessile-eyed Crustacea*, vol. I. pp. 443-4.

<sup>2</sup> Baird, *British Entomostraca*, p. 78.

<sup>3</sup> Rathke, *Untersuchungen über die Bildung und Entwicklung des Flusskrebses*, fol. 1820.

<sup>4</sup> J. O. Westwood in *Phil. Trans.* 1836, vol. CXXV. p. 311. Frits Müller remarks, in reference to Westwood's paper—This is a solitary exception of a single species investigated by Westwood. In the same genus Vaughan Thompson found so-called brood, which has also been met with in other terrestrial crabs (*Ocyropsa* and *Gelasinus*). The mode of life is in favor of Thomson. "Once a year," says Troschel, "they migrate in great crowds to the sea in order to deposit their eggs, and afterwards return, much exhausted, towards their dwelling-places, which are reached only by a few." For what purpose would be these destructive migrations in species whose young quit the egg and the mother as terrestrial animals? Frits Müller, *Facts and Arguments for Darwin*, translated by W. S. Dallas, F.L.S., 1869, p. 48.

whilst the abdominal and caudal appendages are undeveloped. In nearly all the marine Crustacea the young quit the egg in the condition of *zoëa*. We are acquainted with many examples in all three divisions of the Decapoda.

But we are indebted to Mr. C. Spence Bate for the most complete series of observations on the development of one species, the common shore-crab (*Carcinus maenas*) from the *zoëa* to the sexually mature animal.<sup>1</sup>

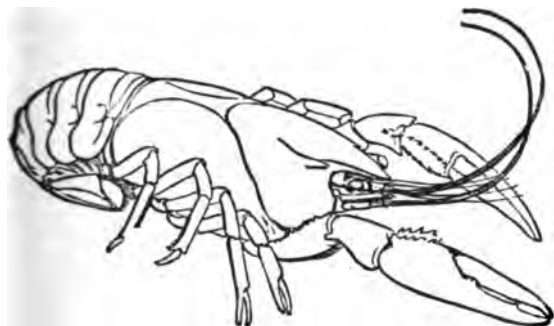

FIG. 25.—Freshwater Cray-fish from the Mississippi River. (Morse.)

He has shown that in this species the metamorphosis is a perfectly gradual one, and that, dissimilar as is the *zoëa* when it quits the egg from the adult animal, yet nevertheless the change at each moult is so small that it is only by a comparison between the earliest and the last stages that we perceive the amount of the change which has actually taken place.

"The most important peculiarities," writes Frits Müller, "which distinguish this *zoëa*-brood from the adult animal are as follows. The middle body (thorax), with its appendages, those five pairs of feet to which these animals owe their name of Decapoda, is either entirely wanting, or scarcely indicated; the abdomen and tail are destitute of appendages and the latter consists of a single piece (fig. 26). The mandibles, as in the Insecta, have no palpi. The maxillipeds, of which the third pair is often wanting, are not yet brought into the service of the mouth, but appear in the form of biramous natatory feet. Branchia are wanting, or where their first rudiments may be detected as small verruciform prominences, these are dense cell-masses through which the blood does not yet flow, and which have therefore nothing to do with respiration. An interchange of the gases of the water and the blood may (and no doubt does) occur all over the thin-skinned surface of the body; but the lateral parts of the carapace may unhesitatingly be indicated as the chief seat of respiration.

"They consist, exactly as described by Leydig in the Daphnia, of an outer and inner lamina, the space between which is traversed by numerous transverse partitions dilated at their ends; the spaces between these partitions are penetrated by a more abundant flow of blood than occurs anywhere else in the body of the *zoëa*. A constant current of water passes beneath the carapace from behind forwards, maintained as in the adult animal by a foliaceous appendage from the second pair of maxillae.

"The *zoëæ* of the crabs are usually distinguished by long, spiniform processes of the carapace (fig. 27). One of these projects upwards from the middle of the back, a second downwards from the forehead, and frequently there is a shorter one on each side near the posterior inferior angles of the carapace. But in the *zoëa* of *Maia*, *Eurynome*, and an allied genus to *Acasus*, the spines are wanting in the first two genera, and but of inconsiderable size in the last-named genus.

"The following are the more important peculiarities in the *zoëa* of the crabs, although less striking than these processes of the carapace, which, in combination with the large eyes, often give them so singular an appearance. The anterior (inner) antennæ are simple, not jointed, and bear two or three olfactory filaments at the extremity; the outer antennæ frequently form

<sup>1</sup> On the development of Decapod Crustacea, *Phil. Trans.*, 1858, pl. xl-xlvi. p. 539.

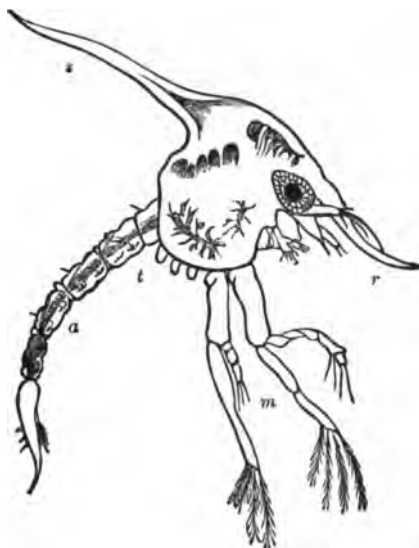

FIG. 27.—*Zoëa* of Common Shore-Crab in its second stage. r, rostral spine; s, dorsal spine; m, maxillipeds; t, buds of thoracic feet; a, abdomen. (Spence Bate.)

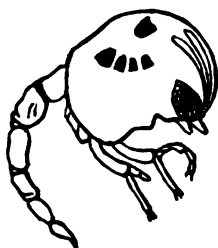

FIG. 26.—*Zoëa* of Common Shore-crab, *Carcinus maenas*, Penn. sp., in its first stage. (Spence Bate.)



FIG. 29.

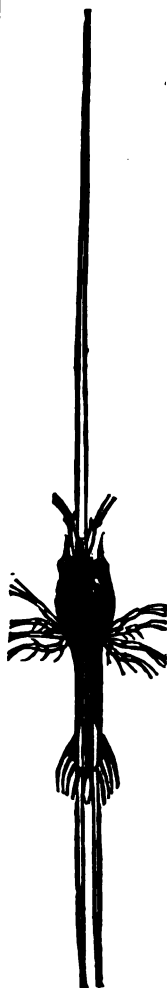

FIG. 28.

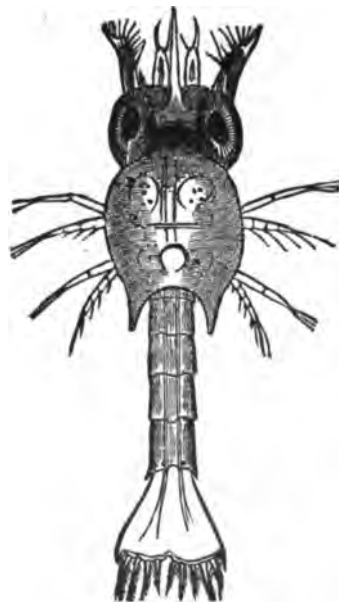

FIG. 30.

FIG. 28.—*Zoëa* of *Percollana stalloella*, F. Müll., mag. 15 diam.

FIG. 29.—*Zoëa* of *Hippo eremia*, mag. 45 diam.

FIG. 30.—*Zoëa* of Hermit-Crab, mag. 45 diam. (Frits Müller.)

a long spine-like process, and bear a minute squamiform process like the antennal scale in prawns. Of the natatory feet (afterwards *maxillipeds*) only two pairs are present, the third is entirely wanting, or present, like the five following pairs of feet, only as minute buds. The tail in zoëa is very variable in form, but nearly always bears three pairs of setæ upon its hinder margin."<sup>1</sup>

When the young zoëa first escapes from the egg, it is enveloped by a membrane veiling the spinous processes of the carapace, the setæ of the feet, and the antennæ; but this is cast off in a few hours. The zoëa of *Porcellana* (fig. 28) seem to differ widely from true crabs, but really approach them very closely. The dorsal spine is wanting, but the frontal and lateral spines are of extraordinary length, and directed straight forward and backward. The tail bears five pairs of setæ.

The zoëa of *Hippa eremita* also resembles that of the crab in general appearance and in mode of locomotion (fig. 29). The carapace has only a short broad frontal process; and the caudal plate is edged with numerous short setæ. The zoëa of hermit-crabs (fig. 30) have simple antennules like those in the Brachyuran zoëa. The antennæ bear a scale-like appendage on the outside analogous to that in the prawn. There are only two pairs of well-developed natatory feet (maxillipeds), but the third pair are present in the form of two-jointed rudimentary appendages destitute of setæ. The hinder border of the tail bears five pairs of setæ.

The zoëa of the shrimps and prawns agree closely with the Anomura. They have a small median eye between the large compound ones. The third pair of maxillipeds are always present.<sup>2</sup>

In investigating the development of the spiny lobster, Claus found embryos in the ova with completely segmented bodies, but wanting the abdominal and caudal appendages and the last two thoracic somites. They have a single median eye, the anterior antennæ are simple, the posterior have a small secondary branch; the maxillipeds are divided into two branches.<sup>3</sup>

The most singular example of lowly development recorded by Fritz Müller is that of a prawn of the genus

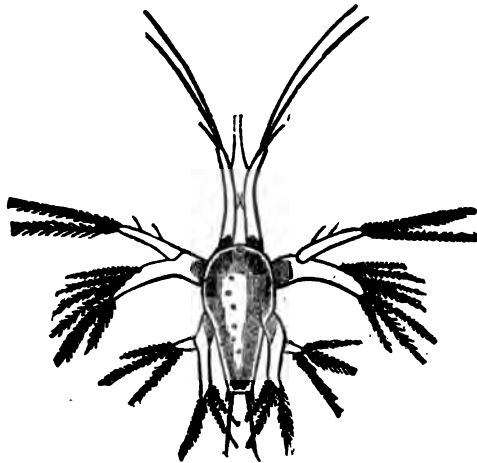

FIG. 31.—Nauplius of a Prawn. Magn. 45 diam. (Fritz Müller.)

*Penæus*. The young appear to quit the egg with an unsegmented ovate body, a median frontal eye, and three pairs of natatory feet, of which the anterior pair are simple and the others biramous, agreeing with the larval form common to the lower Crustacea, to which O. F. Müller has given the name of *nauplius*.<sup>4</sup> In this stage there is no trace of a carapace, no trace of paired eyes, no trace of masticating organs, and the mouth itself is overarched by a helmet-like hood. In one of these species the intermediate forms which lead from the nauplius to the prawn have been discovered by Fritz Müller in a nearly continuous series (*op. cit.* p. 57).

After successive moults the nauplius gives place to the

<sup>1</sup> Fritz Müller, *Facts and Arguments for Darwin*, pp. 49-52.

<sup>2</sup> Fritz Müller, *op. cit.*, pp. 53-55.

<sup>3</sup> Coste asserts that he has bred young *Phyllosoma* from the ova of *Palinurus vulgaris*, a statement, says Fritz Müller, that requires further proof, especially as the more recent investigations of Claus upon *Phyllosoma* by no means favor this conclusion (Fritz Müller, *op. cit.* p. 57).

<sup>4</sup> Compare fig. 31 with the nauplius of *Apus* and *Artemia*, 5 and 6 of fig. 57, and with that of *Idolus*, fig. 60, A, and fig. 61.

zoëa period, during which the paired eyes, the segments of the thorax and abdomen, and the various appendages

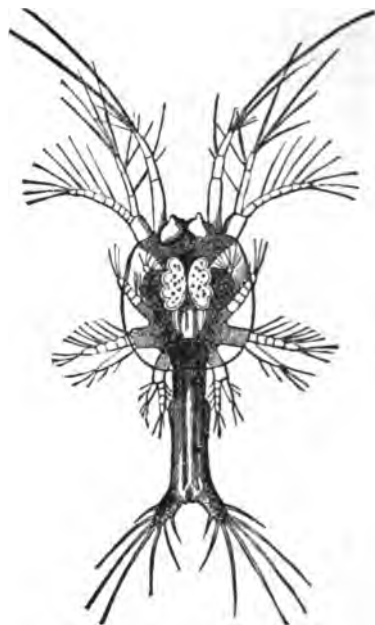

FIG. 32.—Young Zoëa of the same Prawn. Magn. 45 diam. (Fritz Müller.)

are produced in bud-like succession. The zoëa next passes into the *mysis*-stage; the antennæ cease to serve for locomotory organs, and their place is taken by the thoracic feet clothed with setæ (fig. 34). The abdomen, furnished with powerful muscles, jerks the animal through the water in a series of lively jumps.

In the case of those Crustacea in which the young, as in *Mysis*, are retained within the incubatory pouch of the

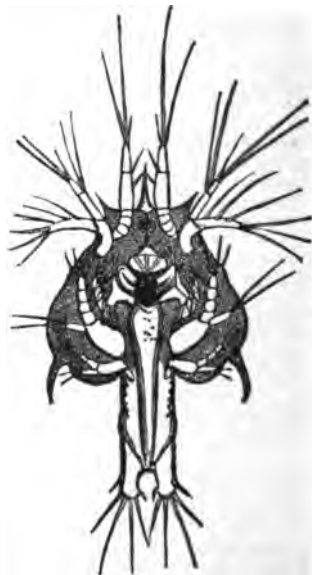

FIG. 33.—Youngest observed Zoëa of another Prawn. The minute buds of a third pair of maxillipeds are visible. The formation of the abdominal segments has commenced. Paired eyes still wanting. Magn. 45 diam. (Fritz Müller.)

parent after quitting the egg, the larva emerges from the egg in a far more rudimentary and destitute condition than in those genera in which no such protective arrangement exists. Van Beneden, whose description of the develop-

ment of *Mysis* is confirmed by Frits Müller, mentions the very curious fact that the first segment that makes its appearance is the tail. In other stalk-eyed Crustacea the embryo has the ventral surface of the anterior and posterior halves of the body folded together, and the dorsal surface forms the external convexity of the young animal within the egg; but in *Mysis* the ventral surface is external and convex. The tail soon acquires the furcate form characteristic of the zoëa of the prawn; two thick ensiform appendages next make their appearance at the anterior end of the body, and behind these a pair of tubercles; these are the antennæ and mandibles. At this immature stage of its development the egg-membrane bursts

*Squilla* are mentioned by Frits Müller; the elder of these zoëa (fig. 35) resembles the mature *Squilla*, particularly in the structure of the great raptorial thoracic feet and of the last cephalic pair; but the six pairs of feet which follow



FIG. 35.—Male of *Bodotria*. Magn. 10 diam. (Frits Müller.)

these are still wanting, although their somites are clearly seen. The abdomen shows rudiments of four pairs of brachial feet and one or two pairs of biramose natatory feet, but the tail has no appendages and still appears as a simple lamina.

The investigations of Goodsir, in 1843,<sup>1</sup> made us acquainted with a most singular family of Crustacea, the *Diastylidae*, or *Cumacea*, which have been placed in the Podophthalmia near to *Mysis*. In general aspect the adult animal presents the most larval and embryonic characters, and might with propriety have been treated as a larval form, had not Goodsir, and subsequently Kröyer, actually taken the young from the brood-pouch of the parent. The antennæ are very small, the thoracic feet are, in most, furnished with setæ; in *Cuma* and *Alauna* the abdominal segments are moniliform and destitute of appendages. The caudal segment bears two long bifurcated styles. In *Bodotria* (fig. 36) five of the abdominal somites bear finlets. The young examined by Kröyer, taken from the brood-pouch of the female (which resembles that in *Mysis*), were already one-fourth the length of the parent, which they resembled in every respect. Whether or not there is a considerable development of the young of *Cumaceæ* within the brood-pouch

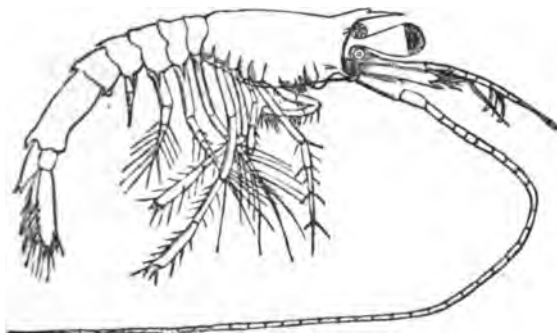

FIG. 34.—Older larva produced from Zoëa represented in fig. 33. The last segment and the last two pairs of feet of the middle-body are wanting. Magn. 20 diam. (Frits Müller.)

before any internal organ, or even any tissue except the cells of the cutaneous layer is formed. The young animal may now be said to be in its nauplius-stage, but its nauplius-akin resembles more nearly a second egg-membrane within which its further development proceeds. The ten pairs of appendages of the cephalic and thoracic divisions of the body make their appearance simultaneously, and at a later period the five abdominal feet. Soon after the young *Mysis* has cast its nauplius envelope, it leaves the brood pouch of its mother.

In *Squilla mantis* the eggs do not adhere to the abdominal feet of the parent (which in this genus are branchiferous), but are (says Frits Müller) deposited in the form of thin, round, yellow plates within its submarine burrow. The spawn is consequently difficult to procure, and quickly dies when removed from its natural hatching-place. In the embryo of *Squilla* the heart is short; the body is long and segmented, but without appendages; the tail is bilobate, and there are indications of the rudiments of six pairs of limbs. If it acquires more limbs before exclusion, the youngest larva must be on a par with the youngest of *Bu-*

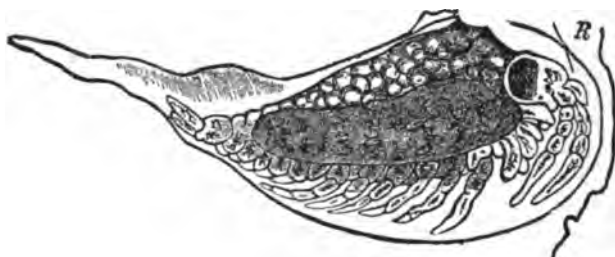

FIG. 37.—Maggot-like larva of *Ligia*. Magn. 15 diam. E, remains of egg-membrane. We see on the lower surface, from before backwards, the anterior and posterior antennæ, the mandibles, the anterior and posterior maxillæ, maxillipeda, six ambulatory feet, the last segment of the middle-body destitute of appendages, five abdominal feet, and the caudal feet. (Frits Müller.)

of the parent is not certainly known. In the embryo the caudal portion is bent upwards as in the Isopoda, and the last pair of thoracic feet are wanting.

The development of the Edriophthalmia, or sessile-eyed Crustacea, is more simple than that of the stalk-eyed forms. In the "rock-slater," *Ligia* (fig. 37), the embryo is bent upwards within the egg, as in *Mysis*, and has also, like *Mysis*, a larval membrane within which the young *Ligia* is developed. In *Mysis* this larval skin may be compared to a nauplius; in *Ligia*, however, it is destitute of appendages, and resembles a maggot with a long simple tail (fig. 37). The dorsal surface of the young *Ligia* is united to the larval skin a little behind the head. A foliaceous appendage is produced at this point, but exists only for a short time, and disappears before the young slater quits the brood-pouch of the mother. The young animal, when it commences to take care of itself, resembles the parent, save that it has only six, instead of seven pairs of ambulatory feet, and the last thoracic somite is but slightly developed and is destitute of appendages. The sexual peculiarities in this as in the young of other Crustacea are not developed at this early period; thus the males lack the hand-like enlargements of the anterior ambulatory feet, and the copulatory appendages are also absent.

The eggs and early stages of *Asellus aquaticus* have

<sup>1</sup> Edinb. New Phil. Jour., 1843. See also Bell, *British Stalk-eyed Crustacea*, 1863, pp. 321-333, and Frits Müller, *Für Darwin*, Engl. trans., p. 81.

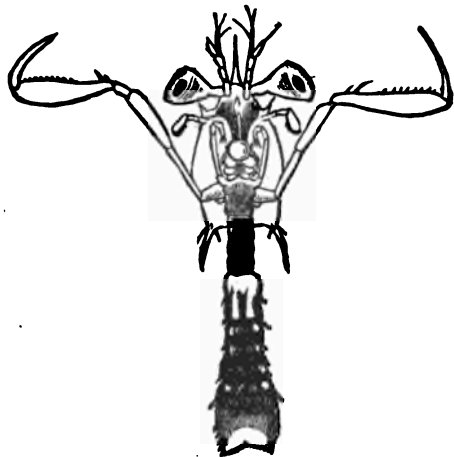

FIG. 36.—Zoëa of a Stomapod, probably *Squilla*. Magn. 15 diam. (Frits Müller.)

phousia observed by Claus. Only two larval forms of

been investigated by numerous observers. De Geer, Rathke,<sup>1</sup> Spence Bate,<sup>2</sup> and Anton Dohrn<sup>3</sup> have made careful observations on the embryology and development of this abundant freshwater Isopod. As in *Ligia* the embryo is bent upwards within the egg. It quits the egg in a most imperfect state, more so, says Rathke, than any other articulated or vertebrated animal. It is furnished in its earliest stages with two lateral external appendages, which probably are homologous with the foliaceous appendage observed by Fritz Müller at the back of the head in *Ligia*. These so-called appendages are subsequently moulted. Moreover in the young *Aeolus* there are only six leg-bearing segments, and six, instead of seven, pairs of legs as in the adult. The curvature of the embryo upwards, instead of downwards, seems to have been generally observed by Rathke, Dohrn, Fritz Müller, and others. The larval skin is in some genera so closely applied to the egg itself as possibly to be mistaken for an inner egg-membrane. The absence of the last pair of thoracic feet seems also a constant character; all the other limbs are usually well developed in the young of normal Isopods; but in the remarkable and aberrant genus *Tanais* (fig. 38) all the abdominal feet are wanting, but not the caudal appendages; they make their appearance, however, simultaneously with the last pair of the thoracic feet.

Among the many interesting facts relative to the development of the Crustacea not the least remarkable are the series of retrograde metamorphoses which certain Isopods undergo as a consequence of their assuming a parasitic mode

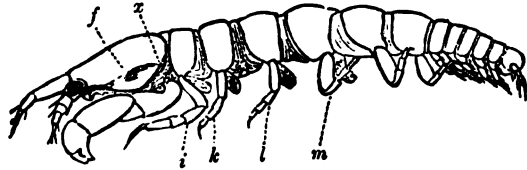

FIG. 38.—*Tanais dubius* (?) Kr. ♀, magnified 25 times, showing the orifice of entrance (s) into the cavity overarched by the carapace in which an appendage of the second pair of maxillae (l) plays. On four feet (k, l, m) are the rudiments of the lamellae which subsequently form the brood-cavity. (Fritz Müller.)

of life when adult. Thus the *Cymothoa*, or "Fish-lice," which in the adult state live parasitic on fishes, clinging firmly by means of their short recurved hook-like feet, are lively free-swimming Crustacea in the larval state. Still

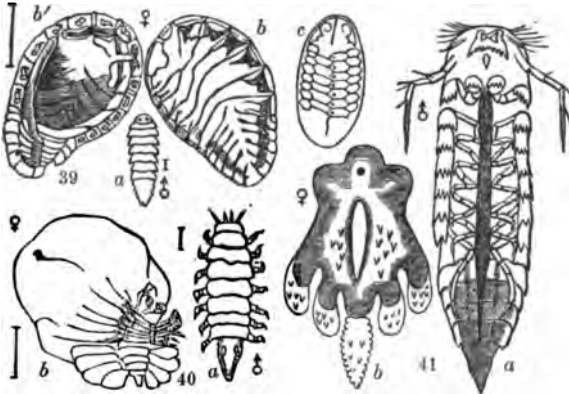

FIG. 39.—*Bopyrus squillarum*, Latr. a, male; b, female (underside); b, the same (dorsal view). (After Spence Bate.)  
 FIG. 40.—*Phryxus abdominalis*. a, the male; b, female (ventral aspect). (After Spence Bate.)  
 FIG. 41.—*Cryptothiria Balani*. a, male; b, female; c, larva. (After Spence Bate.)

greater is the metamorphosis which the adult female undergoes in *Bopyrus* (fig. 39), *Phryxus* (fig. 40), *Ione*, *Gyge*, and several other allied genera, which are parasitic on crabs and lobsters, taking up their abode within the branchial cavity. The adult is usually quite destitute of eyes; the antennae are rudimentary; and the broad and flat body is fre-

quently unsymmetrically developed in consequence of the confined space in which it lives; its segments are more or less amalgamated together; the feet are stunted, and the abdominal appendages transformed into foliaceous or highly branched gills. The males are diminutive in size, but usually they have their eyes, antennae, and feet better preserved than the females; the abdomen is, however, rudimentary, and not unfrequently altogether destitute of appendages.

Among the Isopoda, in the remarkable genera *Cryptothiria*, *Cryptoniscus*, and *Entoniscus*, we meet with forms even still more debased in their adult parasitic condition than *Bopyrus*. In the case of *Cryptothiria Balani*<sup>4</sup> (fig. 41), first noticed



Fig. 42.



Fig. 43.

FIG. 42.—*Cryptoniscus planarioides*, female. Magn. 3 times. (Fritz Müller.)

FIG. 43.—Embryo of the same. Magn. 90 diam. (Fritz Müller.)

as a male cirripede by Goodsir in 1843, but not rightly determined until 1851, by C. Spence Bate, the female is a large inert seven-lobed fleshy mass, destitute of exerted antennae, jaws, legs, or branchial appendages, lying within the shell, and attached to the base of the animal of *Balanus balanoides*. The male is free and resembles the male in the *Bopyridae*; its body is long and slender, and is furnished with seven pairs of legs; it has been met with by Spence Bate, Dana, and other observers within the body-cavity of *Balani*. Here then we have a Crustacean belonging to a higher order, viz., the Isopoda, living parasitic within the shell and deriving its nourishment from one belonging to a lower order, viz., the Cirripedia.

The history of *Cryptothiria pygmaea* (Rathke, sp.) and *Cryptoniscus planarioides* (F. Müller) is perhaps still more remarkable. Professor Bell had long ago noticed the frequent presence of a singular parasite on the inner surface of the abdomen of *Portunus* and *Carcinus* on our coasts, having *prima facie* the aspect of a bag of immature egg. This had been described by Rathke in 1841 as an Eutossarian, but has since been proved by its transformations to be a Cirripede, and was named *Pellogaster*. In 1858 Lilljeborg found what he deemed to be a female *Pellogaster* with an egg-sac; but a careful dissection led to the discovery that another parasite of a higher order, namely a *Cryptothiria*, had become parasitic upon the parasite. The most curious part of this super-parasitic history is, that the roots of *Sacculina* and *Pellogaster* (two forms of rhizocephalous Cirripedia parasitic on crabs and hermit-crabs) seem constantly to be made use of by two parasitic Isopods, namely, a *Bopyrus* and the before-mentioned *Cryptoniscus planarioides*. These take up their abode beneath the *Sacculina*, and cause it to die away by intercepting the nourishment conveyed by the roots; the roots, however, continue to grow, even without the *Sacculina*, and frequently attain an extraordinary extension, especially when a *Bopyrus* obtains its nourishment from them (Fritz Müller, *op. cit.* p. 94). The free males and the young of *Cryptothiria* and *Cryptoniscus* are unlike young Cirripedes, but resemble the young of *Bopyrus*; they are, in fact, larval Isopods.

The female of *Entoniscus* (fig. 44) resides within the body of a species of *Porcellana*, lying in a thin-walled sac between the liver, intestine, and heart of its host, the head being destitute of eyes or antennae; the thorax has become an irregular inarticulate sac, beset with enormous brood laminae; the long vermiform and extremely mobile abdomen has sword-shaped legs; and swelling out above it in a globular form, as if in a hernial sac, the heart lies at the base of the first segment. The young of this singular parasite closely resembles that of *Bopyrus* and *Cryptothiria*.

The embryo of the Amphipoda can be distinguished from that of Isopoda at a very early period; the former being bent downwards with the dorsal surface external, whilst the latter is bent backwards with the ventral surface

<sup>1</sup> *Abhandlungen zur Bildungs- und Embryonalentwicklung des Menschen und der Thiere* (Leipzig, 1832).

<sup>2</sup> Spence Bate and Westwood, *Hist. Sessile-eyed Crustacea* (1868, vol. II, pp. 346-347).

<sup>3</sup> "Die embryonale Entwicklung des *Aeolus aquaticus*" (a reprint from *Zeitsch. f. wissenschaft. Zoologie*, xvii., Bd. II., Heft 1, Jena, 1866).

<sup>4</sup> C. Spence Bate and J. O. Westwood, *British Sessile-eyed Crustacea* (1868, 8vo, vol. II, p. 267).



external. The embryo in all the genera which have been examined is attached on the anterior part of the back to the inner egg-membrane by a peculiar structure—remin- ding one of the union of the young Isopoda with the lar- val membrane, and of the unpaired “adherent organ” on the nape of the Cladocera, so remarkably developed in *Evadne*, and persistent through its life in that gen- us; but though present in the young of *Daphnia*, it dis- appears in the adult (Frits Müller).



FIG. 44.—*Entoniscus cancororum*, female. Magn. 3 times. (Frits Müller.)

The metamorphosis of the young Amphipod after it quits the egg seems greatly reduced and simplified, for before quitting the egg it acquires its full number of segments and limbs.<sup>1</sup> In those instances in which certain of the segments are amalgamated together, or where one or more segments are deficient in the adult, we find the same fusion and the same deficiencies in the young animals taken from the brood-pouch of their mother. The development of the Hyperiidæ, an oceanic group of Amphipods found only in the gill-cavities of the *Medusa*, is very exceptional and remarkable. Thus, in *Hyperia* the youngest larvæ, taken by Fritz Müller from the brood-pouch of the mother, already possessed the whole of the thoracic feet; on the other hand, those of the abdomen were not as yet developed. All the feet are at first simple, but soon become converted into highly denticulated prehensile feet. In this state they remain for a very long time,—the abdominal appendages growing into powerful natatory organs, whilst the eyes, at first wanting or very minute, expand into large hemispheres occupying the entire lateral, and even encroaching upon the dorsal and frontal walls of the head. The females (*Hyperia*) are distinguished by a very broad thorax, and the males (*Lestrigonus*) by their long antennæ. The youngest larvæ cannot swim, but are provided with chelate feet (as shown by Spence Bate) by which they cling firmly to the swimming-laminæ of their host. The feet of the adults are simple, but they are then excellent swimmers, and are not unfrequently met with-free in the open sea. The diversity in structure of the antennæ in the adult male and female Hyperiidæ is so great as to have led naturalists to place them in separate genera or

in the females of *Brachysoelus*, although the male possesses them, like other Amphipoda.

In the foregoing brief sketch of the evolution of the young in the Malacostraca, it will be perceived that cer- tain lines of development are followed, but these are sub- ject to great diversity, and often vary greatly in the same order.<sup>2</sup> Thus we have:—

- I. The larval metamorphosis undergone within the egg.<sup>3</sup>
  - II. The larval metamorphosis undergone within the incubatory pouch of the mother.<sup>4</sup>
  - III. The young first appearing as free-swimming soœa.<sup>5</sup>
  - IV. The young first appearing as nauplii.<sup>6</sup>
- These four stages in the larval development of the Crus-

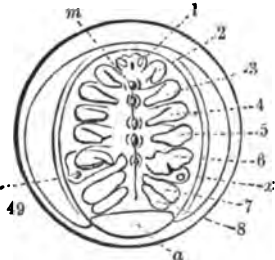
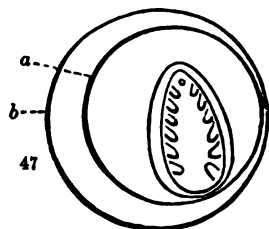
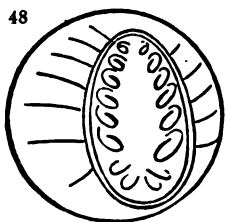
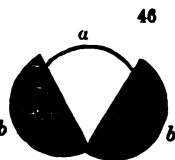

FIG. 46.—Egg of *Limulus polyphemus*: a, protoderm; b, the chorion (after Dohrn).

FIG. 47.—Third stage in the embryo of *Limulus*: a, protoderm; b, chorion (after Packard).

FIG. 48.—Fourth stage (7) in the embryo of *Limulus* (after Dr. Packard's figure).

FIG. 49.—Fourth stage (7) in the embryo of *Limulus*: 1, antennule; 2, antenna; 3-5, maxillipedes; 7 and 8, thoracic plates afterwards bearing the branchiæ; m, the mouth; s, the ovarian apertures (?); a, the abdomen (after Dohrn).

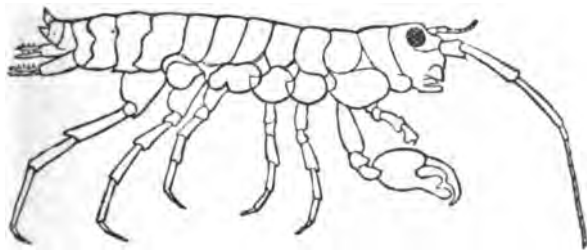

FIG. 45.—*Orchestia Darwinii*, n. sp. male. (Frits Müller.)

even families; but this difference is developed only when the animals are full-grown. Up to this period the young of both sexes resemble the females. In the male shore- hoppers (*Orchestia*) the second pair of the anterior feet is provided with a powerful hand (fig. 45), as in the majority of Amphipoda, but quite different from the female; the young nevertheless resemble the female. This is also the case in the adult male in *Limulus*, in which the second pair of appendages (antennæ) are peculiarly modified (see 3a in fig. 12 above); but in the young male they exactly resemble those of the adult female. According to Spence Bate and Frits Müller, this second pair of antennæ are absent

<sup>1</sup> “Even peculiarities in the structure of the limbs, so far as they are common to both sexes, are usually well marked in the newly-hatched young, so that the latter generally differ from their parents only by their stouter form, the smaller number of the antennal joints and olfactory filaments, and also of the setæ and teeth with which the body or feet are armed, and perhaps by the comparatively larger size of the secondary flagellum” (Frits Müller. *Für Darwin*, Engl. trans., p. 76).

tacea, it will be perceived, are not by any means strictly confined to particular orders of the Mala- costraca, nor do they hold good for all the members of the group in which they have been observed to occur. There is, in fact, no “hard and fast” rule in the class, but on the contrary, there would appear to be numer- ous exceptions and variations in every group.

In considering the larval development of the En- tomostraca, we shall find that their early history, when compared with that of the Malacostraca, is greatly sim- plified, and that the first or nauplii form of the young which Fritz Müller *exceptionally* met with in *Penæus*, has now become the rule almost without exception.

*Embryology of Limulus*.—Starting with that remark- able representative of a most ancient and now al- most extinct order, the Merostomata, we find in *Limulus* a genus in which the young may be said to undergo

<sup>2</sup> In the normal Isopoda, as we have seen, the development of the young is one of progress to the adult; but in the parasitic forms the young animal before attaining the adult state actually has to undergo a retrograde metamorphosis.

<sup>3</sup> An instance of this occurs in the Decapoda-Brachyura, viz., *Geocarcinus* (J. O. Westwood); in the Anomoura, *Dromia* (H. Woodward); in the Macroura, *Potamobius (Astacus) fluviatilis* (Rathke). In the Amphipoda the young appear to have always acquired their full number of segments and appendages before quitting the egg (Frits Müller, Spence Bate, etc.).

<sup>4</sup> In the Stomapoda by *Myris*, and *Cumacea* (?); in the Isopoda by *Asellus*, *Ligia*, etc.

<sup>5</sup> In the Decapoda-Brachyura by *Carcinus* (Spence Bate), by *Cyclo- gressus* and many other crabs and lobsters (Frits Müller).

<sup>6</sup> In the Decapoda-Brachyura by a prawn near to *Penæus* (Frits Müller).

<sup>7</sup> Figs. 46-55 are from H. Woodward's paper on the “Relationship of the Xiphosura to the Eurypterida, etc.” *Quart. Journ. Geol. Soc.*, 1872, vol. xviii., p. 50.

<sup>8</sup> It is very desirable that this remarkable and isolated case in the development of the Macrouran Decapod should be confirmed by others.

all their earlier metamorphoses within the egg, thus at once offering an exception to the general rule as

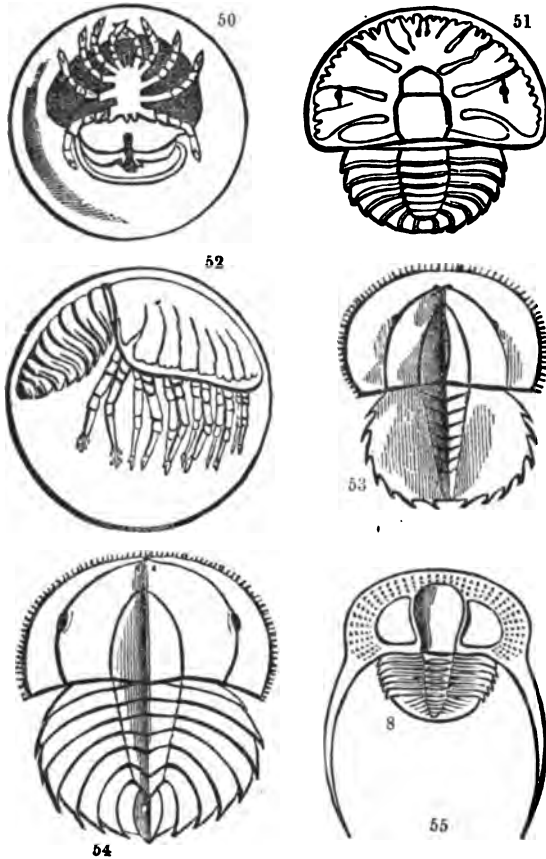

FIG. 50.—Fifth stage (?) of embryo of *Limulus* (after Dohrn). At this stage the chorion is split, and the protoderm is expanded by the admission of water by endosmosis, in which the embryo is seen to revolve.

FIG. 51.—Ninth stage (?) of embryo, "just before hatching" (after Packard); dorsal aspect.

FIG. 52.—The same; side view of embryo.

FIG. 53.—Larva of *Limulus* recently hatched (after Packard).

FIG. 54.—Larva of *Limulus* at hatching (the "Trilobitenstadium" of Dohrn).

FIG. 55.—*Trinucleus ornatus*, Sternb.; adult specimen with six thoracic segments and fully-developed genal spines.

regards the Entomostraca. The embryology of *Limulus* has been investigated by Dr. Anton Dohrn<sup>1</sup> and Dr. A. S. Packard.<sup>2</sup> The natural history of the king-crab has been studied by the Rev. Samuel Lockwood,<sup>3</sup> and its anatomy has quite recently formed the subject of two elaborate memoirs by Professor Owen,<sup>4</sup> and by Dr. Alphonse Milne-Edwards.<sup>5</sup>

We can only very briefly notice these important contributions to our knowledge of the Xiphosura here.

The female *Limulus* of the north-east American coast spawns twice every year during the months of May, June, or July,<sup>6</sup> at the great high tides. It comes up to near high-water mark, spawning under water; thus the eggs are daily exposed to the sun's warmth for a short time at low water. Great numbers arrive in pairs, the male grasping the sides of the shield of the female with his strong and

<sup>1</sup> "Zur Embryologie und Morphologie des *Limulus polyphemus*," in *Jenaischen Zeitschrift*, Band vi. Heft 4, Taf. xiv. and xv., 1871.

<sup>2</sup> "The Development of *Limulus polyphemus*," by A. S. Packard, in *Memoirs of Boston Soc. Nat. Hist.*, 1871, vol. ii., pp. 155-202, pl. 3-5.

<sup>3</sup> "The Horse-Foot Crab," by the Rev. S. Lockwood, in *American Naturalist*, 1870, vol. iv., p. 257.

<sup>4</sup> "Anatomy of the American King-Crab," by Prof. Owen, in *Trans. Ann. Soc.*, 1872, vol. xxviii., pp. 459-506, pl. 36-39.

<sup>5</sup> *Etudes sur les Xiphosures et les Crustacés de la Région Méridionale*, par Alph. Milne-Edwards (Paris, 1873, folio, pp. 43, pl. 1-12).

<sup>6</sup> These investigations are confined to the American king-crab, and were made at Raritan Bay, New Jersey. Van der Hoeven's memoir on *Limulus* was written on the East Indian *Limulus moluccanus* (Rech. sur l'Hist. Nat. et Anatom. des *Limulus*, fol., 1838, Leyden, p. 43, plates 1-7).

peculiarly modified chelate antennae. The eggs are deposited by the female in a hole in the sand, and are fecundated by the male after deposition, and are then left to hatch. Only one other similar case is on record, namely, that of the common freshwater cray-fish, in which, according to M. Chantran, the eggs are fecundated after expulsion from the oviducts. The eggs occupy from fifty to seventy days in hatching, according to the favorable or unfavorable conditions under which they are deposited; some which Dr. Lockwood set aside in a jar of sea-water in a dark place hatched after 350 days!

The egg has two membranes, a dense inelastic chorion and an inner elastic protoderm.<sup>7</sup> This chorion remains entire so long as development is arrested or is sluggish, but as soon as the embryo increases in size, the tough chorion splits asunder, and the inner elastic protoderm enlarges, becomes dense, and vicariously fulfils the duties of the former (fig. 46).

A similar splitting of the external egg-membrane has been noticed in *Apus*. Fritz Müller points out that in some Isopoda (as for instance *Philoscia*) the larval skin is not only without any folds or sac-like diverticula, but is closely applied to the egg-membrane. This second egg-membrane in *Limulus* may perhaps therefore correspond to this first larval skin. Certainly, when the embryo first appears, its position is the same as in *Asellus*, *Ligia*, *Philoscia*, and other Isopoda, i. e., with its ventral surface convex (figs. 47 and 48). In its first stage the larval *Limulus* has six bud-like indications on each side of the mesial line, where the paired cephalic appendages will be developed (fig. 47). In later stages (figs. 48-52) we have first two, then more, up to six pairs, of thoracic natatory feet (which in the adult become branchiferous), and traces of as many as nine post-cephalic somites, but the last three never attain appendages. As the young *Limulus* increases in size, the yolk gradually becomes absorbed, and the larva assumes the position of an Amphipod in the egg, having its dorsal surface convex, instead of its ventral, which is now concave (fig. 52). There appears to be no stage seen in larval *Limulus* which can be compared with the nauplius stage of *Apus* (as Dr. Packard has supposed).<sup>8</sup> The *Trilobiten stadium* of Dohrn<sup>9</sup> resembles *Prestwichia rotundata* from the Coal-measures far more than any known Trilobite. Packard has figured an earlier (?) stage of

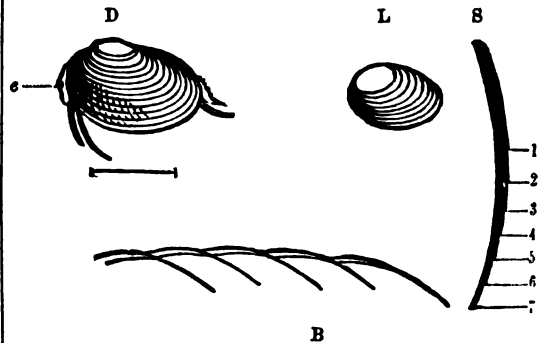

FIG. 56.—*Estheria*, sp. D, from Dubuque, Iowa; (a) the eye. L, from Lynn, Massachusetts (nat. size). S presents a highly magnified section of one of the valves to show the successive growths. B, an enlarged portion of the edge of the shell along the back, showing the overlap of each growth. (Morse's Zoology.)

*Limulus* than Dohrn's "Trilobiten-stadium," which much more resembles *Trinucleus*<sup>10</sup> (compare figs. 51 and 55).

In its earlier stages the young *Limulus* can roll its pro-

<sup>7</sup> Dohrn calls the inner membrane in the egg of *Limulus* the "chorion" and the outer the exochorion, but Packard's term "protoderm" appears preferable for the former.

<sup>8</sup> Packard, *op. cit.*, p. 163.

<sup>9</sup> Dohrn, *op. cit.*, 630, Taf. xv. fig. 4.

<sup>10</sup> Salter supposes (*Quart. Journ. Geol. Soc.*, vol. iii., 1847, p. 222) that the membranous margin of the head-shield of *Trinucleus* was once entire, "then became plicate, then perforate, and lastly separated into linear processes." It seems more probable that the margin of the head-shield was originally digitate, then gradually closed up, leaving only perforations along the sutures in some, and only plicae in others. We have an analogous case in *Haliotis*, *Sciasterella*, and *Pleurotomaria* amongst the Mollusca, in which a slit becomes partially or wholly closed up, leaving perforations at intervals. In the Mollusca it is connected with the respiratory functions, but in *Limulus*, *Hemiaspis*, and *Trinucleus*, it is probably a remnant of the margins of the primitive segments which have coalesced to form the cephalic shield.

rior segments under its head-shield, and when it at last leaves the egg it can swim well, and has been captured by Alexander Agassiz, swimming freely on the surface of the ocean, three miles from Nausahon Island, Buzzard's Bay.<sup>1</sup> At this period it has no caudal spine or telson. This is acquired only at a later moult, whilst a year or more elapses before the young males can be distinguished by their modified antennæ from the females (see 3a in fig. 12).

In the shield-bearing, naked, and bivalved Phyllopoda, represented by *Apus*, *Nebalia*, *Branchipus*, and *Eatheria*, the embryological development is no doubt analogous, though less is known in regard to *Eatheria* (fig. 56).

In *Apus* the male is not certainly known, all the progeny observed being fertile females. Probably, however

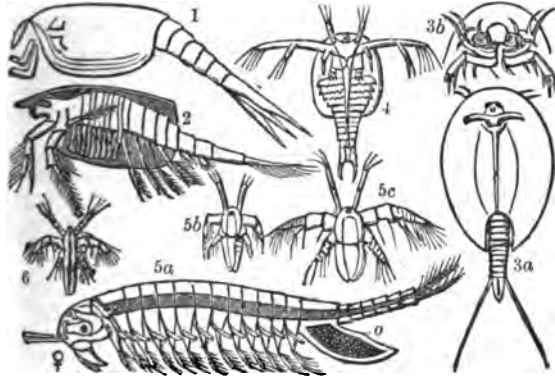

FIG. 57.—PHYLLOPODA.—1, *Crustocaris papilio*, U. Silurian, Lanark; 2, *Nebalia bipes* (one side of carapace removed to show branchial feet), Marine British; 3, *Lepidurus Angust*: a, dorsal aspect; b, ventral aspect of head showing the hypostome and mandibles; 4, larva of *Apus cancriformis*; 5, *Branchipus stagnalis*: a, adult female; b, first larval stage; c, second larval stage; 6, larva of *Artemia salina*.

(as is the case in *Daphnia*), males appear at a particular season of the year, and these suffice to render fertile several generations of females. The females let their eggs fall to the bottom of the water, where they remain until hatched by the sun's warmth. The eggs of *Apus* occupy from two to three weeks in hatching; the chorion splits, as in *Limulus*, revealing a semi-transparent inner egg-membrane. This also soon after bursts, giving freedom to a simple nauplius like that exceptionally met with by Frits Müller in a prawn allied to *Penæus*. The large cephalic shield, so characteristic of the adult *Apus*, is not seen in these early stages, and when it first appears it closely resembles that of *Peltoecaris*, an extinct Silurian form (4 in fig. 57). The nauplius, being short-bodied, does not display those graceful undulatory motions in the water observed in the adult, but progresses rather by a series of jerks like the adult *Cyclops*. At the end of eight or ten days the young Phyllopod has acquired considerable size. The body-segments and feet, so numerous in *Apus*, *Artemia*, and *Branchipus* (5a in fig. 57), are formed gradually (in repeated moults) from before backwards, without any sharply-defined regions of the body being discernible either by the time of their appearance or their form. All the feet are of the same pattern, and resemble the maxillæ of the higher Crustacea.<sup>2</sup>

The young animal exuviates about twenty times during the first two or three months; it is then full-grown, and in every respect resembles the parent.

*Nebalia* (2 in fig. 57) presents a remarkable exception to the rest of its order, the young apparently (like *Daphnia*) undergoing no metamorphosis after they quit the egg. Metschnikoff, who has recently studied the development of *Nebalia*, states that he has observed that it passes through both a nauplius and a zoëa stage within the egg,<sup>3</sup> and he

therefore regards *Nebalia* as a Phyllopodiform Decapod. We hardly see sufficient grounds at present for assigning *Nebalia* to a higher order than that in which it is now placed.

The Cladocera do not afford any additional aid in embryological research. They appear to quit the egg only smaller than the parent, but with their full number of limbs.

Of the developmental history of the Ostracoda but little is known. Zenker states that their anterior limbs are developed first, and the youngest stages, according to Claus, are shell-bearing nauplius-forms.

In the Copepoda (3-7 in fig. 58), the buckler does not cover more than the head and thorax, the abdominal segments, which are nearly cylindrical, extending beyond it. They are met with both in fresh waters and in the sea all over the world, and are most numerous represented both in a free state and as parasites. The larvæ of the non-parasitic forms (3b-d in fig. 58), all possess at the earliest period the three anterior pairs of limbs, i. e., the future antennæ and mandibles,—the anterior pair with a single joint, the two following pairs being bifurcate. The eye is single, and the labrum and mouth already occupy their permanent positions. The hinder body is short, the abdominal segments not being yet developed. In subsequent moults these posterior segments appear, and new limbs sprout forth. In the second stage a fourth pair of extremities is added; these are the future maxillæ; then follow three new pairs of limbs, the maxillæ, and two anterior pairs of natatory feet. The three anterior pairs of appendages still represent rowing-feet. At the next moult the first cyclops-stage is arrived at, when there is a resemblance to the adult in the structure of the antennæ and buccal organs, but the number of body-segments and appendages is still much less than in the parent. Only the rudiments of the third and fourth pairs of natatory feet are seen, and the body is made up of an oval cephalothorax, the second, third, and fourth thoracic segments, and an elongated terminal joint. In the *Cyclopidae* the posterior antennæ have lost their secondary branch, and the mandibles have completely thrown off the previously existing character of natatory feet; whilst in other families these appendages are persistent, although more or less altered. Many of the parasitic Copepoda do not pass beyond this stage of free development. Such forms as *Lernanthropus* and *Chondracanthus* never acquire the third

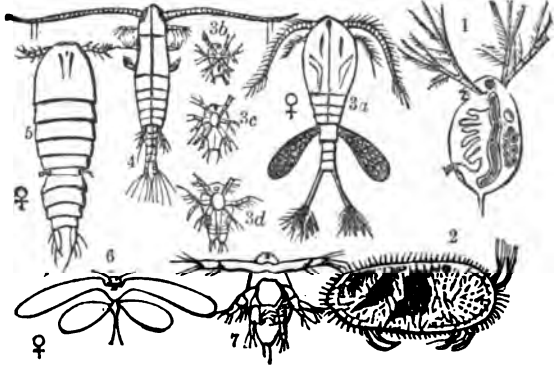

FIG. 58.—(1) CLADOCERA, (2) OSTRACODA, (3-7) COPEPODA. 1, *Daphnia pulex*, freshwater, near London; 2, *Candona hippida*, freshwater, near London; 3, *Cyclops quadricornis*: a, ♀, adult with egg; b, c, d, three stages of development of nauplius; 4, *Cyclopsus sycambriensis*, Fifth of Forth; 5, *Sapphirina ovalisaccolata*, Dana; 6, Atlantic, off harbor of Rio Janeiro; 7, Nauplius of Copepod. (After Frits Müller.)

and fourth pairs of limbs, nor does the fifth thoracic somite separate from the abdomen. Others, such as *Achtheres*, even fall to a still lower grade, by the subsequent loss of the two pairs of natatory feet. But all free Copepoda and most of

isons between the so-called "nauplius" and "zoëa" stages of any one Crustacean, when such stages are passed within the egg, and those of any other Crustacean whose young actually pass through such stages after they have quitted the egg. In the Decapoda we at present know of only one instance in which the young appears as a free-swimming nauplius; in the majority we see only the zoëal and larval stages; in some even the zoëal stage is overlooked, and the young appears as a larva differing but little, if at all, from the parent.

<sup>1</sup> Packard, *op. cit.*, p. 155.  
<sup>2</sup> "The maxilla of the Decapod larva is a sort of Phyllopodal foot" (Claus). "We might," says Frits Müller, "regard the Phyllopoda as zoëa, which have not arrived at the formation of a specialised thorax or abdomen, but have instead repeatedly reproduced the appendages which first follow the nauplius limb." The present writer has compared the Decapod larva in which the maxillæ serve temporarily as organs of natation and locomotion with the similar appendages which respectively fulfil this office in *Pterygotus*, *Stylonurus*, and *Limulus* (H. Woodward, *Mon. Pal. Soc. Merostomata*).  
<sup>3</sup> The greatest caution should be exercised in instituting compar-

the parasitic Crustacea pass through a longer or shorter series of stages of development, in which the limbs acquire a higher degree of division into joints in continuous sequence, the posterior pairs of feet are developed, and the last thoracic segment and the different abdominal segments are successively separated from the common terminal portion (Claus). Some parasitic Copepoda, such as *Aethides percorum*, certainly quit the egg like the rest in the nauplius-stage; the oval astomatous body bears two pairs of simple rowing feet, and behind these are two inflations marking the third pair, each having a long seta. Beneath this nauplius-skin a very different larva lies concealed,

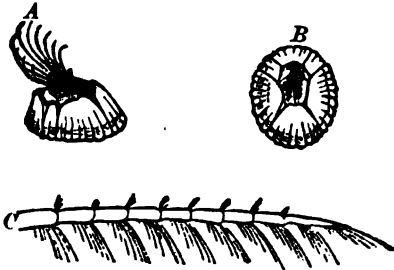

FIG. 59.—*A*, *Balanus* (young), side view with cirri protruded. *B*, upper surface of same; valves closed. *C*, highly magnified view of one of the cirri. (Morse.)

which in a few hours bursts its clumsy envelope, and makes its appearance in a form which agrees both in the segmentation of its body and the development of its extremities with the first cyclops-stage. The entire series of nauplius-stages which are passed through by the free Copepods are in this case completely overleapt.

Although the parasitic species of Copepoda are all more or less permanently fixed when adult, they pass their youthful stages as freely locomotive larvae. To this rule there is a singular exception in the genus *Caligus*. The young animal (described by Burmeister as a peculiar genus, *Chalinus*) lies at anchor upon a fish by means of a cable springing from its forehead, and having its extremity firmly seated in the skin of the fish. When sexual maturity is attained the cable is cut, and the adult *Caligus*, which is an admirable swimmer, is not unfrequently captured swimming freely in the sea (Fritz Müller).

The animals belonging to the last division comprise two orders, the Rhizocephala and the Cirripedia. They have

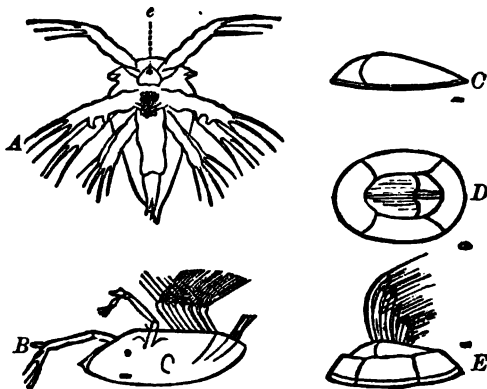

FIG. 60.—Early stages of *Balanus*. *A*, Nauplius; a, eye. *B*, Larva with a bivalve shell and just before becoming attached (represented feet upwards for comparison with *E* where it is attached). *C*, After becoming attached, side view. *D*, Later stage, viewed from above. *E*, Side view, later stage and with cirri extended. The dots indicate the actual size. (After Spence Bate.)

long been kept distinct from the Crustacea, and, together with various parasitic forms of Copepoda, whose developmental history was not known, classed as Epizoa and Cirripedia.

By later zoologists the Rhizocephala have been placed with the Pœcilopoda, but as this division includes many genera which prove to be merely parasitic forms of Copepoda, it will be more convenient to separate them. All

the animals of this last division, which for convenience we would designate under the general name of Anchoracephala, are attached when adult;—in the Cirripedia by means of cement ducts which deposit calcareous matter, forming in the adult *Balanus* (figs. 59–60) a broad shelly base, and a simple attachment in the pedunculated *Lepadida*; in the Rhizocephala by ramifying nutritive roots, which sink deep into the interior of the body of the animal upon which they become parasitic (see figs. 82 and 83, p. 588). In all the members of this division the young appear as naupliiform larvae<sup>1</sup> which speedily moult their first coat. The body is unsegmented and pyriform, having a median eye,<sup>2</sup> a first pair of minute antennæ, two anterior horns, which inclose the second pair of antennæ,<sup>3</sup> one pair of uniramous and two pairs of biramous natatory legs, a forked terminal projection to the body, and a posterior point to the carapace (see fig. 60 *A*, and fig. 61).

The nauplii of the Anchoracephala are distinguished from the Copepoda by possessing a dorsal shield or carapace, which sometimes, as in *Saccolina purpurea*, projects far beyond the body all round. They are also further distinguished by possessing a pair of so-called "olfactory filaments," which spring directly from the head. These filaments, or horns of the carapace (which are interpreted as the second pair of antennæ by Darwin), are believed by Fritz Müller to be the homologue of the so-called "green gland," which opens at the end of a conical process at the base of the inferior antennæ in the Decapoda, and of the

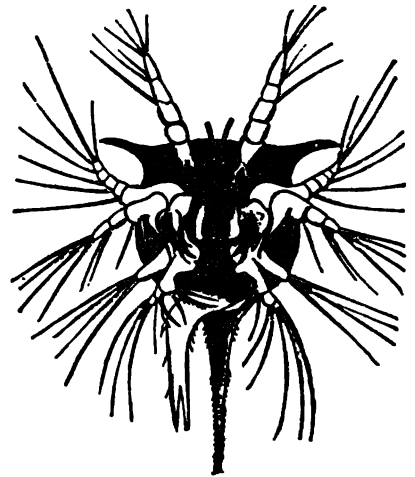

FIG. 61.—Nauplius of *Tetractis porosa* after the first moult. Magn. 90 diam. The brain is seen surrounding the eye, and from it the olfactory filaments issue. Behind it are some delicate muscles passing to the buccal hood. (Fritz Müller.)

conical process, with an efferent duct traversing it, seen as the inferior antennæ of the Amphipoda.

The abdomen of the young Cirripede is produced into a long tail-like furcate extremity, that of the young in Rhizocephala into a movable caudal fork.

The young Cirripedes have a mouth, stomach, etc., and their posterior pairs of limbs are fitted for organs of prehension and manducation. In the young of Rhizocephala all these organs are wanting. The young Cirripede, having to undergo several moults as a nauplius, is provided with organs to sustain its life. The young Rhizocephalon being astomatous, cannot sustain life in its nauplius state for long, and must therefore more rapidly pass through its transformations. They both at length arrive at an equally astomatous pupa-stage. In this stage we see the young animal with its carapace folded together like a bivalved shell; the foremost limbs become transformed into very peculiar adherent feet, and the two following pairs, like the frontal horns, are cast off with the nauplius-skin. Behind these are six pairs of powerful biramous natatory feet, with long setæ and two short setigerous caudal appendages. The young pupæ of the Rhizocephala and Cirripedia agree in every particular, save that the

<sup>1</sup> See Mr. C. Spence Bate's Memoir, *Annals and Mag. Nat. Hist.* 1861. 2d series, vol. viii. p. 224, plates 6, 7, 8.

<sup>2</sup> In *Saccolina purpurea* and in some species of *Lepas* the median eye is wanting.

<sup>3</sup> "Olfactory filaments" (Fritz Müller).

latter possesses a pair of composite eyes; sometimes also traces of the frontal horns seem to persist.

When the proper time arrives the pupæ of the Cirripedia attach themselves by means of their prehensile antennæ to rocks, shells, turtles, cetacea, drift-wood, ships, etc.; the carapace becomes converted into the peculiar sessile-shell of the *Balanus*, or the pedunculated *Lepas*; the natatory feet grow into long cirri by which nourishment is whirled to the mouth, now open and furnished with mandibles and maxilla.



FIG. 62.—Pupa of a Balanidæ (*Cirripedes*). Magn. 60 diam. The adherent feet are retracted within the rather opaque anterior part of the shell. (Fritz Müller.)

The pupæ of Rhizocephala in like manner attach themselves to the abdomen of crabs, *Porcellana*, and hermit-crabs; but they remain astomatous, lose all their limbs completely, and appear as sausage-like, sack-shaped, or discoidal excrescences upon their host, filled with ova (figs. 82 and 83); from the point of attachment closed tubes, ramifying like roots, sink deep into the interior of the host, twisting around the intestine, or are diffused among the sac-like tubes of the liver. The only manifestations of life which persist in this most retrogressively metamorphosed Crustacean are powerful contractions of the roots and alternate expansion and contraction of the body, causing water to flow into the brood-cavity, to be again expelled through a wide orifice (Fritz Müller).

Darwin has recorded various anomalous cases of development in the Cirripedia; amongst others, that of *Cryptophilus minutus* (which forms a separate section *Abdominalia*, Darwin), parasitic in the shell of *Conchospes peruviana*. The egg, at first elliptical, becomes broader anteriorly, then acquires three club-shaped horns, one at each anterior angle and one behind. Subsequently the posterior horn disappears, and the adherent feet may be recognized within the anterior ones. From this "egg-like larva" the pupa is directly produced. Its carapace is but slightly compressed laterally, and is hairy as in *Sacculina purpurea*; the adherent feet are large, the natatory feet wanting, as are also the corresponding cirri in the adult animal. Mr. Spence Bate mentions a similar case in a Rhizocephalon, in which the nauplius-stage is overlapped and the young quits the eggs as a pupa-form larva.

**EXUVIATION IN THE ADULT AND REPARATION OF INJURIES.**—As we have already seen, the young Crustacean, on quitting the egg, usually undergoes a series of larval



FIG. 63.—Pupa of *Sacculina purpurea*. Magn. 180 diam. The filaments on the adherent feet may be the commencements of the future roots. (Fritz Müller.)

metamorphoses more or less numerous, and subject to considerable variation even among closely-allied forms. Eventually, whether by a direct or an indirect route, a form is attained in all, which, save in size, closely agrees with the adult.

Amongst the Insecta the larva usually undergoes repeated moults during its growth, from the time when it first quits the egg until it reaches the pupa-stage, a period of rest in most, but not in all insects,<sup>1</sup> and an astomatous stage in some larval Crustacea.<sup>2</sup> From the pupa springs the full-grown and perfect insect, when no further moult or change takes place—indeed, in some insects the parent only lives to deposit its eggs, and then dies. The immature Crustacean, in passing through its naupliar and zoëal stages, may moult its skin seven or eight times, or even more; nevertheless, when it reaches the *imago*<sup>3</sup> stage, it has not nearly

attained the size of the adult parent, but continues to grow and cast its calcareous envelope as often as its increased size necessitates its so doing. When adult, it still continues to moult probably through its entire lifetime, even to extreme old age.<sup>4</sup>

In casting its shell a crab not only parts with every joint and plate of its limbs and carapace, of its long and slender antennæ, its external eyestalks, the plates of the tail, the appendages of the mouth, the lining of its gills, but even its stomach, with the gastric teeth and the slender apodemata, which give support to the muscles of the limbs and body—so that when the crab has escaped from its old suit, the cast-off shell seems nearly as perfect as the animal itself.

When exuviating the crab and lobster both escape from their old shells by a line of dehiscence which opens between the posterior border of the carapace and its union with the abdomen. Professor Bell also states that in the great crab (*Cancer pagurus*) and some other forms, the carapace divides at the junction of the epimera with the dorsal piece or tergum.

In *Limulus* the carapace splits all round the anterior border, at the union of the dorsal and ventral walls. *Limulus* sheds its shell five to six times during the first year, and probably once annually after that period.

Sir John Dalyell, Mr. Couch, Mr. Gosse, Mr. Spence Bate, Mr. Warrington, and others, have given excellent accounts of the process of moulting of various Crustacea. An accurate observer, Mr. Harper, states<sup>5</sup> that he confined six small specimens of the common shore-crab (*Carcinus menas*) in separate glasses, and fed them daily, until one of them showed that something was amiss by refusing food. Soon after it cast its shell, an occupation which only occupied five minutes. When very young this crab moults frequently. The same author registered the dates, and preserved the exuvie of one which moulted on April 11, 1858, and on May 22, July 3, August 30, and September 26 of the same year; the acceleration of the last moult is attributed to the creature having been fed daily, "like a prize beast," on purpose to try the effect on its growth. Some of these little crabs had lost part of their limbs, but after a moult new limbs appeared of very diminutive size; after a second moult each new limb had increased to one-half as large as the rest, and in the third moult it had reached to its proper bulk and form. Hermit-crabs shed their hard shell before pulling off the exuvie of the tail; their increase at each moult is much less rapid than in the common crab. Prawns exuviate more frequently. Mr. Warrington saw the change occur with much regularity every twelve days in the summer season. With the exception then of certain parasitic forms of Crustacea, which, like the Rhizocephala, have undergone such a complete retrograde metamorphism that no trace of articulations or appendages remain, all the Crustacea periodically exuviate their dermal covering, whether calcareous, chitinous, or membranaceous. In the Cirripedia it would not be possible to exuviate the adherent shell of the adult *Balanus*, or the peduncle of *Lepas* or *Scalpellum*, but, even in this aberrant division, the lining membrane of the shell and the many-jointed cirri are regularly moulted.<sup>6</sup>

rod" all their lives. The larval *Aphis*—the branchiated *Azotid*—are but arrested stages of development of more advanced forms, but they deposit eggs, and in the case of the *Azotid* they possess all the attributes of the perfect animal, save the persistent external larval branchia.

<sup>1</sup> Prof. Bell observes, "there is no doubt that exuviation in many of the higher forms takes place annually with great regularity until the growth is completed, which in many species is not the case before the animal is many years old. This is proved by the extent to which the size increases at each moult, compared with the difference between the young and the old animal; and it is evident that after the growth has reached its maximum, the crust ceases to be changed, from the fact which I have seen in several instances, as in the common crab, the lobster, and some others, where the carapace of the still living creature was the seat of barnacles so large, that several years must probably have been required for attaining their existing size" (*British Stalk-eyed Crustacea*, Introduction, xxxiv.). The young male of *Limulus*, according to Packard, does not attain to the period of puberty before it is four years old. Many Entomostraca infested with bell-animalcules depend on the moulting of their carapace as their only chance of surviving and escaping these prolific parasites.

<sup>2</sup> *Himpees of Ocean Life* (1860).

<sup>3</sup> The frequency with which they exuviate, together with the durability of the cast-off integuments, explains the astonishing masses of exuvie which Mr. C. W. Peach observed annually off the coast of Cornwall, especially in the months of April and May; but he has seen quantities also in September. He could easily have filled several quart-measures with them (Darwin's *Balanidae*, p. 157).

<sup>4</sup> In connection with the exuviation of the Cirripedia Darwin mentions a most remarkable fact (*op. cit.*, p. 15): "In regard to the female

<sup>1</sup> The aquatic pupa of the dragon-fly is active and predaceous.

<sup>2</sup> The pupæ of Rhizocephala and Cirripedia are both astomatous.

<sup>3</sup> *Imago*.—Darwin has applied the term "pupa-stage" to the free-swimming astomatous larva in the Cirripedia previous to its settling down, casting off its pupa-coat, and becoming adult. The writer has long doubted if the Crustacea ever really arrive at this highest or *imago* condition, and whether they are not always in a "pupa-pe-

It has long been known that Crustacea possess the power of voluntarily casting their limbs, and of restoring such as have thus been lost by the animal's will or by accident.<sup>1</sup> If one or more distant phalanges of a limb be torn off, the animal has the power to throw off the remaining part of the limb also. This separation always occurs near the basal extremity of the first phalange. When the limb is thrown off, the blood-vessels and nerve retract, thus leaving a small cavity; from this the germ of the future leg springs, and is at first seen as a nucleated cell. A cicatrix forms over the raw surface caused by the separation, which afterwards forms a sheath for the young leg.<sup>2</sup>

#### PRINCIPAL DIVISIONS OF THE CRUSTACEA.

The subjoined table is intended to give only a general outline of the Crustacean class, with the sub-classes, legions, and orders.

Of the thirteen orders enumerated two only (printed in italics in the table) are extinct, namely, the *Trilobita* and *Eurypterida*. These two lost orders disappeared in the Carboniferous epoch.

#### Table of Classification of the Crustacea.

##### CLASS CRUSTACEA.

##### Sub-Class 1. THORACIPODA (or Malacostraca).

##### Legion I. PODOPTHALMIA.

##### Order 1. DECAPODA.

Sub-Order (a) Brachyura, *Crabs*.

(b) Anomura, *Hermit-crabs*.

(c) Macroura, *Lobster, Prawn*.

" 2. STOMAPODA, *Squilla, Mysis, Diastylida*.

##### Legion II. EMBIOPHTHALMIA.

" 3. ISOPODA, *Oniscus, Idotea, Sphaeroma*.

" 4. TRILOBITA, *Phacops, Asaphus, Calymene, etc.*

" 5. AMPHIPODA, *Talitrus, Gammarus, etc.*

##### Sub-Class 2. GNATHOPODA (or Entomostraca).

##### Legion III. MIBROSTOMATA.

" 6. XIPHOUSA, *Limulus, Bellinurus, etc.*

" 7. EURYPTERIDA, *Eurypterus, Pterygotus*.

##### Legion IV. BRANCHIPODA.

" 8. PHYLLOPODA, *Apsis, Nebalia, Artemia*.

" 9. CLADOCERA, *Daphnia, Lynceus, etc.*

##### Legion V. LOPTHOPODA.

" 10. OSTROCOODA, *Cypris, Candona, Cythere*.

" 11. COPEPODA (a) Liberata: *Cyclops, Cyclophilus, Diaptomus*.

(b) Parasita: *Lernanthropus, Caligae, Nitchoos*.

##### Legion VI. ANCHORACEPHALA.

" 12. RHIZOCEPHALA, *Sacculina, Peltoaster*.

" 13. CIRRIPELIDA, (a) *Balanida, etc.*  
(b) *Lepadida, etc.*

If the old definition between the two great groups, the MALACOSTRACA and the ENTOMOSTRACA, be maintained, namely, that the former shall consist only of forms having more than twenty-one segments, the introduction of the Trilobita among these may be looked upon as inappropriate. If, however, we admit that the Trilobita had (as there seem good grounds for allowing) true special locomotory appendages other than gill-feet or jaws, as in the Malacostraca generally, then we submit that they are appropriately classed. The main characteristic of the Malacostraca seems to be, not so much the possession of twenty-one segments, an inheritance really common to the whole class, but the presence of the seven anterior (cephalic) appendages especially set apart for the senses and nutrition, with separate post-cephalic organs of locomotion;—whereas the peculiarity of the Entomostraca seems to be that the seven anterior (cephalic) organs are not specially set apart as organs of sense and nutrition, but are employed in nearly all the class as the chief locomotory organs, the posterior feet organs, the ovarian tubes and oeca inosculate together; there are no oviducts; the ova, connected together by membrane, and so forming the ovigerous lamellae, becomes exposed by the eversion of the living tunic of the carapace or sack, and by the formation of a new tunic on the underside of these lamellae,—a process unknown in other Crustaceans.<sup>3</sup>

<sup>1</sup> It is a well authenticated fact that the roll of thunder and the discharge of artillery over that part of the sea where lobsters resort will cause them to throw off their great claws. The same effect is also produced by the infliction of any sudden injury. If *Porcellana papyracea* be seized by the claw it immediately casts it off and beats a retreat without it.

<sup>2</sup> H. Goodall, *Ann. and Mag. Nat. Hist.*, vol. xiii, p. 67.

being branchial or ovarian lamellae, or altogether wanting. The writer ventures to propose therefore, instead of the terms Malacostraca<sup>4</sup> and Entomostraca,<sup>5</sup> which convey no idea of any structure or function common to either division to which they are applied, the adoption of the terms Thoraci-poda<sup>6</sup> and Gnathopoda,<sup>6</sup> which embody the salient character in each sub-class.

The Trilobita are probably represented to-day by the Isopoda, to which doubtless they are closely related. There is reason to believe the members of the other extinct order, the *Eurypterida*, to have been the aquatic branchiferous ancestors of the terrestrial tracheated air-breathing *Scorpionida*; nevertheless they need not on that account be removed from their present position in the Crustacean class;<sup>7</sup> and the *Scorpionida* should of course still form a part of the class Arachnida, which may, however, be conveniently placed beside the Crustacea, as in the annexed diagram (fig. 64), in which their probable morphological and ancestral relationship is indicated.

#### TYPES OF EXISTING CRUSTACEA.

##### Sub-class 1. THORACIPODA (or Malacostraca).

I. PODOPTHALMIA: (1.) DECAPODA—(a) BRACHYURA.—Crabs are certainly the highest representatives of the Crustacean class, and in this ten-footed order<sup>8</sup> are included some of the most active and intelligent members of the community,—the "land-crabs," and "shore-crabs," and also the largest living representative of the class, the *Inachus Kempferi* from Japan.

Crabs furnish the best illustration among the Crustacea of that concentration of organs around a single nerve-centre, which Professor Dana aptly terms *cephalisation*.

Instead of a long vermiform body composed of a large number of annuli, each having its own nerve-ganglion, we have in the crab one large cephalo-thoracic ganglion representing nearly the entire nerve force of the body, the supra-oesophageal ganglion only giving rise to the nerves of sense and volition. (See fig. 9, nerves of *Maisia*.)

This highest cephalized type is exemplified by *Maisia*, but as a matter of fact the triangular crabs, of which *Maisia squinado* and *Inachus Kempferi* are examples, do not embrace, by any means, the liveliest and most intelligent of the order; on the contrary, we should decidedly award the highest place for intelligence to the quadrangular land and shore-crabs; indeed, it is amongst such genera as *Grapus*, *Gelasinus*, *Ocypoda*, *Gecarcinus*, etc., that we find the most rapidly moving terrestrial forms of Crustacea. Most of the land-crabs retreat to burrows in the ground during the heat of the day, and issue forth at dusk to feed on the growing crops of sugar-cane, rice, or maize. The *Gecarcinus ruricola* (see ante, fig. 21) is peculiarly destructive to the young sugar-canes in the West Indies. In the highlands of the Deccan land-crabs are most abundant.

<sup>3</sup> From *μαλακός*, soft, and *στρακων*, a shell,—a term not specially appropriate or applicable to crabs and lobsters.

<sup>4</sup> From *ἰστρακων*, an insect, and *στρακων*, a shell,—a name quite applicable to the Ostracoda, but not to all the sub-class.

<sup>5</sup> From *θώραξ*, the thorax (or middle body), and *ποδός*, *πόδιον*, a foot, in allusion to the prevalent use in the Malacostraca of the thoracic series of appendages as special organs of locomotion.

<sup>6</sup> From *γνάθος*, the jaw, the mouth, and *ποδός*, *πόδιον*, a foot, in allusion to the prevailing character in the Entomostraca, in which the head and mouth-organs are also mainly used in locomotion. We should of course have preferred to use the term *Cephalopoda* for this sub-class, had not that designation been already appropriated for the cuttle-fishes, etc.

<sup>7</sup> In a paper on the structure of the Xiphosura and their relationship with the Eurypterida (*Quart. Journ. Geol. Soc.*, 1866, vol. xliii, p. 35), the writer first suggested the probable genealogico-morphological relationship between *Pterygotus* and *Scorpio*; and in a subsequent communication (*op. cit.* 1871, p. 46) he combated the proposal of Dr. Anton Dohrn to remove the Trilobita, Eurypterida, and Xiphosura from the Crustacea, and to combine them with *Scorpio* as a new class beside the Crustacea; he also pointed out wherein the evidence relied upon by Dohrn for establishing such an order fails. The classification of the *Eurypterida* and *Xiphosura* proposed in his monograph (*Pal. Soc. Mon. Serenitatis*, Pt. I., iv., 1866-72) has been adopted by Professor Owen and Huxley both, and has received the sanction of many eminent carcinologists. The writer has given his views as to the close affinity between the extinct Trilobita and the modern Isopoda in *Brit. Assoc. Reports*, *Edinb.* 1871, and *Geol. Mag.*, 1871, vol. viii, p. 289, pl. 8.

<sup>8</sup> The crabs belong to the legion Podophtalmia, all the members of which are distinguished by having their compound eyes placed on movable eye-stalks (hence called "stalk-eyed Crustacea"). They also have the gills covered by the carapace, forming, in fact, a more or less completely enclosed branchial chamber. Only one other Crustacean, viz., *Tanais* (fig. 38), an Isopod, has such an arrangement—in *Tanais* also the eyes are pedunculated. In *Nebalia* (2 in fig. 57), a Phyllopod, the eye is pedunculated, but in these instances the peduncle is not articulated. In the Trilobita several species occur with compound pedunculated eyes, but the eye-stalk has no articulation.

*Gecarcini* are found at Mahabeshwar at an elevation of 4500 feet above the sea. These land-crabs probably do not visit the sea at all, as do the Jamaica land-crabs, but deposit their eggs, when near the time of hatching, in the freshwater streams, the banks of which they are known to frequent. Many of the land-crabs have the chelate limbs largely developed, usually more strongly so in the males, e.g., the male of *Macrophthalmus Latreillii*; in others, one claw only is very disproportionately enlarged, as in the males of the "calling-crab" (*Gelasimus*), which are said in running to carry this claw elevated as if beckoning with it. Frits Müller says, however, that the species common in

Brazil (a small *Gelasimus* with one claw very large) always holds it closely pressed against its body. Vast numbers of land-crabs are met with on the sea-shore and among rocks along the coast, especially in the warmer temperate and sub-tropical regions of the earth. Of the genus *Thelphusa* one freshwater species (*T. Fluvialis*) is a native of the rivers of southern Europe. It is eaten by Catholics during Lent, and hence called "Lenten crab." This crab is also common to the rivers of India.

Although some land-crabs are certainly vegetarians in diet, the class, as a whole, are carrion feeders, greedily devouring animal matter even in a putrescent state. The

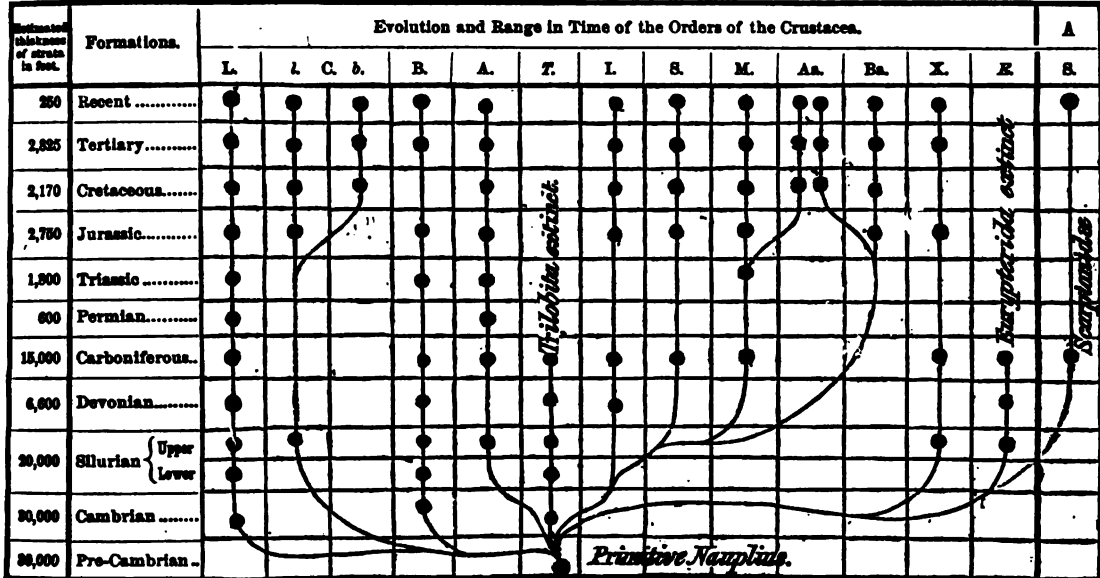

FIG. 64.—Diagram showing the probable evolution and actual range in time of the several orders of Crustacea.

**Explanation.**—The letters at the top of each column represent the several orders and sub-orders of Crustacea,—one family of the Arachnida, the *Scorpionida*, being placed beside the Euryptera to show its range in time and probable derivation from the Crustacea. The vertical lines show the actual range in time, the black dots denote the strata in which remains of each order have been met with. The curved lines, uniting order to order, are intended to show the probable evolution of the class from a common great ancestor; but numerous *s* are the indications of affinities afforded by the Crustacea, the group is too ancient to be certainly traced back in time to a common parent; even the lowest Cambrian rocks have yielded evidence of two orders, namely, the Trilobita and Ostracoda, whilst the Middle Cambrian furnishes a Phyllopod Crustacean (*Hymenocaris*). As the branches of this genealogical tree of the Crustacea are not arranged in a circular manner, they cannot of course be made to show the affinities which each order presents to every other order or branch, my more than does the dried plant show the natural verticillate arrangement of its leaves and branches when pressed out flat upon the page of a *Horvitz Stocus*.

**L**—the LOPHYROPODA. Of this legion, the order Ostracoda is well represented throughout the entire series, from the Cambrian to the Tertiary and also in the seas and fresh-waters of to-day.

**C**—the CIRRIPELIA.—I—the Lepidids, or pedunculated Cirripedes, appear first in the Wenlock Limestone (U. Silurian); represented by a single form (*Terrilepas Wrightianus*, H. Woodw.). Numerous brms occur in the Secondary and Tertiary strata, and they are abundantly distributed throughout the warmer seas of the world. —the Balanidia, or sessile Cirripedes, are represented by a single urn, the *Pyrgoma cretacea*, H. Woodw., in the Chalk, abundantly in the Tertiary rocks, and in recent deposits, and are distributed in the sea all over the world at the present day.

**B**—the BRACHIOPODA.—Of this division the order Phyllopod appears in the Cambrian rocks, and is well represented in Silurian and Carboniferous strata; they are also met with in the Secondary and Tertiary formations, and living in fresh, brackish, and marine waters, widely distributed over the globe.

**A**—the AMPHIPODA.—This order has a single representative in the Upper Silurian, *Neorogommarus Salweeni*, H. Woodw.; it is represented by *Gamponyx?* in the Coal, by *Proceponicus* in the Permian, and by several forms in the Secondary and Tertiary formations, and abundantly in recent freshwater and marine localities.

**T**—the TRILOBITA. This extinct order appears in the Cambrian, attains its maximum development in the Silurian, and terminates in the Carboniferous period.

**I**—the ISOPODA.—This order is represented in the Devonian by a single species, *Proasoturus gigas*, H. Woodw., and by remains in the Carboniferous strata. Many species occur in the Secondary and Tertiary strata. It is largely represented to-day by land, freshwater, and marine types.

**S**—STOMAPODA.—*Pygoccephalus Huxleyi*, H. Woodw., from the Coal-measures, probably belongs to this division. True *Squilla* and *Mytilus*-like Crustacea occur in the Jurassic rocks (Secondary). Forms of this order are abundant in our modern seas.

**M**—the MACROURAN division of DECAPODA. A single species, *Anthropalmon Grossardi*, Salter, appears in the Coal-measures. This order is well represented from the Trias to the present day, and is now one of the prevalent types, occurring both in fresh and salt water.

**Aa**—the ANOMOURA, or irregular-tailed DECAPODA. This sub-order embraces forms related both to the Crabs (e.g., *Dromia*, *Porcellana*, *Dorippe*) and to the Lobsters (e.g., *Pagurus*, *Galathea*, *Munida*). Their earliest appearance is in the Cretaceous period; there are numerous living forms, both terrestrial and marine.

**Ba**—the BRACHYURA.—The oldest known crab is the *Palatnacrus longipes*, H. Woodw., from the Gt. Oolite. Crabs are well represented from the Upper Secondary to the present day, when they attain their maximum within the warmer latitudes, being represented by land, freshwater, and marine forms.

**X**—the XIPHOURA, or king-crabs. These are remarkable for their longevity; they appear first in the Upper Silurian (*Neohemulus falcatus*, H. Woodw.); again in the Coal-measures, next in the Oolite and Tertiaries, and living to-day in the Old and New Worlds.

**E**—EURYPTERIDA. This extinct order contains some of the largest known members of the Crustacean class (e.g., *Eurypterus angulosus*, Devonian). It ranges from the Upper Silurian to the Coal-measures. On morphological grounds there is good reason to conclude that the Euryptera are the ancestors of the Scorpionida, to which they present the strongest affinity.

**A**—ARACHNIDA. **S**—SCORPIONIDA.—The scorpions range from the Coal-measures, apparently unaltered, to the present day.

*Portunidae* and *Carcinidae* perform the duties of sanitary police around our coasts between tide-marks, being assisted by swarms of "sand-hoppers" (*Talitrus locusta*); whilst below low-water mark the prawns, *Maia*s, great crabs, and lobsters share the task. Many sea-side resorts would be extremely unwholesome were it not for the labors of these useful but unpaid scavengers.

The swimming-crabs are mostly predaceous; forms like *Portunus pelagicus* and *Polydora Henslowii* (fig. 66) have

exceedingly thin shells, and all the feet, save the great chelate claws, are modified into oars. They are thus enabled to live and hunt at their ease, often hundreds of miles from land. The writer has seen Henslow's swimming-crab in the middle of the Bay of Biscay far out of sight of land. Crouch, the Cornish naturalist, states that they fasten upon pilchards and mackerel with their knife-like claws, and never relax their hold until the terrified victim floats exhausted on the surface.

Two genera of Tertiary Land-crabs have been described from English localities (*Goniocephala*<sup>1</sup> and *Litoricola*<sup>2</sup>). *Macrophthalmus* occurs fossil in China, where it is prized as a valuable *marines medica*.<sup>3</sup> *Ranina*, "the frog-crab" of the Indian Ocean and Japan, occurs in tertiary rocks<sup>4</sup> in Bunde and Ebenda, Germany, in San Stefano, Italy, and in Malta. Rumphius says, "It loves to climb upon the roofs of houses."<sup>5</sup>

More than fifty genera of fossil Crustacea, referable to the Decapoda-Brachyura, have been described by Milne-Edwards, Bell, Reuss, McCoy, H. Woodward, and others. The oldest known crab is the *Pakeinachus longipes*, H.

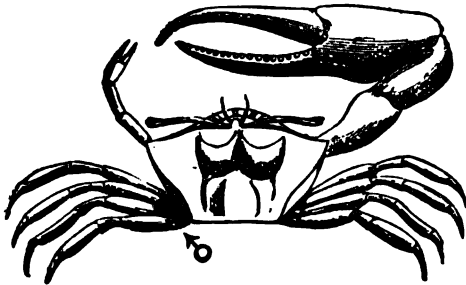

FIG. 65.—The "Calling-Crab" (*Gelasimus*), ♂ a land-crab common in the cassava-fields, Brazil.

Woodw., from the forest marble, Wilts (*Quart. Journ. Geol. Soc.*, 1866, vol. xxii. Pl. xxiv. p. 493).

I. PODOPTHALMIA: (1.) DECAPODA—(b.) ANOMOURA.—The irregular-tailed or Anomourous Crustaceans, of which the hermit-crab is a type (figs. 20 and 67), are excellent examples both of arrested development and retrograde metamorphosis in the adult, resulting from disuse and consequent atrophy of particular parts or organs.

We have seen among the Isopoda the females of the *Bopyridae*, which live parasitic within the branchial chamber of other Crustaceans, or under their abdomen, or within the parietes of a *Balanus*, or actually within the body of a *Porcellana*. In the Rhizocephala we have seen the free-swimming pupa become attached to the soft body of the *Pagurus*,



FIG. 66.—Henslow's Swimming-crab, *Polydora Henslowii*, Leach, coast of Cornwall.

cast off its shell, lose all its limbs, and appear as a sausage-like, sack-shaped, or discoidal excrescence, without even a mouth, its body, filled with ova, attached by its antennae, which are modified into roots, that anchor it and at the same time bring it ready prepared nourishment from the juices of its hosts (see figs. 82 and 83). After such ex-

<sup>1</sup> *Goniocephala Edwardsii*, H. Woodw., L. Eocene, High Cliff, Hampshire *Geol. Mag.*, 1867, vol. iv. pl. 21, fig. 1, p. 529.

<sup>2</sup> *Litoricola glabra*, H. Woodw., and *L. dentata*, H. Woodw., L. Eocene, Portsmouth, *Quart. Journ. Geol. Soc.*, vol. xlix. pl. 2, p. 29.

<sup>3</sup> *Notes on Chinese Materia Medica* by D. Hanbury, F. L. S., *Pharm. Journ.* 1862, p. 48.

<sup>4</sup> See Woodward and Salter's Chart of the Fossil Crustacea, engraved by J. W. Lowry; Stanford, Charing Cross, 1865.

<sup>5</sup> (Fritz Muller, *Flur Darwin*, p. 80.) This statement of the old Dutch naturalist seems most extraordinary, and needs further investigation. All the feet in *Ranina* seem adapted for digging, and an allied but much smaller form (*Raninoides*) from Trinidad, a truly marine species, is a most expert burrower into sand or mud, going down tall foremost. According to Milne-Edwards, in *Ranina* the ordinary entrant orifice to the branchial cavity is altogether wanting, and the entrance is by a canal which opens beneath the abdomen. Such an arrangement seems rather to favor the notion of its fossorial habits.

treme retrogression, the depauperization of certain parts and organs observable in the Anomoura is easily to be understood and admitted.

If we bring together for study a series of Anomourous Crustacea, we shall be at once able superficially to divide them into two sections, the *Macrourous* and the *Brachyours Anomoura*.

- |                                 |                             |
|---------------------------------|-----------------------------|
| (A.) Irregular BRACHYURA.       | (B.) Irregular MACROURA.    |
| 1. <i>Lithodes</i> .            | 1. <i>Galathea</i> .        |
| 2. <i>Porcellana</i> (fig. 68). | 2. <i>Munida</i> .          |
| 3. <i>Dromia</i> .              | 3. <i>Paguri</i> (fig. 67). |
| 4. <i>Dorippe</i> .             | 4. <i>Birgus</i> .          |
| 5. <i>Homola</i> .              |                             |

We have also burrowing forms which obviously are near to these, although not actually classed with them, viz.,

- |                      |                        |
|----------------------|------------------------|
| 1. <i>Ranina</i> .   | 1. <i>Callinassa</i> . |
| 2. <i>Corystes</i> . | 2. <i>Gobia</i> .      |
|                      | 3. <i>Azius</i> .      |

In both these sections of the Anomoura we find the same peculiarity, namely, that the fifth pair of (thoracic) legs,

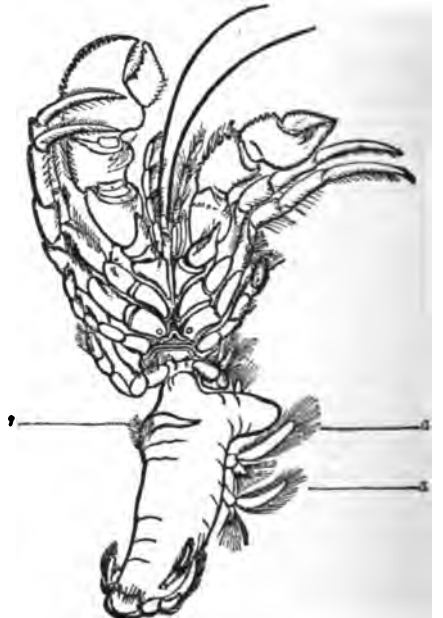

FIG. 67.—Hermit-Crab removed from its shell (see ante, fig. 20) r, hardened ridge, which bears against the columella of small-shell; a, a, the appendages to which the eggs are attached. (More.)

and sometimes indeed the fourth and fifth hinder pair, are not formed for walking, but are minute and rudimentary, and are placed above the level of the other legs.

In *Porcellana* and *Lithodes*, in *Galathea* and *Munida*, the posterior legs are simply rudimentary. In *Dorippe* and *Dromia*, in *Pagurus* and *Birgus*, though still disproportionately small, they are modified into organs for holding on with. This rudimentary condition of the posterior thoracic feet in the Anomoura at once recalls the last larval stages of nearly all the Malacostraca,<sup>6</sup> in which the hinder thoracic somites are not yet developed, or if so, are either destitute of appendages, or have only rudimentary ones. The chelate form of the two posterior pairs of feet in *Dromia* and *Dorippe*, in *Hemula*

<sup>6</sup> In *Palaeomon* and *Pananus* (Macrourea), in *Dulichia*, *Cheratia*, *Lipis* and *Aesillus* (Isopoda), in *Leostripopsis* (Amphipoda), and even in the Brachyura where the young apparently undergo little transformation when compared with the less cephalized forms, the thoracic somites are developed last, and then from before backwards. (See Spence Bate on the Development of Decapod Crustacea, 1857, *Phil. Trans.* 1858, p. 595.)



FIG. 68.—*Porcellana platycheles*, Penn. sp. British. Habitat under stones at low water.



and *Birgus*, being a variable characteristic, and not present in all Anomoura, is doubtless developed as an individual specific modification, like the chelate penultimate feet in *Brachyocetus* and the ante-penultimate pair in *Phronima*.<sup>1</sup>

Some Anomoura have chelate terminations to a pair of their rudimentary feet, others have both pairs simple.<sup>2</sup> This is at once elucidated when we inquire into their economy. *Dromia* does not carry about a turbinated shell like *Pagurus*, but clothes itself with the skin of its victim, a "sea-lemon" (*Doris*) for example, or encourages a parasitic sponge of showy color to grow upon its back, holding it in its place with its two hind pairs of rudimentary feet, just as the other true hermits hold their shells on over their soft-skinned bodies (Gosse),

Professor Verrill has described a *Dorippe* (*D. facchino*), which always carries an *Actinia* (the *Cancerisocia expansa*, St.) upon its back. Like most other cases of commensalism this friendly association of the crab and sea-anemone was begun long ago and has been regularly adhered to. When young the *Dorippe* carries a small shell (? the half of a bivalve), which it holds in position by means of its two hind pairs of legs. The *Actinia* fixes itself when young to the shell, and afterwards by its growth completely conceals the carapace of the crab, replacing the shell which is, no doubt, after a time either disintegrated or abandoned when the *Dorippe* moults. A *Sagarita*, associated with a hermit-crab on our own coasts, is said entirely to dissolve away the *Buccinum* in which the *Pagurus* is lodged, and to supply its place, as in the case of *Dorippe*, with its expanded foot.

Several specimens of a small species of *Pagurus*, common on the French coast, have been brought to the writer, each crab tenanted in what appeared to be the shell of a small *Buccinum* or *Nassa*; but the whole was so completely encrusted by a sponge as to leave no part visible externally. On cutting one open vertically the spiral form of the interior cavity of the shell was very distinctly seen, but the shell itself had been entirely dissolved away by the sponge.<sup>3</sup>

A *Zoanthus* has been described by Dabén and Koren under the name of *Mammalifera incrustedata*, which is commonly found parasitic on shells that are tenanted by a species of *Pagurus*. In all cases the shell is destroyed after a while, not by the hermit-crab, but by some process of disintegration or absorption, the diffused basal crust of the Zoophyte forming a perfect cast of it, and affording shelter to the crab. This form occurs in Shetland and in the North of England, as well as in Norway, and is regarded by Mr. Hincks as distinct from *Zoanthus Couchii*. Gosse (Rev. T. Hincks, *Ann. and Mag. Nat. Hist.*, 1862, p. 304).

The *Adamsia palliata* always selects shells tenanted by *Pagurus Prideauxii*, but instead of adhering to the spire the "cloak-anemone" fixes itself to the smooth inner lip of the shell, so that when the hermit is feeding, the mouth of the anemone is just below that of the crab, and ready to receive any fragment he may let fall. When the *Adamsia* is very young, less than half-an-inch in diameter, its outline is circular; but as it grows older it expands laterally, forming two lobes, which creep along the mouth of the shell, until they meet and coalesce on its outer lip. The base of the cloak-anemone is then perforated, and through this opening the hermit puts out or retracts his head and legs.<sup>4</sup>

In all the Anomoura the abdomen is more or less modified; for instance, in the Brachyurous type, it is not closely bent under the body, as in ordinary crabs, some *Porcellana* (fig. 68) carrying it extended straight out; whilst in the long-tailed forms, like *Galathea*, the epimera are shorter, and the segments are less arched than in the lobeter. The caudal plates are also more rudimentary. In *Pagurus* (fig. 67), the abdomen is naked, only a mere trace of the shelly plates remaining. In *Birgus latro* the sternal portion only of the abdominal somites remains.

If we turn for an instant to the *Thalassinida*, a family of burrowing Macrourea, we find the hard and shelly epimeral

pieces of the body-segments are not properly developed, and the lobes of the tail are in like manner rudimentary; the integument of the body is extremely thin and soft (approaching that of the hermit-crabs, which like themselves live concealed in various foreign substances living and dead, e. g., shells, sponges, *Actinia*, etc.).<sup>5</sup>

There can be no doubt that both in the case of the true hermit-crabs, and in that of the burrowing Crustacea, the



FIG. 69.—*Callianassa subterranea*, Leach, a burrowing Crustacean; coast of Devon (other species are found fossil in the Chalk, Greensand, London Clay, etc.).

non-development of the hard calcareous covering to the abdomen (in *Callianassa* extending to the whole body except the legs and chelæ) is due to the same cause, viz., disuse of the abdomen and caudal fin for natation, and to their constant habit of living in concealment.

In the case of *Birgus latro*, when quite young it probably conceals itself in some shell, but as it grows to such a large size and becomes so enormously fat, from feeding upon the cocoa-nut, it must abandon its early disguise and conceal itself within a burrow instead. The writer has received a small hermit-crab very like *Birgus*, the abdomen of which was concealed in a sponge.

If then the Anomoura be the descendants of certain Crustacea in which an arrested stage of development in the young has become a persistent character in the adult, or in which organs atrophied by disuse have at last come to be suppressed or greatly modified, the conclusion seems obvious that we are dealing not with a distinct sub-order equivalent to the Brachyura or the Macrourea, but with a group composed of various irregular forms at present placed inter-

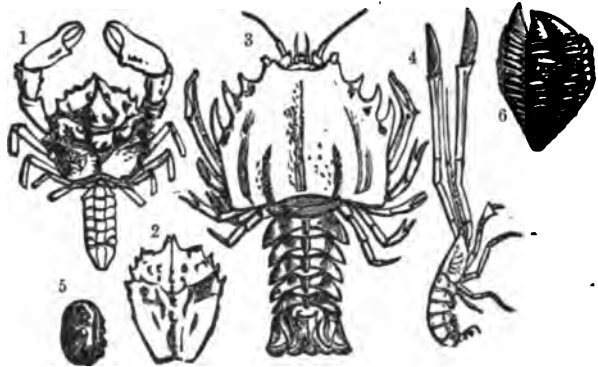

FIG. 70.—1. *Dromites Lamarckii*, Desm.; London Clay, Sheppey. 2. *Palaeocorystes Stobessi*, Gault; Folkestone. 3. *Eryon arciformis*, Schl.; Lithographic stone, Solenhofen. 4. *Mecocochetus longimanus*, Schl.; Lithographic stone, Solenhofen. 5. *Cypridea tuberculata*, Sby.; Weald, Sussex. 6. *Loricula pulchella*, Sby.; L. Chalk, Sussex.

mediate to, but originally belonging to both these divisions.

Forms allied to *Homola* and *Dromia*—*Homolopsis* and *Dromiites*—occur fossil, the former in the Gault and the latter in the London Clay (in fig. 70); no other Anomourous forms have been met with, save some legs and chelæ in the Chalk, which have been attributed to a *Pagurus*.

Remains of *Callianassa* are very abundant in the Cretaceous and Tertiary rocks of Europe, and have been found

<sup>5</sup> We may compare the differences of their tests to that which exists between a lady's white and delicate hand, encased from infancy in a kid glove, and the hand of a primitive savage who uses his digits constantly for delving in the ground for roots. In the one the covering membrane is thin and soft, in the other hard and horny. One might even go further and imagine that, by continued disuse, the nails would be no longer developed; certainly they have in civilized life become less powerful as offensive weapons, and the toe nails on the feet have really in most persons commenced to become atrophied.

<sup>6</sup> From Professor Owen's *Paleontology*, p. 50, fig. 10.

<sup>1</sup> In *Cenobita Diogenes*, one of the land-hermits, the penultimate pair of feet are furnished with curious rasp-like surfaces to their extremities, to enable it to hold on to the smooth inner surface of the spiral shell it has chosen for a habitation.

<sup>2</sup> In the *Hyportia* the youngest larvae cannot swim; they are helpless little animals which cling firmly by their chelate feet to the swimming laminae of the *Molusca* in the gill-cavity of which they live when adult; the adults lose the prehensile character of the feet and acquire the power of swimming.

<sup>3</sup> They are found tenanted shells covered by *Collepora edax* and by *Hypocynthia*. The hermit-crabs are known to break out the spiral columella of the shell they inhabit to give themselves more room.

<sup>4</sup> Gosse, *Glimpses of Ocean Life*; see also Professor Verrill's article, *American Naturalist*, vol. III.

fossil even as far off as Japan. It is always the hands which are preserved, the body being usually too delicate for fossilization.

I. **PODOPHTHALMIA**: (1.) **DECAPODA**—(c.) **MACROURA**.—The common lobster and prawn are excellent examples of the Macroura. In this truly aquatic type the abdomen is no longer rudimentary, as in the crabs, but is developed into a powerful organ for leaping and swimming. The body segments are of nearly equal growth, and being compressed at the sides, or cylindrical in form, they present a well-marked contrast to the crabs, or Brachyura, in which the segments are expanded laterally. The abdomen is terminated by a broad swimming tail. The Macroura are numerically very abundant in both marine and fresh water.

The lobster prefers a rocky coast, and being somewhat of a *gourmand* in his tastes is tempted by the fishermen on our shores to such good purpose, that as many as 25,000 live lobsters are often delivered at Billingsgate in a day. If only as many are eaten in the whole of England as in London, this would be at the rate of 50,000 per day, or 18,250,000 annually. March to August is the period of greatest catch.<sup>1</sup>

The river cray-fish, *Astacus fluviatilis* (fig. 25), also common to the rivers of Europe, is largely caught, and when fresh boiled is not to be despised. It is largely imported into London, and is used by the *chefs* at the West End to garnish dishes. The writer with a friend caught as many as 900 cray-fish in a single evening from 8 till 12 (with a series of simple scale-like nets baited with liver), along the bank of the Thames and Severn Canal, Gloucestershire. The Murray river cray-fish from Australia (*Potamobius serratus*) is as large as a fine sea-lobster, and has its segments ornamented with spines, reminding one of the spiny lobster<sup>2</sup> (*Enoplocyris sussexiensis*) from the chalk of Sussex and Kent.<sup>3</sup>

More than fifty genera of fossil Macroura have been met with and described; the earliest known is the *Anthropalæmon Grossartii* from the Lower Carboniferous series near Glasgow. Similar forms have been obtained from the Coal-measures in England; from Illinois, U.S.; from Bohemia, etc.

I. **PODOPHTHALMIA**: (2.) **STOMAPODA**.—All the members embraced within the three divisions of the preceding order (Decapoda) were cryptobranchiate, in this order they are nudibranchiate, i. e., the gills are composed of plates or simple filaments attached to the feet, whilst the carapace, so largely developed in the order Decapoda, is here both shorter and narrower, and the body less compact. Taking *Squilla* (fig. 71) as an example, the segments are much less coalesced than in the lobster. Those bearing the eyes and the antennules are readily separable from the front of the head, and are not covered by the carapace, which only conceals eight segments, whereas in the lobster it covers fourteen, and in the crab twenty-one. The gills are borne by

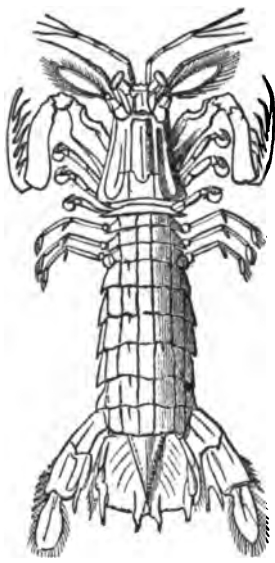

FIG. 71.—*Squilla mantis*, Rondel.; south coast of England and Mediterranean.

<sup>1</sup> Lobsters are sent alive to the London market, packed in damp sea-weed, moss, or heather, from Stornoway in the Island of Lewis, from Ireland, Scotland, the Orkneys, the south coast, and Channel Islands, and from Norway. Fishermen and salesmen are said to know the south coast, Cornish, Scotch, Irish, or Norwegian lobsters at sight, just as cattle salesmen know a "Hereford" or "Devon," a "Scotch" or "Irish" beast. The largest common lobsters weigh from 8 to 12 lb. But the great lobster of the American coast (largely imported in tins into Europe) weighs more than twice as much.

<sup>2</sup> Dixon's *Geology of Sussex*, tab. 38, figs. 6, 7.

<sup>3</sup> For the numerous species of *Palaemonidae* belonging to this division, we must refer the reader to Bell's *British Stalk-eyed Crustacea*, to Dana's magnificent volumes and atlas on the Crustacea found during the United States exploring expedition, and to De Haan's *Fauna Japonica* and Milne-Edwards's *Hist. Nat. des Crustacés*.

the abdominal swimming feet, free and uncovered. The first pair of thoracic limbs are developed into a pair of large and formidable claws, the terminal joint of which bears a row of long, sharp, and recurved teeth; these double back upon the edge of the penultimate joint which has a groove to receive them, like a pocket-comb.

In *Mysis*, "the opossum shrimp," another member of this order, the two posterior pairs of feet only are branchiferous; all the feet are biramous and flagellate; in the female the hinder feet are modified into broad plates which, uniting beneath the body, form a pouch or *marsupium* in which the eggs are protected and the young pass through their infancy.<sup>4</sup>

These opossum-shrimps, which are pelagic in their habits, are frequently met with in countless myriads towards the surface of the Greenland Sea, and, though small, they form the chief part of the food of the common whale (*Balaena mysticetus*).<sup>5</sup>

Some forms of *Erichthys* are included in this division; these, like *Mysis*, are also pelagic, and occur abundantly on the surface of the Indian and Atlantic Oceans, where, together with the larvæ of Cirripedes and many other oceanic cosmopolites, they may be taken with the towing net in abundance.

Numerous specimens of true *Squilla* (*Squilla pennata*, Münster) and of a *Mysis*-like Crustacean have been found fossil in the Solenhofen limestone, of Oolitic age, in Bavaria. With the Stomapoda are also placed a group of very anomalous and larval-looking Crustacea (the *Diastylidae*) originally noticed in 1843 by Mr. Harry Goodair, who obtained them from the Firth of Forth. They closely resemble Copepoda in aspect, and might readily be confounded with the larval stages of some Decapod. They have, however, been found with their eggs borne by the female in an incubatory pouch beneath the thorax, as in *Mysis*.

The branchiæ are situated on each side of the thorax immediately above the insertion of the legs, and approach in their comb-like appearance to those of the higher Crustacea.

Three genera have been established for these singular forms, namely, *Cuma*, *Alauna*, *Bodotria* (see fig. 36).

II. **EDRIOPHTHALMIA**: (3.) **ISOPODA**.—From the stalk-eyed Podophthalmia we pass now to the sessile-eyed Edriophthalmia, in which the eyes with one exception are fixed immovably on the surface of the head. As in the higher forms, the eyes are compound, consisting in the young of some ten or twelve lenses only, but in the adult of as many as sixty to eighty. In nearly all, the body is distinctly divisible into three parts—the head usually very small, the seven thoracic segments well and evenly developed, the abdominal somites more or less coalesced. The general conformity in size and function of the thoracic somites and their seven pairs of legs characterizes the majority of the Isopoda. These legs are nearly uniform, and are fitted either for walking or for swimming, or as powerful hook-like organs to enable them to adhere to the fishes on which they are parasitic. The branchiæ in this order are transferred from the thoracic legs to the abdominal appendages, which are converted into special organs of respiration.

One group of Isopoda, the *Oniscidea* (forming Spence Bate's and Westwood's family *Aerospirantia*), familiar in our gardens under the names of "woodlouse," "sow-bug," and "armadillo" (fig. 22), are all air-breathers, incapable of existing in water, but breathing air which, however, it is necessary must be saturated with moisture. Several of the species which inhabit caves are destitute of eyes (e.g., *Titanethes albus*, Schrodte). The "great sea-slug" (*Ligia oceanica*) is common on all our coasts, running with agility and feigning death when attacked. The genus *Armadillo*, found commonly in our gardens and woods, and so called from the perfect way in which the segments roll together, forcibly reminds one of "the great Barr Trilobite" (*Ilanus Barriensis*), from the Silurian of Staffordshire (7 in fig. 73).

A very interesting little Isopod (presented to the British Museum by Dr. Milligan of Tasmania), from Flinders Island, Bass's Straits, and named in MS. by Mr. Adam White *Ceratocephalus Grayanus*, offers many points of analogy with the extinct Trilobites. The fragile

<sup>4</sup> An allied species to *Mysis*, *Thysanopoda* (obtained in myriads by Couch on the Cornish coast from the stomachs of mackerel), carries its eggs, as does *Cyclops quadricornis*, in two bag-like ovaries depending from the posterior thoracic somite (Bell's *Brit. Stalk-eyed Crust.*).

<sup>5</sup> Otho Fabricius, *Fauna Groenlandica*, p. 248.

mode of articulation of its walking legs, and their entire concealment beneath the body-segments, are very suggestive. This Isopod is near to the *Sphaeromida*, but will form a distinct family, as the antennae are inserted beneath and within the margin of the head-shield; apparently it does not roll itself into a ball.

The *Sphaeromida* are very littoral in their habits; they range from the equatorial latitudes to the colder temperate zones, but are not found in Polar regions. They are vegetable feeders, and some (like *Limnoria*) are guilty of destroying timber. When molested or alarmed they roll themselves up into a ball. The *Sphaeromida* present many points of analogy, if not of affinity, with the extinct Trilobites.

In this order we find the *Limnoria terebrans* (or the "gribble," as it is called by the fishermen). It is one of the most destructive creatures, attacking all wood-work below tidemarks; the only wood which it cannot destroy is teak. Although its ravages had gone on for ages, it was only made known to the scientific world and described by Dr. Leach in 1811.

In the aberrant genus *Tanis* (fig. 38) the first pair of thoracic legs are converted into chela, and the head-shield is covered by a carapace, abundantly traversed by currents of blood, beneath which a stream of water passes, maintained as in the zoëæ and adult Decapoda by a flabelliform appendage of the second pair of maxillæ, which is wanting in all other Edriophthalmia. The abdominal feet, which in other Isopoda act as respiratory organs, are simple natatory feet in *Tanis*. These characters, together with the pedunculated eyes and the great chelate hands, give to *Tanis* a very decapod-like aspect (see fig. 38).

The *Idoteida* contain representatives of some of the largest known Isopoda, some of which are above 4 inches in length.

The *Ægida*<sup>1</sup> and *Cymothoida* have all the feet furnished with a robust finger, sharp at the tip, for seizing and holding on to fishes upon which they are parasitic. Another family, the *Bopyrida* (fig. 39) are parasitic chiefly on mem-

Isopoda are met with as far back as the Old Red Sandstone, where remains of a gigantic species allied to *Aroturus* have been discovered; others occur in the Carboniferous and Oolitic periods. The Purbeck beds of Swanage, Dorset, also yield abundance of a fresh-water form, the *Archaoniscus Brodiei*; species of *Oniscus* and *Sphaeroma* are

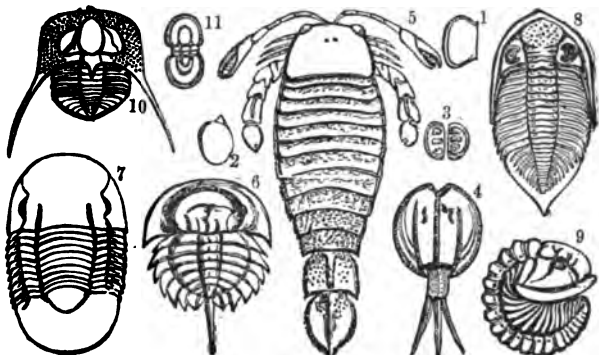

FIG. 78.—1, *Loperditia Baltica*, Wahl; U. Silurian, Gothland. 2, *Entomoconchus Scofieldi*, M. C.; Carbonif. L. Ireland. 3, *Eurythia complanata*, Salter; Lr. Silurian, Wales. 4, *Dithyrocaris Scofieldi*, McCoy; Carbonif. L. Ireland. 5, *Pterygotus antiquus*, Ag.; Old Red, Forfarshire. 6, *Frestotichia rotundata*, H. Woodw.; Carbonif. Coalbrookdale. 7, *Illanus Davisi*, Salter; L. Silurian, Bala. 8, *Phacops caudatus*, Brunn.; U. Silurian, Dudley. 9, *Calymene Blumenbachii*, Br.; U. Silurian, Dudley. 10, *Trinucleus ornatus*, Sternb.; L. Silurian, Britain. 11, *Agnostus trinodus*, Salter; Lr. Silurian, Britain.

found fossil in the Cretaceous, the Eocene, and the Miocene of Europe.

II. EDRIOPHTHALMIA: (4) TRILOBITA.—So long ago as 1821 Audouin placed the Trilobites with the Isopoda, whilst Macleay assigned them a distinct order between the Isopoda and the Phyllopora. Later researches by Milne-Edwards and others have caused the Trilobita to be referred to the Entomostraca, on account of the very variable number of body-rings observed in the several genera (from six to twenty-six), evidencing a much lower type of structure than the Isopoda, in which the thorax is composed of seven free and movable segments with a head-shield and anchylosed caudal somites. Moreover, until the discovery of presumed ambulatory appendages in an *Asaphus* from the Trenton Limestone in 1870,<sup>3</sup> the only appendage previously observed was the hypostome or lip-plate. There seems, however, no good reason to urge against the conclusion that the Trilobita were an earlier and more generalized type of Crustacea, from which the later and more specialized Isopoda have arisen,—a view which the writer is glad to say he shares with the distinguished carcinologists, Professor Dana<sup>4</sup> in America, and Mr. C. Spence Bate in England, although at present more evidence is needed as to the nature of the locomotory appendages in this extinct group. If we range the characters of Trilobita and Isopoda side by side, we shall find there are sufficiently good grounds for placing them in the Edriophthalmia together.<sup>5</sup>

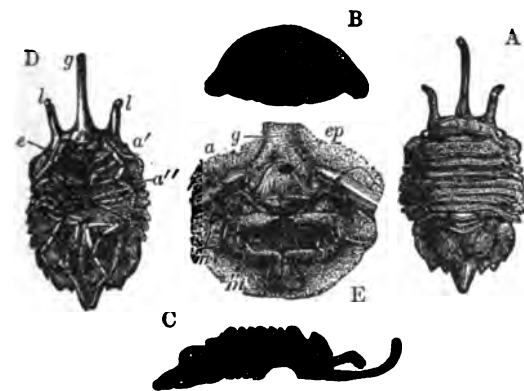

FIG. 72.—*Ceratocephalus Grayanus*; Flinders Island, Bass's Straits.

A, the dorsal aspect. B, front view of the head, showing the curvature of the three spines. C, side view. D, ventral aspect; *g*, the glabellar spine; *l*, *l*, the two lateral or genal spines of the head; *e*, the eye; *a'*, the antennule; *a''*, the antennæ—the legs are seen folded up beneath the body. E, the mouth enlarged, showing *ep*, the epistoma or upper lip-plate; *m*, the mandibles; *m'*, the pectinated maxilla; *a*, the antenna; the epistoma is set in the base of the glabellar spine *g*.

bers of their own class, frequently occupying the branchial chamber of the common prawn, and distorting the carapace on one side. A fossil *Bopyrus* is observed lying in the branchial cavity of a crab (*Palæocorystes*) from the Gault and Greensand.<sup>3</sup> We have already referred to these and other parasitic forms in the earlier part of this article.

<sup>1</sup> One species, *Eurythoe pulchra*, common in the Dee, Cheshire, actually attacks bathers. "If you remain a moment still in the water, dozens will fasten on you and nip most unpleasantly. I have had to jump into the water again after coming out from bathing, and splash violently to get rid of the hosts that had stuck to me while clinging to the side of the boat preparatory to getting in. They continue to bite after you are out of the water."—Extract of letter from Mr. Walker to Mr. C. Spence Bate.

<sup>2</sup> Mr. James Carter, F. G. S., lately showed the writer a *Palæocorystes* from the Cambridge Greensand, having a *Bopyrus* lodged in each of its branchial chambers.

*Trilobita* (Fossil, extinct).

1. Eyes sessile, compound.
2. No ocelli visible.
3. (Appendages partly oral, partly ambulatory, arranged in pairs.)
4. Thoracic segments variable in number from 6 even to 10

*Isopoda* (Fossil and living).

1. Eyes sessile, compound.
2. No ocelli visible.
3. Appendages partly oral, partly ambulatory, arranged in pairs.
4. Thoracic segments, usually seven, free and movable.

<sup>3</sup> Billings, *Quart. Journ. Geol. Soc.*, vol. xxvi. p. 479.

<sup>4</sup> Professor Dana writes, "The Trilobita probably belong with this second type" (the Edriophthalmia, or *Tetradecapoda*, as Dana names them) "rather than with the Entomostraca. Yet they show an aberrant character in two important points. First, the segments of the body are multiplied much beyond the normal number, as in the Phyllopora among the Entomostraca; and Agassiz has remarked upon this as evidence of that larval analogy which characterizes in many cases the earlier forms of animal life. In the second place, the size of the body far transcends the ordinary Isopodan limit. This might be considered a mark of superiority; but it is more probably the reverse. It is an enlargement beyond the normal and most effective size, due to the same principle of vegetative growth which accords with the (occasional) inordinate multiplication of the segments in the body" (*American Journ. Science*, July, 1856, vol. xxii. p. 11).

<sup>5</sup> H. Woodward, *Report on Structure and Classification of Fossil Crustacea*, Brit. Assoc. Edinburgh 1871.

- |  |  |
|--|--|
| <i>Trilobita</i> (Fossil, extinct).  | <i>Isopoda</i> (Fossil and living).  |
| 26, free and movable, animal sometimes rolling in a ball.                                      | animal sometimes rolling in a ball.  |
| 5. Abdominal somites coalesced, forming a broad caudal shield (bearing the branchiæ beneath?). | 5. Abdominal somites coalesced, forming a broad caudal shield, bearing the branchiæ beneath. |
| 6. Lip-plate, well-developed.  | 6. Lip-plate small.  |

Perhaps no investigator of fossil forms has devoted so much careful research to any group as M. Barrande has expended upon the extinct *Trilobita*. Writing recently upon the divisions of their body, he arranges them in four groups, according to the number of their free, movable thoracic segments.

The 1st, of 2 genera, has from 1 to 4 free thoracic segments.  
 " 2d " 24 " " 5 to 9 "  
 " 3d " 32 " " 10 to 13 "  
 " 4th " 16 " " 14 to 26 "

We thus perceive that the number of those forms of *Trilobites* which have a great excess of free segments is not large when we consider the group as a whole.

In the higher and more specialized forms of *Isopoda* of the present day, we do not find the number of segments absolutely adhered to without any variations; on the contrary, we constantly meet with individuals in which more or fewer segments are welded together so as to conceal the normal number of seven thoracic somites between the head and the abdomen. Such being the case, we cannot be surprised to find considerable variation in a group like the *Trilobita*, which, if they really are the remote ancestors of the recent *Isopoda*, must, according to the views suggested above, be the prototypes of the larvae rather than of the adult stage of the living *Isopoda*.<sup>1</sup>

In his researches among the *Trilobites* of Bohemia M. Barrande has discovered forms which there is every reason to believe exhibit (as he has so admirably shown in his great work) the gradual development of the *Trilobite* from the earliest form on quitting the egg to the adult. We give seven of the earliest stages of *Trinucleus ornatus* and seven of *Suo hirsuta*, copied from M. Barrande's monograph.

One most striking feature in the *Trilobita* is the remarkable development of their compound eyes (fig. 11), a subject ably discussed and illustrated long ago by Dr. Buckland in his *Bridgewater Treatise* (1836).

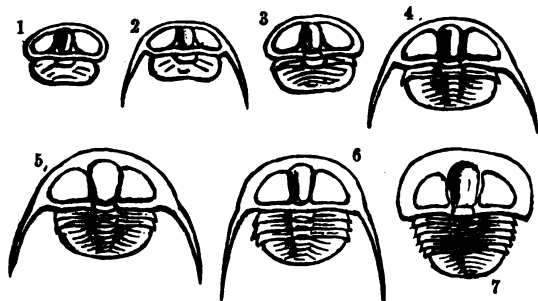

FIG. 74.—*Trinucleus ornatus*, Sternb. sp. (copied from Barrande's *Système Silurien du Centre de la Bohême*, Prague, 1852, 4to, plate 30). Specimens arranged in series according to their supposed age. (All the stages figured by Barrande are not given here.)

1. Young individual, destitute of thoracic segments, composed of head-shield and pygidium only.
2. Another of the same stage, in which the genal or cheek spines are developed.
3. Individual with one thoracic segment developed, but without the genal spines.
4. Another of the same stage, with the genal spines.
5. Individual with two thoracic segments, and with the genal spines present.
6. Individual with three thoracic segments, and possessing the genal spines.
7. Individual with five thoracic segments, but without genal spines.

Perhaps the eye of the *Trilobite* may best be compared with that of *Limulus*, but there are forms like *Egolina* in which the eyes are enormously developed, occupying nearly the entire head-shield with their faceted surfaces.

<sup>1</sup> The larvae of *Bopyrus*, *Cryptothiria*, and *Asellus*, and the adult *Egida*, *Idoleida*, *Sphaeromida*, and *Onciscida* offer many points of analogy with the extinct *Trilobita* (see the *History of the British Sea-eyed Crustacea*, by C. Spence Bate, F. R. S., and J. O. Westwood, M. A., in 2 vols., 1868-68, 8vo).

We have an analogous development of the organs of vision amongst some of the pelagic *Amphipoda*, the *Hyperidea*, and in a very singular form brought home by the "Challenger," the *Thaumopsis pellicuda* (*Phil. Trans.* 1873.) The "facial suture" in the head-shield of the *Trilobita*, which separates the lateral genal portion from the glabella, was for a long time considered as peculiar to *Trilobites* and *Limuli*, but C. Spence Bate has ably shown that it homologizes with the suture which traverses the

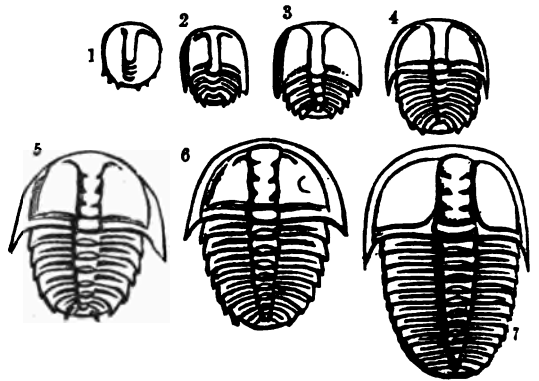

FIG. 75.—*Suo hirsuta*, Barrande (copied from pl. 7 of Barrande's work above cited). Barrande figures twenty stages of this trilobite, of which seven are reproduced here.

1. First stage. A young individual in which the limit of the head-shield is not indicated as separating it from the pygidium.
  2. Second stage. Young individual with the head-shield separated, and having indications of three soldered segments to the pygidium.
  3. Third stage. In which the genal angles of the head and the spiny border of the pygidium are well seen, and four or five soldered segments indicated.
  4. Fourth stage. In which two free thoracic segments are developed behind the head, and two or three soldered segments represent the pygidium.
  5. Fifth stage. In which the thorax is longer than the head, and is composed of three movable segments and three soldered segments in the pygidium.
  6. Sixth stage. In which four free segments succeed the head, and three or four soldered segments form the pygidium.
  7. Tenth stage. In which eight free segments succeed the head, and three soldered segments form the pygidium.
- In the twentieth stage figured by Barrande the adult has seventeen free thoraco-abdominal segments and two soldered ones (the pygidium).

inferior surface in the carapace of the *Brachyurous Decapod* and the cervical suture in the *Macrouran* type (*Reports Brit. Assoc.*, Bristol, 1875, p. 46).

The *Trilobita* are the chief representatives of the Crustacean class in Cambrian times.<sup>2</sup> More than 500 species have been described; out of these 350, representing 43 genera, have been recorded from the Lower Paleozoic rocks of Bohemia alone by Barrande.

About 51 genera and 304 species are British in Cambrian<sup>3</sup> and Silurian rocks; ten are Devonian and four Carboniferous. A gigantic *Paradoxides*, nearly two feet in length, occurs in the Middle Cambrian, and large forms of *Asaphus*, *Homalonotus*, *Lichas*, etc., are met in the Bala group. *Phacops*, *Sphaerexochus*, *Encrinurus*, *Cabymus*, *Ilænus*, and *Acidaspis* are among the Upper Silurian forms,—some, like *Acidaspis*, being extravagantly ornamented with spines and tubercles. The Devonian has fewer and less varied forms of *Trilobites*. Those in the Carboniferous belong nearly all to two genera (*Phillipsia* and *Griffithides*), both small, neat, and simple forms. None are met with in rocks of later date.

II. EDRIOPHTHALMIA: (5.) AMPHIPODA.—This order, as Spence Bate has well observed, constitutes a group among the Edriophthalmia, parallel with the *Macroua* among the *Podophthalmia*, whilst the *Isopoda* may represent the broad and flattened *Brachyura*, the *Cypridæ* offering a kind of parallelism with *Squilla* and its allies. As in the *Isopoda*, the head is small and carries only the organs of sense and nutrition; the sessile eyes<sup>4</sup> are generally small,

<sup>2</sup> *Agnostus*, the earliest genus met with, reminds one of the larval forms of *Suo* and *Trinucleus*.

<sup>3</sup> The large accession in late years to the fauna of these Cambrian rocks has resulted from the labors of Mr. Henry Hicks, F. G. S.

<sup>4</sup> The outer integument of the eyes is never divided into facets, except in the *Hyperidea*. In many of the *Phacides* the eyes appear to be wanting; but this is probably caused by the absence of any coloring pigment. In *Niphargus* the eyes are obsolete or rudimentary. In *Amphipoda* they appear like four simple organs resembling the ocelli of true insects (Spence Bate and Westwood, *Brit. Seas Crust.* vol. 1, p. 4).

yet in a few instances they are extremely large (e.g., *Lestrogonus* and *Thaumopa*), covering the entire sides of the head.

The seven thoracic segments, constituting the middle-body, are well developed and nearly equal in size; all the segments are compressed laterally as in the *Palaeonidea*.

The two anterior pairs of the seven thoracic legs (see Th. 8, 9 in fig. 1), which are jaw-feet in the Podophthalmia, are here developed into arm-like legs, having an enlarged penultimate joint or hand, against which the seventh and terminal joint doubles back, like a finger against the palm, and so forms a prehensile organ similar in form to the claws in the *Orangonidea*. The best-formed claws are seen in *Orchestia Darwinii* (fig. 45), and in *Melita exilis* (fig. 76).

The *ova* are nourished within a pouch formed by a series of foliaceous plates attached to the four anterior pairs of legs; except in the *Hyperidea*, which are parasitic on Medusae, as already mentioned. The males in the Amphipoda closely resemble the females (save in those forms in which the hands are enlarged in the male), but contrary to the general rule the females are much smaller than the males.

This division, like the preceding one, has its terrestrial representatives, *Talitrus* and *Orchestia*, the "sandhoppers,"<sup>1</sup> living out of the sea, but choosing moist places. *Orchestia*

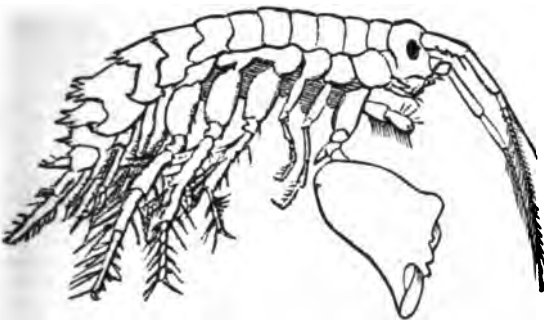

FIG. 76.—*Melita exilis*, n. sp., male, enlarged five times. The large branchial lamellae are seen projecting between the legs. (Fritz Müller.)

with us loves to live within reach of the sea spray, but some species in the southern hemisphere (*O. tahitiensis*, *telluris*, and *sybicola*) live many miles inland, some under plants at an elevation of more than a thousand feet above the sea.

But by far the largest section are natatorial in their habits, being most active and untiring swimmers. One form, *Gammarus pulex* (fig. 77), is most common in our fresh waters, two other genera, both blind, *Niphargus*, with three species, and *Orangonyx*, with one species, are found in wells in England,<sup>2</sup> and from their structure there is every reason to conclude they are as truly indigenous to these underground water-courses in the Chalk, Oolite, or Carboniferous Limestone, as are the numerous species of blind Crustacea met with in the waters flowing through the Mammoth Cave, Kentucky.

A curious subdivision of Amphipods is formed by the *Podocerides* (*Amphithoë* and *Podocerus*), all the species of which invariably construct nests in which they take shelter and nourish their young. These abodes are built of wood or stones, mud, clay, etc., united together by a cement excreted by the animals themselves. Some closely resemble miniature birds' nests, others are in the form of tubes.

This division includes another most destructive wood-borer, the *Chelura terebrans*, so devastating to piles and sub-



FIG. 77.—*Gammarus*, sp., fresh water.

marine timber all round the shores of Europe, but not recorded from other lands. Finally, we come to the minute aberrant forms of *Dulichidea* and *Caprellidea* (fig. 78), in which the body is reduced to a slender elongated cylin-

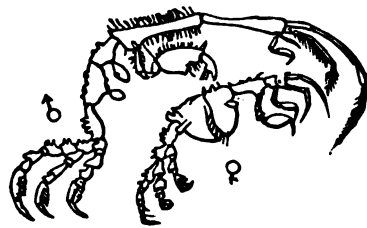

FIG. 78.—*Caprella tuberculata*, Guérin; south coast. (Spence Bate.)

drical form, the thorax having only about six somites (one being absent and two soldered together), and the abdomen being quite rudimentary. They have long antennae and feet, all fitted for climbing and holding on by. Their singular appearance has caused them to be called "spectre shrimps."

With these aberrant forms are associated the *Cyamidae* (fig. 79), a family which affix themselves by their strong recurved legs to the rough portions of the Cetacea upon which they feed. The feet are all prehensile; the third and fourth somites bear the branched or simple branchiae. The abdomen, as in the *Caprellidea*, is rudimentary; the eggs and young are sheltered by four broad lamellar plates, developed from the appendages on the under side of the body of the female.

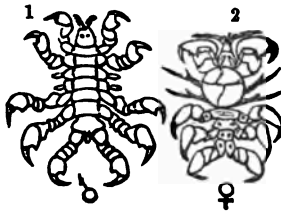

FIG. 79.—1, ♂ *Cyamus thompsoni*, Gosse: found attached to *Hyperoodon bidens*, Portland Roads. 2, ♀ *Cyamus ocellis*, Vauzeme: found attached to common whale. (Spence Bate.)

which also live parasitic on Cetacea (see ARACHNIDA, vol. ii. pp. 242-43), but we must not attempt to discuss their affinities here. A fragment of a presumed Amphipodous Crustacean has been described by the writer from the Upper Silurian (the *Necrogammarus Salweyi*); another, the *Gamponyx fimbriatus*, occurs in the Coal-measures of Germany, Bohemia, and America. Mr. Spence Bate has described one from the Permian of Durham, the *Prosoptoniscus problematicus*, its modern living representative, the *Sulcator*, making peculiar tracks upon our shores to-day like those met with upon the surfaces of slabs of Palaeozoic rocks. Several other Amphipod-like forms occur in the lithographic stone of Bavaria. The world-wide distribution of the Amphipoda accords well with their range in time, which was as great or even greater than the Isopoda.

Sub-class 2. GNATHOPODA (or *Entomostraca*).

III. MEROSTOMATA: (6.) XIPHOSURA.—The king-crab (*Limulus*) is a remarkable type of crustacean closely related to the extinct Eurypterida. Found living in the seas of China and Japan and on the north-east coast of North America, it exemplifies a peculiar and most ancient order, the affinities of which are not at first readily recognized because its nearest allies have passed away. The head-shield is enormously expanded so as to shelter all the anterior appendages beneath it; and the succeeding segments are so soldered together as to appear like one piece, although all the hind-segments are free and movable in the larva. The eyes are fixed on the head-shield; the antennules are chelate, and placed in front of the mouth. The antennae, mandibles, maxillae, maxillipeds, are all converted into walking-legs, forming also chelate appendages and, at their bases, jaws; thus serving admirably to illustrate the most prominent characteristic of the sub-class GNATHOPODA, "mouth-footed."

The thoracic feet are flattened out into broad bilobed plates which cover the branchiae and the egg-pouches. The abdomen is rudimentary, being partly represented by the posterior portion of the hinder shield, and partly by the

<sup>1</sup> It is in the summer months that they occur in such vast myriads upon our sandy shores. At Whitland Bay Mr. Twain saw "not millions, but cartloads," of one species (*Talitrus locusta*) lying piled together along the margin of the sea. They devour offal of every description, including dead carcasses of animals, which they rapidly assimilate and remove. In their turn they afford a repast to the ring-plover, the common wood-pigeon, and numerous shore-birds which rapidly devour them, as well as some coleopterous insects (the *Otilium laterale* and *Broscus cephalotes* (Bate and Westwood).

<sup>2</sup> Spence Bate and Westwood (*Sessile-eyed Crustacea*, vol. iii. pp. 811-328).

long enaiform tail-spine (1) (See Owen's Memoir, *Trans. Linn. Soc.*, vol. xxxviii., 1873.) But in the larvae, as has been already shown, these post-cephalic somites are free and unanchylosed, and the tail-spine is undeveloped, thus connecting the modern king-crab with its far-off ancestors in the Coal and Silurian periods. The oldest species known is the *Neolimulus falcatus*, H. Woodw. (5 in fig. 80), from the Upper Silurian of Lanarkshire, in which the segments are apparently all free and unanchylosed.

In the Coal-measures no fewer than three genera and eight species of small Limuloid Crustaceans have been met with, viz. *Bellinurus* (four species), *Prestwichia* (three species), and *Euproops* (one species),—the last named an American form. Many of these closely resemble young larval *Limuli*. The Oolitic *Limuli* found in the lithographic stone of Solenhofen agree closely with existing species, one form even equalling in size the living *Limulus polyphemus* from the American coast (1 in fig. 80; see also fig. 12).

III. MEROSTOMATA: (7.) EURYPTERIDA.—In this order we become acquainted with the second extinct type of the Crustacean class, and by far the most interesting, because

ing together of the body segments in the one and the retention of free movement in the somites in the other. The characters of these two orders of the Merostomata are summarized in the subjoined table.<sup>1</sup>

*Limulus* (Fossil and living).

1. Eyes sessile, compound.
2. Ocelli distinctly seen.
3. All the limbs serving as mouth-organs.
4. Metastoma rudimentary.
5. All the thoracic segments bearing branchiæ or reproductive organs.
6. Other segments destitute of any appendages.
7. Thoracic segments anchylosed.
8. Abdominal segments anchylosed and rudimentary.

*Pterygotus* (Fossil, extinct).

1. Eyes sessile, compound.
2. Ocelli distinctly seen.
3. All the limbs serving as mouth-organs.
4. Metastoma large.
5. Anterior thoracic segments bearing branchiæ or reproductive organs.
6. Other segments destitute of any appendages.
7. Thoracic segments unanchylosed.
8. Abdominal segments free and well-developed.

Numerous species of these ancient extinct long-bodied Merostomata have been met with and described by Hall in America, by Fischer in Russia and Sweden, and by Huxley, Salter, and Woodward in Britain (see H. Woodward's monograph in *Pal. Soc.*, 4 parts, 1865-1872).

The most perfect specimens of the genera *Slimonia*, *Pterygotus*, and *Eurypterus* have been obtained by Dr. J. Slimon of Lesmahagow, Lanark. The largest known remains, representing specimens from 5 to 6 feet in length, are from the Devonian of Forfarshire, belonging to the great *Pterygotus anglicus* and to *Stylonurus scoticus* obtained by Mr. James Powrie, F.G.S., Beawallie, Forfar.

In the Upper Silurian we have one English genus, *Hemiaspis* (6 in fig. 80), and three Russian forms, *Eapinurus*, *Pseudoniscus* (7 in fig. 80), and *Bunodes*, which, like the Anomoura, serve to bridge over the interval between the *Limuli* and *Pterygoti*, the hind-body being partially developed. The best illustration of the Eurypterida is to be found in the zoëa of the common shore-crab, *Carcinus maenas* (figs. 26 and 27), in which the principal locomotory organs are the maxillipeds, and the abdominal somites are destitute of all appendages. The latest representative of this extinct order has been found in the Lower Carboniferous series of West Lothian, the *Eurypterus Scouleri*, which however differs greatly from all the other forms.

IV. BRANCHIOPODA: (8.) PHYLLOPODA.—This order includes not only the bivalved *Eatharia* and *Nebalia*, and the shield-bearing *Apus*, but two forms of naked gill-footed Crustacea, *Branchipus* and *Artemia* (5 in fig. 87). Of the shield-bearing forms the fresh-water *Apus* may serve as a good example. The eyes are placed in front on the dorsal surface of the carapace and are nearly confluent. The first pair of feet (maxillipeds) are long and branching; to these succeed about sixty pairs of branchial feet. The thoracic and abdominal somites are nearly cylindrical and are composed of about thirty articulations, terminated by two long, many-jointed tail-spines.

Probably *Apus* has more articulations to its appendages and body than any other Crustacean. Schäffer tabulated them, and found they numbered 1,802,604; Latreille puts them down at not less than 2,000,000. *Apus* affords an excellent illustration of a form in which the mere vegetative repetition of parts is carried to an extreme distance beyond the normal number of body-rings so characteristic of the class.

In *Nebalia*, the marine type (1 in fig. 57), the carapace or head-shield has a well-marked rostrum, and is more compressed laterally than in *Apus*, covering the head and thorax and even a part of the abdomen. The eyes in *Nebalia* are placed on peduncles beneath the carapace; the number of segments is not excessive as in *Apus*.

In *Eatharia* (fig. 56), the carapace is composed of two valves, subovate in outline, like a bivalve molluscan shell, which it also resembles in being united by the umbones of each valve on the anterior dorsal border, and in each valve being marked by regular concentric lines of growth.

*Branchipus* (5 in fig. 57) and *Artemia* are destitute of any carapace, so that the elegant wave-like motion of their many-jointed transparent bodies and branchial feet can be

<sup>1</sup> Taken from H. Woodward's Report on the structure and classification of the fossil crustacea (*Brit. Assoc. Reports, Edinburgh, 1871*).

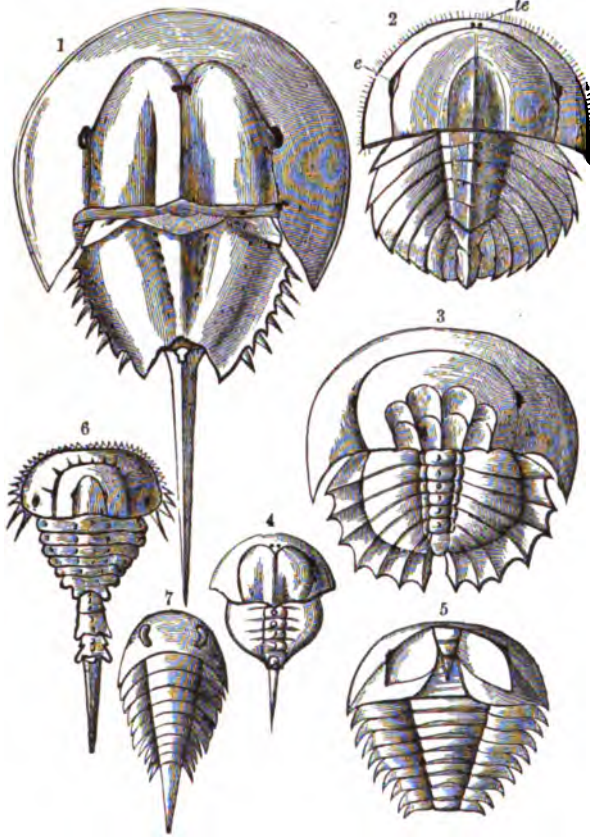

FIG. 80.—1. *Limulus polyphemus*, adult (dorsal aspect). 2. *Limulus polyphemus*, young (dorsal aspect). 3. *Prestwichia rotundata*, Coal M., Shropshire. 4. *Prestwichia Birtwoldi*, Coal M., Lancashire. 5. *Neolimulus falcatus*, U. Silurian, Lanark. 6. *Hemiaspis himaloides*, L. Ludlow, Leintwardine, Shropshire. 7. *Pseudoniscus aculeatus*, U. Silurian, Russia.

all the appendages as well as the body-rings have been preserved to us, whereas in the Trilobita the former are remarkable by their almost entire absence.

Unlike *Limulus*, in which all the segments in the adult are soldered together into a fore and hind body and telson, in the Eurypterida the body is long and well adapted for swimming, the segments being quite distinct and well developed; the feet are also fitted for natation (see 5 in fig. 73, and fig. 81).

We again observe the reiteration of the same well-marked characteristics in the legion Merostomata—already noticed in the Edriophthalmia and Podophthalmia; namely, the division into *Brachyuran* and *Macrouran* forms which exemplify the crawling and swimming types, by the solder-

freely observed. The former inhabits our fresh waters, the latter is marine, being peculiarly prolific in the brine-pans at Lymington, where the workmen firmly believe that the "brine-shrimp" aids in some way the rapid deposit of salt, through the constant agitation caused by such myriads of these minute and restless Entomostraca in the water.

*Chirocephalus* or *Branchipus* is believed to be only a variety of *Artemia*, resulting from change of conditions between a fresh and an extremely saline fluid medium.<sup>1</sup>

In Professor T. Rupert Jones's monograph on fossil *Estheria*, out of thirty-eight localities recorded for that genus living, three only were met with in brackish water.

Mr. John Arthur Phillips, F.G.S., states that the *Artemia fertilis* is exceedingly abundant in the highly-saline waters<sup>2</sup> of Mono and Owen's Lakes, California. These little Crustacea congregate in such dense serpentine or an-

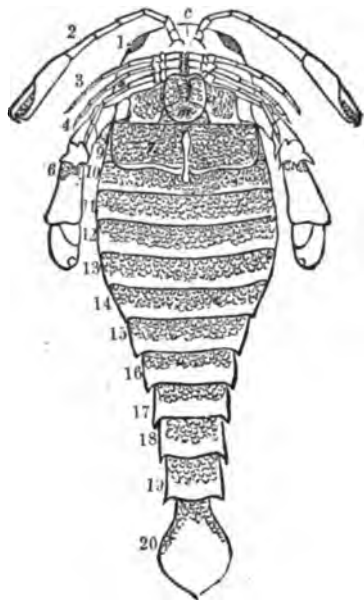

FIG. 31.—Underside of *Pleurypterus Anguipes*, Ag. (restored). c, Cephalon; m, Metastoma or post-oral plate. 1, The compound eyes; 2, Chelate antennae; 3, The mandibles; 4, First maxillae; 5, Second maxillae; 6, Maxillipeds; 7, the operculum or thoracic plate, which fits closely against the ventral surfaces of the two anterior thoracic somites, 8 and 9. 8-14, Thoracic somites; 15-19, Abdominal somites; 20, Telson.

angular masses in the water that a breeze sufficient to ruffle the surface of the lake scarcely affects the water filled by the *Artemia*, which remains perfectly smooth. The only other inhabitant of these salt-lakes is the larva of a dipterous insect, the *Ephydra californica*, Torrey, which is collected by the Indians, and, when dried in the sun, forms an important article of food. Myriads of gulls and other aquatic birds visit these lakes in summer to feed upon the *Artemia* and larval *Ephydra*.

*Nebalia*, at the present day, seems but the puny and degenerate representative of the once giant pod-shrimps of Silurian times, the caudal somites of one of which measured 8 inches and the tail spines 6 to 7 inches in length, the carapace not being preserved.<sup>3</sup> The ancestors of *Nebalia* date back to the Menevian group, *Hymenocaris major* being the earliest known. *Ceratiocaris papilio* is so abundant in the Upper Silurian of Lesmahagow, Lanark, as to cover entire beds with its remains.

Many fossil forms, as *Dithyrocaris*, *Discinocaris*, *Aptychoparis*, and *Pellocaris*, carried their head-shield flat and expanded like *Apus* at the present day; one of these, a *Discinocaris* from Moffat, Dumfriesshire, had a carapace

7 inches in diameter. These forms occur in all the Palaeozoic rocks. *Estheria* are found in the various strata from the Carboniferous Limestone to the Tertiary. Although *Branchipus* or *Chirocephalus* is destitute of any head-shield, its fossil remains have just been transmitted to the writer together with numerous Dipterous and Coleopterous insects from a freshwater deposit, associated with plant remains, at Gurnet Bay, in the Isle of Wight.

IV. BRANCHIOPODA: (9.) CLADOCERA.—In the Cladocera are placed a number of minute animals furnished with branching natatory antennae and five or six pairs of short foliaceous feet; the body (except the head which is distinct and projecting) is entirely inclosed within a carapace, formed of two valves joined together on the back; the eye is single and very large. The Cladocera are chiefly freshwater, and are distributed over the whole world. Of this order the *Daphnia pulex* (1 in fig. 58), so abundant in our fresh waters, is a good example. So numerous are they in our ponds in summer as frequently to impart a blood-red hue to the water for many yards in extent. In order to realize the wonderful fecundity of this and allied genera,<sup>4</sup> it is necessary to realize that when a *Daphnia* is only ten days old, eggs commence to be formed within the carapace, and under favorable conditions of light and temperature, it may have three broods a month or even a greater number,—the largest species having as many as forty or fifty eggs at once. No males appear until the autumn, so that all the earlier broods are derived from females, whose parent was fertilized, and died after depositing its eggs, the year before, and these continue to reproduce fertile female offspring throughout the summer.

F. Goldenberg has lately described a fossil form belonging to this division (*Lyncites ornatus*) from the Coal-measures of Saarbruck.<sup>5</sup>

V. LOPHYROPODA: (10.) OSTRACODA.—In the Ostracoda, of which *Oypria*, *Candona* (2 in fig. 58), and *Cythere* are examples, the body is entirely inclosed in a carapace composed of two nearly equal parts like a bivalve shell. Two pairs of antennae, one pair long, with hairy filaments, one pair short, stout, and recurved (like feet), and three pairs of short feet, may be seen protruded from the carapace, which is compact and brittle, yet is capable of protecting the living animal during long periods of drought, buried in the dried-up mud of pools. *Oypria* frequents stagnant water, living on dead animal matter. *Cythere* is found in pools along the sea-shore.

Like the Phyllopoada, the Ostracoda are of immense geological antiquity, *Primatia prima* occurring in the Lower Cambrian of St. David's. There is abundant evidence, in almost every stratum, of the former existence of these little bivalved Crustacea, often in vast numbers; their size in early times was much larger, *Leperditius* as big as large horse-beans being found in Silurian strata, but the living forms are all microscopic. M. Ch. Brongniart has just described a fossil Ostracod *Palaeocypris Edwardsi*, inclosed in silex from the coal of St. Etienne, in which all the organs are most perfectly preserved.<sup>6</sup> It closely resembles the modern form. The Ostracoda help with other microscopic organisms to build up the Chalk. They make up the great mass of the *Cypris* shales of the Wealden, Isle of Wight, and many Tertiary beds are largely composed of their remains.

V. LOPHYROPODA: (11.) COPEPODA—(a.) LIBERATA.—The free Copepods, of which *Cyclops*, *Canthocamptus*, and *Cetochilus* may serve as examples, have the head and thorax closely enveloped in a carapace with which the front rings of the thorax are confluent. The abdominal somites are much diminished in size and cylindrical. The single or paired external ovisacs are attached to two of the posterior somites, which are usually welded together. The single sessile median eye is situated near the front of the head; in the males of *Diaptomus* and *Anomaloceera* the eye is pedunculated. The antennae are very long and powerful natatory organs (in *Cetochilus*, 4 in fig. 58, and *Diaptomus* equalling the entire length of the animal's body); in the males one or both of the antennae have a swelling near the centre or towards the extremity, followed by a movable joint which acts like a hinge and serves as a clasper to detain the female. There are five pairs of rowing feet, one pair of which are usually rudimentary.

<sup>1</sup> See M. W. J. Schrankewitsch's paper on the transformations of *Artemia* and *Branchipus*, *Ann. and Mag. Nat. Hist.* vol. xvii. March, 1876.

<sup>2</sup> In 1866 Mr. Phillips found that the waters of Owen's Lake had a specific gravity of 1.076, and contained 7128.24 grains of solid matter per gallon. This solid matter held in solution consisted of chloride, sulphate, and carbonate of sodium, 6813.28; sulphate, phosphate, and silicate of potassium, 298.02; and organic matter, 16.94 grains per imperial gallon.

<sup>3</sup> See *Geol. Mag.* 1866, vol. iii. pl. 10, fig. 8, p. 203; and *Geol. Mag.* 1871, vol. viii. pl. 3, fig. 3, p. 104.

<sup>4</sup> See Memoir by Professor Leydig, *Naturgeschichte der Daphniden*, 4to, Tübingen, 1860; Sir John Lubbock in *Phil. Trans.* 1857; Baird's *British Entomostraca* (Ray Society).

<sup>5</sup> Giebel und Sievert's *Zeitschrift*, 1870, vol. i. p. 524.

<sup>6</sup> *Ann. des Soc. Geol. France*, t. vii. pt. vi.

The species belonging to this family are to be found in both fresh water and the sea. In the muddiest and most stagnant pools and in the clearest springs *Cyclops* abound (3a in fig. 58). The marine species frequent the pools along shore and the open ocean in equal abundance. They assist in producing that luminous appearance in the sea called "phosphorescence," for want of a better name (5 in fig. 58).

The fecundity of this order is truly surprising. *Cyclops quadricornis* is often found with thirty or forty eggs on each side; and though those species which have but a single ovisac do not carry so many, their number is still very considerable. Jurine isolated female specimens of *Cyclops*, and found them to lay eight to ten times within three months,—each time about forty eggs. At the end of a year one female would have produced 4,442,189,120 young! *Cetochilus* (4 in fig. 58) is so abundant, both in the Northern Seas and in the South Atlantic, as to serve for food to such an immense animal as the whale. They color the sea for many miles in extent, and when the experienced whaler sees this ruddy hue upon the ocean he knows he has arrived at the "pasture of the whales." They are to be seen in vast quantities off the Isle of May in the Firth of Forth during the summer months; many Cetacea are attracted thither, and vast shoals of fish also come to feed upon them. One anomalous type of free Copepods is the *Notodelphys acidicola*, described by Allman, which is found swimming freely in the branchial sac of the *Ascidia communis*. In this species the female has the fourth anterior segment of the body peculiarly modified, so as to form on its dorsal surface a marsupium for receiving and retaining the ova until they are hatched, when they escape by an opening between the sac and the upper surface of the body-ring.

We have no positive records of Copepoda occurring in a fossil state.

V. LOPHYPODA: (11.) COPEPODA—(b.) PARASITA.—The parasitic Copepods are divisible into two groups, the first comprising the peripatetic genera, in which the male and female both retain their organs of locomotion in the adult state, and can change their habitat whenever needful; this division would include the fresh-water *Argulidae* and the marine *Caligidae*. The second division embraces the fixed parasites, in which the females when adult lose their locomotory appendages and become fixed, deriving their nourishment by a true suctorial mouth, armed with styliform mandibles, from the fishes and other animals upon which they are parasitic. The larvae when they emerge from the egg are nauplii, like those of other Copepods. The males and females are then alike; after attachment the female often attains a large size, and is soon little more than a maggot-like body, with immense paired ovaries attached to her abdomen. The male is very small and resembles a fat *Acaeus*; he is usually parasitic on the female, adhering to the vulva.

Almost every fish has some form of the Copepod parasites, either on its skin, its eyes, or its gills.

*Argulus foliaceus* is of a rounded oval shape, the carapace inclosing the thoracic somites in a deep notch behind, and the body terminating with a bilobed telson. The antennae are formed into recurved hooks for holding on by, when the animal shifts its position. The second pair of foot-jaws are converted into powerful suckers by which it attaches itself to its host. The mouth is tubular, and has a sharp styli-form organ within it, affording good evidence of its suctorial habits. There are four pairs of biramous natatory feet. The animal, when detached, swims with extreme rapidity and elegance, and no fish, however rapid, can escape from its adherence.

The female is much larger than the male. She leaves the fish on which she is parasitic when desirous to deposit her eggs, which she fixes to a stone or other inorganic body at the bottom of the water. As many as 400 are deposited at one time by a single female. *Argulus catostomi* is said to lay 1500 eggs at once. The young are hatched in thirty-five days, and after about three moults as free Copepod larvae they put on the adult form.

It would be impossible to give a detailed account of all the varied forms of Copepoda in an article like the present; we therefore must refer the reader to the works of Baird, Claus,<sup>1</sup> and others for fuller information.

VI. ANCHORACEPHALA: (12.) RHIZOCEPHALA.—These

<sup>1</sup> See Dr. C. Claus, *Die Fret Lebenden Copepoden mit Besonderer Berücksichtigung der Fauna Deutschlands der Nordsee und des Mittelmeeres*, 87 plates, Leipzig, 1863, 4to.

have been referred to under Metamorphosis, so that we need not allude to them further here, save only to give illustrations of two genera, *Pellogaster* (fig. 82) and *Saccolina* (fig. 83).

VI. ANCHORACEPHALA: (13.) CIRRIPEIDIA.—Forty years ago the Cirripedia were still arranged as Mollusca in many public museums; nor is this surprising, considering the fixed condition of their shells and the degree of external resemblance between *Lepas* and *Teredo* on the one hand, and *Balanus* and a compound of a *Patella* and a *Chiton* shell on the other. Strauss in 1819 first affirmed that Cirripedes were Crustacea. But this view was disregarded until J. Vaughan Thompson's capital discovery in 1830 of their metamorphosis, since which time they have been almost universally placed with the Crustacea.

The Cirripedia are classed by Darwin in three great divisions:—(1) THORACICA (limbs thoracic); (2) ABDOM-



FIG. 82.



FIG. 83.

FIG. 82.—Young of *Pellogaster sociatis* on the abdomen of a small hermit-crab; in one of them the fasciculated ramified roots, *r*, is the liver of the crab are shown. The animal and roots are deep yellow. (Fritz Müller.)

FIG. 83.—Young of *Saccolina purpureus* with its roots; the animal purple-red, the roots dark grass green. Magn. 5 diam. (Fritz Müller.)

INALIA (limbs abdominal); (3) APODA (appendages wanting). In the first division are embraced the *Balanidae*, the *Verrucidae*, and the *Lepadidae*; in the second a single genus, *Cryptophilus minutus*; the third is also represented by one form, the *Protolepas binivata*.

(1) THORACICA.—Cirripedes ordinarily are bisexual, in which respect they differ from all other Crustacea,—the male (where it exists distinct) being minute and rudimentary in structure and permanently epizooic on the female. In these latter facts we find an analogy in the Copepoda Parasita just noticed. The male has the excretory organ single, median, and probosciform, and placed at the extremity of the abdomen,—in all these respects differing from other Crustacea in which the male organ is laterally double. In the female organs the ovarian tubes and coxa inoculate together; there are no oviducts, the ova connected together by membrane, and so forming the "ovigerous lamellae," become exposed by the exuviation of the lining tunic of the carapace or sack, and by the formation of a new tunic on the under side of the lamellae, a process unknown in any other Crustacean. The Thoracica are mainly divided into *Balanidae* and *Lepadidae*; in the former, the animal when adult is inclosed in the parietes of its shell, and fixed to some living or dead object by a broad shelly basis, the aperture being protected by the opercular valves. In the *Lepadidae* the animal is attached by the extremity of a more or less long muscular peduncle, and its body is lodged within the shelly valves of the capitulum. In some species, as in *Pollicipes* and *Scalpellum*, the peduncle is covered with more or less numerous rows of scales or squame. This peduncle in *Pollicipes* and *Scalpellum* corresponds with the basis in *Balanus*, as may clearly be seen if a *Pollicipes* with a short peduncle and a *Balanus* with a deep cup-formed or cylindrical basis be compared, the animal being in part lodged in both, as in *Ibla* and *Lithotrya*. The scales which surround the base of the valves in *Pollicipes* correspond with the parietes of the walls of *Balanus*, the valves of the capitulum of the former being homologous with the opercular valves in the latter (fig. 84). The body consists of six, perhaps of seven, posterior thoracic somites. In the division Thoracica the abdomen is undeveloped.<sup>2</sup> The thoracic segments support six pairs of cirri. Each cirrus consists of a two-jointed

<sup>2</sup> All the *Balanidae* are bisexual and hermaphrodite, no male or complementary males having been found in any of them.

<sup>3</sup> In the pupa, however, of this order, and in the mature animal of the two other orders (the *Abdominalia* and *Apada*), it is formed of three segments.



pedicel, carrying two multi-articulated rami. The mouth has a labrum, palpi, mandibles, and two pairs of maxillæ; within the sack a folded membrane forms the branchiæ. Darwin concludes that in the Cirripedia the body may be said to be composed, at most, of but seventeen segments.

In order to indicate the homologues which still exist between the parts of an adult Cirripede and an ordinary free Crustacean, we give the accompanying illustrations from Darwin (fig. 85). The upper figure is a Stomapod

imbedded in vast numbers in the living shell of *Cochlelepus Peruviana*, the crypts almost touching each other. The three abdominal somites bear three pairs of cirri, the thoracic somites being apodal. The sexes are distinct, the minute almost globular male being lodged within the crypt occupied by the female. Darwin found from one or two up to seven males attached to the same female.

(3) APODA.—This section, like the last, contains only a single form, the *Prolelepus bivineta*, resembling the larva or maggot of a fly attached by two threads; the mouth is suctorial; it has no limbs; its body is shell-less, and it lies parasitic within the sack of *Alepus cornula*.

Cirripedia occur attached to the most varied objects, living and dead, throughout the seas of the globe. Sessile forms like *Tubicinella*, *Coronula*, *Platylepas*, *Chelonobia*, etc., are found attached to, and imbedded in, the epidermis of the whale, and on the shell of the turtle, etc. Pedunculated forms are similarly widely distributed. Fritz Müller calls attention to one anomalous form described by Darwin, the *Anelasma squalicola*, parasitic upon sharks in the North Sea, which seems to offer a remarkable analogy to the Rhizocephala. This Lepadide, he says, seems in a fair way to lose its cirri and buccal organs altogether. "The widely-cleft shell-less test is supported upon a thick peduncle, which is imbedded in the skin of the shark. The surface of the peduncle is beset with much-ramified hollow filaments, which penetrate the shark's flesh like roots." Cement glands and cement were not visible. "It seems to me," says Fritz Müller, "hardly doubtful that the ramified hollow filaments are themselves nothing but the cement ducts converted into nutritive roots, and that it is in consequence of the development of this new source of nourishment that the cirri and buccal organs are in the highest degree aborted." All the mouth organs are minute and rudimentary; the cirri thick, inarticulate, and destitute of bristles; the muscular tissue without transverse striation, and the stomach perfectly empty.<sup>2</sup>

"The Lepadidae," writes Darwin, "include a much greater range of forms than the *Balanidae*, and this is what might have been expected, for it is the most ancient family, and extinction has done its work in separating genera which, according to analogy, were once more nearly connected by intermediate forms."

The most ancient sessile Cirripede found fossil is the *Pyrgoma cretacea*, H. Woodw., from the Chalk. Previous to 1865 the oldest known pedunculated Cirripede was the *Pollicipes rhaticus*, Moore. In that year the writer described a curious and most anomalous form of Cirripede, from the Upper Silurian of Dudley, with imbricated calcareous plates (fig. 86), under the name of *Turrilepas Wrightii*, previously described as a *Chiton*. The fossil form with which it has been compared is more perfect and equally bizarre, viz., the *Loricula pulchella* (see 6 in fig. 70), originally discovered in the Chalk of Rochester and since in that near Norwich. It affords evidence of a most aberrant form of Lepadide, in which the capitulum is very small; the body of the animal was lodged in a broadly expanded peduncle, clothed in five rows of smooth loricated calcareous scales, which, if both sides were perfect, would have possessed ten rows and the plates would have exceeded 200 in number. In Bate and Westwood's *Sessile-eyed Crustacea* (vol. ii. p. 268) is figured a larval form of *Cryptothiria Balani* (reproduced in fig. 41 above), which seems to afford evidence of a similar arrangement of plates. Possibly *Loricula* was parasitic like *Bopyrus*.

In conclusion, sufficient evidence has been adduced to show that the normal development of the Crustacean class has been one of progressive advancement, the forms of to-day, when viewed as a whole, being more highly developed and more differentiated than those which the geological record has preserved to us. But in any large community or class it is only the few that outstrip the many in the struggle for existence. Thus the Podophthalmia and Edriophthalmia present numerous examples of high advancement, both in intelligence and in attaining to a terrestrial life, especially in the Decapoda-Brachyura. The Ostracoda, Phyllopoda, and Xiphosura are good instances of merely persistent forms. They are orders the members of which have branched out long since into byways of their own, where, being checked from further

<sup>2</sup> Fritz Müller, *op. cit.* p. 140, and Darwin, *op. cit.* p. 170, Pl. 4, figs. 1-7.

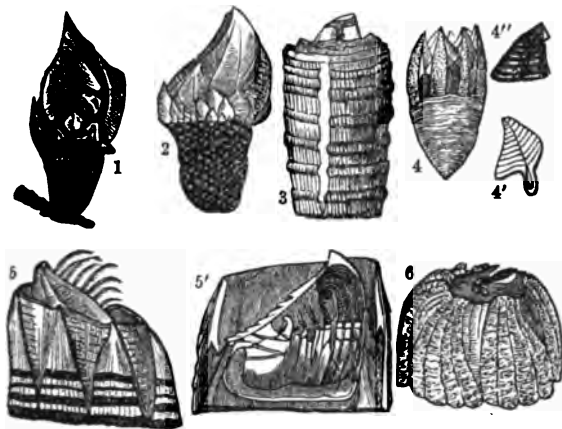

FIG. 84.—1, *Scapellum rostratum*, Darwin, Philippine Islands; 2, *Pollelepus corseopis*, Leach, European Seas; 3, *Tubicinella tracheata*, Shaw, attached to whales; 4, *Acacia sulcata*, Lamk., in sponges, New South Wales (4', scutum); 5, *Balanus tintinnabulum*, Linn., Atlantic; 5', Section of *Balanus*, Linn.; 6, *Coronula diadema*, Linn., attached to whales.

Crustacean (*Leucifer*); the abdomen, being rudimentary in the adult Cirripedia, is only shown in faint outlines. The lower figure is of a mature *Lepas* with the antennæ and eyes, which are actually present in the larva, retained for the sake of completing the comparison. "All that we externally see of a Cirripede, whether pedunculated or sessile, is the three anterior segments of the head of a Crustacean, with its anterior end permanently cemented to a surface of attachment, and with its posterior end projecting vertically from it" (Darwin).

The thoracic appendages of the Cirripedia present us with yet another wonderful modification of the Crustacean type; these biramous multi-articulated cirri are neither natatory, nor ambulatory, nor branchial, but "captorial," or fitted for sweeping the water, and thus catching prey,—

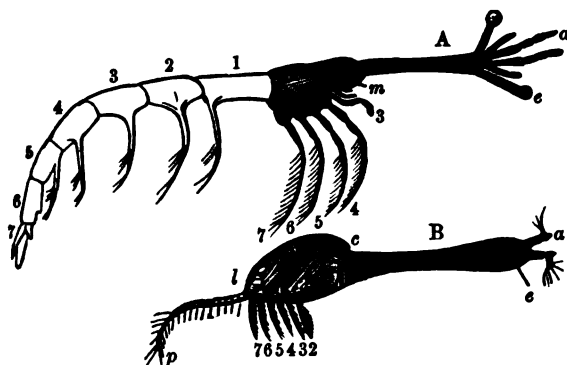

FIG. 85.—Theoretical view of the homologues of the Cirripedia with other Crustacea. A, *Leucifer* (a Stomapod); B, *Lepas*. a, antennæ; s, the eyes; m, the mouth; p, the penis. (After Darwin.)

their alternate extensile and retractile wave-like movements bringing all floating particles and minute organisms within reach of the inclosed mouth.<sup>1</sup>

(2) ABDOMINALIA.—The single Cirripede, the *Cryptophialus minutus*, forming this section is the smallest known, being less than  $\frac{1}{10}$ th of an inch in length. It is met with

<sup>1</sup> Mr. Gosse mentions that the little crab, *Porcellana platycheles* (fig. 88), which lives concealed, holding tightly to the under side of flat stones at low water, does exactly the same thing with its maxillipeds as the barnacles do with their cirri; it keeps up a semicircular sweeping movement, so that a constant current conveys all the small living and dead objects within reach of its mouth.

progress, they have, by their great tenacity of life and large powers of reproduction, held their ground through the long lapse of ages from Silurian times to the present day, whilst higher orders have been modified or swept away.

But the history of some Crustacea has been *retrogressive*, probably in a few instances from arrested larval development, as, for example, in the case of the imperfectly-developed fifth pair of legs in *Porcellana*, *Galathea*, and *Munida*; in most instances, however, retrogression seems clearly traceable to the parasitic or sedentary mode of life which the members have adopted. We have examples of this in the loss of eyesight in Crustacea passing their lives in subterranean caverns, wells, and streams; the loss and atrophy of a part of the defensive armature of the body in the burrowing *Thalassinidæ*; the complete loss of the abdominal calcareous covering in *Pagurus*; the general

was canonized. The poems and prose works of San Juan de la Cruz, which are chiefly devotional and never secular, though rhapsodical and mystical and often obscure, are distinguished by much passionate eloquence and beauty of diction.

Since 1619, the date of the first edition, they have been frequently reprinted. They have been several times translated into French, and a Latin version appeared at Cologne in 1639. A complete edition forms volume xvii. of the *Biblioteca de Autores Españoles*, where is also contained an interesting treatment of his character; and his poems are published in Depping's *Floresta de Rimas Castellanas*, and in an edition by Storck (Munster, 1854), who has also published a German version. See, besides, the highly laudatory and popular life published in 1625, and the lives by Joseph de Jesu-Maria and by Sainte-Alexis.

CRUZ, RAMON DE LA, Spanish dramatist, was born at Madrid in 1731. Nothing is known of his life, save that he was an employé in the ministry of finance, that he was a member of the Academy of Seville and of the Roman "Arcadians," and that between 1786 and 1791 he published some ten volumes of plays. Among his 300 pieces he is remembered only by his *sainetes*, little farcical sketches of city life, written to be played between the acts of a greater play, or as afterpieces.

Specimens are to be found in Ochoa, *Tesoro del Teatro Español*, vol. v.; and seventeen of the best of them have been translated into French, and published, with an introduction, by Antoine de Latour, in his *Sainetes de Ramon de la Cruz*, Paris, 1865. A complete edition, comprising upwards of 110, was issued by Don Agostino Duran in 1848. See Ticknor's *Spanish Literature*, iii., 249-251.

CRYOLITE, so named from *κρύος*, ice, and *λίθος*, stone, on account of its ready fusibility, is a massive, usually granular or indistinctly crystalline, cleavable, translucent to transparent, brittle mineral, of a snow-white (sometimes reddish or brownish) color, vitreous lustre, hardness 2.5, and specific gravity 2.9-3.077. Its transparency is increased by immersion in water. Before the blowpipe it fuses easily to an opaque white enamel. It is a double fluoride of aluminium and sodium, with the percentage composition—aluminium 13, sodium 32.8, fluorine 54.2, answering to the formula  $Al_2F_6NaF$ . Cryolite is used in the manufacture of soap, soda, aluminium sulphate, alum, and cryolite glass; and, till superseded by bauxite, was the chief source of aluminium. That metal was first obtained from it, early in 1855, by Allan Dick, who fused the mineral with alternate layers of small pieces of sodium in a magnesia-lined crucible. Rose, in September of the same year, published a method of producing aluminium by heating together cryolite, potassium chloride, and sodium. According to M. Gauduin a mixture of equal parts of cryolite and barium chloride forms a flux superior to borax for soldering iron, or brazing copper, brass, and bronze. Cryolite was discovered and named by Abildgaard about the year 1800, and was subsequently described by D'Andrada and Karsten, and accurately analyzed by Klaproth. Giesecke in 1822 first made known its occurrence at Ivigtot, in the colony of Frederikshaab, South Greenland. It is found there associated with galena, pyrites, and chalybite, and forms a vein 80 feet in thickness. At Miask in the Urals it occurs with chiolite, lepidolite, and fluor. In 1875 thirty-three cargoes of the mineral, representing a total of 5076 cubic yards, were shipped from the mine at Ivigtot, where the number of laborers employed during the summer was 136. The tax on the mine yielded to the revenue of Greenland in twenty years, or from 1853 to 1874, the sum of £46,402.

CRYPT (Latin *crypta*, from the Greek *κρύπτω*, I hide), a vault or subterranean chamber, especially under churches. In classical phraseology "crypta" was employed for any vaulted building, either partially or entirely below the level of the ground. It is used for a sewer (*crypta Subura* Juvenal, *Sat.* v. 106); for the "carceres," or vaulted stalls for the horses and chariots in a circus (Sidon. Apoll., *Car.* xxiii. 319); for the close porticoes or arcades, more fully known as "cryptoporticus" attached by the Romans to their suburban villas for the sake of coolness, and to the theatres as places of exercise or rehearsal for the performers (Plin., *Epist.* ii. 15, v. 6, vii. 21; Sueton., *Calig.* 58; Sidon. Apoll., lib. ii. epist. 2); and for underground receptacles for agricultural produce (Vitruv. vi. 8, *Varro de re*

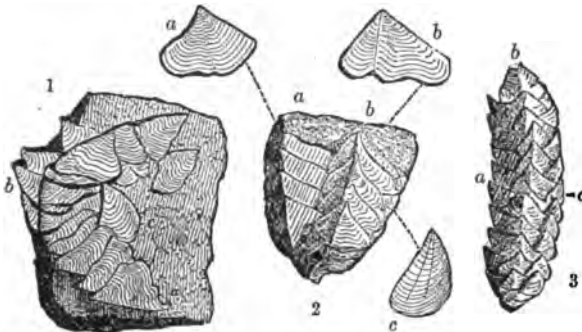

FIG. 86.—*Turritopsis Wrightii*, H. Woodw. (*Chiton Wrightii*, De Kon); U. Silurian, Dudley. The detached figures, a, b, c, indicate the three forms of plates of which the peduncles are composed in 1, 2, and 3, which bear the corresponding letters. The opercular valves are not known.

atrophy of limbs and loss of symmetry of the body in the *Bopyridæ* through residence within the branchial chambers of other Crustacea; and the complete or partial loss of all or nearly all recognizable Crustacean characters in the adult female, or in both sexes, by parasitism on Crustacea, fishes, etc., in certain of the *Bopyridæ*, in the Copepoda, in the Rhizocephala, and in the Cirripedia.

Viewed as a whole, the Crustacea probably offer the best illustration of a class constructed on a common type, retaining its general characteristics, but capable of endless modifications of its parts, so as to suit the extreme requirements of every separate species.

The outline of this great class here attempted necessarily lacks many important details; these must be filled in by the reader from the various works referred to throughout the article. (H. W.)

CRUVEILHIER, JEAN (1791-1874), a French anatomist, was born at Limoges. Having been educated at the university of Paris, where he received his doctor's degree in 1816, he practised for some years in his native town, at Paris, and at Montpellier. In 1825 he became professor of anatomy in the university of Paris, and ten years later he was the first occupant of the recently founded chair of pathological anatomy. He was also created Commander of the Legion of Honor.

The chief works of Cruveilhier are his *Anatomie pathologique du corps humain* (1st vol., 1829, 2d vol., 1842), *Traité de Anatomie pathologique générale* (1849-64), *Anatomie du Système nerveux de l'Homme* (1845), *Traité d'Anatomie descriptive* (1851).

CRUZ, JUAN DE LA (1542-1591), a Spanish mystic, whose family name was Yepes, was born at Ontiveros, in Old Castile. He took the vows at twenty-one, and soon became the faithful and ardent follower of Santa Teresa in her plans for the reform of the Carmelite order, to which he belonged. His zeal drew upon him the wrath of his brethren, through whose influence he was imprisoned for nine months. His release was procured by Santa Teresa, under whom he worked with fervent devotion for many years; but in 1591, having ventured to oppose his superiors, he was sent to a monastery in the Sierra Morena. His health, however, gave way, and he was allowed to change his residence to the monastery of Ubeda, where he died in 1591. In 1675 he was beatified, and in 1726 he

*Eust. i. 57*). Tunnels, or galleries excavated in the living rock, were also called *cryptæ*. Thus the tunnel to the north of Naples, through which the road passes to Puteoli, familiar to tourists as the "Grotto of Posilipo," was originally designated *crypta Neapolitana* (*Seneca, Epist. 57*). In early Christian times *cryptæ* was appropriately employed for the galleries of a catacomb, or for the catacomb itself. Jerome calls them by this name when describing his visits to them as a schoolboy, and the term is used by Prudentius (*CATACOMBS*).

A crypt, as a portion of a church, had its origin in the subterranean chapels known as "confessiones," erected around the tomb of a martyr, or the place of his martyrdom. This is the origin of the spacious crypts, some of which may be called subterranean churches, of the Roman churches of St. Prisca, St. Prassede, St. Martino ai Monti, St. Lorenzo fuori le Mura, and above all of St. Peter's,—the crypt being thus the germ of the church or basilica subsequently erected above the hallowed spot. When the martyr's tomb was sunk in the surface of the ground, and not placed in a catacomb chapel, the original memorial-shrine would be only partially below the surface, and consequently the part of the church erected over it, which was always that containing the altar, would be elevated some height above the ground, and be approached by flights of steps. This fashion of raising the chancel or altar end of a church on a crypt was widely imitated long after the reason for adopting it ceased, and even where it never existed. The crypt under the altar at the basilica of St. Maria Maggiore in Rome is merely imitative, and the same may be said of many of the crypts of our early churches in England. The original Saxon cathedral of Canterbury had a crypt beneath the eastern apse, containing the so-called body of St. Dunstan, and other relics, "fabricated," according to Eadmer, "in the likeness of the confessional of St. Peter at Rome" (*BASILICA*). St. Wilfrid constructed crypts still existing beneath the churches erected by him at the latter part of the 7th century at Hexham and Ripon. These are peculiarly interesting from their similarity in form and arrangement to the catacomb chapels with which Wilfrid must have become familiar during his residence in Rome. The cathedral, begun by Æthelwold and finished by Elphege at Winchester, at the end of the 10th century, had spacious crypts "supporting the holy altar and the venerable relics of the saints" (*Wulstan, Life of St. Æthelwold*), and they appear to have been common in the earlier churches in England. The arrangement was adopted by the Norman builders of the 11th and 12th centuries, and though far from universal, is found in many of the cathedrals of that date. The object of the construction of these crypts was twofold,—to give the altar sufficient elevation to enable those below to witness the sacred mysteries, and to provide a place of burial for those holy men whose relics were the church's most precious possession. But the crypt was "a foreign fashion" derived, as has been said, from Rome, "which failed to take root in England, and indeed elsewhere, barely outlasted the Romanesque period" (*Essays on Cathedrals*, p. 331). Of the crypts beneath our Norman cathedrals, that under the choir of Canterbury is by far the largest and most elaborate in its arrangements. It is, in fact, a subterranean church of vast size and considerable altitude, and in consequence of the elevation of the floor of the upper church is scarcely, if at all, below the level of the soil, and is therefore fairly well lighted. The whole crypt was dedicated to the Virgin Mary, and contained two chapels especially dedicated to her,—the central one beneath the high altar, enclosed with rich Gothic screenwork, and one under the south transept. This latter chapel was appropriated by Queen Elizabeth to the use of the French Huguenot refugees who had settled at Canterbury in the time of Edward VI. There were also in this crypt a large number of altars and chapels of other saints, some of whose hallowed bodies were buried here. At the extreme east end, beneath the Trinity Chapel, the body of St. Thomas (Becket) was buried the day after his martyrdom, and lay there till his translation, July 7, 1220. The cathedrals of Winchester, Worcester, and Gloucester have crypts of slightly earlier date (they may all be placed between 1080 and 1100), but of similar character, though less elaborate. They all contain piscinas and other evidences of the existence of altars in considerable numbers. They are all apical. The most picturesque is that of Worcester, the work of Bishop Wulstan (1084), which is remarkable for the multiplicity of small pillars supporting its radiating vaults.

Instead of having the air of a sepulchral vault like those of Winchester and Gloucester, this crypt is, in Professor Willis's words, "a complex and beautiful temple." Archbishop Roger's crypt at York, belonging to the next century (1154–1181), was filled up with earth when the present choir was built at the end of the 14th century, and its existence forgotten till its disinterment after the fire of 1829. The choir and presbytery at Rochester are supported by an extensive crypt, of which the western portion is Gundulf's work (1076–1107), but the eastern part, which displays slender cylindrical and octagonal shafts with light vaulting springing from them, is of the same period as the superstructure, the first years of the 13th century. This crypt, and that beneath the Early English Lady Chapel at Hereford, are the latest of our existing cathedral crypts. That at Hereford was rendered necessary by the fall of the ground, and is an exceptional case. Later than any of these crypts was that of St. Paul's, London. This was a really large and magnificent church of Decorated date, with a vaulted roof of rich and intricate character resting on a forest of clustered columns. Part of it served as a parish church of St. Faith. A still more exquisite work of the Decorated period is the crypt of St. Stephen's chapel at Westminster, than which it is difficult to conceive anything more perfect in design or more elaborate in ornamentation. Having happily escaped the conflagration of the Houses of Parliament in 1834—before which it was degraded to the purpose of the Speaker's state dining-room—it has been restored to its former sumptuousness of decoration, and is now one of the most beautiful architectural gems in England.

Of Scottish cathedrals the only one that possesses a crypt is the cathedral of Glasgow, rendered celebrated by Sir Walter Scott in his novel of *Rob Roy* (ch. xx.). At the supposed date of the tale, and, indeed, till a comparatively recent period, this crypt was used as a place of worship by one of the three congregations among which the cathedral was partitioned, and was known as "the Laigh or Barony Kirk." It extends beneath the choir transepts and chapter-house; in consequence of the steep declivity on which the cathedral stands it is of unusual height and lightsomeness. It belongs to the 13th century, its style corresponding to our Early English, and is simply constructional, the building being adapted to the locality. In architectural beauty it is quite unequalled by any crypt in the United Kingdom, and can hardly anywhere be surpassed. It is an unusually rich example of the style, the clustered piers and groining being exquisite in design and admirable in execution. The bosses of the roof and capitals of the piers are very elaborate, and the doors are much enriched with foliage. "There is a solidity in its architecture, a richness in its vaulting, and a variety of perspective in the spacing of its pillars, which make it one of the most perfect pieces of architecture in these kingdoms" (*Ferguson*). The care that is taken of this beautiful architectural gem, and the lavish outlay with which its windows have been decorated with stained glass, are a gratifying proof that the citizens of Glasgow fully appreciate the treasure they possess. In the centre of the main alley stands the mutilated effigy of St. Mungo, the patron saint of Glasgow, and at the south-east corner is a well called after the same saint.

Crypts under parish churches are not very uncommon in England, but they are usually small and not characterized by any architectural beauty. A few of the earlier crypts, however, deserve notice. One of the earliest and most remarkable is that of the church of Lastingham near Pickering in Yorkshire, on the site of the monastery founded in 648 by Cedd, bishop of the East Anglians. The existing crypt, though exceedingly rude in structure, is of considerably later date than Bishop Cedd, forming part of the church erected by Abbot Stephen of Whithy in 1080, when he had been driven inland by the incursions of the northern pirates. This crypt is remarkable from its extending under the nave as well as the chancel of the upper church, the plan of which it accurately reproduces, with the exception of the westernmost bay. It forms a nave with side aisles of three bays, and an apsidal chancel, lighted by narrow deeply splayed slits. The roof of quadripartite vaulting is supported by four very dwarf thick cylindrical columns, the capitals of which and of the responds are clumsy imitations of classical work with rude volutes. Still more curious is the crypt beneath the chancel of the church of Repton in Derbyshire. This also consists of a centre and side aisles, divided by three arches

on either side. The architectural character, however, is very different from that at Lastingham, and is in some respects almost unique, the piers being slender, and some of them of a singular spiral form, with a bead running in the sunken part of the spiral. Another very extensive and curious Norman crypt is that beneath the chancel of St. Peter's-in-the-East at Oxford. This is five bays in length, the quadripartite vaulting being supported by eight low, somewhat slender, cylindrical columns with capitals bearing grotesque animal and human subjects. Its dimensions are 36 by 20 feet and 10 feet in height. This crypt has been commonly attributed to Grymboldt in the 9th century; but it is really not very early Norman. Under the church of St. Mary-le-Bow in London there is an interesting Norman crypt not very dissimilar in character to that last described. Of a later date is the remarkably fine Early English crypt groined in stone, beneath the chancel of Hythe in Kent, containing a remarkable collection of skulls and bones, the history of which is quite uncertain. There is also a Decorated crypt beneath the chancel at Wimborne Minster, and one of the same date beneath the southern chancel aisle at Grantham.

Among the more remarkable French crypts may be mentioned those of the cathedrals of Auxerre, said to date from the original foundation in 1085; of Bayeux, attributed to Odo, bishop of that see, uterine brother of William the Conqueror, where twelve columns with rude capitals support a vaulted roof; of Chartres, running under the choir and its aisles, frequently assigned to Bishop Fulbert in 1029, but more probably coeval with the superstructure; and of Bourges, where the crypt is in the Pointed style, extending beneath the choir. The church of the Holy Trinity attached to Queen Matilda's foundation—the "Abbaye aux Dames" at Caen—has a Norman crypt where the thirty-four pillars are as closely set as those at Worcester. The church of St. Eutropius at Saintes has also a crypt of the 11th century, of very large dimensions, which deserves special notice; the capitals of the columns exhibit very curious carvings. Earlier than any already mentioned is that of St. Gervase of Rouen, considered by Mr. E. A. Freeman "the oldest ecclesiastical work to be seen north of the Alps." It is apsidal, and in its walls are layers of Roman brick. It is said to contain the remains of two of the earliest apostles of Gaul—St. Mellon and St. Avitians.

Space forbids our particularizing the numerous crypts of Germany. One at Göttingen may be mentioned, where cylindrical shafts with capitals of singular design support "vaulting of great elegance and lightness" (Fergusson), the curves being those of a horseshoe arch. The crypts of the cathedrals or churches at Halberstadt, Hildersheim, and Naumburg, also deserve to be noticed; that of Lubeck may be rather called a lower choir. It is 20 feet high and vaulted.

The Italian crypts, when found, as a rule reproduce the "confessio" of the primitive churches. That beneath the chancel of St. Michele at Pavia is an excellent typical example, probably dating from the 10th century. It is apsidal and vaulted, and is seven bays in length. That at St. Zenò at Verona (c. 1138) is still more remarkable; its vaulted roof is upborne by forty columns, with curiously carved capitals. It is approached from the west by a double flight of steps, and contains many ancient monuments. St. Miniato at Florence, begun in 1013, has a very spacious crypt at the east end, forming virtually a second choir. It is seven bays in length and vaulted. The most remarkable crypt in Italy, however, is perhaps that of St. Mark's, Venice. The plan of this is almost a Greek cross. Four rows of nine columns each run from end to end, and two rows of three each occupy the arms of the cross, supporting low stunted arches on which rests the pavement of the church above. This also constitutes a lower church, containing a *chorus cantorum* formed by a low stone screen, not unlike that of St. Clement at Rome (see *BASILICA*, vol. iii. p. 360), inclosing a massive stone altar with four low columns. This crypt is reasonably supposed to belong to the church founded by the doge P. Orseolo in 977. There are also crypts deserving notice at the cathedrals of Brescia, Fiesole, and Modena, and the churches of St. Ambrogio and St. Eustorgio at Milan. The former was unfortunately modernized by St. Charles Borromeo. The crypt at Assisi is really a second church at a lower level, and being built on the steep side of a hill is

well lighted. The whole fabric is a beautiful specimen of Italian Gothic, and both the lower and upper churches are covered with rich frescoes. The crypts at Rome have been already mentioned.

Domestic crypts are of frequent occurrence. Mediæval houses had as a rule their chief rooms raised above the level of the ground upon vaulted substructures, which were used as cellars and store-rooms. These were sometimes partially underground, sometimes entirely above it. The underground vaults often remain when all the superstructure has been swept away, and from their Gothic character are frequently mistaken for ecclesiastical buildings. All our older towns are full of crypts of this character, now used as cellars. They occur in Oxford and Rochester, are very abundant in the older parts of Bristol, and, according to Mr. Parker, "nearly the whole city of Chester is built upon a series of them with the Rows or passages made on the top of the vaults" (*Domestic Architecture*, iii. p. 91). The crypt of Gerard's Hall in London, destroyed in the construction of New Cannon Street, figured by Mr. Parker (*Dom. Arch.*, ii. 185), was a very beautiful example of the lower story of the residence of a wealthy merchant of the time of Edward I. It was divided down the middle by a row of four slender cylindrical columns supporting a very graceful vault. The finest example of a secular crypt now remaining in England is that beneath the Guildhall of London. The date of this is early in the 15th century, 1411. It is a large and lofty apartment, divided into four aisles by two rows of clustered shafts supporting a rich lierne vault with ribs of considerable intricacy. There is a fine vaulted crypt of the same date and of similar character beneath St. Mary's Hall, the Guildhall of the city of Coventry. (E. V.)

CRYPTOGRAPHY (from *κρυπτεω*, to hide), or writing in cipher (from Arabic *cifr*, empty, void), called also steganography (from *στεγανη*, a covering), is the art of writing messages, etc., in such a way as to be understood by those only who possess the key to the character employed. The unravelling of the writing is called deciphering. Cryptography having become a distinct art, Bacon classed it (under the name *ciphers*) as a part of grammar. Secret modes of communication have been in use from the earliest times. The Lacedæmonians, according to Plutarch, had a method which has been called the *scytale*, from the staff (*σκυτάλη*) employed in constructing and deciphering the message. When the Spartan ephors wished to forward their orders to their commanders abroad, they would slantwise a narrow strip of parchment upon the *σκυτάλη* so that the edges met close together, and the message was then added in such a way that the centre of the line of writing was on the edges of the parchment. When unwound the scroll consisted of broken letters; and in that condition it was despatched to its destination, the general to whose hands it came deciphering it by means of a *σκυτάλη* exactly corresponding to that used by the ephors. Polybius has enumerated other methods of cryptography.

The art was in use also amongst the Romans. Upon the revival of letters methods of secret correspondence were introduced into private business, diplomacy, plots, etc.; and as the study of this art has always presented attractions to the ingenious, a curious body of literature has been the result.

John Trithemius, the abbot of Spanheim, was the first important writer on cryptography. His *Polygraphia*, published in 1500, has passed through many editions, and has supplied the basis upon which subsequent writers have worked. It was begun at the desire of the duke of Bavaria; but Trithemius did not at first intend to publish it, on the ground that it would be injurious to public interests. The next treatises of importance were those of John Baptist Porta, a Neapolitan mathematician, who wrote *De furibus literarum notis*, 1563; and of Blaise de Vigenère, whose *Traité des chiffres* appeared in Paris, 1587. Lord Verulam proposed an ingenious system of cryptography on the plan of what is called the double cypher; but while thus lending to the art the influence of his great name, he gave an intimation as to the general opinion formed of it and as to the classes of men who used it; for when prosecuting the earl of Somerset in the matter of the poisoning of Overbury, he urged it as an aggravation of the crime that the earl and Overbury "had cyphers and jargons for the king and queen and all the great men,—things seldom

used but either by princes and their ambassadors and ministers, or by such as work or practise against, or at least upon, princes." Other eminent Englishmen were afterwards connected with the art. John Wilkins, subsequently bishop of Chester, published in 1641 an anonymous treatise entitled, *Mercury, or the Secret and Swift Messenger*,—a small but comprehensive work on the subject, and a timely gift to the diplomatists and leaders of the civil war. The deciphering of many of the royalist papers of that period, such as the letters that fell into the hands of the Parliament at the battle of Naseby, has by Henry Stubbe been charged on the celebrated mathematician Dr. John Wallis (*Athen. Oxon.*, iii., 1072), whose connection with the subject of cipher-writing is referred to by himself in the Oxford edition of his mathematical works, 1689, page 659; as also by John Davys. Dr. Wallis elsewhere states that this art, formerly scarcely known to any but the secretaries of princes, etc., had grown very common and familiar during the civil commotions, "so that now there is scarce a person of quality but is more or less acquainted with it, and doth, as there is occasion, make use of it." Subsequent writers on the subject are John Falconer (*Cryptomenysis Patetfacta*), 1685; John Davys (*An Essay on the Art of Decyphering, in which is inserted a Discourse of Dr. Wallis*), 1737; Philip Thicknesse (*A Treatise on the Art of Decyphering and of Writing in Cypher*), 1772; William Blair (the writer of the comprehensive article "Cipher" in Rees's *Cyclopaedia*), 1819; and G. von Marten (*Cours Diplomatique*), 1801 (a fourth edition of which appeared in 1851). Perhaps the best modern work on this subject is the *Kryptographik* of J. L. Klüber (Tübingen, 1809), who was drawn into the investigation by inclination and official circumstances. In this work the different methods of cryptography are classified. Amongst others of lesser merit who have treated on this art may be named Gustavus Selenus (i. e., Augustus, duke of Brunswick), 1624; Cospi, translated by Nicéron in 1641; the marquis of Worcester, 1659; Kircher, 1663; Schott, 1665; Hiller, 1682; Comiers, 1690; Baring, 1737; Conrad, 1739, etc.

Schemes of cryptography are endless in their variety. Bacon lays down the following as the "virtues" to be looked for in them: "that they be not laborious to write and read; that they be impossible to decipher; and, in some cases, that they be without suspicion." These principles are more or less disregarded by all the modes that have been advanced, including that of Bacon himself, which has been unduly extolled by his admirers as "one of the most ingenious methods of writing in cypher, and the most difficult to be decyphered, of any yet contrived" (Thicknesse, p. 13).

The simplest and commonest of all the ciphers is that in which the writer selects, in place of the proper letters, certain other letters in regular advance. This method of transposition was used by Julius Cæsar. He "per quartam elementorum literam," wrote *d* for *a*, *e* for *b*, and so on. There are instances of this arrangement in the Jewish rabbin, and even in the sacred writers. An illustration of it occurs in Jeremiah xxv. 26, where the prophet, to conceal the meaning of his prediction from all but the initiated, writes *Shebakh* instead of Babel (Babylon), the place meant; i. e., in place of using the second and twelfth letters of the Hebrew alphabet (*b, b, l*) from the beginning, he wrote the second and twelfth (*sh, sh, ch*) from the end. To this kind of cipher-writing Buxtorf gives the name *Athbash* (from *a*, the first letter of the Hebrew alphabet, and *h*, the last; *b*, the second from the beginning, and *h* the second from the end). Another Jewish cabalism of like nature was called *Albam*; of which an example is in Isaiah vii. 6, where *Tabeal* is written for *Remaliah*. In its adaptation to English this method of transposition, of which there are many modifications, is comparatively easy to decipher. A rough key may be derived from an examination of the respective quantities of letters in a typefounder's bill, or a printer's "case." The decipherer's first business is to classify the letters of the secret message in the order of their frequency. The letter that occurs oftenest is *e*, and the next in order of frequency is *t*. The following groups come after these, separated from each other by degrees of decreasing recurrence: *a, o, n, i*; *r, s, h, d, l, c, w, u, m*; *f, y, g, p, b*; *v, k*; *x, q, j, z*. All the single letters must be *a, l, or O*. Letters occurring together are *ee, oo, ff, ll, ss*, etc. The commonest words of two letters are (roughly arranged in the order of their frequency) of,

*to, in, it, is, be, he, by, or, as, at, an, so*, etc. The commonest words of three letters are *the* and *and* (in great excess), *for, are, but, all, not*, etc.; and of four letters, *was, with, from, have, this, they*, etc. Familiarity with the composition of the language will suggest numerous other points that are of value to the decipherer. He may obtain other hints from Poe's tale called *The Gold Bug*. As to messages in the Continental languages constructed upon this system of transposition, rules for deciphering may be derived from Breithaupt's *Ars deciftratoria*, 1737, and other treatises.

Bacon remarks that though ciphers were commonly in letters and alphabets, yet they might be in words. Upon this basis codes have been constructed, classified words taken from dictionaries being made to represent complete ideas. In recent years such codes have been adapted by merchants and others to communications by telegraph, and have served the purpose not only of keeping business affairs private, but also of reducing the excessive cost of telegraphic messages to distant markets. Obviously this class of ciphers presents greater difficulties to the skill of the decipherer.

Figures and other characters have been also used as letters; and with them ranges of numerals have been combined as the representatives of syllables, parts of words, words themselves, and complete phrases. Under this head must be placed the despatches of Giovanni Michael, the Venetian ambassador to England in the reign of Queen Mary,—documents which have only of late years been deciphered. Many of the private letters and papers from the pen of Charles I. and his queen, who were adepts in the use of ciphers, are of the same description. One of that monarch's letters, a document of considerable interest, consisting entirely of numerals purposely complicated, was in 1858 deciphered by Professor Wheatstone, the inventor of the ingenious crypto-machine, and printed by the Philobiblon Society. Other letters of the like character have been published in the *First Report of the Royal Commission on Historical Manuscripts*, 1870. In the second and subsequent reports of the same commission, several keys to ciphers have been catalogued, which seem to refer themselves to the methods of cryptography under notice. In this connection also should be mentioned the "characters" which the diarist Peyps drew up when clerk to Sir George Downing and secretary to the earl of Sandwich and to the Admiralty, and which are frequently mentioned in his journal. Peyps describes one of them as "a great large character," over which he spent much time, but which was at length finished 25th April, 1660; "it being," says he, "very handsomely done and a very good one in itself, but that not truly alphabetical."

Shorthand marks and other arbitrary characters have also been largely imported into cryptographic systems to represent both letters and words, but more commonly the latter. This plan is said to have been first put into use by the old Roman poet Ennius. It formed the basis of the method of Cicero's freedman, Tiro, who seems to have systematized the labors of his predecessors. A large quantity of these characters have been engraved in Gruter's *Inscriptiones*. The correspondence of Charlemagne was in part made up of marks of this nature. In Rees's *Cyclopaedia* specimens were engraved of the cipher used by Cardinal Wolsey at the court of Vienna in 1524, of that used by Sir Thomas Smith at Paris in 1563, and of that of Sir Edward Strafford at Madrid in 1586; in all of which arbitrary marks are introduced. The first English system of shorthand—Bright's *Characteris*, 1588—almost belongs to the same category of ciphers. A favorite system of Charles I., used by him during the year 1646, was one made up of an alphabet of twenty-four letters, which were represented by four simple strokes varied in length, slope, and position. This alphabet is engraved in Clive's *Linear System of Shorthand*, 1830, having been found amongst the royal manuscripts in the British Museum. An interest attaches to this cipher from the fact that it was employed in the well-known letter addressed by the king to the earl of Glamorgan, in which the former made concessions to the Roman Catholics of Ireland.

Complications have been introduced into ciphers by the employment of "dummy" letters,—"nulls and insignificant," as Bacon terms them. Other devices have been introduced to perplex the decipherer, such as spelling words backwards, making false divisions between words,

etc. The greatest security against the decipherer has been found in the use of elaborate tables of letters, arranged in the form of the multiplication table, the message being constructed by the aid of preconcerted key-words. Details of the working of these ciphers may be found in the treatises named in this article. The deciphering of them is one of the most difficult of tasks. A method of this kind is explained in the Latin and English lives of Dr. John Barwick, whose correspondence with Hyde, afterwards earl of Clarendon, was carried on in cryptography. In a letter dated 20th February, 1659-60, Hyde, alluding to the skill of his political opponents in deciphering, says that "nobody needs to fear them, if they write carefully in good cyphers." In his next he allays his correspondent's apprehensiveness as to the deciphering of their letters:—

"I confess to you, as I am sure no copy could be gotten of any of my cyphers from hence, so I did not think it probable that they could be got on your side the water. But I was as confident, till you tell me you believe it, that the devil himself cannot decypher a letter that is well written, or find that 100 stands for Sir H. Vane. I have heard of many of the pretenders to that skill, and have spoken with some of them, but have found them all to be mountebanks; nor did I ever hear that more of the King's letters that were found at Naseby, than those which they found decyphered, or found the cyphers in which they were writ, were decyphered. And I very well remember that in the volume they published there was much left in cypher which could not be understood, and which I believe they would have explained if it had been in their power."

An excellent modification of the key-word principle was constructed by the late Admiral Sir Francis Beaufort; it has been recently published in view of its adaptation to telegrams and post-cards.

Ciphers have been constructed on the principle of altering the places of the letters without changing their powers. The message is first written Chinese-wise, upward and downward, and the letters are then combined in given rows from left to right. In the celebrated cipher used by the earl of Argyle when plotting against James II., he altered the positions of the words. Sentences of an indifferent nature were constructed, but the real meaning of the message was to be gathered from words placed at certain intervals. This method, which is connected with the name of Cardan, is sometimes called the *trellis* or *cardboard* cipher.

The wheel-cipher, which is an Italian invention, the string-cipher, the circle-cipher, and many others are fully explained, with the necessary diagrams, in the authorities named above,—more particularly by Klüber in his *Kryptographik*. (J. E. B.)

**CRYSTALLOGRAPHY.** When water containing saline matter in solution is allowed to evaporate slowly, the salt it contains is thrown down in bodies of peculiar forms, bounded by smooth, even surfaces meeting in straight lines. Fused metals consolidating in certain favorable conditions appear as similar bodies. And in nature, also, in cracks or fissures of the rocks, or embedded in their mass, minerals resembling these in form are frequently found. These regular polyhedral, or many-sided bodies, whether

**Definition of crystals.** natural or artificial, are named crystals, and the science naming and describing the forms they assume, and pointing out the relations that exist among them, is termed crystallography. In a theoretical point of view this science may be regarded as a branch of mathematics, and might be studied independent altogether of the fact of any material bodies existing in the forms described. Practically, however, its chief interest and value is as a means of distinguishing many salts, ores, and other substances, either formed artificially or, more especially, occurring naturally as minerals. At present no particular system of crystallography has found general acceptance, and referring for the details of the one adopted in the description of mineral species to **MINERALOGY**, we propose in this place to give an account of the history of the science, pointing out the more remarkable steps in its progress, the chief general results attained, and some of the best works from which further information in regard to it may be obtained.

The term crystal, found in most modern European languages, is derived from the Greek word *κρυσταλλος*, meaning ice or frozen water, and subsequently transferred to pure transparent stones cut into seals, and, as was thought, only produced in the extreme cold of the lofty passes of the Alps. Pliny, who notices this rock-crystal in his *Natural History* (book

xxxvii.), points out clearly enough the hexagonal form of the crystals, remarking that it is not easy to give any reason why they grow in this form, more especially as the points have not the same appearance (*ea magis quod neque mucronibus eadem species est*), and the polish of the sides is such that no art can equal it. The forms of other minerals are also noticed by him, but the term crystal still had regard to the ice-like transparency and purity of the stone, a reference entirely lost in the modern scientific use of the word.

It is not wonderful that these bodies, often so remarkable for the beauty of their forms, colors, and other physical properties, attracted considerable attention even in the so-called dark ages. But these notices rather amuse us by their quaint absurdity, as we should now regard it, than throw light on the progress of the science. Thus Albertus Magnus in the middle of the 13th century tells how the cold in the lofty mountains makes the ice so dry that it congeals into crystal (*ex illo sicco coagulat glaciem in crystallum*). Agricola, three centuries later, knew little more, though affirming that *crystallus* was not ice but rather *succus frigore densatus*. Still he indicates some simple forms of crystals, and notes the fissile structure of some stones, as the *lapis specularis* (probably gypsum or mica), a property which as cleavage soon exercised much influence. Nicolaus Steno, the Dane, born in 1638 at Copenhagen, but for a time resident at Florence, amidst his well-known studies in anatomy, found leisure also to speculate on questions concerning the structure of the earth and the nature of gems and precious stones. As his treatise *De solido intra solidum naturaliter contento*, published in 1669, anticipated in geology some modern speculations and theories subsequently confirmed, so it also contains the germs of important facts in crystallography. It was still the wondrous rock-crystal with the polished sides of the middle prism and the terminal points of the pyramids, joined by the central axis of the crystal, that formed the starting-point of his speculations, and led him to introduce some new notions and terms into the science. How these crystals originated was doubtful, but they evidently grew, not from within like plants, but from without, by the addition of new layers of minute particles carried to the crystal by a fluid, and laid down specially at the ends, as shown by the fine striae that are never wanting on the middle planes. His rejection of extreme cold as the *causa efficiens*, for something similar to magnetic power, is again a suggestive idea, and not less his conclusion that crystals therefore were not formed only at the first beginning of things, but continue to grow even at the present day. Still more important as a step in the progress of the science would be his assertion that the number and length of the sides in the plane of the axis may vary widely without change in the angles (*in plano axis, laterum et longitudinum varis mutari non mutatis angulis*), could we regard it as having a wider application than to the case in hand. It was perhaps more a deduction from the mathematical form of the body than a generalization from observed facts. But some of his other descriptions show great powers of observation, and in his notice of the cleavage of calcespar, and its division into other rhomboidal bodies, we have again a fact that in other hands was to bear important fruits.

Erasmus Bartholinus, another Dane (born 1625, died 1698), made known, in his *Experimenta Crystallic Islandici diadactylastici* (1670), another property of the same mineral, very remarkable in itself and its results to science. This was the double refraction of the beautifully transparent variety sent from the Rødeford in Iceland to Copenhagen. In the same tract, it may be mentioned in passing, occurs the first reference to the blowpipe as a means of applying heat to minerals. But the optical fact, turning the attention of mathematicians to crystals, had more direct influence on our science. The celebrated Huyghens described the same *miranda refractio*, and pointed out its laws; he also measured the angles of the rhomboids with a close approximation to truth, and remarked the occurrence of a less distinct double refraction in quartz—in *crystallo duplex est refractio*. He likewise observed the peculiar cleavage of calcespar, which he tried to explain by building up the crystals of spheroids. Leeuwenhoek also, in his *Aranea Naturæ* (1695), mentions cleavage in gypsum and Muscovy glass, and tried to estimate the thickness of the laminae, which Newton in his *Optics* in 1706 showed could be cal-

Early history of science.

culated from his doctrine of the color of thin plates. In the same work Newton gives an account of the double refraction of Iceland spar and the laws it follows, and, observing the changes to which the rays were subject, asks if these rays of light may not have different sides, with different properties—the first anticipation of the polarization of light, so important in this science. Returning to Leeuwenhoek, we find him showing salts of various forms, growing up in solutions under his microscopes. About this time too Guglielmini in his treatise on these bodies, *De Solidis Dissertatio Epistolaris* (1707), tried to prove that they could all be divided into molecules of a few regular forms, and affirms as a consequence that the inclination of the planes and angles is always constant. At a somewhat earlier period the celebrated Robert Boyle had published a treatise on precious stones, in which he describes many properties of crystals and their peculiar forms which he compares to those of salts. He also pointed out the crystallization of bismuth from fusion by heat—a fact often overlooked by later observers.

The attention of men of science was now thoroughly directed to the forms and origin of these bodies, and many curious observations might be collected from the writings of De la Hire, Woodward, Cappeller, Henckel, and others.

But we pass on to Linnæus, whose *Systema Naturæ* formed, in this as in other departments of natural science, the commencement of a new period in its history. In his first edition in 1736 he gave a classification which, as he says himself, though far from perfect and often blamed, had enabled others mounted on his shoulders to see wider. Some of these successors he enumerates in the twelfth edition of his *System* (1768)—among them Wallerius, Swab, and Cronstedt. He admits in the preface that he had laid aside the study of stones in which he once delighted, and therefore could not boast of his knowledge of lithology. *Lithologia mihi cristas non eriget, lapides enim quos quondam in deliciis habui, tradita demum alius disciplina, seposui*, are his characteristic words. Still there is much that was important in his work. Thus he distinguishes figured stones from those that are amorphous, and notes the difference of the *tessellata* or cubical from the *prisma* or long columnar and the *pyramis* or pointed forms. Then he figures rudely, it may be, and describes some forty common forms of crystals, and gives examples of minerals in which they occur. His table of "*Affinitates crystallorum*" is even more suggestive, and could scarcely fail, if followed out, to lead to further advances. The use he made of these forms as important characters in describing and classifying minerals was well calculated to promote their study. Even the fact that he cut out models in wood of the forms he saw, shows in what a truly practical manner he regarded the subject. His notions regarding the formation of crystals were, however, very imperfect. Salt, he affirms, is the only known natural cause of crystallization, and consequently the forms of the crystals of other substances were determined by the salts in union with them. This is the more remarkable, as he refers to an anonymous author in his own country, to whom he applies the words of Isaac, *rex Swebii, manus Cronstedti*, as refuting this theory from the fact that crystals of metals were produced by fusion.

The advanced character of these views of Linnæus appears more strongly when we contrast them with those of his great rival Buffon. According to him crystals are only a result of organization, so that the prisms of rock crystal, the rhombs of calcspar, the cubes of sea salt, the needles of nitre, and others are produced by the motions of organic molecules, and especially of those derived from the remains of animals and plants found in calcareous masses, and in the layer of vegetable earth covering the surface of the globe. Hence he takes no note of crystallization among the characters of minerals. Very different was the influence of Linnæus on Romé Delisle (born 1736, died 1790), whose *Essai de Cristallographie* appeared first in 1772, and in an enlarged form in 1783. Working in the spirit of his master, he formed a large collection of mineral crystals which he examined with great care, comparing the forms of the faces and measuring the angles. In doing this he soon found that the same mineral assumed various forms,—calcspars, for instance, sometimes that of a six-sided prism, at others of a rhomboid, and fluor-spar in some cases forming cubes, in others octahedrons. In trying to explain this fact, he assumed that in each species there was a certain original form, generally the most simple he could find,

from which all the others might be derived when cut in a particular manner. "Thus by cutting off the angles of the cube, it may be converted into an octahedron. Werner in his treatise *On the External Character of Minerals* had used the terms, truncation, bevelling, acumination (*Abetumpfung, Zuschärfung, Zuspitzung*) for similar changes on the fundamental forms, but Delisle probably had no knowledge of this fact, and in other respects could borrow little from Werner, who in Crystallography scarce went beyond Linnæus. The progress Delisle made in the ten years between his first and second work (*Cristallographie ou Description des formes propre à tous les corps du règne minéral*, 1783) is truly remarkable. He now affirms in clear and distinct terms "that amidst all the innumerable variations of which the primitive form of a salt or crystal is susceptible, there is one thing that never varies and remains constantly the same in each species,—that is, the angle of incidence, or the respective inclination of the faces to each other." Hence these angles are truly characteristic of each species, but only of the primitive forms, from which others, which he names secondary, are derived by various modifications. Of these principal primitive forms he assumes six; but these are less skilfully chosen and, as now seen, not always truly distinct. But many defects were compensated for by the great labor he expended on figuring and his superior accuracy in measuring crystals. This he was able to secure by the use of the goniometer recently invented by Carangeau, the new instrument, as it were, transforming the science. Then his observation of twin crystals, or macles, as he named them,—which he showed were characterized by their re-entering angles as made up of two crystals, or two halves of one crystal, in a reversed position,—was also a noteworthy step. How much he accomplished may be judged from the fact that he gives figures of more than 500 regular forms, in place of the forty described by Linnæus. He had probably carried his system as far as it could go, and not merely familiarized the forms of crystals to mineralogists, but also suggested the possible connections that might exist among them.

Delisle seems to have assigned little value to Bergman's cleavage, and in his preface speaks contemptuously of the crystalloclastes (*brise-cristaux*) as innovators in the science. But even earlier, in 1773, Bergman, the well-known Swedish chemist, had shown its importance, and used this peculiar structure to explain the relations of the different forms of crystals observed in the same mineral. Starting from the rhombohedron of calcspars, he placed it with the chief axis upright, and then building up other similar rhombs on it, formed a six-sided prism with rhombic ends. By stopping at a certain stage it became a dodecahedron, or body with twelve rhombic faces, which he assumed, not quite accurately, to be the same as that proper to garnet. Again, placing this garnet form in proper position and adding other rhombs, he showed how it easily changed into another characteristic of the hyacinth (*in aliam facile migrat*), whilst by other changes different crystals were produced. But he did not proceed far in the direction thus indicated, and deeper views, with more accurate facts and measurements, were required before this could be done.

These were found in the works of René Just Haüy (born 1743, died 1822), who seems to have been led almost by accident to his theory. Curiously it is still the same mineral that with him, as with so many of his predecessors, forms the starting point. When looking over the cabinet of Citizen DeFrance a hexahedral prism of calcspars was accidentally broken from a group to which it belonged, and given him in a present. This crystal showed at the base, where it had been detached, a broken corner with the peculiar brilliant lustre, "*poli de la Nature*," of the cleavage faces. Haüy's attention was arrested by the fact, and he tried to obtain similar faces on other corners, but he only succeeded on the three alternate edges at each end of the prism. Continuing the process further, he found that he could remove slice after slice, till no vestige of the original prism was left, but in place of it a rhomboid perfectly similar to the Iceland spar and lying in the middle of the prism. The fact struck him with surprise, mingled with the hope that it was not isolated, and this, he says, served to "develop my ideas regarding the structure of crystals, and has been, as it were, the key of the theory" (*et a été comme la clef de la théorie*). Following it out on differently formed crystals of this mineral he found they could all be

reduced to a similar internal nucleus. But when the mineral was distinct the nucleus had a different form. Thus in fluor-spar the nucleus was an octahedron; in heavy spar a right prism with rhombic bases; in galena, or sulphate of lead, a cube; and so of other substances. In each also these forms were constant, relative to the entire species, so that its angles were subject to no appreciable variation. Even where crystals cannot be thus mechanically divided, Haüy stated that theory aided by certain indications might serve to discover the primitive form.

On these and other similar facts, Haüy erected his celebrated theory of the structure of crystals. In each mineral there exists what he calls its integrant molecules,—solid bodies incapable of further division and of invariable form, with faces parallel to the natural joints indicated by the mechanical division of the crystals, and with angles and dimensions given by calculation and observation combined. These molecules are marked in different species by distinct and determinate forms, except in a few regular bodies, such as the cube, which do not admit of variations. From these primitive or integrant molecules all the various crystals found in each species are built up according to certain definite laws, and thus the secondary crystals, as he names them, are produced. Of primitive forms only six were known from observation. These were the parallelepiped, the octahedron, the tetrahedron, the regular hexahedral prism, the dodecahedron with equal and similar rhombic faces, and the dodecahedron with triangular faces, consisting of two regular six-sided pyramids joined base to base. In order to produce these secondary crystals which covered over the primitive form, so as to disguise it in so many different ways, he supposed the enveloping matter to be made up of a series of laminae, each decreasing in extent either equally in all directions, or only at certain parts. This decrease takes place by the regular subtraction of one or several ranges of integrant molecules in each successive layer; and theory, determining by calculation the number of these ranges, can represent all the known results of crystallization, and even anticipate discoveries, and indicate hypothetical forms which may one day reward the research of naturalists. He thus claims for his theory that greatest proof of its truth and value which a scientific theory can present,—the power to anticipate observation and to foretell future discoveries. As an example of this process Haüy showed how by applying successive layers of integrant molecules, each less by one row all round, to the faces of the primitive cube, a rhombic dodecahedron was necessarily formed. In other cases he assumed that the decrease was not parallel to the edges, but took the angles as its point of departure, and thus was parallel to a diagonal. In the case above supposed the decrease took place by two ranges in breadth for one in height or thickness, but other less simple ratios might be supposed, as of two in breadth to three in height, and to these the name mixed decrements were given. There were other possible modes of decrease also distinguished, to which it is needless now to refer. But by these and other modes of procedure, Haüy showed how the various secondary crystals could arise from his assumed primitive forms or molecules.

The great advance secured by this theory of Haüy's was the firm establishment of the idea that the forms of crystals were not irregular or capricious, but definite and based on fixed and ascertainable laws. Hence he showed that, whilst certain secondary forms may be deduced from a given nucleus, there are other forms that cannot occur.

Further he pointed out what he named "the law of symmetry," in consequence of which, when any change of a crystal form took place by its combination with other forms, all similar parts—angles, edges, faces—were modified in the same way at the same time. All these changes too, he said, could be indicated by rational coefficients or commensurable numbers.

A not less important principle, which Haüy endeavored to establish, was the intimate relation of the crystalline form to the chemical composition of minerals, so that even prior to analysis the real diversity of species formerly conjoined might be inferred from differences in the angles. As an example of this may be mentioned his discovery of the difference of the angles in crystals classed together as "heavy spar," a difference only explained when Vauquelin showed that those with the larger angle from Sicily con-

tained the new earth strontia, discovered by Klaproth, instead of the baryta found in those from Derbyshire. The modifications which this view has had to undergo from wider observations will be noticed afterwards, but even its enunciation by Haüy formed a great stimulus to research both as to the forms and the composition of minerals. Taken in connection with the perspicuous and elegant style of his work, its clear arrangement and full illustration by figures, its influence on the progress of the science may be readily understood. Many deficiencies in his system are now easily seen, and some of the most fatal were soon brought to light by the very stimulus his works gave to the science.

Thus one of the first to criticise the system was Weiss, who translated Haüy's work into German in 1804. He not only pointed out that the primitive forms erred both in excess and defect, but struck deeper at the theory by showing that the integrant molecules might better be entirely laid aside. They were not wanted to explain the observed facts, and the so-called planes built up of them would not reflect the light. Bernhardt, a medical man in Erfurt, attacked the theory from other points of view. Thus he objected to the prisms which Haüy had chosen as primitive forms that their dimensions could not be determined from themselves, their height depending on another form, and therefore that octahedrons or double pyramids were preferable. Then he showed that various crystals were more readily explained from other forms than those taken as their primaries by Haüy, and that in the regular forms it was quite indifferent whether the cube or regular octahedron was chosen, whilst among the irregular forms other divisions might be established, more conformable to nature. It is needless to specify further criticisms on Haüy's theory, as its very merits soon led to its being replaced by more profound views. Thus the importance it ascribed to the angles of the faces and cleavages of crystals for the true determination of minerals formed a strong motive for their more accurate determination. The discovery also of the reflecting goniometer in 1809 by Wollaston (born 1766, died 1829) enabled this to be done with a degree of accuracy previously impossible. The writings of Dr. Wollaston himself, of Mr. Brooke, and especially the *Introduction to Mineralogy* (1816) of William Phillips (born 1773, died 1828) were specially rich in material of this kind. The influence of this accumulation of facts was shown less in the correction of Haüy's data than in the necessity it involved of some new and more workable theory for connecting the facts than that adopted by the French mineralogists.

For this science is chiefly indebted to Weiss, already mentioned as the translator and critic of Haüy's great work. Born at Leipsic in 1780, and educated in its university, where he began to teach in 1803, he inaugurated his appointment as ordinary professor of physics in 1808 by the publication the following year of a dissertation, *De indagando formarum crystallinarum characteribus geometrico principalibus*. In this he pointed out for the first time the importance of the axes of crystals, to which, however, Haüy had referred. "The axis," he says, "is truly the line governing every figure (*omnis figura dominatrix*) round which the whole is uniformly disposed. All the parts look to it, and by it they are bound together as by a common chain and mutual contact." But the axes are not mere geometric lines physically dead and powerless. It is in reference to them that the forces work which have formed the crystals. Hence the importance of the inclination of the faces to the axes as characterizing forms, and the simpler numbers by which the relations of these faces might be expressed. He further points out various distinctions in the forms of crystals, in which his followers have traced the germs of the systems of crystallization he subsequently established. This was done in his memoir, "Ueber die Darstellung der vertchiedenen natürlichen Abtheilungen der Krystallisationsysteme," published in 1815 in the *Transactions of the Academy of Berlin*, to which city he had been transferred in 1820. In this memoir the terms regular system, four-membered system, two-and-two-membered system, and others afterwards used first appear. In other memoirs in the same series, of which the more important were those on the crystallization of felspar, epidote, gypsum, and quartz, his views were more fully developed. Along with these views of the general relations of crystals Weiss also introduced important improvements in the mode of designating the faces of crystals, so

Criticisms of Haüy's system.

Weiss.



as to render it more easy to calculate their angles. Haüy had already done this in conformity to his theory of decrements, but the expressions were complex and the numbers large. But here as elsewhere, Weiss says, the mechanical atomistic views by which Haüy was led must be laid aside, in order to allow the ascertained knowledge of the mathematical laws and relations of crystalline structure to come out purely. Leaving out of view, therefore, the supposed primitive forms, and looking only to what was above and beyond them, Weiss referred all to the essential relations of the axes or the co-ordinates of the faces, and thus gave at once far more precision and simplicity to the symbols, and facilitated the necessary calculations.

It often happens in periods of intellectual activity that several inquirers are engaged on the same subject, and, following it out in similar directions, come to results that more or less coincide. Such seems to have been so far true in regard to crystallography, and these discoveries of Weiss have been claimed for Mohs. Born in the Hartz in 1773, he studied at Halle, turning his attention specially to mining. In 1812 he became professor in Grätz, and in 1818 succeeded Werner in Freiberg, which a few years later he left for Vienna, where he taught with great success. He died in 1839. The dates of their publications leave no doubt that Weiss preceded him in promulgating these new views, but also show that Mohs wrought them out in a more systematic form, and made them more generally known. In 1820 he published his *Charakteristik des naturhistorischen Mineraliensystems*, followed in 1822 by his *Grundriss der Mineralogie*. Both these treatises were translated into English, the second by the well-known Haidinger, then residing in Edinburgh. The clearness and precision with which he marked out and defined the various terms and new ideas required, and followed out the laws regulating combinations, had a great effect in giving a wider currency to his writings. The thorough mode in which he traced out the series of forms in the systems and explained these also added to their popularity. Professor Jameson too gave it a higher authority and wider acceptance, describing it "as eminently distinguished by its originality and simplicity." Its success was further promoted by the remarkable discovery made about the same time by Sir

David (then Dr.) Brewster. In connection with his observations on the polarization of light, this distinguished optician had endeavored to point out the connection between Haüy's nuclei or primitive forms of crystals and the number of their axes of double refraction, and even shown that Haüy had in some cases chosen erroneous forms, as they did not agree with their optical characters. The appearance of Mohs's views threw unexpected light on the fact, as his system of crystallography harmonized in a most remarkable manner with the arrangement proposed on optical grounds. In reality, as now well known, all minerals crystallising in the regular system of Weiss and Mohs with equal and uniform axes show only single refraction; those belonging to the two and one axial and three and one axial systems of Weiss, the pyramidal and rhombohedral of Mohs, have double refraction with only one optical axis; whilst those in the three other systems show double refraction and two optical axes. As Whewell has well remarked, "Sir D. Brewster's optical experiments must have led to a classification of crystals into the above systems, or something nearly equivalent, even if the crystals had not been so arranged by attention to their forms."

The establishment of this system, whether due to Weiss or Mohs, or in part to both, gave to crystallography as a pure science essentially its present form. Taken in connection with the law that the indices marking the relative dimensions of the parameters are always rational numbers, and seldom large, with the symmetry of forms, and the grouping of the faces in zones, we have the leading principles on which it depends. The subsequent progress of the science has been rather directed to working out and completing the structure, and showing the mutual relations of its essential principles, than to modifying the foundations on which it rests. These researches have taken two chief directions, the one explaining the geometrical properties of crystals, and the systems under which in consequence of these properties they necessarily fall to be classed, while the second has regard to the physical properties of crystals, that is, of the various bodies, especially the native minerals,

assuming these forms. Before noticing these we must refer to another point in which Haüy's views were also about the same time remarkably modified and extended.

Haüy, we have seen, maintained that a very close connection always existed between the crystalline character and the chemical composition of minerals, so that from diversity in the angular measurement of two crystals we might infer a difference in their chemical composition, or the reverse. More accurate analyses soon showed that this law had not that universal application which Haüy assumed, and even in 1816 Fuchs had pointed out that certain elements were what he named vicarious, so that in compounds a certain amount of one could replace so much of some other. The remarkable theories and researches of Berzelius soon rendered some change in this respect inevitable, and it was carried out by the discovery of isomorphism by his pupil Mitscherlich in 1822. The subject, however, belongs less to crystallography than to chemistry or mineralogy, and we can only mention the general principle. Mitscherlich showed that there are certain substances which crystallize in forms closely resembling each other, and with the corresponding angles only differing by one or two degrees, or even less. Thus the carbonates of iron and manganese, or lime and magnesia, agree nearly in form and dimensions. Such substances were named isomorphous, and were found to have the tendency to replace or be substituted for each other in compound bodies, with very slight modification of the forms or angles of the crystals. Though at first denied by Haüy and his followers, this truth is now fully established, and has had vast influence in the determination and classification of minerals. As modifying the same conclusion of Haüy, but in an opposite direction, we must also mention Mitscherlich's further discovery of dimorphism, according to which the same element (as sulphur), or the same compound (as carbonate of lime), when crystallizing under different conditions, especially as regards temperature, may assume two distinct forms of crystals belonging even to different systems. Instances are even known of trimorphism and polymorphism, in which the same substance may occur in three or more forms of crystallization.

The mode of formation of crystals, and the powers that are active in their formation, were, as we have seen, favorite subjects of speculation with the earlier writers on crystallography, and are closely connected with the chemical composition of minerals to which we have just referred. This subject continues to attract many inquirers, and has given occasion to some remarkable speculations; but it can hardly be affirmed that much progress has been made in this direction. Crystals may still be seen, as in the time of Leeuwenhoek, springing out of solutions under the microscope, and continuing to increase in size, but the powers that are active escape our notice, and we are still left almost in the same region of speculation as our predecessors. Such discussions, in truth, concern rather the general constitution of matter than the special corner whose history we have been following, so that the words of Brewster still hold true:—"In whatever way crystallographers shall succeed in accounting for the various secondary forms of crystals, they are then only on the threshold of their subject. The real constitution of crystals would be still unknown; and though the examination of these bodies has been pretty diligently pursued, we can at this moment form no adequate idea of the complex and beautiful organization of these apparently simple bodies."

Returning to the more special subject of pure or geometric crystallography, one great object of recent inquiry has been to discover some method of designating the forms or faces of crystals by numbers or symbols, that would at once point out their general relations to each other, and facilitate the calculation of their angles so as to check or control observation. Haüy had already attempted to do this in his great work, by means of his theory of decrements, but his materials were still too imperfect, and his symbols are often very complex. Still the weight of his name retains great influence in France, where a system founded on his, but modified by the more recent views, prevails. It is generally associated with the name of Armand Lévy (born 1794, died 1841), who in 1837 published an important work on Mr. Heuland's collection (*Description d'une collec-*

Isomorphism.

Powers operating still unknown.

Crystallographic symbols.

tion des Minéraux formés par M. H. Heuland), illustrated by numerous plates of crystals. He assumes six prisms or parallelepipeds as primary forms, and designates the faces, angles, and edges by letters, as was done by Haüy. This system is adopted and explained by Dufrenoy in his *Traité de Minéralogie* (Paris, 1844-56), and by Des Cloizeaux in his *Manuel* (Paris, 1862-74).

In Germany also various methods have appeared. Weiss himself only published special papers, but his views have been wrought out by several of his many followers. Thus one of his favorite pupils, F. E. Neumann, in his "Contributions" (*Beiträge zur Krystallogonomie*) in 1823, showed how crystals might be represented not so much by the faces as by their normals, that is, by lines drawn from the centre of the system vertical to the faces. Cleavage, he says, and the reflection of light, etc., all indicate a force acting vertical to the faces, or in the normal. He further brought clearly out the arrangement of the faces in zones, and showed how they could be represented to the eye either by lines on a plain surface, or by great circles on the circumscribing sphere. Quenstedt of Tübingen, another pupil of Weiss, made known a similar method in 1835, which he has since illustrated in his *Methode der Krystallographie* in 1840, in his *Mineralogie*, 1855 (2d ed. 1863), and more fully in his *Grundriss der bestimmenden und rechnenden Krystallographie*, 1873. The truest representative of Weiss, however, is generally regarded as Gustaf Rose, who laid the foundation of his reputation by his account of the "crystallization of sphene and titanite" in 1820. His *Elemente der Krystallographie* first appeared at Berlin in 1833, and in a third edition in 1873.

Mohs's method was expounded in his works already noticed, and became better known in Britain by Haidinger's translation of his *Treatise on Mineralogy*, published at Edinburgh in 1825; and is further explained in Mohs's *Anfangsgründe der Naturgeschichte des Mineralreichs* (1832, 2d edition by Zippe, 1839). Haidinger, besides many memoirs, has also published a separate work in which the method is fully explained (*Handbuch der bestimmenden Mineralogie*, 1845). But wider success and more general adoption has attended the method of Dr. Carl Naumann, in which the faces are represented by means of their co-ordinates, and thus in an easily understood form. Born in 1797, Naumann began his studies under Werner, and completed them under Mohs, and has been regarded as carrying out the system of his teacher, whilst trying to mediate between him and Weiss. His *Lehrbuch der reinen und angewandten Krystallographie* appeared in 1830; his *Anfangsgründe der Krystallographie* in 1841, 2d edition, 1855, and his *Theoretische Krystallographie* in 1856. His *Elemente der Mineralogie*, first published in 1846, and of which a ninth edition appeared in 1874, has still further extended his method and nomenclature. His system, occasionally in slightly altered form, has wide prevalence in Germany, and has been introduced into this country in Nicol's *Mineralogy*, 1849, and in the article on *Mineralogy* in the eighth edition of the present work. Dana in his *Mineralogy*, 1864, has given it wide currency in America; he has endeavored to simplify the mode of representing the faces. Another method, which in Germany in great measure divides the field with Naumann's, may be said to have had its origin in Britain. In 1825 Dr. Whewell published in the *Philosophical Transactions* a memoir on "A General Method of Calculating the Angles of Crystals," in which he referred only to Haüy's views, and in 1826 another "On the Classification of Crystalline Combinations," founded on the methods of Weiss and Mohs, especially of the latter, with which he had in the meantime become acquainted. The author himself states that his method had little value as a method of calculating the angles of crystals. But in 1839 Professor Miller of Cambridge, partly adopting his views, and partly aiding himself by the suggestions of Naumann and of Grassmann, who, without any knowledge of what his predecessor had done, had re-invented the method of representing the position of the faces of crystals by corresponding points on the surface of a circumscribing sphere, brought out his *Treatise on Crystallography*. In his edition of Phillips's *Mineralogy*, 1852, the same system was also employed. In Germany this system has found many followers, and is used in several of the best text-books, among which may be mentioned the *Lehrbuch der Krystallographie* of Karsten, 1861, and the works with the same title of Von Lang, 1866, and Dr. A. Schrauf, 1866.

The relative merit of the methods mentioned cannot be

discussed in this place. The system of Naumann is, perhaps, the one now most generally prevalent, and most easily understood by beginners, as giving the most graphic picture of the various forms and their combinations. Miller's system, on the other hand, is regarded as better adapted for the various calculations needed in the higher portions of the science, and is therefore often preferred by those who make a special study of the subject. How closely their merits are balanced is shown by the fact that Groth, in his recent valuable work, *Physikalische Krystallographie*, Leipzig, 1876, whilst preferring Naumann's, deems it necessary to explain Miller's also to his readers, and to give a comparative table of the symbols employed by Naumann, Miller, and Lévy, so that the one may be, as it were, translated into the other. Similar tables may also be found in Des Cloizeaux's *Mineralogie* and in Schrauf's *Atlas*.

Many very interesting facts have also been recently ascertained; showing the intimate relation that exists between the various physical properties of crystals and their crystallographic characters, proving very distinctly that the systems of crystals are not mere artificial arrangements of speculative men, but have a real foundation in the structure of the bodies observed. We saw already how Brewster proved this connection in reference to their optical properties. He continued his researches on this subject for many years, and it was also pursued by many of his contemporaries, among whom Biot, Sir John Herschel, and Haidinger may be named. More recently the stauroscope, invented by Von Kobell, and the polarizing microscope of Nörremberg have proved valuable aids in investigating these properties. In France M. des Cloizeaux has specially directed attention to the optical properties of crystals and their value in mineralogy (*De l'emploi des propriétés optiques biréfringentes en Minéralogie*, 1867, and *Sur l'emploi du microscope*, in 1864), and in his *Manuel de Minéralogie* records many remarkable observations made both by himself and others. In Britain and in Germany these investigations have recently been conjoined with the examination with the microscope of thin slices of minerals and rocks. The method of preparing such transparent sections was first described by William Nicol of Edinburgh, to whom is also due the discovery in 1828 of the peculiar prisms of Iceland or calcareous spar which are now known by his name, and which form an almost indispensable part of apparatus for such researches. It is scarcely possible to avoid noticing the important influence which this one mineral with its marked properties has had on the progress of the science whose history we are describing. In this country a new impulse was given to the study by Mr. Sorby's memoir "On the Microscopical Structure of Crystals," published in the *Journal of the Geological Society* in 1848. In Germany the workers in this field are so numerous that we cannot specialize individuals, but shall only refer to the works of Zirkel (*Mikroskopische Gesteinsstudien*, 1863, *Mikroskopische Beschaffenheiten der Mineralien*, 1873, etc.), Schrauf (*Lehrbuch der physikalischen Mineralogie*, 1868), and Rosenbusch (*Mikroskopische Physiographie der Mineralien*, 1873), both for further information on the subject generally, and for lists of the more important recent publications. How valuable it has become may be seen from the fact that these transparent sections, examined between two Nicol's prisms, from the phenomena of the interference of light, readily enable the observer to determine to which of the six systems of crystallization the mineral interposed belongs, and thus to fix one of its most essential characters. In this way the exact composition of many fine-grained crystalline rocks can be determined, and much light thrown on their history.

In regard to the other physical properties of crystals, it must suffice to say that they all indicate a similar close dependence on their geometric character. The same systems shown by their mathematical forms and optic properties reappear in reference to their relations to heat, magnetism, electricity, and other properties. The regular or tesseral minerals, with simple refraction of light, are shown by Senarmont's researches also to conduct heat uniformly in all directions, and their magnetic and electric peculiarities are similar. The tetragonal and hexagonal crystals with one chief axis, as they show double refraction of light with a single optic axis, have also analogous modes of conducting heat, of expanding under its influence, and of transmitting magnetism and electricity. And again, the three other systems with unequal axes, as they show two optic

Physical properties.

axes, exhibit also corresponding peculiarities in respect to the other properties mentioned. In this we have a remarkable instance of connection of the various physical sciences, and a strong proof of the sound basis that crystallography attained by the discoveries of Weiss and Mohs.

A great deal has been recently done in improving the instruments employed in determining the forms and dimensions of crystals.

Though for first and rough approximations to the angles the early form of the hand goniometer may still be used, even the reflecting goniometer of Wollaston no longer meets the requirements of modern accuracy. In 1820 the Royal Academy of Sciences at Berlin offered a prize for the best methods of measuring these angles, which was gained by Dr. Kupffer. Malus added a telescope to Wollaston's goniometer, and other methods of increasing its accuracy have been proposed, as by Babinet and Mitscherlich. Frankenheim, Haidinger, and others have also endeavored to perfect the methods or means of observation which now, as tested by comparison with the results of calculation, seem fully adequate to the wants at least of determinative mineralogy.

The forms of crystals that occur in native minerals are described more or less fully in several of the works already mentioned. The *Atlas der Krystal-Formen des Mineralreiches* of Dr. A. Schrauf, 1865-1873, is intended to form a complete collection of all the forms observed in the mineral kingdom,—estimated as exceeding 10,000 in number, described in very many separate treatises and memoirs, and every day becoming more numerous. The arrangement is alphabetical, and the work, from its accuracy and rich material, is highly valuable but still unfinished. The forms of salts and artificial crystals are described in Rammeisberg's *Handbuch der Krystallographische Chemie*, 1855, and supplement, 1857, and many of them also in Groth's *Krystallographie*.

The history of crystallography is related in C. M. Marz's *Geschichte der Krystallographie*, 1825; Whewell's *History of the Inductive Sciences*, vol. iii.; Von Kobell's *Geschichte der Mineralogie*, 1864; Kenngott's *Uebersicht der Resultate der Mineralogische Forschungen*, 1844-1865; Quenstedt's *Grundriss*, 1873, etc., from which further information may be obtained. (J. M.)

CSOKONAI, MIHALY VITEZ (1773-1805), an Hungarian poet, was born at Debrecin in 1773. Having been educated in his native town, he was appointed while still very young to the professorship of poetry there; but soon after he was deprived of the post on account of the immorality of his conduct. The remaining twelve years of his short life were passed in almost constant wretchedness, and he died in his native town, and in his mother's house, when only thirty-one years of age. Csokonai was the author of a mock-heroic poem called *Dorothy*, two or three comedies or farces, and a number of love-poems. Most of his works have been published, with a life, by Schedel (1844-47).

CSOMA DE KOROS, ALEXANDER (c. 1790-1842), or as the name is written in Hungarian, Kőrösi Csoma Sandor, an Hungarian traveller and philologist, born about 1790 at Kőrös in Transylvania, belonged to a noble family which had sunk into poverty. He was educated at Nagy-Enyed and at Göttingen; and, in order to carry out the dream of his youth and discover the origin of his countrymen, he divided his attention between medicine and the Oriental languages. In 1820, having received from a friend the promise of an annuity of 100 florins (about £10) to support him during his travels, he set out for the East. He visited Egypt, and made his way to Tibet, where he spent four years in a Buddhist monastery studying the language and the Buddhist literature. To his intense disappointment he soon discovered that he could not thus obtain any assistance in his great object; but, having visited Bengal, his knowledge of Tibetan obtained him employment in the library of the Asiatic Society there, which possessed more than 1000 volumes in that language; and he was afterwards supported by the Government while he published a Tibetan-English dictionary and grammar (both of which appeared at Calcutta in 1834). He also contributed several articles on the Tibetan language and literature to the *Journal of the Asiatic Society of Bengal*, and he published an analysis of the *Kah-Gyur*, the most important of the Buddhist sacred books. Meanwhile his fame had reached his native country, and procured him a pension from the Government, which, with characteristic devotion to learning, he devoted to the purchase of books for Indian libraries. He spent some time in Calcutta, studying Sanskrit and several other languages; but, early in 1842, he commenced his second

attempt to discover the origin of the Hungarians. He had only reached Darjiling when he died on the 11th April, 1842. An oration was delivered in his honor before the Hungarian Academy by Eötrö, the novelist.

CTESIAS, a Greek physician and historian, who flourished in the 5th century B. C. He was born of an Asclepiad family at Cnidus in Caria, and was in the early part of his life physician to Artaxerxes Mnemon, having, according to Diodorus Siculus, been taken prisoner of war. He was the author of a treatise on rivers, another on the Persian revenues, a history of India, which is only of value as recording the beliefs of the Persians about India, and, most famous of all, a history of Persia—the *Persica*, written in opposition to Herodotus, and professing to be founded on the Persian royal archives. Of his two histories we possess abridgments by Photius, which have been published by Stephens (Paris, 1557-1594). As to the worth of the *Persica* there has been much controversy, both in ancient and modern times. Its chief modern defenders have been Freret, in the *Mémoires de l'Académie des Inscriptions*, vol. v., and Bähr, in his *Prolegomenon* to his edition of what has come down to us of the works of Ctesias (Frankfort, 1824). Aristotle rejected the testimony of Ctesias, which is opposed to that of the Jewish Scriptures, of the Persian historian Berossus, and of recently discovered cuneiform inscriptions. See Rawlinson's *Herodotus* (vol. i. pp. 71-74).

CTESIPHON, an ancient city in the south of Assyria, situated on the left bank of the Tigris, about twenty-five miles south-east of Baghdad. It is reported by Ammianus to have been founded by a Parthian, Naranes by name, of whose history nothing is known; it rose into importance when the city of Seleucia on the opposite bank began to decline; and under the Parthian kings, who originally selected it as a winter residence, it ultimately acquired the rank of the sole capital of their dominions. On the fall of the Parthian empire it naturally declined; but on the establishment of the Persian dynasty of the Sassanids it recovered somewhat of its prosperity, and was occasionally chosen as the residence of royalty on account of the pleasure-grounds and hunting-parks in the vicinity. At the time when it fell into the hands of the Roman emperor Severus (232 A. D.) its population must have been very great, as it furnished no fewer than 100,000 prisoners of war. About 263 it was besieged by Odenathus, king of Palmyra; and in the minority of Sapor II. it was taken by storm by a Mesopotamian chieftain named Thair. Though the emperor Julian gained the day in a great battle before the city, and its capture seems to have been one of the chief objects of his manœuvres, he retired without attempting an investment. In 637 it was abandoned by Yezdejird, the last of the Sassanids, and seized by Sa'ad, the Arabian general, who found within its walls so extensive and costly a booty that, after the works of art and a fifth of the whole were set apart for the caliph, he was able to bestow 12,000 dirhems, or upwards of £300, on each of his 60,000 soldiers. After this date the destruction of the city seems to have been rapidly accomplished; and in the present day the site is marked by desolate ruins which, instead of preserving the ancient name of Ctesiphon or the more modern name of Maidan, are known to the people of the district as the burial-place of Soliman Pak, the barber of Mahomet. Amid the mounds of sun-dried bricks, one building still remains sufficiently entire to give some authentication to the glowing descriptions of the Arabian writers. This is the Takht-i-Khesra (throne of Chosroes), Tak-i-Khesra (arch of Chosroes), or, using the other form of Chosroes's name, the arch of Nushirvan, which consists of the great central hall of the palace, built in all probability by the monarch whose name it perpetuates. According to Tabari, the edifice when complete was 450 feet in length, 180 feet in breadth, and 150 feet in height; adorned in front by a portico of twelve marble pillars of the noblest dimensions; and the vaulted hall, which had a height of 85 feet and a width of 72, was decorated with the signs of the zodiac in golden stars. The whole building appears from the remains to have been composed of baked bricks covered with a coating of plaster; but the Arabian writers speak of it as consisting of polished stone. See Flandin, *Voyage en Perse*; Rawlinson, *The Seventh Oriental Monarchy*.

CUBA, the largest and richest of the West India Islands, and the most important colony of Spain, was discovered by Columbus on 28th October, 1492, during his first



to the north-west being 130 English miles wide at the narrowest part, between the points of Ycaoes in Cuba and Sable on the Florida coast, and the south-west passage of nearly the same width, between the Cabo de San Antonio of Cuba and the Cabo de Catoche, the most salient extremity of the peninsula of Yucatan. On the north-east, east, and south-east, narrower channels separate it from the Bahamas, Hayti, and Jamaica. Cuba lies between 74° and 85° W. long., and 19° and 23° N. lat. Its length, following a curved line through its centre, is 730 miles, and its average breadth is 80 miles. The area of Cuba is 43,319 English square miles; the neighboring island of Pinos, 1214 square miles; and the smaller coastal islands, 1350 square miles;—in all 45,883 square miles. The coast of Cuba is generally low and flat, and is surrounded by numerous islands and reefs, which render the approach both difficult and dangerous to those not acquainted with the proper channels. The low nature of the shore subjects it to frequent floods and inundations; and especially on the north side of the island there are many large lagoons, from which a considerable quantity of salt is obtained. No island, however, in proportion to its size, has a greater number of excellent harbors, many of them accessible even to ships of the line. Of these the chief are the ports of Bahía Honda, Mariel, Havana, Matanzas, Cardenas, Nuevitas, and Nipe on the northern side, and Guatanamo, Santiago de Cuba, Trinidad, and Cienfuegos on Xagua Bay on the southern.

**Mountains.** The highest part of the island is in the range extending in the south-east from the Punta de Mayai to Cape Cruz, called the Sierra or Montañas de Maestra or Cobre, the summits of which are the Pico de Tarquino, 7670 feet, the highest point of the whole island; Gran Piedra, 5200 feet; Yunque and Ojo del Toro, 3500 feet. From this Sierra a ridge of much smaller general elevation follows nearly the central line of the island westward throughout its extent, rising to form a more marked range in the extreme west of Cuba, on which the Pan de Guajabon attains 2530 feet. An almost isolated mass, of which the Pico de Potrerillo is the summit, 2990 feet above the sea, rises immediately behind the harbor of Trinidad, near the centre of the southern coastland. The south-eastern sierra is one great calcareous mass, resting on a schistose formation. The summits are for the most part rocky and naked, occasionally interrupted by more gentle undulations. The central and western parts of the island contain two formations of compact limestone, one of clayey sandstone, and another of gypsum. Caverns abound in the limestone formations. The secondary formations, east of Havana, are pierced by syenitic and euphotide rocks united in groups. The syenite strata are intercalated with serpentine, and inclined to the north-west. In some places petroleum runs out of rents in the serpentine; and abundant springs of this fluid are also found in the eastern part of the island.

**Rivers.** The rivers are necessarily short, and flow toward the north and south. The largest is the Cauto, rising in the Sierra del Cobre, and falling into the Bay of Buena Esperanza on the southern coast, after a course of fifty leagues, for twenty of which it is navigable by boats, though at low water obstructed by bars. The Sagua la Grande rises in the Sierra del Escambray, and falls into the sea in front of the Boca de Maravillas, being navigable for five leagues. The principal of the other rivers are the Sagua la Chica, the North and South Itatibonica, the Cuyaguasteje, Sasa, Agobama, and Hanabana. North-east of Guantanamo the hills of the south-eastern sierra are known as those of Quibijan and Baracoa, and in the hill of Moa in this range there is formed a huge cavern in which the River Moa descends from a height of 100 yards, forming a superb cascade.

**Climate.** Situated within and near the border of the northern tropical zone the climate of the low coastlands of Cuba is that of the torrid zone, but the higher interior of the island enjoys a more temperate atmosphere. As in other lands on the border of the tropics, the year is divided between a hotter and wetter season, corresponding to the northern declination of the sun, and a cooler and drier period. The months from the beginning of May to October are called the wet season, though rain falls in every month of the year. With May spring begins in the island, rain and thunder are of almost daily occurrence, and the temperature rises high with little daily variation. The period from November to April is called the dry

season by contrast. On a mean of seven years, the rainfall at Havana in the wet season has been observed to be 27·8 inches, of the dry months 12·7 or 40·5 inches for the year. At Havana in the warmest months, those of July and August, the average temperature is 82° Fahr., fluctuating between a maximum of 88° and a minimum of 76°; in the cooler months of December and January the thermometer averages 72°, the maximum being 78°, the minimum 58°; the average temperature of the year at Havana, on a mean of seven years, is 77°. But in the interior, at elevations of over 300 feet above the sea, the thermometer occasionally falls to the freezing point in winter, hoar frost is not uncommon, and during north winds thin ice may form, though snow is unknown in any part of the island. The prevailing wind is the easterly trade breeze, but from November to February cool north winds (*los nortes*, or "northers"), rarely lasting more than forty-eight hours, are experienced in the western portion of the island, to which they add a third seasonal change. From 10 to 12 o'clock are the hottest hours of the day; after noon a refreshing breeze (*la virazon*) sets in from the sea. Hurricanes may occur from August to October, but are less frequent than in Jamaica or Hayti, and sometimes five or six years may pass without such a storm. Slight shocks of earthquake are occasionally felt. There are no diseases specially indigenous to the island; the yellow fever, which breaks out with renewed virulence regularly with the wet season in the coastlands and seaports of Cuba, annually causing great loss of life, is quite unknown in the interior.

The mineral riches of the island have not been explored to any considerable extent. Minerals. Though gold and silver have undoubtedly been found in the island, the quantity has never been sufficient to repay the labor of search. Gold was sent to Spain from this island by the early settlers, but it was more probably the accumulated wealth of the aborigines in previous centuries, wrested from them by tyranny and rapine at the period of the conquest, than the product of honest labor on the part of the colonists. Traces of auriferous sand are found in the rivers Holguin, Escambray, etc. Some specimens of the finest gold have been obtained from the workings of Agabama and Sagua la Grande, but at an expense of time and labor that could not remunerate the parties engaged in it. In 1827 silver and copper were discovered in the jurisdiction of Villa Clara, and the first ores gave no less than 7 oz. of pure silver to the quintal (= 107½ lb) of ore; but they have become less productive, probably from not being properly worked. The Cobre copper mines, twelve miles from Santiago, in the eastern part of the island, are of great extent, and very rich; a village of 2000 inhabitants has formed on their site, and a railroad unites them with the shipping port of Punta de Sal. As much as 50 tons of ore are taken out daily, the richest part of which, being broken up, is shipped to Europe; while the poorer part is smelted at the works, yielding about 14 per cent. of metal. These mines were wrought with some success during the 17th century, and had been abandoned for more than 100 years. Coal of a highly bituminous character, affording a strong heat, and leaving very little solid residue in the form of ashes or cinders, is very abundant. In some places it degenerates into a form resembling asphaltum, and near the coast it is often found in a semi-liquid state like petroleum or naphtha. In the quarries near Havana a thick slate is found, fit for floors and pavements. Marbles and jaspers, of various colors, and susceptible of a high polish, are found in many parts of the island, and particularly in the Isle of Pines. It is generally believed that iron exists in various districts of Cuba, and many parts of the great Cordillera undoubtedly contain rocks of a ferruginous nature; but from the difficulty of access, the scarcity of fuel, and the want of capital, no extensive mining operations have been engaged in. Native loadstone, however, has been found in various parts, and chalybeate springs are numerous.

The only peculiar quadruped known in the island is the *julia* or *Autia*, an animal shaped like a rat, and from 12 to 18 inches in length exclusive of the tail. It is of a clear black color, inhabits the hollows and clefts of trees, and feeds on leaves and fruits. Its flesh is insipid, but is sometimes eaten. A few deer are found about the swamps, but they are supposed to have been introduced from the continent. The woods abound in wild dogs and cats, sprung from these animals in a domestic state, and differing from them only in habits and size. They are

very destructive to poultry and cattle. Of domestic animals, the ox, the horse, and the pig are the most valuable, and form a large proportion of the wealth of the island; the sheep, goats, and mules, are less numerous. The manati frequents the shores. The domestic fowls include geese, turkeys, peacocks, and pigeons. The indigenous birds are distinguished by the beauty of their plumage, and are very numerous, including upwards of 200 species. Birds of prey are few. The vulture and turkey-buzzard are protected by law and custom, on account of their services in the removal of offal. The rivers, bays, and inlets are well supplied with fish. Oysters and other shell-fish are numerous, but of inferior quality. The reefs and shallows, and the sandy portion of the beach, abound in turtle; and the crocodile, cayman, and iguana are common. Large numbers of land-crabs are frequently seen; they cross the island from north to south every spring, when the rains commence. Snakes are not numerous; the *maja*—12 or 14 feet in length, and 18 or 20 inches in circumference—is the largest, but is harmless; the *juba*, which is about 6 feet long, is venomous. Among the insects may be specially noticed the bee and the phosphorescent fly. These flies are very numerous, and much used among the poorer inhabitants. Fifteen or twenty of them confined in a calabash pierced with holes frequently serve during the night as a sort of lantern. The noxious insects are the chigoe or jigger, a species of ant called vivajagua, the mosquito, the sand-fly, the scorpion (less poisonous than that of Europe), and spiders whose bite is malignant enough to produce fever.

The forests of Cuba are of vast extent, and so dense as to be almost impenetrable. It is estimated that of nearly 20,000,000 acres of land still remaining perfectly wild and uncultivated, nearly 13,000,000 are uncleared forest. Mahogany and other hard woods, such as the Cuban ebony, cedar, sabiceí, and granadilla, valuable for manufactures, cabinet work, and ship-building, are indigenous, and are exported to a considerable extent. The palm is the queen of the Cuban forests, and the most valuable tree on the island. The most common species, the *Palma real* (*Oreodora regia*), is found in all parts, but especially in the west. The fruits of Cuba are those common to the tropics, of which the pine-apple and orange are the most esteemed. Of the alimentary plants, the plantain is by far the most important. Next in order come the sweet and bitter cassava—the sweet root being eaten as a vegetable, and the bitter converted into bread after its poisonous juice has been extracted. The sweet potato, and other farinaceous roots, are also common. Indian corn is indigenous, and rice is extensively cultivated; cocoa or chocolate is also grown.

The chief agricultural products of Cuba are, however, sugar, coffee, and tobacco. The "ingenios" or sugar estates, with large buildings and mills for sugar-refining and distillation of rum, are the most important industrial establishments of the island, varying in extent from 500 to as much as 10,000 acres. Of late years, partly from the effects of the insurrection, and partly from the rapidly extending cultivation of beet-root sugar in other countries, the demand for Cuban sugar has been diminishing, and the sugar estates have not flourished. The United States take about 70 or 80 per cent. of the sugar grown in Cuba, the greater part of the remainder passing to Europe. The quantity exported in 1873 from the ports of Havana, Matanzas, Cardenas, Sagua la Grande, Remedios, Nuevitas, Santiago de Cuba, Trinidad, and Cienfuegos exceeded 600,000 tons, of a value of about £12,000,000. Besides this 242,000 tons of molasses were exported. After the "ingenios" the "cafetales" or coffee estates are the most important establishments. They vary in extent from 100 to upwards of 1000 acres, or even more in the mountain districts,—the number of hands employed being as high as 100 in the low country, but generally averaging fifty or sixty negroes to 1000 acres. The first coffee plantation was established in 1748, the seeds having been brought from San Domingo. Though at one time coffee was sent out from Cuba in enormous quantities, it does not now figure largely in the exports. Tobacco is indigenous to Cuba, and its excellent quality is celebrated in all parts of the world. The estates devoted to its cultivation are scattered over the greater part of the island, but the finest qualities of tobacco are those grown in the country west of Havana, known as the "vuelta abajo." In 1873,

224,765,000 cigars were exported, besides nearly 13,500,000 lb of leaf, to the United States, Great Britain, Hamburg and Bremen, Holland, France, and Spain. Among the other industrial establishments of Cuba may be mentioned the numerous cattle farms, cotton plantations, fruit and vegetable farms, chocolate plantations, and "colmenaries" or farms devoted to the production of honey and wax.

The imports consist mainly of jerked beef from South America, codfish from the British North American provinces, flour from Spain, rice from Carolina, Spain, and the East Indies, wine and olive oil from Spain, boards for boxes and barrels from North America, coals from Europe and North America, and petroleum from the United States, besides large quantities of British, German, and Belgian manufactures and hardware. Heavy differential duties in favor of goods imported into Cuba in Spanish ships are in force, so that the greater part of the imports arrive in these. Cattle are imported from Florida and the coasts of the Mexican Gulf. There are no manufacturing industries of importance in the island.

Education is in a remarkably backward state in Cuba. In the absence of recent statistics, it is estimated that of perhaps 100,000 children of free parents, not a tenth part receive lettered education of any kind; and even among the higher classes of society liberal education is very far from being universally diffused. A few literary and scientific men, wherever educated, are however to be found both in the higher and middle ranks, and, previous to the disturbances which began in 1868, the question of public instruction excited much interest among the creole population, an impetus to this having been given by the same liberal portion of the population which originated the *Sociedad Economica* of Havana and Santiago de Cuba, an institution which has for its object the advancement of education and popular industry. At Havana is the royal university with a rector and thirty professors and medical and law schools, as well as an institution called the Royal College of Havana. There is a similar establishment at Puerto Principe, in the eastern interior; and both at Havana and Santiago de Cuba there is a college in which the branches of ecclesiastical education are taught, together with the humanities and philosophy. Besides this there are several private schools, but none are accessible to the masses. The inhabitants of Havana can scarcely be said to have any literature—a few daily and weekly journals, under a rigid censorship, supply almost all the taste for letters in the capital.

The Roman Catholic is the only religion tolerated by Government. At first there was but one diocese, which included not only the whole island, but also Louisiana and the two Floridas, all under one bishop. In 1788 Cuba was divided into two dioceses, each embracing half the island. The eastern diocese, or that of Santiago de Cuba, was in 1804 erected into an archbishopric, while that of Havana still remains under a bishop.

Politically the island is a province of Spain ruled over directly by a governor-captain-general of the class of lieutenant-general of the Spanish army, whose authority for the time being is despotic. He is appointed by the Crown, the term of office being generally from three to five years, is responsible only to the sovereign of Spain, and is supreme head of the civil, military, and ecclesiastical jurisdictions of Cuba. The captain-general is assisted by governors of departments, who have under their orders the lieutenant-governors, commanders of the thirty-two jurisdictions of the island, each of which is subdivided into "partidos" or captaincies. In each city or town a municipal body termed the *ayuntamiento*, or town council, is at the head of affairs, but municipal representation exists only in appearance. The military division is into two departments—that of the west with Havana for its capital, and that of the east with Santiago de Cuba for its head-quarters. The boundary between these departments, which is also the limit of the dioceses, starts from the brook Yana in front of the eastern part of the island of Yuriguano, and terminates near Sabana-la-Mar.

The judicial division comprises the whole island, as the territory of the "Real Audiencia Pretorial," or supreme court. In each of the twenty-six judicial districts into which this is subdivided there is an "alcalde mayor," having for auxiliary delegates the ordinary "alcaldes," or

Education  
and  
religion.

local judges. The "Real Audiencia," holding session at Havana, is a species of council of state which the captain-general consults on all difficult matters of administration. The maritime division is subject to a commander-general, and consists of five stations or provinces, with their centres at Havana, Trinidad, San Juan de los Remedios, Nuevitas, and Santiago de Cuba.

In popular language the different portions of the island are distinguished as the *Vuelta Abajo*, or the portion extending from the meridian of Havana to the western extremity of the island; the *Vuelta Arriba*, from the meridian of Havana towards the east as far as Cienfuegos; *Las Cinco Villas* from the meridian of Cienfuegos to that of Santo Espiritu; and *Tierra Adentro* from that of Santa Espiritu to Holguin and the extreme east of the island.

**Finance.** The Crown revenues of the island are the *rentas maritimas*, including duties on imports, exports, and tonnage, and the local or municipal duties levied at some of the custom-houses; the *impuestas interiores*, including the tax on home manufactures, the sale of stamped paper, the profits derived from the lottery, and the impost on cock-fights; deductions from the *rentas eclesiasticas*, particularly those called the royal ninth and the consolidated fund, the sinking fund, the *media annata*, and the annual and monthly revenues of the clergy; personal deductions, such as from the pay of public functionaries and the price of exemption from military service; miscellaneous receipts, as the produce of the sale of royal lands, the rents of vacant livings and of unclaimed estates, the produce of vendible offices; and casual receipts, including deposits, confiscations, donations, and the recovery of arrears.

Previous to the outbreak of the insurrection of 1868, the total revenue of Cuba had reached nearly to 26,000,000 dollars, of which sum about 6,000,000 dollars was annually remitted to Spain, leaving the remainder to cover the expenses of the army, navy, and civil service of the island. Since 1868 the imposts have been much increased, but have not been sufficient to cover the enormous increase of expenditure consequent on the rebellion. The Government of the island has thus been compelled to borrow large sums for its war funds. Public finances are specially under the management of the Government bank called the Banco Español, and have fallen into an unsatisfactory and confused state consequent on the steps taken by the island Government for obtaining funds by the emission of large amounts of notes without additional security, and without a special guarantee for each issue from the Madrid Government, resulting in the depreciation of the paper, or a premium on gold and silver.

The coins in use are chiefly the old Spanish "doblón," or "onza de oro," worth about £3, 4s., or 16 silver dollars of Spain, but it is legal tender for 17 dollars in the island. Gold coins of half a doblón, "media onza," of 8 dollars 50 cents, and of half and quarter that amount, and the "peso," or dollar in gold or silver, are also in circulation. There is scarcely any smaller silver currency in Cuba, excepting the American 10 cent piece, or dime, called the "real sencilla."

**Communication.** The roads of Cuba are generally in a very wretched condition. Several railways have been established. The oldest, opened in 1838, extends from Havana to Guines, a distance of forty-five miles, and has branches to Batabano, San Antonio, and Los Palos. There are lines in operation from Matanzas to Sabanilla, Cardenas to Bamba and Jucaro, and thence to unite with the line which crosses the island between Sagua la Grande and Cienfuegos, as well as from Puerto Principe to Nuevitas. The whole length of lines in operation is nearly 400 miles. Coastal communication is kept up by steamers which ply regularly between the different ports. Numerous lines of steamers run between Havana and New York, New Orleans, Key West, Philadelphia, and Baltimore; and with Europe, communication is maintained by English mail as well as French and German lines of ocean steamers. The island is connected by telegraph with the mainland and with Jamaica.

Conflicting accounts render it impossible to arrive at anything like certainty as to the number of inhabitants on the island at the time of its conquest; but it may be estimated at from 300,000 to 400,000. There is little doubt, however, that before 1660 the whole of this population had disappeared from the

island. The first census of Cuba was taken in 1774, when the population was 171,620. In 1791 it was 272,300. The following table gives the population since that period:

Year.	Whites.	Free Blacks.	Slaves.	Total.
1811...	274,000	114,000	212,000	600,000
1817...	290,021	115,691	225,268	630,980
1827...	311,051	106,494	286,942	704,487
1841...	418,291	152,838	436,495	1,007,624
1846...	425,769	149,226	323,759	898,752
1849...	457,133	164,410	323,897	945,440
1860...	604,610	207,735	367,370	1,179,715

Owing to the disturbed condition of the island, no census of the inhabitants has been taken since that of 1861. The results of the enumeration of that year made the total population 1,396,530, distributed thus:

Naturalized Whites.....	780,994
Asiatic Coolies.....	34,834
Mexicans (Yucatecs).....	1,047
	<u>766,775</u>
Free Colored.....	232,493
Slaves.....	<u>370,553</u>
	603,046
Resident foreigners.....	5,298
Passing ".....	3,987
Spaniards.....	<u>17,424</u>
	26,709

An estimate, based on this census, made in 1869 gives the total population as 1,414,508, including 50,000 coolies. The following statement appears in *The Times*, March 16, 1877:

"The American press despatch from Havana states that the official figures show that in the year 1870 there were in the island 363,000 slaves; in 1873, 287,000; and 1876, 199,000.

"The number of free blacks in the island in 1873 was 26,000; in 1874, 50,000; in 1875, 75,000; and in 1876, 84,000. The free blacks in the four jurisdictions in which no census could be taken are estimated at 6000."

Writing in 1872, Mr. Gallenga quotes an official statement of the population, giving a total of 1,359,437; or 1,034,616 in the western division of which Havana (population, 230,000) is the chief city; 75,725 in the central districts round Puerto Principe (population, 31,000); and 249,096 in the eastern division, the chief town of which is Santiago de Cuba (population, 37,000). The only other town of importance is Matanzas with a population of 36,000.

The inhabitants of Cuba are divided into four classes,—the native Spaniards, who occupy nearly all the offices of power and trust; the creoles, who are mostly planters, farmers, or lawyers, and are generally looked upon with contempt by the Spaniards; the third class, composed of free mulattoes and free negroes in about equal parts, who are excluded by law from all civil offices; those under servitude, constituting the fourth class, divided into the *bozales*, those recently brought from Africa,—the *ladinos*, those imported before the law of 1821 prohibiting the slave trade,—and the *criollos*, those born on the island. Cuba was long notorious for the extent to which the slave trade was carried on there, and the ineffectual efforts made to suppress it. The English Government succeeded, however, in 1853 in inducing the Spanish Government to pledge itself to adopt measures for its suppression; and the importation of African slaves has consequently ceased for a number of years. In their place Asiatic coolies have been introduced in considerable numbers, and the plan has worked well for the planters, though it is almost certain death in a short time to the coolies, who are slaves in almost every sense.

Under a better and more liberal system of government, there can be no doubt that Cuba would speedily attain a much higher state of prosperity and importance than it has yet enjoyed. Great as is its productiveness at present, some writers assert that under good government it would be increased fivefold; its mineral resources would then be fully developed, and it would be able fully to take advantage of its admirable position to develop its trade.

The following authorities may be consulted—Ramon de la Sagra, *Historia fisica, polit., y natural de la I. de Cuba*, 13 vols.

Madrid, 1849-1861, and Cuba en 1860, Paris, 1862; *Cuba and the Cubans, comprising a History of the Island of Cuba*, New York, 1850; Jegor von Sivers, *Cuba, die Perle der Antillen*, Leipzig, 1861; Fernandes de Castro, *Estudios sobre las minas de oro en la I. de Cuba*, Havana, 1865; Jao. de la Pezuela, *Dict. geogr. estadístico-histórico de la I. de Cuba*, Madrid, 1864; Emilio Blanchet, *Compendio de la Hist. de Cuba*, Matanzas, 1866; R. Ferrer, "Estudios físicos, geogr. y geológicos de Cuba," in *Revista de España*, t. xxii., 1871; S. Hazard, *Cuba with Pen and Pencil*, London, 1873; A. Gallenga, *The Pearl of the Antilles*, London, 1873; Hippolyte Piron, *L'Île de Cuba*, Paris, 1876. (K. J.)

**CUBEBS** (Arabic, *kabābah*), the fruit of species of plants belonging to the genus *Cubeba*, natural order *Piperaceæ*. The cubebs of pharmacy are produced by *C. officinalis* (*Piper Cubeba*, Linn.), a climbing woody shrub indigenous to South Borneo, Sumatra, Prince of Wales Island, and Java. It has round, ash-colored, smooth branches; oblong, or ovate-oblong, coriaceous, shining leaves, 4 to 6½ inches long, and 1½ to 2 inches broad; and dioecious flowers. The fruits are small, globose, about ¼th inch in diameter, and not so large as white pepper; their contracted bases or pedicles are between ¼ and ½ inch in length, and from forty to fifty of them are borne upon a common rachis. Commercial cubebs consist of the dried ripe berries, usually with their pedicles attached; the pericarp is greyish-brown, or blackish and wrinkled; and the seed, when present, is hard, white, and oily. The odor of cubebs is agreeable and aromatic; the taste pungent, acrid, slightly bitterish, and persistent. About 15 per cent. of a volatile oil, polymeric with oil of turpentine, is obtained by distilling cubebs with water; after rectification with water, or on keeping, this deposits rhombic crystals of camphor of cubebs, or hydrate of cubebene,  $C_{20}H_{30}O$ ; cubebene, the liquid portion, has the formula  $C_{20}H_{30}$ . Cubebin is a crystalline substance existing in cubebs, discovered by Soubeiran and Capitaine in 1839; it may be prepared from cubebene, or from the pulp left after the distillation of the oil. The drug, along with gum, fatty oils, and malates of magnesium and calcium, contains also about 1 per cent. of cubebic acid, and to this and to a resin Bernatzik and Schmidt attribute its therapeutic effects. Cubebs are administered for arresting excessive mucous urethral discharges, also as a gentle stimulant, carminative, and stomachic. They are most safely employed in gonorrhœa when the inflammation is confined to the mucous membrane of the urethra. The introduction of the drug into medicine is supposed to have been due to the Arabian physicians in the Middle Ages. Cubebs were formerly candied and eaten whole, or used ground as a seasoning for meat. Their modern employment in England as a drug dates from 1815. "Cubebs" were purchased in 1284 and 1285 by Lord Clare at 2s. 3d. and 2s. 9d. per lb respectively; and in 1307 1 lb for the King's Wardrobe cost 9s., a sum representing about £3 12s. in present value (Rogers, *Hist. of Agriculture and Prices*, i. 627-8; ii. 544). The plant *Cubeba Cusisi* produces the *African cubebs* or West African black pepper, the berry of which is smoother than that of common cubebs, and usually has a curved pedicle. It is said by Stenhouse (*Ann. Ch. Pharm.*, xcv. 106) to contain piperin and not cubebin. In the 14th century it was imported into Europe from the Grain Coast, under the name of pepper, by merchants of Rouen and Lippe.

**CUBITT, THOMAS** (1788-1855), who attained distinction as a builder and capitalist, was born at Buxton, near Norwich. Few men have exhibited greater self-reliance in early life in the pursuit of a successful career. In his nineteenth year, when he was working as a journeyman carpenter, his father's death quickened the desire to reach an independent position, and induced him to undertake a voyage to India as captain's joiner. On his return to London, two years after, in the possession of a small capital, he began business as a carpenter, and the growth of his establishment was steady and rapid. He was one of the first to unite the many trades, until then more or less separate, which are now comprised in a "builder's" business; and this amalgamation very much increased his success. One of the earlier works which gave him reputation was the London Institution, Moorfields; but it is from 1824 that the vast building operations date which identify his name with many splendid ranges of London houses, such as Tavistock, Gordon, Belgrave, and Lowndes Squares, and the district of South Belgravia. While these

and similar extensive operations were in progress, a monetary panic, which proved ruinous to many, was surmounted in his case by a determined spirit and his integrity of character. He took great interest in sanitary measures, and published, for private circulation, a pamphlet on the general drainage of London, the substance of which was afterwards embodied in a letter to the *Times*; the plan he advocated was subsequently adopted by the conveyance of the sewage matter some distance below London. He regarded with the eye of a philanthropist the provision of open spaces in the environs of London as places of public recreation, and was one of the originators of Battersea Park, the first of the people's parks. At a late period he received professionally the recognition of royalty, the palace at Osborne being erected after his designs and under his superintendence; and in the *Life of the Prince Consort* he is described by the Queen as one "than whom a better and kinder man did not exist." In 1851, although he was not identified with the management of the Great Exhibition, he showed the warmest sympathy with its objects, and aided its projectors in many ways, especially in the profitable investment of their surplus funds. As a capitalist he regarded as inseparable the interests of employers and employed, and he always had the elevation of his work-people at heart. He was elected president of the Builders' Society some time before his death, which took place at his seat of Denbies, near Dorking, in 1855.

**CUBITT, SIR WILLIAM** (1785-1861), a distinguished English engineer, was born at Dilham in Norfolk, where his father was a miller. He received his early education at the village school, and subsequently profited greatly by the access he had to a clergyman's library. While still very young he worked in his father's mill, and served an apprenticeship of four years (1800-1804) as a joiner and cabinetmaker at Stalham. After working for a short time with his father, he became associated with an agricultural machine-maker, named Cook, who resided at Swanton. He now showed great talent in making accurate and highly finished patterns for the iron castings of horse threshing-machines and other implements. He turned his attention to windmills, which were, at that time, encumbered with sails so large that they proved exceedingly difficult to manage during a storm. His investigations led him to the invention of self-regulating windmill sails, which were patented in 1807, and are now universally used. In 1812 he entered the important works of Messrs. Ransome of Ipswich, of which he soon became chief engineer. He improved the port and gasworks of Ipswich, and ultimately became a partner of the Messrs. Ransome, and remained with them till 1828, when his increasing interest in great engineering undertakings led to his removal to London. Meanwhile, the subject of the employment of criminals had been much in his thoughts; and the result was his invention of the treadmill, which he meant to be used for grinding corn, pumping water, etc., and did not contemplate as an instrument of punishment. Shortly after 1818 all the principal jails in the kingdom introduced the invention. In 1822 an account of the treadmill, "invented by Mr. William Cubitt of Ipswich" was issued by the Society for the Promotion of Prison Discipline. Mr. Cubitt had been very busy, while in Ipswich, having issued reports in 1814, 1820, and 1822 on the Norwich navigation. In 1822 he first became intimate with Telford. After his removal to London he was almost constantly engaged in important engineering works, and was often requested to give his opinion and evidence on the improvement of canals, harbors, ports, and rivers, the making of railways, and designs for bridges. His face was well known in the committee rooms at Westminster. Among his works may be mentioned the Oxford Canal, the Birmingham and Liverpool Junction Canal, the improvement of the River Severn, the Butte docks at Cardiff, the Black Sluice drainage and its outfall sluice at Boston harbor, the Middlesborough docks and coal-drops in the Tees, and the South-Eastern Railway, of which he was chief engineer. His advice was often asked about proposed alterations on the Thames, Tees, Tyne, Ouse, Weaver, Nene, Witham, and Welland; and he submitted important reports on these rivers. He was a member of the commission for the improvement of the Shannon, in which capacity he did good service. On the Croydon Railway he applied the atmospheric system of traction; and on the Great Northern Railway, constructed by his son, Mr. Joseph Cubitt, he effected many valuable improve-



ments. On the Continent, too, his opinion was much valued. The Hanoverian Government consulted him about the harbor and docks at Harburg; the water-works of the city of Berlin were constructed under his immediate superintendence; his report on the proposed Paris and Lyons railway had much weight in determining what offer was to be accepted; and he was consulting engineer for the line of railway from Boulogne to Amiens. Among his later works we may mention two large floating landing-stages at Liverpool, and the bridge for carrying the London turnpike across the Medway at Rochester.

In 1850 he was consulted by Sir Robert Peel in regard to a building in Hyde Park for the International Exhibition. His name is identified with the original plan; and he gave such high satisfaction that Her Majesty was graciously pleased to confer the honor of knighthood on him in 1852. Ultimately Sir Joseph Paxton's plan was adopted, with the approval of Mr. Cubitt. Public recognition, sometimes withheld in the case of literary men, is generally ample in the case of those who devote themselves to practical usefulness. Cubitt accordingly was chosen a fellow of the Royal Society in 1830; he was also a fellow of the Royal Irish Academy, a member of the Society of Arts, and of the Institution of Civil Engineers, of which he became successively a member of council in 1831, vice-president in 1836, and president in 1850 and 1851. In 1858, after a singularly arduous and successful career, he retired from public business; but he never ceased to take an interest in engineering work till his death, which took place on the 13th October, 1861, at his house on Clapham Common, London.

CUCA, or COCA (*Erythroxylon Coca*), is a plant of the natural order *Erythroxylaceae*, the leaves of which are used as a masticatory in the western countries of South America.<sup>1</sup> It resembles a blackthorn bush, and grows to a height of 6 or 8 feet. The branches are straight, and the leaves, which have a lively green tint, are thin, opaque, oval, tapering at the extremities, and similar to tea-leaves; on each side of the strong mid-rib is a longitudinal vein. Good samples of the dried leaves are uncurled, are of a deep green on the upper, and a grey-green on the lower surface, and have a strong tea-like odor; when chewed they produce a sense of warmth in the mouth, and have a pleasant, pungent taste. Bad specimens have a camphoraceous smell and a brownish color, and lack the pungent taste. The flowers are small, and disposed in little clusters on short stalks; the corolla is composed of five yellowish-white petals, the anthers are heart-shaped, and the pistils are three in number. The flowers are succeeded by red berries. The seeds are sown in December and January in small plots (*almacigos*) sheltered from the sun, and the young plants when from 1½ to 2 feet in height are placed in holes (*aspi*), or, if the ground is level, in furrows (*uachos*) in carefully-weeded soil. The plants thrive best in hot, damp situations, such as the clearings of forests; but the leaves most preferred are obtained in drier localities, on the sides of hills. The leaves are gathered from plants varying in age from one and a half to upwards of forty years. They are considered ready for plucking when they break on being bent. The first and most abundant harvest is in March, after the rains; the second is at the end of June; the third in October or November. The green leaves (*matu*) are spread in thin layers on coarse woollen cloths and dried in the sun; they are then packed in sacks, which, in order to preserve the quality of the leaves, must be kept from damp.

It has been estimated that cuca is used by about 8,000,000 of the human race, being consumed in Bolivia, Peru, Ecuador, Colombia, and Rio Negro. In Peru the Indians carry a leathern pouch (the *chuspa*, or *kuallqui*) for the leaves, and a supply of pulverized unslaked lime, or a preparation of the ashes of the quinoa plant (*Chenopodium quinoa*), called *llipta* or *üucta*. Three or four times a day labor is suspended for *chacchar* or *acullico*, as the mastication of cuca is termed. The leaves, deprived of their stalks, are chewed and formed into a ball (*acullico*) in the mouth; a small quantity of the lime or *llipta* is then applied to the *acullico* to give it a proper relish. Two or three ounces of cuca are thus daily consumed by each Indian.

Garcilasso de la Vega, writing of the plant, says that it is called *ococa* by the Indians, *ococ* by the Spaniards; and Father Blas Valera states that the leaves are called *ococa* both by Indians and Spaniards. (*The Royal Commentaries of the Incas*, 1600-1617; trans. by C. R. Markham, Hakluyt Soc., 1871.) See also, on the name *ococa*, Christison, *Brit. Med. Journ.*, April 26, 1876, p. 527.

Cuca is a powerful stimulant of the nervous system; it enables fatigue to be borne with less nourishment and greater ease than ordinarily, and diminishes the difficulty of breathing in ascending mountains; when used externally it is said to be a remedy for rheumatism and headache.

The poet Cowley represents the Indian "Pachamma" as addressing Venus thus:—

"Our *Varicocha* first this *Coca* sent,  
Endow'd with Leaves of wondrous Nourishment,  
Whose Juice succo'd in, and to the Stomach tak'n  
Long Hunger and long Labor can sustain;  
From which our faint and weary Bodies find  
More Succor, more they cheer the drooping Mind,  
Than can your *Bacchus* and your *Ceres* join'd.  
Three Leaves supply for six days' marsh afford,  
The *Quituito* with this Provision stor'd  
Can pass the vast and cloudy *Andes* o'er."  
(*Plants*, bk. v. p. 121, *Works*, 9th ed. Lond. 1700.)

Dr. Pöppig (*Travels in Chili and Peru*) considers the habit of cuca-chewing to be as dangerous to the health as opium-eating, and in the highest degree pernicious, and Mr. J. A. Lloyd alludes to cuca as a "poisonous narcotic" (*Journ. R. Geog. Soc.*, 1854, p. 260). It does not, however, appear from the writings of Garcilasso that he observed any ill results among the Peruvian Indians from the practice of cuca-chewing. Von Tschudi refers to numerous instances of their longevity and good health, notwithstanding the habit, almost from boyhood, of masticating cuca three times a day. Markham regards cuca as the least injurious, and the most soothing and invigorating of all the narcotics used by man; and Dr. Archibald Smith (*Peru as it is*, London, 1839), states that cuca when fresh and good, and used in moderate quantity, increases nervous energy, removes drowsiness, enlivens the spirits, and enables the Indian to bear cold, wet, great bodily exertion, and even want of food to a surprising degree, with apparent ease and impunity. Though it is said, if taken to excess, to occasion tremor in the limbs, and even a gloomy sort of mania, such dire effects, he considers, must be of rare occurrence, since, after living for years in constant intercourse with persons accustomed to frequent cuca plantations, and with Indian yanacones or laborers, all of whom, whether old or young, masticated the favorite leaf, he never witnessed a single instance in which the chewer was affected with mania or tremor.

Cuca was used by the Peruvian Indians in the most ancient times. It was employed as an offering to the sun, or to produce smoke at the great sacrifices; and the priests, it was believed, must chew it during the performance of religious ceremonies, otherwise the gods would not be propitiated. Cuca is still held in superstitious veneration among the Peruvians, and is believed by the miners of Cerro de Pasco to soften the veins of ore, if masticated and thrown upon them.

*Cocaine*, the alkaloid to which cuca owes its special properties, was discovered by Niemann in 1859. The formula assigned to it is  $C_{10}H_{12}NO_6$  or  $C_9H_{11}NO_6$  (Losen). It is highly poisonous, and its physiological action is apparently identical with that of theine, caffeine, guanine, and theobromine, which all, as has been shown by Dr. A. Bennet, "induce a series of symptoms affecting the nervous, respiratory, circulatory, vaso-motor, and glandular systems" (*Edin. Med. Journ.*, October, 1873, p. 323).

Tschudi, *Travels in Peru*, etc., 1838-42 (Lond., 1847); C. R. Markham, *Travels in Peru and India*, p. 232 (Lond., 1862).

CUCKOO, or CUCKOW, as the word was formerly and more correctly spelt—changed without any apparent warrant except that accorded by custom, while some of the more scholarly English ornithologists, as Montagu and Jenyns, have kept the older form—the common name of a well-known and often-heard bird, the *Cuculus canorus* of Linnæus. In some parts of the United Kingdom it is more frequently called Gowk, and it is the Greek *κόκκυς*, the Italian *Cuculo* or *Cucco*, the French *Coucou*, the German *Kuckuk*, the Dutch *Koekkoek*, the Danish *Kukker* or *Gjög*, and the Swedish *Gök*. The oldest English spelling of the name seems to have been *Cuccu*.

No single bird has perhaps so much occupied the attention both of naturalists and of those who are not naturalists, or has had so much written about it, as the common Cuckoo, and of no bird perhaps have more idle tales been told. Its strange and, according to the experience of most

people, its singular habit of intrusting its offspring to foster-parents is enough to account for much of the interest which has been so long felt in its history; but, as will presently appear, this habit is shared probably by many of its Old-World relatives, as well as in the New World by birds which are not in any near degree related to it. In giving here a short account of this species, there will be no need to refute much of the nonsense about it which has found access to works even of respectable authority; but, besides the known facts of its economy, there are certain suppositions in regard to parts of its history that are unknown, which suppositions are apparently probable enough to deserve notice.

To begin with the known facts. The Cuckow is a summer-visitant to the whole of Europe, reaching even far within the Arctic circle, and crossing the Mediterranean from its winter-quarters in Africa at the end of March or beginning of April. Its arrival is at once proclaimed by the peculiar and in nearly all languages onomatopœic cry of the cock—a true song in the technical sense of the word, since it is confined to the male sex and to the season of love. In a few days the cock is followed by the hen, and amorous contests between keen and loud-voiced suitors are to be commonly noticed, until the respective pretensions of the rivals are decided. Even by night they are not silent; but as the season advances the song is less frequently heard, and the Cuckow seems rather to avoid observation as much as possible, the more so since wherever it shows itself it is a signal for all the small birds of the neighborhood to be up in its pursuit, just as though it were a Hawk, to which indeed its mode of flight and general appearance give it an undoubted resemblance—a resemblance that misleads some beings, who ought to know better, into confounding it with the Birds-of-prey, instead of recognizing it as a harmless if not a beneficial destroyer of hairy caterpillars. Thus pass away some weeks. Towards the middle or end of June its "plain-song" cry alters; it becomes rather hoarser in tone, and its first syllable or note is doubled. Soon after it is no longer heard at all, and by the middle of July an old Cuckow is seldom to be found in these islands, though a stray example, or even, but very rarely, two or three in company, may occasionally be seen for a month longer. This is about as much as is apparent to most people of the life of the Cuckow with us. Of its breeding comparatively few have any personal experience. Yet there are those who know that diligent search for and peering into the nests of several of our commonest little birds—more especially the Pied Wagtail (*Motacilla lugubris*), the Titlark (*Anthus pratensis*), the Reed-Wren (*Acrocephalus streperus*), and the Hedge-Sparrow (*Accentor modularis*)—will be rewarded by the discovery of the egg of the mysterious stranger which has been surreptitiously introduced therein, and waiting till this egg is hatched they may be witnesses (as was the famous Jenner in the last century) of the murderous eviction of the rightful tenants of the nest by the intruder who, hoisting them one after another on its broad back, heaves them over to die neglected by their own parents, of whose solicitous care he thus becomes the only object. In this manner he thrives, and, so long as he remains in the country of his birth, his wants are anxiously supplied by the victims of his mother's dupery. The actions of his foster-parents become, when he is full grown, almost ludicrous, for they often have to perch between his shoulders to place in his gaping mouth the delicate morsels he is too indolent or too stupid to take from their bill. Early in September he begins to shift for himself, and then follows the seniors of his kin to more southern climes.

Of the way in which it seems possible that this curious habit of the Cuckow may have originated something has been already said (see BIRDS, vol. iii. p. 669). But in connection with its successful practice a good deal yet remains to be determined, most of which, however probable, is still to be proved. So much caution is used by the hen Cuckow in choosing a nest in which to deposit her egg that the act of insertion has been but seldom witnessed. The nest selected is moreover often so situated, or so built, that it would be an absolute impossibility for a bird of her size to lay her egg therein by sitting upon the fabric as birds commonly do; and there have been a few fortunate observers who have actually seen the deposition of the egg upon the ground by the Cuckow, who, then taking it in her bill, introduces it into the nest. Of these, so far at

least as this country is concerned, the earliest seem to be two Scottish lads, sons of Mr. Tripeny, a farmer in Cuxmuir, who, as recorded by Macgillivray (*Brit. Birds*, iii. pp. 130, 131), from information communicated to him by Mr. Durham Weir, saw most part of the operation performed, June 24, 1838. But perhaps the most satisfactory evidence on the point is that of Herr Adolf Müller, a forester at Gladenbach in Darmstadt, who says (*Zoolog. Garten*, 1866, pp. 374, 375) that through a telescope he watched a Cuckow as she laid her egg on a bank, and then conveyed the egg in her bill to a Wagtail's nest. Cuckows too have been not unfrequently shot as they were carrying a Cuckow's egg, presumably their own, in their bill, and this has probably given rise to the vulgar, but seemingly groundless, belief that they suck the eggs of other kinds of birds. More than this, Mr. Rowley, who has had much experience of Cuckows, declares (*Ibis*, 1865, p. 186) his opinion to be that traces of violence and of a scuffle between the intruder and the owners of the nest at the time of introducing the egg often appear, whence we are led to suppose that the Cuckow ordinarily, when inserting her egg, excites the fury (already stimulated by her Hawk-like appearance) of the owners of the nest by turning out one or more of the eggs that may be already laid therein, and thus induces the dupe to brood all the more readily and more strongly what is left to her. Of the assertion that the Cuckow herself takes any interest in the future welfare of the egg she has foisted on her victim, or of its product, there is no evidence worth a moment's attention.

But a much more curious assertion has also been made, and one that at first sight appears so incomprehensible as to cause little surprise at the neglect it long encountered. To this currency was first given more than a hundred years ago by Salerne (*L'Hist. Nat.* etc., Paris: 1767, p. 42), who was, however, hardly a believer in it, and it is to the effect, as he was told by an inhabitant of Sologne, that the egg of a Cuckow resembles in color that of the eggs normally laid by the kind of bird in whose nest it is placed. In 1853 the same notion was prominently and independently brought forward by Dr. Baldamus (*Naumannia*, 1853, pp. 307-328), and in time became known to English ornithologists, most of whom were sceptical as to its truth, as well they might be, since no likeness whatever is ordinarily apparent in the very familiar case of the blue-green egg of the Hedge-Sparrow and that of the Cuckow, which is so often found beside it.<sup>1</sup> Dr. Baldamus based his notion on a series of eggs in his cabinet,<sup>2</sup> a selection from which he figured in illustration of his paper, and, however the thing may be accounted for, it seems impossible to resist, save on one supposition, the force of the testimony these specimens afford. This one supposition is that the eggs have been wrongly ascribed to the Cuckow, and that they are only exceptionally large examples of the eggs of the birds in the nests of which they were found, for it cannot be gainsaid that some such abnormal examples are occasionally to be met with. But it is well known that abnormally-large eggs are not only often deficient in depth of color, but still more often in stoutness of shell. Applying these rough criteria to Dr. Baldamus's series, most of the specimens stand the test very well, and, though no doubt more precise and delicate examination than any to which they seem to have been submitted, were desirable, there are some other considerations to be urged. For instance, Herr Braune, a forester at Greiz in the principality of Reuss (*Naumannia*, tom. cit. pp. 307, 313), shot a hen Cuckow as she was leaving the nest of an Icterine Warbler (*Hypolais icterina*). In the oviduct of this Cuckow he found an egg colored very like that of the Warbler, and on looking into the nest he found there an exactly similar egg, which there can be no reasonable doubt had just been laid by that very Cuckow. Moreover Herr Grunack (*Journ. für Orn.*, 1873, p. 454) has since found one of the most abnormally-colored specimens, quite unlike the ordinary egg of the Cuckow, to contain an embryo so fully formed as to show the characteristic zygodactyl feet of the bird, thus proving unquestionably its parentage. Now these being both of them extreme cases, Dr. Baldamus may fairly claim attention to his assertion; for short of absolutely disbelieving his word we must admit that he has ground for it. On the other hand, we must bear in mind the numerous instances in which not the least similarity can be traced—

<sup>1</sup> An instance to the contrary has been recorded by Mr. A. C. Smith (*Zoologist*, 1878, p. 3516) on Mr. Brine's authority.

<sup>2</sup> This series was seen in 1861 by the writer.

as in the not uncommon case of the Hedge-Sparrow already mentioned, and if we attempt any explanatory hypothesis it must be one that will fit all round. Such a one then seems to be this. We know that certain kinds of birds resent interference with their nests much less than others, and among them it may be asserted that the Hedge-Sparrow will patiently submit to various experiments. She will brood with complacency the egg of a Redbreast (*Eriothacus rubecula*), so unlike her own, and for aught we know to the contrary may even be color-blind. In the case of such a species there would be no need of anything further to insure success—the terror of the nest-owner at seeing her home invaded by a Hawk-like giant, and some of her treasures tossed out, would be enough to stir her motherly feelings so deeply that she would without misgiving, if not with joy that something had been spared to her, resume the duty of incubation so soon as the danger was past. But with other species it may be, nay doubtless it is, different. Here assimilation of the introduced egg to those of the rightful owner may be necessary, for there can hardly be a doubt as to the truth of Dr. Baldamus's theory (the only theory, by the way, he has put forth), as to the object of the assimilation being to render the Cuckow's egg "less easily recognized by the foster-parents as a substituted one." But in this place it is especially desirable to point out that there is not the slightest ground for imagining that the Cuckow, or any other bird, can voluntarily influence the color of the egg she is about to lay. Over that she can have no control, but its destination she can determine. It would seem also impossible that a Cuckow having laid an egg, should look at it, and then decide from its appearance in what bird's nest she should put it. That the color of an egg-shell can be in some mysterious way affected by the action of external objects on the perceptive faculties of the mother is a notion too wild to be seriously entertained. Consequently, only one explanation of the facts can here be suggested. Every one who has sufficiently studied the habits of animals will admit the tendency of some of those habits to become hereditary. That there is a reasonable probability of each Cuckow most commonly putting her eggs in the nest of the same species of bird, and of this habit being transmitted to her posterity, does not seem to be a very violent supposition. Without attributing any wonderful sagacity to her, it does not seem unlikely that the Cuckow which had once successfully foisted her egg on a Reed-Wren or a Titlark should again seek for another Reed-Wren's or another Titlark's nest (as the case may be), when she had another egg to dispose of, and that she should continue her practice from one season to another. It stands on record (*Zoologist*, 1873, p. 3648) that a pair of Wagtails built their nest for eight or nine years running in almost exactly the same spot, and that in each of those years they fostered a young Cuckow, while many other cases of like kind, though not perhaps established on authority so good, are believed to have happened. Such a habit could hardly fail to become hereditary, so that the daughter of a Cuckow which always put her egg into a Reed-Wren's, Titlark's, or Wagtail's nest would do as did her mother. Furthermore it is unquestionable that, whatever variation there may be among the eggs laid by different individuals of the same species, there is a strong family likeness between the eggs laid by the same individual, even at the interval of many years, and it can hardly be questioned that the eggs of the daughter would more or less resemble those of her mother. Hence the supposition may be fairly regarded that the habit of laying a particular style of egg is also likely to become hereditary. Combining this supposition with that as to the Cuckow's habit of using the nest of the same species becoming hereditary, it will be seen that it requires but an application of the principle of "Natural Selection" to show the probability of this principle operating in the course of time to produce the facts asserted by the anonymous Solognot of the last century, and by Dr. Baldamus and others since. The particular *gens* of Cuckow which inherited and transmitted the habit of depositing in the nest of any particular species of bird eggs having more or less resemblance to the eggs of that species would prosper most in those members of the *gens* where the likeness was strongest, and the other members would (*ceteris paribus*) in time be eliminated. As already shown, it is not to be supposed that all species, or even all individuals of a species, are duped with equal ease. The operation of this kind of natural selection would be most needed in those

cases where the species are not easily duped—that is, in those cases which occur the least frequently. Here it is we find it, for observation shows that eggs of the Cuckow deposited in nests of the Red-Backed Shrike (*Lanius Collurio*), of the Bunting (*Emberiza miliaria*), and of the Icterine Warbler approximate in their coloring to eggs of those species—species in whose nests the Cuckow rarely (in comparison with others) deposits eggs. Of species which are more easily duped, such as the Hedge-Sparrow, mention has already been made.

More or less nearly allied to our Cuckow are many other forms of the genus from various parts of Africa, Asia, and their islands, while one even reaches Australia. How many of these deserve specific recognition will long be a question among ornithologists which need not be discussed here. In some cases the chief difference is said to lie in the diversity of voice—a character only to be appreciated by those acquainted with the living birds, and though of course some regard should be paid to this distinction, the possibility of birds using different "dialects" according to the locality they inhabit (see BIRDS, vol. iii. p. 668, note 1) must make it a slender specific diagnostic. All these forms are believed to have essentially the same habits as our Cuckow, and, as regards parasiticism, the same is to be said of the large Cuckow of Southern Europe and North Africa (*Coccyzus glandarius*) which victimizes Pies (*Pica mauritanica* and *Cyanopica cooki*) and Crows (*Corvus cornix*). True it is that an instance of this species, commonly known as the Great Spotted Cuckow, having built a nest and hatched its young is on record, but the later observations of Dr. A. E. Brehm, Canon Tristram, Stafford Allen, and others tend to cast doubt on the credibility of the ancient report. It is worthy of remark that the eggs of this bird so closely resemble those of one of the Pies in whose nest they have been found, that even expert zoologists have been deceived by them, only to discover the truth when the Cuckow's embryo had been extracted from the supposed Pie's egg. This species of Cuckow, easily distinguishable by its large size, long crest, and the primrose tinge of its throat, has more than once made its appearance as a straggler in the British Isles. Equally parasitic are many other Cuckows, belonging chiefly to genera which have been more or less clearly defined as *Cuccomantis*, *Chrysoococcyx*, *Eudynamis*, *Oxylophus*, *Phenicophæes*, *Polyphasia*, *Surniculus*, and *Zanclotoma*, and inhabiting parts of the Ethiopian, Indian, and Australian Regions;<sup>1</sup> but there are certain aberrant forms of Old-World Cuckows which unquestionably do not shirk parental responsibilities. Among these especially are the birds placed in or allied to the genera *Centropus* and *Coua*—the former having a wide distribution from Egypt to New South Wales, living much on the ground and commonly called Lark-heeled Cuckows (an obvious misnomer)—the latter bearing no English name, and limited to the island of Madagascar. These build a nest, not perhaps in a highly-finished style of architecture, but one that serves its end.

Respecting the Cuckows of America, the evidence, though it has been impugned, is certainly enough to clear them from the calumny which attaches to so many of their brethren of the Old World. There are two species very well known in parts of the United States and some of the West-Indian Islands (*Coccyzus americanus* and *C. erythrophthalmus*), and each of them has occasionally visited Europe. They both build nests—remarkably small structures when compared with those of other birds of their size—and faithfully incubate their delicate sea-green eggs. In the southwestern States of the Union and thence into Central America is found another curious form of Cuckow (*Geococcyx*)—the Chaparral-cock of northern and Paisano of southern settlers. The first of these names it takes from the low brushwood (*chaparral*) in which it chiefly dwells, and the second is said to be due to its Pheasant-like (*jaisan* corrupted into *paisano*, which is properly a countryman) appearance as it runs on the ground. Indeed, one of the two species of the genus was formerly described as a *Phasianus*. They both have short wings, and seem never to fly, but run with great rapidity. Returning to arboreal forms, the genera *Neomorphus*, *Diplopterus*, *Saurolthera*, and *Piaya* (the last two commonly called Rain-birds, from the belief that their cry portends rain) may be noticed—all of them belonging to

<sup>1</sup> Evidence tends to show that the same is to be said of the curious Channel-bill (*Scothrops nova-hollandia*), but absolute proof seems to be wanting.

the Neotropical Region; but perhaps the most curious form of American Cuckows is the Ani (*Crotaphaga*), of which three species inhabit the same Region. The best-known species (*C. ans*) is found throughout the Antilles and on the opposite continent. In most of the British colonies it is known as the Black Witch, and is accused of various malpractices—it being, in truth, a perfectly harmless if not a beneficial bird. As regards its propagation this aberrant form of Cuckow departs as much in one direction from the normal habit of birds as do so many of our familiar friends of the Old World in the other, for several females unite to lay their eggs in one nest. Full details of its economy are wanting, but it is evident that incubation is carried on socially, since an intruder on approaching the rude nest will disturb perhaps half a dozen of its sable proprietors, who, loudly complaining, seek safety either in the leafy branches of the tree that holds it, or in the nearest available covert, with all the speed that their feeble powers of flight permit.

(A. N.)

**CUCUMBER** (*Cucumis*), a genus of the natural order *Cucurbitaceæ*, represented by indigenous species in most warm regions of the globe, and distinguished by the following characters:—plants, annual or possessing a perennial thick root; stems, rarely if ever climbing; leaves, heart-shaped, sometimes reniform, with three to seven lobes, and crenulate or denticulate margin; flowers, monœcious and yellow, having tubular campanulate calices, petals but slightly adherent, three free stamens, and a tripartite, obtuse, and spheroidal stigma; fruits or pepones, three to six celled, smooth or echinate; and seeds, more or less compressed, ovate, sharp-edged, and of a yellow or dirty-white color. *Cucumis sativus*, the common cucumber, is an annual, indigenous probably to tropical Asia; the branches ramify little; the leaves are hairy and have three to five sharply-pointed lobes; the ovary is often fusiform; the fruits are for the most part oblong, obscurely trigonal or cylindrical, and except in one variety contain three carpels, and their flesh is white, firm, and of an agreeable sub-acid taste. In its characters it is one of the most uniform species of its genus. The principal varieties are (1) the small Russian cucumber, the fruit of which is ovoid, smooth, scarcely larger than a hen's egg, and when ripe of a dull orange color; (2) the common long cucumber; (3) the white cucumber, with fruits usually shorter and proportionally thicker than in the preceding kind; (4) the Sikkim cucumber, the leaves of which may be seven or even nine-lobed, while its fruits are long-oval in shape, have the skin marbled with yellowish-white and reddish-brown, and regularly contain five placentae.

The cucumber usually trails on the ground, but it can be made to grow well in an upright position, supported by its tendrils. It thrives best in deep, loose, and rich earth, but if supplied with liquid manure it may be cultivated in old tan or brick-rubbish. An excellent soil is a sandy loam with a fourth part of rotten dung intermixed. A damp atmosphere and a temperature of from 75° to 80° Fahr., with plenty of light, are the conditions best suited to the cucumber; but it can be grown at so low a temperature as 50°, and will bear fruit at 60°; in the presence of abundant moisture a heat between 90° and 110° may be borne. Exposure to the air on cold nights is highly injurious to the plants, rendering them sickly, and rapidly producing mildew. In England cucumbers are cultivated in dung and hot-beds, also in pots, and during summer in the open fields. At Sandy in Bedfordshire the temperature of the soil of cucumber plantations is in a week or ten days raised 8° or 10° above that of the neighboring soil by turning in the surface-earth, and covering the ground with litter at the close of every sunny day. To promote the formation of fruit the young shoots of the cucumber should be nipped off occasionally between the thumb and finger, and should be allowed to proceed no further than the second joint beyond the fading fruit-blossom. The plants are raised from both seeds and cuttings. For procuring good seed the following method has been given. A strong plant is chosen, and allowed to bear only one fruit, which when ripe and yellow, is cut and laid by in a dry place; when it begins to rot, it is cut in pieces, the pulp is allowed to ferment, and the seeds are then washed from it with water, those which float being rejected. The seed retains its vitality for a considerable period, and that which has been kept for some years is said to produce the best fruit-bearing plants. The seed-bed for cucumbers is made 3 feet high at the back, and

6 inches less in front. After its preparation eight or nine days are allowed to elapse before the seed is sown. The tops of the young plants are kept at a distance of 6 or 8 inches from the glass of the frame by lowering from time to time the pots in which they grow. By pinching off the leading shoot that rises at the base of the petiole, fresh shoots are made to proceed from the base of the seed-leaves; these are in their turn nipped back when the length of two joints. Plants grown in winter in frames and hot-houses are given as much light and air as possible, and care is taken not to supply them with very cold water. On account of their expense, dung-beds have been generally superseded by hot-beds for the growth of cucumbers. The cucumber is a common vegetable in all parts of India; in the cold season it is cultivated in the grain fields, and in summer in the sandy beds and islands of rivers. In Cashmere, as in China and Persia, cucumbers and melons are grown in the lakes on floats formed by cutting through, at about 2 feet under the water, the roots of sedges, reeds, and other aquatic plants, which, being pressed together, are made to form a bed about 2 yards in breadth, and of indefinite length. The heads of the plants are next cut off, laid upon its surface, and covered with a thin coat of mud. The float is moored in its place by a stake of willow driven through it at each end, and conferva and weeds from the bottom of the lake are piled on it in conical mounds about 2 feet in height, and 2 feet broad at the base, and having a hollow at the top filled with soft mud, in which the young cucumber and melon plants are placed. No further labor is requisite save that of gathering the fruit (*Moorcroft, Journ. R. Geog. Soc.*, ii, p. 258).

The varieties of the common cucumber are exceedingly numerous, and constantly changing. Among the longer sorts may be mentioned Dale's Conqueror, Blue Gown, and Hamilton's Invincible. Though generally eaten as a salad or pickled, the cucumber is used in the preparation of various cooked dishes, and is occasionally preserved. The juice is said to be an ingredient in some pomades and cosmetics. For pickling, the young unripe fruit, or gherkins, and the Russian variety are employed. Cucumbers were much esteemed by the ancients. According to Pliny (ix. 23), the Emperor Tiberius was supplied with them daily, both in summer and winter. Naudin enumerates thirteen well-determined and eight doubtful species of the genus *Cucumis*. Of one of these, *C. Figaroi*, he describes five, and of another, *C. Melo*, or the melon, no less than thirty varieties. Among the latter is the *C. Chate* of Linnæus, the fruit of which is supposed to be the same as the *kishum* or "cucumbers" of the Scriptures (Num. xi. 5; Isa. i. 8; Baruch vi. 70). Forskal describes the plant as follows:—"Stalks smooth, with rigid bristles; leaves lobed, scabrous on both sides, with obtuse angles; fruit, hairy when young, smooth when old, attenuated at both ends." The fruit, he tells us, is common in Egypt, where it is grown in the open fields. By many a drink is prepared from it when ripe. The pulp is broken and stirred by means of a stick thrust through a hole cut at the umbilicus of the fruit; the hole is then closed with wax, and the fruit, without removing it from its stem, is buried in a little pit; after some days the pulp is found to be covered into an agreeable liquid (*Flora Ægyptiaco-Arabica*, p. 163, 1775). Various species of *Anguria*, *Citrullus*, *Coccinea*, *Cucurbita*, *Ecolanium*, *Luffa*, *Melothria*, *Mukia*, *Sicyos*, *Telfaria*, and *Trichosanthes* have been referred to the genus *Cucumis*. The squiring cucumber, *Ecolanium elaterium*, the *Σκιν δῦπος* of Theophrastus, furnishes the drug elaterium. Owing to the exosmosis of the juice of the fruit through the strong cortical tissues that line its central cavity, a pressure is accumulated sufficient to cause the severance of the fruit from its peduncle, and the consequent sudden ejection of its contents. The *Cucumis serotinus* of Turkey and *C. Conomon* of Japan are varieties of *C. Melo*; the "serpencucumber" of Central America is the species *Trichosanthes colubrina*.

Watkins, *Art of Promoting the Growth of the Cucumber and Melon*, 1824; Weeden, *Practical Treatise on the Growth of Cucumbers*, 1832; Royle, *Himalayan Botany*, vol. i. p. 218, 1844; Duncan, *Treatise on the Culture of the Cucumber*, 1841; Ayres, *Cultivation of Cucumbers in Pots*, 1850; Naudin, in *Annal. des Sci. Nat.*, 4e. ser. Bot. t. xl. p. 5, 1859; Loudon, *Horticulturist*, ed. Robinson, 1871.

CUDDALOR, or GUDALUR, a municipal town of British India, in the Madras Presidency and the district of South

Arcot, situated on the western shore of the Bay of Bengal at the estuary of the River Panar, 102 miles S. S. W. from Madras, and 15 S. S. W. from Pondicherry. It lies low, but is regarded as exceptionally healthy, and serves as a kind of sanatorium of the surrounding district. The principal trade is the export of cotton; but some attention is also given to the fisheries and the manufacture of paper, sugar, and salt. In the neighborhood are the ruins of the fort of St. David. The English East India Company obtained a grant of the town from the rajah of Gingee in 1681; and their factory was, in consequence of the increasing trade, wholly rebuilt and fortified in 1702. The town was taken by the French in 1758; but two years later it was recaptured by Sir Eyre Coote. In 1782, after the destruction of Colonel Braithwaite's detachment by Tipoo, it was forced to surrender to the combined forces of the French and Hyder Ali, when the works were greatly strengthened, and a strong garrison sent to defend them. In 1783 it was besieged by the British, who were repulsed, with the loss of 942 killed and wounded, in a desperate attempt to storm the works. It finally passed into British possession by the treaty of 1795. Population in 1871, 40,290.

CUDDAPAH, or KADAPA, a district of British India in the presidency of Fort St. George or Madras, situated between 13° 12' and 16° 19' N. lat. and 77° 52' and 79° 48' E. long. It is bounded on the N. by Karanau, on the E. by Nellor, on the S. by North Arcot and Mysore; and on the E. by Ballárí. The district is in shape an irregular parallelogram, divided into two nearly equal parts by the range of the Eastern Gháts which intersects it throughout its entire length. The two tracts thus formed possess totally different features. The first, which constitutes the north, east, and south-east of the district, is a low-lying plain; while the other, which comprises the southern and south-western portion, forms a high table-land from 1500 to 2500 feet above sea-level. The chief river is the Penaur, which enters the district from Ballárí on the west, and flows eastwards into Nellor. Though a large and broad river, and in the rains containing a great volume of water, in the hot weather months it dwindles down to a very inconsiderable stream. Its principal tributaries are the Kundaur, Saglaur, Cheyair, and Papagni rivers. The total area of the district is 8367 square miles, of which 2728 were reserved as under cultivation in 1874-75. Cuddapah is subdivided into eleven *taluks* or sub-districts, and contains 1062 villages. The population in 1872 was returned as follows:—Hindus, 1,242,317; Mahometans, 103,676; Native Christians, 4068; Europeans and Eurasians, 202; Buddhists, 4; others, 387; total, 1,351,194. The principal town and the administrative head-quarters of the district is Cuddapah, situated on the banks of the Bogá River in 14° 32' N. lat. and 78° 54' E. long. Population—Hindus, 10,611; Mahometans, 5338; Christians, 222; others, 104; total, 16,275. The total revenue of Cuddapah district in 1874-75 amounted to £245,222, of which £200,987 was derived from the land assessment.

CUDWORTH, RALPH (1617-1688), the most learned and philosophical of the Cambridge Platonists, was born at Aller, Somersetshire, in 1617. His father, rector of Aller, and an editor of Perkins's works, died in 1624. His widow married a second time Dr. Stoughton, under whose care young Cudworth was well grounded in school learning. In 1630 he was entered a pensioner in Emmanuel College, Cambridge, of which his father had been a fellow. He commenced residence in 1632, took the degree of M. A. in 1639, and was soon after chosen fellow, and became so eminent as a tutor as to have at one time twenty-eight pupils. He was next presented to the rectory of North Cadbury in his native county, and in 1642 he published a *Discourse concerning the true Notion of the Lord's Supper*, and a treatise entitled, *The Union of Christ and the Church, in a Shadow*. In 1644 he took the degree of B. D., and in the same year was chosen master of Clare Hall. In the following year he was appointed professor of Hebrew, and for some time devoted himself with special zeal to the study of Jewish antiquities. Two years after (March 31, 1647), he preached before the House of Commons on 1 John ii. 3, 4, and his discourse on this occasion was published, along with another sermon following out the theme. For some time it appeared as if the insufficiency of his income would force him to leave Cambridge, but this loss to the university was averted by his appointment to the

mastership of Christ's College in 1654. He was one of the persons named by a committee of Parliament in 1657 for the revision of the English translation of the Bible. Through his intimacy with Thurloe, the secretary of state for Cromwell and his son Richard, he was confidentially consulted on various occasions by the Protectors in regard to university and Government appointments. In 1659 we find him engaged with discourses in defence of Christianity against Judaism. Like so many others, he published Latin verses on the restoration of King Charles II. in 1660. He was presented to the rectory of Ashwell in Herefordshire in 1662, and installed prebendary of Gloucester in 1678. He had a design in 1665 to publish a treatise concerning moral good and evil, and as he had been encouraged to do so by Dr. Henry More, the latter's *Enchiridion Ethicum* appears to have almost occasioned a rupture of friendly relations between them. Cudworth's *magnum opus*, the *True Intellectual System of the Universe, wherein all the Reason and Philosophy of Atheism is refuted, and its Impossibility demonstrated*, appeared in 1678. This marvellously learned work, bulky as it is, is merely a fragment, the first of three parts,—the *Treatise on Eternal and Immutable Morality*, published in 1731 by Bishop Chandler, and a *Discourse on Liberty and Necessity*, belonging to the same whole. Its publication had been delayed for seven years, owing to the opposition of some parties at court, probably admirers of Hobbes. It was flatteringly received in the learned world, but offended the narrowly orthodox as well as the sceptics against whom it was written. Some persons were even so thoughtless or malicious as to construe the candor with which its author stated the arguments of atheists as a device to lead his readers to believe that the atheist had the best of the reasoning. If Warburton may be credited, misrepresentations of this kind deterred Cudworth, a peaceable man, averse to theological polemics, from publishing the rest of his work. He died at Cambridge on the 26th of June, 1688, and was buried in the chapel of Christ's College. He left behind him a daughter, Damaris, a lady of considerable genius, known, under the name of Lady Masham, as the intimate and valued friend of John Locke. Several of Cudworth's MSS. are preserved in the British Museum. It is not to the national credit that, with the exception of *A Treatise of Freewill*, edited by the Rev. Mr. Allen in 1838, they have not only not been published, but no adequate account or summary has been given of them.

The *True Intellectual System*, to justify its general title and fulfil its author's plan, should have contained two other parts, each on the same scale as the part which we possess. There appeared to Cudworth to be three systems which deny liberty and involve necessity,—three sorts of fatalism. The first is materialistic fatalism, which suppresses with the idea of liberty every idea of God and spirit, and explains all phenomena, even those of thought and feeling, by mechanical laws, and the formation of all beings by the combination and concurrence of atoms; the second is a theological or religious fatalism, advocated by various scholastic and later divines, which makes good and evil, right and wrong, the creation of the will of God, and thus destroys liberty by destroying its condition and its law; and the third is Stoical fatalism, which, although not denying the Divine existence or the rectitude of the Divine nature, affirms that all that happens is determined by an eternal and unchangeable necessity. These are the three chief false systems of the universe, according to Cudworth, and he would oppose to them three great principles, the fundamentals or essentials of religion:—to the first the existence of God and of a spiritual world; to the second the eternal and immutable distinction of right and wrong; and to the third the freedom and responsibility of man. The proof of these three truths with the refutation of the opposite errors seemed to him to be the establishment of a system of the universe entitled to be called, in opposition to those refuted, *true*, and, in distinction from physical systems like the Ptolemaic, Tyconic, and Copernican, *intellectual*. The first of these forms of fatalism is the only one with which his principal work deals. It includes four species of materialistic atheism, namely,—the atomic adopted by Democritus, Epicurus, and Hobbes, which recognizes no other substances than material atoms, and no other forces than their movements; the hylopathic, maintained by Anaximander, which makes infinite matter, devoid of understanding and life, form all things by "a

secretion or segregation" which takes place according to inherent law; the hylozoic, asserted by Strato of Lampascus, which explains everything by the supposition of an inward, self-organizing, plastic life in matter; and the cosmoplastic, perhaps held by Seneca and the younger Pliny, which represents the universe as an organized being, like a plant, with a spontaneous and necessary, but unconscious and unreflective development. They are, however, reducible to two—the atomic and hylozoic—the one best represented by Democritus, the other by Strato; the one explaining everything by matter and movement, the other everything by matter endowed with life; the one mechanical, the other dynamical.

The history of the atomic philosophy is narrated by Cudworth at great length and with vast erudition, but no one will now be found to accept the view which he gives of its development as even in the main accurate. Like his friend Henry More, he derives the atomic theory, in so far as it is a purely physical speculation, from Moses, and his conclusions as to its transmission are in many respects not less untrustworthy. He would make it out to have been taught by Pythagoras, Empedocles, and, in fact, nearly all the ancient philosophers, and only to have been mutilated and perverted by Leucippus and Democritus. He had the merit, however, of seeing very clearly that the atomic theory in itself, or what he calls the atomic physiology, had no natural or even necessary connection with the atomic atheism. He contends that "so far from being either the mother or nurse of atheism, or any ways favorable thereto (as is vulgarly supposed), it is indeed the most opposite to it of any, and the greatest defence against the same." He states with great fulness and fairness the arguments which have been urged in support both of the atomic and hylozoic atheism. He refutes them, although in a cumbrous and discursive manner, with great strength of reason. It is in connection with the refutation of hylozoic atheism that he brings forward the celebrated hypothesis, which he held in common with More, of a plastic nature,—a substance intermediate between matter and spirit,—a power which prosecutes certain ends but not freely or intelligently,—an instrument by which laws are able to act without the immediate agency of God. He argues that to refer the life and motion of the universe immediately to God renders divine providence "operose, solicitous, and distractious," implies that all things are done miraculously and none of them by an inward principle of their own, and is inconsistent with the slow and gradual development of nature and with its "errors and bumbles." It is not wonderful that few should have been convinced by such arguments. Nothing can be toilsome to omnipotence or perplexing to omniscience. It is not more difficult to believe the life and motions of the universe due to the immediate action of God than the life and motions of the secondary agent which Cudworth imagined to animate nature and "drudgingly to execute a part of the work of providence." An unconscious and "necessitated plastic power" cannot remove from the creator of it the blame of any "errors or bumbles" it may commit. Cudworth's hypothesis became in 1703-4 the subject of an interesting controversy between Bayle and Leclerc,—the former maintaining, and the latter denying, that it was favorable to the atheistical inference. It has been recently reproduced by Joseph John Murphy in his work on *Habit and Intelligence*. What Cudworth designated "plastic nature" is almost identical with what Murphy calls "unconscious intelligence." It was descended from the *anima mundi* of Plato, and is still represented in the *Unbewusste* of Von Hartmann.

After the three chapters which describe and refute atomic and hylozoic atheism, there comes a fourth which "swells," as Cudworth himself says, "into a disproportionate bigness." Its aim is to prove that the belief in one supreme God has been generally entertained even throughout the pagan world; that only a few men, darkened in mind and depraved in heart, have discarded and denied it; and that polytheism was the worship of many gods subordinate to the One God, of the One God under many names, and of the One God and subordinate gods in images and symbols, but not the exclusion of the worship of "one sovereign and omnipotent Deity from which all their other gods were generated or created." Nowhere does our author show more learning or more elevation or breadth of thought than in the survey of religions which

this discussion involves. He carefully searches in the heathen religions which he reviews for features of truth, traces of the presence of God, evidences of his having never left himself without a witness in human hearts. At the same time his reasoning is, on the whole, far from satisfactory. It is at many points perverted by the unconscious desire to establish a foregone conclusion; and the testimonies brought forward have as often meanings imposed on them as deduced from them. The lengthened discussion of the Platonic and Christian Trinities contained in this chapter gave great dissatisfaction to various persons. Cudworth was accused by some, in consequence of it, with being a Tritheist, and by others of being an Arian. He could not possibly be both; he undoubtedly meant to be neither. He wished to be orthodox, and believed that he was so. He erred chiefly by representing Plato as having come far nearer to the Christian doctrine than he really did.

What is of most interest, perhaps, in the last chapter is the attempt at a positive demonstration of the existence of God. This, he explains, cannot be accomplished *a priori*, as if from anything antecedent to the divine existence, but may nevertheless be necessarily inferred from undeniable principles of reason. He refutes the assertion of Descartes that we can be certain of nothing, not even of mathematical reasoning and truth, till certain that there is a God, good and holy, who cannot and will not deceive us. He shows that although this hypothesis bears a resemblance of piety, it really leads to universal scepticism. He then adduces three metaphysical proofs of the divine existence. The first is substantially that of Anselm and Descartes, drawn from the idea of an absolutely perfect being. Cudworth modifies it, however, in the same way which Leibnitz soon afterwards also did. He does not, that is to say, conclude at once the divine existence from the idea of a perfect being, but shows before doing so that this idea is accordant with reason, *i. e.*, involves in it no contradiction. The second proof, instead of thus proceeding from the idea of perfection to that of necessary existence, proceeds from the idea of existence to that of perfection. Theists and atheists, materialists and spiritualists, agree that something certainly existed of itself from all eternity. They differ only as to whether that something be a perfect or an imperfect Being. But that which existed from all eternity must have done so naturally and necessarily, including necessary and eternal self-existence in its own nature. There is nothing, however, it is argued, which contains necessary eternal existence in its own nature or essence, but only an absolutely perfect Being,—all imperfect things being in their nature contingently possible, either to be or not to be. Hence a perfect Being, or God, existed of himself from eternity. The third argument is founded on the very nature of knowledge. It is that knowledge is possible only through ideas which must have their source in an eternal reason. Sense is not only not the whole of knowledge, but is in itself not at all knowledge; it is wholly relative and individual, and not knowledge until the mind adds to it what is absolute and universal. Knowledge does not begin with what is individual but with what is universal. The individual is known by being brought under a universal instead of the universal being gathered from a multitude of individuals. And these universals, *νοήματα*, or ideas, which underlie all the knowledge of all men, which originate it, and do not originate in it, have existed eternally in the only mode in which truths can be said to be eternal, in an eternal mind. They come to us from an Eternal mind, which is their proper home, and of which human reason is an emanation. "From whence it cometh to pass, that all minds, in the several places and ages of the world, have ideas or notions of things exactly alike, and truths indivisibly the same. Truths are not multiplied by the diversity of minds that apprehend them; because they are all but ectypal participations of one and the same original or archetypal mind and truth. As the same face may be reflected in several glasses, and the image of the same sun may be in a thousand eyes at once beholding it, and one and the same voice may be in a thousand ears listening to it, so when innumerable created minds have the same ideas of things, and understand the same truths, it is but one and the same eternal light that is reflected in them all ('that light which enlighteneth every man that cometh into the world'), or the same voice of that one everlasting Word, that is never

silent, re-echoed by them." In different forms and with different references this argument is to be found in Plato, Augustine, Aquinas, Malebranche, Bossuet, Fénelon, Cousin, and Ferrier.

The *Treatise concerning Eternal and Immutable Morality* deals with the second form of fatalism. Over against the assertion that all moral good and evil is arbitrary and factitious, not by nature but by law, there is placed the directly contradictory proposition, nothing is morally good or evil by mere will without nature. Whatever is at all must be what it is not by will but by nature. Omnipotence itself cannot set aside this condition, cannot do what is contradictory; and contradictory it is that things should be what they are not, should be indifferently anything, either this or that, round or square, white or black, according to mere will and pleasure. And "things may as well be made white or black by mere will without whiteness or blackness, equal and unequal without equality and inequality, as morally good and evil, just and unjust, honest and dishonest, by mere will, without any nature of goodness, justice, honesty." The existence of merely positive duties,—the fact that certain commands carry with them an obligatory force, and that it is often wrong to do a thing which has been forbidden although it would have been otherwise quite legitimate,—is argued to be no exception to this truth, since in all such cases the obligation springs not from mere will but from a deeper source, from an underlying natural justice or equity, which is the true foundation both of the right in a superior to command and of obligation in an inferior to obey. Cudworth is thus led to discriminate precisely natural from positive right. Things naturally good are those which the reason obliges us to immediately, absolutely, and perpetually, and on no condition of any voluntary act that may be done or omitted intervening; things positively good are those which the reason obliges to only through the intervention of some such act bringing them under some rule of natural justice. But even the things which thus pass from being indifferent to being positively right or wrong are strictly speaking only brought into a new relation to us, and have not a new nature bestowed on themselves. They remain in themselves what they were,—indifferent, neither good nor evil. And any moral character which may be ascribed to the doing of them consists not in what is done, but in a regard to the natural right which dictates fidelity to engagements and submission to just authorities. Will thus carries with it no creative moral force,—as mere will, indeed, no moral force whatever. Cudworth completes his proof of this position by a refutation of the opinion that rectitude, although not dependent on the will of the creature, depends on the mere will of the Creator. He argues that it represents what is really a contradiction to be the object of divine power. He further insists that there is in God a wisdom superior to His will and a goodness superior to His wisdom; that the perfection of will is to be thus twice determined, first by wisdom and then by goodness, first by truth and then by righteousness. That moral distinctions are arbitrary, grounded not in reality but in will, Cudworth saw was the necessary consequence of a belief that all cognizable distinctions are arbitrary, that all being and knowledge are relative, having no real existence in themselves but only an existence of appearance relative to something else. He perceived with perfect clearness that unless there is an absolute in knowledge there can be no absolute in morals. The larger portion of his treatise is, in consequence, an examination into the nature of sense and knowledge, designed to prove that sense is not knowledge; that sense is a confused perception obtruded on the soul from without, whereas knowledge is an inward native energy of the mind, not arising from things acting from without; that even simple corporeal things, passively perceived by sense, are known or understood only by the active power of the mind; that some ideas of the mind proceed not from outward sensible things, but arise from the inward activity of the mind itself; that the intelligible notions of things, though existing only in the mind, are not figments of the mind, but have an immutable nature; that science or knowledge is the only firm thing in the universe. Among the ideas not drawn from sense but imposed by reason on particular acts, Cudworth places the conceptions of moral good and evil. These, like other noemata, are necessary, eternal, and immutable. They are not created by reason but essential to reason. Reason does not find them, but

brings them with it. Reason, however, and not sense or feeling of any kind, is their organon. Sense apprehends in the imperfect way it does only through the working of reason; feeling is ever varying and individual. Sense is altogether blind to whatever partakes of the necessary; feeling is in no direct contact with what really and absolutely is. Adam Smith and many others have pronounced this conclusion absurd and unintelligible, without attending to the circumstance that Cudworth has at least endeavored, and laboriously endeavored, to show by his examination of sense and knowledge that what is really altogether absurd and unintelligible is that mere sense should give us any knowledge whatever,—that sense should ever rise to the rank of perception until reason has brought its object under some universal category.

In the tractate on free-will he endeavors to establish that man possesses a contingent or fortuitous liberty of self-determination when there is a perfect equality of objects. He rests this conclusion on two arguments:—first, that otherwise were a second world created exactly like the present it would have an exactly similar history; and, secondly, that otherwise the mind could make no choice in the many cases where several objects precisely alike were presented to it. He sees clearly, at the same time, that this power is not the free-will which is the condition of praise and blame. In every conceivable case where two objects of choice perfectly equal are presented to the mind, praise or blame for the preference of the one to the other is unreasonable. It is only the preference of the better to the worse that is praiseworthy; only the preference of the worse to the better that is blameworthy. Accordingly he argues that man has also a power of determining himself better or worse. In the prosecution of this argument he finds it requisite to maintain that there are not two separate faculties in the soul, the one confined to will and the other to understanding, but that there is a soul which wills understandingly and understands willingly. Its first motive principle is the desire of good in general. Its freewill is distinctive of a rational imperfect being. A perfect being, essentially good and wise, cannot have such a power, it being impossible it should ever improve, much less impair itself. He endeavors to refute not only the arguments designed to show freedom impossible, but those intended to prove it confined to Deity.

Vast erudition was combined in Cudworth with remarkable speculative power. The extent and obtrusiveness of his erudition and his discursiveness in argumentation have caused him to get much less credit for philosophical ability than he deserves. It is only the real student of his writings who can be expected to recognize it; and, although he may be often consulted, he is probably now seldom studied.

Thomas Birch's *Account of the Life and Writings of Ralph Cudworth, D. D.*, is the chief, but very inadequate, biographical authority. In all respects the best view of Cudworth, as a man and a philosopher, is that given by Principal Talloch in *Rational Theology*, etc., vol. ii. There is a good special dissertation on "the plastic nature" by Janet, and an excellent estimate of Cudworth as a Platonist in Prof. v. Stein's *Sieben Bücher aus Geschichte des Platonismus*, B. vi. (p. 7.)

CUENCA, a province of New Castile, Spain, lying between 39° 20' and 40° 40' N. lat., and 1° 10' and 3° 10' W. long., with the provinces of Guadalajara and Teruel on the N., Valencia on the E., Albacete and Ciudad Real on the S., Toledo on the W., and Madrid on the N. W. Area, 6728 square miles. It occupies the eastern part of the ancient kingdom of New Castile, and slopes from the Sierra de Cuenca (highest point, the Cerro de San Felipe, on the N. E. border of the province, 5905 feet) down into the great southern Castilian plain watered by the upper streams of the Guadiana. The rocky and bare highland of Cuenca on the north and east includes the upper valley of the Júcar or Xucar and its tributary streams, but in the north-west the province is watered by tributaries of the Tagus. The forests are proverbial for their pine timber, and rival those of Soria; considerable quantities of timber are floated down the Tagus to Aranjuez, and thence taken to Madrid for building purposes. Excessive droughts prevail; the climate of the hills and of the high plateaus is rude and cold, but the valleys are excessively hot in summer. The soil where well watered is fertile, but little attention is paid to agriculture, and three-fourths of the area is left under pasture. The rearing of cattle, asses, mules, and sheep is the

principal employment of the people; olive oil, nuts, wine, wheat, silk, wax, and honey are the chief products of the province. Mining of iron, copper, alum, and saltpetre is carried on to a small extent; jasper and agates are found. Manufactures are limited to the coarsest stuffs. Population in 1870, 238,731.

CUENCA, the capital of the above province, and the seat of a bishop, is finely placed on a rocky eminence girt about with hills, beside the river Jucar at its confluence with the stream of the Huecar, at an elevation 2960 feet above the sea, and distant about eighty-five miles E. S. E. from Madrid. It was once a flourishing town, celebrated in arts and literature, and the focus of the provincial wool-trade, but has now a population of barely 7400. Its cathedral was founded by Alphonso VIII. in 1177, and is one of the most remarkable in Spain. A fine bridge (erected in 1523) passes over the Jucar to the convent of San Pablo. A few paper mills, and some wool-washing and silver-working are the remnant of its former industries.

CUENCA, an inland town of the Andes of Ecuador, S. America, about 190 miles S. of Quito and 60 miles S. E. of the port of Guayaquil. It stands on a plain at an elevation of about 8640 feet above the sea, near the hill of Farqui, chosen by the French astronomers as their meridian in 1742. It is a cathedral city, and contains several monasteries, besides a college and other educational institutions. Cuenca has an extensive trade in cheese, oats, grain, and other agricultural produce. The population, which is estimated at 25,000, is in great part Indian. In the redivision of the republic into 11 provinces, which took place in 1875, the former province of Cuenca ceased to bear that name.

CUIRASS, or CORSELET, the plate armor, whether formed of a single piece of metal or other rigid material or composed of two or more pieces, which covers the front of the wearer's person. In a suit of armor, however, since this important piece would be worn in connection with a corresponding defence for the back, the term *cuirass* commonly is understood to imply the complete body-armor, including both the breast and the back plates. Thus this complete body-armor appears in the Middle Ages frequently to have been described as a "pair of plates. The *corselet*, a comparatively light cuirass, is more strictly a breast-plate only. As parts of the military equipment of classic antiquity, cuirasses and corslets of bronze, and at later periods also of iron or some other rigid substance, were habitually in use; but while some special kind of secondary protection for the breast had been worn in earlier times by the men-at-arms in addition to their mail hauberks and their "cotes," armed with splints and studs, it was not till the 14th century that a regular body-defence of plate can be said to have become an established component of mediæval armor. As this century continued to advance, the cuirass is found gradually to have come into general use, in connection with plate defences for the limbs, until, at the close of the century the long-familiar interlinked chain-mail is no longer visible in knightly figures, except in the camail of the basinet and at the edge of the hauberk. The prevailing and indeed almost the universal, usage throughout this century was that the cuirass was worn covered. Thus, the globose form of the breast-armor of the Black Prince, in his effigy in Canterbury Cathedral, 1376, intimates that a cuirass as well as a hauberk is to be considered to have been covered by the royalty-emblazoned jupon of the Prince. The cuirass, thus worn in the 14th century, was always made of sufficient length to rest on the hips; otherwise, if not thus supported, it must have been suspended from the shoulders, in which case it would have effectually interfered with the free and vigorous action of the wearer. Early in the 15th century, the entire panoply of plate, including the cuirass, began to be worn without any surcoat; but in the concluding quarter of the century the short surcoat, with full short sleeves, known as the tabard, was in general use over the armor. At the same time that the disuse of the surcoat became general, small plates of various forms and sizes (and not always made in pairs, the plate for the right or sword arm often being smaller and lighter than its companion), were attached to the armor in front of the shoulders, to defend the otherwise vulnerable points where the plate defences of the upper-arms and the cuirass left a gap on each side. About the middle of the century, instead of being formed of a single plate, the breast-plate of the cuirass was made in two parts, the lower adjusted to over-

lap the upper, and contrived by means of a strap or sliding rivet to give flexibility to this defence. In the second half of this 15th century the cuirass occasionally was superseded by the "brigandine jacket," a defence formed of some textile fabric, generally of rich material, lined throughout with overlapping scales of metal, which were attached to the jacket by rivets, having their heads, like studs, visible on the outside. In the 16th century, when occasionally, and by personages of exalted rank, splendid surcoats were worn over the armor, the cuirass—its breast-piece during the first half of the century globular in form—was constantly reinforced by strong additional plates attached to it by rivets or screws. About 1550 the breast-piece of the cuirass was characterized by a central ridge, called the "tapul" having near its centre a projecting point; this projection, somewhat later, was brought lower down, and eventually the profile of the plate, the projection having been carried to its base, assumed the singular form which led to this fashion of the cuirass being distinguished as the "peascod cuirass." Corslets provided with both breast and back pieces were worn by foot-soldiers in the 17th century, while their mounted comrades were equipped in heavier and stronger cuirasses; and these defences continued in use after the other pieces of armor, one by one, had gradually been laid aside. The cuirass and the corslet also at last ceased to be worn, until their revival in modern armies, in which mounted cuirassiers, armed as in earlier days with breast and back plates, in some degree have emulated the martial splendor of the body-armor of the era of mediæval chivalry. Cuirasses had been worn for some years by the modern soldiers of France before they were introduced into the British army. It was after the era of Waterloo that certain historical cuirasses were taken from their repose in the Tower of London, and adapted for service by the Life Guards and the Horse Guards.

CUJAS, or CUJACIUS, or JACQUES, or, as he called himself, JACQUES DE CUJAS (1520–1590), one of the greatest of jurists, was born at Toulouse, where his father, whose name was Cujas, was a fuller. Having taught himself Latin and Greek, he studied law under Arnoul Ferrier, then professor at Toulouse, and rapidly gained a great reputation as a lecturer on Justinian. He was an unsuccessful candidate for the chair of law at his native place in 1554, but in the same year he was appointed to a similar position at Cahors, and about a year after L'Hôpital called him to Bourges. Duaren, however, who also held a professorship at Bourges, stirred up the students against the new professor, and such was the disorder produced in consequence that Cujas was glad to yield to the storm, and accept an invitation he had received to the university of Valence. Recalled to Bourges at the death of Duaren in 1559, he remained there till 1567, when he returned to Valence, where he gained a European reputation, and collected students from all parts of the Continent, among whom may be mentioned Joseph Scaliger and De Thou. In 1573 Charles IX. appointed Cujas counsellor to the Parliament of Grenoble, and in the following year a pension was bestowed on him by Henry III. Margaret of Savoy induced him to remove to Turin; but after a few months (1575) he once more took his old place at Bourges. But the religious wars drove him thence. He was called by the king to Paris, and permission was granted him by the Parliament to lecture on civil law in the university of the capital. A year after, however, he finally took up his residence at Bourges, where he remained till his death in 1590, in spite of a handsome offer made him by Gregory XIII. in 1584 to attract him to Bologna.

The life of Cujas was altogether that of a scholar and teacher. In the religious wars which filled all the thoughts of his contemporaries he steadily refused to take any part. *Nihil hoc ad edictum prætoris*, "this has nothing to do with the edict of the prætor," was his usual answer to those who spoke to him on the subject. His merit as a jurist, which has been surpassed by none, arose from the fact that he turned from the ignorant commentators on Roman law to the Roman law itself. He consulted a very large number of manuscripts, of which he had collected more than 500 in his own library; but, unfortunately, he left orders in his will that his library should be divided among a number of purchasers, and his collection was thus scattered, and in great part lost. His emendations, of which a large number were published under the title of *Observations and Corrections*, were not confined to law-books, but extended



to many of the Latin and Greek classical authors. In jurisprudence his study was far from being devoted solely to Justinian; he recovered and gave to the world a part of the Theodosian Code, with explanations; and he procured the manuscript of the *Basilica*, a Greek abridgment of Justinian, afterwards published by Fabrot (see *BASILICA*). He also composed a commentary on the *Consuetudines Fœderum*, and on some books of the Decretals. In the *Paratitula*, or summaries which he made of the Digest, and particularly of the Code of Justinian, he condensed into short axioms the elementary principles of law, and gave definitions remarkable for their admirable clearness and precision. His lessons, which he never dictated, were continuous discourses, for which he made no other preparation than that of profound meditation on the subjects to be discussed. He was impatient of interruption, and upon the least noise he would instantly quit the chair and retire. He was strongly attached to his pupils, and Scaliger affirms that he lost more than 4000 livres by lending money to such of them as were in want.

In his lifetime Cujas published an edition of his works (Neville, 1577). It is beautiful and exact, but incomplete; it is now very scarce. The edition of Colombet (1634) is also incomplete. Fabrot, however, collected the whole in the edition which he published in Paris (1658), in 10 vols. folio, and which was reprinted at Naples (1722, 1727), in 11 vols. folio, and at Naples and at Venice (1758), in 10 vols. folio, with an index forming an eleventh volume. In the editions of Naples and Venice there are some additions not to be found in that of Fabrot, particularly a general table, which will be found very useful, and interpretations of all the Greek words used by Cujas.

See Papiro-Masson, *Vie de Cujas* (Paris, 1590); Terrasson, *Histoire de la Jurisprudence Romaine, et Mélanges d'Histoire, de Littérature, et de Jurisprudence*; Bernardi, *Eloge de Cujas* (Lyons, 1775); Hugo, *Civilistisches Magazin*; Berriat Saint Prit, *Mémoires de Cujas*, appended to his *Histoire du Droit Romain*; *Biographie Universelle*; Gravina, *De ortu et Progressu Juris Civilis*.

**CULDEES.** On no subject connected with the early ecclesiastical history of the British Islands has there been more discussion than on that of the Culdees. Their very name has furnished matter for dissertations, and their doctrines, mode of life, and peculiar institutions have been the fruitful source of controversy. There is still room for doubt as to details, but in all-important points the truth has been sufficiently ascertained by the learned Scottish and Irish antiquaries who have devoted their attention to the question. The discussion may now be held as practically settled in Britain, though Continental scholars of some mark are disposed to carry it on.

It is of no consequence whether the word Culdee is of Latin or Celtic origin. The name is equally significant and of similar meaning in both languages. It is not precisely ascertained at what time that name was first used. It was unknown to Bede and the biographers of St. Columba, but seems to have been established early in the 10th century as the title of an order of ecclesiastics possessing numerous establishments in Scotland and Ireland, and a very few also in England and Wales. The Culdees resided in monasteries, but were not tied down by monastic rules so strict as those of the followers of Columba or Columbanus, or of the Benedictine order and its various branches. Their institute bore some resemblance to the rule of the canons-regular of St. Augustine, but still more to that of the secular canons so well known in the history of England during the 10th and 11th centuries. They were not united in one great community like the Columbites and Cistercians, or the orders of the Mendicant Friars, but resided in their separate monasteries or colleges, each of which was governed by its abbot, and was practically independent of the others. The Scottish monasteries are the best known, and it is in connection with them that the history of the order is most important. Their chief houses in that country were St. Andrews, which numbered among its superiors King Constantine, who in earlier years had fought against the English sovereign Athelstan at Brunanburh; Dunkeld, of which Crinan, grandfather of Malcolm Canmore, was one of the lay abbots; Lochleven, famous as giving us the oldest of Scottish library catalogues; and Abernethy and Brechin, remembered chiefly in connection with their round towers.

It was long fondly imagined by Protestant writers that the religious belief and worship of the Culdees supplied complete evidence of primitive truth having been pre-

served free from Roman corruptions in one remote corner of Western Europe. It is now certain that this opinion is entirely opposed to historical evidence. In doctrine, ritual, and government there was no difference between the Culdees and the monastic communities in the Latin Church, except that the former, as was to be expected in a remote and uncivilized country distracted by repeated invasions of the Northmen, and by almost uninterrupted civil dissensions, were more superstitious and corrupt than their brethren on the Continent. In ecclesiastical discipline and morals there was the same inferiority. The "pure Culdees" are familiar in poetry and legend, but are unknown to history. At no time distinguished above their fellows for learning or piety, they gradually became still more remiss. The chief endowments of their monasteries were seized by nobles, who called themselves abbots, but were neither ecclesiastics nor discharged any ecclesiastical functions, and who transmitted their titles and estates to their families in hereditary descent. In one respect these nobles were better than the corresponding class who, as priors of St. Andrews and abbots of Arbroath and Paisley, or the like, fought on either side in the civil wars of the 16th century;—they gave up a portion of their revenues to ecclesiastics, who, under the name of priors, discharged the spiritual functions of superiors of the monasteries.

Such a system naturally tended to become more corrupt as time went on. We need not believe all that is told to the prejudice of the Culdees by the chroniclers of a later age; but it is certain that the changes introduced into the Scottish Church by the influence of Queen Margaret and her son King David effected a great and beneficial revolution. The Culdees in general conformed to the stricter discipline enforced by these sovereigns. The lay abbots had to resign their titles if not their estates; the chief houses of the old rule reappeared as Benedictine and Augustinian monasteries; and, in one case at least, that of Brechin, the Culdees became for a time the chapter of the new cathedral. The last appearance of the Culdees in Scottish history is in connection with the unsuccessful attempts of the prior and brethren of the order at St. Andrews, in the beginning of the 14th century, to maintain their ancient privilege of assisting at the election of a bishop of the primatial see.

The best and fullest account of the Culdees is to be found in Dean Roewe's *Culdees of the British Islands as they appear in History, with an Appendix of Evidences*, Dublin, 1864.

**CULLEN, WILLIAM** (1710–1790), an eminent physician and medical teacher, was born at Hamilton, Lanarkshire, on 15th April, 1710. His father, who was a writer by profession, was factor to the duke of Hamilton, and was owner of a small estate in the parish of Bothwell. William received his early education at the grammar school of Hamilton, and he appears to have subsequently attended some classes at the university of Glasgow. He commenced his medical career as apprentice to Mr. John Paisley, surgeon in Glasgow, who was a man of learning and possessed a valuable medical library, and under whom Cullen prosecuted his studies with great ardor. After completing his apprenticeship at Glasgow, Cullen became surgeon to a merchant vessel trading between London and the West Indies. On his return to Scotland in 1732 he settled as a practitioner in the parish of Shotts, Lanarkshire, where he resided for about two years. He thereafter proceeded to Edinburgh to pursue his studies at the university, which was then rapidly rising into fame as a medical school. Here he spent two winter sessions, and was one of the founders of what is now known as the Royal Medical Society, a students' association which meets weekly for the discussion of subjects of medical and scientific interest. Leaving Edinburgh in 1736, Cullen commenced practice in Hamilton, where he rapidly acquired a high reputation, and was employed by many of the families of distinction in the locality, including that of the duke of Hamilton. About this time he became acquainted with the celebrated Dr. William Hunter, who resided with him as his pupil for nearly three years. Hunter was about to enter into partnership with Cullen, when, an opening occurring, he removed to London to engage in those anatomical and obstetric pursuits with which his name will ever stand associated. Cullen took the degree of M. D. at the university of Glasgow in 1740; and, resolving to confine his attention to the practice of physic, took into

partnership Thomas Hamilton, surgeon, who undertook the surgical part of the work. While at Hamilton, Cullen was twice elected a magistrate of the town, and in this capacity he displayed great ability, and was of great service to the community. In 1741 he married Miss Johnston, daughter of a clergyman in the neighborhood, a lady of beauty and accomplishment, by whom he had a large family. He continued to practise in Hamilton till 1744, when he was induced to settle in Glasgow. During his residence at Hamilton, besides the arduous duties of medical practice, Cullen found time to devote to the study of the natural sciences, and especially of chemistry, for which he seems to have had special predilections. On coming to Glasgow he appears to have begun to lecture in connection with the university, the medical school of which was as yet imperfectly organized. Besides the subjects of theory and practice of medicine, Cullen lectured systematically on botany, materia medica, and chemistry. His great abilities, enthusiasm, and power of conveying instruction on the most difficult subjects made him a successful and highly popular teacher, and his classes increased largely in numbers. At the same time he diligently pursued the practice of his profession. Chemistry was the subject which at this time seems to have engaged the greatest share of Cullen's attention, and there can be no doubt that to him was due the credit of placing that science on a more philosophical basis than it had hitherto occupied, while at the same time he labored to render it specially subservient to agriculture and other useful arts. He was himself a diligent investigator and experimenter, and he did much to encourage original research among his pupils, one of whom was Dr. Joseph Black, who became the most celebrated chemist of his time. In 1751, a vacancy having occurred in the professorship of medicine, Cullen, through the influence of the duke of Argyll, was appointed by the king to the chair, but he still continued to lecture on chemistry. In 1756 he was elected by the town council of Edinburgh joint professor of chemistry in the university of that city, along with Dr. Plummer, on whose death in the following year the sole appointment was conferred on Cullen. This chair he held for ten years—his classes always increasing in numbers. He also practised his profession as a physician with eminent success. About this time he delivered, along with some of his colleagues, lectures on clinical medicine in the Royal Infirmary, which he continued to do till near the close of his career. This was a work for which Cullen's experience, habits of observation, and scientific training peculiarly fitted him, and in which his popularity as a teacher, no less than his power as a practical physician, became more than ever conspicuous. During the winter session of 1760–61 the professor of materia medica, Dr. Alston, died, and the students presented a petition to Cullen to undertake the work of finishing the course of lectures on that subject,—a request with which he readily complied. He delivered an entirely new course of lectures, in which the subject was treated in such a masterly and scientific as well as interesting and practical manner as to gain the high commendations of his students and of the medical profession generally, by whom copies of his pupils' notes were in great request. An incorrect edition of the lectures was ten years afterwards published in London without Dr. Cullen's knowledge, and widely circulated throughout Europe.

On the death of Dr. Whytt, the professor of the institutes of medicine in 1766, the patrons offered the chair to Dr. Cullen, who accepted it, resigning that of chemistry, in which he was succeeded by Dr. Black, who was then professor of chemistry in Glasgow. In the same year Dr. John Gregory was appointed professor of the practice of physic on the death of Dr. Rutherford. For this chair Cullen was likewise a candidate, and a strong effort was made to induce the patrons to confer the appointment on him, but without success. In 1769 an arrangement was, however, entered into between Drs. Gregory and Cullen, by which they agreed to deliver alternate courses on the theory and practice of physic. This arrangement proved eminently satisfactory in the hands of these two distinguished men, but it was brought to a close by the sudden and premature death of Gregory in 1773. Cullen was then appointed sole professor of the practice of physic, and he continued in this office till a few months before his death, which took place on 5th February, 1790.

Cullen's fame rests on his great power and influence as a

teacher, and on his important contributions to theoretical and practical medicine.

As a lecturer Cullen appears to have stood unrivalled in his day. His clearness of statement and power of imparting interest to the most abstruse topics were the conspicuous features of his teaching, and in his various capacities as a scientific lecturer, a physiologist, and a practical physician, he was ever surrounded with large and increasing classes of intelligent pupils, to whom his eminently suggestive mode of instruction was specially attractive. The grasp and vigor of his mind were shown in the facility with which he mastered the many different branches of medical knowledge which he taught; while his scientific spirit equally appears in his refusal to accept what he describes as the "false facts" so prevalent in his day, and by the zeal with which he pursued original observation and experimental research both as a chemist and as a physician, with the view of arriving at truth. Cullen has been frequently represented as a purely speculative physician; but this view is far from just. It is to be borne in mind that in his time medicine was to a large extent mixed up with metaphysical speculation, that its ascertained facts were few, and that the science of physiology was then in its infancy. If, therefore, in opposing what he held to be false theories he was led to advance new views and speculations of his own, still no one who attentively reads the works of this great physician and teacher can fail to perceive that his constant aim was in the direction of disengaging his science from the hypothetical mazes in which it was involved, and placing it upon the solid basis of fact.

Previous to the days of Cullen, and during his early life, the medical philosophy or medical doctrines of Boerhaave were universally taught in the schools. Boerhaave attempted to combine into one system the vital philosophy of Hippocrates (the *vis medicatrix naturæ*), the chemicohumoral principle of Paracelsus, the mechanical doctrines of Bellini, and a few of the other doctrines taught by former medical philosophers. He attributed, however, more to the chemical and mechanical forces than to the powers of life, and of course embraced a large portion of the doctrine of the humoral pathologists. Cullen, seeing that many of the facts then known were irreconcilable with Boerhaave's doctrines, became their warm opponent, especially taking offence at those doctrines which attributed almost every disease to a vitiation of the fluids of the body. Indeed, he might almost be said to have adopted as his motto the celebrated aphorism of Hoffmann, "*Universa pathologia longe rectius atque facilius ex vitio motuum microcosmicorum in solidis, quam ex variis affectionibus vitiosorum humorum, deduci atque explicari possit, adeoque omnis generis nervos affectionibus sint referenda.*" Living at the time he did, when the doctrines of the humoral pathologists were carried to an extreme extent, and witnessing the ravages which disease made on the solid structures of the body, it was not surprising that he should oppose a doctrine which appeared to him to lead to a false practice, and to fatal results, and adopt one which attributed more to the agency of the solids, and very little to that of the fluids of the body. The Cullenian system was certainly an immense improvement on those which preceded it, and has served as a valuable stepping-stone for the rational doctrines which now prevail, more especially those which relate to the influence of the nervous system alike in healthy and morbid action. He was obliged to introduce the doctrine of a spasm in the extreme vessels in order to account, on his theory, for many of the phenomena of disease; still we cannot refuse to him the honor of having been an able and successful improver in medical science. His classification of diseases was remarkable for its simplicity and clearness. He divided diseases into four great classes—1st, Pyrexia, or febrile disease, as typhus fever; 2d, Neuroses, or nervous diseases, as epilepsy; 3d, Cachexia, or diseases resulting from bad habit of body, as scurvy; and 4th, Locales, or local diseases, as cancer. His nosological arrangement has served to a considerable extent as the groundwork of modern nosologies, and was a great improvement, both in simplicity and clearness, on the involved productions of his predecessors.

Cullen's chief works are—*First Lines of the Practice of Physic*, Edin., 1774, 4 vols. 8vo; second edition, 1788; *Institutions of Medicine*, Edin., 1770, 12mo; *Synopsis Nosologia Methodica*, Edin., 1785, 2 vols. 8vo; *Treatise on the Materia Medica*, Edin., 1789, 2 vols. 4to. The first volume of an account of *Cullen's Life, Lectures and Writings* was published by Dr. John

Thompson in 1832, and was reissued with the second volume (completing the work) by Drs. W. Thompson and D. Craigie in 1859.

**CULLERA**, a walled seaport-town situated on the left bank of the River Jucar, near its mouth, in the province and 20 miles south of the capital of Valencia. It stands on the southern slope of the hill called Zorras, which terminates in Cape Cullera, on the outskirts of a fine agricultural district noted for its rice, and carries on a considerable coasting-trade with France and the Mediterranean. Its streets are irregularly built, but clean, and there are three small plazas. An old castle, extensive barracks, churches, convents, and a hospital are its chief buildings. Agriculture and fishing are the chief industries. Population about 8000.

**CULLODEN**, a desolate tract of moorland, otherwise known as Drummosia, about five miles south-east from Inverness, in Scotland, celebrated as the scene of the battle of April 16, 1746, by which the fate of the house of Stuart was decided. A mile to the north is Culloden House, which at the time of the rebellion belonged to Duncan Forbes, the president of the Court of Session, and has since furnished the historical student with a valuable collection known as the *Culloden Papers*, ranging from 1625 to 1748. Discovered in 1812, they were published in 1815 by Duncan George Forbes, at that time the representative of the Culloden family.

**CUMÆ**, **CUMA**, or, in Greek, *Κύμη*, the oldest and one of the most important of the Greek colonies in Italy, was situated on the shore of Campania, between the lakes Acherusia and Liternus, and about six miles north of Baie. The most generally received opinion is, that Cumæ was founded by a joint colony, partly from the Æolian Cumæ, or Cyme, and partly from Chalcia, in Eubœa, who agreed that they should call the city by the name of one of the parent states, while it should take rank as a colony of the other. The date of its foundation is unknown, but it is certain that Cumæ had attained a high degree of prosperity while Rome was still struggling into existence. In the 8th century B. C. it had extended its power on every side into Campania, and, like Sybaris and Crotona, had begun to plant flourishing colonies and establish itself besides as a maritime power. Of its colonies the most prosperous was Neapolis, destined to survive as the modern Naples; and among its maritime stations were the harbors of Disearchia (Puteoli) and Misenum. The first event which led to the decline of Cumæ was the establishment of the supremacy of the Etruscans by sea; but a severer blow still was the invasion of Campania by that people and their allies about the year 522 B. C. This attack was repelled, though at a great loss to the Cumæans, chiefly by the ability of Aristodemus, who overthrew the existing government, and established a tyranny, which endured for twenty years. At the end of that period he was driven out of the city by the nobles, who had once more become powerful. Twenty-two years later the Cumæans, unable any longer of themselves to resist the growing power of the Tuscans, called in the aid of Hero of Syracuse, and with his assistance defeated their opponents. In 520 B. C. the Samnites, a more formidable foe, made themselves masters of Cumæ, put the male citizens to the sword, and established a colony of their own in the city. Admitted to the Roman franchise in 338 B. C., Cumæ ever after continued faithful to its alliance with Rome, and in the second Punic war, though by that time it had greatly declined, it held out against Hannibal. In the later ages of the republic it attained a kind of reflected prosperity from the neighborhood of Baie, and other favorite retreats of the Roman nobility; but it is mentioned as "Vacuæ Cumæ," "Quieta Cuma," with reference to its half-deserted appearance. In the wars of the Goths and Romans, Cumæ once more became for a short time important as the last stronghold of the Gothic kings in Italy. In 552 it surrendered to the victorious arms of Narses; in the 9th century it was burned by the Saracens; and in the 13th, having become a rendezvous for robbers and pirates, it was destroyed by the people of Naples. Some remains of Cumæ are still to be seen. Of these the principal are a ruinous amphitheatre, a brick arch, supposed to be one of the old gates of the city, and several temples named respectively after Apollo, Diana, the Giants, and Serapis. Bronze statues and vases have at different times been dug up. Not the least interesting spot at Cumæ was a great

cavern in the rock on which the citadel stood, regarded by the Cumæans as the place whence the Sibyl propounded her enigmas. This cavern existed unimpaired till the time of Narses, who availed himself of it to undermine the walls of the town, and the remains are still pointed out to the traveller.

**CUMANA**, a city of Venezuela, capital of a province of the same name, stands on the Gulf of Cariaco, at the mouth of the Manzanares, 180 miles east of Caracas. It is the oldest European city in South America, having been founded by Diego Castellon in 1523. It was almost totally destroyed by the terrible earthquake of 1766, and has since repeatedly suffered from earthquakes. The houses are generally low and flat, and have a poor appearance; but the style of building has recently been much improved. Cumana possesses a capacious roadstead, and presents great facilities for obtaining provisions. The principal trade is in cattle, smoked meat, dried fish, coffee, cotton, sugar, tobacco, salt, and petroleum. Population (1873), 9427.

**CUMBERLAND**, a county of England, at Plate XI. its north-west extremity, situated between 54° 6' and 55° 7½' N. lat. and 2° 13' and 3° 30' W. long., and bounded on the N. by the Solway Firth and Scotland, on the E. by Northumberland and Durham, on the S. by Westmoreland and North Lancashire, and on the W. for about 70 miles by the Irish Sea. It is at a medium about 50 miles long and 30 miles broad, within a bounding line of 215 miles, of which 75 are sea-coast, and it contains an area of 1516 square miles, or 970,161 acres, of which the mountainous district comprises more than a third, and the lakes and waters 8000 acres, the remainder consisting of inclosed and cultivated land with a few commons still uninclosed, but capable of great improvement. The principal divisions are locally termed "wards." These wards are five in number, viz., Cumberland ward, Eskdale, Leath, Allerdale-above-Derwent, and Allerdale-below-Derwent. The ward of Allerdale-above-Derwent was formerly included in the diocese of Chester; but since 1856 it has been joined to the rest of the county for ecclesiastical purposes, and all the county is now in the diocese of Carlisle, with the exception of the parish of Alston, in the extreme east, which belongs to the diocese of Durham. The county is embraced in the northern circuit, the assizes being held at Carlisle, and there is a court of quarter sessions. Cumberland contains the city of Carlisle, 19 market-towns, and 112 parishes. The population in 1871 was found to be 220,253 (males, 109,079; females, 111,174), having increased during the preceding ten years to the extent of 14,969 souls, or 7.2 per cent. The number of inhabitants to a square mile is exceptionally small, being 145, while that of all England is 389½.

Cumberland presents every variety of surface. The south-west district is generally mountainous, rugged, and sterile, yet contains several rich though narrow valleys, with numerous fine lakes, islands, rivers, cascades, and woodlands, which, combined or contrasted with the gigantic masses around them, exhibit many remarkable scenes of grandeur, desolation, and beauty. Scawfell, Skiddaw, and Helvellyn, rising to the height of more than 3000 feet, belong to this quarter. The highest part of that immense ridge known as the Pennine chain, and not inaptly termed the "backbone" of England, which, rising in Derbyshire, extends in a continuous chain into the Lothians of Scotland, forms the eastern boundary; the culminating point of this ridge is Crossfell, nearly 3000 feet high; it is surrounded with other lofty and bleak eminences, which retain the snow upon them for more than half the year.

The following are the loftiest heights, with their respective elevations:—

	Feet.		Feet.
Scawfell Pike.....	3210	Bowfell.....	2960
Scawfell.....	3162	Great Gable.....	2949
Helvellyn.....	3118	Pillar.....	2927
Skiddaw.....	3058	Blencathra.....	2847
Great End.....	2984	Grisdale Pike.....	2593

The north and north-eastern part of the county consists of the vale of the Eden, which separates the Pennine chain from the mountainous system of the south-west, and gradually expands into the great Cumbrian plain, extending north and north-west to the shores of the Solway. A tract of low land, varying from two to five miles in breadth, and

consisting generally of a gravelly or sandy soil, extends along the coast-line.

**Geology.**—The oldest rocks known in this county are the Skiddaw slates, representing ancient marine deposits of clay and sand formed during a long period of subsidence, and containing a few fossils (graptolites, trilobites, phyllopod crustacea, etc.). These old mud rocks have been much contorted, cleaved, and metamorphosed, the metamorphosed portions, including chistolite slate, spotted schist, and mica schist (rarely gneissic), being specially developed around the granite of Skiddaw Forest. The quiet marine conditions under which these slates were formed seem to have given way to a long series of volcanic outbursts, at first sub-marine in character, but soon becoming sub-aërial. Thus, above the Skiddaw slates are piled up great thicknesses of volcanic ashes and lavas—the volcanic series of Borrowdale (or green slates and porphyries). Then must have followed a renewed period of depression beneath the waters of the sea, and upon the denuded surface of volcanic rocks the great series of sedimentary strata known as the Conistone limestone and the overlying Upper Silurian (Westmoreland, about Windermere and Kendal) was deposited.

The next geological epoch (the Devonian or Old Red) is unrepresented in Cumberland by any sedimentary deposition, except quite towards its close; but during the long lapse of time between the Upper Silurian and the commencement of the Carboniferous, that mighty but probably slow elevation and denudation of all the previously formed rock-groups took place, which resulted in the first appearance of the Cumberland mountain-district, the rough-hewn block out of which, during long succeeding ages, mountain and valley were carved. Around this early nucleus was formed the conglomerate so well shown in Mell Fell and at the foot of Ullswater, and then the thick series of Carboniferous rocks, the limestones, sandstones, shales, and coal-seams, which form so admirable a framework to the mountain-country.

In Carboniferous times there must have been frequent alternations of marine and low-lying land conditions over large parts of Cumberland. At the close of this period the conditions around the mountain nucleus, whether marine or partly fresh-water, allowed of the deposition of great thicknesses of sandstones (mostly red) and marls, together with some breccias and magnesian limestone, which make up the geological formations known as the Permian and New Red (or Trias). With the exception of a small area occupied by Liassic rocks, near Carlisle, no newer formations are known in Cumberland; but during that great length of time represented by the Secondary and Tertiary rocks of the rest of England, the area which is now our lake district seems to have been dry land, and to have been sculptured and moulded by atmospheric denudation into its present form. Within comparatively recent times this district has been the home of glaciers, which have left abundant traces of their former existence in the ice-scratched and rounded rocks, perched blocks, and glacial moraines.

Besides these various rock-groups, there are several large masses of granite and granitoid rocks in the area of the mountain-district. Granite occurs in Skiddaw Forest and in Eskdale. Syenitic and quartz-felsitic rocks occur in Buttermere and Ennerdale (closely associated with the Eskdale granite), in St. John's Vale, and in other smaller masses. Bosses and dykes of diorite and dolerite are of frequent occurrence among the older Silurian rocks, but the basalt known as the Whin Sill is the only instance of intrusive igneous rocks yet recognized among the post-Silurian strata.

The mineral resources are extensive. Among the Lower Silurian rocks (Skiddaw slates and volcanic series) are veins of iron (but little worked), lead, and copper, while the celebrated plumbago mine occurs in the midst of some intrusive dioritic and diabasic masses among the volcanic rocks of Borrowdale. The valuable deposits of hematite are found in connection with the Carboniferous limestone, and the Whitehaven coal-field furnishes a large supply of valuable fuel. Lead veins of much value occur in the limestone area in the east of the county, and especially in the neighborhood of Alston.

Slates are worked in the volcanic series, in which case they consist of cleaved ash-beds, and flags are largely wrought among the Conistone series in the Upper Silurian. Building stone of more or less value is found in the various formations developed in the county. (J. C. WA.)

The climate necessarily corresponds with the varied surface. Along the shore-level it is mild and temperate, though subject to an excess of moisture compared with the eastern part of the county; among the mountain winters are sometimes very rigorous, but more frequently subject to heavy and almost incessant rain for days at a time. The average yearly rainfall, as shown by careful observation for several years back, is as follows:—Carnegie, 30 inches; Wigton, 34; Whitehaven, 50; Keswick, while at Seathwaite, in Borrowdale, 420 feet above sea-level, it amounts to about 140 cubic inches. At Sty-Head Pass, at an elevation of 1077 feet, the rain-fall in the year 1872 the enormous fall of 243.98 inches, which, as far as has yet been ascertained, is this region as the wettest spot in Europe. Black earth is the most prevalent soil in the mountainous districts and is found, too, in the moors and commons of the eastern parts of the county. About one-half the cultivated land consists of dry loams, excellently adapted for the growing of turnips, potatoes, grain, and herbage. Fertile clays are only a small portion, but clay, wet and sterile, forms the subsoil in many parts. The principal rivers are the Eden, Irthing, Derwent, Greta, Caldew, and Esk. The Eden has its source in Westmoreland, near the borders of Yorkshire, and, pursuing a north-westerly direction through Cumberland, passes Kirkoswald and Carlisle, falling into the Solway Firth near Rockliffe Marsh, where it forms a large estuary. The land on its banks is for the most part narrow, and in some places the high grounds approach the water's edge. On this river there are several valuable salmon-fisheries belonging to different owners. The river rises among the picturesque crags at the head of Borrowdale, in the south-west group of mountains, where it dashes from rock to rock until it reaches Derwent Lake, from which it again flows onward through the vale of Keswick, thence through Bassenthwaite Lake, and, being joined by the Cocker, near Cocker-mouth, falls into the sea at Workington. The basin of the Derwent includes within its area six lakes and about a dozen mountain tarns, all of which lie embosomed in the midst of scenery unsurpassed in loveliness and grandeur in Great Britain. The Caldew rises on the south-east side of the Skiddaw, enters the Eden near Carlisle after a course of 24 miles, which it gives motion to many corn and cotton mills. The Esk flows through which it flows in its lower part is very fertile and well-wooded. The Esk enters Cumberland from Scotland near a place called the Moat, and, flowing westward by Longtown, falls into the Solway Firth. The Liddel, another Scottish river, which in one part separates Cumberland from Scotland, joins the Esk after the latter has passed into England.

Landed property is much divided in this county, and smaller holdings were formerly generally occupied by the owners, who were known as "statesmen," i. e., "landmen," a class of men long noted for their sturdy independence and attachment to routine husbandry. Most of the estates were held of the lords of manors under customary tenure, which subjected them to the payments of fines, heriots on alienation as well as on the death of the last tenant. According to the *Agricultural Survey* printed in 1794, about two-thirds of the county was held by this tenancy in parcels worth from £15 to £30 rental. On large estates also, the farms were in general rather small, few then renting £200 a year, held on verbal contracts, or very short leases, and burdened like the small estates with payments or services over and above a money rent; but a change has taken place in all these respects within the last forty years. The "statesmen" have been gradually becoming extinct as a class, and many of the small holdings have fallen into the hands of the larger landed proprietors. According to the *Owners of Land Return*, 1873, the county was divided among 15,513 separate proprietors, the total value of the land being estimated at £1,201,980. There were 9617 owners of holdings which did not exceed 1 acre in extent, 1764 owners of holdings from 1 to 10 acres, 1071 owners of 10 to 50 acres, and 3071 owners of 50 acres and upwards, the largest possessing 47,730 acres. From the above-mentioned return it appears that 62 per cent. of the total proprietors in Cumberland hold less than 1 acre; while in the neighboring county of Westmoreland only 39 per cent. belonged to this class, and in all England the average is 71 per cent. The average extent of the holdings in Cumberland was 47 acres against 34 acres in all England.

on f  
rati  
sco  
Cle  
ula  
d, l  
fac  
rela  
or  
red  
ng  
be  
mc  
he  
rtc  
ls  
sel  
itr  
e  
su  
ia  
ly  
m

zi  
in  
ye  
t  
th

h

u  
(

th  
or  
se  
ng  
um  
, W  
193  
77)

port  
, an  
n th  
t wa  
wit  
ey a  
Indi

mberl  
nd b  
e me  
llaws  
ul.

in W  
e to i  
rocky  
succe  
ew a  
entw  
, abou  
ealth  
nithes  
many  
iew o  
ure ag  
ed, and  
Lord'

rincipa  
l Deri  
ded fo  
t's Isle  
the abo  
e, as co  
e 7th ce  
ains a h  
laid-ou  
the cele  
ake, cons  
rmous p

0  
1  
2  
3  
4  
5  
6  
7  
8  
9  
A  
B  
C  
D  
E  
F  
G  
H  
I  
J  
K  
L  
M  
N  
O  
P  
Q  
R  
S  
T  
U  
V  
W  
X  
Y  
Z

and the value per acre was £1, 12s. 11d. as against £3, 0s. 2d. throughout the whole country. There were five proprietors in the county owning more than 10,000 acres, viz., the earl of Carlisle (Castle Howard), 47,730 acres; earl of Londale (Lowther Castle), 28,228; Sir F. U. Graham (Netherby), 25,270; Henry Howard (Greystoke Castle), 13,008; and Lord Leonfield (Cockermouth Castle), 11,147.

Farms are commonly let upon leases of seven or fourteen years, and the farmers can compare favorably with those of neighboring counties in intelligence and skill in husbandry. The live stock consists of horses of rather a small size; the longhorned breed of cattle, for which Cumberland was noted, has been entirely supplanted by the improved shorthorns, of which the stocks of several of the large proprietors include animals from the best blood in the kingdom; Galloways, Ayrshires, and cross-breeds are also kept on dairy-farms. The sheep on the lowland farms are generally of the Leicester class or cross-bred between the Leicester and Herdwick, with a few South-downs. Throughout the mountainous districts the Herdwick has taken the place of the smaller black-faced heath variety of sheep once so commonly met with on the sheep farms. They are peculiar to this part of England; the ewes and wethers and many of the rams are polled, the faces and legs are speckled, and the wool is finer and heavier in fleece than that of the heath breed. They originally came from the neighborhood of Muncaster in the Duddon and Esk district, and are said to be sprung from parents that escaped from a wrecked ship of the Spanish Armada. In general they belong to the proprietors of the sheep-walks, and have been farmed out with them from time immemorial in herds of from 300 to 1000, and from this circumstance it is said they have obtained the name of "Herdwicks." From the agricultural returns for the years 1873 and 1876 it will be seen that the numbers of live stock remain pretty stationary, with the exception of sheep, which have apparently decreased latterly—these returns, however, are not so complete as they might be.

	Cattle.	Sheep.	Hgs.	Horses.
1873.....	128,538	561,513	28,229	19,071
1876.....	128,409	516,305	27,178	19,838

Grain is not so much grown as formerly, a great proportion of the land being laid down in grass for the breeding and rearing of cattle; butter and bacon are largely exported to the populous districts of Lancashire and Yorkshire.

	Average under Corn Crops.	Under Green Crops.	Grass under rotation.	Under all kinds of cultivation.	Percentage of area of county.
1873...	100,704	50,676	99,958	541,681	55½
1876...	94,794	48,207	96,317	549,590	56½

Nearly three-fourths of the corn crops consist of oats, and about one-fifth wheat, while two-thirds of the green crops are turnips, and a fifth potatoes. That excellent variety of oats called the potato-oat was first discovered in Cumberland in 1788, whence it has now spread over every part of the United Kingdom. Among the farm implements the single-horse cart deserves to be noticed, as being almost exclusively used, and with great advantage, as it is not only the most convenient and economical carriage for the farmer, but is much less injurious to the public roads than the wagons and heavily-loaded carts used in many other English counties, which could not easily travel the hilly roads of many parts of Cumberland.

The principal manufactures of this county are calicoes, gingham, corduroys, and other cotton fabrics, established at Dalston, Carlisle, Warwick Bridge, and a few other places. Cotton printing is carried on to some extent in Carlisle. Cockermouth possesses a large new mill for the manufacture of tweeds, and also an old established thread manufactory. A manufactory of coarse earthenware near Dearham, pencil mills at Keswick, and paper mills at Egremont, with breweries, tanneries, soap and biscuit manufactories at Carlisle, comprise all the other chief manufacturing establishments of any note in Cumberland. Coal is found at different places in the eastern mountains, and also near Brampton in the northern part of the county, but in greatest abundance on the west of the Calder, and thence through the Maryport, Workington, and Whitehaven districts; in 1871, 4596 persons were employed in the pits. Owing to the development of the iron trade in the west of the county the consumption of coal is very considerable;

but a large export trade is still carried on from the Cumberland seaports to Ireland. Mining operations have taken a new direction in recent years. The discovery and opening out of immense beds of iron ore in the Cleator district have given increased employment to the population. This ore is of the quality known as hematite; and, being exceedingly rich and well adapted for the manufacture of Bessemer steel, it is largely exported to the Cleveland and other districts to mix with ore of an inferior quality. In 1871 thirty-three iron mines were registered for Cumberland in the Mining Record Office, employing 3771 miners; but since that date many new mines have been opened, and all the mines have been worked on a more extensive scale than before. Furnaces for smelting the ore are established at Workington, Maryport, Seaton, Parton, and Harrington, and at Workington are established large works for the manufacture of iron and Bessemer steel.

The famous black-lead mines are situated at the head of Borrowdale, in the south-west range of mountains. The mineral is found in the green slate, generally lying in nodules or irregular granular kidney-shaped masses. These masses are as a rule small; but early in the present century an extraordinary mass was found which, it is said, yielded 70,000 lb of pure plumbago. With the exception of a couple of trials made at an interval of twenty years by different companies, this "wad-mine" has been practically closed for more than thirty years. The lead now used for pencils is an imitation of the plumbago, made chiefly from Mexican lead mixed with antimony and other ingredients.

The principal lead-mines are at Alston Moor, on the south-east border of the county, in the Caldbeck fells, and in the mountains around Keswick. The ore is found in veins nearly perpendicular, and not unfrequently contains a considerable proportion of silver. Copper was formerly raised from the mines of Caldbeck, Heaket-New-Market, and Newlands near Keswick, but these mines have not been wrought for many years. The ore is a sulphuret, and usually contains both iron and arsenic. In 1871, 1082 persons were employed in lead-mining.

The most considerable towns in Cumberland are Carlisle (population, 31,074), Penrith (8317), Whitehaven (13,298), Workington (7979), Maryport (6938), Wigton (3425), Cockermouth (5115), Keswick (2777), Brampton (2617), and Egremont (2377). The seaports are Whitehaven, Workington, Maryport, Harrington, and Silloth. Whitehaven was among the first ports in the kingdom to embark in the East India trade after it was thrown open, and possessed a fair share of the trade with America and the West Indies long before the Mersey and the Clyde; the first Clyde ventures to the West Indies were made in Whitehaven bottoms.

The lakes and mountains of Cumberland have long attracted the admirers of the wild and beautiful in natural scenery. The lakes, including the mountain tarns, are thirty-four in number; of these Ullswater is the largest, and Derwentwater the most beautiful. Ullswater is partly situated in Cumberland and partly in Westmoreland; it is 9 miles in length and from ¼ mile to ½ mile in breadth. Winding round the base of vast rocky mountains in its upper part, it is only seen in the successive portions,—the scenery on its margin presenting new and striking objects at every successive stretch. Derwentwater is of an irregular figure, approaching to an oval, about 3 miles in length and from ½ mile to 1½ miles in breadth. It is seen at one view, expanding within an amphitheatre of mountains, rocky, but not vast, broken into many fantastic shapes, opening by narrow valleys the view of rocks which rise immediately beyond and which are again overlooked by others. Its shores are well wooded, and its bosom spotted by well-wooded islands, of which Lord's Island, Derwent Isle, and St. Herbert's are the principal. Lord's Island was the residence of the ill-fated Derwentwater family, the last earl of which was beheaded for participation in the rebellion of 1715. St. Herbert's Isle receives its name from the fact of its having been the abode of a holy man of that name mentioned by Bede, as contemporary with St. Cuthbert of Farne Island in the 7th century. Derwent Isle, about 6 acres in extent, contains a handsome summer residence surrounded by tastefully laid-out lawns, gardens, and timber of large growth. The celebrated Falls of Lodore, at the upper end of the lake, consist of a series of cascades which rush over an enormous pile of protruding

crags from the height of nearly 200 feet. What is called the "Floating Island" appears occasionally at intervals of from two to five years on the upper portion of the lake in front of the Lodore Falls. This somewhat singular phenomenon is supposed to owe its appearance to an accumulation of gas, formed by the decay of vegetable matter, detaching and raising to the surface the matted weeds which constitute the floor of the lake at this point.

The following table shows the extent of the lakes and their elevation above the sea-level, etc. :—

	Length.	Breadth.	Elevation.	Greatest Depth.
	Miles.	Miles.	Feet.	Feet.
Ullswater.....	9	2	477	218
Bassenthwaite....	4	2	226	78
Derwentwater.....	3	1½	238	81
Crummock.....	3	2	321	132
Wastwater.....	3	2	204	...
Thirlmere.....	3	2	533	108
Ennerdale.....	2½	2	369	80
Buttermere.....	1½	1	331	93
Loweswater.....	1	1	429	60

The present county of Cumberland was formed by the addition of a portion of the old English kingdom of Yorkshire to the southern part of the old British kingdom of Strathclyde. It first became a portion of the kingdom of England in the reign of William Rufus, who rebuilt Carlisle which the Danes had destroyed 200 years before. At a conference held at York, Henry III., in full satisfaction of the claims of the Scots, who considered Strathclyde to be a tributary kingdom to Scotland, agreed to assign lands to them of the yearly value of £200 within the counties of Northumberland and Cumberland, if lands of that value could be found therein, without the limits of the towns where castles were erected. But after this arrangement there still remained a tract between the two kingdoms called the "debatable ground," the resort of the worst characters of both, who continued to disturb the borders, down to the union of the two crowns. Of the ancient British antiquities of Cumberland the most remarkable is a circle of stones, about three miles from Kirkoswald, called Long Meg and her Daughters; and there is a unique little circle of 48 stones between Threlkeld and Keswick, called the Druid's Temple, scarcely two miles from the latter place—the stones are porphyritic greenstone. The Roman wall may still be traced across the country from the Solway to Northumberland. A great many coins, altars, and other vestiges of antiquity have been discovered from time to time at the Roman stations on its line. In the mountainous parts the manners of the people were down to a recent period somewhat peculiar, and in some of the secluded dales the native inhabitants still lead a primitive kind of existence; but increased intercourse with the outside world, induced by the extension of railways and the spread of education, is doing much to bring them on a level with the peasantry of more favored parts of the kingdom.

Cumberland sends eight members to Parliament:—two for the Eastern Division, two for the Western Division, two for Carlisle, one for Whitehaven, and one for Cockermouth. It is governed by a lord-lieutenant, high-sheriff, deputy lieutenant, and magistrates. (H. I. J.)

CUMBERLAND, a city of the United States, capital of Alleghany county, Maryland, on the north bank of the Potomac river, 179 miles west of Baltimore. It contains a court-house, a county prison, a market-house, and several handsome churches; and as the western terminus of the Chesapeake and Ohio canal and the seat of a railway junction, it enjoys excellent opportunities for trade. There are flour-mills and iron-furnaces in the neighborhood; and an extensive factory for the manufacture of steel rails is maintained by the Baltimore and Ohio railway company. A few miles to the west is the commencement of the great Cumberland coal region. Population in 1870, 8056.

CUMBERLAND, RICHARD (1632-1718), bishop of Peterborough, was the son of a respectable citizen of London, and was born in the parish of St. Ann, near Aldersgate. He was educated at St. Paul's school, and at Magdalene College, Cambridge, where in due time he took his degrees in arts, and obtained a fellowship. He took the degree of B. A. in 1653; and, having proceeded M. A. in 1656, he was next year incorporated to the same degree

in the university of Oxford. For some time he applied himself to the study of physic; and although he did not adhere to this profession, he retained his knowledge of anatomy and medicine. Payne informs us that "he distinguished himself, whilst he was a fellow of the college, by the performance of his academical exercises. He went out bachelor of divinity at a public commencement; and tho' it was hardly known that the same person performed those great exercises twice, yet such was the expectation he had raised, that he was afterwards solicited to keep the act at another public commencement for his doctor's degree." He took the degree of B. D. in 1663, and that of D. D. in 1680. Among his contemporaries and intimate friends were Dr. Hezekiah Burton, Sir Samuel Moreland, who was distinguished as a mathematician, Sir Orlando Bridgeman, who became keeper of the great seal, and Samuel Pepys.

To this academical connection he appears to have been in a great measure indebted for his subsequent advancement in the church. When Bridgeman was appointed lord keeper, he nominated Cumberland and Burton as his chaplains, nor did he afterwards neglect the interest of either. Cumberland's first preferment was the rectory of Brampton, in Northamptonshire, which was bestowed upon him in 1658 by Sir John Norwich. He then quitted the university, and went to reside on his benefice, where he zealously devoted himself to the duties of his sacred office, and to the prosecution of those abstruse studies to which he had long been addicted. In 1661 he was appointed one of the twelve preachers of the university. His character was very remote from that of a preferment-hunter; and in this unambitious retirement he might have spent the remainder of his life, if the lord keeper, who obtained his office in 1667, had not invited him to London, and soon afterwards bestowed upon him the rectory of Allhallows at Stamford. In his new situation he acquired new credit by the fidelity with which he discharged his important functions. In addition to his ordinary duties, he undertook the weekly lecture, and thus was obliged to preach thrice every week in the same church. This labor he constantly and assiduously performed, and in the mean time found sufficient leisure, as well as inclination, to prosecute his scientific and philological studies.

At the mature age of forty he published his earliest work, entitled *De Legibus Naturæ Disquisitio Philosophica, in qua earum Forma, eumma Capita, Ordo, Promulgatio, et Obligatio e Rerum Naturæ investigantur; quin etiam Elementa Philosophiæ Hobbiana, cum moralis tum civilis, considerantur et firuntur*, London, 1672, 4to. It is dedicated to Sir Orlando Bridgeman, and is prefaced by an "Alloquium ad Lectorem," contributed by the author's friend Dr. Barton. It appeared during the same year with Puffendorf's *De Jure Naturæ et Gentium*. This work of the English divine was highly commended in a subsequent publication of the German lawyer, and his weighty suffrage must have had the effect of making it known on the Continent. The book was reprinted at Lübeck in 1683, and again in 1694. It was likewise reprinted at Dublin. As the work was printed in London while the author was residing at Stamford, the first edition contains many typographical errors; nor are they removed in the subsequent editions. Bentley afterwards undertook to revise the entire text, and, according to his grandson's account, he most effectually performed this task; but Barbeyrac, who had the use of the corrected copy, and who was a more competent judge of its value, entertained a less favorable opinion. This copy is now in the library of Trinity College, Cambridge. The author's family intended to publish a splendid edition of the work, but their laudable design was never executed.

Tyrrell, who was the grandson of Archbishop Usher, and is himself well known as a writer on history and politics, digested Cumberland's doctrines into a new form, and published a considerable volume under the following title: *A brief Disquisition of the Law of Nature, according to the Principles and Method laid down in the Reverend Dr. Cumberland's (now Lord Bishop of Peterborough's) Latin Treatise on that subject; as also his Conjectures of Mr. Hobbs's Principles put into another method: with the Right Reverend Author's approbation*, London, 1692, 8vo. Another edition appeared in 1701. A complete English version of the original work was published by John Maxwell, M. A., prebendary of Connor, under the title of *A Treatise of the Laws of Nature, etc.*, London, 1727, 4to. A French trans-



lation was executed by Barbeyrac, and published at Amsterdam in 1744.

Having thus established a solid reputation, Dr. Cumberland next prepared a work on a very different subject,—*An Essay towards the Recovery of the Jewish Measures and Weights, comprehending their Monies; by help of ancient standards, compared with ours of England: useful also to state many of those of the Greeks and Romans, and the Eastern Nations*, London, 1686, 8vo. This work, which is dedicated to his friend Pepys, obtained a copious notice from Leclerc, and was translated into French.

About this period he was greatly depressed, like many other good men, by apprehensions respecting the growth of Popery; but his fears were at length dispelled by the Revolution, which likewise brought along with it another material change in his circumstances. In the course of the year 1691, he went, according to his custom on a post-day, to read the newspaper at a coffee-house in Stamford, and there, to his great surprise, he read that the king had nominated Dr. Cumberland to the bishopric of Peterborough. The face of the bishop elect was scarcely known at court, and he had resorted to none of the usual methods of advancing his temporal interest.

"Being then sixty years old," says his great-grandson, "he was with difficulty persuaded to accept the offer, when it came to him from authority. The persuasion of his friends, particularly Sir Orlando Bridgeman, at length overcame his repugnance; and to that see, though very moderately endowed, he for ever after devoted himself, and resisted every offer of translation, though repeatedly made and earnestly recommended. To such of his friends as pressed an exchange upon him he was accustomed to reply, that Peterborough was his first espoused, and should be his only one; and, in fact, according to his principles, no church revenue could enrich him; for I have heard my father say that, at the end of every year, whatever overplus he found upon a minute inspection of his accounts was by him distributed to the poor, reserving only one small deposit of £25 in cash, found at his death in his bureau, with directions to employ it for the discharge of his funeral expenses,—a sum in his modest calculations fully sufficient to commit his body to the earth."

To the duties of his new station he applied himself with great assiduity. His charges to the clergy are described as plain and unambitious, the earnest breathings of a pious mind. His old age was fresh and vigorous, nor did he discontinue his episcopal visitations till after he attained his eightieth year. When Dr. Wilkins published the New Testament in Coptic, he presented a copy to the bishop, who began to study the language after he had completed the age of eighty-three. "At this age," says his chaplain, "he mastered the language, and went through great part of this version, and would often give me excellent hints and remarks, as he proceeded in reading of it." He died in 1718, in the eighty-seventh year of his age: he was found sitting in his library, in the attitude of one asleep, and with a book in his hand. The great-grandson of Bishop Cumberland was Richard Cumberland, the dramatist, the subject of the following notice.

Bishop Cumberland was eminently distinguished by his gentleness and humility. He was of a temper so cool and sedate that it could not be roused to anger, and through the whole course of his life his soul is represented as having been in a constant state of calmness and serenity, hardly ever ruffled by any passion. The theory which he maintains in his principal work is founded on benevolence, and it naturally flowed from the habitual temperament of the author's mind. He was a man of a sound understanding, improved by extensive learning, and has left behind him several monuments of his talents and industry.

The care of Cumberland's posthumous publications devolved upon his domestic chaplain Payne, who soon after the bishop's death edited "*Sanchoniatho's Phœnician History*, translated from the first book of Eusebius, *De Preparatione Evangelica*: with a continuation of Sanchoniatho's history by Eratosthenes Lyrenus's Canon, which Dicaearchus connects with the first Olympiad. These authors are illustrated with many historical and chronological remarks, proving them to contain a series of Phœnician and Egyptian chronology, from the first man to the first Olympiad, agreeable to the Scripture accounts." Lond., 1720. The preface contains an account of the life, character, and writings of the author, which was likewise published in a separate form, and exhibits a pleasing picture of his happy old age. A German translation appeared under the title of *Cumberland's Phœnische Historie des Sanchoniathons, übersetzt von*

*Joh. Phil. Cassel*, Magdeburg, 1755, 8vo. The sequel to the work was likewise published by Payne,—*Origines Gentium antiquissimas; or Attempts for discovering the Times of the first Planting of Nations: in several Tracts*, Lond., 1724, 8vo.

The philosophy of Cumberland is expounded in the treatise *De Legibus Naturæ*. The merits of the work are almost confined to the general character and substance of the speculation it contains, for its style is destitute of both strength and grace, and its reasoning is diffuse and immethodical to a trying degree. Its main design is to combat the principles which Hobbes had promulgated as to the constitution of man, the nature of morality, and the origin of society, and to prove, in opposition to what he had maintained, that self-advantage is not the chief end of man, that force is not the source of personal obligation to moral conduct nor the foundation of social rights, and that the state of nature is not a state of war. The views of Hobbes seem to Cumberland utterly subversive of religion, morality, and civil society, and he endeavors, as a rule, to establish directly antagonistic propositions. He refrains, however, from denunciation; he uses only calm and moderate language, and is a uniformly fair opponent up to the measure of his insight.

Laws of nature are defined by him as "immutably true propositions regulative of voluntary actions as to the choice of good and the avoidance of evil, and which carry with them an obligation to outward acts of obedience, even apart from civil laws and from any considerations of compacts constituting governments." This definition he says will be admitted by all parties. Some deny that there are any such laws, but they will grant as readily as their opponents that this is what ought to be understood by them. There is thus common ground for the two opposing schools of moralists to join issue. The question between them is, Do such laws exist or do they not? In reasoning thus Cumberland obviously forgot what the position maintained by his principal antagonist really was. Hobbes must have refused to accept the definition proposed. He did not deny that there were laws of nature, laws antecedent to government, laws even in a sense eternal and immutable. The virtues as means to happiness seemed to him to be such laws. They precede civil constitution, which merely perfects the obligation to practise them. He expressly denied, however, that "they carry with them an obligation to outward acts of obedience, even apart from civil laws and from any consideration of compacts constituting governments." And many besides Hobbes must have felt dissatisfied with the definition. It is the reverse of unambiguous or luminous. In what sense is a law of nature a "proposition"? Is it as the expression of a constant relation among facts, or is it as the expression of a divine commandment? A proposition is never in itself an ultimate fact although it may be the statement of such a fact. And in what sense is a law of nature an "immutably true" proposition? Is it one which men always and everywhere accept and act on, or merely one which they always and everywhere ought to accept and act on? The definition, in fact, raises various doubts and difficulties, and can scarcely be said to clear away any.

The existence of such laws as are defined may, according to Cumberland, be established in two ways. The inquirer may start either from effects or causes. The former method had been taken by Grotius, Sharrock, and Selden. They had sought to prove that there were universal truths, entitled to be called laws of nature, from the concurrence of the testimonies of many men, peoples, and ages regarding them, through collecting the opinions of persons widely removed in space and time from one another, and through generalizing the operations of certain active principles. Cumberland admits this method to be valid, but he prefers the other, that from causes to effects, as showing more convincingly that the laws of nature carry with them a divine obligation. It not only establishes laws of nature as universal, but as having been meant to be; it shows that man has been constituted as he is in order that they might be. In the prosecution of this method he expressly declines to have recourse to what he calls "the short and easy expedient of the Platonists," the assumption of innate ideas of the laws of nature. He has not, he says, been so happy as to learn the laws of nature by so simple a way. He thinks it ill-advised to build the doctrine of natural religion and morality on an hypothesis which many philosophers, both Gentile and Christian, had rejected, and which

could not be proved against Epicureans, the principal impugnors of the existence of laws of nature. He cannot assume, he says, without proof that such ideas existed from eternity in the divine mind, but must start from what sense and experience furnish, and thence by search into the nature of things discover what their laws are. It is only through nature that we can rise to nature's God. His attributes are not known by direct intuition. He did not think, then, that the ground taken up by More, Cudworth, and the other members of the Cambridge Platonic school was such as they could hold against an adversary like Hobbes or from which they could successfully assail him. His sympathies, however, were all on their side. He wished success to their efforts, and he would do nothing to diminish their chances of success. He would not even oppose the doctrine of innate ideas, because it looked with a friendly eye upon piety and morality. He granted that it might, perhaps, be the case that ideas were both born with us and afterwards impressed upon us from without.

All the laws of nature, Cumberland maintains, may be reduced to one,—the law of universal benevolence, of effort to promote the happiness of all rational agents. This, he thinks, is the root and source of the entire world of moral good. "No action can be called morally good which does not in its own nature contribute somewhat to the happiness of men." The theory of Cumberland implies as an antecedent the system of Hobbes. Had there not been a theory of selfishness, a doctrine which made self-love the universal principle of conduct, we should not have had the whole nature of virtue resolved into a principle of benevolence as it was by Cumberland. His opinion was evidently a reaction from the opposite. In his dislike of the selfish theory he was tempted to carry his refutation of it to the uttermost and maintain the negative in the directest terms of antithesis. There was no other so forcible mode of denying the obnoxious theory as by positively affirming and defending its contrary,—that no virtuous action whatever is self-regarding, or, in other words, that the only principle of right conduct is benevolence. The principle, therefore, which he lays down as fundamental is that to pursue to the utmost of our power the general good of the whole system of rational beings is to contribute to the utmost of our power to the good of each of its parts, our own individual happiness inclusive, and that to pursue an opposite end is to entail opposite results, and among others our own individual misery. It is just the opposite of the central idea of Hobbes. The happiness of the whole community, according to Hobbes, will be best promoted if each man looks to himself and attends to his own interests. The happiness of each individual, according to Cumberland, will be best promoted if each man begins by endeavoring to promote the happiness of the whole society. Both were right and both were wrong. Man is to a great extent ruled by selfishness; the uncivilized man almost wholly. In savages and in children selfishness is a decidedly stronger principle than benevolence. The human being is keenly susceptible to its own sensational pleasures and pains when almost incapable of entertaining any wide or elevated conceptions of general good. Benevolence as a steady and vigorous principle of action does not manifest itself early in the history either of the individual or of the race. Then, there is a good deal of sense and truth in saying, Let the individual take care of himself and the common good will be thereby best secured. It is far from certain that if every man were setting the common good before him as his direct and immediate object the great majority of them would not do more harm than good. If the selfishness of the ignorant be bad, there is danger of their benevolence being worse. On the other hand, Hobbes was wrong in affirming that man is governed solely by self-interest, and Cumberland was right in maintaining that disinterested benevolence is a principle of human nature. It exists from the first in the human constitution, although only in germ, and moral progress is marked throughout by its growth in strength. History shows us the obstacles imposed by the narrowness and darkness of the human understanding, the coldness and selfishness of the human heart, the jealousies of classes, and the antipathies of nations continuously, if slowly, yielding in favor of universal benevolence, benevolence to all rational and even sentient beings. Thus far the truth is with Cumberland. His error is when he asserts that benevolence is the sole principle of virtue. This clearly is an error, although it is one in which he was

followed by Hutcheson and some other philosophers. Benevolence cannot be legitimately made to include love to God and the exercise of piety nor what have been called the personal virtues. It is only itself virtuous when brought under conformity to the moral law.

In attempting to prove that all the virtues are forms or varieties of benevolence Cumberland never appeals to history, although he believed that the law of universal benevolence had been accepted by all nations and generations; and he carefully abstains from arguments founded on revelation, feeling that it was indispensable to establish the principles of moral right on nature as a basis. There was another line of reasoning open to him, viz., deduction of the propriety of certain actions from the consideration of the character and position of rational agents in the universe; and this is that which he follows. He argues that all that we see in nature is framed so as to avoid and reject what is dangerous to the integrity of its constitution; that the human race would be an anomaly in the world had it not for end its conservation in its best estate; that benevolence of all to all is what in a rational view of the creation is alone accordant with its general plan; that various peculiarities of man's body indicate that he has been made to cooperate with his fellow-men and to maintain society; and that certain faculties of his mind explicitly and positively show the common good to be more essentially connected with his perfection than any pursuit of private advantage. The whole course of his reasoning proceeds on, and is pervaded by, the principle of final causes.

To the question, What is the foundation of rectitude? he replies, the greatest good of the universe of rational beings. He may be regarded as the founder of the utilitarian school in England, which numbers a Hume, Bentham, the Mills, and Bain among its adherents. His utilitarianism is quite distinct from what is known as the selfish system; it errs by going to the contrary extreme, by almost absorbing individual good in universal good. Nor does it look merely to the lower pleasures, the pleasures of sense, for the constituents of good, but rises above them to include especially what tends to perfect, strengthen, and expand our true nature. Existence and the extension of our powers of body, thought, and feeling are held to be good for their own sakes without respect to enjoyment. Cumberland's views on this point were long abandoned by utilitarians as destroying the homogeneity and self-consistency of their theory; but J. S. Mill and some recent writers have reproduced them, without recognition of their paternity, as necessary to its defence against charges not less serious than even inconsistency.

The answer which Cumberland gives to the question, Whence comes our obligation to observe the laws of nature? is that happiness flows from obedience, and misery from disobedience to them, not as the mere results of a blind necessity, but as the expressions of the divine will—the reward attached by that will to obedience, and the punishment attached by it to disobedience. This reward and punishment, supplemented by future retribution, the happy immortality which awaits the good and the misery coming on the wicked, are, in his view, the sanctions of the laws of nature, the sources of our obligation to obey them. To the other great ethical question, How are moral distinctions apprehended? he replies that it is by means of reason, or right reason. But by right reason he means merely the power of rising to general laws of nature from particular facts of experience. It is no peculiar faculty or distinctive function of mind; it involves no original element of cognition; it begins with sense and experience; it is gradually generated and wholly derivative. This doctrine lies only in germ in Cumberland, but will be found in full flower in Hartley, Mackintosh, and later associationists. (R. F.)

CUMBERLAND, RICHARD (1732-1811), a dramatic and miscellaneous writer, was born in the Master's Lodge of Trinity College, Cambridge, on the 19th of February, 1732. He was the great-grandson of his namesake, the bishop of Peterborough; and his father, Dr. Denison Cumberland, became successively bishop of Clonfert and of Kilmore. His mother was Joanna, the youngest daughter of the great Bentley, and the heroine of John Byron's once popular little eclogue, *Colin and Phoebe*. Of the great Master of Trinity his grandson has left a kindly account; he afterwards collected all the pamphlets bearing on the *Letters of Phalaris* controversy, and piously defended the reputation of his ancestor in a *Letter to Bishop Lowth*,

who had called him "aut caprimulgus aut fossor." Cumberland was in his seventh year sent to the grammar-school at Bury St. Edmunds; and he relates how, on the head-master Arthur Kinsman undertaking, in conversation with Bentley, to make the grandson as good a scholar as the grandfather himself, the latter retorted: "Pshaw, Arthur, how can that be, when I have forgot more than thou ever knewest?" Bentley died during his grandson's Bury school-days; and in 1744 the boy, who, while rising to the head of his school, had already begun to "try his strength in several slight attempts towards the drama," was removed to Westminster, then at the height of its reputation under Dr. Nicholls. Among his schoolfellows here were Warren Hastings, George Colman (the elder), Lloyd, and (though he does not mention them as such) Churchill and Cowper. From Westminster Cumberland passed, in his fourteenth year, to the familiar Trinity, where at first he was, according to custom, left to study on his own account. Afterwards, however, under the advice of the master, Dr. Smith, he applied himself closely to mathematics, and in 1750 he took his degree as tenth wrangler. His account of his degree examination, as well as that for a fellowship at his college (part of which he underwent in the "judges' chamber," where he was born), is curious; he was (by virtue of an alteration in the statutes) elected to his fellowship in the second year of his degree.

Meanwhile his projects of work as a classical scholar had been interspersed with attempts at imitating Spenser—whom, by his mother's advice, he "laid upon the shelf"—and a dramatic effort (unprinted) on the model of Mason's *Elfrida*, called *Caractacus*. He had hardly abandoned these pursuits in order to read for his fellowship, when he was offered the post of private secretary by the earl of Halifax, First Lord of Trade and Plantations in the duke of Newcastle's ministry. His family persuaded him to accept the office, to which he returned after his election as fellow. It left him abundant leisure for literary pursuits, which included the design of a poem in blank verse on India. He was fortunate enough to obtain a lay fellowship at Trinity, but this he not long afterwards resigned on his marriage—in 1759—to Miss Elizabeth Ridge, to whom he had paid his addresses on receiving through Lord Halifax "a small establishment as crown-agent for Nova Scotia." In 1761 he accompanied his patron (who had been appointed lord-lieutenant) to Ireland as Ulster secretary; and in acknowledgment of his services was afterwards offered a baronetcy. By declining this he thinks he gave offence; at all events, when in 1762 Halifax became secretary of state, Cumberland in vain applied for the post of under-secretary, and could only obtain the clerkship of reports at the Board of Trade under Lord Hillsborough. While he takes some credit to himself for his incorruptibility when in Ireland, he showed zeal for his friends, and obtained a bishopric for his father. On the accession to office of Lord George Germaine (Sackville) in 1775, Cumberland was appointed secretary to the Board of Trade and Plantations, which post he held till the abolition of that board in 1782 by Burke's economical reform. Before this event he had, in 1780, been sent on a confidential mission to Spain, to negotiate a separate treaty of peace with that power; but though he was well received by King Charles III. and his minister Floridablanca, the question of Gibraltar proved a stumbling-block, and the Gordon riots at home a most untoward occurrence. He was recalled in 1781, and was refused repayment of the expenses he had incurred, and for which only £1000 had been advanced to him. He thus found himself £4500 out of pocket: in vain, he says, "I wearied the door of Lord North till his very servants drove me from it;" his memorial remained unread or unnoticed either by the prime minister or by secretary Robinson, through whom the original promise had been made. Soon after this experience he lost his office, and had to retire on a compensation allowance of less than half-pay. He now took up his residence at Tunbridge Wells; but during his last years he mostly lived in London, where he died May 7, 1811.

Cumberland's literary productions are spread over the whole of his long life; they are very numerous, but it is only by his contributions to the drama, and perhaps by his *Memoirs*, that he is likely to be remembered. In the latter, however, he dwells with more or less of paternal fondness on a great number of other productions. Among these

should in the first instance be mentioned the collection of essays and other pieces entitled *The Observer* (2 vols., 1785; afterwards republished in 5 vols., and in 6, including a translation of *The Clouds* of Aristophanes). This collection found a place, as the author complacently points out, among *The British Essayists*. For the accounts given in *The Observer* of the Greek writers, especially the comic poets, Cumberland availed himself of Bentley's MSS. and annotated books in his possession, his translations from the Greek fragments, which are not inelegant but lack closeness, are republished in Bailey's *Comicorum Græcorum* (part i., 1840) and *Hermianactis, Archilochi, et Pratinæ Fragmenta*. Cumberland also produced *Anecdotes of Eminent Painters in Spain* (2 vols., 1782); with a *Catalogue of the King of Spain's Paintings* (1787); two novels, *Arundel* (2 vols., 1789,—a story in letters "hastily put together during a few idle weeks at Brighthelmstone") and *Henry* (4 vols., 1795,—a "diluted comedy" on the construction and polishing of which he seems to have expended great care); and a religious epic, *Calvary, or the Death of Christ*, in 8 books (1792); and (as his last publication) a poem entitled *Retrospection*. He is also said to have been concerned in an epic, the *Ætiodiad* (with Sir James Bland Burges) and in *John de Lancaster*, a novel in 3 vols. Besides these he wrote the *Letter to the Bishop of Oxford* in vindication of Bentley; another to the *Bishop of Llandaff* on his proposal for equalizing the revenues of the Established Church (1783); a *Character of Lord Sackville*, whom in his *Memoirs* he vindicates from the stigma of cowardice; and an anonymous pamphlet, *Ortius rescued from the Gulf*, against the redoubtable Dr. Parr. He was also the author of a version of fifty of the Psalms of David; of a tract on the evidences of Christianity; and of other religious exercises in prose and verse, the former including "as many sermons as would make a large volume, some of which have been delivered from the pulpits." Lastly, he edited a short-lived critical journal called *The London Review*, conducted on a principle to which Cumberland doubtless attached high importance,—that the articles should bear the names of the contributors.

Cumberland's *Memoirs*, which he began at the close of 1804 and concluded in September, 1805, were published in 1806, and a supplement was afterwards added. This sufficiently ample narrative of his public and private life (which includes a long account of his Spanish mission) contains some interesting reminiscences of several persons of note,—more especially Bubb Dodington, Single-Speech Hamilton, and Lord George Sackville among politicians, and of Garrick, Foote, and Goldsmith; but the accuracy of some of the anecdotes concerning the last-named is not beyond suspicion. In general the book exhibits its author as an amiable egotist, careful—though not arrogantly so—of his own reputation, given to prolixity, and little remarkable for wit, but a good observer of men and manners. The uneasy self-absorption which Sheridan immortalized in the character of Sir Fretful Plagiary in *The Critic* is apparent enough in his autobiography, but presents itself there in no offensive form. The comparative estimates of the author's own works and the development of their designs are harmless if uninteresting; the long quotations from unpublished or forgotten productions almost ask to be skipped; on the other hand the incidental criticisms of actors have been justly praised, for Cumberland was possessed of theatrical instinct, though not of dramatic genius. Lastly, his morality and piety are here at least free from affectation in their expression, though not less effusive than in his comedies themselves.

Cumberland was hardly warranted in the conjecture that no English author had yet equalled his list of dramas in point of number; but as the plays, published and unpublished, which he produced have been computed to amount to a number exceeding by four that of the sons of Priam, he must be allowed to have been fairly prolific as a dramatist. About 35 of these are regular plays, to which have to be added 4 operas and a farce; and about half of the whole list are comedies. Among these again the best known, upon which the literary reputation of their author virtually rests, belong to what he was pleased to term "legitimate comedy," and to that species of it known as "sentimental." The two terms are in point of fact mutually contradictory; but this was precisely the proposition Cumberland was at so much pains to disprove, though his most successful works remain among the most striking illustra-

tions of its truth. He asserted, with some show of reason, that in his sentimental comedy he was following in the footsteps of the new comedy of the Greeks; he was less willing to confess that he was in truth an imitator of native models; for he was by no means the creator in our dramatic literature of the species he so assiduously cultivated. The essential characteristic of these plays is the combination of plots of domestic interest with the rhetorical enforcement of moral precepts, and with such comic humor (and it is usually but little) as the author possesses. These comedies are primarily, to borrow Cumberland's own phraseology, designed as "attempts upon the heart;" and British hearts are "hearts that feel." He takes great credit to himself for weaving his plays out of "homely stuff, right British druggit," and for eschewing "the vile refuse of the Gallic stage;" on the other hand, he borrowed (often perhaps unconsciously) from the sentimental literature of his own country, including Richardson, Fielding, and Sterne. The favorite theme of his plays is virtue in distress or danger, but safe of its reward in the fifth act; their most constant characters are men of feeling and young ladies who (to quote a retort of Goldsmith upon the sentimental dramatists) are either prudes or coquettes. Cumberland's comic power—such as it was—lay in the invention of comic characters taken from the "outskirts of the empire," and professedly intended to vindicate from English prejudice the good elements in the Scotch, the Irish, and the colonial character. For the rest, patriotic sentiment (such as became one who in his old age was a major of volunteers) liberally asserts itself by the side of general morality. If Cumberland's dialogue never approaches the brilliancy of Sheridan's, and if his characters have about them that air of unreality which in his *Retaliation* Goldsmith satirized with so exquisite a grace, the construction of the plots is as a rule skilful, and the situations are contrived with what Cumberland indisputably possessed—a thorough insight into the secrets of theatrical effect. In this respect at all events he was the "Terence of England," that there is hardly one of his principal plays in which the audience is not allowed to enjoy that most thrilling of theatrical emotions—which is produced by a meeting between parent and child after long years of separation or ignorance of one another's existence. It should be added that, though Cumberland's sentimentality is often wearisome, his morality is generally sound; that if he was without the genius requisite for elevating the national drama, he did his best to keep it pure and sweet; and that if he borrowed much, as he undoubtedly did, it was not the vicious attractions of other dramatists of which he was the plagiary.

After making his *début* as a dramatic author with a tragedy, *The Baniishment of Cicero* (of which the plot, though inspired by Middleton, rather strikingly deviates from history), published in 1761 after its rejection by Garrick; and producing in 1765 a musical drama, *The Summer's Tale*, which was performed for a few nights and afterwards compressed into an afterpiece, *Amelia* (1768), Cumberland first essayed sentimental comedy in *The Brothers* (1769). This comedy has more vigor than some of its author's later works; its theme is inspired by *Tom Jones*; its comic characters are the jolly old tar Captain Ironsides, and the henpecked husband Sir Benjamin Dove, whose progress to self-assertion is perhaps as genuinely comic a notion as Cumberland ever executed, though, as he confesses not altogether an original one. The epilogue paid a compliment to Garrick, who accordingly interested himself in the production of Cumberland's second and by far most successful comedy, *The West-Indian* (1771). The hero of this comedy is a young scapegrace fresh from the tropics, "with rum and sugar enough belonging to him to make all the water in the Thames into punch,"—a libertine with generous instincts, which in the end prevail. The chief comic character is Major O'Flaherty, an honest Irish adventurer, in whom Cumberland took no little pride, but who is in truth neither particularly Irish nor particularly humorous. This comedy was received with the utmost favor; it was afterwards translated into German by Boden, and Goethe acted in it at the Weimar court. The next play of some importance was *The Fashionable Lover* (1772), a sentimental comedy of the most pronounced type, with an ill-used heroine and a man of feeling exhibiting the very pruriency of sentimentality; "who dreams," he exclaims, "that I am the lewd fool of pity, and thou my pandar, Jarvis, my provider?" The comic characters are

an honest Scotch steward, whose Scotch is if anything more doubtful than O'Flaherty's Irish, and an antiquarian Welsh tutor Doctor Druid, less creditable to the "outskirt of the empire" represented by him. *The Choleric Man* (1775), founded on the *Adelphi* of Terence, but not, as the author in his long "dedication" protests, on Shadwell's *Squire of Alsatia*, is of a similar type, the comic element rather predominating, but philanthropy being duly represented by a virtuous lawyer called Manlove. Among subsequent comedies may be mentioned *The Natural Son* (1785), in which Major O'Flaherty, now divested of all humor, makes his reappearance; *The Impostors* (1789), a comedy of intrigue noteworthy for the absence of sentiment, but marred in one of the scenes by an indelicacy of feeling which is unlike Cumberland,—the heroine, "a pleasant child of nature," must have admirably suited Mrs. Jordan. *The Box Lobby Challenge* (1794), a mere protracted farce where there is likewise no sentiment, except in Lindamira's novel; *The Jew* (1794), an essentially serious play creditable to Cumberland's good feeling, and highly effective when the character of Sheva is played as it was by the great German actor Döring; *The Wheel of Fortune* (1795), which has a vague resemblance to Kotzebue's *Stranger* (not produced on the English stage till 1798), and in which the character of the misanthropist Penruddock, who cannot forget but learns to forgive, was a celebrated part of John Kemble, while the lawyer Timothy Wessel was made comic by Suett; *First Love* (1796); *The Last of the Family* (1795); *False Impressions* (1797), in which, as the hero instead of the heroine is the injured innocent, the sentimentality is less formidable,—the diction of the apothecary Scud will startle readers of Dickens by its striking resemblance to that of Mr. Alfred Jingle; *The Sailor's Daughter* (1804); and a *Hint to Husbands* (1806), which, unlike the rest, is in blank verse. These appear to be all the comedies by Cumberland printed in his lifetime, during which were also published his farce of *The Note of Hand* (1774); the songs of his musical comedy, *The Widow of Delphi* (1780); his tragedies of *The Battle of Hastings* (1778); and *The Carmelite* (1784), a romantic domestic drama in blank verse, in the style of Home's *Douglas*, furnishing some effective scenes for Mrs. Siddons and John Kemble as mother and son, but ill-constructed, inasmuch as the hero reveals himself several times in succession; the domestic drama (in prose) of *The Mysterious Husband* (1783), in which the chief character, the bigamist Lord Davenant, is, for so incredible a scoundrel, prematurely remorseful, and is ultimately got rid of by suicide, but the intricate plot is clearly contrived: and some minor pieces.

His posthumously printed plays include the comedies of *The Walloons* (acted 1782—Henderson, who afterwards performed Lord Davenant, achieving a great success as the villainous father Sullivan); *The Passive Husband* (acted as *A Word for Nature*, 1798); *The Eccentric Lover* (acted 1798); and *Lover's Resolutions* (once acted in 1802); the serious quasi-historic drama *Confession*; the drama *Don Pedro* (acted 1796); and the tragedies of *Alcanor* (acted as *The Arab*, 1785); *Torrendal*; *The Sibyl* or *The Elder Brutus* (afterwards amalgamated with other plays on the subject into a very successful tragedy for Edmund Kean by Payne); *Tiberius in Caprea*; and *The False Demetrius*, the last on a theme already treated by an earlier English dramatist, and destined to be the last which occupied the genius of Schiller. Besides these and other dramatic productions of more or less originality, Cumberland, as already stated, translated the *Clouds* of Aristophanes (1797), and altered for the stage Shakespeare's *Timon of Athens* (1771), "engrafting on the original the part of Evanthe for the purpose of writing up the character of Alcibiades," and inserting other "new matter," of which he has preserved a specimen in his *Memoirs*, as well as Massinger's *The Bondman* and *The Duke of Milan* (both 1779).

(A. W. W.)

CUMBERLAND, WILLIAM AUGUSTUS, DUKE OF, son of George II. and Queen Caroline, was born on the 15th of April, 1721. When five years of age he was created duke of Cumberland; and when still very young he gave interesting amusement to his grandfather and the London public by the ability with which he drilled and manoeuvred a company of boy soldiers under his own charge. His education was well attended to, and his courage and capacity in outdoor exercises were notable from his early years. In 1740 he sailed as a volunteer in the fleet under the command of Sir John Norris; but he quickly became dis-

satisfied with the navy, and early in 1742 he began the military career in which he was destined to play so prominent a part.

The importance for England of the European struggle which began with the death of Charles VI. was that France had declared against the young Hungarian queen. The war on the part of Britain was begun by a force of over 16,000 men being despatched to Flanders under the command of the earl of Stair. The English troops were reinforced by Hessians and Hanoverians in British pay, and in 1743 George II. and the "martial boy" shared in the glory of Dettingen (27th June). The duke of Cumberland, who led the left of the victorious army, and was wounded in action, displayed an energy and valor on the report of which in England that tide of his popularity began to flow which was in flood at Culloden, and which steadily ebbed thereafter till his death.

In 1745 the duke was again in Flanders, and on this occasion he was in full command, having under him British, Hanoverian, Austrian, and Dutch troops to the number of 50,000. Advancing to the relief of Tournay, which was besieged by Marshal Saxe, he engaged the greatest general of the age at Fontenoy on the 11th of May. It cannot now be doubted that, had the duke been supported by the allies in his marvellously courageous attack on the superior positions of the French army, Fontenoy would not have been recorded as a defeat to the British arms. Three times renewing his attack in spite of repulse, he was at last forced to yield, which he did by effecting a dogged and masterly retreat.

Notwithstanding a severity of discipline which would astonish soldiers of the present day, the young duke had the power to inspire his men with a strong attachment to his person and a very lively *esprit de corps*. As a general his courage and resolution were not sufficiently tempered with sagacity and tact; but he displayed an energy and power in military affairs which pointed him out to the British people as the one commander upon whom they could rely to put a decisive stop to the marvellous successes of Prince Charles Edward in the rebellion of 1745-46.

He was accordingly recalled from Flanders, and immediately proceeded with his preparations for quelling the insurrection. He joined the midland army under Sir John Ligonier, and was at once in pursuit of his swift-footed foe. But the retreat of Charles Edward from Derby disconcerted his plans; and it was not till they had reached Penrith, and the advanced portion of his army had been repulsed by Lord George Murray on Clifton Moor, that he became aware how hopeless an attempt to overtake the retreating Highlanders would then be. Carlisle having been retaken, he retired to London, till the news of the defeat of Hawley at Falkirk roused again the fears of the English people, and centred the hopes of Britain on the royal duke. He was appointed commander of the forces in Scotland.

Having arrived in Edinburgh on the 30th of January, 1746, he at once proceeded in search of the young Pretender. (See CHARLES EDWARD.) He diverged, however, to Aberdeen, where he usefully and energetically employed his time in training the well-equipped forces now under his command for the peculiar nature of the warfare in which they were about to engage. What the old and experienced generals of his time had failed to accomplish or even to understand, the young duke of Cumberland, as yet only twenty-four years of age, effected with simplicity and ease. He prepared to dispose his army so as to withstand with firmness that onslaught on which all Highland successes depended; and he inspired his men with courage by directing each, on the fierce assault being made, to transfix with his bayonet not his immediate opponent but the killed warrior on his right.

On 8th April, 1746, he set out from Aberdeen on that expedition so fruitful in disaster to his enemies, and so fatal to the last hopes of Jacobitism. To his astonishment he was not opposed on the Spey. To his great advantage the attempt of Lord George Murray to surprise his troops as they lay encamped near Nairn proved worse than futile to the exhausted and starving foe, whom on the morrow he engaged and defeated at Culloden. This battle, fought on the 15th of April, resulted in the total overthrow of the Highland army. It is vain to deny that the men wounded in battle were deliberately despatched by orders of the duke, and that his hard and unsparring nature, coupled

with his firm and unfeeling resolve to treat the vanquished merely as rebels, induced him to deny to those whom he had conquered the privileges of war or their rights as fellow-countrymen. His excesses have been over-estimated, but it cannot be gainsaid that they were unconstitutional and most cruel. The relief occasioned to Britain by the duke's victorious efforts was acknowledged by his being voted an income of £40,000 per annum in addition to his revenue as a prince of the royal house.

Henceforth, however, the career of Cumberland was to be one of signal defeat. In 1747 he was again on the Continent opposing the still victorious Marshal Saxe; and at Lauffeld, near Maestricht, the Dutch, Austrian, and English allies under the joint command of the duke and his brother-in-law Prince William of Nassau received a notable defeat. Ten years afterwards Cumberland soured his popularity both as a soldier and a statesman by the affair of Closterseven. When Frederick the Great was suffering the terrible defeats of Prague and Kolin, at the hands of the Austrians, the duke of Cumberland was attempting to defend Hanover at the head of a motley army, raised chiefly in Brunswick, Prussia, and the Electorate. But it was quite in vain; and at Hastenbeck, near Hameln, on the 26th of July, 1757, he was defeated by the superior forces of D'Estrees. In September of the same year his defeat had almost become disgrace. Driven from point to point, and at last hemmed in by the French under Riche-lieu, he capitulated at Closterseven on the 8th of the month, abjectly agreeing to disband his army and to evacuate Hanover, which he had undertaken to defend. His disgrace was completed on his return to England by the king's refusal to be bound by the terms of the duke's agreement. In chagrin and disappointment he retired into private life, after having formally resigned the public offices he held.

It was not till shortly before his death that he again appeared on the stage of public affairs. In 1765, when the debates on the regency bill were agitating the people of England, George III., dissatisfied with Grenville and his ministry, applied to his royal uncle the duke of Cumberland, who was now in failing health, to open negotiations with Pitt for a return to power. On Pitt's declination, and symptoms of violence becoming evident among the populace, Cumberland again attempted to extricate the king from his unfortunate position by a second negotiation with the great and popular statesman. This too was, however, unsuccessful. On 31st October, 1765, the duke died. His statue stands in Cavendish Square.

See, in addition to the histories of the time and the literature of the Rebellion, *Historical Memoirs of the Duke of Cumberland; A Journey through part of England and Scotland along with the Army under the command of H. R. H. the Duke of Cumberland; and especially William Augustus Duke of Cumberland*, by A. N. Campbell-Maclachlan, 1876. (r. s.)

#### CUMBRAE ISLANDS. See BUTE.

CUMIN, or CUMMIN (*Cuminum Cyminum*), is an annual, umbelliferous, herbaceous plant, indigenous to Upper Egypt, but early cultivated in Arabia, India, and China, and in the countries bordering the Mediterranean. Its stem is slender and branching, and about a foot in height; the leaves are multifold, with filiform segments; the flowers are small and white. The fruits or achenes, the so-called seeds, which constitute the cumin of pharmacy, are fusiform or ovoid in shape, and compressed laterally; they are two lines long, are hotter to the taste, lighter in color, and larger than caraway seeds, and have on each half nine fine ridges, overlying as many oil-channels or vittæ. Their strong aromatic smell and warm bitterish taste are due to the presence of about three per cent. of an essential oil. The tissue of the seeds contains a fatty oil, with resin, mucilage and gum, malates, and albuminous matter; and in the pericarp there is much tannin. The volatile oil of cumin, which may be separated by distillation of the seed with water, is mainly a mixture of cymol or cymene,  $C_{10}H_{16}$ , and cuminic aldehyde,  $C_9H_8(C_2H_5)COH$ . Cumin is mentioned in Isaiah xxviii. 25, 27, and Matthew xxiii. 23, and in the works of Hippocrates and Dioscorides. From Pliny we learn that the ancients took the ground seed medicinally with bread, water, or wine, and that it was accounted the best of condiments as a remedy for squeamishness. It was found to occasion pallor of the face, whence the expression of Horace, *exsangue cuminum* (*Epist.* i. 19), and that of Persius, *pallentis grana cumini*

(*Sat.* v. 55). Pliny relates the story that it was employed by the followers of Porcius Latro, the celebrated rhetorician, in order to produce a complexion such as bespeaks application to study (xx. 57). In the Middle Ages cumin was one of the commonest spices of European growth. Its average price per pound in England in the 13th and 14th centuries was 2d., or, at present value, about 1s. 4d. (Rogers, *Hist. of Agric. and Prices*, i. 631). It is stimulant and carminative, and is employed in the manufacture of curry powder. The medicinal use of the drug is now almost confined to veterinary practice. Cumin is exported from India, Mogador, Malta, and Sicily.

CUMMING, ROUALEYN GORDON, Scottish traveller and sportsman, generally known as "the Lion Hunter," was born March 15, 1820. He was the second son of Sir William G. Gordon Cumming, baronet, of Altyre and Gordonstown, North Britain. In his early years a strong love for nature in her wildest forms and a passion for sport displayed themselves in him, at once foreshadowing and determining his future career. He was educated at Eton, and at the age of eighteen passed the examination at Addiscombe and entered the Indian army (Madras Light Cavalry). In consequence of the injurious effects of the climate on his health he did not remain long in India, but retired from the service and returned to Scotland. During his stay, however, he had laid the foundation of his large and interesting collection of hunting trophies and specimens of natural history. After indulging for a time in his favorite pursuits in his native land, he resolved to visit the prairies and mountain solitudes of the Far West. This project, however, was relinquished in favor of a visit to South Africa. He joined the Cape Riflemen, and in 1848 began his five years' hunter's life, the story of which is told in his well-known work, published in 1850. He did not remain long in the army; but for the sake of absolute freedom sold out and set forth to explore the unknown regions of interior Africa. His wagon was his only home; and even this he often quitted for the sake of bolder ventures either alone or attended only by savages. His collection, the South African Museum, was exhibited in London in 1851, at the time of the Great Exhibition, and was illustrated by a lecture delivered by the famous hunter himself. The museum was afterwards exhibited in various parts of the country. During the last eight years of his life he resided at Fort Augustus, where his collection attracted many visitors. He died there, March 24, 1866.

CUNARD, SIR SAMUEL (1787-1865), baronet, civil engineer, founder of the Cunard line of Atlantic steam-ships, was born at Halifax, Nova Scotia, in 1787. He was the son of a merchant, and was himself trained for the pursuits of commerce, in which, by his abilities and enterprising spirit, he attained a conspicuous position. When, in the early years of steam navigation, the English Government made known its desire to substitute steam vessels for the sailing ships then employed in the mail service between England and America, Cunard heartily entered into the scheme, came to England, and accepted the Government tender for carrying it out. A company was formed, the members of which were Cunard, Messrs. Burns of Glasgow, and Messrs. MacIver of Liverpool, these two firms being then proprietors of rival lines of coasting steamers between Glasgow and Liverpool. For the first contract with the Government four steam vessels were built, and the first voyage was successfully made by the "Britannia" from Liverpool to Boston, U.S., between July 4 and 19, 1840. Such was the small beginning of an undertaking which in the course of thirty-seven years has grown into one of the vastest of private enterprises, and may even rank in importance, as to the extent of interests involved in it, and the number of hands employed, with railway and other public companies. In 1852 the company began to substitute iron screw steamers for the wooden vessels with paddle-wheels in use up to that time. The Cunard fleet has always borne the highest character for the build, manning, management, and provisioning of the ships; and the reward of the scrupulous care exercised has been a rare immunity from what are called "casualties." In acknowledgment of his energetic and successful services Cunard was, in 1859, created a baronet. He died in London, April 23, 1865.

CUNEIFORM WRITING. The cuneiform or "wedge-shaped" system of writing takes its name from the wedge-

like form of its characters, which were once extensively used over Western Asia. It has sometimes been called "arrow-headed" from the supposed resemblance of the several strokes which compose a character to the head of an arrow. The characters were originally hieroglyphics, each denoting an object or idea, and, like the Chinese, were gradually corrupted into the forms we see on the Assyrian monuments. They were invented by the primitive Accadian population of Chaldea, who spoke an agglutinative language, and were borrowed from them by their Semitic conquerors, the Babylonians and Assyrians. The characters had come to be used phonetically as well as ideographically even in Accadian times; but they were not reduced into a systematic syllabary until the Semites changed the Accadian words they represented into as many phonetic values. The abundance of clay in Babylonia caused this material to be largely employed for writing purposes, and the impress of the metal style upon it gave the characters their wedge-like appearance. The Semites carried the new syllabary with them into Assyria, and, as in Babylonia, continued to employ it both as a syllabary and as a collection of ideographs; that is to say, a character might not only denote a mere unmeaning syllable, but an idea as well. As each character had answered to several different Accadian words, the Assyrian syllabary by changing these words into phonetic values became necessarily polyphonous. In the 9th century B. C. the Alarodian tribes of Armenia borrowed a selected number of characters and ideographs from the Assyrian syllabary, giving to each character one value only. At a subsequent date the "Turanian" population of Media and Northern Susiania did the same, producing the syllabary of the Protomedic transcripts which accompany the Persian and Babylonian inscriptions of the Achaemenian kings. The Persian cuneiform alphabet of 40 characters was itself taken from the same source under the reign of Darius; the meaning of each character, when used as an ideograph, being expressed in Persian, and the initial letter of the Persian word being then assigned to it as a value. The cuneiform system of writing had been in use in southern Susiania in very early times, and accordingly the forms of the characters employed there agree with those found in the oldest Chaldean inscriptions. Indeed it is probable that it was invented by the Accadians before they had descended into Babylonia from the mountains of Elam, about 3000 B. C. As employed in Babylonia and Assyria, the cuneiform writing tended to become more and more simplified, unnecessary wedges being discarded, and we may, therefore, divide it into Archaic, Hieratic, Assyrian, and Later Babylonian. See INSCRIPTIONS.

CUNITZ, MARIA, a celebrated astronomer, born about the beginning of the 17th century, was the eldest daughter of a doctor of medicine in Silesia, and the wife of a Dutch physician, Elias de Loewen, whom she married in 1630. She is said to have understood Polish, German, French, Italian, Latin, Greek, and Hebrew, and to have had an extraordinary general culture, but her principal study was mathematics and astronomy. Her tables, published under the title *Urania Propitia, sive Tabulae Astronomicae*, which gained for her a great reputation, were composed in a Polish convent, where, with her husband, she had taken refuge at the outbreak of the Thirty Years' War. They were printed in Latin and German (Oels, 1650, and Frankfurt, 1651), and dedicated to the Emperor Ferdinand III.

CUNNINGHAM, ALLAN (1784-1842), a Scottish poet and prose writer, was born at Blackwood, in Dumfriesshire, and began life as a stone mason's apprentice. He commenced literary work as collector of ballads for Cromek's *Remains of Nithdale and Galloway Song*; but instead of collecting ballads, he sent in poems of his own, which the editor inserted without suspicion. In 1810 he repaired to London, where he supported himself partly by working in the studio of Bubb the statuary, and partly as a newspaper reporter, till 1814, when he obtained the situation of clerk of the works in the studio of Francis Chantrey, in which he continued till the sculptor's death in 1841. He meanwhile continued to be busily engaged in literary work. Cunningham's prose is often spoiled by its misplaced and too ambitious rhetoric; his verse also is often over ornate; and both are full of mannerisms. Some of his songs, however from their brightness, vigor, and warmth of feeling, hold a high place in our lyrical literature.

His chief works are *Lives of the Most Eminent British Painters, Sculptors, and Architects (1829-1833)*, *Sir Marmaduke Mac-*

well, a dramatic poem, *Traditionary Tales of the Peasantry*, several novels (*Paul Jones*, *Sir Michael Scott*, *Lord Roldan*), the *Maid of Elowar*, a sort of epic romance, the *Songs of Scotland* (1825), *Biographical and Critical History of the Literature of the Last Fifty Years* (1833), an edition of *The Works of Robert Burns*, with notes and a life containing a good deal of new material (1834), *Biographical and Critical Dissertations* affixed to Major's *Cabinet Gallery of Pictures*, and *Life, Journals, and Correspondence of Sir David Wilkie*, finished two days before his own decease, and published in 1843. An edition of his *Poems and Songs* was issued by his son, Peter Cunningham in 1847.

CUNNINGHAM, PETER (1816-1869), topographical and antiquarian litterateur, was born in London, April 7, 1816. He was the son of the Scottish poet Allan Cunningham, and was educated at Christ's Hospital. He led a singularly uneventful life; for at the age of eighteen he was appointed by Sir Robert Peel, in recognition of his father's genius and reputation, to a junior clerkship in the audit office, and after twenty years' faithful and efficient service he was promoted to a chief clerkship. This post he filled till 1860, when he retired from the public service. His literary career began before his official, and his first published work was *The Life of Drummond of Hawthornden*, with large selections from his poetical works. This volume appeared in 1833. His most important topographical work is the *Handbook of London*, the first edition of which was published in 2 vols. in 1849, and the second in 1 vol. in 1850. It bears a high character for fulness and accuracy of information, and is made particularly attractive by the intermingling of authentic anecdote and incident with the necessary details of names and dates. Among Cunningham's other publications are,—*Songs of England and Scotland* (1835), *Handbook of Westminster Abbey* (1842), *A Life of Inigo Jones* for the old Shakespeare Society (1848), *Modern London* (1851), *The Story of Nell Gwynn* (1852), and a "Memoir of J. M. W. Turner," prefixed to Burnett's *Turner and his Works* (1852). In 1854 he edited, for Mr. Murray's "Library of British Classics," the works of Oliver Goldsmith and Johnson's *Lives of the Poets*, with additional lives. He was a contributor to the *Athenæum*, *The Illustrated London News*, *Fraser's Magazine*, and other periodicals. He was also engaged as collaborateur with Croker on a new edition of Pope's works. He died at St. Alban's, May 18, 1869.

CUNNINGHAM, WILLIAM (1805-1861), a Scottish theologian and ecclesiastic, was born at Hamilton, in Lanarkshire, on the 2d October, 1805. After the usual course of study at the university of Edinburgh, in which he acquitted himself with distinction, he was licensed to preach in 1828. Two years afterwards he was ordained to a collegiate charge in Greenock, where he remained for three years, refusing during that time a presentation offered him to a parish in Glasgow. In 1834 he was transferred to the charge of Trinity College parish, Edinburgh. His removal thus coincided with the commencement of the period known in Scottish ecclesiastical history as the Ten Years' Conflict, in which he was destined to take a leading share. In the stormy discussions and controversies which preceded the Disruption the weight and force of his intellect, the keenness of his logic, and his firm grasp of principle made him one of the most powerful advocates of the cause of spiritual independence; and he has been generally recognized as one of three to whom mainly the existence of the Free Church is due, the others being Chalmers and Candlish. On the formation of the Free Church in 1843 Cunningham was appointed professor of church history and divinity in the New College, Edinburgh, of which he became principal in 1847 in succession to Chalmers. His career as a professor was very successful, his controversial sympathies combined with his evident desire to be rigidly impartial qualifying him to be an interesting delineator of the more stirring periods of church history, and a skillful disentangler of the knotty points in theological polemics. His logical faculty and his total lack of imagination perhaps made him too ready to seek to compress all spiritual truth within the rigid limits of intellectual forms. These qualities are reflected in two able works published posthumously in 1862, his *Historic Theology in the Christian Church* and his *Reformers and the Theology of the Reformation*. In 1859 the church marked its sense of obligation to him by appointing him moderator of the General Assembly. He had received the degree of D. D. from the university of Princeton in 1842. He died on the 14th December, 1861.

Though impulsive and unsparing and sometimes apparently a little unscrupulous in debate, Cunningham was like many great controversialists of his class distinguished for the amiability, simplicity, and integrity of his character. His intellectual rigidity was balanced by a considerable breadth of sympathy, as is evidenced by the fact that he was one of the founders of the Evangelical Alliance. A *Life of Cunningham* by Rainy and Mackenzie appeared in 1871. A theological lectureship at the New College, Edinburgh, was endowed in 1862, to be known as the Cunningham lectureship.

CUPAR-FIFE, so-called to distinguish it from Coupar-Angus in Perthshire, is a royal and parliamentary burgh of Scotland, and the principal town of the county of Fife. It stands on the left bank of the Eden, in the centre of the Howe or Hollow of Fifeshire, about 6 miles from the sea, and is about 32 miles distant by railway and ferry from Edinburgh. The town-hall, the county hall, and the corn-exchange are the chief public buildings, and the principal educational establishment is the Madras Academy, originally founded in 1823 by a joint-stock company, but extended and modified in keeping with the will of Dr. Bell, the well-known originator of the "Madras System," who left it a valuable endowment. The staple trade of Cupar has long been the manufacture of linen; and it also possesses breweries, corn-mills, and tan-yards. There are several collieries in the neighborhood; and a stone quarry and a considerable pottery exist at Cupar Muir, about a mile and a half to the west of the town. The parliamentary burgh is a member of the St. Andrews district; its population in 1871 was 5105. Cupar received its municipal freedom about 1356 by charter from David II. It was early remarkable for its castle, which occupied the height to the east of the town now crowned by the academy buildings, and was one of the principal strongholds of the Macduffs, the earls or thanes of Fife. Being situated between Falkland and St. Andrews, the town was frequently visited by the Scottish kings; and in 1583 it was for a time the residence of the court of James VI. The estate of Sir David Lindsay of the Mount was within three miles of Cupar; and on a green esplanade in front of Macduff Castle, still called the Play-field, the satirical drama of the *Three Estates* and the *Tragedy of the Cardinal* were first performed. From the press of Mr. Tullis in Cupar there appeared about the beginning of the present century editions of Virgil, Horace, and other classical authors, by Dr. Hunter of St. Andrews, which obtained high reputation for their accurate typography. The Scotch proverb, "They that will to Cupar maun to Cupar," owes its origin to the fact that Cupar was the seat of a court of justice, and refers originally to the obstinacy of persons determined to appeal to the law.

CUPID (AMOR, "Ἔρως," in classical mythology, was the god, first, of the principle of love as it was seen to exist throughout nature, and, secondly, of love as a human passion. In the former and earlier phase of his character, he resembled Hermes, and like him was probably a deity of the primitive Pelasgians, since the worship of him at Parion on the Hellespont was connected with the Pelasgic religion of Samothrace, one of the deities of which is named "Ἄφροδίτη." The same primitive character appears at Thespis, where the symbol of his worship was an unhewn stone (ἀργύρεος λίθος). He was the oldest of the gods, being the son of Chaos, or of night and day, or of heaven and earth, with a variety of other poetic parentages. But as god of human love he was the son and constant companion of Aphrodite (Venus); yet even in this respect his earlier character is partly visible, since she was goddess of spring-time, and brought him up in the fields till spring burst from the beautiful island of Cyprus, and spread fertility over the earth. In his ethical capacity he was regarded as the most recent of the gods, and was represented as a beautiful winged youth with bow and arrows or with a torch. The fact of his having wings would preclude him from being classed with the great deities. But as messenger of Venus he would have the same right to them that Iris derived from her office as messenger of the gods. At Thespisæ gymnastic and musical contests (Erotidia) were held in his honor every four years; and generally in Greece his statue was to be found beside those of Hermes and Hercules in the palaestra. The statue of Cupid by Praxiteles at Thespisæ was greatly celebrated. The Spartans and Cretans sacrificed to him before battle. In later works of art Cupid

assumed simultaneously a number of forms ("Epoetes," each identical with the other, as if to indicate his presence at many points at once. We have also Eros and Anteros, or love and its opposite. The story of Cupid and Psyche, as given by Apuleius and as illustrated in later art, is a figurative explanation of the course of human love. The great beauty of Psyche, a king's daughter, excites the jealousy of Venus, who sends Cupid to her to inspire her with love for some ordinary person. But he is caught by her charms, and lives with her happily in a fairy palace, she being under a vow not to look on him with her mortal eyes. Taunted for this by her sisters, she breaks the vow and Cupid vanishes. Venus now imposes on her many sore troubles. At last she must fetch a box for her from Hades, which curiosity makes her open on the way, and the scent escaping from it overpowers her. Cupid comes to her aid, implores Jupiter in her behalf, and with his consent she is removed to Olympus, where she lives for ever with Cupid.

**CUPPING.** The operation of cupping is one of the methods adopted by surgeons to draw blood from an inflamed part in order to relieve the inflammation. The apparatus required is a spirit-lamp and a glass cup with a rounded edge. The skin is washed and dried; the air is rarefied in the cup by the flame of the lamp; the cup is then firmly applied to the skin. A partial vacuum forms within the cup as the air cools, and the blood rushes from the neighboring parts to the skin under the cup. Either the blood is drawn from the patient's body through a number of small wounds which are made in the skin with a special instrument before the cup is applied, or the cup is simply applied to the unbroken skin and the blood drawn into the subcutaneous tissue within the circumference of the cup. The result of both methods is the same, namely, a withdrawal of blood locally from the inflamed part. The former is called moist cupping, the latter dry cupping. Moist cupping is inapplicable on exposed surface, as the mark of the small skin wounds is indelible.

**CURAÇOA,** or **CURAÇAO,** an island in the Caribbean Sea, lying off the north coast of Venezuela, in 12° N. lat., 69° W. long. It is 40 miles in length from N. W. to S. E., and 10 in average breadth; the area is 212 square miles. The island is hilly and deficient in water, being wholly dependent upon the rains, yet owing to the industry of the Dutch planters, considerable quantities of sugar, cotton, indigo, tobacco, and maize are raised. A peculiar variety of orange, the *Citrus Aurantium curassaviensis*, grows abundantly, and furnishes the distinguishing ingredient in the liqueur which takes its name from the island. The principal export is salt. The shores, which are bold, are in some places deeply indented, and present several harbors, the chief of which is Santa Anna, on the south-west side of the island. The entrance to this, which is narrow, is protected by Fort Amsterdam and other batteries; but the harbor itself is large and secure, and is the port of the chief town Curaçoa, or Willemstad. The population in 1875 amounted to 23,972, about one-third being emancipated negroes. All belonged to the Roman Catholic Church, except about 2000 Protestants and 1000 Jews. The island was settled by the Spanish about 1527, and was captured by the Dutch in 1634. It was taken by the English in 1798, and again in 1806, but was restored in 1814 to the Dutch, in whose possession it has since remained.

**CURASSOW** (*Cracinae*), a group of gallinaceous birds forming one of the sub-families of *Cracidae*, the species of which are among the largest and most splendid of the game-birds of South America, where they may be said to represent the pheasants and grouse of the Old World. They are large, heavy birds, many of them rivalling the turkey in size, with short wings, long and broad tail, and strong bill. In common with the family to which they belong, they have the hind toe of the foot placed on a level with the others, thus resembling the pigeons, and unlike the majority of gallinaceous birds. With the exception of a single species found north of Panama, the curassows are confined to the tropical forests of South America, east of the Andes, and not extending south of Paraguay. They live in small flocks, and are arboreal in their habits, only occasionally descending to the ground, while always roosting and building their nests on the branches of trees. Their nests are neat structures, made of slender branches interlaced with stems of grass, and

lined internally with leaves. They feed on fruits, seeds, and insects. They are said to be domesticated in several parts of South America, and Bates states that when journeying up the Amazon he was amused "at the excessive and almost absurd tameness of a fine curassow turkey (*Mitua tuberosa*)," which ran about one of the planter's houses in which he happened to stay. Large numbers of these birds were, according to Temminck, brought to Holland from Dutch Guiana towards the end of last century, and got so completely acclimatized and domesticated as to breed in confinement like ordinary poultry; but the establishments in which these were kept were broken up during the troubles that followed on the French Revolution. Their flesh is said to be exceedingly white and delicate, and this, together with their size and the beauty of their plumage, would make the curassows an important gain to the poultry-yards of Europe, should they yet be successfully reared. The sub-family of curassows contains four genera and twelve species, all confined to South America, with the exception of *Crax globicera*—a Central American species, which extends northward into Mexico. This bird is about 3 feet in length, of a glossy black color, with green and purple reflections over the whole body, excepting the abdomen and tail coverts, which are white. In common with the other species of this genus its head bears a crest of feathers curled forward at the tips, which can be raised or depressed at will. The female is of a reddish color, although varying greatly in this respect, and was until lately described as a separate species—the Red Curassow. In another species, *Crax incommoda*, the greater part of the black plumage is beautifully varied with narrow transverse bars of white. The Galleated Curassow (*Pauxi galeata*) is peculiar in having a large blue tubercle, hard and stony externally, but cellular within, and resembling a hen's egg in size and shape, situated on the base of the bill. It only appears after the first moulting, and is much larger in the male than in the female.

**CURATE** (from the Latin *curare*, to take care of), properly a presbyter who has the cure of souls within a parish, being the Latin equivalent of the Greek *paroecus*. The term curate is used in this general sense in certain rubrics of the Anglican Prayer Book, in which it is applied equally to rectors and vicars as to perpetual curates. In a more limited sense it is applied in the Church of England to the incumbent of a parish who has no endowment of tithes, as distinguished from a perpetual vicar, who has an endowment of small tithes, which are for that reason sometimes styled vicarial tithes. The origin of such unendowed curacies is traceable to the fact that benefices were sometimes granted to religious houses *pleno jure*, and with liberty for them to provide for the cure; and when such appropriations were transferred to lay persons, being unable to serve themselves, the appropriators were required to nominate a clerk in full orders to the ordinary for his license to serve the cure. Such curates, being not removable at the pleasure of the appropriators, but only on due revocation of the license of the ordinary, came to be entitled perpetual curates. The term "curate" in the present day is almost exclusively used to signify a clerk who is assistant to an incumbent; and a clerk in deacon's orders is competent to be licensed by a bishop to the office of such assistant curate. The consequence of this misuse of the term "curate" has been that the title of "perpetual curate" has fallen into desuetude in the Anglican Church, some inconvenience being found to result from the indiscriminate application of the term "curate," in the case of perpetual curacies, both to the incumbent of the parish and to his assistant curate, and an Act of Parliament (31 and 32 Vict. c. 117) has accordingly been passed to authorize such incumbents to style themselves vicars. The Act provides as follows:—

"The incumbent of the church of every parish or new parish for ecclesiastical purposes, not being a rector, who is or shall be authorized to publish banns of matrimony in such church, and to solemnise therein marriages, churches, and baptisms, according to the laws and canons in force in this realm, and who is or shall be entitled to take, receive, and hold for his own sole use and benefit the entire fees arising from the performance of such offices without any reservation thereof, shall from and after the passing of this Act, for the purposes of style and designation, but not for any other purpose, be deemed and styled the vicar of such church and parish or new parish, as the case may be, and his benefice shall for the same purpose be styled and designated a vicarage."



**CURES**, an old town of the Sabines, not far from the left bank of the Tiber, about 25 miles from Rome. It was renowned in Roman story as the birth-place of Tattus, the colleague of Romulus, and of Numa the second king of Rome; and, according to the belief of the ancients, the term *Quirites*, the distinguishing epithet of the Roman people, was derived from its name. If it be true, as Strabo asserts, that Cures was at one time a large city, it early fell into decay. About 100 B. C. it was colonized by Sulla, and continued to prosper till about the 4th century of the Christian era. It was finally destroyed by the Lombards before the end of the 6th century. Remains of the town have been discovered at the modern village of Coreese.

**CURETON**, WILLIAM, D. D. (1808–1864), a famous English Orientalist, was born at Westbury, in Shropshire. After being educated at the Free Grammar School of Newport, and at Christ Church, Oxford, he took orders in 1832, became chaplain of Christ Church College, sub-librarian of the Bodleian, and, in 1837, assistant keeper of MSS. in the British Museum. He was afterwards appointed select preacher to the university of Oxford, chaplain in ordinary to the queen, rector of St. Margaret's Westminster, and canon of Westminster. He was elected fellow of the Royal Society, corresponding member of the German Oriental Society and of the Institute of France, and foreign associate of the Institute, member of the French Asiatic Society and of the Historico-Theological Society of Leipsic, and trustee of the British Museum. He died in 1864.

Cureton's most remarkable work was the edition with notes and an English translation of the Epistles of St. Ignatius to St. Polycarp, the Ephesians, and the Romans, from a Syriac MS., found in the monastery of St. Mary Deipara, in the desert of Nitria, near Cairo. He held that the MS. he used gave the truest text, that all other texts were inaccurate, and that the epistles contained in the MS. were the only genuine epistles of St. Ignatius that we possess—a view which received the support of F. C. Baur, Bunsen, and many others, but which was opposed by Dr. Wordsworth and by several German scholars. Cureton supported his view by his *Vindiciæ Ignatianæ* and his *Corpus Ignatianum*,—a complete collection of the Ignatian Epistles, genuine, interpolated, and spurious. He also edited a partial Syriac text of the *Festal Letters of St. Athanasius*, which was translated into English by Henry Burgess (1854), and published in the *Library of Fathers of the Holy Catholic Church; Remains of a very Ancient Recension of the Four Gospels in Syriac, hitherto unknown in Europe; Spicilegium Syriacum, containing Remains of Bardesane, Meliton, Ambrose, Mara Bar Serapion; The Third Part of the Ecclesiastical History of John, Bishop of Ephesus, which was translated by Payne Smith; Fragments of the Iliad of Homer from a Syriac Palimpsest; an Arabic work known as the Thirty-first Chapter of the Book entitled The Lamp that guides to Salvation, written by a Christian of Tekrit; The Book of Religious and Philosophical Sects, by Muhammed al Sharastani; a Commentary on the Book of Lamentations, by Rabbi Tanchum; and the Pillar of the Creed of the Sunnites.* Cureton also published several sermons, among which was one entitled, *The Doctrine of the Trinity not Speculative but Practical.* After his death Dr. W. Wright of the British Museum edited with a preface the *Ancient Syriac Documents relative to the earliest Establishment of Christianity in Edessa and the neighboring Countries, from the year of our Lord's Ascension to the beginning of the fourth Century; discovered, edited, and annotated by the late W. Cureton.*

**CURFEW**, **CURFEU**, or **COUVRE-FEU**, a signal, as by tolling a bell, to warn the inhabitants of a town to extinguish their fires and lights and retire to rest. This was a common practice throughout the various countries of Europe during the Middle Ages, especially in cities taken in war. In the law Latin of those times it was termed *ignilegium*, or *pyrilegium*. The curfew is commonly said to have been introduced into England by William the Conqueror, who ordained, under severe penalties, that at the ringing of the curfew-bell at eight o'clock in the evening all lights and fires should be extinguished. It seems probable, however, that he merely enforced an existing and very common police regulation to that effect. The absolute prohibition of lights after the ringing of the curfew-bell was abolished by Henry I. in 1100. The practice of tolling a bell at a fixed hour in the evening, still extant in many places, is a survival of the ancient curfew. The common hour was at first seven, and it was gradually advanced to eight, and in some places to nine o'clock. In Scotland ten was not an unusual hour. As a precaution against conflagrations, the curfew was a most useful regulation, at a period when it was the custom to place the fire in a hole in the

middle of the floor, under an opening in the roof to allow the escape of the smoke. When a family retired to rest for the night, the fire was extinguished by covering it up; and hence the term *couvre-feu*, or curfew. But this salutary regulation served another important end, since by obliging people to keep within doors, nocturnal brawls in the streets were in a great measure prevented. There is a popular tradition, for which no historical authority can be assigned, that the severity exhibited by William the Conqueror in enforcing obedience to the curfew, was more particularly designed to prevent the English from assembling in secret to plan schemes of rebellion against himself. The ringing of the "prayer-bell," as it is called, which is still practised in some Protestant countries, originated in that of the curfew-bell.

**CURIA**, the name of the ten divisions into which a tribe was divided by the constitution of Romulus. There being three tribes, there were thirty curiæ, a number which was not altered when the number of the tribes was increased to thirty-five. This division was a division of the populus, to the exclusion of the plebs; and hence the assembly of the populus was called the *comitia curiata*. But when Servius Tullius instituted the *comitia centuriata* as the sovereign assembly of the republic, the *comitia curiata* lost almost all power other than ecclesiastical, except that of conferring upon magistrates the *imperium* and the privilege of taking auspices; and even this remnant of their political authority became a mere form, which was sometimes neglected. But the curiæ retained all their ecclesiastical functions; each elected a chief priest, or *curio*, and a subordinate priest, called the *curialis flamen*, while together they elected the *curio maximus*, who presided over the *curiones*. The *comitia curiata* alone could sanction *adrogatio*, or the adoption of a man who was *sui juris*, or not under the control of parents. The building in which a curia met was also called a *curia*; and the name was given, besides, to the buildings in which a senate met, and even to a senate itself, though never to the senate of Rome.

Under the later empire the "curiales" exercised many important and very diversified functions, which Jacobus Gothofredus gives a catalogue of under twenty-two heads (see *Animad. in Cod. Theod.*, lib. xii. tit. i.). Bingham speaks of these offices of the "curiales" as synonymous with "municipal" offices. The holders of them were by special ecclesiastical constitution made incapable of receiving holy orders. And, on the other hand, clerks—or at least such as had no property of their own apart from that derived from any ecclesiastical benefice—were exempted from the duty of accepting the office of "curialis."

**Papal Court.**—At a later period, probably not earlier than the 12th century, the phrase *curia Romana* came to be synonymous with *corte Romana*, and was used to signify the entire body of persons employed in attendance on the Pope and in transacting the business of the Roman see. It seems indeed to have been at that time occasionally used in a sense equivalent to the "Holy See," comprising, in the idea signified, the Pontiff himself.

In process of time, however, a distinction seems to have established itself between the "corte Romana" and the "curia Romana." The former phrase is declared by Lunadoro in his *Relazione della Corte di Roma*, first published in 1641, to mean the whole body of cardinals, bishops, and prelates of all ranks who hold office in the Papal court and government; whereas at that period and for some time previously the *curia Romana* had come to signify what we should call "the bar" practising in the Papal courts of justice. But it is curious that the old wider and less precise signification of the term is found surviving long afterwards in the writings of Lutherans and Jansenists, who found its larger signification convenient to them in attacking and satirizing the Roman Papal system. Thus in modern writings the phrase "curia Romana" will be found very ordinarily to mean different things, according to the sympathies and in some degree to the country of the writer using it. In the mouth of a Lutheran, a Calvinist, a Jansenist, or even perhaps of a Gallican, it will mean the whole ecclesiastical and administrative system of Rome. In the mouth of the friends of the Papacy, especially of the Italians, it will be found to signify the body of lawyers practising in the Roman courts. The latter is of course, at all events in recent times, the more correct use of the term; and it will probably be found that in the mouth of a learned writer, even among Protestants, this will be the

sense attached to it. Thus Bingham, in a curious passage illustrating the change in the signification of the word "curia," where he is treating of the meaning of the phrase "curiæ tradi" as an ecclesiastical punishment (*Orig. Eccl.*, lib. 17, ch. 2, sec. 3), shows that the more accurate significance of the word was an entirely legal one. The celebrated controversialist Bergier, on the other hand, in his *Theological Dictionary*, defines "corte Romana" as "a phrase used in our days by modern newfangled writers in contempt of the dogmatic constitutions and pontifical briefs of the holy Roman apostolic see. If I remember rightly this phrase was first used by Calvin and his followers." Now all the writers thus twitted by the French theologian would have used "curia" as synonymous with "corte." And modern anti-ecclesiastical Italian writers will be found using the word similarly. But the proper present ecclesiastical sense of the term is most accurately rendered in English by the "Roman bar"—the body of those privileged to practise in the different pontifical courts of justice.

It will be seen, in short, that the use of the term has been shifting and uncertain to a singular degree,—shifting both, as the meaning of other words shifts, by lapse of time, and also not only according to the nationality but according to the views and prejudices of the person using it.

It may be added that the building now occupied by the Italian Chamber of Deputies, was called the Curia Innocenziana, having been built by Innocent XII. for the reuniting of the various "curiæ" before existing in the city.

For a detailed account of the officials who were at different times comprised in the idea of the Curia, of the duties, orders, and hierarchial distinctions and privileges of these, of the story of the pious confraternity into which they formed themselves under the patronage of St. Ivo the Briton, etc., the curious inquirer must be referred to Lunadoro, *Corte di Roma*; *Compendio Istoria del pio istituto, congregazione, e venerab. arciconfraternita sotto l'invocazione dell'Immacolata Concezione, e di S. Ivo avvocato de' poveri oppressi*; Bernini, *Del tribunale della Rota*; Cancellieri, *Possesse de' Pontifici*; and Moroni, *Dict. de Erudit. Eccles.*

CURLEW, in French *Courlis* or *Corlieu*, a name given to two birds, of whose cry it is an imitation, both belonging to the group *Limicolæ*, but possessing very different habits and features.

1. The Long-billed Curlew, or simply Curlew of most British writers, the *Numenius arquata* of ornithologists, is one of the largest of the family *Scolopacidae*, or Snipes and allied forms. It is common on the shores of the United Kingdom and most parts of Europe, seeking the heaths and moors of the interior and more northern countries in the breeding-season, where it lays its four brownish-green eggs, suffused with cinnamon markings, in an artless nest on the ground. In England it has been ascertained to breed in Cornwall and in the counties of Devon, Dorset, Salop, and Derby—though sparingly. In Yorkshire it is more numerous, and thence to the extreme north of Scotland, as well as throughout Ireland, it is, under the name of Whaup, familiar to those who have occasion to traverse the wild and desolate tracts that best suit its habits. So soon as the young are able to shift for themselves, both they and their parents resort to the sea-shore or mouths of rivers, from the muddy flats of which they at low tide obtain their living, and, though almost beyond any other birds wary of approach, form an object of pursuit to numerous gunners. While leading this littoral life the food of the Curlew seems to consist of almost anything edible that presents itself. It industriously probes the mud or sand in quest of the worms that lurk therein, and is also active in seeking for such crustaceans and mollusks as can be picked up on the surface, while vegetable matter as well has been found in its stomach. During its summer sojourn on the moorlands insects and berries, when they are ripe, enter largely into its diet. In bulk the Curlew is not less than a Crow, but it looks larger still from its long legs, wings, and neck. Its bill, from 5 to 7 inches in length, and terminating in the delicate nervous apparatus common to all birds of its family, is especially its most remarkable feature. Its plumage above is of a drab color, streaked and mottled with very dark brown; beneath it is white, while the flight-quills are of a brownish black.

Nearly allied to the Curlew, but smaller and with a more northern range, is the Whimbrel (*N. phaeopus*), called in some parts Jack-Curlew, from its small size—May-fowl, from the month in which it usually arrives—and Titterel

from one of its cries.<sup>1</sup> This so much resembles the former in habit and appearance that no further details need be given of it. In the countries bordering on the Mediterranean occurs a third species (*N. tenuirostris*), the home of which has yet to be ascertained. Some fifteen other species, or more, have been described, but it is probable that this number is too great. The genus *Numenius* is almost cosmopolitan. In North America three very easily recognized species are found—the first (*N. longirostris*) closely agreeing with the European Curlew, but larger and with a longer bill; the second (*N. hudsonicus*) representing our Whimbrel; and the third (*N. borealis*), which has several times found its way to Britain, very much less in size—indeed the smallest of the genus. All these essentially agree with the species of the Old World in habit; but it is remarkable that the American birds can be easily distinguished by the rufous coloring of their axillary feathers—a feature which is also presented by the American Godwits (*Limosa*).

2. The Curlew of inlanders, or Stone-Curlew—called also, by some writers, from its stronghold in this country, the Norfolk Plover, and most wrongly and absurdly the Thick-Knee, or Thick-Kneed Bustard—is usually classed among the *Charadriidae*, but it offers several remarkable differences from the more normal Plovers. It is the *Charadrius edicnemus* of Linnæus, the *C. scolopax* of Sam. Gottl. Gmelin, and the *Edicnemus crepitans* of Temminck. With much the same cry as that of the *Numenius*, only uttered in a far sweeter tone, it is as fully entitled to the name of Curlew as the bird most commonly so called. In England it is almost solely a summer visitor, though an example will occasionally linger throughout a mild winter; and is one of the few birds whose distribution is affected by geological formation, since it is nearly limited to the chalk-country—the open spaces of which it haunts, and its numbers have of late years been sensibly diminished by their inclosure. The most barren spots in these districts, even where but a superficial coating of light sand and a thin growth of turf scarcely hide the chalk below, supply its needs, though at night (and it chiefly feeds by night) it resorts to moister and more fertile places. Its food consists of snails, coleopterous insects, and earth-worms, but larger prey, as a mouse or a frog, is not rejected. Without making the slightest attempt at a nest, it lays its two eggs on a level spot, a bare fallow being often chosen. These are not very large, and in color so closely resemble the sandy, flint-strewn surface that their detection, except by a practised eye, is difficult. The bird, too, trusts much to its own drab coloring to elude observation, and, on being disturbed, will frequently run for a considerable distance and then squat with outstretched neck so as to become almost invisible. In such a case it may be closely approached, and its large golden eye, if it do not pass for a tuft of yellow lichen, is perhaps the first thing that strikes the searcher. As autumn advances the Stone-Curlew gathers in large flocks, and then is as wary as its namesake. Towards October these take their departure, and their survivors return, often with wonderful constancy, to their beloved haunts (see BREDS, vol. iii. p. 664). In size this species exceeds any other European plover, and looks even still larger than it is. The bill is short, blunt, and stout; the head large, broad, and flat at the top; the wings and legs long—the latter presenting the peculiarity of a singular enlargement of the upper part of the tarsus, whence the name *Edicnemus* has been conferred. The toes are short and fleshy, and the hind-toe, as in most *Charadriidae*, is wanting. This Curlew seems to have been an especial favorite with Gilbert White, in whose classical writings mention of it is often made. Its range extends to North Africa and India. Five other species of *Edicnemus* from Africa have also been described as distinct: whether there are so many may be doubted. Australia, however, possesses a very distinct species (*E. gallinarius*), and the genus has two members in the Neotropical Region (*E. bistratus* and *E. superciliosus*). The analogy of all these birds to the Bustards (*Otididae*) is manifest, but that they have any really close affinity to that family is questionable. An exaggerated form of *Edicnemus* is found in *Assacus*, of which two species have been described, one (*A. recurvirostris*) from the Indian, and the other (*A. magnirostris*) from the northern parts of the Australian Region. (A. x.)

<sup>1</sup> The name Spowe (*cf.* Icelandic *Spóti*) also seems to have been anciently given to this bird (see Stevenson's *Birds of North*, vol. ii. p. 201).

**CURLING**, a game in which the players throw large rounded stones upon a rink or channel of ice, towards a mark called the tee. Where the game originated is not precisely known; but as it has been popular in North Britain for the last three centuries at least, and down till our own day been practised chiefly by natives of that country, it may correctly be spoken of as a Scottish pastime. Some writers, looking to the name and technical terms of the game, trace its invention to the Low Countries: thus, "curl" may have been derived from the German *kurs well*, a game; "tee" from the Teutonic *tighen*, to point out; "bonspiel," a district curling competition, from the Belgic *bonne*, a district, and *spel*, play; though the supposition that "rink" is just a modification of the Saxon *krink*, a strong man, seems scarcely tenable. Then, it is further stated that, as curling is called "kuting" in some parts of Lanarkshire and Ayrshire, and very much resembles quiting on the ice, the name may have some connection with the Dutch *coete*, a quoit; while Kilian in his *Teutonic Dictionary* represents the term *khuyten* to mean a pastime in which large globes of stone are thrown upon ice like the quoit or discus. Possibly enough some of the

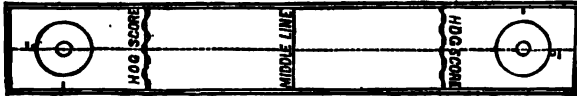

Diagram of Curling Rink.

Flemish merchants who settled in Scotland towards the close of the 16th century may have brought the game to the country. Unfortunately, however, for the theory that assigns to it a far-away origin, we find no early mention of it in the literature of the Continent; while Camden, when describing the Orkney Islands in 1607, tells us that one of them supplies "plenty of excellent stones for the game called curling;" and incidental references to it as a game played in Scotland are made by several authors during the first half of the same century. If the game be not indigenous to Scotland, it certainly owes its development to that country, and in the course of time it has come to be nearly as much the national sport of the Caledonians as "the rough bur thistle" their heraldic emblem.

With very rude engines it was played at first,—random whin boulders fashioned by the finger of nature alone, or misshapen granite blocks, bored through to let in the thumb of the player, having been the channel-stones used by the primitive curlers of the country. Even before Banockburn was fought the ice of the Scottish lochs may have been employed as the arena of a bloodless strife; though it is only as a piece of pardonable witticism that Ossian has been quoted as follows to show that curling was practised by his somewhat mythical heroes:—"Fly, son of Morven, fly; amid the circle of stones Swaran, bends at the stone of might." In course of years the rough block of the game was superseded by a symmetrical object usually made of whinstone or granite, beautifully rounded, brilliantly polished, and supplied with a convenient handle; so that the curling-stone now used is as great an improvement on its remote predecessor as the Martini rifle is on the old matchlock which figured at Marston Moor and Culloden. It is circular in form, its weight from 35 to 50 lb, its circumference from 30 to 36 inches, and the height is about one-eighth of the girth. With engines of such shape and bulk, costing, with handles, from £2 to £2 10s. per pair, all the societies, 472 in number, connected with the Royal Caledonian Curling Club play their spels when "cauld, cauld frosty weather" supplies the required arena. Most of these societies are located in the Land of Cakes and Curlers, but many of them are Transatlantic, no fewer than 37 belonging to the Ontario province branch alone; while there are many hundreds of independent curling fraternities north of the Tweed, who play for their own hand, under arrangements of their own, though the rules and usages of the Caledonian Curling Club form a code which largely regulates "the roaring game," as Burns calls it, all over the world.

On a rink 42 yards long, or so, with a tee at each end, the stone is hurled, the hurler, or curler, when delivering it standing on one side of the goal or tee, so as to bring the stone over the tee when delivering it; or, according to another arrangement, he occupies a small circle a

foot in diameter behind a ring of 7 feet radius drawn round the tee. To cover this goal or lie close to it is the player's chief object; but often when he has realized his aim, a rival stone "up the rink like Jehu roars," driving his stone nowhere, settling down in its pride of place, but only to be served perhaps in a similar way itself before the match is at an end. No stones that lie outside the large circles of 7 feet radius round the tee are allowed to count, and all laggard stones that manifest a pig-like indolence, and do not pass the well-named hog score, which is drawn at a distance of one-sixth the rink from each tee, are removed as obstructive cumberers of the channel. Games can be played by two persons, but usually matches are arranged for with numerous competitors formed into rinks of four players a side, two stones being used by each player. It is customary for the parish clubs of a district, marshalled by their respective skips, or captains, to try their skill against each other once a year or so; while annually (when weather permits) a great contest, which is at least semi-national, is waged between the curlers north and south of the River Forth.

At first the game is remarkably simple, the leader, as we have said, endeavoring to top or closely neighbor the tee, and his immediate opponent having a similar object in view. When, during the progress of the game, one, two, or more stones have been well planted, the supporters of those who placed them there are usually directed by their skip rather to guard the winning stones than venture too near them at the risk of injuring their position. On the other hand the tactics of the opposing party will consist in efforts to knock off the guards, dislodge the well-planted stones, or get their own still better placed where that is possible. It sometimes happens that the stone nearest the tee—the winner, as it is called—is so well protected that it cannot be touched directly, and defies removal unless it be assailed by an ingenious master-stroke technically termed *wicking* or *inringing*, whereby a stone is sent in an oblique direction so as haply to hit the winner; and, if it not only does that, but becomes the winner in its stead, the man who throws it is sure to be hailed by his exulting comrades as a prince among curlers, if not "the king o' a' the core." "Wicking, or inringing," says the late Sir Richard Broun, Bart., in his admirable work *Memorabilia Curtiana* (published in 1830), "the prettiest and most scientific point in the game by far, is to take the shot and leave yourself behind the rampart of your adversary's barricade, when to all appearance their winner was impregnable;" and this is done "by taking an inner angle off a side shot in such a manner as to change and direct the course of your stone upon the one to be projected." When, however, science fails, and the ice is so blocked up as almost to hide the tee, an effort of strength and hazard is resorted to in the hope of some benefit "turning up." This, by the curlers of the south of Scotland, is called "rebutting." The player in such cases is usually told by his skip to "put plenty of powder in the horn," and the stone is delivered with tremendous force, so as to go crashing through guards and double guards, sometimes doing more harm than good, and sometimes also changing in a moment the whole fortunes of the game.

Many fine songs have been written about curling, from which lines might be quoted descriptive of all its leading points, its implements, "channel stones, crampets (flat pieces of iron with spikes below fastened on the sole of the shoe to keep the player from slipping), and besoms so green," with which the rink is swept; also in praise of the game as a promoter of mental enjoyment, bodily health, and the best of good-fellowship. The late Dr. Henry Duncan's song on the subject has never been excelled; and he succeeds in packing into a single stanza some of its chief characteristics:—

"There draw a shot; there lay a guard;  
And here beside him lie, man;  
Now let him feel a gamester's hand;  
Now in this bosom die, man.  
There fill the port, and block the ice;  
We sit upon the tee, man!  
Now take this in-ring sharp and neat,  
And make this winner flee, man."

The Ettrick Shepherd also ranks among the laureates of the rink.

The following rules of the game are abridged from the *Annual of the Royal Caledonian Curling Club*:—

1. The tees shall be set down 40 yards apart; and in an exact alignment with the tees a line shall be drawn on the rink. Seven feet behind each tee a circle 6 inches in diameter shall be also drawn on the ice on the left-hand side of said line (looking to the tee to be played to), the inner side of which shall be distant from said line 6 inches. Upon this circle, and as near as may upon the centre of it, every player, whether standing on the ice or on a board or other rest, shall, in the delivery of his stone, place, or in stepping out, put down his left or fore foot, if he be a right hand player. For a left-hand player, another such circle shall be placed in like manner, and for the like purpose on the right-hand side of said line. And in the event of a hawk, hatch, trigger, etc., being used, it shall be right behind said circle, and not less distant therefrom than 2 feet, nor greater in length than 12 inches.

A circle of 7 feet radius to be described from each tee as a centre, and every stone to count which is either within, or resting on, this circle. All played stones passing the tee, and going beyond the 7 feet radius, shall be put off the ice. The hog-score to be distant from each tee one-sixth part of the length of the whole rink played on. Every stone to be a hog which does not clear this score; but no stone to be such which has struck another stone lying over the hog-score. A line shall be drawn on the ice, at a right angle to the rink, half-way betwixt the tees, called "the middle line." In no case shall the rink be less than 32 yards.

2. All matches to be of a certain number of heads, to be agreed on by the clubs, or fixed by the umpire, before commencement; or otherwise, by time, or shots, if mutually agreed on.

3. Every rink to be composed of four players a side, each using two stones. The rotation of play observed during the first head of a match shall not be changed.

4. The skips opposing each other shall settle by lot, or in any other way they may agree upon, which party shall lead at the first head, after which the winning party shall do so.

5. All curling stones shall be of a circular shape. No stone shall be of a greater weight than 50 lb imperial, or of greater circumference than 36 inches, or of less height than one-eighth part of its greatest circumference.

6. No stone, or side of a stone, shall be changed after a match has been begun, or during its continuance, unless by consent.

7. Should a stone happen to be broken, the largest fragment shall be considered in the game for that end—the player being entitled afterwards to use another stone, or another pair.

8. If a played stone rolls over, or stops, on its side or top, it shall be put off the ice. Should the handle quit the stone in delivery, the player must keep hold of it, otherwise he shall not be entitled to replay the shot.

9. Players, during the course of each end, to be arranged along the sides of the rink, anywhere skips may direct; and no party, except when sweeping according to rule, shall go upon the middle of the rink or cross it, under any pretence whatever. Skips alone to stand at or about the tee—that of the playing party having the choice of place, and not to be obstructed by the other.

10. If a player should play out of turn, the stone so played may be stopped in its progress, and returned to the player. Should the mistake not be discovered till the stone be at rest, or has struck another stone, the opposite skip shall have the option of adding one to his score, allowing the game to proceed, or declaring the end null and void. But if a stone be played before the mistake has been discovered, the head must be finished as if it had been properly played from the beginning.

11. The sweeping shall be under the direction and control of the skips. The player's party may sweep the ice anywhere from the centre line to the tee, and behind it,—the adverse party having liberty to sweep behind the tee, and in front of any of their own stones when moved by another, and till at rest. Skips to have full liberty to clean and sweep the ice behind the tee at any time, except when a player is being directed by his skip.

12. If in sweeping or otherwise, a running stone be marred by any of the party to which it belongs, it may, at the option of the opposite skip, be put off the ice; if by any of the adverse party, it may be placed where the skip of the party to which it belongs shall direct. If otherwise marred, it shall be replayed.

13. Every player to be ready to play when his turn comes, and not to take more than a reasonable time to play. Should he play a wrong stone, any of the players may stop it while running; but if not stopped till at rest, the one which ought to have been played shall be placed instead, to the satisfaction of the opposing skip.

14. No measuring of shots allowable previous to the termination of the end. Disputed shots to be determined by the skips, or, if they disagree, by the umpire, or, when there is no umpire, by some neutral person chosen by the skips. All measurements to be taken from the centre of the tee, to that part of the stone which is nearest it. No stone shall be considered without a circle, or over a line, unless it clear it;—and in every case, this is to be determined by placing a square on the ice, at the circle or line.

15. Skips shall have the exclusive regulation and direction of the game for their respective parties, and may play last stone, or in what part of it they please; and, when their turn to play comes, they may name one of their party to take charge for them.

16. If any player shall speak to, taunt, or interrupt another, not being of his own party, while in the act of delivering his stone, one shot shall be added to the score of the party so interrupted.

17. If from any change of weather after a match has been begun, or from any other reasonable cause, one party shall desire to shorten the rink, or to change to another one, and, if the two skips cannot agree, the umpire shall, after seeing one end played, determine whether the rink shall be shortened, and how much or whether it shall be changed, and his decision shall be final. (w. r. n.)

CURRAGH, a level stretch of open ground in the county of Kildare, in Ireland, famous for its race-course and its military camp. It has an area of upwards of 4800 acres; and its soft natural sward, which has never been broken by the plough, affords excellent pasture for sheep. From the peculiarity of its herbage, the district is known in the neighborhood as "the short grass," and the young men of Kildare are jocularly distinguished as the "boys of the short grass." The land is the property of the Crown, which appoints a special officer as the ranger of the Curragh; but the right of pasturage is possessed by the landowners of the vicinity. The oldest mention of the Curragh occurs in the *Liber Hymnorum* (the manuscript of which probably dates from the 10th century) in connection with St. Bridget, who is said to have received a grant of the district from the king of Leinster, and is popularly credited with the honor of having turned it into a common. It is evident, however, that long before the days of the saint the downs of Kildare had afforded a regular place of assembly for the people of the south of Ireland, and the turf had already become familiar with the hoofs of the race-horse. The *Aenach Colmain*, or Curragh fair, is frequently mentioned in the Irish annals from the Book of Leccan downwards; and the plain appears from time to time as the scene of hostile encounters between the kings of Meath, Leinster, and Offaly. In 1234 the earl of Pembroke was defeated there by the viceroy of Ireland, Lord Geoffrey de Monte Marisco; and in 1406 the Irish under the prior of Connell were routed by the English. In 1789 the Curragh was the great rendezvous for the volunteers; and in 1804 it saw the gathering of 30,000 United Irishmen. The camp was established at the time of the Crimean war, and is capable of accommodating 10,000 men; 6769 was the number of persons registered at the census of 1871. The races, for which Sir William Temple obtained a grant of £100 a year from Government, are held in April, June, September, and October. The early history of the Curragh has been investigated by Mr. W. M. Hennessy, *Proceedings of the Royal Irish Academy*, 1866.

CURRAN, JOHN PHILPOT (1750-1817), Master of the Rolls in Ireland, and one of the most brilliant wits and orators of his day, was born on the 24th July, 1750, at Newmarket, Cork, where his father, a descendant of one of Cromwell's soldiers, was seneschal to the manor-court. Pleased with his bright boyish vivacity and wit, the rector of his native place, the Rev. Nathaniel Boyse, first gave him lessons and then sent him to school at Middleton. At the age of nineteen he became a sizar of Trinity College, Dublin; and in 1773, having taken his M. A. degree, he entered the Middle Temple. During his residence in London he gave some little attention to the study of law, but gained far more by his assiduous attendance at the students' debating societies. In 1774 he married a lady who brought him a small dowry; but the marriage proved most unhappy, not without fault on the part of Curran, and Mrs. Curran finally eloped from her husband.

In 1775 Curran was called to the Irish bar, where he very soon obtained a practice. On his first rising in court, excessive nervousness prevented him from even reading distinctly the few words of a legal form, and when requested by the judge to read more clearly he became so agitated as to be totally unable to proceed. But, his feelings once roused, all nervousness disappeared. His effective and witty attack upon a judge who had sneered at his poverty, the success with which he prosecuted a nobleman for a disgraceful assault upon a priest, the duel which he fought with one of the witnesses for this nobleman, and other similar exploits, gained him such a reputation that he was soon the most popular advocate in Ireland.

In 1783 Curran was appointed king's counsel; and in the same year he was presented to a seat in the Irish House of Commons. His conduct in connection with this affair displays his conduct in a most honorable light; finding that he differed radically in politics from the gentleman from whom he had received his seat, he offered to buy another to replace that which he occupied. In his parliamentary career Curran was throughout sincere and consistent. He spoke vigorously in behalf of Catholic emancipation, and strenuously attacked the ministerial bribery which prevailed. His declamations against the Government party led him into two duels—the first with Fitzgibbon, then attorney-general, afterwards Lord Clare; the second with the secretary of state, Major Hobart, afterwards Lord Buckingham. The Union caused him the bitterest disappointment; he even talked of leaving Ireland, either for America or for England.

Curran's fame rests most of all upon his speeches in behalf of the accused in the state trials that were so numerous between 1794 and 1803; and among them may be mentioned those in defence of Hamilton Rowan, the Rev. William Jackson, the brothers Shearn, Finnerty, Lord Edward Fitzgerald, Tone, and Kirwan. Another of his most famous and characteristic speeches is that against the marquis of Headfort, who had eloped with the wife of a clergyman named Massey. On the arrest of Emmet, who had formed an attachment to his daughter, Curran was himself under suspicion; but, on examination before the Privy Council, nothing was brought forward to implicate him in the intended rebellion.

In 1806, on the death of Pitt and the formation of the Fox ministry, Curran received the post of Master of the Rolls, with a seat in the Privy Council, much to his disappointment, for he had desired a position of greater political influence. For eight years, however, he performed the distasteful duties of this office. He then retired on a pension of £3000; and the three remaining years of his life were spent in London, where he became one of the most brilliant members of the brilliant society which included Sheridan, Erskine, Thomas Moore, and William Godwin. He died at his house in Brompton on the 14th October, 1817.

Curran's legal erudition was never profound; and though he was capable of the most ingenious pleading, his appeal was always to the emotions of his audience. His best speeches are one fiery torrent of invective, pathos, national feeling, and wit. His diction was lofty and sonorous. To his personal presence he owed nothing; for he was short, slim, and boyish-looking, and his voice was thin and shrill.

See *Curran and his Contemporaries*, a most entertaining work, by Charles Phillips, a personal friend of Curran's (1818), and the *Life of Curran* by his son, W. H. Curran (1819, and with additions by Dr. Shelton Mackenzie, New York, 1855), both of which contain numerous samples of Curran's eloquence. See also *Curran's Speeches* (1805, 1808, 1845), *Memoirs of Curran*, by Wm. O'Regan (1817), *Letters to Rev. H. Weston* (1819).

**CURRENTS**, the dried seedless fruit of a variety of the grape-vine, *Vitis vinifera*, cultivated principally in Zante, Cephalonia, and Ithaca, and near Patras, in the Morea. Currants were brought originally from Corinth, whence their name; in the 13th and 14th centuries they were known as *raisins de Coraunts*. In the Ionian Islands the currant-vine is grown on the sides of the lower hills, or in the valleys, the grape-vine occupying the higher and less open and rich ground. Gypseous marls, or calcareous marls containing a little gypsum, are preferred to limestone soils, as they allow of the deep penetration of the roots of the vines. The most favorable situations are those where a good supply of water can be obtained for the irrigation of the plantations. This is carried on from the end of October to the close of the year, after which all that is necessary is to keep the ground moist. The vines are planted in rows three or four feet apart. Propagation is effected by grafting on stocks of the grape-vine, or by planting out in spring the young vigorous shoots obtained at the end of the previous year from old currant-vines that have been cut away below the ground. The grafts bear fruit in three years, the slips in about double that time. The vine-stock for grafting is cut down to the depth of a foot below the surface of the soil; two or three perpendicular incisions are made near the bark with a chisel; and into these are inserted shoots of the last year's growth. The grafted part then receives an application of moist

marl, is wrapped in leaves and bound with rushes, and is covered with earth, two or three eyes of the shoots being left projecting above ground. In December the currant plantations are cleared of dead and weak wood. In February the branches are cut back, and pruned of median shoots, which are said to prevent the lateral ones proceeding from the same bud from bearing fruit. In order effectually to water the trees, the earth round about them is in February and March hoed up so as to leave them in a kind of basin, or is piled up against their stems. In May, when the leaves begin to show, the ground is thoroughly turned, and if requisite manured, and is then re-levelled. By the middle of April the leaves are fully out, and in June it is necessary to break back the newly-formed shoots. The fruit begins to ripen in July, and in the next month the vintage takes place. At this season rain is greatly dreaded, as it always damages and may even destroy the ripe fruit. The plantations, which are commonly much exposed, are watched by dogs and armed men. In Cephalonia the currant-grape is said to ripen at least a week earlier than in Zante. To destroy the oidium, a pest that severely injures the plantations, the vines are dusted, at the time the fruit is maturing, with finely-ground brimstone. The currants when sufficiently ripe are gathered and placed on a drying ground, where they are exposed to the sun in layers half an inch thick; from time to time they are turned and swept into heaps, until they become entirely detached from stalk. They are then packed in large butts for exportation. The wine made from the currant-grape is inferior in quality, but is said to be capable of much improvement. The fresh fruit is luscious and highly flavored, but soon cloy the palate. In 1834 the duty on currants was made 2s. 2d. per cwt., or one-half what it had previously been; in 1844 it was reduced to 15s., and in 1860 to 7s. per cwt. In 1874 the imports of currants into the United Kingdom were:—

	Cwts.	Value.
From Austrian territories.....	6978	£ 8,606
“ Greece.....	963,358	1,278,974
“ other countries.....	2,119	2,994
Total .....	972,455	£1,290,574

The currants of British kitchen-gardens are the produce of *Ribes nigrum* and *R. rubrum*, deciduous shrubs of the natural order *Grossulariaceae*, indigenous to Britain, Northern and Central Europe, Siberia, and Canada. The former species bears the black, the latter the red currant. White currants are the fruit of *R. album*, a cultivated variety of *R. rubrum*. Both red and black currants are used for making tarts and pies, jams, jellies, and wine; the latter are also employed medicinally in lozenges, and in the preparation of a gargle for sore throat, are occasionally preserved in spirits, and in Russia are fermented with honey to produce a strong liquor. The leaves as well as the roots of the black currant have been recommended for their therapeutic virtues. A kind of black currant, bearing poor and acid fruit, is indigenous to Tierra del Fuego. Royle mentions three Himalayan species of currants; their fruit he found to contain less saccharine matter than that of their cultivated European congeners.

**CURRENCY.** See **MONEY.**

**CURRIE, JAMES** (1766–1805), a Scotch physician and an editor of Burns, was the son of the minister of Kirkpatrick Fleming, in Dumfriesshire, where he was born. He was destined for business, and while still very young was sent out to Virginia. The outbreak of the first American war, however, changed his prospects considerably; he had a long and dangerous illness; and he still further damaged his chance of success by contributing a series of letters to an American journal, under the signature of “An Old Man,” in defence of the mother country. At last he found it necessary to leave America, and reaching home at the age of twenty, he applied himself with energy to the study of medicine. In 1780, with the object of procuring military service in Jamaica, he took his degree at Glasgow; but not obtaining the post he had in view, he settled at Liverpool, where in 1783 he was elected physician to the infirmary. The fatigues of his professional work, acting upon a hereditary tendency to pulmonary disease, forced him in 1804 to give up practice, and retire to the south of England, where he died in the following year. Among Currie's works may be mentioned a Tory pamphlet signed “Jasper Wilson” and entitled *A Letter, Commercial and Political, addressed to the Right Honorable William Pitt*, which ran quickly through several editions; and *Medical*

*Reports on the Effects of Water, Cold and Warm, as a Remedy in Fevers and other Diseases.* But he is best known for the edition of Burns, with an introductory criticism and an essay on the character and condition of the Scottish peasantry, which he undertook in behalf of the family of the poet, whose personal acquaintance he had enjoyed.

CURRY, a name applied to a great variety of seasoned dishes. In India the following are employed as ingredients in curries:—anise, coriander, cumin, mustard, and poppy seeds; allspice, almonds, assafetida, butter or ghee, cardamoms, chillies, cinnamon, cloves, cocoa-nut and cocoa-nut milk and oil, cream and curds, fenugreek, the tender unripe fruit of *Buchanania lanceifolia*, cheroonjie nuts (the produce of another species, *B. latifolia*), garlic and onions, ginger, lime-juice, vinegar, the leaves of *Bergera Kenesii* (the curry-leaf tree), mace, mangoes, nutmeg, pepper, saffron, salt, tamarinds, and turmeric. The annexed table shows the composition of four kinds of Indian curry powder:—

	Lbs.			Oz.
Black pepper.....	2	1	1	8
Cardamoms.....	2	...	...	4
Chillies.....	1	2	1	6
Cinnamon.....	2	...	...	4
Coriander seeds.....	20	12	3	8
Cumin seeds.....	1	2	$\frac{1}{2}$	...
Fenugreek.....	1	1	$\frac{1}{2}$	2
Garlic.....	2	1	...	6
Ginger.....	2	2	$\frac{1}{2}$	8
Mustard seed.....	1	1	$\frac{1}{2}$	...
Turmeric.....	4	2	1	9
Poppy seed.....	2	2	...	6

The cumin and coriander seeds are generally used roasted. The various materials are cleaned, dried, ground, sifted, thoroughly mixed, and bottled. Upwards of forty different methods of preparing curry are given in the *Indian Domestic Economy and Receipt Book*, 2d ed. Madras, 1850.

CURRYING. See LEATHER.

CURTIUS, METTUS or METIUS, the hero of two legends connected with the part of the Roman forum called the Lacus Curtius, which appears to have once been a marsh, and where sacrifices were regularly offered. The first legend makes him the leader of the Sabine army in a battle with the Romans under Tullus Hostilius. To escape from the attack of the Romans he was forced to ride into a swamp, which occupied the spot, hence called the Lacus Curtius. The second legend, which is dated 362 B. C., tells how a gulf suddenly appeared in the forum, according to one account riven by a thunder-bolt, and the aruspices declared that it would never close till what was dearest to Rome was thrown therein. At this announcement a noble youth, Mettus Curtius, came forward, declaring that her citizens were the most valuable possessions of the city; and, armed and on horseback, he leapt into the chasm, which forthwith closed over his head.

CURTIUS, QUINTUS RUFUS, the celebrated biographer of Alexander the Great. Of his personal history nothing whatever is known with certainty, some fixing his epoch in the Augustan, others as far down as the mediæval age, but most critics in the time of Vespasian. Niebuhr held him to be a contemporary of Septimius Severus. His work originally consisted of ten books, but the first two of these are entirely lost, and the remaining eight are incomplete. The best modern editions of the text are those of Zumpt, Baumstark, and Müttzell.

See Niebuhr, *Kleine Schriften*, vol. i.; Buttman, *Ueber das Leben des Geschichtschreibers Q. Curtius Rufus*; Pinzger, "Ueber das Zeitalter des Q. Curtius Rufus," in *Seebode's Archiv. für Philologie*.

CURVE. This subject is treated here from an historical point of view, for the purpose of showing how the different leading ideas in the theory were successively arrived at and developed.

A curve is a line, or continuous singly infinite system of points. We consider in the first instance, and chiefly, a plane curve described according to a law. Such a curve may be regarded geometrically as actually described or kinematically as in course of description by the motion of a point; in the former point of view, it is the locus of all

the points which satisfy a given condition; in the latter, it is the locus of a point moving subject to a given condition. Thus the most simple and earliest known curve, the circle, is the locus of all the points at a given distance from a fixed centre, or else the locus of a point moving so as to be always at a given distance from a fixed centre. (The straight line and the point are not for the moment regarded as curves.)

Next to the circle we have the conic sections, the invention of them attributed to Plato (who lived 430 to 347 B. C.); the original definition of them as the sections of a cone was by the Greek geometers who studied them soon replaced by a proper definition *in plano* like that for the circle, viz., a conic section (or as we now say a "conic") is the locus of a point such that its distance from a given point, the focus, is in a given ratio to its (perpendicular) distance from a given line, the directrix; or it is the locus of a point which moves so as always to satisfy the foregoing condition. Similarly any other property might be used as a definition; an ellipse is the locus of a point such that the sum of its distance from two fixed points (the foci) is constant, etc., etc.

The Greek geometers invented other curves; in particular, the "conchoid," which is the locus of a point such that its distance from a given line, measured along the line drawn through it to a fixed point, is constant; and the "cissoid," which is the locus of a point such that its distance from a fixed point is always equal to the intercept (on the line through the fixed point) between a circle passing through the fixed point and the tangent to the circle at the point opposite to the fixed point. Obviously the number of such geometrical or kinematical definitions is infinite. In a machine of any kind, each point describes a curve; a simple but important instance is the "three-bar curve," or locus of a point in or rigidly connected with a bar pivoted on to two other bars which rotate about fixed centres respectively. Every curve thus arbitrarily defined has its own properties; and there was not any principle of classification.

The principle of classification first presented itself in the *Géométrie* of Descartes (1637). The idea was to represent any curve whatever by means of a relation between the

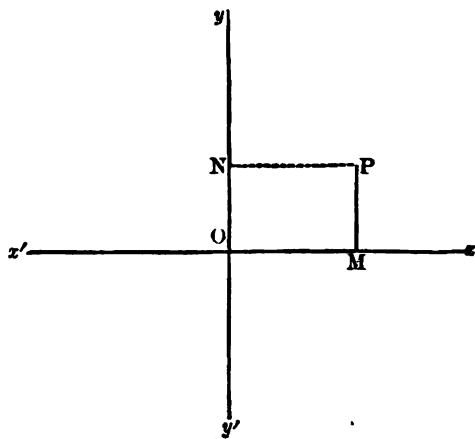

co-ordinates ( $x, y$ ) of a point of the curve, or say to represent the curve by means of its equation.

Descartes takes two lines  $xx', yy'$ , called axes of co-ordinates, intersecting at a point O called the origin (the axes are usually at right angles to each other, and for the present they are considered as being so); and he determines the position of a point P by means of its distances OM (or NP) =  $x$ , and MP (or ON) =  $y$ , from these two axes respectively; where  $x$  is regarded as positive or negative according as it is in the sense Ox or Ox' from O; and similarly  $y$  as positive or negative according as it is in the sense Oy or Oy' from O; or what is the same thing—

In quadrant $xy'$ , or N.E., we have	$x$	$y$
" " $xy$ " N.W., "	-	+
" " $xy'$ " S.E., "	+	-
" " $xy$ " S.W., "	-	-

Any relation whatever between ( $x, y$ ) determines a curve,

and conversely every curve whatever is determined by a relation between  $(x, y)$ .

Observe that the distinctive feature is in the *exclusive* use of such determination of a curve by means of its equation. The Greek geometers were perfectly familiar with the property of an ellipse which in the Cartesian notation is  $\frac{x^2}{a^2} + \frac{y^2}{b^2} = 1$ , the equation of the curve; but it was as one of a number of properties, and in no wise selected out of the others for the characteristic property of the curve.<sup>1</sup>

We obtain from the equation the notion of an algebraical or geometrical as opposed to a transcendental curve, viz., an algebraical or geometrical curve is a curve having an equation  $F(x, y) = 0$ , where  $F(x, y)$  is a rational and integral function of the co-ordinates  $(x, y)$ ; and in what follows we attend throughout (unless the contrary is stated) only to such curves. The equation is sometimes given, and may conveniently be used, in an irrational form, but we always imagine it reduced to the foregoing rational and integral form, and regard this as the equation of the curve. And we have hence the notion of a curve of a *given order*, viz., the order of the curve is equal to that of the term or terms of highest order in the co-ordinates  $(x, y)$  conjointly in the equation of the curve; for instance,  $xy - 1 = 0$  is a curve of the second order.

It is to be noticed here that the axes of co-ordinates may be any two lines at right angles to each other whatever; and that the equation of a curve will be different according to the selection of the axes of co-ordinates; but the order is independent of the axes, and has a determinate value for any given curve.

We hence divide curves according to their order, viz., a curve is of the first order, second order, third order, etc., according as it is represented by an equation of the first order,  $ax + by + c = 0$ , or say  $(\text{*)}x, y, 1 = 0$ ; or by an equation of the second order,  $ax^2 + 2hxy + by^2 + 2fy + 2gx + c = 0$ , say  $(\text{**) } x, y, 1)^2 = 0$ ; or by an equation of the third order, etc.; or what is the same thing, according as the equation is linear, quadric, cubic, etc.

A curve of the first order is a right line; and conversely every right line is a curve of the first order.

A curve of the second order is a conic, or as it is also called a quadric; and conversely every conic, or quadric, is a curve of the second order.

A curve of the third order is called a cubic; one of the fourth order a quartic; and so on.

A curve of the order  $m$  has for its equation  $(\text{***) } x, y, 1 = 0$ ; and when the coefficients of the function are arbitrary, the curve is said to be the general curve of the order  $m$ . The number of the coefficients is  $\frac{1}{2}(m+1)(m+2)$ ; but there is no loss of generality if the equation be divided by one coefficient so as to reduce the coefficient of the corresponding term to unity, hence the number of coefficients may be reckoned as  $\frac{1}{2}(m+1)(m+2) - 1$ , that is,  $\frac{1}{2}m(m+3)$ ; and a curve of the order  $m$  may be made to satisfy this number of conditions; for example, to pass through  $\frac{1}{2}m(m+3)$  points.

It is to be remarked that an equation may *break up*; thus a quadric equation may be  $(ax + by + c)(a'x + b'y + c') = 0$ , breaking up into the two equations  $ax + by + c = 0$ ,  $a'x + b'y + c' = 0$ , viz., the original equation is satisfied if either of these is satisfied. Each of these last equations represents a curve of the first order, or right line; and the

original equation represents this pair of lines, viz., the pair of lines is considered as a quadric curve. But it is an *improper* quadric curve; and in speaking of curves of the second or any other given order, we frequently imply that the curve is a proper curve represented by an equation which does not break up.

The intersections of two curves are obtained by combining their equations; viz., the elimination from the two equations of  $y$  (or  $x$ ) gives for  $x$  (or  $y$ ) an equation of a certain order, say the resultant equation; and then to each value of  $x$  (or  $y$ ) satisfying this equation there corresponds in general a single value of  $y$  (or  $x$ ), and consequently a single point of intersection; the number of intersections is thus equal to the order of the resultant equation in  $x$  (or  $y$ ).

Supposing that the two curves are of the orders  $m, n$ , respectively, then the order of the resultant equation is in general and at most  $= mn$ ; in particular, if the curve of the order  $n$  is an arbitrary line ( $n=1$ ), then the order of the resultant equation is  $= m$ ; and the curve of the order  $m$  meets therefore the line in  $m$  points. But the resultant equation may have all or any of its roots imaginary, and it is thus not always that there are  $m$  real intersections.

The notion of imaginary intersections, thus presenting itself, through algebra, in geometry, must be accepted in geometry—and it in fact plays an all-important part in modern geometry. As in algebra we say that an equation of the  $m$ -th order has  $m$  roots, viz., we state this generally without in the first instance, or it may be without ever, distinguishing whether these are real or imaginary; so in geometry we say that a curve of the  $m$ -th order is met by an arbitrary line in  $m$  points, or rather we thus, through algebra, obtain the proper geometrical definition of a curve of the  $m$ -th order, as a curve which is met by an arbitrary line in  $m$  points (that is, of course, in  $m$ , and not more than  $m$ , points).

The theorem of the  $m$  intersections has been stated in regard to an *arbitrary* line; in fact, for particular lines the resultant equation may be or appear to be of an order less than  $m$ ; for instance, taking  $m=2$ , if the hyperbola  $xy - 1 = 0$  be cut by the line  $y = \beta$ , the resultant equation in  $x$  is  $\beta x - 1 = 0$ , and there is apparently only the intersection

$(x = \frac{1}{\beta}, y = \beta)$ ; but the theorem is, in fact, true for every line whatever: a curve of the order  $m$  meets every line whatever in precisely  $m$  points. We have, in the case just referred to, to take account of a point at infinity on the line  $y = \beta$ ; the two intersections are the point  $(x = \frac{1}{\beta}, y = \beta)$ , and the point at infinity on the line  $y = \beta$ .

It is, moreover, to be noticed that the points at infinity may be all or any of them imaginary, and that the points of intersection, whether finite or at infinity, real or imaginary, may coincide two or more of them together, and have to be counted accordingly; to support the theorem in its universality, it is necessary to take account of these various circumstances.

The foregoing notion of a point at infinity is a very important one in modern geometry; and we have also to consider the paradoxical statement that in plane geometry, or say as regards the plane, infinity is a right line. This admits of an easy illustration in solid geometry. If with a given centre of projection, by drawing from it lines to every point of a given line, we project the given line on a given plane, the projection is a line—i.e., this projection is the intersection of the given plane with the plane through the centre and the given line. Say the projection is *always* a line, then if the figure is such that the two planes are parallel, the projection is the intersection of the given plane by a parallel plane, or it is the system of points at infinity on the given plane—that is, these points at infinity are regarded as situate on a given line, the line infinity of the given plane.<sup>2</sup>

Reverting to the purely plane theory, infinity is a line, related like any other right line to the curve, and thus intersecting it in  $m$  points, real or imaginary, distinct or coincident.

Descartes in the *Geométrie* defined and considered the remarkable curves called after him ovals of Descartes, or simply Cartesians, which will be again referred to. The

<sup>1</sup> There is no exercise more profitable for a student than that of tracing a curve from its equation, or say rather that of so tracing a considerable number of curves. And he should make the equations for himself. The equation should be in the first instance a purely numerical one, where  $y$  is given or can be found as an explicit function of  $x$ ; here, by giving different numerical values to  $x$ , the corresponding values of  $y$  may be found; and a *sufficient* number of points being thus determined, the curve is traced by drawing a continuous line through these points. The next step should be to consider an equation involving literal coefficients; thus, after such curves as  $y = x^2, y = x(x-1)(x-2), y = (x-1)\sqrt{x-2}$ , etc., he should proceed to trace such curves as  $xy = (x-a)(x-b)(x-c), y = (x-a)\sqrt{x-b}$ , etc., and endeavor to ascertain for what different relations of equality or inequality between the coefficients the curve will assume essentially or notably distinct forms. The purely numerical equations will present instances of nodes, cusps, inflexions, double tangents, asymptotes, etc.—specialties which he should be familiar with before he has to consider their general theory. And he may then consider an equation such that neither co-ordinate can be expressed as an explicit function of the other of them (practically, an equation such as  $x^2 + y^2 - 2xy = 0$ , which requires the solution of a cubic equation, belongs to this class); the problem of tracing the curve here frequently requires special methods, and it may easily be such as to require and serve as an exercise for the powers of an advanced algebraist.

<sup>2</sup> More generally, in solid geometry infinity is a plane, its intersection with any given plane being the right line which is the infinity of this given plane.

next important work, founded on the *Géométrie*, was Sir Isaac Newton's *Enumeratio linearum tertii ordinis* (1706), establishing a classification of cubic curves founded chiefly on the nature of their infinite branches, which was in some details completed by Stirling, Murdoch, and Cramer; the work contains also the remarkable theorem (to be again referred to), that there are five kinds of cubic curves giving by their projections every cubic curve whatever.

Various properties of curves in general, and of cubic curves, are established in Maclaurin's memoir, "De linearum geometricarum proprietatibus generalibus Tractatus" (posthumous, say 1746, published in the 6th edition of his *Algebra*). We have in it a particular kind of *correspondence* of two points on a cubic curve, viz., two points correspond to each other when the tangents at the two points again meet the cubic in the same point.

The *Géométrie Descriptive* by Monge was written in the year 1794 or 1795 (7th edition, Paris, 1847), and in it we have stated, *in plano* with regard to the circle, and in three dimensions with regard to a surface of the second order, the fundamental theorem of reciprocal polars, viz., "Given a surface of the second order and a circumscribed conic surface which touches it . . . then if the conic surface moves so that its summit is always in the same plane, the plane of the curve of contact passes always through the same point." The theorem is here referred to partly on account of its bearing on the theory of imaginaries in geometry. It is in Brianchon's memoir, "Sur les surfaces du second degré" (*Jour. Polyt.*, t. vi. 1806), shown how for any given position of the summit the plane of contact is determined, or reciprocally; say the plane XY is determined when the point P is given, or reciprocally; and it is noticed that when P is situate in the interior of the surface the plane XY does not cut the surface—that is, we have a real plane XY intersecting the surface in the imaginary curve of contact of the imaginary circumscribed cone having for its summit a given real point P inside the surface.

Stating the theorem in regard to a conic, we have a real point P (called the pole) and a real line XY (called the polar), the line joining the two (real or imaginary) points of contact of the (real or imaginary) tangents drawn from the point to the conic; and the theorem is that when the point describes a line the line passes through a point, this line and point being polar and pole to each other. The term "pole" was first used by Servois, and "polar" by Gergonne (*Gerg.*, t. i. and iii., 1810-13); and from the theorem we have the method of reciprocal polars for the transformation of geometrical theorems, used already by Brianchon in the memoir above referred to) for the demonstration of the theorem called by his name, and in a similar manner by various writers in the earlier volumes of Gergonne. We are here concerned with the method less in itself than as leading to the general notion of duality. And, bearing in a somewhat similar manner also on the theory of imaginaries in geometry (but the notion presents itself in a more explicit form), there is the memoir by Gaultier on the graphical construction of circles and spheres (*Jour. Polyt.*, t. ix., 1813). The well-known theorem as to radical axes may be stated as follows. Consider two circles partially drawn so that it does not appear whether the circles, if completed, would or would not intersect in real points, say two arcs of circles; then we can, by means of a third circle drawn so as to intersect in two real points each of the two arcs, determine a right line, which, if the complete circles intersect in two real points, passes through the points, and which is on this account regarded as a line passing through two (real or imaginary) points of intersection of the two circles. The construction in fact is, join the two points in which the third circle meets the first arc, and join also the two points in which the third circle meets the second arc, and from the point of intersection of the two joining lines, let fall a perpendicular on the line joining the centre of the two circles; this perpendicular (considered as an indefinite line) is what Gaultier terms the "radical axis of the two circles;" it is a line determined by a real construction and itself always real; and by what precedes it is the line joining two (real or imaginary, as the case may be) intersections of the given circles.

The intersections which lie on the radical axis are two out of the four intersections of the two circles. The question as to the remaining two intersections did not present itself to Gaultier, but it is answered in Poncelet's *Traité*

*des propriétés projectives* (1822), where we find (p. 49) the statement, "deux cercles placés arbitrairement sur un plan . . . ont idéalement deux points imaginaires communs à l'infini;"—that is, a circle *qua* curve of the second order is met by the line infinity in two points; but more than this, they are the same two points for any circle whatever. The points in question have since been called (it is believed first by Dr. Salmon) the circular points at infinity, or they may be called the circular points; these are also frequently spoken of as the points I, J; and we have thus the circle characterized as a conic which passes through the two circular points at infinity; the number of conditions thus imposed upon the conic is = 2, and there remain three arbitrary constants, which is the right number for the circle. Poncelet throughout his work makes continual use of the foregoing theories of imaginaries and infinity, and also of the before-mentioned theory of reciprocal polars.

Poncelet's two memoirs, "Sur les centres des moyennes harmoniques," and "Sur la théorie générale des polaires réciproques," although presented to the Paris Academy in 1824, were only published (*Orelle*, t. iii. and iv., 1828, 1829), subsequent to the memoir by Gergonne, "Considérations philosophiques sur les élémens de la science de l'étendue" (*Gerg.*, t. xvi., 1825-26). In this memoir by Gergonne, the theory of duality is very clearly and explicitly stated; for instance, we find "dans la géométrie plane, à chaque théorème il en répond nécessairement un autre qui s'en déduit en échangeant simplement entre eux les deux mots *points* et *droites*; tandis que dans la géométrie de l'espace ce sont les mots *points* et *plans* qu'il faut échanger entre eux pour passer d'un théorème à son corrélatif;" and the plan is introduced of printing correlative theorems, opposite to each other, in two columns. There was a reclamation as to priority by Poncelet in the *Bulletin Universel* reprinted with remarks by Gergonne (*Gerg.*, t. xix., 1827), and followed by a short paper by Gergonne, "Rectifications de quelques théorèmes, etc.," which is important as first introducing the word *class*. We find in it explicitly the two correlative definitions:—"a plane curve is said to be of the *m*th degree (order) when it has with a line *m* real or ideal intersections," and "a plane curve is said to be of the *m*th class when from any point of its plane there can be drawn to it *m* real or ideal tangents."

It may be remarked that in Poncelet's memoir on reciprocal polars, above referred to, we have the theorem that the number of tangents from a point to a curve of the order *m*, or say the class of the curve, is in general and at most = *m(m-1)*, and that he mentions that this number is subject to reduction when the curve has double points or cusps.

The theorem of duality as regards plane figures may be thus stated:—two figures may correspond to each other in such manner that to each point and line in either figure there corresponds in the other figure a line and point respectively. It is to be understood that the theorem extends to all points or lines, drawn or not drawn; thus if in the first figure there are any number of points on a line drawn or not drawn, the corresponding lines in the second figure, produced if necessary, must meet in a point. And we thus see how the theorem extends to curves, their points and tangents: if there is in the first figure a curve of the order *m*, any line meets it in *m* points; and hence from the corresponding point in the second figure there must be to the corresponding curve *m* tangents; that is, the corresponding curve must be of the class *m*.

Trilinear coordinates (to be again referred to) were first used by Bobillier in the memoir, "Essai sur un nouveau mode de recherche des propriétés de l'étendue" (*Greg.*, t. xviii., 1827-28). It is convenient to use these rather than Cartesian co-ordinates. We represent a curve of the order *m* by an equation  $(x, y, z)^m = 0$ , the function on the left hand being a homogeneous rational and integral function of the order *m* of the three co-ordinates (*x, y, z*); clearly the number of constants is the same as for the equation  $(x, y, z, 1)^m = 0$  in Cartesian co-ordinates.

The theory of duality is considered and developed, but chiefly in regard to its metrical applications, by Charles in the "Mémoire de géométrie sur deux principes généraux de la science, la dualité, et l'homographie," which forms a sequel to the "Aperçu Historique sur l'origine et le développement des méthodes en Géométrie" (*Mém. de Brno.*, t. xi., 1837).

We now come to Plücker; his "six equations" were



given in a short memoir in *Crelle* (1842) preceding his great work, the *Theorie der Algebraischen Curven* (1844).

Plücker first gave a scientific dual definition of a curve, viz., "A curve is a locus generated by a point, and enveloped by a line,—the point moving continuously along the line, while the line rotates continuously about the point; the point is a point (ineunt) of the curve, the line is a tangent of the curve.

And, assuming the above theory of geometrical imaginaries, a curve such that  $m$  of its points are situate in an arbitrary line is said to be of the order  $m$ ; a curve such that  $n$  of its tangents pass through an arbitrary point is said to be of the class  $n$ ; as already appearing, this notion of the order and class of a curve is, however, due to Gergonne. Thus the line is a curve of the order 1 and class 0; and corresponding dually thereto, we have the point as a curve of the order 0 and class 1.

Plücker moreover imagined a system of line-coordinates (tangential coordinates). The Cartesian coordinates  $(x, y)$  and trilinear coordinates  $(x, y, z)$  are point-coordinates for determining the position of a point; the new coordinates, say  $(\xi, \eta, \zeta)$  are line-coordinates for determining the position of a line. It is possible, and (not so much for any application thereof as in order to more fully establish the analogy between the two kinds of coordinates) important, to give independent quantitative definitions of the two kinds of coordinates; but we may also derive the notion of line-coordinates from that of point-coordinates; viz., taking  $\xi x + \eta y + \zeta z = 0$  to be the equation of a line, we say that  $(\xi, \eta, \zeta)$  are the line-coordinates of this line. A linear relation  $a\xi + b\eta + c\zeta = 0$  between these coordinates determines a point, viz., the point whose point-coordinates are  $(a, b, c)$ ; in fact, the equation in question  $a\xi + b\eta + c\zeta = 0$  expresses that the equation  $\xi x + \eta y + \zeta z = 0$ , where  $(x, y, z)$  are current point-coordinates, is satisfied on writing therein  $x, y, z = a, b, c$ ; or that the line in question passes through the point  $(a, b, c)$ . Thus  $(\xi, \eta, \zeta)$  are the line-coordinates of any line whatever; but when these, instead of being absolutely arbitrary, are subject to the restriction  $a\xi + b\eta + c\zeta = 0$ , this obliges the line to pass through a point  $(a, b, c)$ ; and the last-mentioned equation  $a\xi + b\eta + c\zeta = 0$  is considered as the line-equation of this point.

A line has only a point-equation, and a point has only a line-equation; but any other curve has a point-equation and also a line-equation; the point-equation  $(\xi x, y, z)^m = 0$  is the relation which is satisfied by the point-coordinates  $(x, y, z)$  of each point of the curve; and similarly the line-equation  $(\xi, \eta, \zeta)^n = 0$  is the relation which is satisfied by the line-coordinates  $(\xi, \eta, \zeta)$  of each line (tangent) of the curve.

There is in analytical geometry little occasion for any explicit use of line-coordinates; but the theory is very important; it serves to show that in demonstrating by point-coordinates any purely descriptive theorem whatever, we demonstrate the correlative theorem; that is, we do not demonstrate the one theorem, and then (as by the method of reciprocal polars) deduce from it the other, but we do at one and the same time demonstrate the two theorems; our  $(x, y, z)$  instead of meaning point-coordinates may mean line-coordinates, and the demonstration is then in every step of it a demonstration of the correlative theorem.

The above dual generation explains the nature of the singularities of a plane curve. The ordinary singularities, arranged according to a cross division, are

	<i>Proper.</i>	<i>Improper.</i>
Point-singularities—	1. The stationary point, cusp, or spinode;	2. The double point, or node;
Line-singularities—	3. The stationary tangent, or inflexion.	4. The double tangent;—

arising as follows:—

1. The cusp: the point as it travels along the line may come to rest, and then reverse the direction of its motion.
2. The stationary tangent: the line may in the course of its rotation come to rest, and then reverse the direction of its rotation.
3. The node: the point may in the course of its motion come to coincide with a former position of the point, the two positions of the line not in general coinciding.
4. The double tangent: the line may in the course of its motion come to coincide with a former position of the line, the two positions of the point not in general coinciding.

It may be remarked that we cannot with a real point and line obtain the node with two imaginary tangents (conju-

gate or isolated point, or acnode), nor again the real double tangent with two imaginary points of contact; but this is of little consequence, since in the general theory the distinction between real and imaginary is not attended to.

The singularities (1) and (3) have been termed proper singularities, and (2) and (4) improper; in each of the first-mentioned cases there is a real singularity, or peculiarity in the motion; in the other two cases there is not; in (2) there is not when the point is first at the node, or when it is secondly at the node, any peculiarity in the motion; the singularity consists in the point coming twice into the same position; and so in (4) the singularity is in the line coming twice into the same position. Moreover (1) and (2) are, the former a proper singularity, and the latter an improper singularity, as regards the motion of the point; and similarly (3) and (4) are, the former a proper singularity, and the latter an improper singularity, as regards the motion of the line.

But as regards the representation of a curve by an equation, the case is very different.

First, if the equation be in point-coordinates, (3) and (4) are in a sense not singularities at all. The curve  $(\xi x, y, z)^m = 0$ , or general curve of the order  $m$ , has double tangents and inflexions; (2) presents itself as a singularity, for the equations  $d_x(\xi x, y, z)^m = 0$ ,  $d_y(\xi x, y, z)^m = 0$ ,  $d_z(\xi x, y, z)^m = 0$ , implying  $(\xi x, y, z)^m = 0$ , are not in general satisfied by any values  $(a, b, c)$  whatever of  $(x, y, z)$ , but if such values exist, then the point  $(a, b, c)$  is a node or double point; and (1) presents itself as a further singularity or sub-case of (2), a cusp being a double point for which the two tangents become coincident.

In line-coordinates all is reversed:—(1) and (2) are not singularities; (3) presents itself as a sub-case of (4).

The theory of compound singularities will be referred to further on.

In regard to the ordinary singularities, we have

$m$ ,	the order,
$n$	“ class,
$\delta$	“ number of double points,
$\kappa$	“ “ cusps,
$\tau$	“ “ double tangents.
$\iota$	“ “ inflexions;

and this being so, Plücker's "six equations" are

- (1)  $n = m(m-1) - 2\delta - 3\kappa,$
- (2)  $\iota = 3m(m-2) - 6\delta - 8\kappa,$
- (3)  $\tau = \frac{1}{2}m(m-2)(m^2-9) - (m^2-m-6)(2\delta+3\kappa) + 2\delta(\delta-1) + 6\delta\kappa + \frac{1}{2}\kappa(\kappa-1),$
- (4)  $m = n(n-1) - 2\tau - 3\iota,$
- (5)  $\kappa = 3n(n-2) - 6\tau - 8\iota,$
- (6)  $\delta = \frac{1}{2}n(n-2)(n^2-9) - (n^2-n-6)(2\tau+3\iota) + 2\tau(\tau-1) + 6\tau\iota + \frac{1}{2}\iota(\iota-1).$

It is easy to derive the further forms—

- (7)  $\iota - \kappa = 3(n-m),$
- (8)  $2(\tau - \delta) = (n-m)(n+m-9),$
- (9)  $\frac{1}{2}m(m+3) - \delta - 2\kappa = \frac{1}{2}n(n+3) - \tau - 2\iota,$
- (10)  $\frac{1}{2}(m-1)(m-2) - \delta - \kappa = \frac{1}{2}(n-1)(n-2) - \tau - \iota,$
- (11, 12)  $m^2 - 2\delta - 3\kappa = n^2 - 2\tau - 3\iota, = m + n,$

the whole system being equivalent to three equations only; and it may be added that using  $\alpha$  to denote the equal quantities  $3m + \iota$  and  $3n + \kappa$  everything may be expressed in terms of  $m, n, \alpha$ . We have

$$\begin{aligned} \kappa &= \alpha - 3n, \\ \iota &= \alpha - 3m, \\ 2\delta &= m^2 - m + 8n - 3\alpha, \\ 2\tau &= n^2 - n + 8m - 3\alpha. \end{aligned}$$

It is implied in Plücker's theorem that,  $m, n, \delta, \kappa, \tau, \iota$  signifying as above in regard to any curve, then in regard to the reciprocal curve  $n, m, \tau, \iota, \delta, \kappa$  will have the same significations, viz., for the reciprocal curve these letters denote respectively the order, class, number of nodes, cusps, double tangents, and inflexions.

The expression  $\frac{1}{2}m(m+3) - \delta - 2\kappa$  is that of the number of the disposable constants in a curve of the order  $m$  with  $\delta$  nodes and  $\kappa$  cusps (in fact that there shall be a node is 1 condition, a cusp 2 conditions) and the equation (9) thus expresses that the curve and its reciprocal contain each of them the same number of disposable constants.

For a curve of the order  $m$ , the expression  $\frac{1}{2}m(m-1) - \delta - \kappa$  is termed the "deficiency" (as to this more hereafter); the equation (10) expresses therefore that the curve and its reciprocal have each of them the same deficiency.

The relations  $m^2 - 2\delta - 3\kappa = n^2 - 2\tau - 3\iota, = m + n$ , present themselves in the theory of envelopes, as will appear further on.

With regard to the demonstration of Plücker's equations it is to be remarked that we are not able to write down the equation in point-coordinates of a curve of the order  $m$ , having the given numbers  $\delta$  and  $\kappa$  of nodes and cusps. We can only use the general equation  $(x, y, z)^m = 0$ , say for shortness  $u=0$ , of a curve of the  $m$ th order, which equation, so long as the coefficients remain arbitrary, represents a curve without nodes or cusps. Seeking then, for this curve, the values  $n, \iota, \tau$  of the class, number of inflexions, and number of double tangents,—first, as regards the class, this is equal to the number of tangents which can be drawn to the curve from an arbitrary point, or what is the same thing it is equal to the number of the points of contact of these tangents. The points of contact are found as the intersections of the curve  $u=0$  by a curve depending on the position of the arbitrary point, and called the "first polar" of this point; the order of the first polar is  $m-1$ , and the number of intersections is thus  $m(m-1)$ . But it can be shown, analytically or geometrically, that if the given curve has a node, the first polar passes through this node, which therefore counts as two intersections, and that if the curve has a cusp, the first polar passes through the cusp, touching the curve there, and hence the cusp counts as three intersections. But, as is evident, the node or cusp

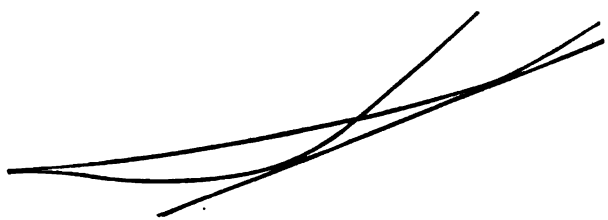

is not a point of contact of a proper tangent from the arbitrary point; we have, therefore, for a node a diminution 2, and for a cusp a diminution 3, in the number of the intersections; and thus, for a curve with  $\delta$  nodes and  $\kappa$  cusps, there is a diminution  $2\delta+3\kappa$ , and the value of  $n$  is  $n=m(m-1)-2\delta-3\kappa$ .

Secondly, as to the inflexions, the process is a similar one; it can be shown that the inflexions are the intersections of the curve by a derivative curve called (after Hesse who first considered it) the Hessian, defined geometrically as the locus of a point such that its conic polar in regard to the curve breaks up into a pair of lines, and which has an equation  $H=0$ , where  $H$  is the determinant formed with the second differential coefficients of  $u$  in regard to the variables  $(x, y, z)$ ;  $H=0$  is thus a curve of the order  $3(m-2)$ , and the number of inflexions is  $-3m(m-2)$ . But if the given curve has a node, then not only the Hessian passes through the node, but it has there a node the two branches of which touch respectively the two branches of the curve; and the node thus counts as six intersections; so if the curve has a cusp, then the Hessian not only passes through the cusp, but it has there a cuspidal branch touching the cuspidal branch of the curve, and besides a simple branch passing through the cusp, and hence the cusp counts as eight intersections. The node or cusp is not an inflexion, and we have thus for a node a diminution 6, and for a cusp a diminution 8, in the number of the intersections; hence for a curve with  $\delta$  nodes and  $\kappa$  cusps, the diminution is  $-6\delta+8\kappa$ , and the number of inflexions is  $\iota=3m(m-2)-6\delta-8\kappa$ .

Thirdly, for the double tangents; the points of contact of these are obtained as the intersections of the curve by a curve  $\Pi=0$ , which has not as yet been geometrically defined, but which is found analytically to be of the order  $(m-2)(m^2-9)$ ; the number of intersections is thus  $-m(m-2)(m^2-9)$ ; but if the given curve has a node then there is a diminution  $-4(m^2-m-6)$ , and if it has a cusp then there is a diminution  $-6(m^2-m-6)$ , where, however, it is to be noticed that the factor  $(m^2-m-6)$  is in the case of a curve having only a node or only a cusp the number of the tangents which can be drawn from the node or cusp to the curve, and is used as denoting the number of these tangents, and ceases to be the correct expression if the number of nodes and cusps is greater than unity. Hence, in the case of a curve which has  $\delta$  nodes and

$\kappa$  cusps, the apparent diminution  $2(m^2-m-6)(2\delta+3\kappa)$  is too great, and it has in fact to be diminished by  $2\{2\delta(\delta-1)+6\delta\kappa+\frac{1}{2}\kappa(\kappa-1)\}$ , or the half thereof is 4 for each pair of nodes, 6 for each combination of a node and cusp, and 9 for each pair of cusps. We have thus finally an expression for  $2\tau, =m(m-2)(m^2-9)$ —etc.; or dividing the whole by 2, we have the expression for  $\tau$  given by the third of Plücker's equations.

It is obvious that we cannot by consideration of the equation  $u=0$  in point-coordinates obtain the remaining three of Plücker's equations; they might be obtained in a precisely analogous manner by means of the equation  $v=0$  in line-coordinates, but they follow at once from the principle of duality, viz., they are obtained by the mere interchange of  $m, \delta, \kappa$  with  $n, \iota, \tau$ , respectively.

To complete Plücker's theory it is necessary to take account of compound singularities; it might be possible, but it is at any rate difficult, to effect this by considering the curve as in course of description by the point moving along the rotating line; and it seems easier to consider the compound singularity as arising from the variation of an actually described curve with ordinary singularities. The most simple case is when three double points come into coincidence, thereby giving rise to a triple point; and a somewhat more complicated one is when we have a cusp of the second kind, or node-cusp arising from the coincidence of a node, a cusp, an inflexion, and a double tangent, as shown in the annexed figure, which represents the singularities as on the point of coalescing. The general conclusion (see Cayley, *Quart. Math. Jour.*, t. vii., 1866, "On the higher singularities of plane curves") is that every singularity whatever may be considered as compounded of ordinary singularities, say we have a singularity  $-d'$  nodes,  $\kappa'$  cusps,  $\tau'$  double tangents, and  $\iota'$  inflexions. So that, in fact, Plücker's equations properly understood apply to a curve with any singularities whatever.

By means of Plücker's equations we may form a table—

$m$	$n$	$\delta$	$\kappa$	$\tau$	$\iota$
0	1	—	—	0	0
1	0	0	0	—	—
2	2	0	0	0	0
3	6	0	0	0	0
"	4	1	0	0	3
"	3	0	1	0	1
4	12	0	0	28	24
"	10	1	0	16	18
"	9	0	1	10	16
"	8	2	0	8	12
"	7	1	1	4	10
"	6	0	2	1	8
"	6	3	0	4	6
"	5	2	1	2	4
"	4	1	2	1	2
"	3	0	3	1	0

The table is arranged according to the value of  $m$ ; and we have  $m=0, n=1$ , the point;  $m=1, n=0$ , the line;  $m=2, n=2$ , the conic; of  $m=3$ , the cubic, there are three cases, the class being 6, 4, or 3, according as the curve is without singularities, or as it has 1 node, or 1 cusp; and so of  $m=4$ , the quartic, there are nine cases, where observe that in two of them the class is  $-6$ ,—the reduction of class arising from two cusps or else from three nodes. The nine cases may be also grouped together into four, according as the number of nodes and cusps  $(\delta+\kappa)$  is  $-0, 1, 2, \text{ or } 3$ .

The cases may be divided into sub-cases, by the consideration of compound singularities; thus when  $m=4, n=6, \kappa=3$ , the three nodes may be all distinct, which is the general case, or two of them may unite together into the singularity called an acnode, or all three may unite together into a triple point, or else into an oscnode.

We may further consider the inflexions and double tangents, as well in general as in regard to cubic and quartic curves.

The expression for the number of inflexions  $3m(m-2)$  for a curve of the order  $m$  was obtained analytically by Plücker, but the theory was first given in a complete form by Hesse in the two papers "Ueber die Elimination, u.s.w.," and "Ueber die Wendepuncte der Curven dritter

Ordnung" (*Crelle*, t. xxviii., 1844); in the latter of these the points of inflexion are obtained as the intersections of the curve  $u=0$  with the Hessian, or curve  $\Delta=0$ , where  $\Delta$  is the determinant formed with the second derived functions of  $u$ . We have in the Hessian the first instance of a covariant of a ternary form. The whole theory of the inflexions of a cubic curve is discussed in a very interesting manner by means of the canonical form of the equation  $x^2+y^2+z^2+6\lambda yz=0$ ; and in particular a proof is given of Plücker's theorem that the nine points of inflexion of a cubic curve lie by threes in twelve lines.

It may be noticed that the nine inflexions of a cubic curve are three real, six imaginary; the three real inflexions lie in a line, as was known to Newton and Maclaurin. For an acnodal cubic the six imaginary inflexions disappear, and there remain three real inflexions lying in a line. For a crunodal cubic, the six inflexions which disappear are two of them real, the other four imaginary, and there remain two imaginary inflexions and one real inflexion. For a cuspidal cubic the six imaginary inflexions and two of the real inflexions disappear, and there remains one real inflexion.

A quartic curve has 24 inflexions; it was conjectured by Salmon, and has been verified recently by Zeuthen, that at most 8 of these are real.

The expression  $\frac{1}{2}m(m-2)(m^2-9)$  for the number of double tangents of a curve of the order  $m$  was obtained by Plücker only as a consequence of his first, second, fourth, and fifth equations. An investigation by means of the curve  $\Pi=0$ , which by its intersections with the given curve determines the points of contact of the double tangents, is indicated by Cayley, "Recherches sur l'élimination et la théorie des courbes" (*Crelle*, t. xxxiv., 1847), and in part carried out by Hesse in the memoir "Ueber Curven dritter Ordnung" (*Crelle*, t. xxxvi., 1848). A better process was indicated by Salmon in the "Note on the double tangents to plane curves," *Phil. Mag.*, 1858; considering the  $m-2$  points in which any tangent to the curve again meets the curve, he showed how to form the equation of a curve of the order  $(m-2)$ , giving by its intersection with the tangent the points in question; making the tangent touch this curve of the order  $(m-2)$ , it will be a double tangent of the original curve. See Cayley, "On the Double Tangents of a Plane Curve" (*Phil. Trans.*, t. cxlviii., 1858), and Dersch (*Math. Ann.*, t. vii., 1874). The solution is still in so far incomplete that we have no properties of the curve  $\Pi=0$ , to distinguish one such curve from the several other curves which pass through the points of contact of the double tangents.

A quartic curve has 28 double tangents, their points of contact determined as the intersections of the curve by a curve  $\Pi=0$  of the order 14, the equation of which, in a very elegant form, was first obtained by Hesse (1849). Investigations in regard to them are given by Plücker in the *Theorie der Algebraischen Curven*, and in two memoirs by Hesse and Steiner (*Crelle*, t. xlv., 1855), in respect to the triads of double tangents which have their points of contact on a conic, and other like relations. It was assumed by Plücker that the number of real double tangents might be 28, 16, 8, 4, or 0, but Zeuthen has recently found that the last case does not exist.

The Hessian  $\Delta$  has just been spoken of as a covariant of the form  $u$ ; the notion of invariants and covariants belongs rather to the form  $u$  than to the curve  $u=0$  represented by means of this form; and the theory may be very briefly referred to. A curve  $u=0$  may have some invariantive property, viz., a property independent of the particular axes of co-ordinates used in the representation of the curve by its equation; for instance, the curve may have a node, and in order to this, a relation, say  $A=0$ , must exist between the coefficients of the equation; supposing the axes of co-ordinates altered, so that the equation becomes  $u'=0$ , and writing  $A'=0$  for the relation between the new coefficients, then the relations  $A=0$ ,  $A'=0$ , as two different expressions of the same geometrical property, must each of them imply the other; this can only be the case when  $A$ ,  $A'$  are functions differing only by a constant factor, or say, when  $A$  is an invariant of  $u$ . If, however, the geometrical property requires two or more relations between the coefficients, say  $A=0$ ,  $B=0$ , etc., then we must have between the new coefficients the like relations,  $A'=0$ ,  $B'=0$ , etc., and the two systems of equations must each of them imply the other; when this is so, the system of

equations,  $A=0$ ,  $B=0$ , etc., is said to be invariantive, but it does not follow that  $A$ ,  $B$ , etc., are of necessity invariants of  $u$ . Similarly, if we have a curve  $U=0$  derived from the curve  $u=0$  in a manner independent of the particular axes of co-ordinates, then from the transformed equation  $u'=0$  deriving in like manner the curve  $U'=0$ , the two equations  $U=0$ ,  $U'=0$  must each of them imply the other; and when this is so,  $U$  will be a covariant of  $u$ . The case is less frequent, but it may arise, that there are covariant systems  $U=0$ ,  $V=0$ , etc., and  $U'=0$ ,  $V'=0$ , etc., each implying the other, but where the functions  $U$ ,  $V$ , etc., are not of necessity covariants of  $u$ .

The theory of the invariants and covariants of a ternary cubic function  $u$  has been studied in detail, and brought into connection with the cubic curve  $u=0$ ; but the theory of the invariants and covariants for the next succeeding case, the ternary quartic function, is still very incomplete.

In further illustration of the Plückerian dual generation of a curve, we may consider the question of the envelope of a variable curve. The notion is very probably older, but it is at any rate to be found in Lagrange's *Théorie des Fonctions analytiques* (1798); it is there remarked that the equation obtained by the elimination of the parameter  $a$  from an equation  $f(x, y, a)=0$  and the derived equation in respect to  $a$  is a curve, the envelope of the series of curves represented by the equation  $f(x, y, a)=0$  in question. To develop the theory, consider the curve corresponding to any particular value of the parameter; this has with the consecutive curve (or curve belonging to the consecutive value of the parameter) a certain number of intersections, and of common tangents, which may be considered as the tangents at the intersections; and the so-called envelope is the curve which is at the same time generated by the points of intersection and enveloped by the common tangents; we have thus a dual generation. But the question needs to be further examined. Suppose that in general the variable curve is of the order  $m$  with  $\delta$  nodes and  $\kappa$  cusps, and therefore of the class  $n$  with  $\tau$  double tangents and  $\iota$  inflexions,  $m, n, \delta, \kappa, \tau, \iota$  being connected by the Plückerian equations,—the number of nodes or cusps may be greater for particular values of the parameter, but this is a speciality which may be here disregarded. Considering the variable curve corresponding to a given value of the parameter, or say simply the variable curve, the consecutive curve has then also  $\delta$  and  $\kappa$  nodes and cusps, consecutive to those of the variable curve; and it is easy to see that among the intersections of the two curves we have the nodes each counting twice, and the cusps each counting three times; the number of the remaining intersections is  $m^2-2\delta-3\kappa$ . Similarly among the common tangents of the two curves we have the double tangents each counting twice, and the stationary tangents each counting three times, and the number of the remaining common tangents is  $n^2-2\tau-3\iota$  ( $=m^2-2\delta-3\kappa$ , inasmuch as each of these numbers is as was seen  $=m+n$ ). At any one of the  $m^2-2\delta-3\kappa$  points the variable curve and the consecutive curve have tangents distinct from, yet infinitesimally near to each other, and each of these two tangents is also infinitesimally near to one of the  $n^2-2\tau-3\iota$  common tangents of the two curves; whence, attending only to the variable curve, and considering the consecutive curve as coming into actual coincidence with it, the  $n^2-2\tau-3\iota$  common tangents are the tangents to the variable curve at the  $m^2-2\delta-3\kappa$  points respectively, and the envelope is at the same time generated by the  $m^2-2\delta-3\kappa$  points, and enveloped by the  $n^2-2\tau-3\iota$  tangents; we have thus a dual generation of the envelope, which only differs from Plücker's dual generation in that, in place of a single point and tangent, we have the group of  $m^2-2\delta-3\kappa$  points and  $n^2-2\tau-3\iota$  tangents.

The parameter which determines the variable curve may be given as a point upon a given curve, or say as a parametric point; that is, to the different positions of the parametric point on the given curve correspond the different variable curves, and the nature of the envelope will thus depend on that of the given curve; we have thus the envelope as a derivative curve of the given curve. Many well-known derivative curves present themselves in this manner; thus the variable curve may be the normal (or line at right angles to the tangent) at any point of the given curve; the intersection of the consecutive normals is the centre of curvature; and we have the evolute as at once the locus of the centre of curvature and the envelope of

the normal. It may be added that the given curve is one of a series of curves, each cutting the several normals at right angles. Any one of these is a "parallel" of the given curve; and it can be obtained as the envelope of a circle of constant radius having its centre on the given curve. We have in like manner, as derivatives of a given curve, the caustic, catacaustic, or diacaustic, as the case may be, and the secondary caustic, or curve cutting at right angles the reflected or refracted rays.

We have in much that precedes disregarded, or at least been indifferent to, reality; it is only thus that the conception of a curve of the  $m$ -th order, as one which is met by every right line in  $m$  points, is arrived at; and the curve itself, and the line which cuts it, although both are tacitly assumed to be real, may perfectly well be imaginary. For real figures we have the general theorem that imaginary intersections, etc., present themselves in conjugate pairs; hence, in particular, that a curve of an even order is met by a line in an even number (which may be  $= 0$ ) of points; a curve of an odd order in an odd number of points, hence in one point at least; it will be seen further on that the theorem may be generalized in a remarkable manner. Again, when there is in question only one pair of points or lines, these, if coincident, must be real; thus, a line meets a cubic curve in three points, one of them real, the other two real or imaginary; but if two of the intersections coincide they must be real, and we have a line cutting a cubic in one real point and touching it in another real point. It may be remarked that this is a limit separating the two cases where the intersections are all real, and where they are one real, two imaginary.

Considering always real curves, we obtain the notion of a branch; any portion capable of description by the continuous motion of a point is a branch; and a curve consists of one or more branches. Thus the curve of the first order or right line consists of one branch; but in curves of the second order, or conics, the ellipse and the parabola consist each of one branch, the hyperbola of two branches. A branch is either re-entrant, or it extends both ways to infinity, and in this case, we may regard it as consisting of two legs (*crura*, Newton), each extending one way to infinity, but without any definite separation. The branch, whether re-entrant or infinite, may have a cusp or cusps, or it may cut itself or another branch, thus having or giving rise to crunodes; an acnode is a branch by itself,—it may be considered as an indefinitely small re-entrant branch. A branch may have inflexions and double tangents, or there may be double tangents which touch two distinct branches; there are also double tangents with imaginary points of contact, which are thus lines having no visible connection with the curve. A re-entrant branch not cutting itself may be everywhere convex, and it is then properly said to be an oval; but the term oval may be used more generally for any re-entrant branch not cutting itself; and we may thus speak of a once indented, twice indented oval, etc., or even of a cuspidate oval. Other descriptive names for ovals and re-entrant branches cutting themselves may be used when required; thus, in the last-mentioned case a simple form is that of a figure of eight; such a form may break up into two ovals, or into a doubly indented oval or hour-glass. A form which presents itself is when two ovals, one inside the other, unite, so as to give rise to a crunode—in default of a better name this may be called after the curve of that name, a limacon. Names may also be used for the different forms of infinite branches, but we have first to consider the distinction of hyperbolic and parabolic. The leg of an infinite branch may have at the extremity a tangent; this is an asymptote of the curve, and the leg is then hyperbolic; or the leg may tend to a fixed direction, but so that the tangent goes further and further off to infinity, and the leg is then parabolic; a branch may thus be hyperbolic or parabolic as to its two legs; or it may be hyperbolic as to one leg, and parabolic as to the other. The epithets hyperbolic and parabolic are of course derived from the conic hyperbola and parabola respectively. The nature of the two kinds of branches is best understood by considering them as projections, in the same way as we in effect consider the hyperbola and the parabola as projections of the ellipse. If a line  $\Omega$  cut an arc  $aa'$ , so that the two segments  $ab$ ,  $ba'$  lie on opposite sides of the line, then projecting the figure so that the line  $\Omega$  goes off to infinity, the tangent at  $b$  is projected into the asymptote, and the arc  $ab$  is projected

into a hyperbolic leg touching the asymptote at one extremity; the arc  $ba'$  will at the same time be projected into a hyperbolic leg touching the same asymptote at the other extremity (and on the opposite side), but so that the two hyperbolic legs may or may not belong to one and the same branch. And we thus see that the two hyperbolic legs belong to a simple intersection of the curve by the line infinity. Next, if the line  $\Omega$  touch at  $b$  the arc  $aa'$  so that the two portions  $ab'$ ,  $ba$  lie on the same side of the line  $\Omega$ , then projecting the figure as before, the tangent at  $b$ , that is, the line  $\Omega$  itself, is projected to infinity; the arc  $ab$  is projected into a parabolic leg, and at the same time the arc  $ba'$  is projected into a parabolic leg, having at infinity the same direction as the other leg, but so that the two legs may or may not belong to the same branch. And we thus see that the two parabolic legs represent a contact of the line infinity with the curve,—the point of contact being of course the point at infinity determined by the common direction of the two legs. It will readily be understood how the like considerations apply to other cases,—for instance, if the line  $\Omega$  is a tangent at an inflexion, passes through a crunode, or touches one of the branches of a crunode, etc.; thus, if the line  $\Omega$  passes through a crunode we have pairs of hyperbolic legs belonging to two parallel asymptotes. The foregoing considerations also show (what is very important) how different branches are connected together at infinity, and lead to the notion of a complete branch, or circuit.

The two legs of a hyperbolic branch may belong to different asymptotes, and in this case we have the forms which Newton calls inscribed, circumscribed, ambigene, etc.; or they may belong to the same asymptote, and in this case we have the serpentine form, where the branch cuts the asymptote, so as to touch it at its two extremities on opposite sides, or the conchoidal form, where it touches the asymptote on the same side. The two legs of a parabolic branch may converge to ultimate parallelism, as in the conic parabola, or diverge to ultimate parallelism, as in the semi-cubical parabola  $y^2 = x^2$ , and the branch is said to be convergent, or divergent, accordingly; or they may tend to parallelism in opposite senses, as in the cubical parabola  $y = x^2$ . As mentioned with regard to a branch generally, an infinite branch of any kind may have cusps, or, by cutting itself or another branch, may have or give rise to a crunode, etc.

We may now consider the various forms of cubic curves, as appearing by Newton's *Enumeratio*, and by the figures belonging thereto. The species are reckoned as 72, which are numbered accordingly 1 to 72; but to these should be added 10<sup>a</sup>, 13<sup>a</sup>, 22<sup>a</sup>, and 22<sup>b</sup>. It is not intended here to consider the division into species, nor even completely that into genera, but only to explain the principle of classification. It may be remarked generally that there are at most three infinite branches, and that there may besides be a re-entrant branch or oval.

The genera may be arranged as follows:—

1,2,3,4	redundant hyperbolas
5,6	defective hyperbolas
7,8	parabolic hyperbolas
9	hyperbolisms of hyperbola
10	" ellipse
11	" parabola
12	trident curve
13	divergent parabolas
14	cubic parabola;

and thus arranged they correspond to the different relations of the line infinity to the curve. First, if the three intersections by the line infinity are all distinct, we have the hyperbolas; if the points are real, the redundant hyperbolas, with the three hyperbolic branches; but if only one of them is real, the defective hyperbolas, with one hyperbolic branch. Secondly, if two of the intersections coincide, say if the line infinity meets the curve in a onefold point and a twofold point, both of them real, then there is always one asymptote; the line infinity may at the twofold point touch the curve, and we have the parabolic hyperbolas; or the twofold point may be a singular point,—viz., a crunode giving the hyperbolisms of the hyperbola; an acnode, giving the hyperbolisms of the ellipse; or a cusp, giving the hyperbolisms of the parabola. As regards the so-called hyperbolisms, observe that (besides the single asymptote) we have in the case of those of the hyperbola two parallel asymptotes; in the case of those of the ellipse the two par-

allel asymptotes become imaginary, that is, they disappear; and in the case of those of the parabola they become coincident, that is, there is here an ordinary asymptote, and a special asymptote answering to a cusp at infinity. Thirdly, the three intersections by the line infinity may be coincident and real; or say we have a threefold point: this may be an inflexion, a crunode, or a cusp, that is, the line infinity may be a tangent at an inflexion, and we have the divergent parabolas; a tangent at a crunode to one branch, and we have the trident curve; or, lastly, a tangent at a cusp, and we have the cubical parabola.

It is to be remarked that the classification mixes together non-singular and singular curves, in fact, the five kinds presently referred to: thus the hyperbolas and the divergent parabolas include curves of every kind, the separation being made in the species; the hyperbolisms of the hyperbola and ellipse, and the trident curve, are nodal; the hyperbolisms of the parabola, and the cubical parabola are cuspidal. The divergent parabolas are of five species which respectively belong to and determine the five kinds of cubic curves; Newton gives (in two short paragraphs without any development) the remarkable theorem that the five divergent parabolas by their shadows generate and exhibit all the cubic curves.

The five divergent parabolas are curves each of them symmetrical with regard to an axis. There are two non-singular kinds, the one with, the other without, an oval, but each of them has an infinite (as Newton describes it) *compansiform* branch; this cuts the axis at right angles, being at first convex, but ultimately concave, towards the axis, the two legs continually tending to become at right angles to the axis. The oval may unite itself with the infinite branch, or it may dwindle into a point, and we have the crunodal and the acnodal forms respectively; or if simultaneously the oval dwindles into a point and unites itself to the infinite branch, we have the cuspidal form. Drawing a line to cut any one of these curves and projecting the line to infinity, it would not be difficult to show how the line should be drawn in order to obtain a curve of any given species. We have herein a better principle of classification; considering cubic curves, in the first instance, according to singularities, the curves are non-singular, nodal (viz., crunodal or acnodal), or cuspidal; and we see further that there are two kinds of non-singular curves, the complex and the simplex. There is thus a complete division into the five kinds, the complex, simplex, crunodal, acnodal, and cuspidal. Each singular kind presents itself as a limit separating two kinds of inferior singularity; the cuspidal separates the crunodal and the acnodal, and these last separate from each other the complex and the simplex.

The whole question is discussed very fully and ably by Möbius in the memoir "Ueber die Grundformen der Linien dritter Ordnung" (*Abh. der K. Sachs. Ges. zu Leipzig*, t. i., 1852). The author considers not only plane curves, but also cones, or, what is almost the same thing, the spherical curves which are their sections by a concentric sphere. Stated in regard to the cone, we have there the fundamental theorem that there are two different kinds of sheets: viz., the single sheet, not separated into two parts by the vertex (an instance is afforded by the plane considered as a cone of the first order generated by the motion of a line about a point) and the double or twin-pair sheet, separated into two parts by the vertex (as in the cone of the second order). And it then appears that there are two kinds of non-singular cubic cones, viz., the simplex, consisting of a single sheet, and the complex, consisting of a single sheet and a twin-pair sheet, and we thence obtain (as for cubic curves) the crunodal, the acnodal, and the cuspidal kinds of cubic cones. It may be mentioned that the single sheet is a sort of wavy form, having upon it three lines of inflexion, and which is met by any plane through the vertex in one or in three lines; the twin-pair sheet has no lines of inflexion, and resembles in its form a cone on an oval base.

In general a cone consists of one or more single or twin-pair sheets, and if we consider the section of the cone by a plane, the curve consists of one or more complete branches, or say circuits, each of them the section of one sheet of the cone; thus, a cone of the second order is one twin-pair sheet, and any section of it is one circuit composed, it may be, of two branches. But although we thus arrive by projection at the notion of a circuit, it is not

necessary to go out of the plane, and we may (with Zeuthen, using the shorter term *circuit* for his *complete branch*) define a circuit as any portion (of a curve) capable of description by the continuous motion of a point, it being understood that a passage through infinity is permitted. And we then say that a curve consists of one or more circuits; thus the right line or curve of the first order consists of one circuit; a curve of the second order consists of one circuit; a cubic curve consists of one circuit or else of two circuits.

A circuit is met by any right line always in an even number, or always in an odd number, of points, and it is said to be an even circuit or an odd circuit accordingly; the right line is an odd circuit, the conic an even circuit. And we have then the theorem, two odd circuits intersect in an odd number of points; an odd and an even circuit, or two even circuits, in an even number of points. An even circuit not cutting itself divides the plane into two parts, the one called the internal part, incapable of containing any odd circuit, the other called the external part, capable of containing an odd circuit.

We may now state in a more convenient form the fundamental distinction of the kinds of cubic curve. A non-singular cubic is simplex, consisting of one odd circuit, or it is complex, consisting of one odd circuit and one even circuit. It may be added that there are on the odd circuit three inflexions, but on the even circuit no inflexions; it hence also appears that from any point of the odd circuit there can be drawn to the odd circuit two tangents, and to the even circuit (if any) two tangents, but that from a point of the even circuit there cannot be drawn (either to the odd or the even circuit) any real tangent; consequently, in a simplex curve the number of tangents from any point is two, but in a complex curve the number is four, or none—four if the point is on the odd circuit, none if it is on the even circuit. It at once appears from inspection of the figure of a non-singular cubic curve, which is the odd and which the even circuit. The singular kinds arise as before; in the crunodal and the cuspidal kinds the whole curve is an odd circuit, but in the acnodal kind the acnode must be regarded as an even circuit.

The analogous question of the classification of quartics (in particular non-singular quartics and nodal quartics) is considered in Zeuthen's memoir "Sur les differentes formes des courbes planes du quatrième ordre" (*Math. Ann.*, t. vii., 1874). A non-singular quartic has only even circuits; it has at most four circuits external to each other, or two circuits, one internal to the other, and in this last case the internal circuit has no double tangents or inflexions. A very remarkable theorem is established as to the double tangents of such a quartic:—distinguishing as a double tangent of the first kind a real double tangent which either twice touches the same circuit, or else touches the curve in two imaginary points, the number of the double tangents of the first kind of a non-singular quartic is  $-4$ ; it follows that the quartic has at most 8 real inflexions. The forms of the non-singular quartics are very numerous, but it is not necessary to go further into the question.

We may consider in relation to a curve, not only the line infinity, but also the circular points at infinity; assuming the curve to be real, these present themselves always conjointly; thus a circle is a conic passing through the two circular points, and is thereby distinguished from other conics. Similarly a cubic through the two circular points is termed a circular cubic; a quartic through the two points is termed a circular quartic, and if it passes twice through each of them, that is, has each of them for a node, it is termed a bicircular quartic. Such a quartic is of course binodal ( $m=4, \delta=2, \kappa=0$ ); it has not in general, but it may have, a third node, or a cusp. Or again, we may have a quartic curve having a cusp at each of the circular points; such a curve is a "Cartesian," it being a complete definition of the Cartesian to say that it is a bicuspidal quartic curve ( $m=4, \delta=0, \kappa=2$ ), having a cusp at each of the circular points. The circular cubic and the bicircular quartic, together with the Cartesian (being in one point of view a particular case thereof), are interesting curves which have been much studied, generally, and in reference to their focal properties.

The points called *foci* presented themselves in the theory of the conic, and were well known to the Greek geometers, but the general notion of a focus was first established by Plücker (in the memoir "Ueber solche Punkte die bei

Curven einer höheren Ordnung den Brennpunkten der Kegelschnitte entsprechen" (*Orelle*, t. x., 1833). We may from each of the circular points draw tangents to a given curve; the intersection of two such tangents (belonging of course to the two circular points respectively) is a focus. There will be from each circular point  $\lambda$  tangents ( $\lambda$ , a number depending on the class of the curve and its relation to the line infinity and the circular points, = 2 for the general conic, 1 for the parabola, 2 for a circular cubic, or bicircular quartic, etc.); the  $\lambda$  tangents from the one circular point and those from the other circular point intersect in  $\lambda$  real foci (viz., each of these is the only real point on each of the tangents through it), and in  $\lambda^2 - \lambda$  imaginary foci; each pair of real foci determines a pair of imaginary foci (the so-called antipoints of the two real foci), and the  $\frac{1}{2}\lambda(\lambda-1)$  pairs of real foci thus determine the  $\lambda^2 - \lambda$  imaginary foci. There are in some cases points termed centres, or singular or multiple foci (the nomenclature is unsettled), which are the intersections of improper tangents from the two circular points respectively; thus, in the circular cubic, the tangents to the curve at the two circular points respectively (or two imaginary asymptotes of the curve) meet in a centre.

The notions of *distances* and of lines at *right angles* are connected with the circular points; and almost every construction of a curve by means of lines of a determinate length, or at right angles to each other, and (as such) mechanical constructions by means of linkwork, give rise to curves passing the same definite number of times through the two circular points respectively, or say to circular curves, and in which the fixed centres of the construction present themselves as ordinary, or as singular foci. Thus the general curve of three bar-motion (or locus of the vertex of a triangle, the other two vertices whereof move on fixed circles) is a tricircular sextic, having besides three nodes ( $m+6, \delta-3+3+3, =9$ ), and having the centres of the fixed circles each for a singular focus; there is a third singular focus, and we have thus the remarkable theorem (due to Mr. S. Roberts) of the triple generation of the curve by means of the three several pairs of singular foci.

Again, the normal, *qua* line at right angles to the tangent, is connected with the circular points, and these accordingly present themselves in the before-mentioned theories of evolutes and parallel curves.

We have several recent theories which depend on the notion of *correspondence*: two points whether in the same plane or in different planes, or on the same curve or in different curves, may determine each other in such wise that to any given position of the first point there correspond  $a'$  positions of the second point, and to any given position of the second point  $a$  positions of the first point; the two points have then an  $(a, a')$  correspondence; and if  $a, a'$  are each = 1, then the two points have a (1, 1) or rational correspondence. Connecting with each theory the author's name, the theories in question are—Riemann, the rational transformation of a plane curve; Cremona, the rational transformation of a plane; and Chasles, correspondence of points on the same curve, and united points. The theory first referred to, with the resulting notion of *Geschlecht*, or *deficiency*, is more than the other two an essential part of the theory of curves, but they will all be considered.

Riemann's results are contained in the memoirs on "Abelian Integrals," etc. (*Orelle*, t. liv., 1857), and we have next Clebsch, "Ueber die Singularitäten algebraischer Curven" (*Orelle*, t. lxx., 1865), and Cayley, "On the Transformation of Plane Curves" (*Proc. Lond. Math. Soc.*, t. i., 1865). The fundamental notion of the rational transformation is as follows:—

Taking  $u, X, Y, Z$  to be rational and integral functions ( $X, Y, Z$  all of the same order) of the co-ordinates  $(x, y, z)$ , and  $u', X', Y', Z'$  rational and integral functions ( $X', Y', Z'$  all of the same order) of the co-ordinates  $(x', y', z')$ , we transform a given curve  $u = 0$ , by the equations  $x' : y' : z' = X : Y : Z$ , thereby obtaining a transformed curve  $u' = 0$ , and a converse set of equations  $x : y : z = X' : Y' : Z'$ ; viz., assuming that this is so, the point  $(x, y, z)$  on the curve  $u = 0$  and the point  $(x', y', z')$  on the curve  $u' = 0$  will be points having a (1, 1) correspondence. To show how this is, observe that to a given point  $(x, y, z)$  on the curve  $u = 0$  there corresponds a single point  $(x', y', z')$  determined by the equations  $x' : y' : z' = X : Y : Z$ ; from these equations and the equation  $u = 0$  eliminating  $x, y, z$ , we obtain the equation  $u' = 0$  of the transformed curve. To a given point  $(x', y', z')$  not on the curve  $u' = 0$  there corresponds, not a single point, but the system of

points  $(x, y, z)$  given by the equations  $x' : y' : z' = X : Y : Z$ , viz., regarding  $x', y', z'$  as constants (and to fix the ideas, assuming that the curves  $X = 0, Y = 0, Z = 0$  have no common intersections), these are the points of intersection of the curves  $X : Y : Z = x' : y' : z'$ , but no one of these points is situate on the curve  $u = 0$ . If, however, the point  $(x', y', z')$  is situate on the curve  $u' = 0$ , then one point of the system of points in question is situate on the curve  $u = 0$ , that is, to a given point of the curve  $u' = 0$  there corresponds a single point of the curve  $u = 0$ ; and hence also this point must be given by a system of equations such as  $x : y : z = X' : Y' : Z'$ .

It is an old and easily proved theorem that, for a curve of the order  $m$ , the number  $\delta + \kappa$  of nodes and cusps is at most  $-\frac{1}{2}(m-1)(m-2)$ ; for a given curve the deficiency of the actual number of nodes and cusps below this maximum number, viz.,  $\frac{1}{2}(m-1)(m-2) - \delta - \kappa$ , is the "*Geschlecht*," or "*deficiency*," of the curve," say this is  $= D$ . When  $D = 0$ , the curve is said to be unicursal, when  $= 1$ , bicursal, and so on.

The general theorem is that two curves corresponding rationally to each other have the same deficiency. [In particular a curve and its reciprocal have this rational or (1, 1) correspondence, and it has been already seen that a curve and its reciprocal have the same deficiency.]

A curve of a given order can in general be rationally transformed into a curve of a lower order; thus a curve of any order for which  $D = 0$ , that is, a unicursal curve, can be transformed into a line; a curve of any order having the deficiency 1 or 2 can be rationally transformed into a curve of the order  $D+2$ , deficiency  $D$ ; and a curve of any order deficiency  $= \text{or} > 3$  can be rationally transformed into a curve of the order  $D+3$ , deficiency  $D$ .

Taking  $x', y', z'$  as co-ordinates of a point of the transformed curve, and in its equation writing  $x' : y' : z' = 1 : \theta : \phi$  we have  $\phi$  a certain irrational function of  $\theta$ , and the theorem is that the co-ordinates  $x, y, z$  of any point of the given curve can be expressed as proportional to rational and integral functions of  $\theta, \phi$ , that is, of  $\theta$  and a certain irrational function of  $\theta$ .

In particular if  $D = 0$ , that is, if the given curve be unicursal the transformed curve is a line,  $\phi$  is a mere linear function of  $\theta$ , and the theorem is that the co-ordinates  $x, y, z$  of a point of the unicursal curve can be expressed as proportional to rational and integral functions of  $\theta$ ; it is easy to see that for a given curve of the order  $m$ , these functions of  $\theta$  must be of the same order  $m$ .

If  $D = 1$ , then the transformed curve is a cubic; it can be shown that in a cubic, the axes of co-ordinates being properly chosen,  $\phi$  can be expressed as the square root of a quartic function of  $\theta$ ; and the theorem is that the co-ordinates  $x, y, z$  of a point of the bicursal curve can be expressed as proportional to rational and integral functions of  $\theta$ , and of the square root of a quartic function of  $\theta$ .

And so if  $D = 2$ , then the transformed curve is a nodal quartic;  $\phi$  can be expressed as the square root of a sextic function of  $\theta$ , and the theorem is, that the co-ordinates  $x, y, z$  of a point of the tricursal curve can be expressed as proportional to rational and integral functions of  $\theta$ , and of the square root of a sextic function of  $\theta$ . But  $D = 3$ , we have no longer the like law, viz.,  $\phi$  is not expressible as the square root of an octic function of  $\theta$ .

Observe that the radical, square root of a quartic function, is connected with the theory of elliptic functions, and the radical, square root of a sextic function, with that of the first kind of Abelian functions, but that the next kind of Abelian functions does not depend on the radical, square root of an octic function.

It is a form of the theorem for the case  $D = 1$ , that the co-ordinates  $x, y, z$  of a point of the bicursal curve, or in particular the co-ordinates of a point of the cubic, can be expressed as proportional to rational and integral functions of the elliptic functions  $\text{sn} u, \text{cn} u, \text{dn} u$ ; in fact, taking the radical to be  $\sqrt{1 - \theta^2 - k^2 \theta^4}$ , and writing  $\theta = \text{sn} u$ , the radical becomes  $-\text{cn} u, \text{dn} u$ ; and we have expressions of the form in question.

It will be observed that the equations  $x' : y' : z' = X : Y : Z$  before-mentioned do not of themselves lead to the other system of equations  $x : y : z = X' : Y' : Z'$ , and thus that the theory does not in anywise establish a (1, 1) correspondence between the points  $(x, y, z)$  and  $(x', y', z')$  of two planes or of the same plane; this is the correspondence of Cremona's theory.

In this theory, given in the memoirs "*Sulle Trasformazioni geometriche delle Figure piane*," *Mem. di Bologna*, t. ii. (1863) and t. v. (1865), we have a system of equations  $x' : y' : z' = X : Y : Z$  which does lead to a system  $x : y : z = X' : Y' : Z'$ .

where, as before,  $X, Y, Z$  denote rational and integral functions, all of the same order, of the co-ordinates  $x, y, z$ , and  $X', Y', Z'$  rational and integral functions, all of the same order, of the co-ordinates  $x', y', z'$ , and there is thus a (1,1) correspondence given by these equations between the two points  $(x, y, z)$  and  $(x', y', z')$ . To explain this, observe that starting from the equations  $x' : y' : z' = X : Y : Z$ , to a given point  $(x, y, z)$  there corresponds one point  $(x', y', z')$ , but that if  $n$  be the order of the functions  $X, Y, Z$ , then to a given point  $x', y', z'$  there would, if the curves  $X = 0, Y = 0, Z = 0$  had no common intersections, correspond  $n^2$  points  $(x, y, z)$ . If however, the functions are such that the curves  $X = 0, Y = 0, Z = 0$  have  $k$  common intersections, then among the  $n^2$  points are included these  $k$  points, which are fixed points independent of the point  $(x', y', z')$ ; so that, disregarding these fixed points, the number of points  $(x, y, z)$  corresponding to the given point  $(x', y', z')$  is  $n^2 - k$ ; and in particular if  $k = n^2 - 1$ , then we have one corresponding point; and hence the original system of equations  $x' : y' : z' = X : Y : Z$  must lead to the equivalent system  $x : y : z = X' : Y' : Z'$ ; and in this system by the like reasoning the functions must be such that the curves  $X' = 0, Y' = 0, Z' = 0$  have  $n^2 - 1$  common intersections. The most simple example is in the two systems of equations  $x' : y' : z' = xs : xz : xy$  and  $x : y : z = y's' : s'x' : x'y'$ ; where  $ys = 0, xz = 0, xy = 0$  are conics (pairs of lines) having three common intersections, and where obviously either system of equations leads to the other system. In the case where  $X, Y, Z$  are of an order exceeding 2 the required number  $n^2 - 1$  of common intersections can only occur by reason of common multiple points on the three curves; and assuming that the curves  $X = 0, Y = 0, Z = 0$  have  $a_1 + a_2 + a_3 + \dots + a_{n-1}$  common intersections, where the  $a_1$  points are ordinary points, the  $a_2$  points are double points, the  $a_3$  points are triple points, etc., on each curve, we have the condition

$$a_1 + 4a_2 + 9a_3 + \dots + (n-1)^2 a_{n-1} = n^2 - 1;$$

but this must be joined the condition

$$a_1 + 3a_2 + 6a_3 + \dots + \frac{1}{2}(n-1)(n-2) a_{n-1} = \frac{1}{2}n(n+3) - 2,$$

(without which the transformation would be illusory); and the conclusion is that  $a_1, a_2, \dots, a_{n-1}$  may be any numbers satisfying these two equations. It may be added that the two equations together give

$$a_2 + 3a_3 + \dots + \frac{1}{2}(n-1)(n-2) a_{n-1} = \frac{1}{2}(n-1)(n-2),$$

which expresses that the curves  $X = 0, Y = 0, Z = 0$  are unicursal. The transformation may be applied to any curve  $u = 0$ , which is thus rationally transformed into a curve  $u' = 0$ , by a rational transformation such as is considered in Riemann's theory: hence the two curves have the same deficiency.

Coming next to Chasles, the principle of correspondence is established and used by him in a series of memoirs relating to the conics which satisfy given conditions, and to other geometrical questions, contained in the *Comptes Rendus*, t. lviii. et seq. (1864 to the present time). The theorem of united points in regard to points in a right line was given in a paper, June-July, 1864, and it was extended to unicursal curves in a paper of the same series (March, 1866), "Sur les courbes planes ou à double courbure dont les points peuvent se déterminer individuellement—application du principe de correspondance dans la théorie de ces courbes."

The theorem is as follows: if in a unicursal curve two points have an  $(\alpha, \beta)$  correspondence, then the number of united points (or points each corresponding to itself) is  $-\alpha + \beta$ . In fact in a unicursal curve the co-ordinates of a point are given as proportional to rational and integral functions of a parameter, so that any point of the curve is determined uniquely by means of this parameter; that is, to each point of the curve corresponds one value of the parameter, and to each value of the parameter one point on the curve; and the  $(\alpha, \beta)$  correspondence between the two points is given by an equation of the form  $(\theta, \phi, 1)^{\alpha}$   $(\phi, 1)^{\beta} = 0$  between their parameters  $\theta$  and  $\phi$ ; at a united point  $\phi = \theta$ , and the value of  $\theta$  is given by an equation of the order  $\alpha + \beta$ . The extension to curves of any given deficiency  $D$  was made in the memoir of Cayley, "On the correspondence of two points on a curve"—*Proc. Lond. Math. Soc.*, t. i. (1866), viz., taking  $P, P'$  as the corresponding points in an  $(\alpha, \alpha')$  correspondence on a curve of deficiency  $D$ , and supposing that when  $P$  is given the corresponding points  $P'$  are found as the intersections of the curve by a curve  $O$  containing the co-ordinates of  $P$  as parameters, and having with the given curve  $k$  intersections at the point  $P$ , then the number of united points is  $\alpha - \alpha' + kD$ ; and more generally, if the curve  $O$  intersect the given curve in a set of points  $P'$  each  $p$  times, a set of points  $Q'$  each  $q$  times, etc., in such manner that the points  $(P, P')$  the points  $(P, Q')$  etc., are pairs of points corresponding to each other according to distinct laws; then if  $(P, P')$  are points having an  $(\alpha, \alpha')$  correspondence with a number  $-\alpha$  of united points,

$(P, Q')$  points having a  $(\beta, \beta')$  correspondence with a number  $-\beta$  of united points, and so on, the theorem is that we have

$$p(\alpha - \alpha' - \alpha') + q(\beta - \beta' - \beta') + \dots = 2kD.$$

The principle of correspondence, or say rather the theorem of united points, is a most powerful instrument of investigation, which may be used in place of analysis for the determination of the number of solutions of almost every geometrical problem. We can by means of it investigate the class of a curve, number of inflexions, etc.,—in fact, Plücker's equations; but it is necessary to take account of special solutions: thus, in one of the most simple instances, in finding the class of a curve, the cusps present themselves as special solutions.

Imagine a curve of order  $m$ , deficiency  $D$ , and let the corresponding points  $P, P'$  be such that the line joining them passes through a given point  $O$ ; this is an  $(m-1, m-1)$  correspondence, and the value of  $k$  is  $-1$ , hence the number of united points is  $-2m - 2 + 2D$ ; the united points are the points of contact of the tangents from  $O$  and (as special solutions) the cusps, and we have thus the relation  $n + \kappa = 2m - 2 + 2D$ ; or writing  $D = \frac{1}{2}(m-1)(m-2) - \delta - \kappa$ , this is  $n = m(m-1) - 2\delta - 3\kappa$ , which is right.

The principle in its original form as applying to a right line was used throughout by Chasles in the investigations on the number of the conics which satisfy given conditions, and on the number of solutions of very many other geometrical problems.

There is one application of the theory of the  $(\alpha, \alpha')$  correspondence between two planes which it is proper to notice.

Imagine a curve, real or imaginary, represented by an equation (involving, it may be, imaginary coefficients) between the Cartesian co-ordinates  $u, u'$ ; then, writing  $u = x + iy, u' = x' + iy'$ , the equation determines real values of  $(x, y)$  and of  $(x', y')$ , corresponding to any given real values of  $(x', y')$  and  $(x, y)$  respectively; that is, it establishes a real correspondence (not of course a rational one) between the points  $(xy)$  and  $(x'y')$ ; for example, in the imaginary circle  $u^2 + u'^2 = (a + bi)^2$ , the correspondence is given by the two equations  $x^2 - y^2 + x'^2 - y'^2 = a^2 - b^2, xy + x'y' = ab$ . We have thus a means of geometrical representation for the portions, as well imaginary as real, of any real or imaginary curve. Considerations such as these have been used for determining the series of values of the independent variable and the irrational functions thereof in the theory of Abelian integrals, but the theory seems to be worthy of further investigation.

The researches of Chasles (*Comptes Rendus*, t. lviii., 1864, et seq.) refer to the conics which satisfy given conditions. There is an earlier paper by De Jonquieres, "Théorèmes généraux concernant les courbes géométriques planes d'un ordre quelconque," *Liouv.*, t. vi. (1861), which establishes the notion of a system of curves (of any order) of the index  $N$ , viz., considering the curves of the order  $n$  which satisfy  $\frac{1}{2}n(n+3) - 1$  conditions, then the index  $N$  is the number of these curves which pass through a given arbitrary point. But Chasles in the first of his papers (February, 1864), considering the conics which satisfy four conditions, establishes the notion of the two characteristics  $(\mu, \nu)$  of such a system of conics, viz.,  $\mu$  is the number of the conics which pass through a given arbitrary point, and  $\nu$  is the number of the conics which touch a given arbitrary line. And he gives the theorem, a system of conics satisfying four conditions, and having the characteristics  $(\mu, \nu)$  contains  $2\nu - \mu$  line-pairs (that is, conics, each of them a pair of lines), and  $2\mu - \nu$  point-pairs (that is, conics, each of them a pair of points,—conics infinitely applanated), which is a fundamental one in the theory. The characteristics of the system can be determined when it is known how many there are of these two kinds of degenerate conics in the system, and how often each is to be counted. It was thus that Zeuthen (in the paper *Nyt Bydrag*, "Contribution to the Theory of Systems of Conics which satisfy four Conditions," Copenhagen, 1865, translated with an addition in the *Nouvelles Annales*) solved the question of finding the characteristics of the systems of conics which satisfy four conditions of contact with a given curve or curves; and this led to the solution of the further problem of finding the number of the conics which satisfy five conditions of contact with a given curve or curves (Cayley, *Comptes Rendus*, t. lxiii., 1866), and "On the Curves which satisfy given Conditions" (*Phil. Trans.* t. clviii. 1868).

It may be remarked that although, as a process of investigation, it is very convenient to seek for the character

istics of a system of conics satisfying 4 conditions, yet what is really determined is in every case the number of the conics which satisfy 5 conditions; the characteristics of the system (4p) of the conics which pass through 4p points are (5p), (4p, 1l), the number of the conics which pass through 5 points, and which pass through 4 points and touch 1 line: and so in other cases. Similarly as regards cubics, or curves of any other order: a cubic depends on 9 constants, and the elementary problems are to find the number of the cubics (9p), (8p, 1l), etc., which pass through 9 points, pass through 8 points and touch 1 line, etc.; but it is in the investigation convenient to seek for the characteristics of the systems of cubics (8p), etc., which satisfy 8 instead of 9 conditions.

The elementary problems in regard to cubics are solved very completely by Maillard in his *Thèse, Recherche des caractéristiques des systèmes élémentaires des courbes planes du troisième ordre* (Paris, 1871). Thus, considering the several cases of a cubic

	No. of consta.
1. With a given cusp.....	5
2. " cusp on given line.....	6
3. " cusp.....	7
4. " a given node.....	6
5. " node on given line.....	7
6. " node.....	8
7. Non-singular.....	9

is determined in every case the characteristics ( $\mu, \nu$ ) of the corresponding systems of cubics (4p), (3p, 1l), etc. The same problems, or most of them, and also the elementary problems in regard to quartics are solved by Zeuthen, who in the elaborate memoir "Almindelige Egenskaber, etc.," *Danish Academy*, t. x. (1873), considers the problem in reference to curves of any order, and applies his results to cubic and quartic curves.

The methods of Maillard and Zeuthen are substantially identical; in each case the question considered is that of finding the characteristics ( $\mu, \nu$ ) of a system of curves by consideration of the special or degenerate forms of the curves included in the system. The quantities which have to be considered are very numerous. Zeuthen in the case of curves of any given order establishes between the characteristics  $\mu, \nu$ , and 18 other quantities, in all 20 quantities, a set of 24 equations (equivalent to 23 independent equations), involving (besides the 20 quantities) other quantities relating to the various forms of the degenerate curves, which supplementary terms he determines, partially for curves of any order, but completely only for quartic curves. It is in the discussion and complete enumeration of the special or degenerate forms of the curves, and of the supplementary terms to which they give rise, that the great difficulty of the question seems to consist; it would appear that the 24 equations are a complete system, and that (subject to a proper determination of the supplementary terms) they contain the solution of the general problem.

The remarks which follow have reference to the analytical theory of the degenerate curves which present themselves in the foregoing problem of the curves which satisfy given conditions.

A curve represented by an equation in point-coordinates may break up: thus, if  $P_1, P_2, \dots$  be rational and integral functions of the co-ordinates ( $x, y, z$ ) of the orders  $m_1, m_2, \dots$  respectively, we have the curve  $P_1^{a_1} P_2^{a_2} \dots = 0$ , of the order  $m = a_1 m_1 + a_2 m_2 + \dots$ , composed of the curve  $P_1 = 0$  taken  $a_1$  times, the curve  $P_2 = 0$  taken  $a_2$  times, etc.

Instead of the equation  $P_1^{a_1} P_2^{a_2} \dots = 0$ , we may start with an equation  $u = 0$ , where  $u$  is a function of the order  $m$  containing a parameter  $\theta$ , and for a particular value, say  $\theta = 0$ , of the parameter reducing itself to  $P_1^{a_1} P_2^{a_2} \dots$ . . . . Supposing  $\theta$  indefinitely small, we have what may be called the penultimate curve, and when  $\theta = 0$  the ultimate curve. Regarding the ultimate curve as derived from a given penultimate curve, we connect with the ultimate curve, and consider as belonging to it certain points called "summits" on the component curves  $P_1 = 0, P_2 = 0$  respectively; a summit  $\Sigma$  is a point such that, drawing from an arbitrary point  $O$  the tangents to the penultimate curve, we have  $O\Sigma$  as the limit of one of these tangents. The ultimate curve, together with its summits, may be regarded as a degenerate form of the curve  $u = 0$ . Observe that the positions of the summits depend on the penultimate curve  $u = 0$ , viz., on the values of the coefficients in the terms multiplied by  $\theta, \theta^2, \dots$ ; they are thus in some measure arbitrary points as regards the ultimate curve  $P_1^{a_1} P_2^{a_2} \dots = 0$ .

It may be added that we have summits only on the component curves  $P_1 = 0$ , of a multiplicity  $a_1 > 1$ ; the number of summits on such a curve is in general  $-(a_1^2 - a_1) m_1^2$ . Thus, assuming that the penultimate curve is without nodes or cusps, the number of the tangents to it is  $-m^2 - m$ ,  $-(a_1 m_1 + a_2 m_2 + \dots)^2 - (a_1 m_1 + a_2 m_2 + \dots)$ , taking  $P_1 = 0$  to have  $a_1$  nodes and  $a_1$  cusps, and therefore its class  $m_1$  to be  $-m_1^2 - a_1 - 2a_1 - 3a_1$ , etc., the expression for the number of tangents to the penultimate curve is

$$-(a_1^2 - a_1) m_1^2 + (a_2^2 - a_2) m_2^2 + \dots + 2a_1 a_2 m_1 m_2 + \dots + a_1(a_1 + 2a_1 + 3a_1) + a_2(a_2 + 2a_2 + 3a_2) + \dots;$$

where a term  $2a_1 a_2 m_1 m_2$  indicates tangents which are in the limit the lines drawn to the intersections of the curves  $P_1 = 0, P_2 = 0$  each line  $2a_1 a_2$  times; a term  $a_1(a_1 + 2a_1 + 3a_1)$  tangents which are in the limit the proper tangents to  $P_1 = 0$  each  $a_1$  times, the lines to its nodes each  $2a_1$  times, and the lines to its cusps each  $3a_1$  times; the remaining terms  $(a_1^2 - a_1) m_1^2 + (a_2^2 - a_2) m_2^2 + \dots$  indicate tangents which are in the limit the lines drawn to the several summits, that is, we have  $(a_1^2 - a_1) m_1^2$  summits on the curve  $P_1 = 0$ , etc.

There is of course a precisely similar theory as regards line-coordinates; taking  $\Pi_1, \Pi_2$ , etc., to be rational and integral functions of the co-ordinates ( $\xi, \eta, \zeta$ ) we connect with the ultimate curve  $\Pi_1^{a_1} \Pi_2^{a_2} \dots = 0$ , and consider as belonging to it certain lines, which for the moment may be called "axes" tangent to the component curves  $\Pi_1 = 0, \Pi_2 = 0$  respectively. Considering an equation in point-coordinates, we may have among the component curves right lines, and if, in order to put these in evidence, we take the equation to be  $L_1 \Pi_1 \dots P_1^{a_1} \dots = 0$ , where  $L_1 = 0$  is a right line,  $P_1 = 0$  a curve of the second or any higher order, then the curve will contain as part of itself summits not exhibited in this equation, but the corresponding line-equation will be  $A_1 \Pi_1 \dots \Pi_1^{a_1} \dots = 0$ , where  $A_1 = 0, \dots$  are the equations of the summits in question,  $\Pi_1 = 0$ , etc., are the line-equations corresponding to the several point-equations  $P_1 = 0$ , etc.; and this curve will contain as part of itself axes not exhibited by this equation, but which are the lines like  $L_1 = 0, \dots$  of the equation in point-coordinates.

In conclusion a little may be said as to curves of double curvature, otherwise twisted curves, or curves in space. The analytical theory by Cartesian co-ordinates was first considered by Clairaut, *Recherches sur les courbes à double courbure* (Paris, 1731). Such a curve may be considered as described by a point, moving in a line which at the same time rotates about the point in a plane which at the same time rotates about the line; the point is a point, the line a tangent, and the plane an osculating plane, of the curve, moreover the line is a generating line, and the plane a tangent plane, of a developable surface or torse, having the curve for its edge of regression. Analogous to the order and class of a plane curve we have the order, rank, and class, of the system (assumed to be a geometrical one), viz., if an arbitrary plane contain  $m$  points, an arbitrary line meets  $r$  lines, and an arbitrary point lies in  $n$  planes, of the system, then  $m, r, n$  are the order, rank, and class respectively. The system has singularities, and there exists between  $m, r, n$  and the numbers of the several singularities equations analogous to Plücker's equations for a plane curve.

It is a leading point in the theory that a curve in space cannot in general be represented by means of two equations  $U = 0, V = 0$ ; the two equations represent surfaces, intersecting in a curve; but there are curves which are not the complete intersection of any two surfaces; thus we have the cubic in space, or skew cubic, which is the residual intersection of two quadric surfaces which have a line in common; the equations  $U = 0, V = 0$  of the two quadric surfaces represent the cubic curve, not by itself, but together with the line. (A. CA.)

CURZOLA (Slavonic, *Karkar*), a city of Dalmatia, Austria, the capital of an island of the same name in the Adriatic, which is situated between 42° 50' and 43° 1' N. lat. and 16° 40' and 17° 20' E. long., and has a length of about 25 miles, with an average breadth of 4 miles. The city is about 55 miles north of Ragusa. It is regularly built, and, besides the old cathedral, the *loggia* or council chambers, and the palace of its former Venetian governor, it possesses the noble mansion of the Arnieri, and other specimens of the domestic architecture of the 15th and 16th centuries, and still retains the massive walls and towers that were erected in 1420. Its principal industry is the building of the boats for which it is famed throughout the Adriatic. Originally, as it would seem, a Phœnician settlement, Curzola was afterwards colonized by Greeks from



*Caidus*; but nothing is known of its earlier history. The present name is a corruption of *Corcyra Nigra*, or *Κέρκυρα Νίγρα*, the designation by which it was known to the Greeks and Romans. In 997 it came under the suzerainty of Venice, and it was one of the earliest cities in Dalmatia to receive municipal rights. In 1571 it defended itself so gallantly against the Turks under Uluch Ali of Algiers that it obtained the designation *Adelissima*. Population, 2300.

CUSA, NICOLAUS DE [NICOLAUS CUSANUS], cardinal (1401-1464), was the son of a poor fisherman named Kruppff or Krebs, and derived the name by which he is known from the place of his birth, Cues or Cusa, on the Moselle, in the archbishopric of Treves. In his youth he was employed in the service of Count Ulrich of Manderscheid, who, seeing in him evidence of exceptional ability, sent him to study at the school of the Brothers of the Common Life at Deventer, and afterwards at the university of Padua, where he took his doctor's degree in law in his twenty-third year. Failing in his first cause he abandoned the legal profession, and resolved to enter the church. After filling several subordinate offices he became archdeacon of Liège. He was a member of the Council of Basel, and dedicated to the assembled fathers a work entitled *De Concordantia Catholica*, in which he maintained the superiority of councils over popes, and assailed the false decretals and the story of the donation of Constantine. A few years later, however, he had reversed his position, and zealously defended the supremacy of the Pope. He was intrusted with various missions in the interests of Catholic unity, the most important being to Constantinople, to endeavor to bring about a union of the Eastern and Western churches. In 1448 he was raised by Pope Nicolas V. to the dignity of cardinal; and in 1450 he was appointed bishop of Brixen against the wish of the Archduke Sigismund, who opposed the reforms the new bishop sought to introduce into the diocese. In 1451 he was sent to Germany and the Netherlands to check ecclesiastical abuses and bring back the monastic life to the original rule of poverty, chastity, and obedience,—a mission which he discharged with well-tempered firmness. Soon afterwards his dispute with the Archduke Sigismund in his own diocese was brought to a point by his claiming certain dues of the bishopric, which the temporal prince had appropriated. Upon this the bishop was imprisoned by the archduke, who, in his turn, was excommunicated by the Pope. These extreme measures were not persisted in; but the dispute remained unsettled at the time of the bishop's death, which occurred at Lodi in Umbria on the 11th August, 1464. In 1459 he had acted as governor of Rome during the absence of his friend Pope Pius II. at the assembly of princes at Milan; and he wrote his *Crebratio Alcorani*, a treatise against Mahometanism, in support of the expedition against the Turks proposed at that assembly. Some time before his death he had founded a hospital in his native place for thirty-three poor persons, the number being that of the years of the earthly life of Christ. To this institution he left his valuable library.

The interest of Cusa for later times lies in his philosophical much more than in his political or ecclesiastical activity. As in religion he is entitled to be called one of the "Reformers before the Reformation," so in philosophy he was one of those who broke with scholasticism while it was still the orthodox system. In his principal work, *De docta ignorantia* (1440), supplemented by *De Conjecturis libri duo*, published in the same year, he maintains that all human knowledge is mere conjecture, and that man's wisdom is to recognize his ignorance. From scepticism he escapes by accepting the doctrine of the mystics that God can be apprehended by intuition (*intuitio, speculatio*), an exalted state of the intellect in which all limitations disappear. God is the absolute maximum and also the absolute minimum, who can be neither greater nor less than He is, and who comprehends all that is or that can be ("deum esse omnia, ut non possit esse aliud quam est"). Cusa thus laid himself open to the charge of pantheism, which did not fail to be brought against him in his own day. His chief philosophical doctrine was taken up and developed more than a hundred years later by Giordano Bruno, who calls him the divine Cusanus. In mathematical and physical science Cusa was much in advance of his age. In a tract, *Reparatio Calendarii*, presented to the Council of Basel, he proposed the reform of the calendar after a method resembling

that adopted by Gregory. If he was not before his own age he was not behind many in the present day in a treatise *De Quadratura Circuli*, in which he professes to have solved the problem; and the same remark applies to a prophecy that the world would come to an end in 1734, which he hazarded in his *Conjectura de novissimis diebus*. Most noteworthy, however, in this connection is the fact that he anticipated Copernicus by maintaining the theory of the rotation of the earth.

The works of Cusanus were published in a complete form by Henri Petri (1 vol. fol. Basel, 1565). See Hartsheim's *Vita Nicolau de Cusa* (Treves, 1730), Martini's *Das Hospital Cusa und dessen Stifter* (Treves, 1841), and Scharpff's *Der Cardinal und Bischof Nic. von Cusa als Reformator in Kirche, Reich, und Philos. des 15. Jahrhunderts*. (Tübingen, 1871).

CUSH, the eldest son of Ham, from whom seems to have been derived the name of the *Land of Cush*, which is commonly rendered by the Septuagint and by the Vulgate *Ethiopia*. The locality of the land of Cush is a question upon which eminent authorities have been divided; for while Bochart maintained that it was exclusively in Arabia, Schulthess and Gesenius held that it is to be sought for nowhere but in Africa. Others again, such as Michaelis and Rosenmüller, have supposed that the name Cush was applied to tracts of country both in Arabia and Africa—a circumstance which would easily be accounted for on the very probable supposition that the descendants of the primitive Cushite tribes emigrated across the Red Sea from the one continent to the other. The existence of an African Cush cannot reasonably be questioned, though the term is employed in Scripture with great latitude, sometimes denoting an extensive but undefined country (Ethiopia), and at other times one particular kingdom (Meroë). It is expressly described by Ezekiel as lying to the south of Egypt beyond Syene; Mizraim and Cush (i. e., Egypt and Ethiopia) are often classed together by the prophets; the inhabitants are elsewhere spoken of in connection with the Lubim and Sukkiim, which were certainly nations of Africa, for they belonged to the vast army with which Shishak, king of Egypt, "came out" against Rehoboam, king of Judah; and, finally, in the ancient Egyptian inscriptions the country to the south of Egypt is called Keesh, or Kesh. Though there is a great lack of evidence to show that the name of Cush was ever applied to any part of Arabia, there seems no reason to doubt that a portion of the Cushite race did early settle there. In the 5th century the Himyarites, in the south of Arabia, were styled by Syrian writers Cusheans and Ethiopians. By modern scholars the name Cushite has been adopted as the designation of the early non-Semitic language of Babylonia; and the reasoning of Canon Rawlinson goes to show that there was a close connection between Babylon and Egypt.

CUSTARD APPLE, a name applied to the fruit of various species of the genus *Anona*, natural order *Anonaceæ*. The members of this genus are shrubs or small trees having alternate, exstipulate leaves, and flowers with three small sepals, six petals arranged in a double row, and numerous stamens. The fruit of *A. reticulata*, the common custard apple, or "bullock's heart" of the West Indies, is dark brown in color, and marked with depressions, which give it a quilted appearance; its pulp is reddish-yellow, sweetish, and very soft; the kernels of the seeds are said to be poisonous. The sour-sop, the fruit of *A. muricata*, grows in the West Indies, and in the neighborhood of Bombay; it is covered with soft prickles, is of a light-greenish hue, and has a peculiar but agreeable sour taste, and a scent resembling that of black currants. The sweet-sop, which is cultivated in both the Indies, is produced by *A. squamosa*; it is an ovate fruit, with a thick rind and luscious pulp. According to Royle, an acrid principle, fatal to insects, is contained in its seeds, which, powdered and mixed with the flour of gram (*Cicer arietinum*), are used by the natives of India in washing the hair. *A. Cherimolia* furnishes the Peruvian Cherimoyer, which is held to be of very superior flavor, and is much esteemed by the Creoles. *A. palustris* is valued in Jamaica for its wood, which serves the same purposes as cork; the fruit, commonly known as the alligator-apple, is not eaten, being reputed to contain a dangerous narcotic principle.

CUSTOMS DUTIES are taxes on the import and export of commodities, and rank among the most ancient, as they continue to prevail as one of the most common modes, in

all countries, of levying revenue for public purposes. In an insular country like the United Kingdom customs duties came in process of time to be levied only or chiefly in the seaports, and thus applied only to the foreign commerce, where they may be brought under the control of fair and reasonable principles of taxation. But this simplification of customs duties was only reached by degrees; and during a long period special customs were levied on goods passing between England and Scotland; and the trade of Ireland with Great Britain and with foreign countries was subjected to fiscal regulations which could not now stand in the light of public reason. The taxes levied, on warrant of some ancient grant or privilege, upon cattle or goods at a bridge or a ferry or other point of passage from one county or province to another, of which there are some lingering remains even in the United Kingdom, and those levied at the gates of cities on the produce of the immediate country—a not uncommon form of municipal taxation on the European continent—are all of the nature of customs dues. It is from the universality of this practice that our English term of "customs" appears to have been derived. In countries of extensive land frontiers the system of taxation by duties on foreign commodities becomes still more complicated. Custom-houses have to be established along the land borders and at particular points on the rivers or the railways; and the foreign and domestic tax-collectors are brought into immediate contact. Some European Governments distinguish in their rates of duty between "dry" or land ports and "wet" or sea ports; and others vary their dues on foreign commodities according to the zones of the globe from which the commodities come. Nothing has consequently been more perplexing to the merchant than customs duties. They are a labyrinth through which he has had to steer with caution and circumspection; while, at the same time, it has offered to the more unscrupulous traders temptations to fraud. The smuggling which proceeds under customs duties is only to be checked by the most careful administration, by a system proceeding as far as possible on the simplicity of generally recognized principles, and by duties so moderate in amount as to reduce to a minimum the temptation of fraud.

A customs duty on the *import* of commodities has to be paid by the domestic consumers of the commodities. The foreign producer will not sell them at less than they cost, and the importing merchant will not bring them in unless he obtain this cost, his own fair profit, and the import duty over and above these essential constituents of the transaction. An import duty is thus in some cases a tax which consumers may pay lightly or heavily as they choose, and has accordingly a flexibility that is not unimportant in taxation. But if the commodity be one of domestic as well as foreign supply, the effect of the customs duty is to raise the price of the domestic supply in some proportion to the duty; and the consumer, in so far as the commodity is one of necessity to him, has no choice. He has to pay the tax, with the further dissatisfaction of knowing that it goes to no public purpose, but only into the pockets of some of his own private neighbors. A customs duty on the *export* of commodities, on the other hand, has to be paid by the foreign consumers, one of the most agreeable forms of taxation to be conceived. But this desire of taxing foreigners for domestic revenue is met by the competition of general commerce, and nations have to be chary of levying duties on the export of the products of their own industry. It is only where they have some special monopoly of the product that they can enter upon such a course without the gravest disadvantage to themselves.

Wherever the principle of free trade is recognized, these distinctions have to be strictly observed; and in the past thirty years' regime of free trade in the United Kingdom, the whole system of customs duties, in its principles, its rates of duty, and its administration, has undergone a complete revolution. Of many hundreds of articles on which customs duty was levied in the seaports, only five or six, of exclusively foreign origin, now remain to yield the customs revenue of the kingdom. Yet this revenue has never declined. It is much larger than when the whole elaborate system of customs duties was in force. The best literature of this interesting subject, apart from the standard works of British, French, and German economists, is to be found in the Budgets of the British Parliament since 1842; in the Acts consolidating and reforming the custom-house admin-

istration, particularly the Act of 1853 drawn by Mr. Wilson, editor of *The Economist*, and then secretary of the treasury; in the reports of the Hon. David Wells, late commissioner of revenue in the United States; and in the annual reports of the British custom-house commissioners, in which also there is a magazine of the most valuable facts. Of recent years the only controversy of the British public with the custom-house relates to what has been deemed the too careless admission of adulterated or worthless commodities, in respect to which there may have to be a further reform in the future. In the case of commodities on which a duty is levied, and must be paid before they pass into consumption, there would seem to be a responsibility on the part of the duty-levying power to ascertain that the commodity is what it is professed to be.

CUSTOS ROTULORUM, in England, is one of the justices of the peace, and keeper of the records for the county. He nominates the clerk of the peace. He is described by Lambard as a "man for the most part especially picked out either for wisdom, countenance, or credit." He is nominated by the royal sign-manual.

CUTCH, or KACHH, a native state in the south-western extremity of Hindustan, situated between 68° and 72° E. long. and 22° and 25° N. lat. It is a peninsular tract of land, inclosed towards the W. by the eastern branch of the Indus, or the Koree, on the S. by the Indian Ocean and the Gulf of Cutch, and on the N. and E., towards the interior, by the great northern *Ran*, or *Ruan*, an extensive salt morass or lake, which from May to October is flooded with salt water, and communicates in its greatest extent with the Gulf of Cutch on the west and the Gulf of Cambay on the east, these two gulfs being united during the monsoon.

The interior of Cutch is studded with hills of considerable elevation, and a range of mountains runs through it from east to west, many of them of the most fantastic shapes, with large insulated masses of rock scattered in all directions. In the intervening valleys the country is not deficient in fertility and verdure, and is sufficiently productive in all cases where the nature of the government permits the cultivator to enjoy the fruits of his labor. But this very seldom happens. Many of the hills are covered with jungle, and with the strongholds and dens of petty chiefs, who sometimes protect, but more frequently issue forth to plunder the lower country. The general appearance of Cutch is barren and uninteresting. The greater part is a rock destitute of soil, and presenting the wildest aspect; the ground is cold, poor, and sterile; the rains are generally scanty, and often fail altogether; and the whole face of the country bears marks of volcanic action. From the violence of tyranny, and the rapine of a disorderly *banditti*, by which this district has from time immemorial been infested, as well as from shocks of earthquakes, the villages have a ruinous and dilapidated appearance; and, with the exception of a few fields in their neighborhood, the country presents a rocky and sandy waste, with in many places scarcely a show of vegetation. Water is scarce and brackish, and is chiefly found at the bottom of low ranges of hills, which abound in some parts; and the inhabitants of the extensive sandy tracts suffer greatly from the want of it. Owing to the uncertainty of the periodical rains in Cutch, the country is liable to severe famines, which, along with the internal broils by which it has been harassed, have greatly obstructed cultivation, and thinned the inhabitants, many of whom have been induced to emigrate to Bombay and Gujara't; and, in addition to all these evils, an uncommonly violent earthquake, which occurred on the 18th of June, 1819, nearly destroyed Bhuj, the capital, and greatly injured the towns of Anjar, Mandavi, and Moondra or Mundra. The soil of Cutch produces grain, cotton, tobacco, ghee, etc.; and iron and coal have been discovered, the latter near the surface of the ground, on the banks of one of the rivers, seven miles north-east of Bhuj, but it is not in general use as fuel.

The *Ran*, or *Runn*, which communicates with the Gulf of Cutch, and sweeps round the northern side of that province, is a very extensive salt morass, varying in breadth from five to eighty miles across, and during the rains nearly impassable for horsemen. The total area of this immense morass may be estimated at about 8000 square miles, without including any portion of the Gulf of Cutch, which is in many parts so shallow as to resemble a marshy fen rather than an arm of the sea. The *Runn* is said to be formed by

the overflow of the rivers Pharan, Lunf, Banás, and others, during the monsoon; but in December it is quite dry, and in most places hard. The wild ass is very common on the borders of this lake, being seen in herds of from 60 to 70 at a time.

The temperature of Cutch during the hot season is high, the thermometer frequently rising to 100° or 105°; and in the months of April and May, clouds of dust and sand, blown about by hurricanes, envelop the houses, the glass windows scarcely affording any protection. For nine months of the year the climate is comparatively temperate and agreeable; but the approach of October is equally dreaded by the native and European population as extremely unhealthy, and at the close of the monsoon the oppression of the atmosphere is described as being intolerable. The influence of the monsoon is greatly moderated before it reaches this region, and the rains sometimes fall altogether; but although in this case the necessary consequences are want and misery to the great body of the people, these dry seasons are far more favorable to the health of Europeans. The monsoon generally sets in with great violence from the north-east before it settles in the south-west. The prevailing wind is westerly, and it blows west by south and west by north ten months in the year. The easterly winds, which do not blow more than a month in the year, are always unhealthy and unpleasant, and bring with them, if they continue long, epidemics and locusts. Cutch is considered unhealthy by the natives of other parts of the country; and Dr. Burnes, who was stationed there, and gives an account of its medical topography, mentions that he has known many persons from Bombay, especially servants, who were perfectly useless from continued sickness in Cutch, but who recovered their health the moment they left it. He also adds, that he never was at any station where recoveries from fever were so tedious and incomplete. The hospital returns do not, however, he adds, show any extraordinary sickness. Cholera has made no progress in Cutch. The most common diseases among the natives are fever and rheumatism; and fever is also the prevailing disease among Europeans, the first attacks of which are always the most dangerous. These, however, are not ordinarily severe, and easily yield to the remedy of sulphate of quinine without any serious injury to the constitution. There are some stations at Cutch particularly noxious, such as Narrona, a village in a marsh 24 miles north-east of Bhuj, near the Runn, and Lakshpat Bandar, remarkable for the badness of its water.

The principal towns are Bhuj, Anjar, Jharrá, Kantkot, and Katáriá. The principal seaports are Mandávi and Mundra. The town best known to Europeans is Bhuj, which is situated inland, and is surrounded by an amphitheatre of hills, some of which approach within three or four miles of the city. The hill of Bhujá, on which the fort is situated, and under the south-west angle of which is the cantonment of the Cutch brigade, rises to the height of 500 feet in the middle of the plain, and is detached from other high ground. The residency is four miles distant in a westerly direction. There are many mountain streams, but no navigable rivers. They scarcely contain any water except in the rainy season, when they are very full and rapid, and discharge themselves into the Runn, all along the coast of which the wells and springs are more or less impregnated with common salt, and other saline ingredients.

Various causes have contributed to thin the population of this country. In 1812 it was ravaged by a famine and pestilence, which destroyed a great proportion of its inhabitants,—according to some accounts, nearly one-half. This, joined to the tyranny and violence of the Government until the year 1819, and more lately to a succession of unfavorable seasons, has forced many of the cultivators to remove to Sind and other countries. The inhabitants may be estimated at 500,000, of whom one-third are Mahometans and the remainder Hindus of various castes. The Jharijá Rájputs form a particular class, being the aristocracy of the country; and all are more or less connected with the family of the Ráo, or prince. There are in Cutch about 200 of these Jharijá chiefs, who all claim their descent from Sacko Goraro, a prince who reigned in Sind about 1000 years ago. From him also the reigning sovereign is lineally descended, and he is the liege lord of whom all the chiefs or nobles hold their lands in feu, for services which they or their ancestors had performed, or

in virtue of their relationship to the family. They are all termed the brotherhood of the Ráo, and supposed to be his hereditary advisers, and their possessions are divided among their male children. To prevent the breaking down of their properties, the necessary consequence of this law of inheritance, there is no doubt that infanticide is common among them, and that it extends to the male as well as the female progeny. The Jharijás consider it unlawful to marry any female of their own tribe, being all descended from a common parent. They accordingly marry into the families of other Rájputs; and to this unfortunate regulation may be chiefly ascribed the destruction of all the female children. The Jharijás have a tradition that when they entered Cutch they were Mahometans, but that they afterward adopted the customs and religion of the Hindus. It is certain, indeed, that they still retain many Mahometan customs. They take oaths equally on the Koran or on the Shastrás; they employ Mussulman books; they eat from their hands; the Ráo, when he appears in public, alternately worships God in a Hindu pagoda and a Mahometan mosque; and he fits out annually at Mandávi a ship for the conveyance of pilgrims to Mecca, who are maintained during the voyage chiefly by the liberality of the prince. The Mahometans in Cutch are of the same degenerate caste with those usually found in the western parts of India. The Míanás form a particular class, who claim the same descent as the Jharijás, and boast of their constancy to the Mahometan creed, while the latter apostatized; but they have now entirely degenerated, and are little better than banditti, always ready to commit outrages, and to sally out in disorderly bands to plunder the defenceless country. Such has been the weakness and tyranny of the rulers of Cutch, that they have frequently had recourse to these wretched auxiliaries in order to aid them in their inordinate exactions, while at other times they recruited the army from the same race. They were nearly extirpated under the rigorous rule of Fathi Muhammad, but of late years they have returned in considerable numbers to their villages among the hills. In the seasons of scarcity of 1823 and 1824, many of them emigrated to Sind, where, joining with other adventurers, they formed disorderly bands, who made forays into Cutch, several villages of which they plundered and burned. The natives are in general of a stronger and stouter make, and even handsomer, than those of Western India; and the women of the higher classes are also handsome. The peasants are described as intelligent, and the artisans are justly celebrated for their ingenuity and mechanical skill. The palace at Mandávi, and a tomb of one of their princes at Bhuj, are fair specimens of their architectural skill. In the manufacture of gold and silver ornaments they display great taste and nicety. The natives of this country are in general peaceable and obedient subjects, for robberies and murders are seldom committed except by the Míanás. The quantity of opium which they use is enormous; its effects, according to Dr. Burnes, are less deleterious to their constitution than might be supposed.

*History.*—The country of Cutch was invaded about the 9th century by a body of Mahometans of the Summa tribe, who under the guidance of five brothers emigrated from Sind, and who gradually subdued or expelled the original inhabitants, consisting of three distinct races. The descendants of these five leaders assumed the name of Jharijá, from a chief named Jharrá, who set an example of female infanticide by putting to death his seven daughters in one day. Cutch continued tranquil under their sway for many years, until some family quarrel arose, in which the chief of an elder branch of the tribe was murdered by a rival brother. His son fled to Ahmadábád to seek the assistance of the viceroy, who was married to his sister, and who reinstated him in the sovereignty of Cutch, and Murvi in Káthiáwár, in the title of Ráo, or Rawul, in the year 1519.

The succession continued in the same line from the time of this prince until 1666, when a younger brother, Práçji, murdered his elder brother and usurped the sovereignty. This line of princes continued till 1760 without any remarkable event, when, in the reign of Ráo Gor, the country was invaded four times by the Sinds, who wasted it with fire and sword. The reign of this prince, as well as that of his son Ráo Rabiden, by whom he was succeeded in 1778, was marked by cruelty and blood. The latter prince was dethroned, and, being in a state of mental derangement, was during his lifetime confined by Fathi Muhammad, a native of Sind, who continued, with a short interval (in which the party of the legal heir, Bhsíji Bawa, gained the ascendancy), to rule the country until his death in

1818. It was in the reign of Fathi Muhammad that a communication first took place with the British Government. During the contests for the sovereignty between the usurper and the legal heir, the leader of the royal party, Hansráj, the governor of Mandávi, sought the aid of the British. But no closer connection followed at that time than an agreement for the suppression of piracy, or of inroads of troops to the eastward of the Runn, or Gulf of Cutch. But the Gulf continued notwithstanding to swarm with pirates, who were openly encouraged or connived at by the son of Hansráj, who had succeeded his father, as well as by Fathi Muhammad. The latter left several sons by different wives, who were competitors for the vacant throne. Husáin Miyán succeeded to a considerable portion of his father's property and power. Jugjevan, a Bráhmaṇ, the late minister of Fathi Muhammad, also received a considerable share of influence; and the hatred of these two factions was embittered by religious animosities, the one being Hindu and the other Mahometan. The late Ráo had declared himself a Mahometan, and his adherents were preparing to inter his body in a magnificent tomb, when the Jharjás and other Hindus seized the corpse and consigned it to the flames, according to Hindu custom.

The administration of affairs was nominally in the hands of Husáin Miyán and his brother Ibráhim Miyán. Many sanguinary broils now ensued, in the course of which Jugjevan was murdered, and the executive authority was much weakened by the usurpations of the Arabs and other chiefs. In the meantime Ibráhim Miyán was assassinated; and after various other scenes of anarchy, the Ráo Bharmulji, son of Ráo Rahiden, by general consent, assumed the chief power. But his reign was one continued series of the grossest enormities; his hostility to the British became evident, and accordingly a force of 10,500 men crossed the Runn in November, 1818, and were within five miles of Bhuj, the capital of the country, when a treaty was concluded, by which the Ráo Bharmulji was confirmed in his title to the throne, on agreeing, among other stipulations, to cede Anjar and its dependencies in perpetuity to the British. He was, however, so far from fulfilling the terms of this treaty that it was determined to depose him; and an army being sent against him, he surrendered to the British, who made a provision for his maintenance, and elevated his infant son to the throne.

In 1822 the relations subsisting between the ruler of Cutch and the British were modified by a new treaty, under which the territorial cessions made by the Ráo in 1816 were restored in consideration of an annual payment. The sum fixed was subsequently thought too large, and in 1832 the arrears, amounting to a considerable sum, were remitted, and all future payments on this account relinquished. From that time the Ráo has paid a subsidy of £20,000 per annum to the British for the maintenance of the military force stationed within his dominions. Suttees has been prohibited in Cutch; and, under British influence, various other measures of a salutary and beneficent character have been adopted.

**CUTCH GUNDAVA**, a district in the province of Baluchistan, situated at the bottom of the mountains lying south-east of Khelat, between 27° 40' and 29° 50' N. lat. and 67° 20' and 69° 17' E. long. It is about 150 miles in length, and measures nearly an equal distance in its greatest breadth. The Hala range of mountains extends along its western frontier, and forms the eastern wall or face of the elevated table-land of central Baluchistan. Through this range are two great passes,—the celebrated Bolan Pass in the north leading in a north-westerly direction, and the Mula Pass, which, more to the south, takes an extensive circuit, the two extremities pointing towards the north, and the convexity towards the south. The soil is rich, black, and loamy, and produces every species of grain, as also cotton, indigo, madder, and other commodities. The rains are heavy in June, July, and August; it rains also, but not so heavily, in the spring months. The climate during the summer is unhealthy, owing to the simoom or pestilential wind which blows at that time, causing the death of many of the inhabitants. Great quantities of grain are exported from this district to the seaports of Kurrachee and Sonmiani. Cutch Gundava is the most populous part of Baluchistan, and constitutes the most valuable portion of the dominions of the Khan of Khelat, who during winter resides at the chief town.

**CUTHBERT**, St. (...-687). The precise date and place of the birth of Cuthbert are unknown. Some writers assert that he was born in Ireland. It is much more probable, or rather it is almost certain, that he was of English descent, and born in that part of the kingdom of Northumbria which lay north of the Tweed, and was afterwards included in the Scottish kingdom. The original abbey of Melrose—to be distinguished from the later Cistercian foundation of that name, which lies higher up

the Tweed—had been founded before the middle of the 7th century. The first abbot was Eata, one of the twelve English disciples of the Scottish Aidan; and under him Cuthbert, then probably in early youth, became a monk. He accompanied Eata on the latter being appointed superior of the monastery at Ripon, founded by Alchfrid, son of Oswy, king of Northumbria. When the dispute arose between the English and Scottish ecclesiastics as to the proper time of keeping Easter, Eata, rather than conform to the English usage, returned to Melrose along with Cuthbert, who soon afterwards was appointed prior of that monastery. Eata having subsequently adopted the English rule was appointed abbot of Lindisfarne by king Oswy, and Cuthbert, still accompanying him, held the office of prior. Under the influence of that intense desire to lead a life of absolute solitude by which the Scottish monks of the school of St. Columba were so frequently impelled, Cuthbert, after a residence of considerable duration at Lindisfarne, resigned his office and retired to the neighboring island of Farne. From this seclusion Egfrid, king of Northumbria, endeavored to recall him. Cuthbert at first resisted the king's entreaties, but was at last induced to comply and to become bishop of Lindisfarne. He was consecrated at York during the Easter festival of 685 by Theodore, archbishop of Canterbury. After exercising his episcopal office for two years he again retired to his solitude of Farne, where he died on the 20th of March, 687.

During his lifetime Cuthbert had been revered as a saint, a reverence which his holy life and faithful discharge of all his duties had well deserved. His austere and secluded mode of living added greatly to the estimation in which he was held, and as usual at that period the performance of miracles was freely ascribed to him. Two accounts of his life were written within a short time after his decease, one by an unknown author, the other by the most distinguished ecclesiastic of the age—the Venerable Bede. They give an interesting account of Cuthbert while prior of Melrose. His labors were not confined to his monastery. He went about the country, sometimes on horseback, but more frequently on foot, preaching to the rude people, and instructing them in their religious duties, following in all respects the example of St. Aidan and the other early Scottish missionaries. When bishop of Lindisfarne he continued to act in the same manner, as well knowing, to use the words of Bede, that "He who said, Thou shalt love the Lord thy God, also said, Thou shalt love thy neighbor as thyself."

The fame of Cuthbert increased as time went on, and excelled that of all the saints of the north. His remains were preserved at Lindisfarne as the most precious treasure of the church; and, when the island towards the end of the 9th century was attacked by the heathen Danes, the monks fled carrying the relics with them, which were finally deposited at Durham, when that city became the seat of the Northumbrian bishopric. During the Middle Ages his shrine at Durham was almost as famous as that of St. Thomas at Canterbury, and attracted the visits of innumerable pilgrims. The English army rallied round the banner of St. Cuthbert at the battle of Neville's Cross, and it is said to have been carried for the last time at the rising known as the Pilgrimage of Grace in the reign of Henry VIII. When the whole mediæval system was beginning to crumble and after its entire overthrow, the popular reverence for his name did not cease in his own northern region. The last Roman Catholic bishop of Durham, and not the least famous of his line, was Cuthbert Tunstall; and in the present century one of our most renowned seamen was Cuthbert Collingwood, the friend and colleague of Nelson.

The original authorities for the life of St. Cuthbert are the two biographies already referred to and the notices in Bede's *Ecclesiastical History*. Bede mentions that what he wrote, whether in the history or in the life, was derived from the records of the monastery of Lindisfarne, or from the testimony of those to whom Cuthbert was personally known. (a. c.)

**CUTLERY** (French *coutellerie*, from the Latin *castrum*, a knife) is a branch of industry which originally embraced the manufacture of all cutting implements of whatever form or material. The progress of manufacturing industry has, however, detached from it the fabrication of several kinds of edge-tools, saws, and similar implements, the manufacture of which is now regarded as distinct branches of trade. On the other hand, modern cutlery includes a great

number of articles which are not strictly cutting implements, but which, owing to their more or less intimate relation to table or pocket cutlery, are classed with such articles for convenience's sake. A fork, for example, is an important article of cutlery, although it is not a cutting tool, and silver or German silver forks in no way answer to the common definition of cutlery, as "cutting implements made of steel."

The original cutting instruments used by the human race consisted of fragments of flint, obsidian, or similar stones, rudely flaked or chipped to a cutting edge; and of these tools numerous remains yet exist. Stone knives and other tools must have been employed for a long period by the prehistoric races of mankind, as their later productions show great perfection of form and finish. In the Bronze period, which succeeded the Stone age, the cutlery of our ancestors was fabricated of that alloy. The use of iron was introduced at a later but still remote period; and it now, in the form of steel, is the staple article from which cutlery is manufactured.

From the earliest period in English history the manufacture of cutlery has been peculiarly associated with the town of Sheffield, and at the present day that town not only practically monopolizes the ordinary cutlery trade of Great Britain, but undoubtedly remains the chief centre of the industry for the whole world. The prominence of the manufacture in his own age is attested by Chaucer, who says of the whittler of Trompington—

"A Shefeld thwytel bare he in his hose."

The thwytel or whittle of that period was a very poor rude implement, consisting of a blade of bar-steel fastened into a wooden or horn handle. It was used for cutting food as well as for the numerous miscellaneous duties which now fall to the pocket-knife. To the whittle succeeded the jack-knife,—the Jacques-de-Liège, or Jock-te-leg of the Scottish James VI.,—which formed the prototype of the modern clasp-knife, inasmuch as the blade closed into a groove in the handle. This improved form was probably introduced to Sheffield by Protestant refugees from the Low Countries who came to England during the reign of Queen Elizabeth. Shortly thereafter, about the beginning of the 17th century, the pocket-knife with spring back was introduced, and no marked improvement thereafter took place till the early part of the present century. In 1624, two centuries after the incorporation of the Cutlers' Company of London, the cutlers of Hallamshire—the name of the district of which Sheffield is the centre—were formed into a body corporate for the protection of the "industry, labor, and reputation" of the trade, which was being disgraced by the "deceitful and unworkmanlike wares of various persons." The Act of incorporation specifies the manufacture of "knives, scissors, shears, sickles, and other cutlery," and provides that all persons engaged in the business shall "make the edge of all steel implements manufactured by them of steel, and steel only, and shall strike on their wares such mark, and such only, as should be assigned to them by the officers of the said company." Notwithstanding these regulations, and the pains and penalties attached to their infringement, the corporation was not very successful in maintaining the high character of Sheffield wares. Most manufacturers made cutlery to the order of their customers, on which the name of the retailer was stamped, and very inferior malleable or cast iron blades went forth to the public with "London made," "best steel," and other falsehoods stamped on them to order. The corporate mark and name of a few firms, among which Joseph Rodgers & Sons stand foremost, are a guarantee of the very highest excellence of material and finish; and such firms decline to stamp any name or mark other than their own on their manufactures. In foreign markets, however, the reputation of such firms is much injured by impudent forgeries; and so far was this system of fraud carried that inferior-foreign work was forwarded to London to be transhipped and sent abroad ostensibly as English cutlery. To protect the trade against frauds of this class the Trades Mark Act of 1862 was passed chiefly on the instigation of the Sheffield Chamber of Commerce.

Sword cutlery, which embraces the manufacture of all military cutting weapons, has always been a distinct branch of trade, and it attained great perfection long before much attention was bestowed upon the tools appertaining to the arts of peace. Damascus blades, with their peculiar variegated watered appearance and their unequalled excellence

of metal, have possessed from an early period the highest reputation, and the method by which it structure was produced was long a matter of speculation. The following remarks by Dr. Percy (*Metallurgy—Iron and Steel*) explain the method by which Damascus or damask work is produced:—

"The damasked portion is due to the difference in coloration, resulting from the action of acids on iron and steel, the surface of the former being left with a metallic tissue, and that of the latter being left coated with a black firmly adherent carbonaceous residue. By suitably piling together bars of steel and iron, welding them, and then drawing them out under the hammer, or otherwise, patterns of various kinds may be produced, just as is done in the case of glass, by heating together variously colored pieces of glass, and drawing them out into rods."

The sword-blades of Toledo, and the workmanship of Andrea de Ferrara in the 16th century, were also triumphs of metal-work. While Sheffield is now the great centre of the manufacture of ordinary cutlery, Birmingham occupies the leading place in the sword cutlery department; but the sword and its cogeners do not now hold the important position either in civil or in military life which they occupied in earlier ages.

The variety of materials which go to complete any single article of cutlery is very considerable; and as the stock-list of a cutler embraces a vast number of articles different in form, properties, and uses, the master cutler must have a practical knowledge of a wide range of substances. The leading articles of the trade may be classed under—1st, domestic cutlery, which includes carving and table knives and forks, pocket or clasp knives, razors, scissors, and similar articles; and 2d, tool cutlery, under which head may be arranged surgical knives and lancets, butchers' and shoemakers' knives, gardeners' pruning-knives, etc., sickles, scythes, and a vast number of other allied cutting implements. The blades or cutting portions of a certain number of these articles are made of shear steel, and for others cast steel only is employed. Sometimes the cutting edge alone is of steel, backed or strengthened with malleable iron, to which it is welded. Tangs on which handles are fastened, and other non-cutting portions, are also very often of malleable iron. Brass, German silver, silver, horn, tortoise-shell, ivory, bone, mother-of-pearl, and numerous fancy woods are all brought into requisition for handles and other parts of cutlery, each demanding special treatment according to its nature. The essential processes in making a piece of steel cutlery are—1st forging; 2d, hardening and tempering; 3d, grinding; and 4th, polishing; and to these of course are added the diverse operations of fitting and handling of various kinds.

The following outline of the stages in the manufacture of a razor will serve to indicate the sequence of operations in making an article which, though simple in form, demands the highest care and skill in the departments which strictly appertain to cutlery. The first essential of a good razor is that it be made of the finest quality of cast steel. A razor must further, according to Mr. Ebenezer Rhodes, a practical cutler, who writes an *Essay on the Manufacture of a Razor*, present "due proportion, form, temperature, fitness, and regularity of concavity." The steel for razors is obtained in bars half an inch in breadth, and the thickness of the back of the instrument. Such a bar the forger takes, and, heating one end of it to the proper forging temperature, he, with great dexterity, fashions it upon his anvil, giving it roughly the required form, edge, and concavity. It is then separated from the remainder of the bar, leaving only sufficient metal to form the tang, if that is to be made of steel; sometimes a tang of malleable iron is welded to the blade. The tang of the "mould," as the blade in this condition is termed, is next drawn out, and the whole "smithed" or beaten on the anvil to compact the metal and improve the form and edge of the razor. At this stage the razor is said to be "forged in the rough," and so neatly can some workmen finish off this operation that a shaving edge may be given to the blade by simple whetting. The forged blade is next "shaped" by grinding on the dry stone, in which operation it is considerably reduced in weight, and the oxidized scale is removed, which allows the hardening and tempering to be done with certainty and proper effect. The shaped razor is now returned to the forge, where the tang is file-cut and pierced with the joint-hole, and into the blade is stamped either the name and corporate mark of the maker, or any mark and name ordered by the tradesman

for whom the goods are being manufactured. The hardening is accomplished by heating the blade to a cherry-red heat and suddenly quenching it in cold water, which leaves the metal excessively hard and brittle. To bring it to the proper temper for a razor, it is again heated till the metallic surface assumes a straw color, and upon plunging it into water, it is ready for the process of wet grinding. The wet grinding is done on stones which vary in diameter from 4 to 12 inches according to the concavity of surface desired. The stones recommended by Mr. Rhodes are from 6 to 8 inches in diameter, which produce, he says, "razors sufficiently hollowed or ground out for any service however hard, to which they may be applied; and they combine a desirable strength and firmness of edge, with a requisite degree of thinness." "Lapping," which is the first stage in polishing, is performed on a wheel of the same diameter as the wet-grinding stone. The lap is built up of segments of wood having the fibres towards the periphery, and covered with a metallic alloy of tin and lead. The lap is fed with a mixture of emery powder and oil. "Glazing" and "polishing," which follow, are for perfecting the polish on the surface of the razor, leather-covered wheels with fine emery being used; and the work is finished off with crocus. The finished blade is then riveted into the scales or handle, which may be of ivory, bone, horn, or other material; and when thereafter the razor is set on a hone it is ready for use.

The processes employed in making a table knife do not differ essentially from those required for a razor. Knife blades are made from shear steel, and, after forging the blade, a piece of malleable iron sufficient for the bolster or shoulder and tang is welded to it. The bolster is formed with the aid of a die and swage called "prints," and the tang is drawn out. The tang is variously formed, according to the method by which it is to be secured in the shaft, and the various processes of tempering, wet grinding, and polishing are pursued as described above. Steel forks of an inferior quality are cast and subsequently cleaned and polished, but the best quality are forged from bar steel, and the prongs are cut or stamped out of an extended flattened extremity called the mould or "mood." In the United States of America machinery has been extensively adapted for performing the various mechanical operations in forging and fitting table cutlery, and to some extent machines have been introduced in Sheffield. In the making of a common pocket-knife with three blades not fewer than one hundred separate operations are involved, and these may be performed by as many workmen. The diversity of quality and workmanship is probably greater in the cutlery trade than in any other, although differences are not readily apparent to the unskilled critic, and the range of prices is correspondingly wide.

In the cutlery trade the division of labor is carried out to such an extreme degree as to exercise a very baneful influence on the operatives—who, as a class, are socially and morally inferior to many of their fellows. Cutlery grinding, which is one of the most important and distinctive departments of the trade, possesses the bad eminence of being one of the most unhealthy and deleterious of all occupations. Grinders are divided into three classes—dry, wet, and mixed grinders, according as they work at dry or wet stones. This branch of trade is in Sheffield, conducted in distinct establishments called "wheels," which are divided up into separate apartments or "hulls," dry grinding being as much as possible separated from the wet grinding. Dry grinding, such as is practised in the shaping of razors described above, the "humping," or rounding of scissors, and other operations, is by far the most injurious and fatal process. Red-hot particles of steel fly off, injuring and sometimes blinding the eyes, unless they are protected; and the atmosphere is loaded with fine dust of silica and steel, inducing inflammation of the lungs, pleurisy, and grinders' asthma. The men work in a peculiarly constrained position, and under highly unsanitary conditions; and although a fan has been invented and extensively introduced which, placed behind the stones, by suction draws away a large proportion of the grinding dust, and renders the atmosphere comparatively pure, many grinders still neglect to keep it working or positively refuse to have it. In a communication to the Social Science Association (Sheffield meeting, 1865), Dr. John C. Hall stated that there were then 3090 men and 1073 boys employed in grinding,—wet, dry, and mixed. "The average age of all the

fork grinders living," he says, "does not exceed 29, scissors grinders, 32; edge tool and wool-shear grinders, 33; table-knife grinders, 35. . . . On taking down the ages of all the grinders—wet, mixed, and dry—at one of our largest wheels, I found the average 34; boys under 21 were excluded from this calculation." Dr. Hall gives the accompanying table of the ages of 290 men over 21 years of age employed in razor grinding:—

Ages.	Persons.	Ages.	Persons.
21 to 25	83	45 to 50	29
25 " 30	57	50 " 55	9
30 " 35	36	55 " 60	8
35 " 40	35	60 " 65	3
40 " 45	29	65 " 75	1

The operation of the Factories and Workshops Acts has, in recent years, exercised a beneficial influence on the health of the grinding trade; and the more general use of the fan in dry grinding has considerably reduced the excessive mortality among the operatives. (J. P.A.)

CUTTACK. See CATTACK.

CUTTLE-FISH. The cuttle-fishes are the "Dinten fische" of the Germans and the "Seiches" of the French, and they constitute the most highly-organized members of the class of the *Cephalopoda*. The great class of animals now known to naturalists under the name of *Cephalopoda* was fully recognized by Aristotle as a well-marked division of animals, under the name of *Malakia*. Even at the early period at which he lived (384–322 B.C.), this acute observer recognized at least nine species of *Cephalopods*—including the Argonaut and the Pearly Nautilus; and he also recorded the singular phenomena of reproduction, phenomena which were not scientifically confirmed and fully established till the year 1850, by the researches of Veray and H. Müller. The other classical writers (e.g., Pliny) added nothing to Aristotle's observations. The next contribution of importance to the elucidation of the history of the *Cephalopods* was made by Rumph (1705) in his *Herleit-Kamer*, describing the curiosities of Amboyna. The old Dutch naturalist gives in this work an account of the structure and habits of the Pearly Nautilus, which, though long discredited, is now known to be in the main correct, and which is accompanied by a fair figure of the soft parts of the animal. The relations of various fossil forms (such as Ammonites) to the *Cephalopoda* were first recognized in the earlier portion of the 18th century; and Breyner (1732) detected the true affinities of the Belemnite. Linnaeus gives a summary of the knowledge of his time as to these animals, but separates the naked from the testaceous forms. The first establishment of the class *Cephalopoda*, however, as a definite natural group, is due to the genius of Cuvier (1798), to which we also owe this now universally accepted name. Cuvier's researches on this subject are contained in his *Leçons d'Anat. Comparée* (1799–1805), and were subsequently republished in an enlarged form in his *Mémoires sur les Cephalopodes et leur Anatomie* (1817). Since the appearance of this classical work, our knowledge of the natural history of the *Cephalopods* has been immensely increased by the researches of Delle Chiaje, Meckel, Von Siebold, De Blainville, Owen, Van Beneden, Peters, Van der Hoeven, Gray, Huxley, A. Hancock, Milne-Edwards, Kölliker, H. Müller, Leuckart, Steenstrup, Keferstein, Férussac, D'Orbigny, etc.; and, as regards fossil forms, by Buckland, D'Orbigny, Quesnelt, Opper, Owen, Huxley, Phillips, Von Buch, Münster, Barande, Von Hauer, Von Meyer, Hyatt, Hall, Meek, and many other paleontologists. One of the principal steps in advance upon the knowledge possessed by Cuvier was taken in 1835, when Dujardin showed that the *Foraminifers*, previously included by Plancus, Soldani, Fichtel, Linnaeus, and others in the *Cephalopoda*, were in reality of a much lower grade of organization, and were not systematically related to the true *Mollusca*.

The class *Cephalopoda* comprises *Mollusca* in which there is a distinct head, and a toothed "tongue" or "odontophore," whilst the hinder extremity of the body is enclosed in a muscular mantle-sac, which may or may not secrete an external shell. The mouth is placed near the centre of the "foot," and the margins of this structure are split up into 8 (Octopod Cuttle-fishes), 10 (Decapod Cuttle-fishes), or numerous (Pearly Nautilus) muscular processes, or "arms." The lateral margins of the foot ("epipodia") constitute, by apposition or fusion, a muscular tube (the "funnel") through which the effete water of respiration is expelled.

The class *Cephalopoda* is divided into the two great orders of the *Tetrabranchiata* and the *Dibranchiata*.

The *Tetrabranchiate* order comprises only the living species, or varieties, of the Pearly Nautilus (*Nautilus pompilius*), along with a vast number of fossil forms, and is characterized by the possession of an external, many-chambered, siphunculate shell; by the presence of numerous arms, which are devoid of suckers; by the possession of four branchiæ; by the absence of an ink-sac; and by the fact that the "funnel" does not form a complete tube.

The order *Dibranchiata*, with which alone we are concerned here, comprises the true cuttle-fishes, in which there are either 8 or 10 arms, provided with suctorial discs; there is no external shell, or, in the single case in which such a structure is present (the female Argonaut), it is single-chambered, and is not secreted by the mantle; there are only two branchiæ; an ink-sac is present; and the "funnel" forms a complete tube.

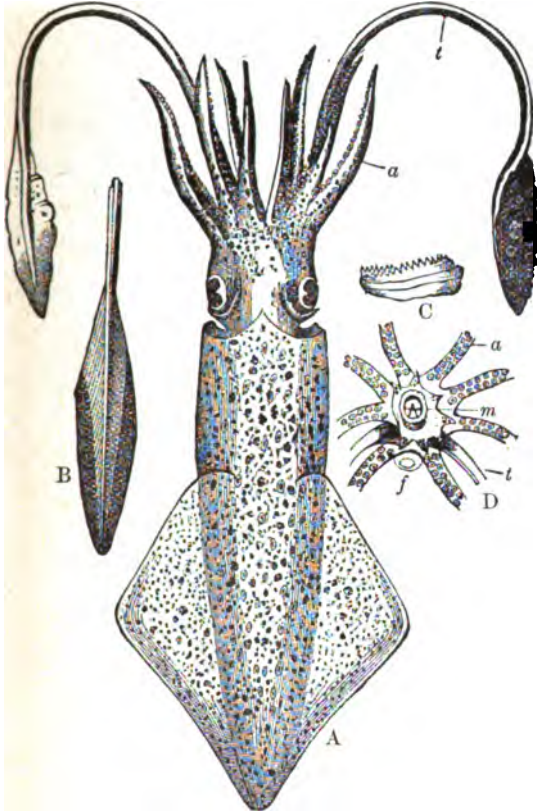

FIG. 1.—A, *Loligo vulgaris*; a, arms; t, tentacle. B., pen of the same reduced in size; C, side view of one of the suckers, showing the horny hooks surrounding the margin; D, view of the head from in front, showing the arms (a), the tentacles (t), the mouth (m), and the funnel (f).

The body of a cuttle-fish is symmetrical, and is divisible into an anterior cephalic portion (*prosome*) and a posterior abdominal portion (*metasoma*). The former of these is developed into a distinct head furnished on its sides with large and prominent eyes, and having the mouth in the centre of its anterior surface, surrounded by eight or ten "arms." The latter incloses the various viscera, and is enveloped in an integumentary sac, which corresponds to the "mantle" ("pallium") of the Gasteropods and Lamellibranchs. The mantle-sac is formed by the coalescence of the two pallial lobes along the ventral surface of the body, and it is attached directly to the metasoma along the dorsal surface, whilst it is free inferiorly, and incloses a space (the "pallial chamber") which contains the gills, and into which the intestine and the ducts of the generative organs and ink-sac open.

The integument of the cuttle-fishes consists of several layers, of which the most important is one which corresponds to the lowermost layer of the epidermis, and which is distinguished by the possession of numerous large-sized cells filled with pigment-granules ("chromatophores").

These pigment-cells are capable of expanding and contracting in their dimensions, and of altering in shape, and below them are other flattened nucleated refracting cells, which co-operate with the former in the production of the marvellous play of changing colors which the cuttle-fishes exhibit under excitement or irritation.

The muscular system of the cuttle-fishes is well developed, the fibres being long and spindle-shaped, and only in certain situations (e. g., in the branchial hearts) transversely striated. The mantle is in all highly muscular, but the most important muscular organs are the "arms," the "tentacles," the "fins," and the "funnel." The "arms" are long processes produced by the splitting up of the antero-lateral margins of the foot, and the mouth is placed in the centre of their bases. In all the cuttle-fishes eight arms are present, but the so-called *Decapods* have in addition the "tentacles," whilst the *Octopods* are devoid of these supplementary processes. The arms are longer or shorter pointed processes, formed principally of longitudinal muscles, with well-marked radial bundles of fibres, and having a nerve and an artery occupying the axis of each. They are placed symmetrically round the mouth; forming a dorsal pair, a ventral pair, and two lateral pairs on each side; and their bases are connected by an inter-brachial membrane, which in some instances (*Cirrotheuthis*) extends nearly to their points. On the inner surface of the arms are placed the suckers ("acetabula"), in the form of muscular cup-like discs, which may be sessile or stalked, and which are arranged generally in one or two, or rarely in four rows. Each acetabulum consists of a cup, the margin of which is formed by a muscular ring, sometimes strengthened by a horny girdle (which may be smooth or may be produced into teeth), whilst its centre is occupied by an elevated papilla composed mainly of radial muscular fibres. When the sucker is applied to any object, the contraction of the muscular fibres causes the depression of this muscular papilla, and creates a partial vacuum, thus enabling each sucker to act as a most efficient organ of prehension—their action being sometimes supplemented (as in *Onychoteuthis*) by the conversion of the central papilla into a horny hook. The so-called "tentacles" of the *Decapod* cuttle-fishes resemble the true arms in structure, but are very much longer, and only carry suckers on their swollen and club-shaped extremities. They are placed on the ventral surface of the animal, between the third and fourth pairs of arms (counting from the middle line of the back); they may or may not be retractile into pouches placed below the eyes, and they may attain a length many times greater than that of the body itself. The tentacles are organs of prehension, and the arms are in addition employed by the animal in locomotion, enabling it to walk head downwards, at the bottom of the sea, or, when webbed, to swim through the water in a retrograde manner. One of the arms of the male cuttle-fishes, as will subsequently appear, is also more or less largely engaged in the work of reproduction, and may for this reason be greatly modified.

The sides of the body in all the *Decapod* cuttle-fishes, and in a few of the *Octopods* (e. g., *Pinnoctopus*), are more or less extensively produced into muscular expansions or fins, supported internally by a cartilaginous basis. These fins are employed by the animal in swimming head foremost, and they may extend along the whole length of the metasoma (as in *Sepia*), or they may be confined to the hinder end of the body (as in *Loligo*, *Cheirotheuthis*, *Onychoteuthis*, etc.).

The "funnel" of the cuttle-fishes is a muscular tube, formed by the union of the "epipodia," and placed on the lower surface of the body, with its anterior extremity projecting beyond the mantle, whilst it opens posteriorly into the pallial chamber. It serves for the extrusion (by means of the outgoing respiratory currents) of the undigested portions of the food and of the excretions of the kidneys and ink-sac; whilst the water which has passed over the gills is expelled through it in a succession of jets, subserving in this way the secondary purpose of driving the animal backwards through the water.

As regards the digestive system, the mouth is placed centrally, surrounded by the bases of the arms, and it conducts into a powerfully muscular buccal cavity, in which are contained two strong horny jaws and a well-developed "tongue." The jaws, or "mandibles," are purely horny (not partially calcareous, as in the Pearly Nautilus), and they have very much the form of a parrot's beak, working

vertically, the lower one projecting most and receiving the upper mandible within it in the act of biting. The so-called "tongue" is a muscular organ, part of which is covered with numerous papillæ, and is apparently an organ of taste; whilst another portion is developed into a lingual ribbon, essentially similar in its structure to the "odontophore" of the *Gasteropoda*. The œsophagus—sometimes simple (*Decapoda*), sometimes provided with proventricular or crop-like dilatations (*Octopoda*)—conducts from the buccal chamber to the stomach, the latter organ being of large size, highly muscular, of a generally rounded shape, and having appended to its pyloric extremity a capacious diverticulum, into which the bile-ducts open. Into the œsophagus open the ducts of one or two pairs of salivary glands, and the liver is of large size and highly developed, whilst certain glandular structures which pour their secretion into the bile-ducts are believed to represent the pancreas. The intestine is usually short, mostly of nearly uniform calibre, straight or slightly convoluted, and terminates in an anal aperture placed in the median line of the pallial chamber, close to the base of the funnel.

The *excretory organs* of the cuttle-fishes are the kidneys and the ink-sac, and the integumentary sinuses in connec-

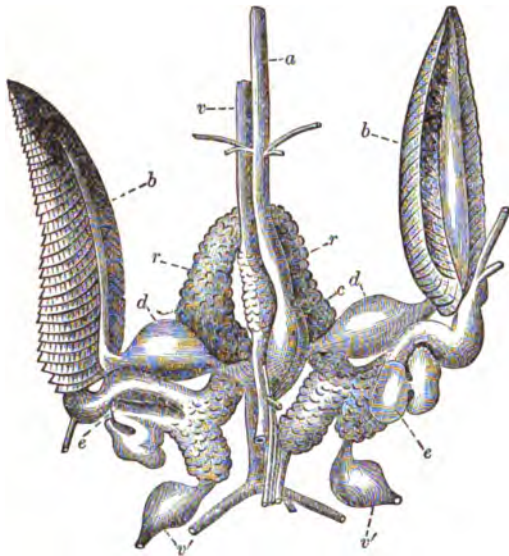

FIG. 2.—Central organs of the circulation, gills, and renal organs of *Sepia officinalis* (after John Hunter). *a*, aorta; *v*, vena cava; *r*, *r*, renal organs; *c*, systemic heart; *d*, *d*, dilations of branchial veins on entering the heart; *e*, *c*, branchial hearts; *b*, *b*, branchiæ; *r*, *r*, renal organs.

tion with the so-called "aquiferous pores" may possibly also have an excretory function. The kidneys (*r*, *r*, fig. 2) are spongy, cellular, tufted, or massive organs appended to the two posterior branches of the vena cava, and sometimes developed on others of the principal veins, just before they open into the branchial hearts. They are contained, along with the veins to which they are attached, and the corresponding branchial heart on each side, in two serous sacs, which are separated centrally by the chamber containing the systemic heart, and which open by distinct apertures into the pallial chamber. The renal appendices are in direct communication with the veins on which they are situated, and have the form of membranous, often plicated, sacs, covered externally with a layer of glandular cells, which secrete a yellowish fluid. This fluid escapes into the serous sacs surrounding the kidneys, and is thence expelled into the mantle-cavity by the apertures before mentioned. The identity of this fluid with the renal secretion of the higher animals is shown by its containing uric acid, as proved by Harless.

The ink-sac is a glandular organ, present in all known Dibranchiates, generally of a pyriform shape, situated in different portions of the visceral chamber, but communicating by a longer or shorter duct either with the terminal portion of the intestine, or, more commonly, directly with the pallial cavity by a special aperture of its own, situated

close beside the anus and at the base of the funnel. The ink-sac has strong fibrous walls, often with a silvery lustre, and its secretion is a brown or black fluid, containing a large amount of a carbonaceous pigment ("sepia"), along with various mineral salts. It is employed by the cuttle-fishes as a means of protection against their enemies, as they have the power of at will expelling jets of it into the surrounding water, and thus raising a cloud under cover of which they make their escape. The coloring matter of the ink is highly indestructible, is often found preserved in fossil Dibranchiates, and was formerly employed in the manufacture of the paint "sepia."

The *circulatory organs* of the cuttle-fishes consist of arteries, veins, generally an intermediate system of capillaries, a more or less extensively developed system of sinuses or lacunæ amongst the tissues, a central systemic heart, and two accessory or "branchial" hearts, whereby the venous blood is propelled through the breathing organs. The general course of the circulation is as follows. The venous blood returned from the arms, the anterior portion of the body and mantle generally, and the funnel is collected into a main ventrally-placed vein (the vena cava). This is reinforced by a great vein (*canalis venosus*), which brings the blood from a venous sinus surrounding the buccal chamber, the gullet, stomach, and liver in the Octopoda, but which is of comparatively small dimensions in the Decapoda. The great venous channel thus formed splits into two branches (the so-called "branchial arteries"), which further receive the venous blood returned from the posterior viscera and hinder portion of the mantle by special vessels (the "visceral veins"). The branchial arteries then pour their contents by valvular apertures into two special muscular contractile chambers, which are termed the "branchial hearts," and are situated, one on each side, at the bases of the gills. The branchial hearts drive the blood through the gills, where it is aerated, and whence it issues, as arterial blood, by the so-called "branchial veins," which convey it to the true systemic heart. This organ is placed in the middle line of the body, between the renal sinuses on each side, and below the bifurcation of the vena cava. The two branchial veins open into it by contractile dilatations, which may be regarded as auricles, and it consists of a single muscular cavity, which propels the blood into the systemic aorta. By this vessel the aerated blood is distributed to the tissues generally, finding its way back to the veins mostly through the intervention of a system of capillaries, but partly by the venous sinuses and lacunæ before-mentioned. Besides the true aorta there arise from the systemic heart minor arterial vessels, by which the blood is conveyed to the mantle, fins, and reproductive organs. The blood contains microscopic corpuscles, and is remarkable in containing a notable amount of copper.

The *respiratory organs* of the cuttle-fishes consist of two gills or branchiæ, one of each side of the body, placed in the cavity of the mantle-sac. The branchiæ are of an elongated pyramidal figure, and each consists of a central stem, attached below to the visceral mass and along one side to the mantle, the other side being free. The central stem bears a larger or smaller number of triangular laminae, in turn supporting similar secondary laminae, which finally carry still smaller tertiary laminae; and the blood is thus minutely distributed through the gill. In the absence of a ciliated branchial surface, the necessary respiratory currents are maintained by the alternate contractions and expansions of the muscular walls of the pallial chamber. As the mantle dilates, the water from the exterior makes its way into the mantle-cavity by the opening between the rim of the mantle and the neck. The water, after passing over the gills, is then expelled through the funnel by the contraction of the mantle. The course of the out-going current through the funnel is determined either by the presence of suitable valves at the base of this organ, which permit the egress of water, but do not permit its ingress, or by the articulation of the sides of the funnel with the rim of the mantle-sac, in such a manner that the opening into the mantle-cavity is completely closed during the expiratory act, the funnel alone remaining open. As before remarked, the outgoing respiratory currents serve to take with them the excrementitious portions of the food and the secretions of the kidneys and ink-sac; and they are also concerned in swimming, as the animal can by their means propel itself backwards through the water.

The *nervous system* of the cuttle-fishes consists of the



three principal pairs of ganglia characteristic of the Lamellibranchs and Gasteropods—namely, the cephalic, pedal, and parieto-splanchnic. These form an oesophageal collar, which consists of a smaller dorsal mass (the cephalic ganglia), and a larger ventral mass (the pedal and parieto-splanchnic ganglia), united by commissures. The central organs of the nervous system are protected by a cartilage,

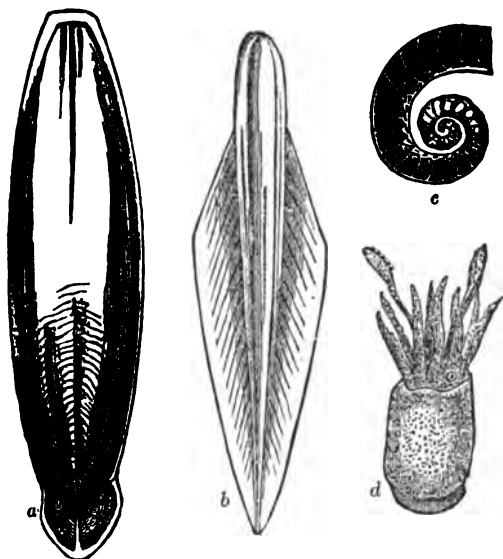

FIG. 3.—a, Internal skeleton ("sepiostaire") of *Sepia ornata*, Rang; b, Internal skeleton ("pen") of *Histioteuthis Bonelliana*, D'Orb.; c, Internal skeleton ("phragmacone") of *Spirula fragilis*, Lamarck; d, Animal of *Spirula Paronii*.

foreshadowing the cranium of the vertebrate animals; and the cerebral ganglia supply the nerves to the buccal mass and eyes, whilst the pedal ganglia supply nerves to the auditory organs, funnel, and arms, and the nervous supply of the mantle and viscera generally is derived from the parieto-splanchnic ganglia. The organs of sense of the cuttle-fishes are highly developed, and consist of the eyes, auditory sacs, and perhaps of an olfactory apparatus. Space will not permit of a description of these, and it must suffice to say that the organs of vision are of large size, and more highly developed than in any other invertebrate animals, consisting of a sclerotic, choroid, retina, vitreous humor, aqueous humor, and crystalline lens; the organs of hearing are two chambers hollowed out of the cartilage of the cranial plate, each containing a membranous sac with an otolith; and the organs of smell have been doubtfully sought in certain cavities which open by small apertures behind the eye, and are supplied with filaments from the cephalic ganglia.

Of the skeletal structures which these animals possess, some are integumentary and exoskeletal, whilst others may be regarded as constituting a true endoskeleton. In the latter category are the various internal cartilaginous structures which are found in the cuttle-fishes, protecting vital organs, or serving as a base of insertion for muscles. Some of these, such as the cartilages which strengthen the anterior rim of the mantle-sac, and serve for its articulation in some forms with the funnel, and the cartilages of the fins (when present) need no further notice; but the cranial cartilage is of greater importance. This latter forms a plate, which surrounds the gullet, and incloses and protects the great oesophageal nerve-collar, and which sends off prolongations which strengthen and protect the eye, thus discharging the functions of the orbits of higher animals.

The integumentary skeleton of the cuttle-fishes consists of an external shell only in the Paper Nautilus (*Argonauta*), but in all others in which it is present at all it is composed of certain horny or calcareous structures, which are lodged in the substance of the mantle, and are therefore concealed from view. This internal skeleton, so characteristic of the Dibranchiata, is well developed in all the Decapods, but is either absent or rudimentary in the Octopods, in which it never consists of more than "two short rudimental styles encysted in the dorso-lateral parts of the mantle" (Owen).

In the typical Decapods (such as *Loligo*, *Sepioteuthis Euplototeuthis*, *Histioteuthis*, etc.), the skeleton is horny, and consists of a feather-shaped "pen" (b, fig. 3) composed of a central shaft and two more or less extensively developed lateral expansions or wings, the whole imbedded in the mantle in the middle line of the back. In some cases (*Onychoteuthis*, *Ommastrephes*, *Loliopsis*) the hinder end of the pen is developed into hollow conical appendix or cup forming a rudimentary "splanchnoskeleton." In the genus *Sepia*, the internal skeleton (a, fig. 3) consists of a horny oval plate, strengthened by calcareous matter, which is deposited principally on its internal surface, and consists of numerous thin plates separated by vertical fibres. The "cuttle-bone," or "sepiostaire," is of a porous, spongy consistence, and is concave on its inner surface behind, terminating posteriorly in a small cone ("mucro"), from which a thin, wing-like margin is prolonged forwards on both sides. In the singular genus *Spirula* the internal skeleton (c, fig. 3) has the form of a calcareous and nacreous tube, coiled up into a flat spiral, the coils of which are not in contact. The internal cavity of the shell is partitioned off by a succession of pearly septa, which are perforated on the ventral or concave side of the shell by a tube ("siphuncle") running the whole length of the spiral. In its general construction, the skeleton of the *Spirula* is very like the shell of the Pearly Nautilus; but it is quite certain that its relations to the animal are quite different. Though the shell itself is exceedingly abundant in certain regions, the animal is at present only known by some very imperfect examples, and its connection with the shell is not precisely clear. The last chamber of the shell, however, is little or not at all larger than those behind it, and it is certain that the animal in no sense lives in the shell. On the contrary the last chamber simply lodged the extremity of the visceral sac, and the shell is to all intents and purposes an internal one, though possibly it is only partially concealed from view by folds of the mantle, and is not absolutely encysted.



FIG. 4.—Diagram of Belemnite (after Phillips), r, horny pen or "pro-ostacum"; a, conical cavity or "alveolus," in which the chambered "phragmacone" (p) is contained; g, "guard," or "rostrum."

Secondary in its distribution, which has a type of skeleton peculiar to itself. This skeleton consists of a conical cham-

Of the three types of internal skeleton characteristic of living cuttle-fishes—namely, the horny pen of the Calamaries, the calcareous "bone" of the *Sepia*, and the spiral chambered and siphunculate shell of *Spirula*—two appear under various forms in the Secondary and Tertiary rocks, whilst the third, comprising the *Spirula*, is so far unknown in the fossil condition. Thus, we find fossil "pens," in all essential respects identical with those of the ordinary living Decapods, to be by no means very rare in deposits of Secondary age, and such genera as *Teudopsis*, *Leptoteuthis*, *Geoteuthis*, and *Beloteuthis* have been founded on these remains. Similarly, the calcareous "cuttle-bones" from the Tertiary rocks, upon which are founded the genera *Spirulirostra*, *Beloptera*, and *Belemnites*, appear to be referable to the *Sepiadae*. In *Spirulirostra*, however, the skeleton consists partly of a spirally bent, chambered, and siphonate "phragmacone," protected by a pointed calcareous "guard," and it thus reminds us on the one hand of the living *Spirula*, and on the other hand of the extinct Belemnites. By far the most important of the fossil cuttle-fishes, however, are those which form the family of the *Belemnitidae*, a group wholly

bered shell—the “phragmacone”—which is partitioned off by calcareous septa into distinct air-chambers, pierced ventrally by a tube or “siphuncle.” The conical phragmacone is placed in a corresponding excavation in the anterior end of a longer or shorter, sub-cylindrical, calcareous, and fibrous structure, which is known as the “guard,” or “rostrum,” and which protects the delicate phragmacone from injury. The guard is the part of the skeleton which is most frequently found in the fossil condition, and in perfect specimens it is prolonged forwards anteriorly into a longer or shorter horny or shelly plate, which corresponds with the front portion of the “pen” of the Calamaries, and is known as the “pro-ostracum.” The various genera of the *Belemnitida*—*Belemnites*, *Belemnitella*, *Xiphoteuthis*, *Conoteuthis*, *Acanthoteuthis*, *Belemnoteuthis*—are founded on differences in the nature of the internal skeleton. We know, however, from specimens preserved in such fine-grained deposits as the Oxford clay, that the cuttle-fishes of this family possessed lateral fins, and two “tentacles” in addition to the eight proper “arms,” that the suckers were provided with horny hooks; and that there was an ink-sac.

As before remarked, the only known Dibranchiate Cephalopod in which an external shell is present is the Paper Nautilus (*Argonauta*). The shell, moreover, is only possessed by the female Argonaut—the male being shell-

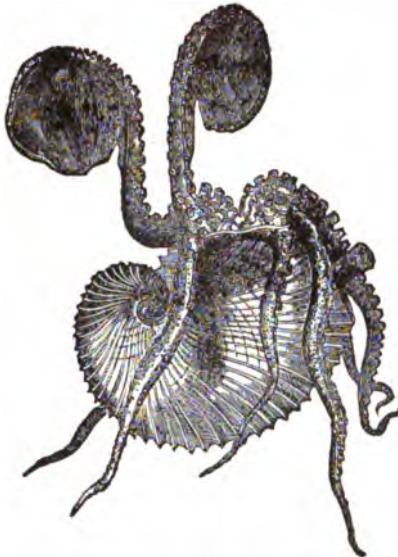

FIG. 5.—*Argonauta argo*, the “Paper Nautilus,” female. The animal is represented in its shell, but the webbed dorsal arms are separated from the shell, which they ordinarily embrace.

less—and it is in no way comparable as regards its mode of origin and its morphological significance with the shell of the ordinary testaceous Mollusks in general, or of the Tetrabranchiate Cephalopods in particular. The shell of the Argonaut is involute, one-chambered, and calcareous, of most graceful outlines and ornamentation. It is not secreted by the mantle, nor is the animal attached to it by any organic connection—hence the long controversy as to whether the Argonaut truly owned the shell it inhabited, or had not rather simply obtained it by plunder, as the Hermit-Crab seizes any empty shell which may be suitable for its temporary habitation. It is, however, now known that the shell of the Argonaut is secreted by the two dorsal arms of the female, which are expanded or webbed, and closely embrace the shell which they produce. These two arms, in their natural position, are bent backwards, so as to allow the animal to inhabit the shell. The animal sits in the shell, with its funnel turned towards the keel, and the apex of the shell is empty, and is used simply as a receptacle for the clustered eggs.

The processes of reproduction and development in the cuttle-fishes are of great interest. The males and females are generally more or less unlike externally—this difference being most marked in the Argonaut, in which the male is very much smaller than the female, and in addition possesses no shell. The reproductive organs of the female consist of a single ovary, situ-

ated at the hinder end of the body, and inclosed in a pouch of the peritoneum, from which one or two oviducts are continued to open into the mantle-cavity, generally near the base of the funnel. The eggs are discharged into the peritoneal sac, surrounding the ovary, and are then taken up by the oviducts and conveyed into the mantle-cavity. When finally extruded, the impregnated eggs are found to be inclosed, singly or many together, in special capsules, which are usually attached in bunches to some foreign body. These egg-capsules are produced by the so-called “nidamental glands,” which in some genera (e.g., *Sepia* and *Loligo*) are of large size, and are appended to the proper generative organs. The reproductive organs of the male cuttle-fishes consist of a testis placed at the hinder extremity, like the ovary of the female, and inclosed in a peritoneal sac. The spermatozooids are discharged into this sac by the rupture of the secreting tubes, and are conveyed to the exterior by a tubular “vas deferens,” which is dilated in its course into a “vesicula seminalis,” and ultimately opens into the mantle-cavity by a papilliform “penis” situated close to the anus. Before the vas deferens finally terminates in this way, it is usually expanded into a special dilatation (“bursa spermatorum”), in which are packed away the so-called “spermatorphores,” or “moving filaments of Needham.” These singular bodies are whitish filaments, 6 or 8 lines in length, composed of aggregations of spermatozooids inclosed in a covering originally of an albuminous nature, but ultimately becoming developed into two membranes which have a complicated arrangement. When set free and moistened, the spermatorphores exhibit active vermicular movements, and under suitable circumstances rupture and discharge their contained spermatozoa.

The reproductive act in the cuttle-fishes is only imperfectly known; but true intromission is certainly impossible. According to the observations of Aristotle, the poulpes and calamaries perform this act by clinging to each other, mouth to mouth, with the suckers of the arms in mutual apposition, the former seeking the bottom, whilst the latter move freely in the water. It is known now, in this connection, that one of the arms of the male cuttle-fishes is peculiarly modified, the arm thus affected being said to be “hectocotylized.” In some forms, this hectocotylized arm—differing in its position in different cases—is not so conspicuously altered as to attract immediate attention, and it does not appear clear that it plays necessarily any part in the reproductive act, though the alteration of form is undoubtedly primarily sexual. In certain forms, however (viz. *Argonauta argo*, *Tremoctopus violaceus*, *T. Quoyanus*, and *Octopus carena*) the hectocotylized arm is the efficient agent in the act of reproduction. It is longer and thicker than the other arms, prolonged at its extremity into a long filament, and possessing posteriorly a sac which is filled with spermatorphores. During the act of reproduction, the hectocotylized arm is detached by the male, and is deposited, with its freight of spermatorphores, within the mantle-cavity of the female. The terminal filament is perforated by a tube, by which the spermatorphores are conveyed to the ova, and impregnation is thus effected. When thus detached, the hectocotylized arm is capable of independent movement, and when first found in this free condition within the mantle-sac of the female Argonaut it was regarded as a parasitic worm. Under this belief Delle Chiaje described it as the *Trichocephalus acetabularis*, and Cuvier called it (in the *Octopus*) the *Hectocotylus Octopodis*. Both these names are in allusion to the suckers which the arm carries, and the name of “hectocotylus” is still applied to the detached arm, whereas the arm, if not detached, is simply said to be “hectocotylized.” As before remarked, it is not absolutely certain that the hectocotylized arm is invariably employed as a reproductive agent; and certainly it is only occasionally detached. According to Steenstrup, however, the hectocotylized arm, when not detached, is employed by the male to transfer the spermatorphores to the female during the act of reproduction, the spermatic filaments being either placed within the mantle-cavity, or fixed to the internal surface of the buccal cavity of the females. How the spermatorphores are transferred from the seminal ducts of the male to the sac contained in the interior of the hectocotylized arm is still uncertain; but Leuckart has shown that the sac in question does actually communicate with the surface by a distinct aperture.

The development of the cuttle-fishes can be barely touched upon here. After fertilization the ovum undergoes a partial segmentation, as in birds and reptiles, and there is formed at one pole a germinal disc (“blastoderm”), which is at first divided into two parts by a primitive furrow, then into four by a secondary furrow intersecting the first at right angles, and then into eight. An inner germinal layer is then formed (according to the researches of Ray Lankester on *Loligo*) quite independently of the outer one; and the two layers then grow over the entire yolk and completely inclose it. The unsegmented portion of the yolk is gradually absorbed by the growing embryo, but obtains no direct connection with the alimentary tube, the latter originating from the primitive invagination of the outer layer of the blastoderm, instead of being formed, as in vertebrates, by its inner layer.

As regards their *distribution in space*, the cuttle-fishes are all marine, active, rapacious, and carnivorous in their habits, swimming vigorously by means of the jets of water emitted from the funnel, or in an opposite direction by means of fins, and creeping about the sea-bottom by means of the prehensile arms. Some forms (such as the *Octopodidae* and *Sepia*) are essentially littoral animals, frequenting shallow seas, living in the vicinity of the land, and specially affecting rocky bottoms. Others (such as *Tremoctopus*, *Sepioida*, *Argonauta*, *Spirula*, *Architeuthis*, *Onychoteuthis*, etc.) are pelagic animals, living in the open ocean, often far from land, and swimming at or near the surface. Though more varied as regards their specific and generic types in the warmer seas of the globe, cuttle-fishes are found in almost all seas, and are sometimes extremely numerous individually even in the colder oceans. It seems also certain that our present knowledge as to the pelagic forms is only very imperfect. As to their dimensions, none are extremely minute, and some attain truly gigantic dimensions. Not to speak of the fabulous accounts of colossal cuttle-fishes given by many of the older writers, such as Pontoppidan and Olaus Magnus, we are now acquainted through the observations and descriptions of scientific witnesses, such as Banks and Solander, Quoy and Gaimard, Steenstrup, Verrill, etc., with various huge cuttle-fishes, inhabiting both the Atlantic and Pacific Oceans. Some of these, though only known by imperfect specimens, certainly attain a length of 15 feet or upwards to the body and head, and from 30 to 40 feet or upwards in the long tentacles. All these giant cuttle-fishes appear to belong to the sub-order of the *Decapoda*.

As regards their *distribution in time*, the order of the Dibranchiate Cephalopods does not seem to have come into existence during the Palaeozoic period. And in this case the negative evidence is of considerable value, seeing that so many members of the order are provided with structures capable of preserva-

*Anatomie*; Owen, "Cephalopoda," in Todd and Bowman's *Cyclopædia of Anatomy and Physiology*, 1835-36; Von Siebold, "Anatomy of Cephalopoda," in Siebold and Stannius's *Lehrbuch der vergleichenden Anatomie*, 1848; Milne-Edwards, *Leçons sur la Physiologie et l'Anatomie comparée*, 1857; Kernerstein, "Cephalopoda," in Bronn's *Klassen und Ordnungen des Thierreichs*, 1862; Férussac and Ale. d'Orbigny, *Histoire naturelle des Cephalopodes actinabuliferes vivants et fossiles*, 1835-43; Pöll, "Anatomy of Argonauta," in his *Testacea utriusque Hæliis*, 1826; Jeanette Power, "The Animal of *Argonauta argo*," *Archiv. f. Naturgesch.*, 1837; Van Beneden, "Mém. sur l'Argonauta," in *Nouv. Mém. de l'Acad. roy. de Bruxelles*, 1838; J. E. Gray, "The Animal of *Spirula*," *Ann. and Mag. Nat. Hist.*, 1845; Kölliker, *Entwickelungsgeschichte der Cephalopoden*, 1844, and "Observations on the Hectocotyl of *Tremoctopus violaceus* and *Argonauta argo*," in *Trans. Linn. Soc.*, 1846; H. Müller, "Ueber das Männchen von *Argonauta argo* und die Hectocotylen," in *Zeitsch. f. Wiss. Zool.*, 1852; Verrill, "Colossal Cephalopods of the North Atlantic," in *American Naturalist*, 1875; Wagner, "Die fossilen Ueberreste von nackten Dintenfischen aus den Lithographischen Schiefer," in *Abhandl. d. Math. phys. Cl. der K. Bayer. Akad. Wiss.*, 1860; Owen, "Belemnites from the Oxford Clay," *Phil. Trans.*, 1844; Huxley, "Structure of Belemnites," in *Mem. Geol. Survey*, 1864; Phillips, *Monograph of the Belemnitids* (Palaeontographical Society), 1865-69.

(H. A. N.)

CUVIER, BARON (1769-1832). Georges Cuvier was born on the 23d of August, 1769, at Montbéliard, in the department of Doubs, then belonging to Würtemberg. He was christened Léopold-Chrétien-Frédéric-Dagobert, but afterwards assumed, at his mother's wish, the name of Georges, which was that of an elder brother deceased. His father, a retired officer on half-pay, belonged to a Protestant family which had emigrated from the Jura in consequence of religious persecution. His mother, as in the case of so many eminent men, was a cultivated and high-minded woman, who took every pains to develop the nascent faculties of her son. He early showed a bent towards the investigation of natural phenomena, and was noted for his studious habits and marvellous memory. His higher education was carried out at the Academy of Stuttgart—the school of Schiller and other men of eminence—to which collegiate institution he had received a nomination from Prince Charles of Würtemberg. Devoting a year to the study of "philosophy," he was enrolled as a student in the faculty of political economy ("Administration," "Camerawissenschaft"); and after a brilliant university career he was thrown upon the world at the age of eighteen. A short interlude was passed as sub-lieutenant in the Swiss regiment of Châteaueux, but this corps being disbanded, and his family being poor, he accepted the position of tutor in the family of the Comte d'Héricy, residing near Caen, in Normandy. Here he spent the years from 1788 to the end of 1794—including the terrific epoch of the "Reign of Terror"—peaceably occupying his leisure in the ardent pursuit of his favorite sciences. About this time he attracted the attention of the Abbé Tessier, who was sheltering himself from the fury of the Revolution at Fécamp, and who wrote strongly in favor of his *protégé* to his friends in Paris,—with the result that Cuvier, after corresponding with the well-known naturalist Geoffroy Saint-Hilaire, was appointed in 1795 assistant to Mertrud, the aged professor of comparative anatomy at the Museum d'Histoire Naturelle.

The pre-eminent abilities of Cuvier as a naturalist and scientific observer were at once recognized in Paris, and the National Institute being founded this year (1795), he was elected a member, and was associated with Lacépède and Daubenton as the nucleus of the section of zoology. Detached memoirs on various zoological subjects had already been published by him, one of the most important being a joint memoir with Geoffroy on a new classification of the Mammalia. In this year he also published a number of researches, dealing with a very wide range of subjects, such as descriptions of new species of insects, the anatomy of *Helix pomatia*, the internal ear of the cetaceans, the circulation of the invertebrates, the classification of the invertebrates, etc. One of the most important of these, published in the "Décade philosophique" of the *Memoirs of the Natural History Society of Paris*, dealt with the internal and external structure and systematic affinities of the miscellaneous assemblage of lower invertebrates at that time grouped together under the name of "Vermes." In 1796 Cuvier commenced his course of lectures in the École Centrale du Panthéon, and published a number of contributions to comparative anatomy. He also read his first palaeontolog-

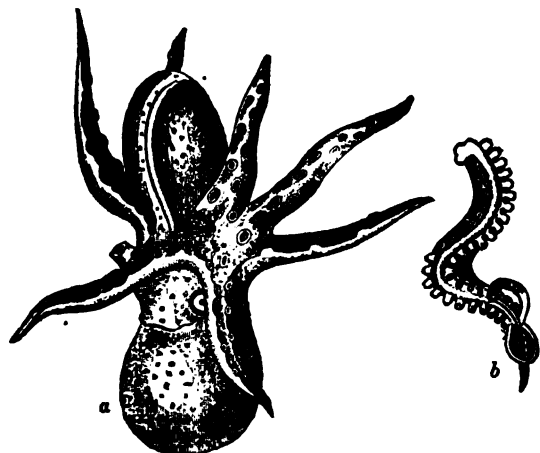

FIGS. 6.—a, Male of *Argonauta argo*, with the hectocotylized arm still contained in its enveloping cyst, four times enlarged (after H. Müller). b, Hectocotylus of *Tremoctopus violaceus* (after Kölliker).

tion in the fossil state. During the Mesozoic period the Dibranchiates attained a high development, being principally represented by the exclusively Secondary family of the *Belemnitidae*, which began to exist in the Trias and survived to the Chalk. The genus *Belemnites* itself extends from the Upper Trias to the Upper Greensand, and its place is taken in the Chalk by the nearly allied *Belemnitella*, distinguished by a fissure in the side of the alveolus of the guard. The Secondary rocks have also yielded the pens of *Teuthidae* (*Teudopsis*, *Belemnites*, etc.), and of *Sepiidae* (*Sepia* itself, and *Coccolithis*). In the Tertiary rocks, the three curious extinct genera *Belosepia*, *Spirulirostra*, and *Belemnosis* appear to be referable to the *Sepiidae*, and *Sepia* itself still continues to exist; whilst the *Teuthidae* are not wholly unrepresented. The family of the *Spirulidae* has no certain fossil representative; but two species of Argonaut have been detected in the later Tertiaries. With this last-mentioned exception, no remains certainly referable to the sub-order of the *Octopoda* have hitherto been met with.

BIBLIOGRAPHY.—The following list comprises some of the more important works and memoirs which may be consulted with regard to the living and fossil Dibranchiate Cephalopods:—Aristotle, *Historia de Animalibus*; Meyer, *Aristoteles Thierkunde*, Berlin, 1855; Needham, *An Account of some new Microscopical Discoveries*, 1745; Monro (*secundus*), "On the Anatomy of the Sagittated Calamary," in *The Structure and Physiology of Fishes*, 1788; Cuvier, *Leçons d'Anat. Comparée et Mémoire sur les Cephalopodes et sur leur Anatomie*; St. delle Chiaje, *Memoria su' Cepalopedi*, 1829; Meckel, *System der vergleichenden*

ical paper at the opening of the National Institute in the April of this year, which was subsequently published in 1800 under the title *Mémoires sur les Espèces d'Éléphants vivants et fossiles*. Throughout the years 1797 and 1798 his scientific activity continued unabated, as is implied by the production of various memoirs upon such subjects as the nutritive processes in insects, the structure of the ascidians, the anatomy of the bivalve mollusks, the nostrils of the cetaceans, the different species of rhinoceros, the fossil bones of the Gypseous series of Montmartre, etc. In 1798, also was published his first separate work, namely the *Tableau Élémentaire de l'histoire naturelle des Animaux*. This volume was an abridgment of his course of lectures at the École du Panthéon, and may be regarded as the foundation and first general statement of that natural classification of the animal kingdom, which his genius originated, and which is universally accepted by modern zoologists.

In 1799, by the death of Daubenton, the chair of natural history in the Collège de France was rendered vacant; and Cuvier was appointed to this responsible post. In this year an important memoir on the blood system of the leeches appeared from his pen. In 1800, in addition to various scattered contributions to zoology and paleontology, embracing observations on the *Siren lacertina*, the crocodilians of the Old and New Worlds, the fossil tapirs of France, the ornitholites of Montmartre, etc., appeared the *Leçons d'Anatomie Comparée*, a classical work, in the production of which Cuvier was assisted by Dumeril in the first two volumes, and by Duvernoy in three later ones. In 1802 Cuvier became titular professor at the Jardin des Plantes; and in the same year he was appointed commissary of the Institute to accompany the inspectors-general of public instruction. In this latter capacity he visited the south of France; but he was in the early part of 1803 chosen perpetual secretary of the National Institute in the department of the physical and natural sciences, and he consequently abandoned the appointment just mentioned and returned to Paris. Shortly thereafter he married the daughter of M. Duvancel, a contractor for the public taxes, by whom he had four children, all of whom predeceased him.

Cuvier's scientific publications during the period posterior to the year 1801 covered a vast area, and can be but briefly alluded to here. In addition to memoirs on the teeth of fishes, on the "Vermes" with red blood (Annelides), on the crabs known to the ancients, on the Egyptian ibis, etc., Cuvier now devoted himself more especially to three lines of inquiry, one dealing with the structure and classification of the Mollusca, a second treating of the comparative anatomy and systematic arrangement of the fishes, and the third concerned with fossil mammals and reptiles primarily, and secondarily with the osteology of living forms belonging to the same groups. As regards the first of these fields of investigation, Cuvier published a long series of papers on the mollusca, which began as early as 1792, and dealt with almost all the groups now admitted into this sub-kingdom, with the exception of the *Polymoa*. Most of these memoirs were published in the *Annales du Muséum* between 1802 and 1815, and they were subsequently collected into the well-known and invaluable *Mémoires pour servir à l'Histoire et à l'Anatomie des Mollusques*, published in one volume at Paris in 1817. In the department of fishes, Cuvier's researches, begun in 1801, finally culminated in the publication of the *Histoire Naturelle des Poissons*. This magnificent work contained descriptions of 5000 species of fishes, and was the joint production of Cuvier and Valenciennes, its publication (so far as the former was concerned) extending over the years 1828-31. Paleontology was always a favorite study with Cuvier, and the department of it dealing with the Mammalia may be said to have been essentially created and established by him. In this region of investigation he published a long list of memoirs, partly relating to the bones of extinct animals, and partly detailing the results of observations on the skeletons of living animals especially examined with a view of throwing light upon the structure and affinities of the fossil forms. In the second category must be placed a number of papers relating to the osteology of the *Rhinoceros Indicus*, the tapir, *Hyrax Capensis*, the hippopotamus, the sloths, the manatee, etc. In the former category must be classed an even greater number of memoirs, dealing with the extinct mammals of the Eocene beds of Montmartre, the fossil species of hippopotamus, the

*Didelphys gypsurum*, the *Megalonyx*, the *Megatherium*, the cave-hyena, the extinct species of rhinoceros, the cave-bear, the mastodon, the extinct species of elephant, fossil species of manatee and seals, fossil forms of crocodilians, chelonians, fishes, birds, etc. The results of Cuvier's principal paleontological and geological investigations were ultimately given to the world in the form of two separate works. One of these is the celebrated *Recherches sur les Ossements fossiles de Quadrupèdes*, in four volumes quarto, published in Paris in 1812, with subsequent editions in 1821 and 1825; and the other is his *Discours sur les Révolutions de la surface du Globe*, in one volume octavo, published in Paris in 1825.

Apart from his own original investigations in zoology and paleontology Cuvier carried out a vast amount of work as perpetual secretary of the National Institute, and as an official connected with public education generally, and much of this work appeared ultimately in a published form. Thus, in 1808 he was placed by Napoleon upon the council of the Imperial University, and in this capacity he presided (in the years 1809, 1811, and 1813) over commissions charged to examine the state of the higher educational establishments in the districts beyond the Alps and the Rhine which had been annexed to France, and to report upon the means by which these could be affiliated with the central university. Three separate reports on this subject were published by him. In his capacity, again, of perpetual secretary of the Institute, he not only prepared a number of *éloges historiques* on deceased members of the Academy of Sciences, but he was the author of a number of reports on the history of the physical and natural sciences, the most important of these being his celebrated *Rapport historique sur le progrès des sciences Physiques depuis 1789*, published in 1810.

No work of Cuvier, however, has attained a higher reputation than his famous *Règne Animal distribué d'après son Organisation*. The first edition of this appeared in four octavo volumes in 1817, the second, in five volumes, was published in 1829-30. In this classical work, Cuvier embodied the results of the whole of his previous researches on the structure of living and fossil animals, as giving confirmation and fixity to that system of classification of which he was the originator, and the main features of which still subsist. The whole of this work was his own, with the exception of the *Insecta*, in which he was assisted by his friend Latreille.

The rest of Cuvier's life, apart from his scientific labors, must be very briefly told. By the unanimous consent of the learned world, he was now regarded as the most eminent of living naturalists, and the scientific honors which he received are beyond enumeration. Nor did he fail to meet amongst his own countrymen—always ready to recognize ability, genius, energy, and perseverance—with that public acknowledgment of his merits which he had so richly deserved. Prior to the fall of Napoleon (1814) he had been admitted to the Council of State, and his position remained unaffected by the restoration of the Bourbons. He was elected chancellor of the university, in which capacity he acted as interim president of the Council of Public Instruction, whilst he also, as a Lutheran, superintended the faculty of Protestant theology. In 1819 he was appointed president of the Committee of the Interior, which office he retained until his death. In 1826 he was made grand officer of the Legion of Honor, and in 1831 he was raised by Louis Philippe to the rank of peer of France, and was subsequently appointed president of the Council of State. In the beginning of 1832 he was nominated to the Ministry of the Interior, but the end was now near. On the 13th of May of this year, after a brief illness, commencing in paralysis of the throat, and rapidly implicating the respiratory organs, Cuvier passed away, his last surviving child having preceded him no less than five years.

Eminent as he was in various departments of administration, it will be as a naturalist and paleontologist that the memory of Cuvier will be preserved. The results which he accomplished in the sciences of zoology and paleontology were, however, so vast and varied that it is only possible to indicate in a general manner the more important of them. These results fall naturally under three heads.

In the first place, as regards *systematic zoology*, he effected an entire revolution in the classification of the animal kingdom as previously understood, and as explicitly for-

ulated in the system of Linnæus. For an artificial and arbitrary classification he substituted a natural arrangement, and he for the first time indicated the true principles upon which a natural classification is possible. He established the empirical laws of correlation of growth and the subordination of different systems of organs, and he showed that the primary laws of all sound classification are to be found only in the anatomical examination of the animals compared. In other words, for the loose, formal, and physiological analogies, which had previously been used as the basis of classification, he substituted the fundamental resemblances of morphological type and homology, and relegated the former to a subordinate place. In no department of systematic zoology were the reforms instituted by Cuvier more conspicuous than in the invertebrates. Linnæus classified the invertebrates simply by dividing them into the two classes of the *Insecta* and the *Vermes*. Cuvier divided the invertebrates into the three sub-kingdoms ("embranchements") of the *Mollusca*, the *Articulata*, and the *Radiata* or zoophytes, and split up these again into a number of natural groups or classes. It is true that modern zoologists have almost unanimously agreed on the partition of the Cuvierian "Radiata" into the two sub-kingdoms of the *Cœlenterata* and *Protozoa*; though some modern views would almost obliterate any line of demarcation between these, and would thus, in effect, re-establish the *Radiata*. It is also true that considerable changes have been made in the classes of the lower invertebrates as instituted by Cuvier. It is impossible, however, not to recognize the immense step in advance made by the Cuvierian system of classification upon that of Linnæus.

Cuvier's contributions to *comparative anatomy*, in the second place, can be merely glanced at here. Apart from the impulse given to the study of this science by the publication of his *Leçons d'Anatomie Comparée*, it may almost be said that we owe to Cuvier the general recognition that the really essential portion of scientific zoology is comparative anatomy. As regards special departments, his contributions to the comparative anatomy of the *Mollusca* and fishes, and to the osteology of the *Mammalia*, may be particularly mentioned. As an instance, further, of the manner in which Cuvier employed comparative anatomy as a guide in zoological classification, the sub-kingdom of the *Mollusca* may be specially singled out, or, if we prefer to take a minor group, the class of the *Cephalopoda*.

Lastly, in the department of *paleontology*, Cuvier effected a great and notable advance upon his predecessors. The notion that fossils were merely *lunus natura* had been already formally abandoned by such men as Leibnitz, Buffon, and Pallas. Daubenton, and subsequently Pallas and Camper, compared the fossil bones of quadrupeds with those of living forms, and the last of these declared his opinion that some of these fossil bones belonged to extinct species of quadrupeds. It is to Cuvier, however, that the world owes the first systematic application of that science of comparative anatomy, which he himself had done so much to place upon a sound basis, to the study of the bones of fossil animals. It is to him that we owe the first complete demonstration that extinct animals could be "reconstructed" from fragmentary remains by availing ourselves of the law of the "correlation of growth;" though it is true, as pointed out by Professor Huxley, that he rested more implicitly and securely upon this law than its empiric nature and its now proved exceptions would justify at the present day. Cuvier, as a paleontologist, devoted himself principally to the study of the fossil *Mammalia* of the Tertiary period, and especially to those of the Eocene basin of Paris; and the flood of light which he was enabled to throw upon the structure and affinities of these lost forms was mainly derived from a careful and laborious comparison of the extinct types with their nearest living congeners. Whatever new victories may be in store for the science of paleontology, the *Ossemens Fossiles* will remain an imperishable monument of the genius and industry of one of the first and of the greatest of the pioneers in this region of human investigation.

**BIBLIOGRAPHY.**—*Éloge historique de G. Cuvier*, by M. Flourens, published as an introduction to the *Eloges Historiques de Cuvier*. *Histoire des Travaux de Georges Cuvier*, by M. Flourens, 3d ed. Paris, 1858. "Mort de G. Cuvier," by D. Candolle, a notice in the *Bibliothèque Universelle*, t. xlix. p. 442, Geneva, 1832; Article "Cuvier" in *Biographie Universelle*, supp. t. lxi. p. 588, Paris, 1836, by Laurillard. *Memoire de Cuvier*, by

Sarah Lee, London, translated into French by Lacordaire in 1833. (H. A. N.)

**CUXHAVEN**, or **KUXHAVEN**, a small seaport town of Northern Germany, at the mouth of the Elbe, on its left bank, 58 miles W.N.W. of Hamburg, in the detached bailiwick of Ritzebüttel, which forms part of the territory belonging to Hamburg. It has nearly 3900 inhabitants, chiefly pilots and fishermen. The harbor is good and secure, and is much frequented by vessels delayed in the Elbe by unfavorable weather; it is also the starting point of the Hamburg steamers when the river is frozen over. There is regular communication by diligence with Bremerhafen, and by river with Hamburg. Though lying on a bare strand, the town is much frequented as a bathing-place by Hamburgers.

**CUYABA**, or **CULABA**, the capital of the Brazilian inland province of Mato Grosso, in 16° 20' S. lat. and 56° W. long., or almost in the heart of the South American continent. It lies about a mile from the left bank of the Cuyabá river, one of the head streams of the Paraguay, at 250 miles by river from the confluence with the main stream, and about 2400 miles from the estuary of the Plata. Its churches, public buildings, and dwelling-houses are generally well built of brick or of adobe, or of blocks of a conglomerate of pebbles and red clay, plastered and tiled. It is the seat of a bishop, and has a military station and dépôt, and an arsenal for the construction of small vessels for the protection of the rivers. As early as 1722 a number of Portuguese, attracted by the discovery of gold, formed the settlement of Senhor Bom Jesus de Cuyabá, and two years later, such was the influx of population, it was raised to the rank of a city by the governor of São Paulo. Its prosperity dates, however, from 1856, when the navigability of the upper tributaries of the Paraguay had been demonstrated, and when the outlet by the rivers took the place of the former toilsome caravan passage overland to the Atlantic towns and ports. Now a regular fortnightly line of Brazilian steamers unites Monte Video and Rio with Curumba on the Upper Paraguay, whence, after the collection of custom duties, the goods are transhipped in smaller steamers and boats to Cuyabá. The chief import trade is in manufactured goods, hardwares, and salt; the exports are hides, cattle, ipêcuanha, vanilla, and some diamonds. Other products of the district of Cuyabá are manioc, rice, maize, sugar, cotton, tobacco, coffee, and beans. The population is estimated at from 18,000 to 20,000.

The Cuyabá river is navigable from 14° 49' S., and from its proximity at this point to the navigation of the Tapajós by its tributary the Arinos, is probably destined to form part of a great future highway between the Amazon and La Plata. Proof of the practicability of this route was afforded by the portage of large canoes, laden with merchandise from Pará, across the water-parting to the Cuyabá river in 1846.

**CUYP**, the name of a Dutch family which produced two generations of painters. The Cuypes were long settled at Dort, in the neighborhood of which they had a country house, where Albert Cuyp was born and bred. The eldest member of the family who acquired fame was—

**JACOB GERBITSZ CUYP** (1575?—1649), born, it is said, at Dort, and taught by Abraham Bloemaert, of Utrecht. It is difficult to find a greater contrast than that which marks the styles of these two painters, one of whom learned to imitate the mannerisms of the French school, whilst the other persistently clung to the sober reality of nature. J. G. Cuyp's pictures are little known, and are therefore said to be scarce. But he produced portraits in various forms, as busts and half-lengths thrown upon plain back-grounds, or groups in rooms, landscapes, and gardens. Solid and clever as an imitator of nature in its ordinary garb, he is always spirited, sometimes rough, but generally plain, and quite as unconscious of the sparkle conspicuous in Frans Hals as incapable of the concentrated light-effects peculiar to Rembrandt. In portrait busts, of which there are signed examples dated 1624, 1644, 1646, and 1649, in the museums of Berlin, Rotterdam, Marseilles, Vienna, and Metz, his treatment is honest, homely, and true; his touch and tone firm and natural. In portraying children he is fond of introducing playthings and pets—a lamb, a goat, or a roe deer; and he reproduces animal life with realistic care. In a family scene at the Amsterdam Museum we have likenesses of men, women, boys, and girls, with a cottage and park. In the background is a coach with a pair of horses.

These examples alone give us a clue to the influences under which Albert Cuyp grew up, and explain to some extent the direction which his art took as he rose to manhood.

ALBERT CUYP (1605-1691), the son of Jacob Gerritz by Grietje Dierichsdochter (Dierich's daughter), was born at Dort. He married in 1658 Cornelia Bosman, a widow, by whom he had an only daughter. By right of his possessions at Dordwyck, Cuyp was a vassal of the county of Holland, and privileged to sit in the high court of the province. As a citizen he was sufficiently well known to be placed on the list of those from whom William III., stadtholder of the Netherlands, chose the regency of Dort in 1672. His death, and his burial on the 7th of November, 1691, in the church of the Augustines of Dort, are historically proved. It has been said that Albert was the pupil of his father. The scanty evidence of Dutch annalists to this effect seems confirmed by a certain coincidence in the style and treatment of father and son. It has been likewise stated that Albert was skilled, not only in the production of portraits, landscapes, and herds, but in the representation of still life. His works are supposed to be divisible into such as bear the distinctive marks C. or A. C. in cursive characters, the letters A. C. in Roman capitals, and the name "A. Cuyp" in full. A man of Cuyp's acknowledged talent may have been versatile enough to paint in many different styles. But whether he was as versatile as some critics of this generation think is a question not quite easy to answer. It is to be observed that pieces assigned to Cuyp representing game, shell-fish, and fruit, and inscribed A. C. in Roman capitals (Rotterdam, Amsterdam, and Berlin museums), though cleverly executed, are not in touch or treatment like other pictures of less dubious authenticity, signed either with C. or A. C. or "A. Cuyp" in cursive letters. The panels marked C. and A. C. in cursive are portraits or landscapes, with herds, and interiors of stables or sheds, in which there are cows, horses, and poultry. The subjects and their handling are akin to those which strike us in panels bearing the master's full signature, though characterized, as productions of an artist in the first phase of his progress would naturally be, by tones more uniform, touch more flat, and color more deep than we find in the delicate and subtle compositions of the painter's later time. Generally speaking the finished examples of Cuyp's middle and final period all bear his full signature. They are all remarkable for harmonies attained by certain combinations of shade in gradations with colors in contraposition.

Albert Cuyp, a true child of the Netherlands, does not seem to have wandered much beyond Rotterdam on the one hand or Nimeguen on the other. His scenery is that of the Meuse or Rhine exclusively; and there is little variety to notice in his views of water and meadows at Dort, or the bolder undulations of the Rhine banks east of it, except such as result from diversity of effect due to change of weather or season or hour. Cuyp is to the river and its banks what Willem Vanderveelde is to calm seas and Hobbema to woods. There is a poetry of effect, an eternity of distance in his pictures, which no Dutchman ever expressed in a similar way. His landscapes sparkle with silvery sheen at early morning, they are bathed in warm or sultry haze at noon, or glow with heat at eventide. Under all circumstances they have a peculiar tinge of suburn which is Cuyp's and Cuyp's alone. Bürger truly says Van Goyen is grey, Ruysdael is brown, Hobbema olive, but Cuyp "is blond." The utmost delicacy may be observed in Cuyp's manner of defining reflections of objects in water, or of light from water on ship's sides. He shows great cleverness in throwing pale yellow clouds against clear blue skies, and merging yellow mists into olive green vegetation. He is also very artful in varying light and shade according to distance, either by interchange of cloud-shadow and sun-gleam or by gradation of tints. His horses and cattle are admirably drawn, and they relieve each other quite as well if contrasted in black and white and black and red, or varied in subtler shades of red and brown. Rich weed-growth is expressed by light but marrow touch, suggestive of detail as well as of general form. The human figure is given with homely realism in most cases, but frequently with a charming elevation, when, as often occurs, the persons represented are meant to be portraits. Whatever the theme may be it remains impressed with the character and individuality of Cuyp. Familiar subjects of

the master's earliest period are stables with cattle and horses (Rotterdam, Amsterdam, Petersburg, and Brussels museums). Occasionally he painted portraits in the best form familiar to his father, one of which is dated 1642, and exhibited in the National Gallery in London. More frequently he produced likenesses of ladies and gentlemen on horseback, in which the life and dress of the period and the forms of horses are most vividly represented (Buckingham Palace, Bridgewater Gallery, Louvre, and Dresden Museum). Later on we find him fondest of expansive scenery with meadows and cattle and flocks, or rivers and barges in the foreground and distances showing the towers and steeples of Dort. Cuyp was more partial to summer than to winter, to noon than to night, to calm than to storm. But some of his best groups are occasionally relieved on dark and gusty cloud (Louvre and Robart's collection). A few capital pieces show us people sledging and skating or netting ice-holes (Yarborough, Neeld, and Bedford collections). A lovely Night on the Banks of a River, in the Grosvenor collection, reminds us that Cuyp's friend and contemporary was the painter of moonlights, Aart van der Neer, to whom he was equal in the production of these peculiar effects and superior in the throw of figures. Sometimes Cuyp composed fancy subjects. His Orpheus charming the Beasts in the Bute collection, is judiciously arranged with the familiar domestic animals in the foreground, and the wild ones, to which he is a comparative stranger, thrown back into the distance. One of his rare gospel subjects is Philip baptizing the Eunuch (Marchmont House, Berwickshire), described as a fine work by Waagen. The best and most attractive of Cuyp's pieces are his Meuse and Rhine landscapes, with meadows, cattle, flocks, and horsemen, and occasionally with boats and barges. In these he brought together and displayed—during his middle and final period—all the skill of one who is at once a poet and a finished artist; grouping, tinting, touch, harmony of light and shade, and true chords of colors are all combined. Masterpieces of acknowledged beauty are the Riders with the Boy and Herdsman in the National Gallery; the Meuse, with Dort in the distance, in three or four varieties, in the Bridgewater, Grosvenor, Holford, and Brownlow collections; the Huntsman (Ashburton); Herdsmen with Cattle, belonging to the marquis of Bute; and the Piper with Cows, in the Louvre. It is well known that the prices paid for Cuyp's pictures in his own time were comparatively low. In 1750, 30 florins was considered to be the highest sum to which any one of his panels was entitled. At the sale of the Clewer collection at Christie's in 1876 a small Hilly Landscape in Morning Light was sold for £5040, and a View on the Rhine, with cows on a bank, for £3150. Smith has catalogued 335 of Cuyp's works. It would be difficult now to find more than a third of them. (J. A. C.)

CUZCO, a city of southern Peru, the capital of a province of the same name, the ancient capital of the empire of the Incas, and still one of the most important cities of the republic, in 13° 31' S. lat. and 73° 3' W. long., 11,360 feet above the sea, and 350 miles E.S.E. of Lima. It stands at the head of a fertile valley, nine miles in length, running from south-east to north-west, and bounded by mountains of considerable elevation. Over the city on the north side rises the famous hill of Saesahuaman, crowned with the old fortress of the Incas, and separated from the mountains by the deep ravines of the streams called the Huatanay and Rodadero. The chief portion of the city is built between the two streams, with its great plaza in the centre. To westward of the Huatanay are two more fine squares, those of the Cabildo and of San Francisco. The houses of the city are built of stone, the lower portion of massive masonry of the times of the Incas, with a light modern superstructure roofed with red tile; the streets are at right angles, and afford fine vistas. The principal buildings are the cathedral, the convent of San Domingo (on a part of the site of the ancient Inca temple of the Sun), the Cabildo or Government house, a university founded in 1598, the College of Science and Arts, the Library and Museum of Incarial Antiquities, and various churches. The trade of Cuzco is chiefly in linen, wool, cotton, gold and silver work, leather, and sugar. The population, estimated at about 50,000, is chiefly Indian. The roads from Cuzco to other parts of Peru, especially that one which leads towards Quito, are most remarkable for their frail suspension bridges over the deep chasms of the Andes. A road is projected to unite Cuzco with the line which has

been completed from the coast through Arequipa towards Puno on Lake Titicaca.

The province of Cuzco, the limits of which were somewhat curtailed in the formation of the new province of Abancay in 1873, lies partly on the eastern cordillera of the Andes, and slopes thence into the forest plains of the interior, along the tributaries of the Ucayali and Marañon, to the frontier of Brazil and Bolivia.

CYBELE, or RHEA CYBELE, in Greek mythology, was the mother of Zeus and the order of deities of which he was the head. As such she was styled "mother of gods" (*θεῶν μήτηρ*), and her temple called Metroön. But though thus made to fit into the general system of deities, her worship was originally peculiar to Crete and Phrygia in Asia Minor, in both which places it was accompanied by wild orgiastic dances and music on the model of the rites which her first priests and attendants, the Curetes, Corybantes, and Dactyls, had held in her honor. It was in Crete that the infant Zeus was secluded and brought up in the guardianship of the Curetes, and there also he was said to have been buried. But the belief in the death of Zeus in this case may have arisen from the tendency of her worship to dwell on the opposites of birth and death as seen in the Phrygian story of Atys, which again, like that of Adonis, seems to illustrate the change in nature from the bloom of spring to the decay of winter. (See ATYS). In Phrygia she was on the one hand the goddess of mountains, caves, and haunts of wild animals. Her name Cybele was the Phrygian word for caves. Her proper name there was Agdistis, and she was thought of as attended by lions and panthers. On the other hand she was a goddess of vine-growing, agriculture, and town-life, wearing a mural crown, and connected in early legends with Midas, Gordias, and Marsyas, who belong also to the cycle of Bacchus, whose nurse she is sometimes called. Marsyas perfected the flute which she had invented. Midas and Gordias owed their great wealth to her. The centre of her worship in Phrygia, and the most sacred place to her anywhere, was Pessinus, where in a cave in Mount Dindymon was an image of her in the form, as was said, of a meteoric stone, which was afterwards removed to Rome. There also was the grave of Atys. Her first temple at Pessinus had been built, according to tradition, by king Midas. In later times it was kept up by the kings of Pergamus and the Romans. From Phrygia her worship passed to Lydia, where she was called Cybebe and had a temple in Sardes, thence to the coast of Asia Minor, to the mainland of Greece, and lastly to Rome. She was figured seated on a throne with a lion on her lap or under her feet, or with a lion at each side, or drawn in a chariot by lions, with a mural crown on her head, and in her hands a sceptre and a cymbal.

CYCLADES, the southern group of islands in the Ægean Sea belonging to Greece, as distinguished from the northern Sporades of the Greek archipelago, and the southern Sporades of the Asiatic portion of the archipelago, belonging to Turkey. They were originally twelve in number, and derived their name from the fact of their lying in a circle round the sacred isle of Delos, which was the smallest of the group. The twelve were Andros (the modern Andro), Ceos (Zea), Cythnos (Thermia), Delos (Mikra Dili), Rhenea (Megali Dili), Myconos (Mykono), Naxos (Naxia), Paros (Paro), Seriphos (Serpho), Siphnos (Sipheno), Syros (Syra), and Tenos (Tino). The modern Greek nomarchy of the Cyclades includes the above islands and those of Amurgo (the ancient Amorgos), Nio (Ios), Antiparo (Oliaros), Iraklia (Heraclæa), Kimolo (Kimolos), Milo (Melos), Polykandro (Pholegandros), Sikino (Sicinos), Santorin (Thera), Anaphi (Anaphe), and many other islets and rocks between these, forming together an area of 927 square miles, and having a population in 1870 of 123,299. The islands are generally high, several exceeding 2000 feet in altitude, and one or two points, as the summits of Andro and Naxia, exceeding 3200 feet; they have a varied climate and fertile soil, producing corn and fruits, wine and oil. Many of the inhabitants, who are less mixed in race than those of the mainland, are seamen and traders. Hermopolis, on the island of Syra, is the capital of the nomarchy.

CYCLONE. See ATMOSPHERE, CLIMATE, and METEOROLOGY.

CYCLOPES (*Κύκλωπες*), THE, in Greek mythology, worked with Vulcan at his forge in the heart of burning mountains, especially in Mount Ætna, the Lipari islands, and Lemnos. Their names, Brontes, Steropes, and Argæ,

indicate the noise and flash of a volcanic eruption. Finding them dangerous to his rule by their enormous strength, Kronos had confined them in the centre of the earth. In the war between the gods and Titans they were set free by Zeus, and furnished him with his thunder and lightning. Next they appear as the builders of walls of huge stones, such as those of Mycenæ, to build which they had been brought from Lycia, a volcanic country. But here they are seven in number, and seem to be of a different race. Different also are the Cyclopes of the *Odyssey*, in which they appear as a race living individually in caves,—with large herds of sheep and goats,—having only one eye, in the centre of the forehead, of enormous strength, and fearless of gods or men. The great strength and the one large round eye, from which their name is derived, they have in common with the volcanic Cyclopes, but as a race they seem to be connected with Neptune and the forces of the sea. Polyphemus was a son of the sea god.

CYNICS, a Greek sect, whose name is derived either from the fact that they originally met in the gymnasium called Cynosarges, or, in scorn of their habits and temper, from the word *κυν*, a dog. The founder of the sect was Antisthenes, a disciple of Socrates, who, adopting the Socratic doctrines that the sole aim of philosophy is to attain the knowledge of right conduct, and that the *summum bonum* is not to be found in pleasure but in virtue, pushed them to an extreme, teaching that both pleasure and theoretical knowledge are to be wholly despised, and that to be independent of outward circumstances is the highest good. All that is artificial was condemned; and the cynic was marked by his intense scorn of all other men, and the insolence with which he expressed it. The later Cynics, losing the Cynic virtue of self-control, but retaining the Cynic maxim of living according to nature, sank into mere beggars and brutal sensualists. From the time of Socrates the succession of Cynic teachers was unbroken for about a century; and in the 1st century A. D. Cynicism revived. The leading earlier Cynics were Antisthenes, Diogenes of Sinope, Crates, and Zeno; and the chief later Cynics were Demetrius the friend of Seneca, and Enomachus and Demonax, who were both alive in the time of Hadrian. For further details, see the biographies of the principal Cynics.

CY-PRES a principle adopted by the Court of Chancery in dealing with trusts. When the charitable purpose intended by a testator cannot be carried into effect, the court will apply the funds to some other purpose, as near the original as possible. For instance, a testator having left a fund to be divided into four parts—one-fourth to be used for "the redemption of British slaves in Turkey and Barbary," and the other three-fourths for various local charities—it was found that there were no British slaves in Turkey or Barbary, and as to that part of the gift therefore the testator's purpose failed. Instead of allowing the portion of the fund devoted to this impossible purpose to lapse to the next of kin, the court devoted it to the purposes specified for the rest of the estate. This doctrine is only applied where "a general intention of charity is manifest" in the will, and not where one particular object only was present to the mind of the testator. Thus a testator, having left money to be applied in building a church in a particular parish, and that having been found to be impossible, the fund will not be applied *cy-pres*, but will go to the next of kin.

CYPRESS (*Oupressus*), a genus of the sub-order *Oupressineæ*, natural order *Conifera* or *Pinaceæ*, represented by evergreen aromatic trees and shrubs indigenous to the south of Europe, the East Indies, China, California, Mexico, Guatemala, and North America. The leaves of the cypresses are scale-like, overlapping, and generally in four rows; the female catkins are roundish, and fewer than the male; the cones consist of from 6 to 10 peltate woody scales, which terminate in a curved point, and open when the seeds are ripe; the seeds are numerous and winged. All the species exude resin, but no turpentine. *C. sempervirens*, Linn., the common cypress, is a native of the Levant and Persia. It is a tapering, flame-shaped tree resembling the Lombardy poplar; its branches are thickly covered with small, imbricated, shining-green leaves; the male catkins are about 3 lines in length; the cones are between 1 and 1½ inches in diameter, sessile, and generally in pairs, and are made up of large angular scales, slightly convex exteriorly, and mucronate in the centre. In Brit-

ain the tree grows to a height of 40 feet, in its native soil to 70 or 90 feet. It thrives best on a dry, deep, sandy loam, on airy sheltered sites at no great elevation above the sea. It was introduced into Great Britain before the middle of the 16th century. In the climate of the south of England its rate of growth when young is between 1 and 1½ feet a year. The seeds are sown in April, and come up in three or four weeks; the plants require protection from frost during their first winter. The timber of the cypress is hard, close-grained, of a fine reddish hue, and very durable. Among the ancients it was in request for poles, rafters, joists, and for the construction of wine-presses, tables, and musical instruments; and on that account was so valuable that a plantation of cypresses was considered a sufficient dowry for a daughter. Owing to its durability the wood was employed for mummy cases, and images of the gods; a statue of Jupiter carved out of cypress is stated by Pliny to have existed 600 years without showing signs of decay. The cypress doors of the ancient St. Peter's at Rome, when removed by Eugenius IV., were about 1100 years old, but nevertheless in a state of perfect preservation. Laws were engraved on cypress by the ancients, and objects of value were preserved in receptacles made of it; thus Horace speaks of poems *levi servanda cupresso*. The cypress, which grows no more when once cut down, was regarded as a symbol of the dead, and perhaps for that reason was sacred to Pluto; its branches were placed by the Greeks and Romans on the funeral pyres and in the houses of their departed friends. Its supposed ill-boding nature is alluded to in Shakespeare's *Henry VI.*, where Suffolk desires for his enemies "their sweetest shade, a grove of cypress trees." The cypress was the tree into which Cyparissus, a beautiful youth beloved by Apollo, was transformed, that he might grieve to all time (Ovid, *Met.*, x. iii.). In Turkish cemeteries the cypress—

"Dark tree, still sad when others' grief is fled,  
The only constant mourner o'er the dead"—

is the most striking feature, the rule being to plant one for each interment. The tree grows straight, or nearly so, and has a gloomy and forbidding, but wonderfully stately aspect. With advancing age its foliage becomes of a dark, almost black, hue. Gilpin calls the cypress an architectural tree; "no Italian scene," says he, "is perfect without its tall spiral form, appearing as if it were but a part of the picturesquely disposed edifices which rise from the middle ground against the distant landscape." The cypress of Somma, in Lombardy, is believed to have been in existence in the time of Julius Cæsar; it is about 121 feet in height, and 23 feet in circumference. Napoleon, in making the road over the Simplon, deviated from the straight line in order to leave it standing. The cypress, as the olive, is found everywhere in the dry hollows and high eastern slopes of Corfu, of the scenery of which it is characteristic. Its superior luxuriance in that island is attributed by Professor Ansted to the calcareous nature of the soil. As an ornamental tree in Britain the cypress is useful to break the outline formed by round-headed low shrubs and trees. The *berosh*, or *beroth*, of the Hebrew Scriptures, translated "fir" in the authorized version, in 1 Kings v. 8 and vi. 15, 2 Chron. ii. 8, and many other passages, is supposed to signify the cypress, which, according to Pococke, is the only tree that grows towards the summit of Lebanon. The common or tall variety of *C. sempervirens* is known as *C. fastigiata*; the other variety, *C. horizontalis*, which is little planted in England, is distinguished by its horizontally-spreading branches, and its likeness to the cedar. The species *C. torulosa* of North India, so called from its twisted bark, attains an altitude of 150 feet; its branches are erect or ascending, and grow so as to form a perfect cone. In the Kulu and Ladakh country the tree is sacred to the deities of the elements. It has been introduced into England, but does not thrive where the winter is severe. The wood, which in Indian temples is burnt as incense, is yellowish-red, close-grained, tough, hard, readily worked, durable, and equal in quality to that of the deodar. Another East Indian species, *C. lusitanica*, or *glauca*, the "Cedar of Goa," is a handsome tree, 50 feet in height when full-grown, with spreading branches drooping at their extremities; it has been much planted in Portugal, especially in the neighborhood of Cintra. The species *C. Lawsoniana*, a native of the Shasta and Scott valleys in

North California, where it attains a height of 100 feet, was introduced into Sootland in 1854; it is much grown for ornamental purposes in Britain. Other Californian cypresses are *C. macrocarpa*, which is 60 feet high when mature, and *C. attenuata*, *C. Goveaniana*, and *C. Macnabiana*, shrubs varying from 6 to 10 feet in height. The Mexican species, *C. Knightiana*, grows to 120 feet. *C. funebria* is a native of the north of China, where it is planted near pagodas. *C. Nutkaensis*, the Nootka Sound cypress, was introduced into Britain in 1850. It is a hardy species, reaching a height of from 80 to 100 feet. See Gordon's *Pinetum*, 1875. (F. H. B.)

CYPRIAN [THASCIUS CÆCILIUS CYPRIANUS] (c. 200-258), bishop of Carthage in the 3d century, is one of the most illustrious names in the early history of the church, and one of the most notable of its early martyrs. He was born about the year 200; or, at least, this is the most reasonable conjecture as to the date of his birth, for there is no clear evidence on the subject, nor as to his age at the time of his martyrdom, which took place on the 14th September, 258. He was of patrician family, and highly educated, and for some time occupied as a teacher of rhetoric in Carthage, in the neighborhood of which he was born. He had either inherited or acquired considerable wealth. Of an enthusiastic temperament, accomplished in classical literature and the rhetorical art which he taught, he seems while a pagan to have courted discussion with the converts to Christianity. Confident in his own powers, he entered ardently into what was no doubt the great question of the time at Carthage as elsewhere. He sought to vanquish, but was himself vanquished by, the new religious force which was making such rapid inroads on the decaying paganism of the Roman empire. Cæcilius, a presbyter of Carthage, is supposed to have been the instrument of his conversion, and he assumed this name accordingly at his baptism, which seems to have taken place about 245 or 246.

Cyprian carried all his natural enthusiasm and brilliant powers into his new profession. He devoted his wealth to the relief of the poor and other pious uses; and so, according to his deacon Pontius, who wrote a diffuse and vague account of his "life and passion," "realized two benefits—the contempt of the world's ambition, and the observance of that mercy which God has preferred to sacrifice." The result of his charity and activity as a Christian convert was his unanimous call by the Christian people to the head of the church in Carthage. "His reluctant diffidence was overpowered by the acclamations of the whole city, who envired his house and compelled him by their friendly violence to assume the distinguished and, it might be, dangerous office. He yielded to preserve the peace of the city."

The time was still one of fierce persecution directed against the Christians according to the temper or caprice of the Roman emperors; and the head of the church at Carthage became a prominent object of attack. During the persecution of Decius in 250 he was exposed to imminent danger, and was compelled for a time to seek safety in retreat. Under Gallus, the successor of Decius, the persecution was relaxed, and Cyprian returned to Carthage. Here he held several councils for the discussion of the affairs of the church, especially for grave questions as to the rebaptism of heretics, and the readmission into the church of the *lapsi*, or those who had fallen away through fear during the heat of the Decian persecution. Cyprian, although inspired by lofty notions of the prerogatives of the church, and inclined to severity of opinion towards heretics, and especially heretical dissentients from the divine authority of the episcopal order and unity of Christendom, was leniently disposed towards those who had temporarily fallen from the faith. He set himself in opposition to Novatian, a presbyter of Rome, who advocated their permanent exclusion from the church; and it was Cyprian's influence which probably guided the tolerant measures of the Carthaginian synods on the subject. This question plunged him into controversy, of which, as well as many other matters, we have an interesting glimpse in the numerous letters which he wrote during his episcopate, and which have been preserved to our time.

Among the early documents of church history there are few more interesting memorials than these letters of Cyprian, addressed to a great variety of friends, particularly to two bishops of Rome, Cornelius and Stephen, and dealing with many points of church discipline and doctrine. They



show clearly the substantial equality of all Christian bishops at the time, who all equally received the name of "pope" (papa), and addressed each other as colleagues. The bishop of Carthage, for example, speaks of "his brother" the bishop of Rome, and does not hesitate to dispute his opinion when it does not seem to him a good or sound one. Stephen of Rome had espoused the cause of one Basilides, a bishop of Spain, who had been deposed from his see; but Cyprian manfully defends (*Epist. lxxvii.*) the sentence pronounced against the latter, and does not hesitate to say in the same epistle that Basilides had gone to Rome and deceived there his colleague Stephen (*Stephanum collegam nostrum sefellit*). Some of the letters were written during his retirement under the Decian persecution—the forty or nearly that number, which stand first in the series,—others belong to the later period of his life, and a few to a still earlier period. It is by no means easy to determine their several dates, as the first of the series (according to Migne's order, that usually followed), which is one of the most interesting of the whole, is without any chronological indication. We give a sentence or two from this letter, as showing the more human, poetical, and pleasing aspect of Cyprian's character. It is the vintage time when he writes to his "dearest Donatus," and both the season and the place, he says, invite to repose. "The pleasant aspect of the gardens harmonizes with the gentle breezes of a mild autumn in soothing and cheering the senses; . . . the neighboring thickets insure us solitude; and the vagrant trailings of the vine branches, creeping in pendent mazes among the reeds that support them, have made for us a leafy shelter. Pleasantly here we clothe our thoughts in words."

Valerian followed Gallus upon the imperial throne in 253, and the persecutions of the Christians were soon renewed. Cyprian was at first banished from Carthage, but found refuge in a pleasant retreat at Ceribia, "near the sea-shore, in a spot shaded with verdant groves, beside a clear and healthful stream of water." But soon he was recalled, taken into custody, and finally condemned to death. The severity of Valerian spared the mass of the Christian people, and vented itself chiefly on the bishops who refused to sacrifice to the emperor. When brought before the proconsul, the great bishop of Carthage was briefly interrogated: "Art thou Thascius Cyprian, the bishop of so many impious men? The emperor commands thee to sacrifice." Cyprian replied, "I will not sacrifice;" and, persisting in his refusal, notwithstanding remonstrances, he was condemned to death. On hearing his sentence, Cyprian only said, "God be thanked!" and, being conducted to a neighboring field, he was beheaded.

Besides his letters, various brief treatises of Cyprian have descended to modern times, on such subjects as "The Lapsed," "The Unity of the Church," "The Lord's Prayer," "Works and Alms." But the characteristics of his time and of his own mind are chiefly to be sought in his letters. A general account of him will be found in any of the larger church histories, as those of Milman, Neander, Schaff. (J. r.)

CYPRUS, one of the largest islands in the Mediterranean, situated in the easternmost basin of that sea, at nearly equal distance from the coasts of Asia Minor to

and 34° 35' E. long., so that it is situated in almost exactly the same latitude as Crete. Its greatest length is about 145 miles, from Cape Drepano in the west, to Cape St. Andrea in the north-east; and its greatest breadth, from Cape Gata in the south, to Cape Kormakiti in the north, reaches nearly 60 miles; while it retains an average width of from 35 to 50 miles through the greater part of its extent, but narrows suddenly to less than 10 miles in about 34° long., and from thence sends out a long narrow tongue of land towards the E. N. E. for a distance of more than 45 miles, terminating in Cape St. Andrea. It is the third largest island in the Mediterranean, considerably exceeding in area both Corsica and Crete.

**Mountains.**—Great part of the island is occupied by two mountain ranges, both of which have a general direction from west to east. Of these the most extensive as well as the most lofty is that which fills up almost the whole southern portion of the island, and is generally designated by modern geographers as Mount Olympus, though that name appears to have been applied by the ancients only to one particular peak. The highest summit is known at the present day as Mount Troödos, and attains an elevation of 6590 feet. It sends down subordinate ranges or spurs of considerable altitude on all sides, one of which extends to Cape Arnauti (the ancient Acamas), which forms the north-west extremity of the island, while others descend on both sides quite to the northern and southern coasts. The main range is continued eastwards by the lofty summits known as Mount Adelphi and Mount Machera (both of them, however, considerably inferior to Troödos) until it ends in the somewhat isolated peak called Oros Stavro, or Hill of the Holy Cross. This mountain, which is evidently the one designated by Strabo as Mount Olympus, is only 2300 feet high, but is a conspicuous object from Larnaca, from which it is only 12 miles distant, and is well known from being frequented as a place of pilgrimage.

The northern range of mountains, which is not known by any collective name, begins at Cape Kormakiti (the ancient Crommyon), and is continued from thence in an unbroken ridge to the eastern extremity of the island, Cape St. Andrea, a distance of more than 100 miles. It is very inferior in elevation to the southern range, its highest summits not attaining to more than about 3200 feet, while in the eastern portion they but rarely exceed 2000 feet. But it is remarkable for its continuous and unbroken character—consisting throughout of a narrow but rugged and rocky ridge, descending abruptly to the south into the great plain of Lefkosia, and to the north to a narrow plain bordering the coast.

**The Messaria.**—Between these two mountain ranges lies a broad tract of plain, extending quite across the island from the Bay of Famagosta to that of Morphu on the west, through a length of nearly 60 miles, with a breadth varying from 10 to 20 miles. It is known by the name of the Messaria, and is watered by two streams, both of which descend from the mountains on the south; but on reaching the plain the one turns eastward and flows into the Bay of Famagosta, close to the ruins of Salamis, the other flows westward into the Bay of Morphu. The greater part of this plain is open and uncultivated, and presents nothing but barren downs; but corn is grown in considerable quantities in the northern portions of it, and there is no doubt that the whole is readily susceptible of cultivation. It is remarkable that Cyprus was celebrated in antiquity for its forests, which not only clothed the whole of its mountain ranges, but covered the entire central plain with a dense mass, so that it was with difficulty that the land could be cleared for cultivation. At the present day the whole plain of the Messaria is utterly bare and treeless, and it is only the loftiest and central summits of Mount Olympus that still retain their covering of pine woods. The disappearance of the forests has naturally affected the rivers, which are mostly mere torrents, dry in summer. The most considerable is that called in ancient times the Pediseus, which, as already mentioned, traverses the plain of the Messaria, and falls into the sea near Salamis. But even this does not reach the sea in summer, and its stagnant waters form marshes which contribute much to the unhealthy character of the plain.

**Minerals.**—Next to its forests, which long supplied the

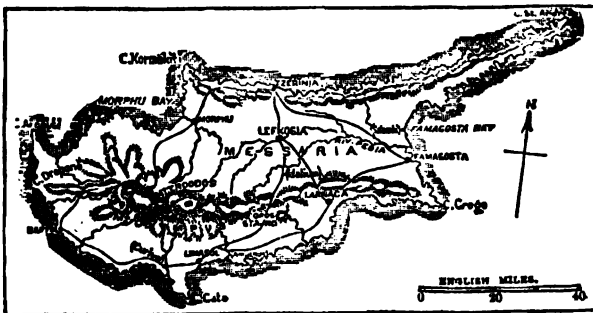

Island of Cyprus.

the north and of Syria to the east. The headland of Cape Kormakiti, in Cyprus, is distant about 46 miles from Cape Anamur, in Cilicia, and its north-east point, Cape St. Andrea, is about 60 miles from Latakiah, in Syria. It lies between 34° 30' and 35° 40' N. lat., and between 32° 15'

Greek monarchs of Egypt with timber for their fleets, Cyprus was celebrated among the ancients for its mineral wealth, especially for its mines of copper, which were worked from a very early period, and continued to enjoy such reputation among both Greeks and Romans that the modern name for the metal is derived from the term of *Æs Cyprium*, or *Cuprium*, by which it was known to the latter. According to Strabo, the most valuable mines were worked at a place called *Tamasus*, in the centre of the island, on the northern slopes of Mount Olympus, but their exact site has not been identified, and no mines are at present worked in Cyprus. Besides copper, according to Strabo, the island produced considerable quantities of silver; and Pliny records it as producing various kinds of precious stones, among which he mentions diamonds and emeralds, but these were doubtless nothing more than rock crystal and beryl. But the mineralogy and geology of Cyprus have as yet been very imperfectly explored. Salt, which was in ancient times one of the productions for which the island was noted, is still made in large quantities, and there are extensive salt works in the neighborhood of *Larnaca* and *Limasol*.

*Vegetable Products.*—Cyprus was noted among the ancients for its fertility and beauty; and under the Venetian rule it carried on an extensive trade in its various natural productions; but this has greatly declined in modern times. Besides corn, however, the island exports considerable quantities of wine, oil, madder, the fruit of the carob tree, silk, and wool. Tobacco and cotton are also grown in small quantities, and their cultivation might doubtless be largely increased. The small plains at the foot of the range of Mount Olympus, between the underfalls of the mountains and the sea, as well as the narrow strip of level land along the north coast, though limited in extent, are districts of great fertility; the latter especially is described by Colonel Leake as one of the most beautiful and best cultivated districts in Turkey. The great central plain, on the contrary, is in many parts marshy and unhealthy; and indeed the whole interior of the island suffers much from unhealthiness, and is subject to fevers of a peculiarly dangerous description.

*Harbors.*—One of the greatest disadvantages of Cyprus is the want of ports, there not being a good natural harbor in the whole island. *Larnaca* and *Limasol*, which are the chief places of trade at the present day, have nothing but mere roadsteads; and *Salamis*, which was the chief port of the island in antiquity, as well as *Famagosta*, which held that position under the Venetians, were only artificial harbors upon an open sandy coast. *Tzerinia*, on the north coast, which serves as the place of direct communication with the mainland of Asia Minor, has a very small and bad port, which, bad as it is, is the only one on this side of the island.

*Towns.*—The only towns in Cyprus worthy of notice are the following. 1. *Lefkosis*, or, as it is more commonly called, *Nicosia*, has since the time of the Lusignan kings been the capital of the island. 2. *Famagosta*, on the east coast, near the ruins of *Salamis*, also first rose to importance under the Lusignan dynasty, by whom it was fortified, and continued under the Venetians to be the chief port, as well as the strongest fortress in the island. It became celebrated by its heroic defence against the Turks in 1571. It still retains its external walls, but is a very poor and decayed place, with only a few hundred inhabitants. 3. *Larnaca*, on the south-east coast, on the site of the ancient *Citium*, is now the chief place of trade, and the most rising and flourishing town in the island. It contains from 5000 to 6000 inhabitants, and consists of two portions—the old town, a short distance inland, and the *Marina*, immediately facing the sea, where the foreign consuls reside, and foreign steamers touch, which gives a degree of life and activity to the place unknown to the rest of Cyprus. Recent excavations have discovered here many interesting remains of the ancient city of *Citium*. 4. *Limasol*, on the south coast, some miles west of the site of *Amathus*, is still a place of considerable trade, though partially eclipsed by the rising prosperity of *Larnaca*. It is the principal place of export of the wines of Cyprus, which enjoy a high reputation throughout the Levant. 5. *Baffo*, or *Papho*, on the site of the ancient *Paphos*, called for distinction's sake *New Paphos*, at the south-west angle of the island, has a small but insecure port, and is a very small place, though still the seat of a Greek bishop. 6.

*Tzerini* or *Tzerinia* (the ancient *Kerynea*) has been already mentioned. It retains its old Venetian fortifications, and has therefore still the air of a town, but is a very inconsiderable place.

The population of the island, which is said to have amounted under the Venetians to not less than 1,000,000 (probably, however, a great exaggeration), is now estimated at about 135,000 souls, of whom about two-thirds are Greeks, the rest principally Turks.

*History.*—The early history of Cyprus is very obscure and imperfectly known. It is certain, indeed, that it was colonized at a very early period by the neighboring Phœnicians, who introduced the worship of the goddess *Asharoth* (called by the Greeks *Astarte*, and identified by them with their own *Aphrodite*), for which the island always continued to be celebrated in ancient times. But nothing is historically known of the period or extent of these Phœnician settlements. Equally uncertain is the history of the Greek colonies in the island, which are found in historical times existing side by side with the Phœnicians. Their foundation was ascribed by popular legend and tradition to the heroic ages—*Salamis*, for instance, being supposed to have been founded by *Teucer*, the brother of *Ajax*—but there can be little doubt that they were in reality posterior to the Phœnicians. Of the relations between the two we know little, except from conjecture or inference; but it seems probable that the Greeks gradually established a political supremacy, while the Phœnicians continued to form an important element in the population, and exercised an influence over the manners and customs, arts, and religious rites of the inhabitants in general, wholly different from anything found in *Crete*, *Rhodes*, or the other islands of the *Ægean*. The first positive fact in the history of Cyprus is its conquest by the Egyptian king *Amasis* in the 6th century B. C. (*Herodot.*, ii. 182). It did not, however, long continue subject to the Egyptian monarchy, having revolted on occasion of the invasion of Egypt by *Cambyes* (525 B. C.), when it declared in favor of the Persians, and became thenceforth a tributary province of the Persian empire.

On the occasion of the Ionian revolt in 500 B. C. the Cyprians were persuaded to take part in the insurrection, but after a year's interval were again reduced to subjection, and contributed a contingent of not less than 150 ships to the Persian fleet under *Xerxes* (*Herod.*, vii. 90)—a striking proof of the power and prosperity they at this time possessed. During the subsequent wars between the Greeks and Persians Cyprus was frequently the scene of hostilities; and after the peace of *Antalcidas* (387 B. C.), *Evagoras*, king of *Salamis*, succeeded in extending his authority over the greater part of the island, as well as in rendering himself independent of the Persian monarch. This state of things, however, did not last long; and after the death of *Nicoles*, the son and successor of *Evagoras*, the island again became tributary to the Persian empire. But after the battle of *Issus*, when *Alexander* advanced into Phœnicia, all the cities of Cyprus declared in his favor, and sent their fleets to assist him in the siege of *Tyre*.

During this period, though the island was subject, with brief intervals, to Persia, the several cities enjoyed the privilege of local self-government. Their institutions, however, presented one marked difference from those of other Greek cities, that they were always governed by kings, of whom there were not less than nine in the island. The cities which were the seats of these petty monarchies were:—1. *Salamis*, on the east coast, the most important of the Greek colonies, which often held a kind of supremacy over the whole island; 2. *Citium*, on the same site as the modern *Larnaca*, originally a Phœnician settlement, and which always retained a predominant Phœnician character, and became only partially Hellenized; 3. *Amathus*, on the south coast, near *Limasol*, also a Phœnician colony; 4. *Curium*, some miles further west, at a spot now called *Episkopi*; 5. *Paphos*, at the south-west angle of the island, sometimes called *New Paphos*, in order to distinguish it from the more ancient Phœnician city of the name, called in the days of *Strabo* *Palæ Paphos*, which was one of the principal seats of the worship of *Astarte*, the Phœnician *Venus*; 6. *Marium*, afterwards called *Arsinoë*, on the north coast, at a short distance from the promontory of *Acamas*; 7. *Soli*, on the same coast, further east; 8. *Kerynea*, which still retains its ancient site and name as *Tzer-*

inia; 9. Lapathus, or Lapethus, on the same coast, intermediate between the two cities last mentioned. Others, however, assign this ninth place to Chytri, a town of the interior, on the road from Salamis to Kerynea, and it is likely that the sovereign cities were not always the same. Several other towns are mentioned by Strabo and Ptolemy, which were apparently in earlier times subject to those above enumerated. Idalium and Golgos, the names of which are celebrated from their connection with the worship of Venus, seem to have been merely sanctuaries or holy places, which had grown up around the temples of the goddess, and, in Greek times at least, were never towns of importance.

After the death of Alexander, the possession of Cyprus, so important from its position and on account of its inexhaustible forests, became an object of contention among his successors. After various vicissitudes it passed into the hands of Ptolemy, king of Egypt; but in 306 B. C. a great effort to recover it was made by Demetrius, the son of Antigonus, who reduced the whole of the rest of the island and laid siege to the capital city of Salamis. The attempt of Ptolemy, who arrived with a great fleet, to raise the siege, led to one of the most memorable naval battles in all antiquity, in which Ptolemy was utterly defeated; and Salamis, with all the rest of Cyprus, passed into the power of Demetrius. He did not, however, long retain his new acquisition; the island was recovered by Ptolemy in 295 B. C., and continued thenceforth to form one of the most valuable possessions of the Greek monarchs of Egypt. It was generally placed under the government of a man of the highest rank, who was often a kinsman of the Egyptian king; and during the dissensions of the royal family which marked the declining period of the Ptolemaic dynasty, Cyprus was more than once held by one of the rival candidates as an independent sovereignty. In this manner it was governed as a separate kingdom by Ptolemy Lathyris for not less than 18 years (from 107 to 89 B. C.), and it was held by a younger brother of Ptolemy Auletes, in 58 B. C., when it was determined by the Romans to dispossess him,—an act of shameless aggression, which was proposed by the tribune Clodius, and reluctantly carried into effect by Cato. From this time Cyprus became a Roman province; it was at first united with Cilicia, but afterwards was constituted as a separate government.

The most remarkable event in the history of Cyprus, while it was under the Roman empire, was a great revolt of the Jews, who had established themselves there in large numbers, in which they are said to have destroyed not less than 240,000 of the other inhabitants (117 A. D.). Christianity, which had been introduced into the island by St. Paul, quickly rose to a flourishing condition, and not less than thirteen bishoprics were established in the island. After the division of the Roman empire Cyprus naturally passed, with all the neighboring countries, into the hands of the Eastern or Byzantine emperors, to whom it continued subject, with brief intervals, for more than seven centuries. In 646 the Arabs under the caliph Othman made themselves masters of the island, and destroyed the city of Salamis, which had until that time continued to be the capital. But it was recovered by the Greek emperors two years afterwards; and, though again conquered by the Arabs under the reign of Haoum el Raschid (802), it did not long remain in their hands, and lapsed again into the power of the Byzantine empire. In 1184, Isaac Comnenus, the nephew of the reigning emperor, established himself in possession of Cyprus as an independent sovereignty; but during the third crusade (1195) it was wrested from his hands by Richard I., king of England, who bestowed it upon Guy de Lusignan, the titular king of Jerusalem, as some compensation for the loss of the holy city.

From this time Cyprus was governed for nearly three centuries by a succession of kings of the same dynasty, who introduced into the island the feudal system and the other institutions of Western Europe. During the latter part of this period, indeed, the Genoese made themselves masters of Famagosta—which had risen in place of Salamis to be the chief commercial city in the island—and retained possession of it for a considerable time; but it was recovered by King James II., and the whole island was reunited under his rule. His marriage with Catharine Cornaro, a Venetian lady of rank, was designed to secure the support of the powerful republic of Venice, but had the effect after a few years, in consequence of his own death and that of his

son James III., of transferring the sovereignty of the island to his new allies. Catharine, feeling herself unable to contend alone with the increasing power of the Turks, was induced to abdicate the sovereign power in favor of the Venetian republic, which at once entered into full possession of the island (1487).

The Venetians retained their acquisition for about eighty years, notwithstanding the neighborhood of the Turks. It was not till 1570 that the latter, under Selim II., made a serious attempt to conquer the island, in which they landed an army of 60,000 men. The greater part of the island was reduced with little difficulty; Nicosia, the capital, was taken after a siege of 45 days, and 20,000 of its inhabitants put to the sword. Famagosta alone made a gallant and protracted resistance, and did not capitulate till after a siege of nearly a year's duration (August, 1571). The terms of the capitulation were shamefully violated by the Turks, who put to death the governor Bragadino with the most cruel torments. Since that time Cyprus has remained in the hands of the Turks, and its history has been almost a blank. A serious insurrection broke out in 1764, but was speedily suppressed; another in 1823 became the occasion of a frightful massacre of the Greek population. Meanwhile the prosperity of the island was continually declining. It is only of late years that the increasing commerce of the western nations of Europe with the Levant has given some stimulus to trade, and encouraged the cultivation of the natural productions of an island which, under more favorable circumstances, might be one of the richest in the Mediterranean.

Though Cyprus has been visited and described by several travellers—among others by Dr. Pococke (*Description of the East*, Lond., 1743), by Mariti (*Viaggi per Pisola Cypro*, 1769), and more recently by M. Seiff (*Reisen in der Asiatischen Türkei*, 8vo, Leipzig, 1875)—there is no full and comprehensive account of it, such as we possess of Crete and many parts of Asia Minor. The work of Engel (*Cyprus: eine Monographie*, 2 vols. 8vo, Berlin, 1841) is a diligent compilation of all that could be gathered from ancient authorities concerning the geography, history, and mythology of the island, but was not based upon any original researches. Its geology and natural history are still very imperfectly known, and its antiquities had, until lately been almost entirely neglected. But within the last few years extensive excavations have been carried on in different parts of the island—especially at Golgos, Idalium, and Curium—by Mr. Lang and General di Cesnola, which have brought to light a vast number of statues and other works of art of the highest interest, as throwing light on the religion and mythology of the inhabitants—which appear to have always presented a singular mixture of the Hellenic and Oriental elements—as well as displaying a peculiar style of art, in some degree intermediate between that of Assyria and continental Asia on the one hand and the early Greek sculptures on the other. Unfortunately these collections have been removed to New York, while no detailed description of them has yet been published. It is, however, announced that General di Cesnola is engaged in a comprehensive work giving an account of his researches and their results, which will doubtless throw much light on the ancient geography and history of Cyprus.<sup>1,2</sup> (E. H. B.)

<sup>1</sup> In 1868 Mr. R. H. Lang discovered the site of a temple at Idalium (Dall) containing a large number of statues in calcareous stone, of which a selection was acquired by the British Museum, along with a bilingual inscription—in Phœnician and Cypriote—found there also. From this inscription Mr. George Smith obtained the key to the Cypriote language, which had not previously been deciphered, and which now proves to be a dialect of Greek written in a local character. With this key Dr. Birch has published a reading of the Duc de Luynes tablet, known as the "tablet of Dall," in the *Transactions of the Soc. of Bib. Archaeology*, vol. i. pt. ii. 1872. Dr. Brandis in the *Monatsbericht of the Berlin Academy*, 1873, has given a full list of all the words of Cypriote that are now fairly made out, and since then a collection of Cypriote inscriptions (*Sammlung Cyprioter Inschriften*, Jena, 1876) has been published by Moritz Schmidt. An account of Mr. Lang's excavations, and the sculptures discovered by him, will be found in the *Transactions of the Roy. Soc. Lit.*, 2d ser. x. pt. i. At the same time excavations were being carried on at the various ancient sites of Cyprus by the American consul, General di Cesnola, and were continued up to 1878, the result being the discovery of an enormous quantity of sculpture, inscriptions, pottery, gold ornaments, gems, and other articles of treasure stored up in temples or in tombs. These antiquities have been acquired by the Museum of New York. The most interesting part of his discovery was the treasure from the underground chamber of a temple at Curium, including a pair of solid gold armlets inscribed in Cypriote with the name of a King Eteandros, whose date is assigned to about 668 B. C. The engraved Greek gems and gold ornaments are of great beauty.

<sup>2</sup> [By Turkish convention of June 4, 1878, the administration of the island was ceded to Great Britain, which reduced it at once to a practical colony as a counterpoise to Russian gains in Asia and the Balkan peninsula.—AM. Ed.]

CYRENAICA, or PENTAPOLIS, in ancient geography, a district of Africa, on the shores of the Mediterranean Sea, lying exactly opposite to Greece, at the distance of about 250 miles. It received the name of *Cyrenaica* from Cyrene, its chief city; and that of *Pentapolis* from the fact of its containing five principal cities, Berenice or Hesperus, Barce, Cyrene, Apollonia, and Arsinoë or Teucheira, now identified respectively with Benghazi, El Merdj, Grennah or Shahat, Marsoe, Sousah, and Tocra. The district extended inland about 80 miles, and included that portion of the African continent which stretched from the frontier of Egypt on the east to the borders of Africa Propria on the west, which were marked by the tumuli of Aræ Philænorum. On its southern frontier Cyrenaica is protected from the scorching winds of the Sahara by a range of lofty mountains which descend in gradual slopes to the sea, and produce within a small compass a great variety of climate and temperature. Its vegetable products consequently comprised all the more important species to be found in the tropical and temperate zones; and, as its position was admirably adapted for commerce, nothing was wanting but an enterprising population to make it one of the most valuable countries in the world. The people of Thera, under Battus, a native of that island, were the first to colonize Cyrenaica. After a slight opposition from the native tribes, they established themselves in the country, and founded Cyrene in 631 B. C. There soon sprang up in advantageous situations other cities which, while acknowledging Cyrene as the capital of the country, were really independent, and at length threw off its yoke altogether. After the invasion of Cambyses the regal form of government was entirely abolished, and the republican substituted in its room. Under the Ptolemaic dynasty of Egypt (with which country Cyrenaica was incorporated in 321 B. C.), Cyrenaica rose into great importance from the extent and value of its commerce. In 96 B. C. it was bequeathed by will to the Romans by Apion, the last lineal representative of the Ptolemies. Soon afterwards, but at what date is not absolutely fixed, it became a Roman province, and along with the island of Crete was governed by a Roman proconsul. The commercial prosperity of Cyrenaica, however, continued unimpaired till the revolt of the Jews in the province during the reign of Trajan. This revolt was quelled only after the most bloody atrocities had been perpetrated on both sides; and the population was so much diminished in the contest, that the native tribes recommenced their incursions, and overran the province up to the walls of the principal cities. In the middle of the 7th century the whole country passed into the hands of the Saracens. From that time till the present the country has been occupied by tribes of wandering Arabs, nominally subject to the pasha of Tripoli.

See Thirge, *Historia Cyrenæ*, 1819; in which all the passages of the ancient writers about Cyrene are brought together; Gottschick, *Geschichte der Gründung und Blüte des Hellen. Staats in Cyrene*, 1858; Falbe and Lindberg's *Numismatique de l'Asie Mineure*; and Grote's *History of Greece*, vol. iv.

CYRENAICS, a Greek school of philosophers, so called from Cyrene, the birthplace of their founder, Aristippus, who was a disciple of Socrates. They held that the one aim in life is to enjoy as many moments of as intense pleasure as possible. The pleasures of sense are to be preferred as the most intense, for duration and intensity are the only qualities in which pleasures really differ. For the wise choice of pleasures intellectual cultivation is needed, and there must also be self-control and power of resisting desire. According to Aristippus, what each is to seek is his own present pleasure, though he modified this teaching by his doctrine of self-control. But his follower Theodorus held, like the Epicureans, that permanent tranquillity and cheerfulness are to be sought rather than passing pleasures. The position of Hegesias, the advocate of suicide, who is counted among the Cyrenaics, is far apart from that of Aristippus, with him avoidance of trouble is the highest attainable good. Anniceris the younger differed from Aristippus in declaring that selfish pleasures are to be sometimes sacrificed to sympathetic. Other members of the school were Arete, the daughter of Aristippus, Aristippus, her son, Bio, and Euhemerus.

See, besides the histories of philosophy, and works on the various members of the school separately, Diog. Laert.; Wendt, *De Philosophia Cyrenaica*; H. v. Stein, *De Philosophia Cyrenaica*; Mullaach, *Fragmenta Phil. Græc.*, vol. ii.

CYRENE, the capital of Cyrenaica, was situated on the northern slope of a lofty table-land nearly 2000 feet above the level of the sea, from which it was ten miles distant. It was the first town of Cyrenaica founded by Battus and his Therman followers (see CYRENAICA), and very soon rose into great importance as a commercial mart. The policy of Battus led him to conciliate the aboriginal tribes of Libya, with whom his subjects began at an early period to form matrimonial alliances. The natives, however, as in all colonies formed on the principles of Spartan policy, were scrupulously excluded from any participation in the government of the state. For eight generations, as had been foretold by the Delphic oracle, Cyrene continued to be governed by the original dynasty, whose kings ruled under the names of Battus and Arcesilaus alternately; and it maintained its prosperity till the time of the Ptolemies, who, carrying out their usual policy, fostered Apollonia, the port, to such an extent that the inland city soon fell into decay.

Cyrene was noted among the ancients for the intellectual life of its inhabitants. Its medical school was famous, and it numbered among its celebrities Callimachus the poet, Carneades, the founder of the New Academy at Athens, Aristippus, a pupil of Socrates and the founder of the so-called Cyrenaic school, Eratosthenes the polyhistor, and Synesius, one of the most elegant of the ancient Christian writers.

The ruins of the town cover a great extent of ground, but have been sadly defaced by the various races which have overrun the country. Cyrene and the district to east, the north, and the west, is called Shahat by the Arabs; while the ancient designation, under the modified form of Ghrennah, is applied to the district to the south. The first account of the site in modern times seems to be that of M. Lemaire, who was French consul at Tripoli in the time of Louis XIV. Paul Lucas visited the spot in 1710, and again in 1723, and Dr. Thomas Shaw in 1738; an Italian, Dr. Cavelli, who was there in 1812, furnished some information to the Société de Géographie de Paris; and Della Cella published an account of his visit in his *Travels* translated into English in 1822. In 1821-2 important explorations were made by Lieutenant Beechey, R. N.; and he was almost immediately followed by a French artist, M. Pacho, whose pencil preserved a number of interesting monuments that have since disappeared. M. Delaporte, French consul at Tangier, and Vattier de Bonville come next in order of time. Barth, the famous African traveller, published an account of his investigations in his *Wanderungen durch die Küstenländer des Mittelmeers*, 1849. In 1861 excavations were made on the site of the city by Captain Murdoch Smith, R. E., and Commander Porcher, R. N., the results of which are detailed in their valuable *Discoveries in Cyrene*, London, 1864. The principal buildings of which the plan can be more or less clearly distinguished are three theatres, a small Doric temple of Bacchus, a temple of Apollo (Beechey's temple of Diana), two temples hypothetically assigned to the worship of Venus, and a large many-chambered structure, supposed to be the palace of the Roman governor. All are composed of a friable yellow sandstone, containing a great number of shells. The temples are remarkable for the eastern position of the main entrance. Of the ancient sculpture of the city several fine specimens were exhumed and conveyed in safety to the British Museum—a statue of Bacchus, a colossal statue of Apollo playing on the Lyre, a bust of Cneus Cornelius Lentulus Marcellinus, the first Roman propraetor of Cyrene, a fine portrait-head in bronze, etc. Far more imposing than the remains of its buildings are the long lines of tombs which occupy the scarped fronts of all the hill sides, and stretch out along the various roads leading from the city. These consist of two kinds—the excavated and the constructed,—the former being the best preserved, and, it would seem, the most spacious and elaborate. Many of the finer examples have large temple-like entrances with Doric columns cut out of the rock, and bear traces of internal decoration of the most costly and brilliant kind. On the walls of one which still preserved its colors at the time of its discovery in 1861 was depicted a procession of thirty-six individuals in various costumes, as well as hunting scenes and games. A favorite sepulchral ornament appears to have been a large scallop-shell sculptured in marble and placed above the sarcophagus recess. The city was furnished with water by means of a perennial fountain now known to scholars as

the fountain of Apollo, and to the Arabs as 'Ain Shahat, remarkable for the artificial tunnel through which it passes. In 1864 Mr. George Dennis, vice-consul at Benghazi, proceeded to examine the tombs of the Cyrenaica, and obtained a fine series of painted Greek vases of the red-figure and polychrome styles, which are now in the British Museum. An account of his excavations will be found in the *Transactions of the Royal Soc. of Literature*, 2d ser. ix. p. 135.

CYRIL [CYRILLUS], saint and bishop of Jerusalem. He was born probably at Jerusalem about 315, and died about 386. He was ordained a presbyter in 345, and had the instruction of the catechumens confided to him. In 350 he was elevated to the see of Jerusalem, and became deeply involved in the dogmatic controversies of his time. His metropolitan, Acacius of Cæsarea, inclined to Arianism, while Cyril strongly espoused the Nicene creed. The result was the temporary deposition of Cyril. On the death of the emperor Constantine, however, he was restored; but again, on the accession of Valens, an Arian emperor, he had once more to resign his post till the accession of Theodosius permitted him to return finally in peace in 379. He attended the second œcumenical council held at Constantinople in 381, where he was received with grateful acclamations for his sufferings in defence of orthodoxy. Cyril has left one important work—his 23 Catecheses (*Κατηχήσεις*) or lectures mainly addressed to those who were preparing for baptism; the last 5, under the name of the Mystagogic Catecheses, were addressed to newly baptized persons. These lectures are said to be "the first example of a popular compend of religion," and are particularly interesting for the insight which they give us both into the creed-forms of the early church and the various ceremonies of initiation constituting baptism in the 4th century. Other tracts and homilies have been ascribed to Cyril of Jerusalem, but they are of doubtful genuineness. The Catecheses of Cyril have been translated in the Oxford Library of the Fathers, vol. ii.

CYRIL, of Alexandria (376–444), is a more distinguished father of the church than his namesake of Jerusalem. He was born in 376, and died in 444. Becoming patriarch of Alexandria about 412, he soon made himself known by the violence of his zeal against Jews, pagans, and heretics or supposed heretics alike. He had hardly entered upon his office when he closed all the churches of the Novatians and seized their ecclesiastical effects. He assailed the Jewish synagogues with an armed force, drove the Jews in thousands from the city, and exposed their houses and property to pillage. The prefect of Egypt, Orestes, who endeavored to withstand his furious zeal, was in turn denounced himself, and had difficulty in maintaining his ground against the fury of the Christian multitude. It was during one of the violent commotions kindled by the strifes of these parties in Alexandria that the illustrious Hypatia, famed for her beauty and her eloquent advocacy of the Neo-Platonic philosophy in opposition to Christianity, was murdered. Her murder has been attributed to the direct instigation of the patriarch himself; but this charge is held unsupported by others, although there can be no doubt that "the perpetrators were officers of his church," and undoubtedly drew encouragement from his own violent proceedings. Hypatia was a friend of Orestes, and the hostility betwixt the prefect and the patriarch overflowed towards her, and undoubtedly led to her destruction.

But Cyril's violence was not merely confined to those who might be considered enemies of the church. He inherited from Theophilus, his uncle and predecessor in the see of Alexandria, a strong aversion to John Chrysostom, the noble bishop of Constantinople, and even after his death opposed for a time all attempts to remove the unjust sentence of condemnation which had been passed upon him. Afterwards he so far yielded to remonstrances, and allowed the name of Chrysostom to appear in the list of distinguished martyrs and bishops mentioned in the prayers of his church. These names were inserted in what were called "diptychs" (*δίπτυχα νεκρών*), or two-leaved tablets preserved in the churches—a usage which the Greek Church has preserved to this day. Nestorius, a successor of Chrysostom in the see of Constantinople, received a still larger share of Cyril's intemperate opposition. Nestorius had refused to apply the title "Mother of God" to the Blessed Virgin. The patriarch of Alexandria denounced this heresy to Nestorius himself, to the emperor (the feeble Theodosius II.), and to the empresses, the mother and sister of Theodosius. The

altercation grew in bitterness as it advanced, until at length Nestorius was excommunicated and driven from his see in 430. The two opponents met at the œcumenical council summoned at Ephesus in the following year to dispose of the intricate question raised by the use of the terminology in dispute. Each came "accompanied by a rabble of followers—Cyril by the bath men and a multitude of women from Egypt, Nestorius by a horde of peasants and some of the lower populace of Constantinople" (Milman's *Latin Christ.*, i. 160). The result was the condemnation of Nestorius, although Cyril also incurred the charge of heresy from the Oriental bishops. Satisfied, however, with the deprivation and exile of his opponent, he returned to Alexandria in triumph as the great champion of the faith, and thence continued, by the "unscrupulous use of all the means at his command," the theological strife for years.

Altogether Cyril presents a character not only unamiable, but singularly deficient in all the graces of the Christian life. He may, as Milman says (*Latin Christ.*, i. 145), be a hero or even a saint to those "who esteem the stern and uncompromising assertion of certain tenets the one paramount Christian virtue; but, while ambition, intrigue, arrogance, rapacity, and violence are proscribed as unchristian means—barbarity, persecution, bloodshed, as unholy and unevangelic wickedness, posterity will condemn the orthodox Cyril as one of the worst of heretics against the spread of the Gospel." Baur, however, says that Cyril must be placed high as a theologian, and that he sought upon the whole to preserve faithfully the spirit of the Alexandrian school. He has left, besides commentaries, and homilies and letters chiefly relating to the Nestorian controversy, a treatise on the Trinity and the Incarnation, and an apologetic work in defence of Christianity against the attack of the Emperor Julian, also a definite treatise against Nestorius—*Κατὰ τῶν Νεστορίου δοσσημῶν πεντάββλος ἀντίρρητος*.

CYRIL, a celebrated professor of the ancient law college of Berytus, and one of the founders of the œcumenical school of jurists (*τῆς οἰκουμένης διδάσκαλος*) which preceded the succession of Anastasius to the Eastern empire (491 A.D.), and paved the way for Justinian's legislation. His reputation as a teacher of law was very great; and from the fragments of his works which have been preserved it may be inferred that his merit as a teacher consisted in his going direct to the ancient sources of law, and in interpreting the best writers, such as the Commentary of Ulpian on the Edict and the *Responsa Papiniani*. He wrote a treatise on definitions (*ἰσχύνημα τῶν δεσφόντων*), in which, according to a statement of his contemporary Patricius, the subject of contracts was treated with superior precision and great method, and which has supplied the materials for many important scholia appended to the first and second titles of the eleventh book of the *Basilica*. He is generally styled "the great Cyril," to distinguish him from a more modern jurist of the same name, who lived after the reign of Justinian, and who compiled an epitome of the Digest.

CYRUS THE ELDER. Like other natural heroes, Cyrus, the founder of the Persian empire, has been surrounded with an atmosphere of myth. Already in the time of Herodotus (i. 95) four different stories were current among the Persians concerning his origin and his relation to the last king of Media. The one preferred by Herodotus is probably the most legendary of all four; at any rate it has the same source as the tales told of Perseus or Romulus, or other popular heroes who survived exposure and obscurity to revenge themselves upon the tyrant, and be restored to the royal dignity. Cyrus, Herodotus states, was the son of Cambyses, a Persian prince, and Mandane, a daughter of the Median king Astyages, in whose name we may see the *Ashi dahaka* ("the biting snake") of Zend mythology, the Ahi or "serpent" of darkness of the Veda, the Zohak of Firdusi's epic; and of whom Moses of Chorene declared in the 4th century of our era that popular songs still spoke as Ajdahak, the wicked serpent. In consequence of a dream Astyages delivered Cyrus to Harpagus to be put to death. Harpagus transferred the order to the king's herdsman Mitrdates, whose wife Cyno, "the bitch," persuaded him to bring up the child as his own, instead of exposing it, and a still-born infant was sent to Harpagus in its place. At the age of ten Cyrus was discovered and recognized by Astyages, who punished Harpagus by making him eat the flesh of his own son. Cyrus returned to Persia; and some years afterwards Harpagus,

who had never forgotten the injury he had suffered, induced him to raise the standard of revolt. Harpagus, appointed commander of the Median forces, went over to the enemy, the Medes were defeated, and Astyages taken prisoner. He was kept in prison till his death, while Cyrus made the Medes subservient to the Persians.

Xenophon in the *Cyropædia*, where the life of a model prince rather than of the historical Cyrus is depicted, agrees with Herodotus in making Cyrus the grandson of Astyages, though he calls his father Cambyses an independent king. Cyrus received, we are told, the simple and hardy education of a Persian up to the age of twelve, when he visited the luxurious and effeminate court of Media, and while there gained the admiration of his grandfather by repelling an unprovoked attack of Evil-Merodach, the son of Nebuchadnezzar. Astyages was succeeded by his son Cyaxares II., on whose death the Median empire passed peaceably into the hands of Cyrus, now forty years old.

A third account is given by Nicolas of Damascus. According to this Cyrus was the son of the Persian satrap Atradata, and spent the greater part of his youth in the court of Astyages at Ecbatana. Having escaped by a stratagem and evaded the pursuit of the Medes, he led the Persians into revolt, and attempted to stem the attack of the Median monarch. The Persians, however, were defeated in four great battles, in one of which Atradata was slain, and Pasargade, the Persian capital, was besieged. Here the tide of fortune turned, the insignia of royalty fell into the hands of Cyrus, and Astyages was overtaken and captured during his flight. The whole of Media at once submitted to the conqueror.

The version of Ctesias is totally unlike either of the preceding three. Like Nicolas of Damascus he denies that Cyrus was in any way related to Astyages, whose daughter Amytis was the wife of Spitaces, or Spitamas, a Mede. Cyrus, after his escape from Media, invaded the country and defeated Astyages, who fled to Ecbatana and was there concealed by Amytis. The Persian Cebars, however, discovered his hiding-place; but Astyages was well treated by Cyrus, and died a natural death. Cyrus put Spitaces to death and married Amytis.

None of these versions can be regarded as satisfactory. The cuneiform inscriptions have proved that Persia could not have been a mere dependency of Media, as Darius declares that eight ancestors had been kings like himself, while Cyrus calls himself, on a brick from Senkereh, "the son of Cambyses, the powerful king." The Persian conquest of Media, moreover, must have been a slow process. Xenophon (*Anab.*, iii. 4) describes Larissa and Mespila on the Tigris as strongly-fortified cities which had been built by the Medes after the overthrow of Nineveh, but ruined by the Persians during the Median war. Mespila had afforded refuge to a wife of the Median monarch.

The conquest of Media and the consequent establishment of the Persian empire is fixed somewhat doubtfully at 559 B. C. According to Strabo (xv. p. 729) the earlier name of Cyrus was Agradates; if so, he must have changed it about this period, borrowing his new title perhaps from the River Cyrus, near Pasargade. In any case the name Cyrus (Old Persian, *Kurus*) cannot be connected with the later Persian *Khor* or *Khorshéd*, "the sun," which would be *uvara* in the Persian of the Achæmenian epoch (Zend, *huare*). The reduction of Media must have occupied a considerable time, as it was not until 546 B. C. that Cyrus found himself strong enough to face Croesus of Lydia, who had entered into alliance with Egypt and Babylonia. Without waiting for his allies, however, Croesus crossed the Halys, and a drawn battle was fought in Pteria. The Lydian king returned to Sardis and disbanded his forces, believing that Cyrus would not undertake a winter campaign. This belief proved illusive; Cyrus followed the enemy, defeated the Lydian army in spite of its bravery, besieged Sardis, and took it within fourteen days. A Greek legend accounted for the preservation of Croesus and his future position as confidential counsellor in the Persian court.

The conquest of the Greek cities of Ionia followed, and a revolt that broke out in Sardis under Pactyes during the absence of Cyrus caused the general disarmament of the Lydians and the reduction of Lycia and Caria.

Cyrus now turned his attention to the East—Parthia, Sogdiana, Arachosia, and the neighboring countries being added to the empire. According to Ctesias, Bactria had

submitted on the marriage of Cyrus with Amytis; and the most formidable campaign Cyrus had to undertake in the East was against the Sacæ. According to one story, Cyrus was taken prisoner in this campaign; according to another, Sparethra, the queen of the Sacæ, gained important advantages over the Persians. Pliny states that Kapisa (perhaps the modern Kafshan), near the Upper Indus, was destroyed by Cyrus; and Arrian's assertion that a Persian army was lost in the desert of Gedrosia is confirmed by the fact that this country formed part of the Persian empire in the reign of Darius.

In 539 B. C. Babylonia was attacked. Nabonidus, the Babylonian king, called Labynetus by Herodotus, had been preparing for the invasion for years. Cyrus carried with him the water of the Choaspes for drinking, and delayed a whole summer and autumn on his march in order to dissipate the River Gyndes, in which one of the sacred white horses had been drowned. The Jews settled in Babylonia hailed the Persians as deliverers and monotheists, and it was doubtless in return for the assistance they had afforded that Cyrus permitted them to return to their country and restore Jerusalem and the temple. Nabonidus, defeated in the field, took refuge in Borsippa, while the Persians laid siege to Babylon, where Belshazzar, the son of Nabonidus, was in command. Babylon was taken during a feast; Nabonidus surrendered and was sent to Carmania, and the sceptre of Nebuchadnezzar passed to Persia.

Instead of reducing Phœnicia, which had resumed its freedom, Cyrus led his troops across the Araxes against the Massagetae. At first victorious, he was afterwards defeated and slain (538 B. C.) by the Massagetic queen Tomyris, the double of Sparethra, after a reign of twenty-nine years (*Herod.* i. 208-214). According to Ctesias, however, this campaign was against the Derbices and their Indian allies, and Cyrus died of a wound received in battle three days after gaining a complete victory over them. The conquest of Egypt was left to a successor, Cyrus having made this side of his empire secure by restoring the Jews to Palestine.

The tomb at Murghâb cannot be that of Cyrus, as is often supposed. Murghâb, like Persepolis, is on the Araxes, while Pasargade (Persian, *Pasîryânâdâ*, "valley of springs"), where Cyrus was buried, was on the Cyrus (Kur). The cuneiform inscription at Murghâb points to a period subsequent to the accession of Darius, as does also the Egyptian head-dress of the figure below it. Andreas suggests that the Cyrus Achæmenides mentioned in the inscription is the viceroy of Egypt, brother of Xerxes, called Achæmenides by Ctesias, whose corpse was brought to Persia to be buried there. Pasargade, and the real tomb of Cyrus, must be looked for near Darabjerd, in south-eastern Farsistân.

(A. H. S.)

CYRUS THE YOUNGER was the son of Darius Nothus, and of Parysatis, and the brother of Artaxerxes Mnemon. He was sent by his father at the age of sixteen to assist the Lacedæmonians against the Athenians. Artaxerxes succeeded to the throne on the death of Nothus; and Cyrus, who deemed himself, as born after his father's accession to the throne, the legitimate successor, sought to dispossess him. His attempt would have been punished by his death, had not his mother Parysatis saved him by her tears and entreaties. This circumstance did not in the least check his ambition. He was appointed satrap of Lydia and of Asia Minor, where he secretly fomented rebellion, and levied troops under various pretences. At last he took the field with an army of 100,000 barbarians and 13,000 Greeks, under the command of Clearchus; and Artaxerxes met him near Cunaxa with a force said to have numbered 900,000 (401 B. C.). The battle was long and bloody, and Cyrus might perhaps have obtained the victory, had not his rashness proved his ruin. The two royal brothers met in person, and Cyrus was slain. Artaxerxes was so anxious to have it believed that his brother had fallen by his hand, though this does not seem to have been the case, that he put to death two of his subjects for boasting that they had killed Cyrus. The Greeks who were engaged in the expedition obtained much glory in the battle, and after the death of Cyrus they remained victorious in the field without a commander. Their homeward march in face of the vastly superior numbers of the enemy is known in history as the Retreat of the Ten Thousand, and forms the subject of Xenophon's most popular work, the *Anabasis*.

CYTHERA. See CEBIGO.

**CYZICUS**, an ancient town of Mysia, in Asia Minor, on the coast of the Propontis or Sea of Marmora, occupying the narrowest part of a peninsula which was at one time an island, and was said to have been joined to the mainland by Alexander the Great by moles and bridges. During the Peloponnesian war, Cyzicus was subject to the Athenians and Lacedæmonians alternately, as the power of either state predominated; and at the peace of Antalcidas, like the other Greek cities in Asia, it was made over to Persia. The greatness and prosperity of the town did not commence till about 74 B. C., when the Cyzicenes, under circumstances of great difficulty, repelled Mithridates from their walls, and kept the town till relieved by Lucullus. For their bravery and devotion at this time they were rewarded with peculiar honors and privileges by the Romans, and presented with a large tract of the rich land adjoining their city. Seriously injured by an earthquake in the reign of Antonius Pius, Cyzicus from that period gradually declined. The ruins of Cyzicus, which once boasted a very large number of splendid temples and public buildings, are still to be seen among the cherry orchards and vineyards that have overgrown its site. They are known by the Turkish name of Balkiz, which is probably a corruption of Παλαιά Κιζίκος. The principal buildings still clearly distinguishable are a Roman amphitheatre and a temple dedicated to Hadrian; but there are also remains of the city-walls and towers. Great damage has been inflicted within modern times by the spoliation of the Turks, who have carried off the ancient materials for the erection of public edifices in Constantinople. The coins of Cyzicus have been found in large numbers, and are of great interest to the numismatist for the light they furnish on the history of ancient coinage. They were current at Athens and other parts of Greece; and the device by which they were frequently distinguished probably gave rise to the proverb about bribery—There is an ox on his tongue, βούρ ἐπὶ γλῶσσοι.

**CZACKI, TADEUSZ** (1765–1813), a Polish statesman and author, who did much for the spread of education in Poland, was born at Poryck in Volhynia, of good family. After being educated at Cracow, he went to court and gained the favor of the king, Stanislaus Augustus Poniatowski, by whom he was appointed to several high dignities. In the diet which sat from 1788 to 1792 he took a prominent place, and he was one of the advocates of the constitution which was passed in May, 1791. Consequently his property was confiscated by the Czarina Catherine II. It was, however, restored by her successor Paul I.; and Alexander I. appointed him councillor. The great aim of Czacki's life was now to further education in Poland. In 1805 he opened a school at Krzemienietz, which was soon filled by about 600 pupils of both sexes, and he effected the establishment of a very large number of schools in other parts of the country. He also assisted in the foundation of the Scientific Society of Warsaw, and the Polish Commercial Society. He was twice examined by Russian commissions on a charge of having disseminated views hostile to Russia, but on both occasions he was acquitted. His chief school, that at Krzemienietz, was destroyed by the French invasion of 1812. In the February of the next year Czacki died at Dubno. A statue was raised to his memory, and placed in the library at Krzemienietz.

Among the works of Czacki, the treatise on Polish and Lithuanian law, which is full of valuable information on many subjects connected with these countries (Warsaw, 1801, Breslau, 1835), and those on the Jews, gypsies, and the statistics of Poland, deserve special mention. See the lives of Czacki by his friends Polański and Motowski (the latter of which appeared in the supplement to the *Biographie Universelle*), which, however, differ considerably as to the facts of his life; that by Osinski (Krzemienietz, 1816); and the *Dictionary of Learned Poles*, by Chokodyniski (1823).

**CZARTORYSKI, PRINCE ADAM GEORGE** (1770–1861), a principal actor in the Polish revolution of 1830, was born at Warsaw, January 14, 1770. He was the eldest son of Prince Adam Casimir Czartoryski; and, after receiving a careful education in his father's house, he completed his studies in France and Great Britain, spending some time at Edinburgh University and in London. On his return to Poland he entered the public service, and in the war occasioned by the second partition of Poland he fought bravely against the Russians. In 1795 he was sent, with his brother Constantine, as a hostage to St. Petersburg.

Here he became the intimate friend of the grand duke (afterwards emperor) Alexander; and in 1797 he was appointed ambassador to the court of Sardinia. This office he held about five years; and in 1802 Alexander I. named him assistant at the ministry of foreign affairs. In this capacity he was present at the battle of Austerlitz, subscribed a treaty with Great Britain, and accompanied the czar in the campaign of 1807 and at the conferences of Tilsit. He then retired from public life; but in 1812 was again by the side of the emperor, and accompanied him to Paris in 1814. Prince Adam George had been named curator of the new university of Wilna in 1803, a post which he held for nearly twenty years; and during this period, while outwardly loyal to the Russian Government, his influence powerfully contributed to keep alive and intensify the patriotic spirit of his countrymen. In 1815 he was named senator palatine of the kingdom. He attended the first diet, and spoke bravely and hopefully in favor of constitutional government; but his efforts were fruitless, and his hopes vanished.

In 1821 charges of disaffection and sedition were made against the students of Wilna, and very severe measures were taken,—many being imprisoned, and others sent to Siberia, or compelled to serve in the army. Prince Adam George interceded for the young men, but was not listened to. He consequently resigned his office of curator, and for the next nine years he remained in retirement. The revolution of 1830 once more brought him to the front. He became president of the provisional government of Poland, convoked the diet, and when the throne was declared vacant was chosen head of the national government (January, 1831). He continued to hold the presidency till the terrible and decisive days of August (15th and 16th), and then served as a common soldier in the final struggles, in which once more, by the overwhelming forces of Russia and the disintegrating forces of internal dissension, Poland fell. The prince patriot escaped to Paris. He was excluded by name from the amnesty of 1831, and his estates in Poland were confiscated. The large revenue of his Gallician estates, however, enabled him to maintain the position of a noble of the highest rank. He enjoyed the unbounded esteem of his countrymen, and was the recognized head of Polish society at Paris. In 1848 he granted freedom to the peasants on his estates in Galicia, and gave them their lands in fee. He died at Paris, July 15, 1861.

**CZASLAU, or CASLAU**, a town of Bohemia, the chief place of the circle of the same name, situated near the left bank of an affluent of the Elbe, in a fertile plain 48 miles E.S.E. of Prague, on the North-west Railway from Vienna. The church is surmounted by a lofty spire, the highest in Bohemia, and contains the tomb of the celebrated Hussite leader Ziska, who died in 1424. Here (or more accurately at the village of Chotusitz, 2½ miles north of this) Frederick the Great defeated the Austrians, May 17, 1742. Population of 1869, 5993, chiefly agriculturists.

**CZECHS**, or phonetically *Tscheks*, a large branch of the Slavonic race, which includes the Bohemians or Czechs proper, the Hannacks or Moravians, and the Slovacks. Besides forming the predominant element in Bohemia and Moravia, where they are estimated respectively at 2,930,000 and 1,352,000, they contribute 614,000 to the population of Hungary, where they are mainly settled on the N.W. frontiers, 93,000 to Austrian Silesia, 60,000 to Prussian Silesia, and a considerable percentage to Austria proper, Bukovina, and Slavonia. See **BOHEMIA**.

**CZEGLLED**, a market town or large village of Hungary, in the district of Pesth, and 38 miles south-east of that city, situated on the bare sandy and fertile plain which extends between the Danube and Theiss. Some parts of the surrounding country yield large quantities of red wine, and this, with the cultivation of maize and millet and beer brewing, gives the occupation and trade of the place. Population of commune in 1869, 22,216.

**CZENSTOCHOVA, or TCHENSTOCHOW**, OLD and NEW two small contiguous towns of Poland, in the circle of the same name and the government of Piotrkov, on the left bank of the Warta, 130 miles S.W. of Warsaw, and on the railway between that city and Cracow. Population of the two (1867), 14,167. The towns derive their importance from a celebrated monastery situated on the eminence called the Jasno Gura above them. This monastery, which is surrounded by a small fortress, has a fine church with a chapel dedicated to the Virgin, containing a famous and much-ven-

erated picture of the mother of Christ, which according to legend was painted by St. Luke. Pilgrims from all parts of Poland visit the shrine in large numbers. In 1655 the monastery withstood a siege by the Swedes in the War of Succession, and another by the Russian troops in 1771, during the War of Independence.

CZERNOWITZ, or CZERNAUZ, the capital town of the Austrian duchy of Bukowina, in 48° 26' N. lat. and 25° 57' E. long., picturesquely situated on a height above the right bank of the river Pruth, 140 miles S.E. of Lemberg, 720 feet above the sea. The line of railway from Cracow and Lemberg to Galatz on the Lower Danube passes by Czernowitz. It is a clean, pleasant town, possessing for its chief buildings a Greek cathedral, a theological seminary, and several schools; and it is the seat of an archbishop, of an Oriental Greek patriarch, and of the metropolitan of Bukowina. A fine bridge of 720 feet in length crosses the Pruth with six spans. There are manufactures of machinery and bronze work, and a considerable trade is carried on with Moldavia and Bessarabia in grain, brandy, cattle, hides, wood, wool, and potashes. Population with suburbs (1869), 33,884.

CZERNY, KARL (1791-1857), pianist and composer, was born at Vienna on the 21st February, 1791. His father, who was a teacher of the piano, trained him for that instrument from an early age with such success that he performed in public at the age of nine, and commenced his own career as a teacher at fourteen. He was brought under the notice of Beethoven, and was his pupil in the sense in which the great master had pupils. It is, perhaps, his greatest claim to distinction as a performer that he was selected to be the first to play Beethoven's celebrated Emperor concerto in public. He soon became the most popular teacher of his instrument in a capital which abounded in pianists of the first rank. Among his pupils he numbered Liszt, Döhler, and many others who afterwards became famous. As a composer he was prolific to an astonishing degree, considering the other demands on his time. His works, which included every class of composition, numbered 849 at the time of his death. Comparatively few of them possess high merit, and none are destined to the immortality that belongs to the productions of genius. He had considerable skill in devising variations for the piano of the display type, and in this and other ways helped to develop the executive power which in the modern sensational school of pianoforte playing seems to have reached the limits of the possible. His various books of exercises, elementary and advanced, of which the best known are the *Études de ia Vélocité*, have probably had a wider circulation than any other works of their class. To the theory of music he contributed a translation of Reicha's *Traité de Composition*, and a work entitled *Umriss der ganzen Musikgeschichte*. Czerny died on the 15th July, 1857, at Vienna, which he seldom left, one of the few exceptions being a visit paid to England in 1836. Having no family, he left his fortune, which was considerable, to the Vienna Conservatorium and various benevolent institutions.

CZERNY GEORGE (? 1766-1817), or KARDJORDJE, or Black George, as he is always called, though his name was properly George Petrovitch, a Servian who freed his country from the domination of the Turks, born about 1766, was the son of a Servian peasant. He was about twenty when, having killed a Turk in some wild adventure, he was forced to flee into Austria. It is said that he forced his father, or his stepfather or father-in-law, to accompany him; but the old peasant could not be persuaded to leave his country, and, to prevent his falling into the pitiless hands of the Turks, Czerny George put him to death with a pistol-shot. In the Austrian army Czerny George fought against the Turks from 1788 to 1791, and rose to the rank

of sergeant; but either unwilling to submit to discipline or disgusted by some slight, he left the service for the life of a *heyduc* or bandit who preyed only upon the Mahometans. He afterwards, however, is said to have held an appointment as inspector of forests to a monastery in Austria.

For a time Servia was under the mild rule of Hadji Mustapha, and Czerny George lived on his farm in peace. But the Janissaries overran the country, killed the Pasha, and began to murder the Servian chiefs. Many escaped, however, and, headed by Czerny George, who was chosen commander-in-chief, summoned every male Servian to arms. The sultan sent troops against the Janissaries, who were overwhelmed, and their leaders executed. But the Servians now refused to receive again the yoke of the Turks, Russia supported their claim to independence, and war commenced. Czerny George commanded his countrymen with fiery enthusiasm, rough vigor, and considerable ability. Several victories over the Turks were won; and, in October, 1806, the independence of Servia was recognized by the Porte, a tribute only being exacted, and the sign of Turkish sovereignty maintained by the residence at Belgrade of a Turkish officer with a very small force. The Turks refusing, however, to give up Belgrade and Schabaz, both towns were taken by Czerny George by assault, and the Janissaries and Turks in both were massacred in cold blood.

Czerny George, as commander-in-chief, now became the ruler of Servia, and till 1813, despite strong opposition in the Servian senate and constant danger from the Turks, he maintained his position. His elevation made no change in his habits. He continued during peace to cultivate his farm at Topola with his own hands, and he never laid aside his coarse peasant's dress. He had received no school education, and was never able to write. In general, he was moody and taciturn, though, when excited, he was fond of joining in the village dances. His passion was terrible; he killed his warmest adherent in a fit of anger. His execution of justice was stern and prompt; he hanged his own brother for assaulting a girl, and forbade his mother to make any signs of mourning. In war he displayed marvellous energy and valor, and he had the power of inspiring his followers with the fierce enthusiasm by which he was himself animated.

In 1809, on the outbreak of war between Russia and Turkey, Czerny George, who had formed the scheme of achieving the independence of all the Slavonic countries under the rule of Turkey, took up arms against the Turks, and, after attempting to excite a revolt in Bosnia, marched on Herzegovina. The Turks at this juncture invaded Servia; and Czerny George, though wishing to place the country under the protection of Austria, was forced to seek the aid of Russia. A vigorous attempt was now made to dispossess him of the supreme power, but he forced his opponents to submit or flee the country. The treaty of Bucharest (May, 1812), however, while depriving the Servians of the protection of Russia, failed to claim for them sufficient guarantees from the Turks, in whose hands all the Servian fortresses were placed. In June, 1813, the Turks again entered Servia, and Czerny George, in despair, with almost all the Servian chiefs, took refuge in Austria.

Four years after, having been persuaded that his countrymen were only awaiting his signal to burst into revolt, he ventured to return in disguise into Servia. He discovered himself to Vuitza, an officer who had served under him, by whom he was basely murdered (27th July, 1817), at the instigation of Milosch Obrenovitch, a Servian senator, who had come to a compromise with Turkey and obtained the chief power, and was jealous of the popularity of the old chief. See SERBIA, and Ranke's *Die Serbische Revolution*.

## D.

**D** IN the English alphabet, the fourth letter, and the third consonant, represents the dental sonant sound, to which T is the corresponding surd (see B). It is the fourth letter also in the Hebrew, Chaldee, Samaritan, Syriac, Greek, and Latin alphabets. The form of our D is the

same as that of the Latins; and the Latin D is no other than the Greek Δ; in old Latin, and in several of the Greek alphabets, including those of South-western Italy, from which the Roman alphabet was borrowed, we find the form >: the right hand corner was rounded for convenience of



writing. The Greek symbol, again, is borrowed from the ancient Phœnician character, called in Hebrew *Daleth*. D is found in English (according to Grimm's law) where *θ* will be found in Greek, and *f* in Latin: thus our *deer* is the Greek *θηρ*, and Latin *fera*. In Old High German the corresponding word was rightly spelt with a *t* (*tior*); but this is now spelt *thier*, though the sound is the same. By the same law *d* appears in Greek and Latin where we find *t* in English and *s* in High German: thus we have *divo*, *duo*, *two*, *suet*. D sometimes became *t* in Latin; thus *Ulysses* represented *Ὀδυσσεύς*; sometimes it became *r*, as in *arbiter* for *ad-biter*. In prænomens D stood for *Decimus*, and in the titles of emperors for *Divus*. It is also a numeral letter, representing *five hundred*. This may arise from the circumstance that the letter D is analogous in form to IO, the half of CIO, which is the Roman numeral expression for a *thousand*. With a dash placed on the top thus, *D̄*, its value is increased tenfold, or, in other words, it stands for *five thousand*. Used as an abbreviation, D has various significations, for which see the article ABBREVIATIONS.

<sup>1</sup> DACCA [DHAKA], the principal district in the division of the same name,<sup>1</sup> in Bengal, British India, situated between 24° 20' 12'' and 23° 8' 30'' N. lat., and between 89° 47' 50'' and 91° 1' 10'' E. long. It is bounded on the N. by Maimansinh, on the E. by Tipperah, and on the S. and W. by Bâkarganj and Jaridpur. The district consists of a vast level plain, divided into two sections by the Dhaleswarî river. The northern part, again intersected by the Lakshmiâ river, contains the city of Dacca, and as a rule lies well above flood-level. The soil is composed of red ferruginous *kankar*, with a stratum of clay in the more elevated parts, covered by a thin layer of vegetable mould, or by recent alluvial deposits. The scenery along the Lakshmiâ is very beautiful, the banks being high and wooded. About 20 miles north of Dacca city, small ridges are met with in the Madhupur jungle, stretching into Maimansinh district. These hills, however, are mere mounds of from 20 to 40 feet high, composed of red soil containing a considerable quantity of iron ore; and the whole tract is for the most part unproductive. Towards the city, the red soil is intersected by creeks and morasses, whose margins yield crops of rice, mustard, and *til* seed; while to the eastward of the town, a broad, alluvial, well-cultivated plain reaches as far as the junction of the Dhaleswarî and Lakshmiâ rivers. The country lying to the south of the Dhaleswarî is the most fertile part of the district. It consists entirely of rich alluvial soil, annually inundated to a depth varying from 2 to 14 feet of water. The villages are built on artificial mounds of earth, so as to raise them above the flood-level.

*Rivers*.—Dacca is watered by a network of rivers and streams, ten of which are navigable throughout the year by native cargo boats of four tons burthen. (1) The Meghnâ forms the eastern boundary of the district, separating it from Tipperah. (2) The Ganges, or Padma river, marks the western and south-western boundary, separating the district from Faridpur and Bâkarganj. This river, here from three to four miles in width, is liable to frequent and extensive changes in its course; the old channel is now almost dry in the hot months. (3) The Lakshmiâ, a branch of the Brahmaputra, flows through the north of the district and empties itself into the Dhaleswarî. (4) The Jamunâ, or main stream of the Brahmaputra, only touches on the north-western corner of the district, where it joins the Ganges. (5) The Mendi-Khâlî, a large branch of the Meghnâ, communicates with the old Brahmaputra. (6) The Dhaleswarî, an offshoot of the Jamunâ, intersects the district from west to east, and falls into the Meghnâ at Munshiganj. It has two large navigable branches, both of which reunite with the parent-stream, viz., (7) the Ghâzî-khâlî and (8) the Burigangâ.

The wild animals comprise a few tigers, leopards, and wild elephants, deer, wild hog, porcupines, jackals, foxes, hares, otters, etc. The green monkey is very common; porpoises abound in the large rivers. Among birds are vultures, crows, several varieties of eagles, fish eagles, kites,

falcons, owls, swallows, kingfishers, woodpeckers, *sylnas*, green paroquets, spoonbills, *sâras*, *mânikjors*, herons, pelicans, *shill ibis*, adjutants, *bulbuls*, gulls, cormorants, coots, plovers, snipe, pigeons, doves, partridges, wild geese and ducks, etc. A trade is carried on in bird feathers, principally in those of the kingfisher tribe. The common fishes are the shark, ray, saw-fish, *anwâri* or mullet, *tapsi mâchh* or mango fish, *hilsâ*, *chitâl*, *kallâ*, *ruî*, *mirgal*, *kai*, *khalisâ*, crabs, cray-fish, prawns, etc. Crocodiles are found in most of the large rivers. Among snakes are the cobra, *sanda*, *girgî*, *bamânt*, *goatsnp*, python, etc., and several varieties of tree and water snakes.

*Agriculture*.—Rice forms the staple product of the district. It is divided into three great classes:—*boro*, or spring rice, sown from December to February, and reaped in April and May; *âus*, or autumn rice, sown from March to May, and reaped from July to September; and *âman*, or winter rice (the great crop of the year), sown from March to May, and reaped in November and December. Wheat and barley are cultivated to a small extent; pulses are largely grown; also oilseeds, such as mustard, *til*, and linseed. Cotton was formerly a staple product, but since the decline of the fine Dacca muslins, due to the introduction of Manchester goods, its cultivation has almost entirely ceased. Jute cultivation has enormously extended of late years. The other crops raised are indigo, sugar-cane, *pân* or betel leaf, cocoa-nut, turmeric, ginger, tobacco, and safflower. Of the area of the district in 1870 (viz., 3217 square miles) 2245 are returned as cultivated, 24 as fallow land, 672 as cultivable waste land, and 276 as uncultivable. No statistics exist showing the cultivation of each kind of crop. But roughly speaking, it may be said that in the rains three-fifths of the cultivated area is under rice, one-fifth is fallow or uncultivated, and one-fifth under jute; and that in the dry season, two-fifths is under oil seeds and pulses, two-fifths fallow or uncultivated, and one-fifth under other crops.

The *manufactures* consist of weaving, embroidery, gold and silver work, shell carving, and pottery. The weaving industry and the manufacture of fine Dacca muslins have greatly fallen off, owing to the competition of European piece goods. Forty different kinds of cloth were formerly manufactured in this district, the bulk of which during many years was made from English twist, country thread being used only for the finest muslins. Those of the most delicate texture were known by the name of *âb-râwdn*, or "running-water" and *shabnam*, or "evening dew." It is said that, in the time of the Emperor Jahângîr, a piece of *âb-râwdn* muslin, 15 feet by 3, could be manufactured, weighing only 5 *sikkâs*, or 900 grains, its value being £40. In 1840, the finest cloth that could be made of the above dimensions weighed about 9 *sikkâs*, or 1600 grains, and was worth £10. Since then the manufacture has still further decayed, and the finer kinds are not now made at all except to order. The manufacture of indigo is largely carried on with European capital. The great trading centres are Nârâinganj and Madanganj, at the confluence of the Lakshmiâ and Dhaleswarî rivers, on opposite banks. Nârâinganj may be termed the port of Dacca, from which it is distant about 9 miles by land, and 16 or 18 by water. It constitutes the great south-eastern mart on the Jamunâ, and has regular steam communication with Calcutta and the Assam districts. The general revenue of the district increased from £86,926 in 1860-61 to £111,620 in 1870-71; and the civil expenditure in the same period from £44,666 to £49,803. The land tax contributes about one-half of the general revenue, and amounted in 1870-71 to £53,672. There are 8 magisterial and 25 civil and revenue courts, besides 1 honorary magistrate's court, situated in the district. The regular police consists of a force of 430 officers and men, besides a municipal and rural police. For educational purposes, there is a Government college at Dacca city, together with 148 Government or aided schools, attended in 1871 by a total of 7155 pupils, besides numerous unaided village schools, for which no statistics exist.

*Diseases*.—Cholera and small-pox occasionally visit the district in an epidemic form. The principal endemic diseases are—intermittent and remittent fever, elephantiasis, bronchocele, enlargement of the spleen, dysentery and diarrhœa, rheumatism, catarrh, whooping cough, bronchitis, ophthalmia, cutaneous diseases, and intestinal worms. Cattle disease is also common. Five charitable dispensaries are maintained in the district, one of which,<sup>1</sup>

<sup>1</sup>The Division or Commissionership of Dacca is under the Lieutenant Governor of Bengal, and comprises the districts of Dacca, Maimansinh, Bâkarganj, Faridpur, and Tipperah (transferred from the Chittagong to the Dacca Division in 1876). It is bounded on the N. by the Gârô Hills, on the E. by Sîlhet and the state of Hill Tipperah, on the S. by the Bay of Bengal, and on the W. by Jessour Pabnâ, Bogrâ, and Rangpur. The Division contains a total area of 14,276 square miles, with a population of 9,126,663 souls.

Mitford Hospital, is the largest institution of the kind in Bengal out of Calcutta. There are also a lunatic asylum and an almshouse for indoor paupers.

**Population.**—The Bengal census of 1872 returned the population of Dacca district at 1,852,998 persons (males, 908,775; females, 947,218), distributed over 2897 square miles, and residing in 5016 villages or towns, and 290,593 houses. The population is thus classified according to religion:—Hindus, 798,789, or 42·9 per cent.; Muhammadans, 1,050,131, or 56·7 per cent.; Buddhists, 4; Christians, 7844, or ·4 per cent.; "others," 1226. The proportion of males in the district population was 48·9 per cent. Six towns contain a population of over 5000, viz.:—(1) Dacca city (*g. v.*), population 69,212; (2) Mánikganj, population: Hindus, 6381; Muhammadans, 6159; and "others," 2—total, 11,542; (3) Náráinganj, population: Hindus, 5200; Muhammadans, 5694; and Christians, 17—total, 10,911; (4) Sholaghal, population: Hindus, 4478; Muhammadans, 2047—total, 6525; (5) Hásará, population: Hindus, 4807; Muhammadans, 900—total, 5707; (6) Narishá, population: Hindus, 2030; Muhammadans, 3670; Christians, 37—total, 5645. The material condition of the people, particularly of the cultivating classes, has greatly improved of late years owing to the increased prices of produce, and the cultivation of more valuable crops.

**DACCA CITY**, the principal place in the above district, is situated on the left or north bank of the Burigangá river, in 23° 43' 20'' N. lat. and 90° 26' 10'' E. long. The city is bounded on the E. by a low alluvial plain stretching to the Lakshmiá river, and on the N. and N. W. by a tract of jungle interspersed with Muhammadan cemeteries, deserted gardens, mosques, and ruined houses. The streets, *bárára*, and lanes extend four miles along the bank of the Burigangá, the breadth of the town being about 1½ miles. The *chauk*, or market-place, lies at the west end, near the river bank. It is a square of considerable dimensions, surrounded by mosques and shops. The numerous streets which intersect the town are extremely crooked; and only a few are wide enough for wheeled conveyances. In parts of the city, inhabited by particular castes, such as the weavers' and shellcutters' *bárára*, where building ground lets at a high rent, many four-storied houses have a frontage of only 8 or 10 feet, while the side walls run back to a distance of twenty yards. The opposite ends of these buildings are roofed in; the middle part is left open, and constitutes a small court. The ruins of the English factory, St. Thomas's church, and the houses of the European residents lie along the banks of the river, and give the town a rather imposing appearance when viewed from the south. In the Armenian quarter are several large brick houses, for the most part now falling into decay. Of the old fort erected by Nawáb Islám Khán, in the reign of the Emperor Jahángír, no vestige remains; but the jail is built on a portion of its site. The principal Muhammadan public buildings, erected by subsequent governors and now in ruins, are the Katra and the Lal-bágh Palace,—the former built by Sultán Muhammad Shujá in 1645, in front of the *chauk*, or market place. Its extensive front faced the river, and had a lofty central gateway, flanked by smaller entrances, and by two octagonal towers rising to some height above the body of the building. The Lal-bágh Palace was commenced by Sultán Muhammad Azím, the third son of the Emperor Aurangzeb. It originally stood close to the Burigangá river; but the channel has shifted its course, and there is now an intervening space covered with trees between it and the river. The walls on the western side, and the terrace and battlement towards the river, are of a considerable height, and present a commanding aspect from the water. These outworks, with a few gateways, the audience hall, and the baths, were the only parts of the building that survived in 1840. Since then, their dilapidation has rapidly advanced; but even in ruin they show the extensive and magnificent scale on which this princely residence was originally designed. It appears never to have been completed; and when Tavernier visited Dacca, circ. 1666, the Nawáb was residing in a temporary wooden building in its court. The English factory was built about that year. The central part of the old factory continued to be used as a court-house till the present century, but owing to its ruinous state it was pulled down in 1829 or 1830; in 1840 the only portion that remained was the outward wall. The French and Dutch factories were taken possession of by the English in the years 1778 and 1781 respectively.

The trade of Dacca, which formerly was considerable,

has steadily declined since the beginning of this century. In 1800 the population of the city was estimated at 200,000, while a census in 1830 returned only 66,989 inhabitants. The city still continued to decline, and in 1867 its population was estimated at 51,636 only. The rise, however, of the jute trade in late years, and increased prices for country produce, have now begun to compensate for the loss of its cotton manufactures. The census of 1872 showed that the population of the city had increased to 69,212 souls (males, 37,395; females, 31,817) made up as follows:—Hindus, 34,433; Muhammadans, 34,275; Christians, 479; "others," 25. Sanitary improvements are being carried out; and a wealthy Muhammadan gentleman lately gave a donation of £5000 for the purpose of providing the city with a pure water-supply, and in 1875 it was proposed to light the main thoroughfares with gas. The principal local institutions are the Mitford Hospital and the Dacca Government College. Two English and several vernacular newspapers are published in the town.

**History.**—Dacca first attained political importance between 1608 and 1612. In order to check the depredations of Magh pirates from Chittagong, and the rebellions of the Afgháns, it was found necessary to remove the seat of government of Bengal from Rájmahál to Dacca, where the Nawáb Islám Khán erected a fort and increased the strength of the fleet and artillery, and changed the name of the town to Jahángír-nagar. Subsequently, in 1704, the capital of Bengal was removed to Murshidábád, and the government of Dacca and the eastern districts made over to a deputy of the Nawáb Násím. During the time of the Mughul government, the city was under the jurisdiction of a magistrate (*Jauddár*) and six *amás*, who, with the police, were maintained by rent-free grants of land. The fleet consisted of 700 war boats and state barges. Dacca was also a *dépot* for the Mughul artillery in Eastern Bengal, and possessed a mint. On the establishment of the British power the old officers and representatives of the native rulers were pensioned, but the title of Nawáb was continued in the family until 1845, when it became extinct on the death of the last incumbent without heirs. The only event of historical importance in late years was the mutiny of 1857, when two companies of the 73d Native Infantry, which were stationed in the town, joined in the revolt, but were overpowered by a small European force and dispersed. (w. w. H.)

**DACE, DARE, or DAET** (*Leuciscus vulgaris*), a freshwater fish belonging to the family *Cyprinidae*. It is an inhabitant of the rivers and streams of Europe north of the Alps, but is most abundant in those of France and Germany. It prefers clear streams flowing over a gravelly bottom, and deep, still water, keeping close to the bottom in winter, but disporting itself near the surface in the sunshine of summer. It is preyed upon by the larger predaceous fishes of fresh waters, and owing to its silvery appearance is a favorite bait in pike-fishing. The dace is a lively, active fish, of gregarious habits, and exceedingly prolific, depositing its eggs in May and June at the roots of aquatic plants or in the gravelly beds of the streams it frequents. Its flesh is wholesome, but is not held in much estimation. In appearance it closely resembles the roach, usually attaining a length of eight or nine inches, with the head and back of a dusky blue color and the sides of a shining silvery aspect, with numerous dark lines running along the course of the scales. The pectoral, ventral, and anal fins are white, tinged with pale red; and the dorsal yellowish, darkly clouded at its anterior edge. The dace feeds on worms, maggots, and other soft bodies. It is abundant in many of the streams of the south of England, but is unknown in Scotland and Ireland. See ANGLING, vol. ii. pp. 38, 39.

**DACIA**, or the country of the Daci, the ancient name of that district of Europe which lies to the N. of the Danube between the Theiss on the W. and the Dniester on the E. It thus comprehended the modern provinces of Transylvania, Wallachia, and Moldavia, the Bukowina the banat of Temeswar and other parts of Hungary, as well as the southern portions of Galicia.

The first occupants of the district with whom we are made acquainted by history are the Getæ, a rude tribe of Thracian extraction, originally settled on the right bank of the Danube. They first appear in connection with the Scythian campaign of Darius, which nominally attached them for a moment to the Persian empire. By Philip of Macedon their friendship was considered of importance, and

he married Medopa, the daughter of their king Cothelus; but they afterwards took part in the confederation of the Scythian tribes against the invasion by which Alexander the Great sought to secure his northern frontiers. About forty years later, Lysimachus, king of Thrace, made an attempt to subdue them, but he was defeated and obliged to give his daughter in marriage to their chief; and a second expedition, by which he hoped to retrieve his fortunes, left him a prisoner in their hands, and brought him under obligation to his Dacian son-in-law, Dromichetes, for the restoration of his liberty. We next hear of the Getæ as being defeated by the Gauls, by whom many of them were sold as slaves to the Athenians and other Greeks.

The Getæ gradually retire from the foreground of history, and give place to the Daci, or Daçi, as they were called in Greek, a cognate race, who seem to have migrated from Rhodope, and about 90-57 B. C. attained a stable settlement and extensive influence under their leader Burebista. It has been usual to identify the Getæ and Daci as one, but though they continued to occupy the same country, and were, at least for a time, politically united, the allusions of the ancient writers seem to point to an essential difference. At the time of the war between Octavius and Antony, the Getæ sided with the former and the Daci with the latter; and during the fifty years after the formation of the province of Mœsia the Getæ continued to disturb the Roman frontiers, while the Dacians kept peacefully at home. After 73, however, the Getæ almost completely disappear, and the Dacians come forward as one of the most powerful enemies of Rome. Their reputation was heightened by the submission which they exacted from the tyrant Domitian, and the tribute by which he was obliged to purchase immunity from their attacks. In 101 A. D. Trajan, who had succeeded to the purple, set out against them in person, and defeated them with great slaughter at a place which is still called *Prat de Trajan* (Pratum Trajani), or Crossfield, near Thorda, in Transylvania. This was followed in 104 by another invasion, in which he advanced to the Dacian capital Sarmizegethusa (now Varhely), and routed Decebalus, who soon after committed suicide. The country was reduced to a Roman province, under the jurisdiction of a legate of prætorian rank; and colonists were brought from other parts of the empire, and more especially from southern Italy. In honor of the campaign of 104 the famous column of Trajan was erected at Rome; and to secure his conquests the victor constructed three great military roads and the bridge over the Danube, which ranked as one of the architectural wonders of the world. Under Hadrian (129 A. D.) the province was divided into two parts—Upper Dacia, which probably included the Banat and the mountain region of Transylvania; and Lower Dacia, situated in the Wallachian lowlands. Under Antoninus Pius the division became threefold—Dacia Apulensis, so-called from Apulum, the modern Carlsburg; Porolissensis, from Porolissum; and Malvensis, a name of unknown derivation. Dacia remained a Roman province till 272, when Aurelian adopted the line of the Danube as the frontier of the empire. The Roman legions and colonists retired to the southern side of the river and settled in the eastern part of Upper Mœsia and the district of Dardania; while their former territory was relinquished to the Goths and other Germanic tribes. The name of Dacia, sometimes with the addition of *Nova* or *Ripensis*, was applied to the new region along the Danube, and Dardania was distinguished as *Dacia Mediterranea*, or Inland Dacia. After the time of Constantine the designation, in its wider use, included Dacia Ripensis, Dacia Mediterranea, Mœsia Prima, Prævalitana, and a part of Macedonia Salutaris; in its narrower use it comprehended only the first two. Numerous traces of Roman occupation are found throughout the region, and in Roumania the people pride themselves on their supposed descent from the Roman colonists, and use a dialect which bears a strong similarity to Latin. In features they are said to have a resemblance to the Dacians figured on Trajan's pillar. See Dierauer, *Geschichte Trajan's*; W. Froehner, *La Colonne trajane*, Paris, 1865; Roessler, *Römische Studien*, 1871.

DACIER, ANDRÉ (1651-1722), a French classical scholar, was the son of a Protestant advocate at Castres, and was born in that town in 1651. His father resolved to give him a learned education, and accordingly sent him first to the academy of Puy Laurens, and afterwards to Saumur, to study under Tanneguy Lefèvre, who at that time

enjoyed a considerable reputation as a teacher of classics. Such rapid progress did the young scholar make, that when Lefèvre sent away all his other pupils, he kept Dacier for another entire year. On the death of Lefèvre, Dacier removed to Paris; and he had the good fortune to be appointed one of the editors of the Delphin series of the classics. His marriage with the far more famous Anne Lefèvre, the daughter of his old teacher, took place in 1683. In 1685 he announced, in a letter to the king, the conversion of himself and his wife to Roman Catholicism. As a reward Louis bestowed on him a pension of 1500 livres, and on his wife one of 500 livres. In 1695 Dacier was elected member of the Academy of Inscriptions, and also of the French Academy (of which in 1718 he became secretary); and not long after, as payment for his share in the *Histoire de Louis le Grand par médailles*, etc., he was appointed keeper of the library of the Louvre. He died, two years after his wife, on September 18, 1722.

Though endowed with none of the higher literary faculties, Dacier possessed great erudition. He was, as was wittily said, "un gros mulet chargé de tout le bagage de l'antiquité." The most important of his works were his editions of Pompeius Festus and Valerius Flaccus, and his translations of Horace, with notes, of Aristotle's *Poetics*, of the *Electra* and *Œdipus* of Sophocles, of Hippocrates, and of Plutarch.

DACIER, ANNE LEFÈVRE (1654-1720), a famous French scholar and translator from the classics, was born at Saumur, probably in 1654. She was the daughter of Tanneguy Lefèvre, a self-educated scholar belonging to the Huguenots, who taught classics and edited classical authors with a liveliness and enthusiasm which brought him some degree of fame. At the age of eighteen Anne Lefèvre lost her father. She then removed to Paris, carrying with her part of an edition of Callimachus, which she afterwards published, and which obtained for her an engagement as one of the editors of the series of classical authors then being prepared *ad usum Delphini*. In this series she edited Florus, Dictys Cretensis, Aurelius Victor, and Eutropius. In 1681 appeared her prose version of Anacreon and Sappho, which, though it was successful at the time, is wanting in the delicate taste, the gayety, and fire essential to a true translation. Within the next few years she also published prose versions of Terence and some of the plays of Plautus and Aristophanes, for the last of whom especially she cherished the most intense admiration. In 1683 Anne Lefèvre married André Dacier, once her father's favorite pupil. In the following year she accompanied her husband to his native town of Castres, whither they retired with the professed object of devoting themselves to theological studies. In 1685 the result was announced in the conversion to Roman Catholicism of both M. and Mme. Dacier, and of many of the townfolk of Castres besides. The sincerity of this conversion, though it brought with it court favor, it would be uncharitable to doubt; indeed the tastes of Mme. Dacier and her husband were such as would render such a step most natural. In 1711 appeared the prose translation of the *Iliad* (followed five years later by a similar translation of the *Odyssey*) which, through the spirit and enthusiasm which she brought to the work, and the direct and simple strength of her sometimes homely language, gained her the position she occupies in French literature. The appearance of this version, which made Homer known for the first time to many Frenchmen of letters, and among others to La Motte, gave rise to a famous literary controversy. La Motte published a poetical version of the *Iliad*, which he took the liberty of greatly abridging and altering to suit his own taste, together with a *Discours sur Homère*, stating the reasons why Homer failed to satisfy his critical taste (1714). Mme. Dacier replied, in her work *Des Causes de la Corruption de la Gôth* (1714), maintaining her opinions with a thorough enthusiasm for the ancients which allowed no merit to the moderns, and with occasional flashes of not unhappy banter. La Motte carried on the discussion with light gayety and badinage, and had the happiness of seeing his views supported by the indisputable erudition of the Abbé Terrasson, who in 1715 produced two volumes, entitled *Dissertation critique sur l'Iliade*, in which he maintained that science and philosophy, and especially the science and philosophy of Descartes, had so cultured the human mind that, without doubt, the poets of the 18th century were immeasurably superior to those of ancient Greece. The reply to this treatise was undertaken by M. Dacier. In 1715 the

<sup>1</sup> [Antoine Houdart de (1672-1731), a Parisian dramatist and critic, wrote *Ines de Castro*, translated Homer badly, an Academician eminent for his prose style.—AM. Ed.]

dispute was settled. In that year, Père Buffier published *Homère en arbitrage* (two letters to Mme. Lambert, with a reply from her) in which he concludes that both parties are really agreed as to the essential point that Homer was one of the greatest geniuses the world has seen, and that, as a whole, no other poem can be preferred to his; and, soon after, in the house of M. de Valincourt, Mme. Dacier and La Motte met at supper, and drank together to the health of Homer. Nothing of importance marks the rest of Mme. Dacier's life. She assisted her husband, for whom she seems to have cherished a high admiration, in his editions and translations, and spent part of her latter years in writing notes on the Scriptures, which were never published. She died at the Louvre, where her husband was keeper of the library, on the 17th August, 1720.

See Sainte-Beuve, *Causeries de Lundi*, vol. ix.; Bodin, *Recherches historiques sur la ville de Saumur*; Burette, *Éloge sur Mme. Dacier*; *Mémoires de Mme. de Staël*. A *mémoire* containing stories to the prejudice of Mme. Dacier's character appeared a few years after her death, and may be found in the *Histoire littéraire de la France* (vol. i.); some of the stories are also repeated by Bayle. The scandal is with great probability attributed by Sainte-Beuve to the rancor of some Huguenot.

DA COSTA, ISAAK (1798–1860), a Dutch poet and theologian, was born at Amsterdam on the 14th January, 1798. His father was a Jew of Portuguese descent, through whom he claimed kindred with the celebrated Uriel D'Acosta. He studied at Amsterdam, and afterwards at Leyden, where he took his doctor's degree in law in 1818. Before this he had given evidence of poetical talent, and had become acquainted with Bilderdijk, who exercised the strongest influence over him both in poetry and in theology. He was in fact the imitator as well as the scholar of Bilderdijk. In 1822 he became a convert to Christianity, and immediately afterwards asserted himself as a champion of orthodoxy in his *Bewaren tegen den Geest der Eeuw* (1823), which was an attack upon the prevalent latitudinarianism in doctrine. He took a lively interest in missions to the Jews, and towards the close of his life was a director of the seminary established at Amsterdam in connection with the mission of the Free Church of Scotland. He died at Amsterdam on the 28th April, 1860. Da Costa ranked first among the poets of Holland after the death of Bilderdijk. His principal poetical works were *Alphonse I.* (1821), a tragedy; *Poëzi* (1821); *God met ons* (1826); *Festliedern* (1828); *Vijf-en-twintig Jaren* (1840); *Hagar* (1852); *De Slag van Nieuport* (1857); and *De Mensch en-de Dichter*. He also translated the *Prometheus of Eschylus*, and edited the poetical works of Bilderdijk in 16 volumes. He was the author of a number of theological works, chiefly in connection with the criticism of the gospels.

DACOTAH. See DAKOTA.

DACYLUS. See CORYBANTES.

DÆDALUS, from the identity of his name with *δαίδαλον*, "to carve," and *δαίδαλα*, "carved images," appears to have been, not a real person, but a legendary representative of the art of carving and sculpture in Greece in the time before Homer, who speaks of him (*Iliad*, xviii. 590) as having made a "chorus" for Ariadne in Crete, which Hephestus took as the model of his "chorus," or dance, on the shield of Achilles. Works of art of an extremely early date, but especially wooden images of deities, were ascribed to Dædalus or his descendants, and there were many traditions of the wonders he had done in sculpture. Most of the tools used in wood-carving and sculpture were believed to have been invented by him. He was the first to open the eyes of statues, so that they seemed to look at the spectator, and to separate the legs so that they seemed to walk. A statue of Heracles by him had to be tied to prevent its running away, when the hero, angry at its resemblance to himself, threw a stone at it. The greater freedom which early Greek artists introduced into their figures was always contrasted with the stiffness of Egyptian statues, and hence it was necessary for the legend to represent Dædalus as having been some time in Egypt. Two of the earliest centres of art in Greece were Crete and Attica, and in the legends of both Dædalus is involved, the story being that he had fled from Athens after killing his skillful nephew Talus, had gone to Crete in the time of Minos, had there constructed the famous labyrinth, and made a "chorus" for Ariadne and a cow for Pasiphaë, and had been then thrown into prison, but escaped along with his son Icarus by means of wings. Icarus, however, fell

into the sea and perished. Dædalus reached Sicily, where, protected by the king against Minos, who pursued him, he is said to have constructed several important works.

DAFFODIL, the name of a group of plants of the genus *Narcissus*, and natural order *Amaryllidaceæ*. The common daffodil, *N. Pseudo-narcissus*, is common in woods and thickets in most parts of the N. of Europe, but is rare in Scotland. Its leaves are 5 or 6 in number, are about a foot in length and an inch in breadth, and have a blunt keel and flat edges. The stem is about 18 inches long, and the spathe single-flowered. The flowers are large, yellow, scented, and a little drooping, with a corolla deeply cleft into 6 lobes, and a central bell-shaped nectary, which is crisped at the margin. They appear early in the year, or, as Shakespeare says, "come before the swallow darses, and take the winds of March with beauty." The stamens are shorter than the cup, the anthers oblong and converging; the ovary is globose, and has three furrows; the seeds are roundish and black. Double and other varieties of the flower are commonly cultivated in gardens. The bulbs are large and orbicular, and have a blackish coat; they, as well as the flowers, are reputed to be emetic in properties. The Peruvian Daffodil and the Sea Daffodil are species of the genus *Ismenis*.

DAGGER, a weapon which, in relation to its comparatively short blade, may be considered a diminutive of the sword. Specially designed to inflict wounds by the act of stabbing, the dagger is sharp at the point, but it is equally adapted for cutting purposes with its keen edge. All savage races have highly valued the dagger in some modifications of its simplest type; while at certain periods it has been included among the military weapons of civilized nations, and, in our own time, is well known as the dirk. Early in the 14th century a dagger straight in the blade, and called a *misericorde*—either because the sight of it caused the vanquished to cry out for mercy, or from its use in mercifully ending the sufferings of the hopelessly wounded—became a companion weapon to the sword among the knights of Europe; and, accordingly, from about 1330 till the end of the succeeding century, in many knightly effigies it is often represented as attached on the right side by a cord or a chain to the sword-belt. The *misericorde* varied in size, the length of the blade sometimes causing it to appear almost like a second sword, while at other times the blade and the hilt were nearly of equal length. This weapon and its sheath were often elaborately adorned. It was customary to secure it from accidental loss by a guard-chain fastened to a *mamelière* of the breast-armor, of which chain the other end was secured to the hilt of the weapon by a ring either fixed on the apex of the pommel or travelling along the grip. Occasionally the *misericorde* was fixed to the body-armor by a staple, or, more rarely, it was connected with a *gypcière* or pouch. A similar weapon, with a longer blade than the ordinary *misericorde*, was habitually worn by civilians, including judges, during the Middle Ages; such weapons bore the name of *asiales* or *basilards*. By nobles and knights the *misericorde* was worn when they had exchanged their armor for the costume of peace. It is recorded, besides, that when they appeared at a tournament, and on some other occasions, ladies at that time wore daggers depending, with their *gypcières*, from their girdles. Thus, writing of the year 1348, Knighton speaks of certain ladies who were present at jousts as "*habentes cultellos, quos daggerios vulgariter dicunt, in pouchis desuper impositis.*" A sword having a blade much shorter than the principal knightly weapon of the same class, and distinguished as an *estoc*, which, like the civilian anlace or basilard, may be considered to be a variety of the dagger, occasionally formed a part of the equipment of the mediæval man-at-arms; and it is the scabbard of such a weapon that hangs as a characteristic memorial above the tomb and the effigy of the Black Prince in Canterbury Cathedral. Much ingenuity and skill have been lavished on the adornment of daggers, and in rendering the blades more capable of inflicting severe wounds. Daggers also were sometimes made to poison as well as wound. Some Italian daggers, of stiletto type, have the blade made to expand laterally, by the action of delicate and powerful springs. Others, like the *cris* of the Malaya, have wavy blades.

DAGHESTAN, a government in Asiatic Russia, on the eastern slopes of the Caucasus, bounded by Circassia, Grusia or Georgia, and the Caspian. As its name implies, it

is of a very rugged and mountainous character, with the exception of a narrow strip along the sea-coast. It is watered by the tributaries of the Sulak and other streams that find their way to the Caspian. The district is geologically of great interest, and its strata have been investigated by Abich in his *Sur la structure et la géologie du Daghestan*, 1862. Lead, iron, and sulphur are worked to some extent. The chief town is Derbent. See CAUCASUS, vol. v. p. 221.

D'AGINCOURT, JEAN BAPTISTE LOUIS GEORGE SEBROUX (1730-1814), archaeologist and historian, was born at Beauvais on the 5th April, 1730. He belonged to a good family, and in his youth served as an officer in a regiment of cavalry. Finding it necessary to quit the army in order to take charge of his younger brothers who had been left orphans, he was appointed a farmer-general by Louis XV. In 1777 he visited England, Germany, and Holland; and in the following year he travelled through Italy, with a view of exploring thoroughly the remains of ancient art. He afterwards settled at Rome, and devoted himself to preparing the results of his researches for publication. He died on the 24th September, 1814, leaving the work, which was being issued in parts, unfinished; but it was carried on by M. Gence, and published complete under the title *L'Histoire de l'Art par les Monuments, depuis sa décadence au quatrième siècle jusqu'à son renouvellement au seizième* (6 vols. fol. with 325 plates, Paris, 1823). An English translation by Owen Jones was published in 1847. In the year of his death D'Agincourt published at Paris a *Recueil de Fragments de Sculpture antique, en terre cuite* (1 vol. 4to).

DAGON, a national god of the Philistines, spoken of in Judg. xvi. 23; 1 Sam. v. 2; 1 Chron. x. 10; 1 Macc. x. 83. The name is derived from *Dag*, a fish, with the suffix of endearment,—the older etymology from *Dagan*, corn, suggested by Philo Byblius, being generally regarded as untenable. The principal temples of the god were at Ashdod (1 Sam. v. 1), and Gaza (Judg. xvi. 1, 23), and the former existed until the time of the Maccabees, when it was destroyed (148 B. C.) by Jonathan, the brother of Judas (1 Macc. x. 84). Dagon was a fish-god of the male gender, as the form of the name indicates, the corresponding female deity being Atargatis. From 1 Sam. v. 4, it appears that his image was composed of the head and hands of a man and the tail of a fish. The words "the stump of" at the close of the verse are an interpolation of the translators; the original reads "only Dagon (i. e., the fish) was left." Selden and Niebuhr identify the Philistine Dagon with the Dagon (*'Adānaw*) of the Babylonian mythology; but Rawlinson considers it "extremely doubtful" whether the two had any connection (Rawlinson's *Herodotus*, 3d ed. i. 614.) The fish was worshipped as the symbol of fertility, both on account of its own fecundity and as representing water, the life-giving and fertilizing element.

DAGUERRE, LOUIS JACQUES MANDÈ (1789-1851), a French painter and physicist, was born at Cormeilles, in the department of Seine-et-Oise, and died July 12, 1851, at Petit-Brie-sur-Marne, near Paris. He was at first occupied as an inland revenue officer, but soon betook himself to scene-painting for the opera, in which he ere long surpassed his predecessors Bibiena and Munich, and his teacher Degoti, more especially in his remarkable power of representing light and shade. Among the most admired of his productions were the Chapel of Glenthorn, at the Ambigu, and the Rising of the Sun in "Les Mexicains." He assisted M. Prévost in the execution of panoramic views of Rome, Naples, London, Jerusalem, and Athens, and subsequently (July 11, 1822), in conjunction with Bouton, he opened at Paris the Diorama (*δις*, double; *ἄραμα*, view), an exhibition of pictorial views, the effect of which was heightened by changes in the light thrown upon them. As an example of these may be instanced the Midnight Mass at the Church of Saint-Etienne du Mont. An establishment similar to that at Paris was opened by Daguerre in the Regent's Park, London. On the 3d March, 1839, the Diorama, together with the work on which Daguerre was then engaged, the Interior of Sainte-Marie-Majeure, was destroyed by fire. This reverse of fortune was soon, however, more than compensated for by the distinction he achieved as the inventor of the daguerreotype photographic process. Nicéphore Niepce, who since 1814 had been seeking a means of obtaining permanent pictures by the action of sunlight, learned in 1826 that Daguerre

was similarly occupied. In the following year he communicated to Daguerre particulars of his method of fixing the images produced in the camera lucida by making use of metallic plates coated with a composition of asphalt and oil of lavender; this where acted on by the light remained undissolved when the plate was plunged into a mixture of petroleum and oil of lavender, and the development of the image was effected by the action of acids and other chemical reagents on the exposed surface of the plate. The two investigators labored together in the production of their "heliographic pictures" from 1829 until the death of Niepce, July 3, 1833. Daguerre, continuing his experiments, discovered eventually the process connected with his name. This, as he described it, consists of five operations:—The polishing of the silver plate; the coating of the plate with iodide of silver by submitting it for about 20 minutes to the action of iodine vapor; the projection of the image of the object upon the golden-colored iodized surface; the development of the latent image by means of the vapor of mercury; and, lastly, the fixing of the picture by immersing the plate in a solution of sodium "hyposulphite" (sodium thiosulphate). On January 9, 1839, at a meeting of the Academy of Sciences, Arago dwelt on the importance of the discovery of the daguerreotype; and, in consequence of the representations made by him and Gay Lussac to the French Government, Daguerre was on the 15th of June appointed an officer of the Legion of Honor. On the same day a bill was presented to the Chambers, according to the provisions of which Daguerre and the heir of Niepce were to receive annuities of 6000 and 4000 francs respectively, on the condition that their process should be made known to the Academy. The bill having been approved at the meetings of the two Chambers on the 9th of July and the 2d of August, Daguerre's process, together with his system of transparent and opaque painting, was published by the Government, and soon became generally known. The first great improvement upon it, due to Mr. Towson, of Devonport, was the use of enlarged lenses, with which Mr. Draper of New York was the first to secure portraits from the life. Then followed Mr. Goddard's introduction, in 1840, of bromine for increasing the sensitiveness of the plates, and Fizeau's method of strengthening the lights and shades by the application of chloride of gold in the fixing operation. Previous to the time of Daguerre both Wedgwood and Sir H. Davy had attempted, but in vain, to prevent the unshaded portions of pictures taken by means of the solar rays from becoming colored by exposure to diffused light; this result Daguerre secured by the use of sodium thiosulphate, and thus became the chief pioneer of the modern art of photography.

Daguerre's *Histoire et description des procédés du Daguerreotype et du Diorama* (Paris, 1839) passed through several editions, and was translated into English. Besides this he wrote an octavo work, entitled *Nouveau moyen de préparer la couche sensible des plaques destinées à recevoir les images photographiques* (Paris, 1844).

D'AGUESSEAU, HENRI FRANÇOIS (1668-1751), chancellor of France, illustrious for his virtues, learning, and talents, was born at Limoges on the 27th of November, 1668. Under the careful supervision of his father, a man of great worth and ability, who held the posts of intendant of Languedoc and councillor of state, D'Aguesseau devoted himself to study with great ardor and with extraordinary results. When little more than twenty-one years of age he was, through his father's influence with the king, appointed one of the three advocates-general; and the eloquence and learning which he displayed in his first speech gained him a very lofty reputation, which was well sustained by his subsequent career. The chosen companions of his leisure hours were Racine and Boileau, the latter of whom frequently mentions him with high praise.

In 1700 he was appointed procurator-general; and in this office, which he filled for seventeen years, he gained the greatest popularity by his lenity in criminal cases, and by his care of the public hospitals. In 1717 he was made chancellor by the Regent Orleans; but it was only a year after that he was deprived of the seals, and exiled to his estate, on account of his steady opposition to the projects of the famous John Law, which had been adopted by the regent and his ministers. In 1720, however, on the failure of these schemes, he was recalled; and he contributed not a little, by the firmness and sagacity of his counsels, to calm

the public disturbance and repair the mischief which had been committed. Law himself had acted as the messenger of his recall; and it is said that D'Aguesseau's consent to accept the seals from his hand greatly diminished his popularity. But his reputation was much more severely shaken by his conduct in connection with the bull "Unigenitus," a measure which, with distinguished bravery, he had himself opposed during the life of the late king. He allowed the Great Council to assume the power of registration, which legally belonged to the Parliament alone; and he assisted Dubois, the favorite of the regent, in his endeavor to force the Parliament to register the bull, though he refused to sanction the extreme measure of exiling the Parliament, which Dubois had contemplated. Dislike of the Jansenists, and desire to put an end to the religious controversies which were raging so bitterly, were probably the motives which, in part at least, influenced D'Aguesseau; but the people unjustly attributed his conduct to a base compliance with the favorite. He certainly opposed Dubois in other matters; and when Dubois became chief minister, D'Aguesseau was deprived of his office.

He retired to his estate at Fresnes, where he passed five years, of which he always spoke with delight. The Scriptures, which he read and compared in various languages, and the jurisprudence of his own and other countries, formed the subjects of his more serious studies; the rest of his time was devoted to philosophy, literature, and gardening.

From these occupations he was recalled to court, by the advice of Cardinal Fleury, in 1727; but the seals were not restored to him till ten years later. During these years he endeavored to mediate in the disputes between the court and the Parliament. When he was at last reinstated in office, he completely withdrew from all political affairs, and devoted himself entirely to his duties as chancellor, and to the achievement of those reforms which had long occupied his thoughts. Besides some important enactments regarding donations, testaments, and successions, he introduced various regulations for improving the forms of procedure, for ascertaining the limits of jurisdictions, and for effecting a greater uniformity in the execution of the laws throughout the several provinces. These reforms constitute an epoch in the history of French jurisprudence, and have placed the name of D'Aguesseau in the same rank with those of L'Hôpital and Lamoignon. As a magistrate also he was so conscientious that Saint-Simon has complained that he spent too much time over the cases that came before him.

In 1750, when upwards of eighty-two years of age, D'Aguesseau retired from the duties without giving up the rank of chancellor. He died on the 9th February of the following year.

The published writings of D'Aguesseau form a collection of thirteen volumes quarto, of which the first was published at Paris in 1759, and the last in 1789. The far greater part relates to matters connected with his profession, but they also contain an elaborate treatise on money; several theological essays; a life of his father, which is interesting from the account which it gives of his own early education; and *Metaphysical Meditations*, written to prove that, independently of all revelation and all positive law, there is that in the constitution of the human mind which renders man a law to himself.

See *Histoire des hommes illustres des règnes de Louis XIV. et de Louis XV.* by the Duc de Saint-Simon; *Mémoires secrets*, by Ducloux; *Les loisirs d'un ministre d'état*, by D'Argenson; *Éloges* by Antoine Thomas (1760), by Marthon (1760), and by Boinvilliers (1848), and *Discours sur la vie de M. d'Aguesseau*, by his son, Aguesseau de Fresnes (1812).

DAHL, JOHANN CHRISTIAN (1778-1857), a landscape painter, born in Bergen, Norway, on the 24th February, 1778. He began painting in his native town, and formed his style without much tuition, remaining there till he was twenty-four, when he left for the better field of Copenhagen, and ultimately settled in Dresden in 1818. He is usually included in the German school, although he was thus close on forty years of age when he finally took up his abode in Dresden, where he was quickly received into the Academy and became professor. German landscape-painting was not greatly advanced at that time, and Dahl contributed to improve it. He continued to reside in Dresden, though he travelled into Tyrol and in Italy, painting many pictures, one of his best works being that of the Outbreak of Vesuvius, 1820. What his works want

is the careful expression of nature in its normal conditions. He was fond of extraordinary effects, as seen in his *Winter at Munich*, and his *Dresden by Moonlight*; also the *Haven of Copenhagen*, and the *Schlöss of Friedrichsburg*, under the same condition. At Dresden may be seen many of his works; a large picture called *Norway* may be mentioned, and a *Storm at Sea*. He was received into several academic bodies, and had the orders of *Wasa* and *St. Olaf* sent him by the king of Norway and Sweden. His death took place in 1857.

DAHL, MICHAEL (1656-1743), the only celebrated Scandinavian portrait painter of his time, was born at Stockholm in 1656. He received his first professional education from Ernst Klocke, who had a respectable position in that northern town, which, however, Dahl left in his twenty-second year. His first destination was England, where he did not long remain, but crossed over to Paris, and made his way at last to Rome, there taking up his abode for a considerable time, painting the portraits of Queen Christina and other celebrities. In 1688 he returned to England, with an established character, and became for some years a dangerous rival to Kneller. His portraits still exist in many houses, but his name is not always preserved with them. Nagler (*Künstler-Lexicon*) says those at Hampton Court and at Petworth contest the palm with those of the better known and vastly more employed painter. Some of his pictures have been engraved. He died in 1743, in his eighty-seventh year.

DAHL, or DALE, VLADIMIR IVANOVITCH (1802-1872), a Russian author and philologist of high reputation, was born of Scandinavian parentage in 1802, and received his education at the Naval Cadets' institution at St. Petersburg. He joined the Black Sea fleet in 1819; but at a later date he entered the military service, and was thus engaged in the Polish campaign of 1831, and in the expedition against Khiva. He was afterwards appointed to a medical post in one of the Government hospitals at St. Petersburg, and was ultimately transferred to a situation in the civil service. The latter years of his life were spent at Moscow, and he died there on November 3 (October 22), 1872. Under the name of Kossack Lugansky he obtained considerable fame by his stories of Russian life,—*The Dream and the Waking*, *A Story of Misery, Happiness, and Truth*, *The Door-Keeper* (Dvernik), *The Officer's Valet* (Denshchik). His greatest work, however, was a *Dictionary of the Living Russian Tongue* (Tolkovy Slovar Zhivago Velikorusskago Yasika), which appeared in four volumes between 1861 and 1866, and is of the most essential service to the student of the popular literature and folk-lore of Russia. "It is impossible," says Mr. Ralston, "to praise too highly this magnificent work—one to which he devoted during a great part of his lifetime what was truly a labor of love." It was based on the results of his own investigations throughout the various provinces of Russia,—investigations which had furnished him with no fewer than 4000 popular tales, and upwards of 30,000 proverbs. Among his other publications may be mentioned *Bemerkungen zu Zimmermann's Entwurf des Kriegstheaters Russlands gegen Khiva*, published in German at Örenburg, and a *Handbook of Botany*, Moscow, 1849. A collected edition of his works appeared at St. Petersburg in 8 volumes, 1860-61.

DAHLGREN, KARL FREDRIK (1791-1844), the Swedish poet, was born at Stensbruk, in Östergötland, June 20, 1791. At the time when literary partisanship ran so high in Sweden, and the writers divided themselves into "Goths" and "Phosphorists," Dahlgren came over to the latter body, and made himself indispensable by his polemical activity. In the mock-heroic poem of *Markalls sömlösa nätter* (Markall's Sleepless Nights), in which the Phosphorists bitterly and with eminent success ridiculed their opponents, Dahlgren, who was a genuine humorist, took a very prominent part. In 1825 he published *The Tower of Babel*, a satire, and in the same year a comedy, *Argus and Olympus*. In 1828 he collected the scattered poems of his youth into two volumes. In 1829 he was appointed to an ecclesiastical post in Stockholm, which he held until his death. In a series of odes and dithyrambic pieces, entitled *Mollbergs Epistlar* (1819, 1820), he strove to emulate the wonderful lyric genius of Bellman, of whom he was a student and follower. From 1825 to 1827 he edited a critical journal entitled *Kometen* (The Comet), and he is also the author of a comic novel, *Nahum Frederik Bergström's Chronicle*, which is said to be extremely witty. In com-

pany with Almqvist he founded the celebrated Manhemförbund, a society of agricultural socialists, which had but a short tenure of existence. In 1834 he collected his poems in one volume; and in 1837 appeared his last book, a volume entitled *Steamboat Songs*. On the 1st of May, 1844, he died at Stockholm. Dahlgren is one of the best humorous writers that Sweden has produced, but it was perhaps in realistic and idyllic description that his peculiar talents displayed themselves to most advantage. His little poem of *Zephyr and the Girl*, which is to be found in every selection from Swedish poetry, is a good example of his sensuous and ornamental style, as well as of his ease and vivacity. His works were collected and published after his death by A. J. Arwidsson.

**DAHLIA**, a genus of herbaceous plants of the natural order *Compositæ*, so called after Dr. Dahl, a pupil of Linnæus. The dahlia is indigenous to Mexico, where it flourishes in sandy tracts at a height of 5000 feet above sea-level. Two cultivated species are distinguished by some botanists, *D. frutescens* and *D. superflua*, the outer involucre in the former being spreading, in the latter reflected. The flowers have a chaffy receptacle, a double involucre, and no pappus. The roots or tubers are spindle-shaped, and grow in bundles; they were at one time used as food in France; but their acrid flavor occasioned their rejection as an esculent. They may be stored in winter in the same manner as potatoes. The flowers, at the time of the first introduction of the plant, were single, with a yellow disc and dull scarlet rays; under cultivation (since 1802 in France, and 1804 in England), flowers of numerous brilliant hues, with the elements of the disc converted into ray-florets, have been produced. The flower has been modified also from a flat to a globular shape, and the arrangement of the florets has been rendered quite distinct in the ranunculus and anemone-like kinds. The ordinary natural height of the dahlia is about 7 or 8 feet, but one of the dwarf races grows to only 18 inches. With changes in the flower, changes in the shape of the seed have been brought about by cultivation; varieties of the plant have been produced which require more moisture than others, and the period of flowering has been made considerably earlier. In 1808 dahlias were described as flowering from September to November, but some of the dwarf varieties at present grown are in full blossom in the middle of June. The nature of the season has a marked effect upon certain kinds of dahlia, so that those which are good in one year may become decidedly bad in the next. In 1842 it was noted by one observer that every dahlia with a tendency to become of a scarlet hue had its petals deeply notched, in some cases to the depth of half an inch. A fine color is an important requisite for a good flower. There should also be no sinking of the centre or eye, and the backs of the petals should not be visible. Dahlias may be grown in almost any kind of soil, but flourish best in a rich loam; on a light sandy mould they arrive early at maturity, and become dwarfed. The plants should be protected from north and east winds, and when watered the whole of their foliage should be wetted. They are propagated by cuttings and seed as well as by tubers. Experience has shown that the best plants obtained from cuttings are those planted on soil different from that on which the parent plants grow. The seeds are sown in pots early in March, under the protection of a hotbed frame or in a hothouse.

**DAHLMANN, FRIEDRICH CHRISTIAN** (1785-1860), a distinguished German historian and politician, was born on the 13th May, 1785, at Wismar. He studied philology at the universities of Copenhagen and Halle, and at the age of twenty-five took his doctor's degree in that subject. He had already delivered lectures at Dresden, and in 1812 he was appointed professor of history at Kiel. His devotion to historical study had been caused by his wish to take a useful and intelligent part in contemporary politics. In 1816 he was made secretary to the permanent deputation of the prelates and nobles of Schleswig-Holstein in which position his influence was exerted against the policy of the Danish Government, and he henceforth took a prominent place among moderate liberals. In 1829 he was chosen professor of the science of politics in the university of Göttingen. Two or three years later he was engaged in drawing up the Hanoverian constitution of 1833. In 1837, when that constitution was abolished by Ernest Augustus, Dahlmann so strongly opposed the

king's policy that he was banished from Hanover. He retired to Leipzig, and then to Jena, where he gave his time to the study of history and the production of his most important works. In 1842 Dahlmann became professor of history and the science of politics at Bonn. In 1848 he was chosen a member of the committee of seven-teen which was appointed to draw up a new German constitution, and he was elected member of the National Assembly of Frankfurt. He distinguished himself as an advocate of the election of the king of Prussia as emperor of Germany. He was indeed so much regarded as a leader that he was requested to form a ministry; but his attempt was unsuccessful. In March, 1849, when the Parliament rejected the constitution, Dahlmann, who had been opposed to the armistice of Malmö, retired with many of his followers from the Parliament, and joined the assembly of Gotha, in which he still advocated the unification of Germany under the king of Prussia. He also worked in the same cause in the assembly of Erfurt and the Prussian diet. When that cause appeared hopeless, he retired from politics; and the rest of his life was spent in study, and in fulfilling the duties of the chair which he still held at Bonn. He died on the 5th December, 1860.

The chief works of Dahlmann are a valuable *Geschichte Dänemarks* (3 vols., 1840-3), *Geschichte des Englischen Revolution* (1845 and 1853), *Geschichte des Französischen Revolution* (1844 and 1853), *Forschungen auf dem Gebiete der deutschen Geschichte* (1822-3), *Chronik von Dithmarsen* (1827), *Politik auf den Grund und das Mass der gegebenen Zustände zurückgeführt* (1835 and 1847); *Quellenkunde der deutschen Geschichte* (1830 and 1875). See Springer, *Friedrich Christian Dahlmann* (1870-2).

**DAHLSTJERNA, GUNNO** (1661-1709), whose original surname was **EURELIUS**, the Swedish poet, was born September 7, 1661, in the parish of Ohr, in Dalaland, where his father was rector. He entered the university of Upsala in 1677, and after gaining his degree, entered the Government office of land-surveying. He was sent in 1681 on professional business to Livonia, then under Swedish rule, and after some time took thence a scientific journey into Germany, in the course of which, being at Leipzig, he published and publicly read, in 1687, a dissertation, *De Electro*, which caused such a sensation that he was offered a professorial chair at the university of that city. He refused this honor, however, and busied himself, on his return to Sweden, with carrying out the numerous commissions in land-surveying directed by King Charles XI., and in 1699 he became head of the whole department. In 1702 he was ennobled under the name of Dahlstjerna. He spent his life in travelling, and wandered over the whole of the coast of the Baltic, Livonia, Rügen, and Pomerania, preparing maps which still exist in the office of Public Land-Surveying in Stockholm. He died in Pomerania on his forty-eighth birthday, September 7, 1709, just after the disastrous news of the lost battle of Pultowa had reached him. Dahlstjerna's life was, as it might seem, fully occupied with those practical mathematical studies in which he labored so conscientiously for his country; but it is indisputable that his passion for poetry was still more absorbing. His patriotism was touching in its pathos and intensity, and during his long periods of professional exile he comforted himself by the composition of songs to his beloved Sweden. His genius was most irregular; at his best he surpasses all the Swedish poets of his time, and that with ease; but no writer of that country has sunk to lower depths of bombastic puerility. He formed his style after two thoroughly bad models,—the so-called Second Silesian School, of which Lohenstein was the leader, and the florid Italian pastoralists, Marini and Guarini. His best known original work is *Kungasæld*, an elegy on the death of Charles XI., published in 1697. It is written in alexandrines, arranged in *ottava rima*. The poem has faults enough; it is pompous and allegorical, but there are passages full of melody and high thoughts. The whole bearing of the work, judged from a national point of view, is noble and even sublime, and could only have been conceived at such a time, when Sweden was a great power in Europe. Dahlstjerna was a reformer in language, and it has been well said by Atterbom, that in this poem "he treats the Swedish speech just as dictatorially as Charles XI. and Charles XII. treated the Swedish nation." In 1706 he printed a volume of poems celebrating the victories of Charles XII., which, to the serious loss of Swedish literature, has unaccountably disappeared. In 1690 was printed at Stettin his translation

or rather paraphrase of the *Pastor Fido* of Guarini, which was very much admired and often reprinted. But of all the works of Gunno Eurlius the one that has attained most living popularity is *The Goth's Battle Song concerning the King and Master Peter*, published in 1701. The king is Charles XII. and Master Peter is, of course, the czar of Russia. There is a proud maiden whom Peter will ravish from the king, and her name is Narva Castle. It is an exceedingly spirited and felicitous ballad, and lived almost until our own days on the lips of the people as a folk-song. In a more tasteful age, and with more leisure for poetic study, there can be no doubt that the vivid genius of Dahlstjerna would have produced works of a far higher order. As it is, there is no Swedish writer of his age who has approached him in his sublimer moments. The works of Dahlstjerna have been collected by Hansellius.

DAHOMY, a kingdom on the west coast of Africa, extending inland from the Slave Coast, in the Gulf of Guinea, and second only to Ashantee in power and importance. The territory of Dahomey has been described as extending from the Volta to the Niger, and from the Kong Mountains to the sea; but recent investigation has shown that the true limits of the state are much more closely circumscribed, Dahomey proper being probably not more than 120 miles from north to south, and the same, or perhaps less, from east to west, lying between  $6^{\circ} 15'$  and  $7^{\circ} 30'$  N. lat. and  $1^{\circ} 30'$  and  $2^{\circ} 30'$  E. long. or thereby. On the W. and N.W. are the semi-independent races of Aja and Atakpamé; on the N. the Mahees or Makhis, now completely subjugated; and on the N.E. and E. the Eyos and the Egbas, both the hered-

channels of Great Popo and Lagos are well defined. Behind the sand-bank runs a lagoon affording carriage along almost the whole coast. A line drawn from the coast at Appi northwards to Abomey would represent roughly the almost imperceptible water-shed of the country, dividing the two systems of drainage which communicate with the sea at Great Popo and Lagos respectively. Recent charts show two vast lakes, the Avon and the Denham waters, extending many miles inland, and communicating with the lagoon which skirts the coast-line, but it is now certain that the extent of these lakes has been much exaggerated, and that the greater portion of what has been considered as navigable water is really low-lying land, more or less marshy according to the season of the year, and intersected by rivers and streams. The steamer "Eko" from Badagry ascended the Whemi river for a considerable distance in the autumn of 1876, and found plenty of water; while M. Guillemin, a French naval officer, who some years ago penetrated to the same river at Kassa near Abomey, not many miles further up in the month of April, that is, during the dry season, reported that there was then little water in the stream.<sup>1</sup> The whole question of the geography of this coast is very fully discussed by the Abbé Borghero in a letter explaining the discrepancies between the English maps and his own. The letter is published in the *Bulletin de la Société de Géographie* of July, 1866. The subject has considerable interest in connection with recent events on the Slave Coast, and in regard to the possible extension of the British protectorate over the interval of coast-line which now separates the two sections of the Gold Coast Colony. The

sketch which illustrates this article is based upon M. Borghero's map, but it differs from it in the important particular of the position of Abomey. The latitude now assigned has been determined by a careful comparison of the itineraries of all the principal travellers, and the length of the route is found to correspond exactly with that given by Commodore Wilmot in 1862. It is a singular fact that the distance of Abomey from the coast, according to the accounts of successive travellers, has been gradually diminishing from 200 miles in 1724 to the present estimate. The longitude of Abomey is undetermined, but preference has been given to the English accounts which place it slightly more to the west than the French map.

**Communication.**—The interior of Dahomey is traversed by a road extending from Whydah to Abomey, the capital, a distance of 65 miles. The road, for the first 40 miles, lies through forest, gradually increasing in density to the edge of the Agrimé, or Great Swamp. Round the villages, and here and there in the forest, clearings are met with, cultivated in places, but in others now partially overgrown. The soil is naturally fertile, and there is evidence of former prosperity, but everywhere the process of depopulation is apparent, and the country is described as a luxuriant wilderness. The swamp which is supposed to connect the marshes at the head of the Avon and Denham waters is seven or eight miles broad. It is covered with stunted trees and its surface is rough and uneven. So far as any movement of its waters has been observed, it drains towards the west. The passage is attended by considerable difficulties during the rainy months, but in dry seasons it is scarcely distinguishable from the rest of the route. There are two known tracks across the swamp. The right is the more direct of the two; it passes through Akpwé and Agrimé. The left road, said to be slightly longer owing to the obligation imposed upon all travellers to halt at Cana, branches off at Henvi, and enters the marsh at Toffo; it is used in the rainy season, the passage of the swamp being less difficult at this point. The "koh," or swamp, once passed, the difficulties of the journey are left behind, and the character of the country undergoes a complete change; instead of dense forest and dismal swamp, a vast and gently undulating plain, with a gradual ascent towards the Kong Moun-

<sup>1</sup> More recently Mr. Dumaresq, the late administrator of Lagos, who was on board the "Eko," when it explored the Whemi after the rains of 1876, has again ascended the river for 20 miles in an open boat for the purpose of ascertaining the depth of water during the dry season. He is reported to have found it to average 2 fathoms but with a depth of 3½ feet only on the bar at the entrance of the river. The breadth was 150 yards, and the stream was free from swamps. It must, however, be remarked that the character of the river in the latitude of the Agrimé swamp remains still undetermined.

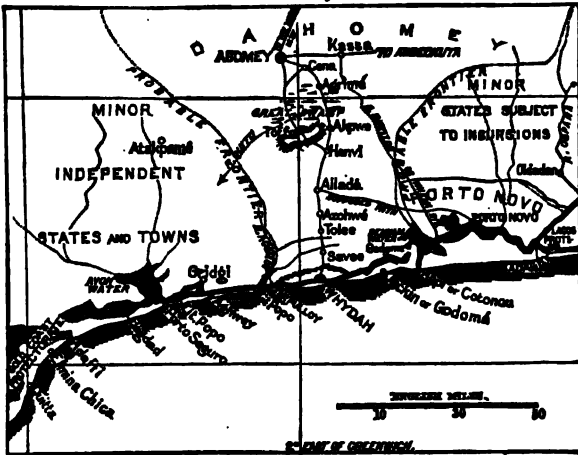

Chart of Dahomey.

itary enemies of the Dahomans. On the S.E. is the kingdom of Porto Novo, a nation of kindred race, over which the king of Dahomey claims suzerainty. The southern portion of Dahomey is confined to the narrow tongue of dry land which lies between the Avon and the Denham lagoons and the swamps to the north of them, while the actual coast-line included in the dominion extends only from Mount Pulloy (near Great Popo) on the west to Cotonau on the east. The frontier is said to be marked for some distance inland by the River Agomey on the west and the Denham water and its tributary, the Ouellon or Whemi river, on the east. The seaboard is about 35 miles long, and forms a portion of the 120 miles of coast which intervene between the British possessions of the Gold Coast proper and Lagos. Between the Gold Coast and the Dahoman frontier occur several independent townships or coast settlements of mixed race, each under a separate chief. The principal centre of trade with the interior in this debatable land is the town of Gridgi, where a market is held every few days.

**Physical Features.**—The physical geography of Dahomey possesses some peculiarities. The ancient limit of the continent now lies about 50 miles inland, and the low ground intervening between the former coast-line and the present shore is protected from the ocean by a natural bank of sand, varying in width and height, but sufficient to prevent the incursions of the sea except at a few points, of which the



ains, stretches out as far as the eye can reach. The approach to Cana has been described by several travellers as one of such beauty.

**Port and Town.**—The principal seaport is Whydah. It is situated on the north bank of the coast lagoon about two miles from the sea. There is no harbor at the beach, and landing is effected in boats made expressly to pass through the surf, which is here particularly heavy. The town is two miles long and half a mile deep, and has about 12,000 inhabitants. There are five quarters, the English, French, Portuguese, Brazilian, and native, and the three first have the remains of once formidable forts.

Cana is the country residence of the king; the town straggles over three miles of ground, but the precincts include more field than habitation, the population being from 4000 to 5000. The distance from Cana to Abomey is eight miles; the road, apparently level, has an imperceptible rise the whole way; it is 20 yards broad and is kept carefully clear of grass.

**Abomey.**—The site of the capital is a rolling plain, nearly surrounded by marsh, and terminating in short bluffs to the north-west, where it is bounded by a long depression. Scattered over this hollow are the principal pans which scantily supply the city with water. For some reason visitors are not permitted to approach this quarter, and it was only by infringing the royal commands that Captain Burton, setting out at 4 o'clock one misty morning, was able to explore it. The city is about eight miles in circumference. The enceinte consists of a ditch 5 feet deep, filled with a dense growth of prickly acacia, the usual defence of West African strongholds. It is entered by six gates, which are simply clay walls, with two apertures, built across the roads leading into the town. Within the walls are several royal palaces, a market-place, a large square containing the barracks, etc., many cultivated farms and several large wastes; and outside the gates on the south there is a suburb with three other palaces. Notwithstanding the great area occupied by the habitations, the population is estimated by Burton at not more than 12,000, or about the same as that of Whydah, which only covers one-sixth of the area.

**Mahee country.**—From Abomey a road leads across a marsh northwards into the Mahee country, which is entered about 30 miles from the capital, and extends in a series of gradually rising terraces to the heart of the Kong Mountains. It is a rugged country of varied surface, and produces iron ore, which is smelted and worked up into agricultural and other implements. The mahogany tree and the African oak abound, and the much esteemed shea-butter tree is met with; the cotton plant is indigenous. The towns are built on the level summits of the hills with a view to defence.

**Productions.**—The soil of Dahomey proper is naturally fertile, and is capable of being highly cultivated. It consists of a rich clay of a deep red color. Finely powdered quartz and yellow mica are met with, denoting the deposit of disintegrated granite from the interior. The principal product is palm-oil, which is made in large quantities throughout the country. The district of Toffo is particularly noted for its oil-palm orchards; these are chiefly owned by the officials of the capital, many of whom have houses and grounds there. Palm-wine, said to be superior to the finest cider, is also made, but the manufacture is prohibited excepting in the bush, as the process destroys the tree. Next to palm-oil the principal vegetable products are maize, guinea-corn, cassava (the substitute for bread), yams, sweet potatoes, plantains, cocoa-nuts, oranges, limes, and the African apple, which grows almost wild. The country also produces ground-nuts, Kola-nuts, pine-apples, guavas, spices of all kinds, ginger, okros (*Hibiscus*), sugar-cane, onions, tomatoes, and papaws. Cattle, sheep, and goats are scarce, and fowls are not plentiful.

The medium of exchange is the cowrie, which is imported from Zanzibar by the European merchants. At Whydah fifty cowries make a string, and fifty strings one "head"; a dollar is worth four heads; the head is 1s. 1½d., and a string therefore about a farthing. Inland the value of the cowrie is enhanced by reducing the number in the string.

The climate of this part of the Slave Coast is the same as on the remainder of the Bight of Benin. Whydah is considered slightly more healthy than either Lagos or Badagry. Near the sea the heat is not excessive, the average temperature being about 80° Fahr. The year may be di-

vided into four seasons:—summer, the rains, autumn, and the harmattan. During the summer, which continues from March to May, the heat is greatest, and dysentery prevails. The rains are ushered in by violent thunder-storms, and they last from May until August, with a break of fine weather in June; at the close of the rains thunder-storms are again prevalent. This is the coolest season of the year, but mosquitoes and sandflies abound. The autumn months are from September to November; thunder-storms and tornadoes occur at intervals; the climate assumes a more un-healthy phase, and the Guinea worm is troublesome. The harmattan, so called owing to the prevalence of a cold dry wind which blows from the north and north-east, continues from December to February. It prevails for several days in succession, and alternates with winds from the south and south-west; its approach is generally foretold by a thick white fog known as "the smokes." During its continuance the thermometer falls about 10°, there is not the slightest moisture in the atmosphere, vegetation dries up or droops, the skin parches and peels, and all woodwork is liable to warp and crack with a loud report. This season is considered healthy, but in the intervals of the harmattan wind, when it is usually hot, mild fever may be expected. Tornadoes occur occasionally. During nine months of the year the climate is tempered by a sea-breeze, which is felt as far inland as Abomey. It generally commences in the forenoon, and in the summer it often increases to a stiff gale at sundown.

The history of Dahomey before the last 200 years is unknown. The country now occupied by Dahomey and Porto Novo was, at the commencement of this period, comprised in the extensive kingdom of Ardrah, of which the capital was the present town of Alladé, on the road from Whydah to Abomey. About the beginning of the 17th century the state became dismembered on the death of a reigning sovereign, and three separate kingdoms were constituted under his three sons. One state was formed by one brother round the old capital of Alladé, and retained the name of Ardrah; another brother migrated to the east and formed a state also called Ardrah, but now known under the name of Porto Novo; while the third brother travelled northwards, and after some vicissitudes established the kingdom of Dahomey. The Western Ardrah, or Alladé, appears to have been subsequently further subdivided by the formation of the separate kingdom of Whydah to the south. About 1724–28 Dahomey, having become a powerful state, invaded and conquered successively Alladé and Whydah. Towards the north it was unable to extend its power, being hemmed in by the Mahees and the still more powerful Eyo or Oyca. The people of Whydah who escaped massacre or capture retreated along the coast to the west, and established themselves in the islands of the lagoon about Great Popo. The Whydahs from time to time made several attempts to recover their country, but without success, while on the other hand the Dahomans failed in all their expeditions against Popo. It is related that the repulses they met with in this quarter led to the standing order that no Dahoman warrior is to enter a canoe. The Dahomans have at several times penetrated along the beach towards the east as far as Badagry, but the king of Porto Novo became jealous of their incursions, and invoked the aid of the Eyo to put a stop to them. This was the state of affairs at the accession of Gezo about the year 1818. This monarch, who reigned forty years, raised the power of Dahomey to its highest pitch. He boasted of having first organized the amazons, to which force he attributed his successes. In 1825 he attacked the Eyo at Cana and abolished the tribute, thus freeing his country from the incubus on the north-east. He next (1840) overran Atakpané on the west, and subjugated the Mahees on the north. Shortly after this began the quarrels with Abbeokuta, which continue to this day, and have proved one of the main causes of the decline of the Dahoman power. In 1849 Gezo fell unexpectedly on Okidan and completely destroyed it. In 1851 he attacked Abbeokuta, the centre of the Ego power, but was beaten back. Gezo never recovered from this blow; he died in 1858, and was succeeded by his son Gelelé.

Gelelé's principal exploit was the capture of the Ego town of Ishagga in 1862. He slew the chief and carried off amongst the prisoners some native Christian converts and a native scripture-reader called William Doherty. This unfortunate man was crucified on a tree at Abomey French protectorate or colony in 1890.—AM. Ed.] by Google

<sup>1</sup> [This district after hostilities became a virtual

and his body was seen in this position by M. Euschart, a Dutch merchant of Whydah. In 1864 Gelelé attacked Abbeokuta and received an exemplary defeat, which will probably be sufficient to prevent him from again seriously attempting the capture of the place. Abomey has been frequently visited by representatives of the British Government. The later missions have had a threefold object—the suppression of the slave trade, the abolition of human sacrifices, and the dissuasion of the king from attacking Abbeokuta. Little result has ever been obtained from any of these visits.

From the time of Captain Burton's visit in 1863 there was little change in the political situation of Dahomey, until the spring of 1876, when in an evil moment Gelelé caused an Englishman resident in Whydah to be treated ignominiously. Brought to task by the commodore on the station the king refused to pay the fine of palm-oil awarded, and defied the British flag. Accordingly, for the fourth time in the history of Dahomey, a blockade of the coast was proclaimed.

Throughout the history of Dahomey, with very few exceptions, Europeans appear to have been treated with kindness, but they have often felt the inconvenience of placing themselves within the power of an uncivilized despot. It has always been an object with the king to secure the presence of white men at his "customs," and even casual visitors to Whydah have found themselves compelled to accept an invitation to visit the capital. Once there the length of their stay has depended on the caprice of the king, and even the envoys of European powers have found it impossible to break through the tedious etiquette of the savage court. As a notable instance of vexatious delay, Mr. Skertchley, who visited Whydah in 1871, was induced to go to Abomey under promise of return to the port in eight days, and was compelled to remain eight months.

The "customs" consist of an annual festival which takes place about October, and lasts several weeks. During the saturnalia many human victims are put to death with great barbarity. At one stage of the customs the unfortunate wretches, chiefly captives taken in war, are dressed in white shirts and long white night-caps and tied into baskets. They are then taken to the top of a high platform, and paraded on the heads of amazons, together with an alligator, a cat, and a hawk in similar baskets. The king now makes a speech, explaining that the victims are sent to testify to his greatness in spirit-land, the men and the animals each to their kind. They are then hurled down into the middle of a surging crowd of natives, and meet with a horrible death. At another stage of the festival human sacrifices are offered at the shrine of the king's ancestors, and the blood is sprinkled on their graves. The skulls are used to adorn the palace walls, and the king's sleeping-chamber is paved with the heads of his enemies. The skulls of the conquered kings are turned into royal drinking-cups, and their conversion to this use is esteemed an honor.

**Amazons.**—But the most singular institution of this strange race is found in the treatment of the female sex. About one-fourth of the whole are said to be married to the fetish, many even before their birth, and the remainder are entirely at the disposal of the king. The most favored are selected as his own wives or enlisted into the regiments of amazons, and then the chief men are liberally supplied. Of the female captives the most promising are drafted into the ranks as soldiers, and the rest become amazonian camp followers and slaves in the royal households.

With such an appropriation of the women it is not surprising that the population of Dahomey is found to be decreasing. No estimate can be formed of the number of inhabitants, but evidences of depopulation strike the traveller. It is a mistake to ascribe the diminution to human sacrifices, for the number of these is comparatively insignificant, and the victims are principally foreign captives.

The army of Dahomey was formerly held in high repute, but its prowess was probably overrated. The amazons form the flower of the army. They are marshalled in regiments, each with its distinctive uniform and badges, and they take the post of honor on the flanks of the battle line. Their number has been variously stated. Captain Burton had a good opportunity of judging, as he saw the army marching out of Cana on an expedition in 1862, and he computed the whole force of

women troops at 2500, of whom one-third were unarmed or only half armed. Their weapons are blunderbusses, flint muskets, and bows and arrows. Whether their arrows are poisoned or not is a point on which there is difference of opinion.

A recent writer estimates the number of amazons at 1000, and the male soldiers at 10,000. The system of warfare is one of surprise. The army marches out, and, when within a few days' journey of the town to be attacked, silence is enjoined and no fires are permitted. The regular highways are avoided, and the advance is by a road specially cut through the bush. The town is surrounded at night, and just before daybreak a rush is made and every soul captured if possible; none are killed except in self-defence, as the first object is to capture, not to kill. The season usually selected for expeditions is from January to March, or immediately after the annual customs. The amazons are carefully trained, and the king is in the habit of holding "autumn manœuvres" for the benefit of foreigners. Many visitors have witnessed a mimic assault, and they are agreed in ascribing a marvellous power of endurance to the women troops. Lines of thorny acacia are piled up one behind the other to represent defences, and at a given signal the amazons, barefooted and without any special protection, charge and disappear from sight. Presently they emerge within the lines torn and bleeding, but apparently insensible to pain, and the parade closes with a march past, each warrior leading a pretended captive bound with a rope.

It is said that at the death of the king a horrid scene ensues; the wives, after the most extravagant demonstrations of grief and breaking and destroying everything within their reach, attack and murder each other, and remain in an uproar until order is restored by the new sovereign. The throne descends rightfully to the eldest son, but, as in the case of the present monarch, a younger brother is not unfrequently preferred, should the chiefs consider the heir unfitted to assume the reins of government. (W. K. E.)

**DAILLÉ** [DALLÆUS], JEAN (1594-1670), one of the most learned Protestant divines of the 17th century, was born at Châtelleraut, in January, 1594, and received his education at Poitiers and Saumur. For seven years from 1612 he was tutor to two of the grandsons of the illustrious M. du Plessis Mornay, and in 1619 he accompanied them in a tour through Italy, Switzerland, Germany, Flanders, Holland, and England, which lasted for two years. Having been ordained to the ministry in 1623, he preached for some time in the family of M. du Plessis Mornay, and on the death of his patron he devoted himself to the grateful task of drawing up his *Memoirs*. In 1625 Daillé was appointed minister of the church of Saumur, and in 1626 he removed to Paris. Of his works, which are principally controversial, the most important is the celebrated treatise *Du vrai Emploi des Pères* (1631), translated into English by Thomas Smith under the title *On the Use of the Fathers* (1651). In 1656 it appeared in Latin. The work is a most effective attack on the views of those who made the authority of the fathers conclusive on matters of faith and practice. Daillé shows that their text is often corrupt, and that even when the text is correct their reasoning is often weak and inconsequent. He was greatly esteemed, even by his antagonists; and his mild and amiable disposition, united to his learning and genius, led Balsac to exclaim, "*Um talis sis utinam noster esses.*" In his famous *Sermoes on the Philippians and Colossians* Daillé has vindicated his claim to be ranked as one of the first of preachers, as well as one of the most able of polemicists. Daillé was president of the last national synod held in France, which met in 1658. In the discussions which occurred he defended the universalism of Amyraut. His *Apologie des Synodes d'Alençon et de Charenton* (1655) was devoted to the same object. Among his other works were an *Apologie pour les Eglises Reformées* and *La Foy fondée sur les Sainte Ecritures*. Daillé's life was written by his son Adrien, who retired to Zurich at the revocation of the Edict of Nantes.

**DAIMIÉL**, a town of Spain, at the head of a department of the province of Ciudad Real, and about 20 miles north-east of the town of that name, with which it is connected by rail. It is situated in a fertile plain on the Azuer, and is regarded as one of the most flourishing places in the La Mancha district. Linens and woollens are manufactured, and a purgative salt known as *Saj de Inghil-*

terra is extracted from the neighboring marshes. Being of comparatively modern foundation, the town presents nothing very remarkable in its architecture. Population about 12,000.

**DAIRY.** Milk, either in its natural state, or in the form of butter and cheese, is an article of diet so useful, wholesome, and palatable, that dairy management, which includes all that concerns its production and treatment, constitutes a most important branch of husbandry. The physical conditions of the different countries of the world have determined in each case the most suitable animal for dairy purposes. The Laplander obtains his supplies of milk from his rein-deer, the roving Tartar from his mares, and the Bedouin of the desert from his camels. In the temperate regions of the earth many pastoral tribes subsist mainly upon the milk of the sheep. In some rocky regions the goat is invaluable as a milk-yielder; and the buffalo is equally so amid the swamps and jungles of tropical climates. The milking of ewes was once a common practice in Great Britain; but it has fallen into disuse because of its hurtful effects upon the flock. A few milch asses and goats are here and there kept for the benefit of infants or invalids; but with these exceptions the Cow is the only animal now used for dairy purposes in this country.

**Breeds.**—Cows of every kind are used for the dairy; but there are several of our native breeds of cattle which are called *par excellence* "the dairy breeds." An account of these has already been given in the article **AGRICULTURE**, vol. i., page 343. Whatever the breed, the quality is much influenced both by the age of the cow and by the way in which she is fed. So clearly is it ascertained that the milk of cows not exceeding four years of age yields a larger proportion and richer quality of curd than the milk of older animals, that it is customary in some of the cheese-making districts of England to draft off the cows to the grazier after they have borne two or at most three calves each.<sup>1</sup> Cows that are prized for their pedigree, however, are of course kept for longer periods, and few will part with a good cow so long as she continues to yield abundance of milk. In large well-conducted dairies, especially where, as in a yearly increasing number of cases, shorthorns are kept, the cows are fed so well that they are sold to the butcher at very nearly their original cost as milch cows.

**Food.**—The influence which the food of the cow exerts upon the amount and qualities of her milk has always been recognized; but at one time a large yield of milk, free from any unpleasant taste, was made the chief object of regard. It was accordingly the practice in new-milk dairies to feed the cows principally with soft sloppy food, such as boiled turnips, brewers' grains, and distillery wash. The milk produced from such food contains an undue proportion of serum, and is deficient in butter, caseine, sugar, and phosphates—the very elements which give to milk its value as an article of food, and fit it so peculiarly for building up the frame of young animals. When these elements are wanting in the cow's food they are to a certain extent supplied to her milk from her own system; and hence it is that cows which give a very large quantity of milk generally lose the fat and flesh which they had accumulated before calving. In order, therefore, to maintain the condition of the cow, and enable her to give milk of the best quality, it is necessary that her food contain an adequate supply of the requisites for good milk. Her food, in short, must be substantially the same as that found most useful in feeding cattle for the butcher. It is now pretty well ascertained that the fattening process is accomplished most economically by giving a moderate allowance of linseed or other cake, and of the meal of beans, Indian corn, and other grains in addition to the pasturage, green forage, roots, and fodder, which constitute the bulk of the food of such animals. The following approved dietary for milch cows is taken from a Report on Harvey's Dairy Company, Glasgow, by H. M. Jenkins, F. G. S., published in the *Journal of the Royal Agricultural Society of England* in 1871.

"During the seven winter months, when the cows remain entirely in the byre, the daily food commences with draf (distillery refuse) about four or five o'clock in the morning, mixed

<sup>1</sup> In those districts it is usual to rear one heifer calf for each three cows, and to have the heifers to calve for the first time at 3 years old, —so that the young stock of all ages are equal in number to the cows. As many pigs are kept as suffice to consume the whey, —the proportion in summer being one pig to two cows.

with beans, peas, or Indian meal, preferably the first named, unless beans are too dear, when mixed kinds of meal are substituted. Linseed cake is occasionally given at this time to cows beginning to run dry, and also in spring to those that require a little laxative. After the first milking, viz., about seven in the morning, as much distillery refuse as they can take is freely given, and at eight o'clock either oat-straw or hay (if possible). The latter is generally rye-grass hay of the irrigated fields which are held by the Company. The next feed consists of raw turnips or cabbages, given about ten o'clock, and at eleven the cows are milked for the second time. The afternoon meal is given at two o'clock, and consists of steamed meal, turnips, and draf. At four o'clock some fodder, generally straw, is placed in the mangers, and between four and five more draf is run in. Some turnips are always put in the steamed food. At five o'clock the cows are milked for the third time, and are afterwards made up for the night.

"During the summer the cows get nothing in the byres but a little draf in the morning, when they come in to be milked, except towards the fall of the year. They are then allowed some fodder at mid-day; and in a bad season they get a little meal with their draf in the morning. They are kept on the pastures all day, but are brought up to the steading to be milked about eleven o'clock, as well as at night."

The ordinary management of cows in the cheese manufacturing districts is of a much more simple and less expensive nature than the above. In Ayrshire the cows generally begin to calve early in March, and they are all giving milk by the time when the pasture is ready for them. That time varies in ordinary seasons from the middle of April on fine early land to the middle of May on the colder soils of the uplands. The female calves from the best cows are reared on most farms. The calved cows get two meals of cooked food daily. The cooked food consists of chaff and turnips or mangold, boiled together, with bean and Indian corn meal added. The other food consists of hay or straw produced on the farm. The chaff and meal are frequently given, especially in backward seasons, for some time after the cows are on the pasture. On bare inland farms good managers use meal of some kind during a considerable part of the summer. In hot days, or cold boisterous nights, the cows are sometimes kept in the house and supplied with a little food. In August, when young grasses are failing, the cows are fed partly on second clover, or on vetches, and later in autumn cabbages and soft turnips come in to supplement the pastures. When the weather becomes inclement the cows are kept in at night, and get hay or straw with good supplies of turnips. The turnips are reduced in quantity when the cows are put dry, which may be from one to two months before the expected time of calving, and the dietary is improved again when that time approaches. Where butter is made, mangold or turnips have to be given in a judicious manner, on account of the flavor. With the turnips given soon after milking, and a little nitre put into the shallow vessels in which the milk is cooled, there is little danger of unpleasant flavor. Mangold is most valuable in the latter part of spring. Its feeding quality is then at the best, and turnips are not so good. But for quality of milk, carrots are the best food of all the so-called root crops.

Gorse, bruised and chopped, has been found a suitable kind of green winter forage for milch cows. On the large dairy farm of F. Leser & Co., near St. Louis, Missouri, the daily winter food of a cow consists of about half a bushel of brewers' grains, 6 gallons of distillery slop, mixed with from 2 to 5 lb of ship stuff, malt aprouts, bran, and Indian or cotton-seed meal, and 6 to 10 lb of good hay, chiefly Hungarian. On another American farm, at Cumberland, Rhode Island, each cow receives in summer 2 quarts of cotton-seed meal daily in addition to pasturage, and in winter 4 quarts of cotton-seed meal, and from 2 to 4 quarts of Indian meal, with English and swale hay; neither Indian meal nor wheat shorts can be substituted for the cotton-seed meal without lessening the produce of a cow by a quart per diem.

The best pasturage for cows is that afforded by good old grass land, in sheltered inclosures of modern size, where there is a constant supply of pure water. To have dairy produce of the best quality, the grass must be so stocked as to keep it always fresh grown and sweet. This is most easily secured by frequently changing the cows from one field to another; and hence the advantage of having small inclosures, one of which can be rested, while another is keeping the stock. When soiling is resorted to, Italian rye-grass is at once the cheapest and best forage that can

be used; but it can be varied, as circumstances dictate, with clover, sainfoin, vetches, or green rape. When cows are kept entirely at pasture during the summer, from 1½ to 2 acres of grass land is required for each animal; and if hay alone is given in winter (as is the practice in Gloucestershire), the produce of another 1½ acres of meadow is required to supply their winter keep. As from 1 to 1½ cwt. of green forage is an ample daily allowance for a cow, and as two cuttings of clover or Italian rye-grass, averaging 8 tons each per acre, can with suitable manuring be easily obtained, it is obvious that by soiling in summer and feeding on roots and cooked food in winter, half as much land will suffice to maintain a cow on the latter system as on the former. And, above all, the produce in milk, besides being of richer quality, is greater in quantity by fully one-fourth. The average yield per annum of milk of a cow in Gloucestershire is estimated at 525 gallons, and in Ayrshire at about 425 gallons. Under a generous house-feeding system an average of 680 gallons may be obtained. Salt ought always to be a constituent of the food of the dairy cow; to cows at grass it should be given daily, and in May and June it may be advantageously supplied twice per

diem. Withholding it for five days has been found to occasion a loss of 2 per cent. in the quantity and 7 per cent. in the quality of the milk. All changes of diet must be made with caution. The utmost vigilance must also be used to insure regularity in the times of feeding and milking, in seeing that the latter process is thoroughly performed, and in guarding the cows from exposure to extremes of heat or cold. Through inattention to these particulars the flow of milk may easily be so diminished as to render the keeping of a dairy a profitless business.

*Buildings.*—The accompanying plan shows the general arrangement and dimensions of the different portions of a modern dairy farm steading for fifty cows. It has been drawn by Mr. James Cowie, of Sundridge Hall, after the model introduced by him and approved of by the Highland Agricultural Society of Scotland, an engraving of which was given in the last edition of this work. The interior of the steading is intended to have two roofs, and is so constructed as to facilitate with the least possible labor the supplying of the cattle with straw and roots, which latter are wheeled on a tramway. The dung, which is also removed by tramway, is deposited in an adjacent covered

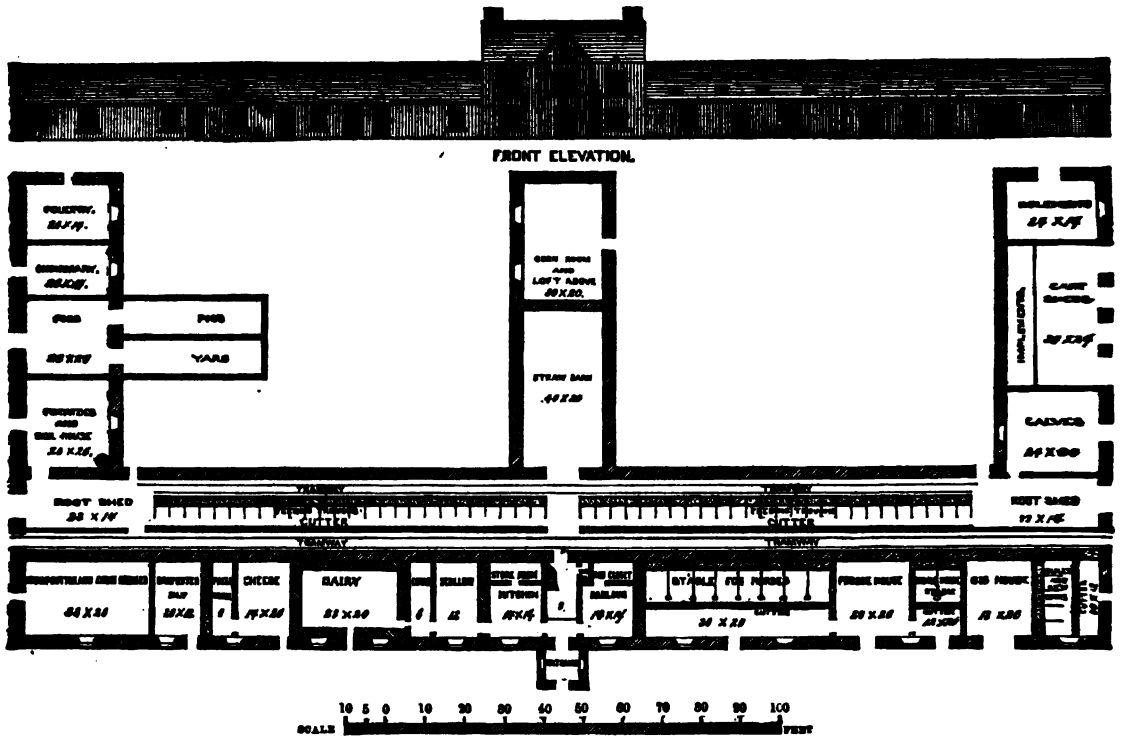

Elevation and Plan of Dairy Farm-steading.

yard, where, if need be, cattle and pigs can be kept for soiling down the dung. Sufficient ventilation can be obtained by very simple methods, and must be provided for in the course of erection. It is necessary only to add, that the principle on which the steading is constructed can be applied to either larger or smaller establishments as required.

Dairies are of three kinds, viz.—new-milk, butter, and cheese dairies.

*1. New-Milk Dairies.*—These, in or near towns, or amidst the dense population of mining and manufacturing districts, are to a large extent kept by persons who, with the aid of their families, undertake the management of from one to a dozen cows, and the delivery of the milk to customers. In our large towns there are also to be found gigantic establishments, in some of which as many as a thousand cows may be seen at one time. In these town dairies the cows are usually purchased when they have newly calved, or are at the point of calving, and they are retained till they cease to give a remunerative quantity of milk. The cows are commonly milked twice a day, but sometimes thrice, as in the case of those owned by Harvey's Dairy Company, Glas-

gow. To ensure successful milking, quietness, comfort, and kindly treatment are essential to the animals. The udders and teats should be thoroughly cleansed before the commencement of the operation. The more expeditious the milker, the better the result. The left arm should be kept firmly pressed against the cow's right leg, in order to protect the pail. Towards the close of the process the hand should reach a little above the teat, and pull down gently upon it at each delivery of the milk, so as completely to empty the udder. The milk is conveyed at once to the milk-room, where it is strained, measured, and delivered over to retailers, or to servants of the establishment, by whom it is distributed to the customers. A portion, in some cases half of the new milk is, however, retained in the dairy for twelve hours. It is then skimmed, and the cream either retailed or made into butter. This business requires the employment of a large capital, and is attended with much risk; but when well managed, is a remunerative one to those engaged in it.

Railways have occasioned the introduction of important changes in this branch of dairy business. Instead of the cows being kept in or near cities, where housing, food, and

After are costly, it has become a common practice to keep them on farms near railway stations, and to forward the new milk in suitable vessels twice a day to retail tradesmen. It is obviously easier to carry the milk to the place where it is consumed than first to convey thither the cows and their litter and food, and then to remove to the country the manure which they produce. There can be no doubt, also, that the air and pasturage of the country are of advantage to the cows.

2. *Butter Dairies.*—Wherever cows are kept some portion of the milk is used for the production of butter. The dairies, however, of extensive districts both in England and Scotland, on account of the attention given to this particular product, are appropriately spoken of as "butter dairies." In the midland and western counties of England, where the breeding of cattle is extensively carried on, the calves, two or three weeks after birth, are fed upon skimmed milk and a gruel of bruised linseed and oatmeal, so that the greater part of the new milk can be converted into butter. When the calves are all weaned, the skim-milk is employed in fattening pigs. In many parts of the country buttermilk is much relished by the laboring classes. Wherever churned milk can be readily disposed of, dairy farmers direct their attention chiefly to the production of butter.

When new milk is allowed to settle, the fat globules, being lighter than the general mass, gradually rise to the surface in the form of cream. In the process of churning, these globules are broken by the mechanical agitation, aided by the action of the lactic acid which is formed from the sugar of the milk, and the contents cohere to form butter. The usual practice is to allow the cream, whether separated from the milk or not, to stand until it begins to become acid.

Butter is made either from cream only or from milk and cream together. The best butter is obtained from the cream which rises during the first twelve hours after milking, and the next best by churning the whole milk. In the former case the new milk, after being carefully strained, is poured into shallow vessels of glazed earthenware, glass, tinned iron, wood, lead, or zinc, of which the three first-named sorts are the best. Wooden vessels are objectionable from the difficulty of cleaning them thoroughly, and lead and zinc on account of the noxious salts produced by the action of the acid of the milk on the metal. Pans of about 10 quarts capacity, made, without seams, of well-tinned sheet-iron, are in common use. Where milk is cooled by means of water the pails are made round, and about 18 inches in depth, or shallow and rectangular, with an exterior pan for containing the water. The deeper vessels are found to be most suitable in a cold, the shallower in a warm, atmosphere. To obtain as much butter from the milk as possible, the first skimming takes place at the end of twenty-four hours, and one or more skimmings are made at further intervals. The cream is stored in jars, which should be kept in a place separate from the milk-room, that the milk in the coolers may not be too early acidulated by the proximity of the sour cream. The latter is either stirred repeatedly, or poured from one vessel to another, to prevent the formation of a tough coat upon it before enough is accumulated for a churning. In large dairies it is usual to churn daily. Three days is as long as the cream can ordinarily be kept for butter of good quality. In the New York butter-factories the milk-rooms are thoroughly ventilated, and are provided with tanks sunk in the ground, and having a depth of 18 inches of flowing water for cooling the milk whilst it is throwing up its cream. The temperature of the water should be between the limits of 48° and 56° Fahr. The uniform temperature of the cream is said to have a favorable effect on the churning. When a cow has recently calved, her milk is comparatively rich in butter and poor in curd; but by and by the relative proportions of these constituents are reversed, the cream diminishing and the milk becoming thicker. A very sensible change in the quality usually takes place when a cow becomes pregnant, so that in not a few cases double or treble the ordinary length of time is required to churn the cream, and the butter produced is of inferior quality. If cows are flurried and heated, either by gadding in the pasture, or by being overdriven in bringing them home for milking, their milk becomes peculiarly liable to corrupt, the yield of butter is sensibly lessened, and its quality is impaired. The success of the process of churning depends much on the tempera-

ture of the cream being nicely regulated. Experiments have shown that a temperature of from 54° to 59° Fahr., both of the air and of the cream, is the best for churning. The temperature of the cream usually rises about 10° during this process. Advantage is derived from rinsing the churn with cold water in summer and with warm water in winter. The addition to the cream of small quantities of cold or hot water, as the case requires, is also found beneficial. Box or barrel churns are preferred when the cream only is churned, the former being best adapted for small dairies, and the latter for large ones. When the whole milk and cream are churned together, it is indispensable that acidulation and coagulation should first take place, and the churning should not be at longer intervals than every second day. When the milk is gathered for more than two days some of it is past the proper stage of acidulation at the time of churning, or part of it has not reached that stage. The time required to produce butter from whole milk is much longer than with cream alone, three hours being an average period. The plunge-churn is most appreciated for this practice; and in large dairies it is usually worked by steam, water, or horse-power. Forty strokes of the piston per minute has been found a good rate of working, but, according to a report on American butter factories, the best rate is fifty strokes per minute. The most suitable dasher for the barrel churn is either circular or cross-shaped with broad wings, and should have a diameter equal to about three-fourths of that of the central portion of the churn. The speed of working is kept slow until the cream is thoroughly mixed; it may then be increased to the normal rate. When the butter begins to come, the speed, if rapid, should be slackened. The residual buttermilk is removed from the butter by kneading either with or without water. The water should be entirely free from sediment, and not very hard. Generally brine is preferable to water alone for washing. The method of churning introduced into America by Mr. John Higgins of Speedsville, New York, consists in adding cold water twice or thrice at short intervals to the contents of the churn, so as to lower the temperature to about 55° Fahr. The dasher, which now does not rise above the surface of the cream, is worked at half speed, and the butter is produced quite pure, in large-sized, hard, and compact granules; the adherent buttermilk can be readily separated by rinsing a couple of times in water, and the butter is then ready for salting.

*Clotted Cream.*—In Devonshire a method of treating the milk has long been in use for the production of what is called clotted or "clouted" cream. The new milk is strained into shallow earthenware pans, in each of which half a pint of water has previously been placed to prevent the milk from adhering to the pan in the subsequent process of scalding; after twelve hours the pans are placed over a charcoal fire, or on a hot plate, or are immersed in cold water in a shallow boiler, which is then heated until the temperature of the milk rises to 180°, after which they are again replaced in the milk-room (great care being taken to preserve the surface of cream unbroken), and allowed to stand the usual time. The scalding effects the separation of the whole of the cream from the milk, and greatly facilitates its conversion into butter. This is readily accomplished by placing the cream in a small tub, and working it with the hand or a piece of flat wood. The butter made from it is said by some persons to be altogether superior to that made without scalding, and also to keep better; whereas others assert, and with good show of truth, that it contains an undue proportion of cheesy matter, and in consequence is more liable to rancidity than other butter.

*Lancashire Method.*—A mode of procedure in use in some Lancashire dairies has been much commended. The first drawn and larger portion of the new milk is set aside, and the cream obtained from it is mixed, at the time of churning, with the strippings or afterings, which contain the greater part of the butter obtained at milking. The labor of churning the whole of the milk is thus obviated, and a larger yield of butter is said to be obtained than when the cream only is churned.

The separation of the butter from the milk is not so complete as to secure the absence of some oily matter in the whey, and, on the other hand, of a portion of caseous matter in the butter. Cheese, being a nitrogenous substance, is peculiarly susceptible of putrefaction, and hence even the smallest portion of it present in butter is sure in a very short time to corrupt the whole mass and to impart to it a

rancid flavor. Besides this liability to taint, butter, like other fatty substances, readily absorbs odors of all kinds; and if cream or butter is kept in the same apartment with tainted meat, or other decaying matter, or is stored in vessels that have previously contained any rancid substance, or is exposed to the exhalations of dung-heaps and stables, it is sure to become contaminated. By washing the newly-churned butter repeatedly in cold water, and at the same time working a little salt into it, not only the whey, but the greater part of the caseous matter above referred to, can be removed, and the tendency to rancidity is overcome. If the butter is to be used fresh, it is immediately made into rolls or pats; but if it is to be cured, half an ounce of fine salt is added for each pound of the butter, and thoroughly incorporated with it; and the mass, after lying a day, is again worked over, and then packed into a perfectly clean air-tight vessel. In domestic use the most convenient vessels are jars of glazed earthenware. Market butter is put into casks called half-firkins, firkins, and tubs, containing respectively 28 lb, 56 lb, and 84 lb. These should be of well-seasoned oak, and made perfectly tight, as otherwise the butter is sure to become tainted. Large quantities of butter are also now disposed of in sealed tins. From the facilities which railways afford for cheap and rapid carriage, a very great proportion of our home-made butter is sent to market in a fresh or only slightly salt state.

The average yearly product of butter per cow in the butter dairies is usually estimated at from 170 to 200 lb. This is in addition to the new milk used in rearing the heifer calves required to keep up the stock, and to the butter consumed in the farmer's family.

**3. Cheese Dairies.**—Cheese-making is by far the most difficult department of dairy management. Although the art is universally practised, and the raw material is everywhere substantially the same, there is perhaps no equally common product which varies so much in its quality and market value, from mere diversity in the skill with which it is made. The difficulty of producing really good cheese arises from the peculiar susceptibility of milk to be influenced by a great variety of external causes, and the extreme facility with which its component parts undergo chemical changes.

Casein, the chief ingredient of cheese, is held in solution in milk by means of an alkali. The effect of neutralizing this alkali is to produce insoluble casein, which when dried forms cheese. When milk is allowed to stand, coagulation takes place on account of the formation of lactic acid. There are various substances which, when added to new milk, promote speedy coagulation. The preparation which is invariably used for this purpose in British dairies is rennet, provincially called *steep* or *yearning*, which is made from the stomachs of sucking calves. To cure them, the stomachs, usually termed bags or vells, as soon as taken from the animal, are turned inside out, carefully freed from all impurities, and salted. They are then packed one upon another, with layers of salt between, into a deep earthenware vessel, and are covered over with salt, the air being excluded by a close-fitting lid. In the best English dairies the skins are invariably kept for a year previous to use. About a month before the rennet is needed, a sufficient number of the skins are taken out of the jar, and when the brine has drained from them, they are spread out upon a table, powdered on both sides with fine salt, rolled with a paste roller, distended with a splint of wood, and hung up to dry. The rennet is made the day before use by putting into a cup with half a pint of lukewarm water and a tea-spoonful of salt a square inch of the bag for each 10 gallons of milk to be curdled. The power of effecting coagulation is attributed to the minute globular germs existing in prodigious quantities in the steep. The production of these appears to be connected with a kind of decay in the skin, which, however, if it goes too far, causes the cheese made to corrupt prematurely, and renders it unwholesome. In some dairies as much of the rennet is infused at one time as serves for several weeks, or even months; but the practice of the best dairies is in favor of its daily or at most weekly preparation. To produce cheese of the best quality it is indispensable that the rennet be sweet and good, that only so much of it be used as will suffice to effect perfect coagulation, and that this takes place at a proper temperature. Too much rennet makes a tough curd and a poor, ill-flavored cheese. The time the milk takes to coagulate varies with different modes of churning.

The cheese-dairy comprises a milk-room, working-salting and drying-room, and cheese-room. The work-room is provided with two boilers—a smaller one for heating water, and a larger one for heating whey. There are also lead tanks for containing the fresh whey, and a term in which, after being scalded, it is stored for use. The cheese-tub is of wood or tinned iron, the latter the best, as it admits of being thoroughly washed, while the wooden vessel, being porous, is exceedingly apt to minute particles of milk or whey, which, souring the wood, become a source of mischief to the future of the cheese. The other utensils are lever-presses, cheese-vats, turned out of the solid and hooped with wood, panned iron or brass for heating milk by immersion in water, a cheese-ladder, a curd-breaker, a curd-mill, and a thermometer.

In England the cows are milked twice a day, at 4 and 5 P. M. The whole available hands are engaged in this work, that it may be accomplished speedily. Each person has seven or eight cows to his share, and occupies about ten minutes in the milking of each. The milk is carried to the dairy as fast as it is drawn from the cows, and is there consigned to the care of the maid, who proceeds in her treatment of it according to the variety of cheese to be produced. The kinds of cheese in best estimation and of greatest market value are Cheddar, Cheshire, and Gloucester. The first was made in Leicestershire, and contains the cream of the milking, added to the new milk of the next day. The Cheshire and Cheshire cheeses are made from new milk rather than from milk in which all its own cream is removed. Gloucester cheese is usually deprived of a small portion of its cream. Double and single Gloucester differ in the former being twice the thickness and weight of the latter, and consequently taking longer to ripen. Scotch variety, called Dunlop, and the Gouda of Holland are full-milk cheeses. Cheddar cheese is now generally made in Ayrshire and the other cheese-making counties in Scotland. The following is an abstract of a report presented by Mr. Drennan to the Ayrshire Agricultural Association in 1854, describing the method followed by Hardington's dairy in Somersetshire:—

Immediately after the morning milking, the milk is mixed with that of the preceding evening, the whole being brought to the temperature of from 80° to 82° Fahr. by heating a quantity of the evening milk. In spring and towards winter a small quantity of annatto is used to improve the color of the cheese. It is put into the milk along with the rennet at 8 o'clock. After the rennet is added, an hour is required for coagulation. At 8 o'clock the curd is partially broken up, allowed to subside a few minutes, in order that a small quantity of whey may be drawn off to be heated. This whey is put in a tin vessel and placed on a boiler in a separate apartment, to be heated in hot water. The curd is then most carefully and minutely broken with utensils called shovel breakers, and much of the heated whey is mixed with it as suffices to raise the temperature at which the rennet was added. Soon after 9 o'clock the work is resumed. A few pailfuls of whey are drawn off and heated to a higher temperature than at 8 o'clock. The curd is then broken as minutely as before; and after several pailfuls of heated whey are poured into the mass, the pouring in of the whey the stirring with the breakers is actively continued, in order to mix the whole regularly, and to allow any portion of the curd to become overheated. The temperature at this time is raised to 100°, as ascertained by a thermometer, and the stirring is continued until, at length, the minutely broken pieces of curd acquire a certain degree of consistency. The curd is then left half an hour to subside, at the expiry of the half hour it has settled at the bottom of the tub. Drawing off the whey is the next operation. The proportion of the whey is lifted in a large tin bowl, and passed through a hair sieve into the adjoining coolers. The whey above the mass of curd is removed, a spigot is turned to the bottom of the tub, and the remainder is allowed to drain without the application of pressure. To facilitate this part of the work the tub is made with a convex bottom, and the whey is run out from the sides of the tub and heaped up on the centre, and left for an hour with no other pressure than its own weight. It is then cut across in large slices, turned over on the centre of the tub, and left in a heap as before for an hour. The whey drips away toward the sides of the tub, and runs off at the spigot; and, no pressure being applied, it continues to come away comparatively pure. After undergoing this treatment the curd is ripe for the application of salt. If, as is usual, it be warmer than 60°, it is broken up by the hand and thrown upon a lead cooler to bring it down











The desired temperature. It is then put into vats, and subjected to moderate pressure for about an hour; after which it is broken finely in a simple curd mill, mixed with salt, and made up into cheeses. From 2 to 2½ lb of salt may be given to one cwt. of curd. The cheese is put into the lever-press at from two to three o'clock of the day on which it is made; next morning it is reversed in the vat, with a calico cloth upon it to give it a smooth surface; on the following morning another fine cloth is put upon it; and after another day of the press it is laid upon the shelf.

Skilful management during the ripening of the cheese is now regarded as indispensable to complete success. To enable a cheesemaker to come to the front rank, he must have a good cheese-room, with means of regulating heat and ventilation. Great attention is now paid to this important matter in many of the Scotch dairies, and still more in the cheese-factories of America.

New-milk cheese, when skilfully made, consists not of the casein only, but includes nearly all the butter of the milk. A portion of the latter is however, carried off in the whey, from which it is recovered by a simple process. The whey is heated in a boiler to 180°, at which point a small quantity of sour buttermilk is stirred into it, which has the instantaneous effect of causing all the buttery matter to rise to the surface, from which it is skimmed off and put into a jar. As soon as the buttermilk is put in, the fire is withdrawn to prevent the whey from reaching the boiling-point. The whey thus deprived of its cream is run into a cistern, whence it is dealt out to the pigs. The whey-cream is kept for three or four days until it thickens, and is then churned like ordinary cream. About half a pound of this whey-butter is obtained weekly from each cow. Its value is about three-fourths of that of cream butter.

According to the reports of 43 New York factories in 1869, from 9-14 to 10-11 lb of milk is requisite to make 1 lb of cured American cheese.

In the province of Parma, in Italy, the annual quantity of milk used in cheese-dairy farms was about the year 1872 estimated in round numbers at 1,540,700 gallons, yielding 855,400 lb of "grana" or Parmesan cheese, 253,530 lb of butter, and 524,700 lb of "ricotta," a fresh common cheese, made after the butter and cream have been for the most part removed from the milk. In the hill district 1000 litres of milk will produce 18 kilogrammes more butter, cheese, and ricotta than in the plain. In the majority of the dairy-farms work is carried on during only six or eight months in the year.

The following is an estimate of the amount, description, and cost of the year's food of an average Ayrshire milch-cow on a good farm in the cheese and butter-producing districts, and the value of the produce:—

1. Keep.—3½ to 4 tons of roots during 200 days in winter, given raw or cooked, at 12.....	£2 5 0
40 to 50 stones of meal, cake, and bran, etc.....	2 10 0
Summer's grass.....	5 0 0
Straw given as fodder and litter over and above value of dung.....	2 0 0
Expenses of attendance, feeding, and milking, as well as deterioration of value of cow, interest on its price, and various risks, estimated at....	4 5 0
Making outlay about.....	£16 0 0
2. The produce of a cow treated as above may be estimated for the year at say from 500 to 600 gallons of milk, which if disposed of as new milk from the cow would give, at 8d per gallon, about.....	£20 0 0
Profit.....	£4 0 0

When hay is used, as in Ireland in the neighborhood of Cork, and in many districts where roots are not grown, the quantity estimated for the winter's keep of a cow is 1½ tons.

If made into butter the milk would produce about 220 lb, which at 1s. 5d. a lb would amount to £15, 11s. 8d., to which must be added the value of buttermilk sold or used for feeding pigs, say £3, making in all as the produce of the year, £18, 11s. 8d. Again, if converted into cheese, the produce may be estimated at 550 lb at 7½d. per lb, or about £17—which, with perhaps 25s. as value of whey, gives £18, 5s. as the result of this system. These calculations are made on the recognized standard that 1 gallon of milk produces 1 lb of cheese, and that 2½ gallons produce 1 lb of butter.

<sup>1</sup>[On November 3, 1889, this territory was admitted into the Union as the two States of North Dakota (area, 70,195 square miles; pop. 18,719) and South Dakota (area, 76,850 square miles; pop. 328,906), Capitals, Bismarck and Pierre.

DAISY, the name applied to the plants constituting the genus *Bellis*, of the natural order *Compositae*, and sub-order *Corymbifera*. The flowers in this genus have a small, hemispherical, erect calyx; florets of the disk numerous and tubular; phyllaries strap-shaped and slightly notched; filaments hair-like and very short; anthers forming a cylindrical notched tube; achenes obovate and compressed; and no pappus. The common daisy, *B. perennis*, is the only representative of the genus in Britain and Ireland. It is a perennial abundant everywhere in pastures and on banks in Europe, except in the most northerly regions, where, as in America, it is a garden-plant. The stem of the daisy is short; the leaves are numerous, crenate or crenate-serrate, slightly hairy, obovate-spathulate, and arranged in a rosette; and the rootstock is creeping, and of a brownish color. The flowers are to be found from March to November, and occasionally in the winter months. Their scapes bear single blossoms, with phyllaries in one row, and often red externally or at the tips; the florets of the disk are short and yellow. The size and luxuriance of the plant are much effected by the nature of the soil in which it grows. The cultivated varieties, which are numerous, bear finely colored flowers, and make very effective borders for walks. What is known as the "hen-and-chicken" daisy has the main blossom surrounded by a brood of sometimes as many as 10 or 12 small flowers, formed in the axils of the scales of the involucre. The daisy (Ang. Sax., *dagas eage*, day's eye) rolls up its florets on the approach of rain, and unfolds them once more on the return of bright weather; and, like the marigold, it "goes to bed w' the sun, and with him rises weeping." Chaucer writes—

"The daisie, or els the eye of the dale,  
The emprise, and the floure of flouris alle;

and again—

"To seen this floure agens the sunne sproved  
Whan it riseth early by the morrow,  
That blissful sight softentheth all my sorrow;"

and the flower is often alluded to with admiration by the other poets of nature. To the farmer, however, the daisy is a weed, and a most wasteful one, as it exhausts the soil and is not eaten by any kind of stock. In French the daisy is termed *la marguerite* (*μαργαριτης*, a pearl), and "herb margaret" is stated to be an old English appellation for it. In Scotland it is popularly called the gowan, and in Yorkshire it is the bairnwort, or flower beloved by children. The Christmas and Michaelmas daisies are species of aster; the ox-eye daisy is the species *Chrysanthemum Leucanthemum*.

DAKOTA, a territory<sup>1</sup> of the United States of North America, bounded on the N. by the Dominion of Canada, E. by Minnesota and a small part of Iowa, S. by Nebraska, and W. by Montana and Wyoming. It is situated between 42° 28' and 49° N. lat. and 96° 20' and 104° W. long.,—thus extending about 400 miles from E. to W. and about as much from N. to S., with an area estimated at 150,932 square miles. With the exception of a small portion drained by the Red River and the Minnesota, Dakota belongs to the basin of the Missouri, which enters at the N. W. corner as a navigable river, and proceeds with considerable meandering for upwards of 1000 miles in a S. E. direction across the territory, receiving from the right the Little Missouri, the Big Knife, the Cannon Ball, the Grand River, the Owl, the Big Sheyenne, the Bad River, and the White River, and from the left, besides a large number of small tributaries, one considerable affluent known as the James or Dakota River, which traverses nearly the whole length of the territory with a predominant southern direction, and joins the larger stream at the S. E. corner. There are no mountains of any importance in the territory except the Black Hills on the Western frontiers, which attain a height of 6700 feet; but a plateau called the Coteau des Prairies, with a mean elevation of 1450 feet above the level of the sea, occupies a considerable area on the eastern borders, and another known as the Coteau du Missouri stretches south between the Missouri and the Dakota. A large district in the south-west between the White River and one of the main branches of the Big Sheyenne bears the descriptive designation of the Mauvaises Terres. In the Coteau des Prairies and several other parts of the territory there are a large number of lakes, the most extensive of which is the Minniwakan or Devil's Lake, a sheet of salt water 40 miles

long by about 12 miles in breadth. Dakota has hitherto been only partially explored, but the military expedition of 1874 under the command of General Custer reports very favorably of the soil and climate of the virgin districts. A large part of the surface consists of open prairie-land finely adapted for the raising of stock, and most of the river-valleys appear suitable for the plough. The experience of the settlers shows that Indian corn, wheat, barley, oats, and potatoes, as well as apples, plums, grapes, and hops, can be successfully cultivated. The hills are covered with timber, mostly pine and spruce; while the banks of the rivers are in many places bordered with ash, elm, poplar, maple, and other trees. The mineral wealth of the region includes deposits of iron ore, extensive beds of limestone, gypsum, and sandstone, and a certain amount of plumbago and gold. Coal, lead, and petroleum have also been discovered. Buffaloes, bears, antelope, and elk are still abundant in the remoter districts; and the beaver still builds his dam in many of the streams. The population of Dakota is mainly aboriginal,—the principal tribes being the Sioux in the south, who number about 28,000, and the Arickarees, the Gros-Ventres, and the Mandans in the north-west. The chief settlement of the whites, Yankton on the Missouri, had in 1870 a population of 787; and the whole amount of land under cultivation at the same date was 42,645 acres. The northern Pacific railroad passes through the territory from east to west, entering at Fargo on the Red River, crossing the Missouri at Burleigh City, and proceeding onwards to cut the Yellowstone River at Wolf Rapids in Montana. The territory is administered in the same way as the other territories of the United States. Dakota belongs to the ancient French district of Louisiana, which was purchased by the United States in 1803. It was not till 1861 that it was separated from Minnesota and received a separate organization; and its present boundaries only date from 1868, when it surrendered 89,665 square miles for the formation of the territory of Wyoming. It began to be colonized in 1859, and its first legislature met in 1862.

DALBERG, CHARLES THEODOR ANTON MARIA, PRINCE OF (1744-1817), was the son of a prince of Dalberg who was one of the chief councillors of the elector of Mainz. Having attended the universities of Göttingen and Heidelberg, he devoted himself to the study of canon law, and entered the church. In 1772 he was appointed counsellor and governor of Erfurt by the elector of Mainz, the duties of which position he fulfilled in the most exemplary manner, displaying the highest conscientiousness, and doing all that he could to promote the interests of his people. After other advancements, he became in 1802 archbishop and elector of Mainz. Being obliged by the terms of the peace of Lunéville to give up Worms and Constance, he received Ratisbon, Aschaffenburg, and Wetzlar. In 1804 he visited Paris in order to discuss with Pius VII. the affairs of the Catholic Church of Germany. The result was that he gave way to the wishes of Napoleon, and thereby considerably diminished his popularity at home. The emperor did not fail to reward him; and, on the formation of the Confederation of the Rhine, though he was forced to resign his post as archchancellor of the emperor, he received more than compensating dignities. These, however, on the fall of Napoleon, he was forced to resign; and he died, holding no other office than that of archbishop of Ratisbon (10th February, 1817). The friend of Goethe, Schiller, and Wieland, Dalberg was himself a scholar and author.

He produced several works on art and philosophy, including *Grundsätze der Ästhetik, Betrachtung über das Univerum, Von dem Bewusstsein als allgemeinem Grunde der Weltweisheit*, and two works on the social influence of art. See Krüger, *Karl Theodor von Dalberg* (Leip., 1821).

D'ALEMBERT, JEAN LE ROND (1717-1783), French mathematician and philosopher, was born at Paris in November, 1717. He was a foundling, having been exposed in the market near the church of St. Jean le Rond, Paris, where he was discovered by a commissary of police on the 17th November. It afterwards became known that he was the illegitimate son of the Chevalier Destouches and Madame de Tencin, a lady of somewhat questionable reputation. Whether by secret arrangement with one or other of the parents, or from regard to his exceedingly feeble state, the infant was not taken to the foundling hospital, but intrusted to the wife of a glazier named Rousseau who

lived close by. He was called Jean le Rond from the church near which he was found; the surname D'Alembert was added by himself at a later period. His foster-mother brought him up with a kindness that secured his life-long attachment. When, after he was beginning to be famous, Madame Tencin sent for him and acknowledged the relationship between them, he said that she was only a step-mother, and that the glazier's wife was his true mother. His father, without disclosing himself, recognized his natural claims by settling upon him while still an infant an annuity of 1200 francs. Furnished in this way with enough to defray the expense of his education he was sent at four years of age to a boarding school, where he had learned all the master could teach him ere he was ten. In 1730 he entered the Masarin College under the care of the Jansenists, who soon perceived his exceptional talent, and prompted perhaps by a commentary on the epistle to the Romans which he produced in the first year of his philosophical course, sought to direct it to theology. They checked his devotion to poetry and mathematics, and in the science in which he was to achieve his greatest distinction he received no instruction at college beyond a few elementary lessons from Caron. His knowledge of the higher mathematics was acquired by his own unaided efforts after he had left the college. This naturally led to his crediting himself with the discovery of many truths which he afterwards found had been already established, often by more direct and elegant processes than his own.

On leaving college he returned to the house of his foster-mother, where he continued to live for thirty years. On the advice of his friends he made two successive efforts to add to his scanty income by qualifying himself for a profession. He studied law, and was admitted as an advocate in 1738, but did not enter upon practice. He next devoted himself to medicine, and in order to detach himself effectually from his favorite subject, sent all his mathematical books to a friend, who was to retain them until he had taken his doctor's degree. His natural inclination, however, proved too strong for him; within a year the books had all been recovered, and he had resolved to content himself with his annuity and give his whole time to mathematics. He led a simple regular life in the house of the glazier, whose circumstances he contrived somewhat to better out of his limited means. His foster-mother continued to show a warm attachment to him, though she took no interest in his pursuits, and professed something like contempt for his fame. "You will never," she said, "be anything but a philosopher. And what is a philosopher? A fool who plagues himself during his life that men may talk of him after his death."

In 1741 D'Alembert received his first public distinction in being admitted a member of the Academy of Sciences, to which he had previously presented several papers, including a *Mémoire sur le calcul intégral* (1739). In this he pointed out some errors in Beinaur's *L'Analyse Démonstrée*, which was regarded as a work of high authority. In his *Mémoire sur la réfraction des corps solides* (1741) he was the first to give a theoretical explanation of the familiar and curious phenomenon which is witnessed when a body passes from one fluid to another more dense, in a direction not perpendicular to the surface which separates the two fluids. Two years after his election to a place in the Academy he published his *Traité de Dynamique*. The new principle developed in this treatise, known as D'Alembert's Principle, may be thus stated—"If from the forces impressed on any system of bodies, connected in any manner, there be subtracted the forces which, acting alone, would be capable of producing the actual accelerations and retardations of the bodies, the remaining forces must exactly balance each other." The effect of this is greatly to simplify the solution of complex dynamical problems by making them problems of statics.

So early as the year 1744 D'Alembert had applied this principle to the theory of the equilibrium and the motion of fluids; and all the problems before solved by geometers became in some measure its corollaries. The discovery of this new principle was followed by that of a new calculus, the first trials of which were published in his *Réflexions sur la cause générale des Vents*, to which the prize medal was adjudged by the Academy of Berlin in the year 1746, and which was a new and brilliant addition to his fame. He availed himself of the favorable circumstances of the king of Prussia having just terminated a glorious

campaign by an honorable peace, to dedicate his work to that prince in the following Latin lines:—

*Hinc ego de ventis, dum ventorum coeget alis  
Palantes agit Austriacos Fredericus, et orbis,  
Insigne lauro, ramum præstendit olivæ.*

Swifter than wind, while of the winds I write,  
The foes of conquering Frederick speed their flight;  
While laurel o'er the hero's temple bends,  
To the tir'd world the olive branch he sends.

This flattering dedication procured the philosopher a polite letter from Frederick, and a place among his literary friends. The king made repeated attempts to induce him to settle in Berlin without success. In 1754 he induced D'Alembert to accept a pension of 1200 francs a year, and in 1763 the philosopher visited Berlin, where he was received with great respect. He finally refused on that occasion the office of president of the Academy of Berlin, which had been already offered to him more than once. In 1747 D'Alembert applied his new calculus of partial differences to the problem of vibrating chords, the solution of which, as well as the theory of the oscillation of the air and the propagation of sound, had been given but incompletely by the geometers who preceded him, and these his masters or his rivals. In 1749 he furnished a method of applying his principles to the motion of any body of a given figure; and he solved the problem of the precession of the equinoxes, determined its quantity, and explained the phenomenon of the nutation of the terrestrial axis, discovered by Dr. Bradley. In 1752 he published a treatise on the Resistance of Fluids, to which he gave the modest title of an *Essay*, but which contains a large number of original ideas and new observations. About the same time he published, in the *Memoirs* of the Academy of Berlin, "Researches concerning the Integral Calculus," a branch of mathematical science which is greatly indebted to him for the rapid progress it has made in the present century. In his *Recherches sur différents points importants du système du monde* (1754-8) he perfected the solution of the problem of the perturbations of the planets, which he had presented to the Academy some years before.

While the studies of D'Alembert were confined to geometry, he was little known or celebrated in his native country. His connections were limited to a small society of select friends; he had never seen any man in high office except the Marquis d'Argenson. Satisfied with an income which furnished him with the necessaries of life, he did not aspire after opulence or honors; nor had they been hitherto bestowed upon him, as it is easier to confer them on those who solicit them than to look out for men who deserve them. His cheerful conversation, his smart and lively sallies, a happy knack at telling a story, a singular mixture of malice of speech with goodness of heart, and of delicacy of wit with simplicity of manners, rendered him a pleasing and interesting companion; and his company, consequently, was much sought after in the fashionable circles. His reputation at length made its way to the throne, and rendered him the object of royal attention and beneficence. He received also in 1756 a pension from Government, which he owed to the friendship of M. d'Argenson.

D'Alembert's association with Diderot in the preparation of the celebrated *Dictionnaire Encyclopédique* led him to take a somewhat wider range than that to which he had hitherto confined himself. He wrote for that work the *Discours préliminaire* on the rise, progress, and affinities of the various sciences, which he read to the French Academy on the day of his admission as a member, the 19th December, 1754. Condorcet, in his *Éloge*, characterizes it as one of those works which only two or three men in a century could produce. Comprehensive in its plan, and clear in its statement, it deserves this often quoted praise; but it is open to the criticism that the fundamental principle, adopted from Bacon, on which it classifies the sciences is untenable. D'Alembert distinguishes the human faculties into memory, reason, and imagination, and following out that distinction classifies all science under the three heads of history or the science of memory, philosophy or the science of reason, and poetry or the science of imagination. Now, it is obvious that even if these are in each case the faculties primarily concerned, which is not beyond question, no science is the product of any one faculty exclusively. D'Alembert wrote several literary articles for the first two volumes of the *Encyclopædia*, after which the work was suppressed for a

time. To the remaining volumes he contributed mathematical articles chiefly. One of the few exceptions was the article on "Geneva," which involved him in a somewhat keen controversy in regard to Calvinism and the suppression of theatrical performances within the town. During the time he was engaged on the *Encyclopædia* he wrote a number of literary and philosophical works, which extended his reputation and also exposed him to criticisms and controversy, as in the case of his *Mélanges de Philosophie, d'Histoire, et de Littérature*. His *Essai sur la société des gens de lettres avec les grands* was a worthy vindication of the independence of literary men, and a thorough exposure of the evils of the system of patronage. He broke new ground and showed great skill as a translator in his *Traduction de quelques morceaux choisis de Tacite*. One of his most important works was the *Éléments de Philosophie*, published in 1759, in which he discussed the principles and methods of the different sciences. He maintained that the laws of motion were necessary, not contingent. The work furnished occasion for a renewal of his correspondence with Frederick the Great. A treatise *Sur la destruction des Jésuites* (1765) involved him in a fresh controversy, his own share in which was rendered very easy by the violence and extravagance of his adversaries. The list of his more noteworthy literary works is completed by the mention of the *Histoire des membres de l'Académie française*, containing biographical notices of all the members of the Academy who died between 1700 and 1772, the year in which he himself became secretary. D'Alembert was much interested in music both as a science and as an art, and wrote *Éléments de Musique théorique et pratique*, which was based upon the system of Rameau with important modifications and differences.

D'Alembert's fame spread rapidly throughout Europe and procured for him more than one opportunity of quitting the comparative retirement in which he lived in Paris for more lucrative and prominent positions. The offer of Frederick the Great has already been mentioned. In 1762 he was invited by Catherine of Russia to become tutor to her son at a yearly salary of 100,000 francs. On his refusal, the offer was repeated with the additional inducement of accommodation for as many of his friends as he chose to bring with him to the Russian capital. D'Alembert persisted in his declination, and the letter of Catherine was ordered to be engrossed in the minutes of the French Academy. A foreign honor of a different kind had previously been bestowed upon him. In 1755, on the recommendation of Pope Benedict XIV., he was admitted a member of the Institute of Bologna. A legacy of £200 from David Hume showed the esteem in which he was held by that philosopher.

D'Alembert continued to the end to lead the quiet and frugal life which his limited means, as well as his simple tastes, dictated. He was abstemious in his habits, and never tasted any alcoholic beverages. His later years were saddened by circumstances connected with a romantic attachment he had formed for Mademoiselle de l'Espérance. He made the lady's acquaintance at the house of Madame du Deffand, a noted resort of literary men and savans. She nursed him assiduously during an illness he had in 1766, and from that period till her death in 1776 they lived in the same house without any scandal attaching to their intimacy. On her part there seems to have been from first to last nothing more than warm friendship, but his feelings towards her were of a stronger kind, and her death deeply affected him. He never recovered his elasticity of spirits, though he continued to occupy himself with his favorite pursuits, and to frequent the society of his brother philosophers. After the death of Voltaire (1778), whose friend and correspondent he had been for more than thirty years, he was regarded as the leader of the philosophical party in the Academy. He died on the 29th October, 1783.

The chief features of D'Alembert's character were benevolence, simplicity, and independence. Though his income was never large, and during the greater part of his life was very meagre, he contrived to find means to support his foster-mother in her old age, to educate the children of his first teacher, and to help various deserving students during their college career. By his practice as well as by the work above referred to (*Essai sur la société des gens de lettres*, etc.) he did much to destroy the unworthy subserviency of literary and scientific men to the socially great and the politically powerful. If his manner was sometimes

plain almost to the extent of rudeness it probably set all the better an example of a much needed reform to the class to which he belonged. The controversy as to the nature of his religious opinions, arising as it did chiefly out of his connection with the Encyclopædia, has no longer any living interest now that the Encyclopædists generally have ceased to be regarded with unqualified suspicion by those who count themselves orthodox. It is to be observed, moreover, that as D'Alembert confined himself chiefly to mathematical articles, his work laid him less open to charges of heresy and infidelity than that of some of his associates. The fullest revelation of his religious convictions is given in his correspondence with Voltaire, which was published along with that with Frederick the Great in Bossange's edition of his works.

The scientific works of D'Alembert have never been published in a collected form. The most important of them have been mentioned above, with the exception of the *Opuscules mathématiques* (1761-80, 8 vols. 4to). His literary and philosophical works were collected and edited by Bastien (Paris, 1805, 18 vols., 8vo). A better edition by Bossange was published at Paris, in 1821 (5 vols. 8vo). The best account of the life and writings of D'Alembert is contained in Condorcet's *Éloge*, presented to the Academy and published in 1784.

DALGARNO, GEORGE (c. 1626-1687), an ingenious but now almost forgotten writer, born at Old Aberdeen about 1626. He appears to have studied at Marischal College; and in 1657 he went to Oxford, where, according to Wood, "he taught a private grammar-school with good success for about thirty years," and where he died on August 28, 1687. In his work entitled *Didascalocophus, or the Deaf and Dumb Man's Tutor*, printed at Oxford in 1680, he has the merit of anticipating some of the most useful modern discoveries as to the education of the deaf and dumb, including the hand-alphabet. "In prosecution of his general idea," says Dugald Stewart in his "Account of a Boy Born Blind and Deaf" (*Trans. of Royal Soc. of Edinb.* vol. vii.), "he has treated, in one short chapter, of a *Deaf Man's Dictionary*, and, in another, of a *Grammar for Deaf Persons*, both of them containing a variety of precious hints, from which useful practical lights might be derived by all who have any concern in the tuition of children during the first stage of their education." Twenty years before the publication of his *Didascalocophus*, Dalgarno had given to the world a very ingenious piece entitled *Ars Signorum*, from which, says Mr. Stewart, it appears indisputably that he was the precursor of Bishop Wilkins in his speculations concerning "a real character and a philosophical language." It is alleged that, although Wilkins does not refer to Dalgarno, it was from him that he took the hint of his celebrated work. Leibnitz on various occasions alluded to the *Ars Signorum* in commendatory terms. The works of Dalgarno, which had become exceedingly rare, have been reprinted by the Maitland Club.

DALHOUSIE, JAMES ANDREW BROWN-RAMSAY, MARQUIS OF (1812-1860), in the peerage of the United Kingdom, the great administrator who was the last of the historic governors-general under the East India Company, and may be ranked with his two most distinguished predecessors, Warren Hastings and the Marquis Wellesley. The family was founded by Sir John Ramsay, who rescued James VI. in the Gowrie outrage; but there is mention in 1140 of Simon de Ramsay as witness to the grant of Livingston Church in West Lothian; and Sir Alexander Ramsay, whom David II. made sheriff of Teviotdale, was starved to death by the Douglas. The grateful King James made Sir John Lord Ramsay of Barns and Viscount Haddington, and his son obtained a change of the title to Baron Ramsay of Dalhousie. His son was created earl of Dalhousie. The ninth earl was a distinguished Waterloo officer, held high command in Canada, was commander-in-chief in British India previous to 1832, and was created a peer of the United Kingdom as Baron Dalhousie of Dalhousie. He married Miss Broun, the heiress of Coalstown near Haddington, a woman of remarkable ability and force of character, which she transmitted to her distinguished son, who closely resembled her in features also. He was their third son, but the early death of his brothers, followed by that of their father, made him the tenth earl while yet a youth. For his long and brilliant services in India he received the thanks of Parliament, and the Crown made him marquis, a dignity that passed away with him, his only issue being two daughters, the Lady Susan, married to the Honorable

R. Bourke, M.P., brother of the sixth earl of Mayo, and the Lady Edith, first wife of Sir James Ferguson.

Born in 1812, the boy was educated at Harrow, and entered at Christ Church, Oxford, where he gave bright promise of his future career. The two most remarkable of his fellow-students were Lord Canning and Lord Elgin, who both succeeded their younger rival in the viceroy's seat, and more than once in their public career alluded to the friendship that had united the three. When Lord Ramsay, he attempted, as a follower of Sir Robert Peel, to snatch the representation of Edinburgh from Sir John (afterwards Lord Chancellor) Campbell, and James Abercromby, afterwards Speaker and Lord Dunfermline. He was afterwards elected for the county of Haddington, which he represented for a short time till called to the House of Lords on his father's death. The duke of Wellington was soon attracted by the industry and ability of the young peer, in whom, moreover, he felt an interest for his father's sake. When the Whigs went out of office under Lord Melbourne, Sir Robert Peel came into power with three colleagues who were successively to be governor-general, Lord Ellenborough as president of the Board of Control, Sir H. Hardinge as secretary at war, and Lord Dalhousie as vice-president of the Board of Trade under Mr. Gladstone, and in 1844 as president. It was in the Board of Trade that he sowed the seeds of that disease which carried him off in the prime of life. The time was that of the corn-law struggle and, still more to him, of the railway mania. Night and day the president had to work. In 1845 he organized that railway department of the Board of Trade, through which in one year he passed, after detailed personal study, 332 projects, involving a capital of £271,000,000, besides many foreign schemes which appealed to the English money-market. At the last hour of November for lodging applications no fewer than 600 schemes were deposited on his table. To him, more than any other man, Great Britain owes its railway system, and if the experienced warning of the over-worked president had been heeded, the disasters of 1847-48 would never have taken place. At the same time the duty of leading the corn-law debates in the House of Lords fell upon the wearied official. The defeat of Sir Robert Peel at the end of June, 1846, gave him no respite, for Lord John Russell asked him to remain in office, and again the Whig premier offered the young Conservative peer the office of governor-general of India, from which Lord Hardinge was returning after the first Sikh war.

Never, since Clive, had any man so young been called to bear such vast responsibilities, and yet, like Clive, he nearly doubled the empire, and adorned his rule with the blessings of peaceful and material reform. Lord Dalhousie was only thirty-five years of age when, on the 12th January, 1848, he assumed at Calcutta that high office which he held for upwards of eight years, or almost as long as the period during which Lord Hastings had been led by troublous times to fill it. Had he remained a cabinet minister, it is not difficult to predict what he might have become in the annals of British statesmanship, but he had even higher work to do in India. Lord Hardinge, guided throughout his policy by the good and great Henry Lawrence, had left the Punjab nominally at peace under a Sikh regency, but really seething with discontent and confusion. To use Lord Dalhousie's own words in reviewing the situation, the spirit of the whole Sikh people was influenced by the bitterest animosity against us, chief after chief deserted our cause, nearly the whole army and council of regency were openly arrayed against us, the Sikhs courted an Afghan alliance, and the question was no longer one of policy but of national safety. Moolraj, at Mooltan had, in April, murdered the British officers Vans Agnew and Anderson; Herbert Edwardes had in June shown how disaster could be retrieved; by September General Whish was before Mooltan with an avenging force; and on the 5th October the governor-general announced, at a military ball at Barrackpore, a general war against the Sikh Sirdars. Proceeding to the spot like another Clive he conquered, annexed, and reorganized the Punjab in six months. The crowning victory of Gujerat, on the 21st February, 1849, followed by the fall of Mooltan, avenged the drawn battle of Chillianwalla, and on the 29th March the Punjab became a British province. Borrowing from administrative experiments on a small scale in Tenasserim and Sind, the governor-general created that non-regulation system under

which military officers and civilians combined have ever since brought up to the ordinary level of our civilized administration the warlike peoples of Northern and the more savage tribes of Central and Eastern India. In the brothers Henry and John Lawrence, assisted by Sir Robert Montgomery and Sir Donald Macleod, Lord Dalhousie found men to work out his plans with such success as to convert the Punjab into the base from which, in 1857, Delhi was taken and the empire was reconquered. He returned to the capital by Bombay, the Straits Settlements, and Burmah, surveying the coast-line of the magnificent dependency which he had thus carried up to its natural boundaries, to the Himalayas from the sea. The experience he thus gained was soon to be used. The king of Upper Burmah violated the treaty of Yandaboo by a gross outrage on certain British traders in the port of Rangoon, and refused atonement. Quoting Lord Wellesley's maxim, that an insult offered to the British flag at the mouth of the Ganges would be resented as promptly and as fully as at the mouth of the Thames, after every peaceful effort had failed, the Government of India fought the second Burmese war; and, as reparation was still scorned, took possession of the kingdom of Pegu, thus uniting the territories of Arakan and Tenasserim taken in the first war into what is now the compact and prosperous coast province of British Burmah.

From that time, in 1852, the completed empire has been at peace, save for the Mutiny and little frontier campaigns. Its consolidation now became the great work of the young and triumphant governor-general, who showed on as great a scale as history can present, in a few years, that peace has greater victories than those of war. While in the minute review of his eight and a quarter years' administration Lord Dalhousie devotes 177 paragraphs to these, he records in only 3 the conquest of territories and populations as large as those of France. With the foresight and caution that marked all his statesmanship he thus closes the narrative of his wars:—"Experience—frequent, hard, and recent experience—has taught us that war from without or rebellion from within may at any time be raised against us, in quarters where they were the least to be expected, and by the most feeble and unlikely instruments." The rising of the tribe of Sonthals, a non-Aryan race of simple and now half-Christianized savages in the Rajmahal hills, due to the oppression of Hindu usurers and landlords, illustrated this. But the mutiny, to which we shall afterwards allude, has still more light thrown on it by this warning.

Lord Dalhousie made additions to those portions of the empire under direct British administration, however, not only by conquest but by annexing native states which lapsed to the suzerain power on the failure of natural and even adopted heirs, or, as in the case of Oudh, for outrageous and hopeless misrule. No part of his policy has been more misrepresented than this. His own narrative of it, written as simple history and long before it was attacked, bears the stamp of the unflinching honesty which was the basis of his nature,—the sympathy with the people and horror of oppression which influenced all his career, and the strict regard for justice which made his Government the strongest India ever had, before or since. He has been charged with the lack of imagination; but he had that as Cromwell had it, where he cared for the many rather than for the self-seeking and self-pleasing few. The question is twofold—Is it the duty or the right of the paramount power (1) to escheat states the chiefs of which persist in anarchy that not only ruins their own people but threatens their neighbors, or (2) to allow states to lapse when the chiefs leave no natural heirs and have refused to adopt a successor? The first was illustrated in the case of the kingdom of Oudh, which for the crimes of its kings, committed in spite of all warnings, was ordered to be annexed by the British Cabinet contrary to the recommendation of Lord Dalhousie, who would have again tried the policy that failed after the first Sikh war. The second is the real point at issue in his case. Now the despatch of the 30th April, 1860, in which Lord Canning urges the concession to the 153 Hindu and Mahometan princes who actually govern their estates of a distinct law of adoption and feudatory right, is based on the fact that no such law or certain usage was in existence before. Lord Dalhousie acted for the good of the natives and for the interests of the British Government, solely as their trustee, when he annexed states according to what has been called the doctrine of

lapse. His regard for purely historic claims which could not affect the happiness of the people for evil is shown by his refusal to carry out the consent of the court of directors to extinguish the dynasty of Timur on the death of the king of Delhi. He rather perpetuated the titular sovereignty by recognizing the grandson of the king as heir-apparent, on the two conditions that he should reside at the Kootub palace, outside Delhi, and "should as king receive the governor-general at all times on terms of perfect equality." To the two kingdoms of the Punjab and Pegu, won by conquest, and to the kingdom of Oudh, annexed for misrule worse than that of the Ottoman Turks, Lord Dalhousie hence added the fourth of Nagpore, "in the absence of all legal heirs," refusing to bestow the territory in free gift upon a stranger. So also he added the province of Berar, ceded by the Nizam for the permanent maintenance of the Hyderabad contingent. In Nagpore and Berar, one day to be united to Bombay, he gave Lancashire the finest cotton-field under the British Crown. So also the principality of Sattara and the chiefship of Jhansl reverted to the Indian Government. Writing in 1856 he showed that these four kingdoms and three provinces had raised the revenue of India from 26 to 30 millions sterling a year. In the twenty years since, no revenue-paying addition has been made to the empire as Dalhousie left it, for he reached the boundaries fixed by nature. But the income of the 12 provinces of British India, with the 153 native states, which cost the rest of India far more than the small tribute they pay and spend nothing on the people, has risen to 52 millions sterling a year. It has doubled since Lord Dalhousie landed at Calcutta. But, while caring for the people, he was not indifferent to the welfare and good-will of their chiefs. Himself a sincere Christian, while singularly reticent as to his personal faith, and strictly neutral as the ruler of millions of alien and opposed creeds, he thus wrote of the adoption of Christianity by Maharaja Dhuleep Singh, the last of the rulers of the Punjab:—"The act was voluntary on the part of the boy, and, under the guidance of God's hand, was the result of his own uninfluenced convictions. It is gratifying to be able to state that his life hitherto has been strictly consistent with the injunctions of the faith he professes." So he records the baptism of the Queen's ward, the princess of Coorg, at the desire of her father the ex-rajah. And in his time there was passed the Toleration Act, which, completing the good work begun by Lord William Bentinck, removed from the statute-book the last traces of the persecution of converts to Christianity, who had suffered the loss of all their goods as a penal consequence.

The catalogue of Lord Dalhousie's reforms is as interesting as it is long, but we must be content with a mere statement of those which remind us of Clive's work in his third visit to India. The Civil Service was open to the competition of all the natural-born subjects of the Crown, black and white, and at the same time the civil and military services were reorganized in India itself to supply the new territories. In Bengal, the boards, which had acted as "screens" for inefficiency were abolished or simplified, and personal government was introduced in a way which made the force of the governor-general's energy and influence felt throughout the empire. The Public Works Department, separated from the military administration, was organized in a style which has enabled it to grapple with the vast needs of the whole Peninsula. A legislative council was created which, far more effectually than the sham introduced by Lord Halifax afterwards, promised to represent both British and native opinion. Bengal, with its sixty millions, received a lieutenant-governor for itself. In a thousand details life was substituted for apathy or obstructiveness, till among all classes the genius and force of the "boy" governor-general were gratefully eulogized as had never before happened in the history of India. There was not a hostile critic. But these were small matters compared with the introduction of the four potent forces of the railway and the telegraph, cheap postage and the primary school. The triumph of physical and educational progress went hand in hand. The quondam president of the Board of Trade felt himself at his old work, but on a vaster scale, and with far more magnificent results. Every word he spoke or wrote, every act that he ordered or sanctioned, told on the civilization of the country. His it was, too, to push on and open the great

Georges Canal, which has since saved Hindustan from famine; his to make roads from Delhi through the Punjab, from the Simla and the frontier to Tibet, from Assam to Pegu. Trade and agriculture were ever before him as if he had no other work to do; cotton and tea, iron and coal, salt and other resources were carefully developed by him; and he created a forest department. When he did not think it politically expedient to make female education a care of the state, any more than even the early missionaries were prepared to attend to it, he supported the Bethune school out of his own pocket. Suttee in native states, and thuggee, or strangling, in our own, he kept down with an iron hand; female infanticide and meriah or human sacrifice he vigilantly suppressed; slavery and the slave-trade he made treaties from the Somalee coast of Africa to the Euphrates and the Irawaddy to put down. Finally, his care for the British soldier in a tropical climate was matched only by the improvement which he caused in the physical condition of the sepoya. No less a military than a civil administrator, his last act was to send home a series of minutes pressing for a reorganization and an increase of the army, in language not only unheeded, but deliberately repelled, with consequences which the mutiny soon displayed.

Such work as this, following the still greater strain of the Board of Trade during the railway mania, began to show itself even before Lord Dalhousie had completed the usual five years' term of service. He recorded at the time the bitter pang it was to him to be so ill as not to be able to accompany the first railway train which he officially sent forth in its course Bombay-wards from Howrah, the suburb opposite Calcutta. In 1855 the physicians solemnly warned him to leave, but as Her Majesty's Government laid on him the duty of annexing Oudh, he deliberately accepted the responsibility. "The ministry have asked me to stay, and I will do my duty," he replied to all remonstrances. He had, too, lost his wife, to whom he was devotedly attached—a daughter of the marquis of Tweeddale, who had been governor of Madras—and was smothered by the arrival of his eldest daughter. The hot season of 1855 he spent in the Neilgherry hills.<sup>1</sup> It was on the 6th March, 1858, that he left Calcutta, amid the tears of many, both natives and Europeans, who accompanied the great proconsul, as he was lovingly called, to the Ghaut. He knew he had no more health to look for. Sadly did he write, in his formal reply to the citizens of Calcutta—"Nearly thirteen years have passed away since first I entered the service of the Crown. Through all those years, with but one short interval, public employment of the heaviest responsibility and labor has been imposed upon me. I am wearied and worn, and have no other thought or wish than to seek the retirement of which I stand in need, and which is all I now am fit for."

Lord Dalhousie retired not only amid the regrets of the people he had ruled so well, and of the services, civil and military, which he had attached to himself at once by the splendor of his administrative genius and by the kingly fascination of his personal character. He was honored by Parliament and the Crown, while the press exhausted the terms of eulogy in reviewing the career of one who, like Clive, had proved equally great in peace and in war. The many months spent in Malta before he could brave the rigors of his native climate he devoted to a defence of his whole administration, which, unfortunately, is not now to be found. For already the outburst of the Bengal mutiny had led thoughtless or prejudiced and certainly ignorant persons to demand a victim, and they sought it in the dying governor-general. He could not take his place in the House of Lords and explain his acts and policy to unthinking and excited critics who personally knew nothing of either. In India itself, where the facts were known and he was known, he was defended as, on much less and lower grounds, Warren Hastings had been. So appealing from his contemporaries to posterity, and moved at the same time by the unauthorized publication of other family papers, he dictated the following addition to his will, which we are permitted to publish for the first time:—

"Secondly, it is my wish that on my decease the whole of the letters and private papers of every description, wherever

<sup>1</sup> The appointment, as his successor, of Lord Canning, his old college companion, gave him great pleasure; and when, soon after, he was dying and was told of the eulogy that viceroy had passed on him when opening an extension of the railway to Rajmahal, he smiled, saying, "I always knew Canning was a gentleman."

found, belonging to me, and not being legal documents connected with the Dalhousie family, should be delivered to my daughter Susan. I enjoin that at her decease, or sooner if she should think fit, all documents, journals, and letters illustrating the history of the Dalhousie family, or the career of those who have been successively its head, shall be delivered to the holder of the title of Dalhousie.—And as it has been the practice of my father and of myself to keep a full private journal during our lives, and to preserve papers of personal interest, and as there prevails in these days a mania for giving publicity to the correspondence of public men, however slight may have been their real importance in the annals of the period, or however valueless may be their written remains, I desire if possible to preserve these papers in privacy within the family to which they refer.—I direct, therefore, that when these documents shall be delivered to him who shall then be Lord Dalhousie, the delivery of them shall be accompanied by a request from me (to which I am confident he will conform, as to a request issuing from the grave) that no portion of the private papers of my father or of myself shall be made public until at least fifty years shall have passed after my death."

The papers are carefully preserved in Coalstown till the year 1910. Lord Dalhousie retired to his old boy home, in Dalhousie Castle, to die, affectionately tended by his daughter, and on the 19th December, 1860, he passed peacefully away. He was not forty-nine years old, an age when in England statesmen only begin their career, yet in England and India he had done a life-work surpassed by none, if equalled by any of his contemporaries. His marble statue, long opposite Wellesley's in the hall of Government House, Calcutta, now adorns the public institute in the public square, which both bear his name. His portrait by Sir John Watson Gordon, at Coalstown, recalls the fine head, the brow of massive breadth and height, the large and lustrous eyes, the flexible and sensitive lips, the commanding attitude which made his middle-size look like the tallness of bigger men.

The panic which sought to fasten on Lord Dalhousie responsibility for the mutiny has long since been pronounced unreasonable. All the charges against the last of the Company's governors-general may be summed up in two, political and military,—he conquered and annexed many states; he ignored or misunderstood the condition of the Sepoy army. As to the first, the despatch of Lord Canning, already alluded to—and he is identified with the opposite or non-annexation policy, which Lord Dalhousie alone made possible for his successor—shows that there was no law or regular usage on the subject. Lord Dalhousie had certainly no passion for annexation, as the Oudh case proves, and each instance must be dealt with on its own merits. It is difficult to obtain reliable evidence: to support any statement as to native opinion or feeling, even after the event, and we have none for the assertion that the series of acquisitions of territory had alarmed the native chiefs. But even if it had, we may maintain that it was the governor-general's duty to complete the empire, to care for the people, and to do this at all fair risks. To all such assertions we may reply that it was conquests like the Punjab that saved the empire when the crisis came, that it was annexations like Nagpore and Sattara which removed centres of discontent. Oudh, for which he was not responsible, and little Jhansi, which had a mad rane, were the only malcontents. All the other native chiefs were loyal, actively or passively. The military argument is still less defensible, and has been abandoned ever since Sir Charles Jackson exposed it. Lord Dalhousie foresaw trouble in India as much as any man has ever done in a country where it is the unforeseen that happens. We have already quoted an instance of this. But these words in his farewell to India might, as has been said, have been written after the mutiny. "We have learned by hard experience how a difference with a native power, which seems at first to be but the little cloud no bigger than a man's hand, may rapidly darken and swell into a storm of war, involving the whole empire in its gloom. We have lately seen how, in the very midst of us, insurrection may rise like an exhalation from the earth, and how cruel violence, worse than all the excesses of war, may be suddenly committed by men who, to the very day in which they broke out in their frenzy of blood, have been regarded as a simple, harmless, timid race, not by the Government alone but even by those who knew them best, who were dwelling among them, and were their earliest victims. Remembering these things, no prudent man will venture to give you assurance of continued peace."



The first authority on the subject, Lord Lawrence, pronounced the cause of the mutiny purely military, and found it in the greased cartridges. It was social, not political,—an assault on caste, not on princes, though doubtless Mahometan and other intriguers took advantage of the mutinous spirit. But the opportunity for the mutiny was found in the reduction of the British garrison, already too low, to a point of danger which had led to Lord Dalhousie's alarmed but unheeded protests. When he wanted more troops to meet the increase of territory he found himself denuded of two cavalry and two infantry regiments for the Crimea. The strength of the white garrison was thus reduced to 22 regiments. That reduction completed what the Afghan policy of the home authorities had begun, by placing success within the grasp of the native army. In 1854 Lord Dalhousie thus wrote:—"We are perfectly secure so long as we are strong and are believed to be so; but if European troops shall now be withdrawn from India to Europe, and if further we should be called on to despatch an army to the Persian Gulf . . . then, indeed, I shall no longer feel, and can no longer express, the same confidence as before that the security and stability of our position in the East will remain unassailed." That is prophetic enough. But it is nothing to the nine minutes which, on the last day of his office, he laid before his council and sent home, all of which were pigeon-holed, and two of which cannot be found in the records. In spite of these admirable and earnest state papers, the two infantry regiments sent to the Crimea were not replaced, and five or six of the minimum of thirty-one on the India establishment were in the Persian war, as his excellency had feared. He sought to raise the number to thirty-seven, and to reduce the Sepoy force by upwards of 14,000 men, but in vain. Had he been able to carry out his own military policy as he did in the case of purely political and administrative affairs, is it too much to say that there would have been no mutiny? In spite of the passing away of the school of political and military officers whom Lord Dalhousie created, represented now only by the venerable Lord Lawrence, every year's progress in the history of India reveals new reasons for recalling with gratitude and admiration the eight or nine years' administration of the last of the governors-general.

The detailed events of this period will be found in the volumes of the *Friend of India* and the *Calcutta Review* from 1848 to 1856 inclusive. Other and more compact sources are Marshman's *History of India*, volume iii., Sir Charles Jackson's *Vindication of the Marquis of Dalhousie's Indian Administration*, and the Duke of Argyll's *India under Dalhousie and Canning*. The "Minute by the Most Noble the Governor-General of India," dated the 28th of February, 1856, was published as No. xiv. of the *Selections from the Records of the Government of India in the Home Department in 1856*. Those who are interested in that controversy with Sir Charles Napier, in which the Duke of Wellington supported the Marquis of Dalhousie, will find the facts in *Minutes of the Resignation of the late General Sir Charles Napier of the Command of the Army in India* (John Murray, 1854). (c. sm.)

DALIN, OLOF VON (1708-1763), a Swedish poet, was born August 29, 1708, in the parish of Vinberg, in Halland, being the son of the incumbent. His mother was the daughter of a Dr. Ausén, to whom Queen Christina had offered, during her exile in Rome, a cardinal's hat if he joined the Romish Church. He was also nearly related to a still more remarkable man, Rydelius, the philosophical bishop of Lund, and the young Dalin was sent at a very early age to be instructed by him, Linneæus being one of his fellow-pupils. The quick instinct of Rydelius instantly perceived the boy's extraordinary genius, and he assisted its development in every possible way. While studying deeply at Lund, Dalin had visited Stockholm in the year 1723, and in 1726 he proceeded thither for the purpose of entering one of the public offices. Under the patronage of Baron Ralamb he rapidly rose to preferment, and his skill and intelligence won him golden opinions. It was at the age of twenty-four that he commenced his literary career by the publication of a work that was entirely new at that time in Sweden, namely the famous *Argus*, a weekly journal, founded on the model of Addison's *Spectator*. For the two years 1733, 1734, Dalin issued his brilliant paper; at the end of 1733 he had thought to give it over, but he was forced to continue by the importunity of the public. It was not till 1736 that the secret was known, and Dalin con-

fessed that he had been the writer of *Argus*. His reputation thereupon became immense. His next work was *Tänkar om Kritiker* (Thoughts about Critics), the first really æsthetic book brought out in Sweden. With the avowed purpose of enlarging the horizon of his cultivation and tastes, Dalin set off, in company with his pupil, Baron Ralamb's son, on a tour through Germany and France, in 1739-40. On his return the shifting of political life at home caused him to write his famous satiric allegories of *The Story of the Horse* and *April-Work*, which were very popular, and provoked countless imitations. He now set himself to work on the most considerable of his writings, his didactic epos of *Svenaka Friheten* (Swedish Liberty), which first appeared in 1742. Hitherto Addison and Pope had been his models; in this work he draws his inspiration from Thomson, whose poem of *Liberty* it emulated. In 1751 Dalin received the honorable post of tutor to the crown prince, afterwards Gustavus III., and gained the friendship of the literary crown prince Louis Ulrika. His position at court gave rise to many personal inconveniences, and separated him to a vexatious degree from the studies in which he had hitherto been absorbed. He held the post of tutor to the crown prince until 1756, when he was arrested on suspicion of having taken part in the attempted revolution of that year, and tried for his life. He was acquitted, but was forbidden on any pretence to show himself at court. This period of exile, which lasted until 1761, Dalin spent in the preparation of his great historical work. He had been ennobled in 1751, and made privy counsellor in 1758; and now, in 1761, he once more took his place at court. During his exile, however, his spirit and his health had been broken; in a fit of panic he had destroyed some packets of his best unpublished works, and this he constantly brooded over. On the 12th of August, 1763, he died at his house in Drottningholm. In the year 1767 his writings in *belles lettres* were issued in six volumes, edited by Bökman, his half-brother. Amid an enormous mass of occasional verses, anagrams, epigrams, impromptus, and the like, his satires and serious poems were almost buried. But some of these former, even, are found to be songs of remarkable grace and delicacy, and many display a love of natural scenery and a knowledge of its forms truly remarkable in that artificial age. His dramas also are of interest, particularly his admirable comedy of *The Envious Man*; he also wrote a tragedy, *Brynhilda, or the Unfortunate Love*, and a pastoral in three scenes on King Adolphus Frederick's return from Finland. During the early part of his life he was universally admitted to be *facile princeps* among the Swedish poets of his time; in his later days the extravagant reputation of the poetess Hedvig Nordenflycht somewhat eclipsed his glory. He possessed a singular mixture of the literary qualities which we attribute severally to Pope, to Voltaire, and to Thomson. As a prose writer, Dalin is chiefly memorable for his *History of the Swedish Kingdom*, which proceeds to the end of the reign of Charles IX.

DALKEITH, a burgh of barony and market-town of Scotland, in the county of Edinburgh, situated between the North and South Esk, 6½ miles south-east of Edinburgh. The town is for the most part clean and well-built. The principal church, an old Gothic edifice, was originally the castle chapel; in 1406 it was raised to the dignity of a collegiate church, and after the Reformation it became the parish kirk. A new church in the Early English style, with a steeple 167 feet high, was built by the duke of Buccleuch in 1840; and there is an Episcopal chapel within the palace grounds. Dalkeith has one of the largest corn-markets in Scotland, held every Thursday. There are extensive corn-mills, breweries, iron-foundries, a brass-foundry, brickworks, and tanneries. In the vicinity is Dalkeith palace, the principal seat of the duke of Buccleuch, surrounded by an extensive park. It was the temporary residence of Charles I. in 1633, of George IV. in 1822, and of Queen Victoria in 1842. Population in 1871, 6386.

DALLING AND BULWER, BARON (1801-1872). William Henry Lytton Earle Bulwer, better known during the chief part of his long and brilliant career in diplomacy, politics, and literature as Sir Henry Bulwer, was born in Baker Street, Portman Square, London, on Friday the 13th February, 1801. Upon both sides Lord Dalling's lineage was illustrious; his father's house traced back their ancestry to the Vikings of the North, and his mother's claimed

descent from the Tudors and Plantagenets. General Bulwer, when colonel of the 106th Regiment, had been married to Elizabeth Barbara Lytton, who—as the only offspring of Richard Warburton Lytton, of Knebworth Park, in the county of Hertford—was sole heiress of the family of Norreys-Robinson-Lytton of Monacdhru in the island of Anglesea and of Guersylt in Denbighshire. Her father, Warburton Lytton, was noteworthy in his generation. As an Oriental linguist he became the intimate friend of Sir William Jones; he was besides the favorite pupil of Dr. Samuel Parr, who used to brag of him as inferior only to himself and perhaps Porson in classical erudition. Three sons were the fruit of General Bulwer's marriage with the heiress of the Lyttons. The second of those three sons, Henry, afterwards Lord Dalling, having been amply provided for by his selection as heir to his maternal grandmother, while the paternal estates in Norfolk went in due course, by right of primogeniture, to his elder brother William, the maternal property in Herts passed into the possession of the youngest of the three brothers, Edward, known first as Bulwer the novelist and dramatist, and afterwards as the first Baron Lytton of Knebworth.

Lord Dalling's father was so far notable in his military capacity that, as brigadier-general of volunteers, he was one of the four commanding officers to whom was intrusted the defence of England in 1804, when threatened with invasion by the great Napoleon. Three years afterwards, on the 7th July, 1807, General Bulwer died prematurely at fifty-two at Heydon Hall. His young widow had then devolved upon her not only the double charge of caring for the estates in Herts and Norfolk, but the far weightier responsibility of superintending the education of her three sons, then in their earliest boyhood. She at once devoted herself with earnest solicitude to their instruction, and her qualifications for the duties of home instructress were certainly exceptional. For, besides having great natural gifts and instinctive refinement, she was a woman of cultured intellect and rare accomplishments. Henry Bulwer's first school was that of Dr. Curtis in Sunbury, Middlesex. Thence, while yet a stripling, he was removed to Harrow, then presided over by Dr. George Butler. His tutor there was the Rev. Mark Drury, a younger brother of the previous head master. At eighteen, Henry Bulwer was enrolled as an undergraduate at Trinity College, Cambridge, removing thence soon afterwards to Downing College, where his university career was completed. At that turning-point in his history his maiden work was published. It was issued from the press in 1822 as a tiny volume of verse, commencing with an ode on the death of Napoleon. It is chiefly interesting now for its fraternal dedication to Edward Lytton Bulwer, then a youth of nineteen, an inscription couched in terms of affectionate admiration.

On leaving Cambridge in the autumn of 1824, Henry Bulwer signalized his entrance into public life by an adventure. As emissary of the Greek Committee then sitting in London, he started for the Morea, carrying with him no less a sum than £80,000 sterling, which, immediately on his arrival at his destination, he handed over to Prince Mavrocordato and his colleagues, as the responsible leaders of the War of Independence. He was accompanied on this expedition by Mr. Hamilton Browne, who, a twelvemonth before, had been despatched by Lord Byron to Cephalonia to treat with the insurgent Government. Shortly after his return to England in 1826, Bulwer published a record of this romantic excursion, under the title of *An Autumn in Greece*. Meanwhile, bent for the moment upon following in his father's footsteps, he had on the 19th October, 1825, been gazetted as a cornet in the Second Life Guards. Within less than eight months, however, he had exchanged from cavalry to infantry, being enrolled on the 2d June, 1826, as an ensign in the 58th Regiment. That ensigncy he retained for little more than a month, obtaining another unattached, which he held until the 1st January, 1829, when he finally abandoned the army. The court, not the camp, was to be the scene of his successes; and for thirty-eight years altogether—from the August of 1827 to the August of 1865—he contrived, while maturing from a young attaché to an astute and veteran ambassador, to hold his own with ease, and in the end was ranked among the subtlest intellects of his time as a master of diplomacy. His first appointment in his new profession, at the date just mentioned, was as an attaché at Berlin.

In the April of 1830 he obtained his next step through his nomination as an attaché at Vienna. Thence, exactly a year afterwards, he was employed nearer home in the same capacity at the Hague.

As yet, ostensibly, no more than a careless loungeur in the salons of the Continent, the young ex-cavalry officer veiled the keenest observation under an air of indifference. His constitutional energy, which throughout life was exceptionally intense and tenacious, wore from the first a mask of languor. When in reality most cautious, he was seemingly most negligent. No matter what he happened at the moment to take in hand, the art he applied to it was always that highest art of all, the *ars celare artem*. His mastery of the lightest but most essential weapon in the armory of the diplomatist, tact, came to him as it seemed intuitively, and from the outset was consummate. Talleyrand himself would have had no reason, even in Henry Bulwer's earliest years as an attaché, to write entreatingly, "*Pas de zèle*," to one who concealed so felicitously, even at starting, a lynx-like vigilance under an aspect the most phlegmatic. Endowed thus highly both in intellect and in temperament, he had hardly reached his new post in the capital of the Netherlands when he found and immediately seized his opportunity. The revolutionary explosion of July at Paris had been echoed on the 25th August, 1830, at Brussels by an equally startling outburst of insurrection. During the whole of September a succession of stormy events swept over Belgium, until the popular rising reached its climax on the 4th October in the declaration of Belgian independence by the Provisional Government. At the beginning of the revolution, the young attaché was despatched by the then foreign secretary at Whitehall, Lord Aberdeen, to watch events as they arose and report their character. When he reached Ghent in the midst of the civil conflict, the commissionaire of his hotel was shot down at his elbow on the Grande Place. In the execution of his special mission he traversed the country in all directions amidst civil war, the issue of which was to the last degree problematic. Under those apparently bewildering circumstances, he was enabled by his sagacity and penetration to win his spurs as a diplomatist. Writing almost haphazard in the midst of the conflict, he sent home from day to day a series of despatches which threw a flood of light upon incidents that would otherwise have appeared almost inexplicable. Scarcely a week had elapsed, during which his predictions had been wonderfully verified, when he was summoned to London to receive the congratulations of the Cabinet. He returned to Brussels no longer in a merely temporary or informal capacity. As secretary of legation, and afterwards as chargé d'affaires, he assisted in furthering the negotiations out of which Belgium rose into a kingdom, and in so rising established for the first time on the European continent the adjusted fabric of a moderate constitutional sovereignty. Scarcely had this been accomplished when he wrote what may be called the first chapter of the history of the newly created Belgian kingdom. It appeared in 1831 as a brief but luminous paper in the January number of the *Westminster Review*. And as the events it recorded had helped to inaugurate its writer's career as a diplomatist, so did his narrative of those occurrences in the pages of the *Radical* quarterly signalize in a remarkable way the commencement of his long and consistent career as a Liberal politician. Shortly before his appearance as a reviewer, and immediately prior to the carrying of the first Reform Bill, Bulwer had won a seat in the House of Commons as member for Wilton, afterwards in 1831 and 1832 sitting there as M. P. for Coventry. Nearly two years having elapsed, during which he was absent from the legislature, he was in 1834 returned to Westminster as the representative of the metropolitan borough of Marylebone, which, as it happened, was his birthplace. That position he retained during four sessions, winning considerable distinction as a debater by his undoubted gifts of wit and oratory. Within the very year in which he was chosen by the Marylebone electors, he brought out in two volumes, entitled *France—Literary, Social, and Political*, the first half of a work which was only completed upon the publication, two years afterwards, of a second series, also in two volumes, under the title of *The Monarchy of the Middle Classes*. Through its pages he made good his claim to be regarded not merely as a keen-witted observer, but as one of the most sagacious and genial delineators of the generic

Frenchman, above all of that supreme type of the race, with whom all through his life he especially delighted to hold familiar intercourse, the true Parisian. Between the issuing from the press of these two series, Henry Bulwer had prefixed an intensely sympathetic *Life of Lord Byron* to the Paris edition of the poet's works published by Galignani, — a memoir republished sixteen years afterwards. A political argument of a curiously daring and outspoken character, entitled *The Lords, the Government, and the Country*, was given to the public in 1836 by Bulwer, in the form of an elaborate letter to a constituent. At this point his literary labors, which throughout life were with him purely labors by the way, ceased for a time, and he disappeared during three decades from authorship and from the legislature. It was within that interval of thirty years, however, that he succeeded in building up what has ever since constituted the sum and substance of his reputation, securing to him his eminent and now historical name as a diplomatist. During the period of his holding the position of chargé-d'affaires at Brussels, Bulwer had seized every opportunity of making lengthened sojourns at Paris, always for him the choicest place of residence. It was in the midst of one of these *dolce far niente* loiterings on the boulevards that, on the 14th August, 1837, he received his nomination as secretary of embassy at Constantinople. Although he held that position for little more than a year, he contrived within that brief period to make his mark upon the Ottoman empire. He did this by opening up single-handed its resources to Western Europe, through the negotiation of a commercial treaty that has ever since proved of the greatest importance, not to England alone, but in a more or less considerable way to all Christendom. Until then the mercantile relations subsisting between the Sublime Porte and the outer world were not merely unsatisfactory, they were simply intolerable. Recognizing, immediately upon his advent, the exceptional abilities of the new secretary, Lord Ponsonby, then ambassador at Stamboul, devolved upon Bulwer the responsibility of discovering some solution for this apparently insoluble problem. Dexterously overcoming difficulties which had heretofore appeared insuperable, the young diplomatist succeeded within an astonishingly brief interval in removing the barriers which hampered trade at the Golden Horn. So triumphant in their result were his negotiations that Lord Palmerston, in writing his congratulations to him from Windsor Castle, on the 13th September, 1838, pronounced his treaty a *capo d'opera*, adding that without reserve it would be at once ratified. Shortly after this achievement he was nominated secretary of embassy at St. Petersburg. Illness, however, compelled him to delay his northern journey—almost opportunely, as it happened, for in the June of 1839 he was despatched, in the same capacity, to the more congenial atmosphere of Paris. At that juncture the affairs of the Levant were threatening to bring England and France into armed collision. In 1839 and 1840, during the temporary absence of his chief, Lord Granville, the secretary of embassy was gazetted *ad interim* chargé d'affaires at the court of France. Opportunities were thus afforded him, of which he availed himself, for winning new distinction as a diplomatist. The reward earned by his devotion to his profession came to him at last towards the close of 1843. On the 14th November he was appointed ambassador at the court of the young Spanish Queen Isabella II. Upon his arrival at Madrid signal evidence was afforded of the estimation in which he was then held as a diplomatist. He was chosen arbitrator between Spain and Morocco, then confronting each other in deadly hostility. As the result of his mediation, a treaty of peace was signed between the two powers in 1844, their antagonistic interests having through his negotiations been adroitly reconciled. Two years had hardly elapsed after Bulwer's success in this way as a peacemaker when, in 1846, a much more formidable difficulty arose,—one which, after threatening war between France and England, led at last to a diplomatic rupture between the British and Spanish Governments. The dynastic intrigues of Louis Philippe were the immediate cause of this estrangement, and those intrigues found their climax in what has ever since been discreditably known in European annals as the Spanish Marriages. The storm sown in the Spanish marriages was reaped in the whirlwind of the February revolution. And the explosion which took place at Paris was answered a month afterwards at Madrid by a similar outbreak. Marshal Narvaez thereupon assumed the dictatorship, and

wreaked upon the insurgents a series of reprisals of the most pitiless character. These excessive severities of the marshal-dictator the British ambassador did his utmost to mitigate. When at last, however, Narvaez carried his rigor to the length of summarily suppressing the constitutional guarantees, Bulwer sent in a formal protest in the name of England against an act so entirely ruthless and unjustifiable. This courageous proceeding at once drew down upon the British envoy a counter-stroke as ill-judged as it was unprecedented. Narvaez, with matchless effrontery, denounced the ambassador from England as an accomplice in the conspiracies of the Progressistas; and despite his position as an envoy, and in insolent defiance of the Palmerstonian boast, *Civis Britannicus*, Bulwer, on the 12th June, was summarily required to quit Madrid within twenty-four hours. Two days afterwards M. Isturitz, the Spanish ambassador at the court of St. James's, took his departure from London. Diplomatic relations were not restored between the two countries until years had elapsed, nor even then until after a formal apology, dictated by Lord Palmerston, had been signed by the prime minister of Queen Isabella. Before his return the ambassador was gazetted a Knight Companion of the Bath, being promoted to the Grand Cross some three years afterwards. In addition to this mark of honor, he received the formal approbation of the ministry, and with it the thanks of both Houses of Parliament. Before the year of his return from the peninsula had run out Sir Henry Bulwer was married to the Hon. Georgiana Charlotte Mary Wellesley, youngest daughter of the first Baron Cowley, and niece to the duke of Wellington. Early in the following year, on the 27th April, 1849 he was nominated ambassador at Washington. During his sojourn in the United States in that capacity he acquired immense popularity. Though possessing few popular qualifications as a speaker, he frequently roused American audiences to enthusiasm by his generous sentiments and impressive address. His principal success, as ambassador at Washington, was the compact known equally in the Old World and in the New as the Bulwer-Clayton treaty, which was in the main the fruit of his sustained labor as a diplomatist. This convention, ratified in May, 1850, pledged the contracting Governments to respect the neutrality of the meditated ship-canal through Central America, bringing the waters of the Atlantic and Pacific into direct communication. If it did no other good, it unquestionably for the time being allayed the jealousies which so often before then had sprung up between the two countries in regard to the British right of protection on the Mosquito Coast and in the Bay of Honduras. After having been accredited as ambassador to the United States for three years, Sir Henry Bulwer, early in 1852, was despatched as minister plenipotentiary to the small but stately court of the grand duke of Tuscany at Florence. Shortly after his retirement from that post in the January of 1855, he was intrusted with various diplomatic missions of an almost nomadic character, in one of which he was empowered as commissioner under the 23d article of the Treaty of Paris, 1856, to investigate the state of things in the Danubian principalities, with a view to their definitive reorganization. Finally, as the crowning incident in his diplomatic career, he was installed, from May, 1858, to August, 1865, as the immediate successor, after the close of the Crimean war, of the "Great Eltchi," Viscount Stratford de Redcliffe, as ambassador extraordinary to the Ottoman Porte at Constantinople. In that capacity he fully sustained the high reputation he had acquired as a diplomatist.

When in the winter of 1865 Sir Henry Bulwer returned home from the Bosphorus it was to retire upon his pension to the lettered ease he had so well earned and to revive for a brief space in the evening of his life the recollection of his earlier successes as an advanced liberal reformer in the House of Commons. He was elected member for Tamworth on the 17th November, 1868, and retained his seat until gazetted as a peer of the realm on the 21st March, 1871, under the title of Baron Dalling and Bulwer of Wood Dalling in the county of Norfolk. Upon the eve of his return to his old haunts as a debater and politician he had asserted his claim to literary distinction by giving to the world in two volumes his four masterly sketches of typical men, entitled *Historical Characters*. This work, dedicated to his brother Edward, in testimony of the writer's fraternal affection and friendship, portrayed in

luminous outline Talleyrand the Politic Man, Cobbett the Contentious Man, Canning the Brilliant Man, and Mackintosh the Man of Promise. Two other kindred sketches, those of Sir Robert Peel and Viscount Melbourne, having been selected from among their author's papers, have since been published posthumously. Another work of ampler outline and larger pretension was begun and partially issued from the press during Lord Dalling's lifetime. The luxury of completing it, however, was denied to the hand of its author. This was the elaborately planned and vigorously opened *Life of Viscount Palmerston*, the first two volumes of which were published in 1870. A third volume appeared four years afterwards. Even then it left the story of the English statesman broken off so abruptly that the work remained at the last the merest fragment. Within little more than one year from the date of his elevation to the peerage Lord Dalling, on the 23d May, 1872, breathed his last quite unexpectedly at Naples, whither he had gone to all appearances on a mere holiday excursion. Although he had been for some time a confirmed valetudinarian, his death occurred so suddenly that it came at last almost as a surprise. Yet he had by that time entered upon his seventy-second year, more than half his life having been passed in the service of his country. In his public career he enjoyed a three-fold success—as ambassador, as politician, and as man of letters. Winning his way in each character with a seemingly careless ease, he still improved the gifts of nature and fortune by personal effort, and bore his honors with an air of distinction expressive half of fatigue, half of indifference. His popularity in society was at all times remarkable, mainly no doubt from his mastery of all the subtler arts of a skilled conversationalist. The apparent languor with which he related an anecdote, flung off a *bon mot*, or indulged in a momentary stroke of irony imparted interest to the narrative, wings to the wit, and point to the sarcasm in a manner peculiarly his own. If as envoy he helped to mould the events of his time, he left among those who came within the range of his social influence the memory of one of the most gifted and charming of companions. (C. K.)

DALMATIA, a crownland of the Austrian empire, stretching in a narrow strip along the eastern shores of the Adriatic from Austrian Croatia on the N. to Albania in the S., and bounded towards the interior by Turkish Croatia, Herzegovina, and Montenegro. It has an area of 4937 square miles, and its population in 1869 was 456,961.

The boundary towards Austrian Croatia is marked by the Velebitch Mountains, which trend to the east and reach a height of 5350 feet in Vizeruna and 5774 at Sveto-Brdo, or the Holy Mountain; and the Turkish frontier coincides with the line of the Dinarian Alps, which run parallel with the Adriatic and attain an elevation of 5940 feet in Mount Dinara. The highest mountain in the country is Orjen, in the district of Cattaro, 6225 feet. The coast is for the most part steep and rocky, and fronted by a large number of islands. Towards the north, opposite the Croatian coast, are Pago and Arbe, of which the former rises to a height of 885 feet and the latter to 1338; next come Isola Grossa, Ugliana, Isola Incoronata, and others of less importance; then to the south of the promontory of Oorich, Brazza, with Monte St. Vito, 2574 feet high; Lesina, with Monte St. Nicola, 2078; and Curzola, with a maximum elevation of 1879, forming a prolongation of the promontory of Sabioncello. To the south of Curzola lies Lagosta, and to the south of Sabioncello, Meleda. The chief natural harbors are Tajer, Zara, Sebenico, Lesina, Lissa, Curzola, Sabioncello, Meleda, Gravesa, and Cattaro.

Dalmatia is not well supplied with water. The lakes are for the most part temporary rain-pools, and the only streams of importance are the Kerka (*Tivius*) and the Cetina (*Tivrus*), which rise in the Dinara mountains. The former constitutes the boundary between Croatia and Dalmatia, and is interesting for its falls and the wildness of its scenery. The Narenta (*Naro*), which belongs mainly to Herzegovina, disembogues between the peninsula of Sabioncello and the mainland, and forms an extensive marsh.

The climate is warm and healthy, the mean temperature at Zara being 57° Fahr., at Lesina 62°, and at Ragusa 63°. The prevailing wind is the sirocco, or S. E.; but the terrible Bora, or N. E., may blow at any season of the year. The average annual rainfall is about 28 inches, but a dry and a wet year usually alternate. The greater proportion of the

surface is devoted to pasture,—only 18 per cent. being under the plough, 5½ per cent. in vineyards, and 22 per cent. in forest. Barley, wheat, maize, oats, rye, millet, beet-root, hemp, and potatoes are all grown, but in small quantities. Asses are largely used as beasts of burden; goats are strikingly numerous; and sheep are reared for the sake of their mutton, which is almost the only animal food freely consumed in the country. Asphalt, lignite, and bay-salt from Dernis and Sign, are now the only mineral products of commercial importance; and there is no manufacturing industry except the distillation of liqueurs, oil-pressing, and tile-burning. The peasant still grinds his corn with his own hands, weaves his own cloth, and prepares his own furniture. The principal exports are olive-oil, wine, salt, and rosoglio.

Dalmatia is sparsely peopled, the neighborhoods of Cattaro and of Ragusa being the areas of maximum density. About 89 per cent. of the inhabitants are the so-called Morlacks, or Dalmatians proper, who belong to the Servian race, and speak a Slavonic dialect usually distinguished as the Illyric; about 10½ per cent. are of Italian origin; and the remainder consist mainly of Albanians and Jews. The prevailing religion is Roman Catholicism, to which no fewer than 82 per cent. of the population are attached; and the Greek Church comprises almost all the rest. The Roman Catholic archbishop has his seat at Zara; and Spalato, Ragusa, Sebenico, Lesina, and Cattaro are bishoprics. Education is still in a backward state, but has made considerable advances since 1862. The political constitution is based on the law of the 28th February, 1861. The diet is composed of 43 members, including the Roman Catholic archbishop, the Greek bishop of Zara, and representatives of the chief tax-payers, the towns, and the communes. To the imperial diet Dalmatia furnishes five delegates. Zara is the capital of the country; and Benkovacz, Cattaro, Curzola, Imoski, Knin, Lesina, Macarsca, Ragusa, Sebenico, Sign, and Spalato give names to the administrative districts. With the exception of Zara, Spalato, and Sebenico, most of the towns are very small, and the great proportion of the population is distributed in petty hamlets.

*History.*—The history of Dalmatia may be said to begin with the year 180 a.c., when the tribe from which it takes its name declared their independence of Gentius the king of Illyria, and established a republic with its capital at Delminium or Delminium, which was probably situated in Dalen in the Herzegovina. In 156 a.c. the Dalmatians were for the first time attacked by the Romans, and compelled to pay tribute, but it was not till the reign of Augustus that their country was made a Roman province. A formidable revolt was suppressed by Tiberius in 9 a.d. Under the later empire Dalmatia was thoroughly Romanized, and it had the honor of giving to the world an emperor in the person of Diocletian, who retired, after resigning the purple, to Salona, the new Dalmatian capital, where he erected those buildings which still bear witness to his magnificence. (See SPALATO.) After the fall of the Western Empire, in which it was included, Dalmatia was successively in the hands of Odoacer, Theodoric, and Justinian; and in the 7th century it received the dominant element of its present population by the immigration of the Slavs, who had been invited by Heraclius. In the 9th century we find Croatian influence at its height, and Croatian princes recognised as kings of Dalmatia; but in the course of the 10th Venice extended her power over most of the towns, and about 1018 the doge took the title of duke of Dalmatia. During the 11th century the struggle went on between Croatia and Venice, till in 1091 the Hungarians took the place of the Croats. Meanwhile the maritime cities Zara, Trau, Ragusa, etc., had each almost a separate history of its own, and, like the free cities of Northern Italy, attained no small prosperity through commerce and industry. As was natural from their position and affinities, they rather sided with Venice, and in fact were sometimes really under Venetian control; but the treatment they received from the great republic alienated their affection, and in 1357–8 they opened their gates to Louis of Hungary, who became for a time master of all Dalmatia. Venetian authority was, however, again restored through most of the country, and it was not till the treaty of Campo Formio, in 1797, that Dalmatia was finally incorporated with the Austrian dominions. Since that date, with the exception of the Napoleonic period from 1805–1814, the Austrian supremacy has never been questioned, though during a considerable time the feeling of the country towards its masters was extremely hostile, and in 1869 an insurrection had to be put down by force of arms.

The literature relating to Dalmatia is very extensive. See Lucius of Trau, *De regno Dalmatia et Croatia*, 1668; Gio. Lucovich, *Dei Costumi dei Morlacci*, 1776; Cattalinich, *Monarchia*

*degli Avvenimenti successi in Dalmazia*; A. Fortis, *Travels in Dalmatia*, 1778; Schmidt, *Das Königreich Dalmatien*, 1848; Cusani, *Dalmazia*, 1846; Wilkinson, *Dalmatia and Montenegro*, 2 vols., 1848; Paton, *Highlands and Islands of the Adriatic*, 1849; Kohl, *Reisen in Istrien, Dalmatien, etc.*, 1850; Neugebauer, *Die Südslaven*, 1851; Petter, *Compendio geografico della Dalmazia, and Dalmatien in seinen verschiedenen Verhältnisse dargestellt*, Gotha, 1857; W. F. Wingfield, *Tour in Dalmatia*, 1859; Heesgaard, "Géographie pol. et phys. de la Dalmatie," in *Bulletin de la soc. de géogr.*, 1862; Noe, *Dalmatien und seine Inselwelt*, 1870; Maschok, *Manuale del regno di Dalmazia per l'anno 1875*; Schlie, *Culturbilder aus Dalmatien*, Vienna, 1875.

DALRYMPLE. See STAIR and HAILES.

DALTON, JOHN (1766-1844), the celebrated physicist and founder of the atomic theory of chemistry, was born September 5, 1766, at Eaglesfield, 2½ miles south-west of Cockermouth, in Cumberland. His grandfather, Jonathan Dalton, was a member of the Society of Friends, and Dalton as well as his parents belonged to that body. His father, Joseph Dalton, who in 1755 married Deborah Greenup, had three children.—Jonathan, John, the subject of this sketch, and Mary. The occupation in which he was engaged, namely, that of weaving woollens, was not a lucrative one, and Mrs. Dalton assisted in the support of the family by the sale of stationery. John received his early education from his father and from a Mr. Fletcher, the teacher of the Quakers' school at Eaglesfield. At the age of twelve he himself began the work of school-teaching, in which he continued for two years; then, for a year or more, he worked occasionally on his father's farm. His principal study was mathematics, in which he received aid from a distant relative, a gentleman of the name of Robinson, living in the vicinity of Eaglesfield. In 1781 Dalton left his native village to become assistant to his cousin George Bewley, the master of a school for boys and girls at Kendal; and there he spent the next twelve years of his life in teaching, and in studying Latin, Greek, mathematics, and natural philosophy. During that period he became acquainted with the blind philosopher, Mr. Gough, to whose influence and help his progress in scientific knowledge was in no small measure due. In 1785 Dalton became, through the retirement of his cousin, joint-manager with his brother of the school at Kendal, and in addition to his ordinary teaching he, in 1787 and 1791, gave courses of lectures in natural philosophy. The school was not generally popular, for its young masters were uncouth in manners, and kept aloof from society. Discipline was strict, and the elder brother Jonathan is said to have been stern and severe; John being milder and gentler, and continually preoccupied with mathematics, allowed faults to escape his notice, and was consequently preferred by the scholars. About the year 1790 Dalton appears to have been desirous to secure a larger sphere for his abilities by entering on the profession of law or of physic; but his projects meeting with no encouragement from his relations, he continued to live at Kendal, till in the spring of 1793 he obtained, mainly through Mr. Gough, the appointment of teacher of mathematics and natural philosophy in the New College, Moseley Street, Manchester. That position he retained up to the time of the removal of the College to York in 1799, when he became a private tutor. In 1794 the number of his pupils at the College, in mathematics, mechanics, algebra, geometry, book-keeping, natural philosophy, and chemistry, was 24. It was in 1792 that he first visited London, which he described as "a surprising place, and well worth one's while to see once; but the most disagreeable place on earth for one of a contemplative turn to reside in constantly."

During his residence at Kendal Dalton had contributed solutions of problems and questions on various topics to the *Gentleman's and Ladies' Diaries*; but his first separate publication was his *Meteorological Observations and Essays*, published September, 1793, a result of the study of natural phenomena during upwards of seven years previously. The book contained much original matter, but met nevertheless with only a limited sale, for, having been printed exclusively for the author, it never found its way in any large numbers into the hands of publishers. Another work by Dalton, entitled *Elements of English Grammar*, was published in 1801. On Oct. 3, 1794, Dalton became a member of the Manchester Literary and Philosophical Society, before which, on the 31st, he read a communication entitled "Extraordinary Facts relating to the

Vision of Colors." In this paper he gives the earliest account of that ocular peculiarity known as dyschromatopsia, chromatopseudopsis (false vision of colors), Daltonism, parachromatism, or color-blindness, and sums up its characteristics as observed in himself and others.<sup>1</sup> When a boy, being present at a review of troops, and hearing those around him expatiating on the gorgeous effect of the military costume, he asked in what the color of a soldier's coat differed from that of the grass on which he trod; and it was the derisive laugh and the exclamations of his companions which this question called forth that first made him aware of the defectiveness of his eye-sight. Besides the blue and purple of the spectrum he was able to recognize but one color, yellow; or, as he states in his paper, "That part of the image which others call red appears to me little more than a shade or defect of light; after that the orange, yellow, and green seem one color, which descends pretty uniformly from an intense to a rare yellow, making what I should call different shades of yellow."

On March 1, 1799, Dalton read to the Manchester Society a paper on rain and dew, and the origin of springs, which was subsequently followed by various disquisitions—on heat, the color of the sky, steam, the auxiliary verbs and participles of the English language, and the reflectibility and refrangibility of light. In May, 1800, he was elected to the secretaryship of the society, an office which he held until 1808, when he became vice-president in the place of Dr. Roget. In 1817 he became president, and remained so till the time of his death. On July 31, 1801, was read the first of four important essays by Dalton, "On the Constitution of Mixed Gases;" "On the Force of Steam or Vapor from Water and other Liquids in different Temperatures, both in a Torricellian Vacuum and in Air;" "On Evaporation;" and "On the Expansion of Gases by Heat." In the second of these he makes the striking remark,—“There can scarcely be a doubt entertained respecting the reducibility of all elastic fluids, of whatever kind, into liquids; and we ought not to despair of effecting it in low temperatures, and by strong pressures exerted upon the unmixed gases;” further, he describes experiments to ascertain the tension of aqueous vapor at different points between 32° and 212° Fahr., and concludes, from observations on the behavior of the vapor of six different fluids, “that the variation of the force of vapor from all liquids is the same for the same variation of temperature, reckoning from vapor of any given force.” In the fourth essay he observes—“I see no sufficient reason why we may not conclude that all elastic fluids under the same pressure expand equally by heat, and that for any given expansion of mercury, the corresponding expansion of air is proportionally something less, the higher the temperature. . . . It seems, therefore, that general laws respecting the absolute quantity and the nature of heat are more likely to be derived from elastic fluids than from other substances.” Dalton thus both enunciated the law of the expansion of gases, stated six months later by Gay-Lussac, and indicated the future employment of the air-thermometer.

But the most important of Dalton's numerous investigations are those concerned with the atomic theory of chemistry. The subject of chemistry seems to have first occupied his attention about the year 1796. In 1802 he had already arrived at some conception of the law of the multiple combining proportions of the elements, which was afterwards developed by him. Thus, in a paper "On the Proportion of the Several Gases or Elastic Fluids constituting the Atmosphere," read on the 29th of October in that year, he says—though, as it happened, his conclusions were based upon the incorrect supposition that the size of the vessels he employed affected the nature of the chemical union of the gases they contained—"The elements of oxygen may combine with a certain portion of nitrous gas, or with twice that portion, but with no intermediate quantity. In the former case nitric acid is the result, in the latter nitrous acid."

Dr. Thomson states (*History of Chemistry*, vol. ii.)—"Mr. Dalton informed me that the atomic theory first occurred to him during his investigations of olefiant gas and carburetted hydrogen gas." In 1850, however, in a notice of Wollaston, read before the Glasgow Philosophical Society, he remarks, "Mr. Dalton founded his theory on the anal-

<sup>1</sup> The subject is fully treated of in Dr. G. Wilson's *Researches on Color-Blindness*, 1856.

ysis of two gases, namely, protoxide and deutoxide of azote. . . . The first of these he considered as a compound of one atom of azote with one atom of oxygen, and the second of one atom of azote united with two atoms of oxygen." Inasmuch as from the recognition of the law of definite and multiple combining proportions of the elements originated the establishment of that of their relative, Dalton may be said to have received assistance in the foundation of his atomic theory from the researches here alluded to by Thomson; but the latter part of the statement is manifestly erroneous, for the two gases referred to were invariably represented by Dalton as compounds respectively of two atoms and one atom of azote (nitrogen) with a single atom of oxygen. It is doubtless the earlier of Thomson's observations that is to be regarded as correct, more especially as Dalton himself says, in 1810, in his *New System of Chemical Philosophy*, with respect to carburetted hydrogen,—"No correct notion of the constitution of the gas about to be described seems to have been formed till the atomic theory was introduced and applied in the investigation. It was in the summer of 1804 that I collected, at various times and in various places, the inflammable gas obtained from ponds." As a matter of fact, the first germs of the atomic theory were Dalton's views of the separate existence of aqueous vapor in the atmosphere, which necessitated the assumption that gases were constituted of independent atoms; indeed they are represented as such, each atom having its distinguishing symbol, in the plate accompanying the paper "On the Constitution of Mixed Gases." Dalton appears already in 1803 to have pictured to himself the form of atoms, for in a paper "On the Absorption of Gases by Water" we read—"A particle of gas pressing on the surface of water is analogous to a single shot pressing on a square pile of them," and five years later he writes in his *New System*,—"Whatever, therefore, may be the shape or figure of the solid atom abstractedly, when surrounded by such an atmosphere [of heat] it must be globular; but as all the globules in any small given volume are subject to the same pressure, they must be equal in bulk, and will, therefore, be arranged in horizontal strata like a pile of shot." At the end of the paper on "Absorption" just alluded to, Dalton gives the following first table of the relative weights of the ultimate particles of gaseous and other bodies, which was constructed, he tells us, in order to test whether the solubility of gases in water was dependent upon the weight of their particles:—

Hydrogen .....	1	Nitrous oxide <sup>1</sup> .....	13·7
Azot.....	4·2	Sulphur .....	14·4
Carbone .....	4·3	Nitric acid .....	15·2
Ammonia .....	5·2	Sulphuretted hydrogen	15·4
Oxygen .....	5·5	Carbonic acid.....	15·3
Water .....	6·5	Alcohol .....	15·1
Phosphorus .....	7·2	Sulphureous acid.....	19·9
Phosphoretted hydrogen	8·2	Sulphuric acid.....	25·4
Nitrous gas <sup>1</sup> .....	9·3	Carburetted hydrogen	
Ether.....	9·6	from stagnant water..	6·3
Gaseous oxide of carbone	9·8	Olefant gas .....	5·3

As this table contains the results of the analyses of olefant gas and carburetted hydrogen made in the summer of 1804, it must have been completed after that date, and possibly was not added to the paper containing it till shortly before the printing of the latter in November, 1805. It was in 1803, as we are informed in the preface to the *New System*, that Dalton "was gradually led to those primary laws which seem to obtain in regard to heat and to chemical combination;" and in a letter to his brother in that year he writes that he has been fully engaged in all his leisure hours in the pursuit of chemical and philosophical inquiries, "having got into a track that has not been much trod in before." Dr. Bryan Higgins, in a little pamphlet composed about the year 1775, had treated of "atoms" which united with one another; but the fixity of the constitution of chemical substances had apparently formed no part of his ideas. "The matter of fire," according to him, "limits the quantity in which æriform fluids, and bodies containing it, can combine chemically," and it is his belief that the forces of atoms measure the attraction of matter, yet he ventures on no deduction as to the comparative numbers of the attracting atoms. Upon these views we find an advance in the writings of William Higgins, who not only held that atoms combined to form mole-

cules of compound bodies, but reasoned that they must unite singly or by twos and threes, there being no intermediate division of atoms; nowhere, however, does he attempt to elevate his conclusions into a general law. Next Richter, and after him Fischer, showed the existence of definite quantitative relations between the constituents of bodies, but for these relations they assigned no cause; and it was reserved for Dalton to give to the world a theory which linked together and reduced to order and simplicity the previously disconnected and unexplained phenomena of chemical combination. Till 1811 Dalton, who drew his deductions from his own rough experimental work, was unacquainted with the observations of William Higgins; and although Richter's determinations may have aided him in the proving of his laws, still, as Dr. R. A. Smith has remarked, "they could never have given him fundamental ideas." Dalton makes the following clear distinction between his own researches with respect to the ultimate constitution of matter and those of other chemists (*New System*, pt. i. p. 213, 1808):—

"In all chemical investigations, it has justly been considered an important object to ascertain the relative weights of the simples which constitute a compound. But unfortunately the inquiry has terminated here; whereas from the relative weights in the mass, the relative weights of the ultimate particles or atoms of the bodies might have been inferred, from which their number and weight in various other compounds would appear, in order to assist and to guide future investigations, and to correct their results. Now, it is one great object of this work to show the importance and advantage of ascertaining the relative weights of the ultimate particles, both of simple and compound bodies, the number of simple elementary particles which constitute one compound particle, and the number of less compound particles which enter into the formation of one or more compound particles.

If there are two bodies, A and B, which are disposed to combine, the following is the order in which the combinations may take place, beginning with the most simple, namely:—

- 1 atom of A + 1 atom of B = 1 atom of C binary.
- 1 atom of A + 2 atoms of B = 1 atom of D ternary.
- 2 atoms of A + 1 atom of B = 1 atom of E ternary.
- 1 atom of A + 3 atoms of B = 1 atom of F quaternary.
- 3 atoms of A + 1 atom of B = 1 atom of G quaternary, etc., etc."

In 1810 appeared the second part of volume i. of the *New System*, in which the chemical elements are described. The first part of volume ii. was not published till 1827; it by no means represents the advanced state of chemical science at that time, and the appendix, giving Dalton's latest views, is the only portion of it that is of any special interest. A history of the development of the atomic theory since its first promulgation will be found under CHEMISTRY, vol. v. p. 402. By Dr. Thomson, its first advocate, by Wollaston, and by Dr. Henry, it was ably supported, and the analyses of Berzelius placed it on a stable footing. "The theory of multiple proportions," wrote Berzelius, "is a mystery without the atomic hypothesis." Strange to say, the conclusions of Gay-Lussac with regard to the combining volumes of gases, which afforded the strongest evidence in favor of the atomic theory, were distrusted, and perhaps never fully accepted by Dalton. The tenacity with which he clung to opinions once formed is further exemplified by his unwillingness to recognize chlorine as a chemical element, and his persistent use of the atomic weights first adopted by him, in spite of the later and more trustworthy determinations of other chemists. The memoirs of Dalton read before the Manchester Literary and Philosophical Society were in all 116. In one of these, read in 1814, he lays down the principles of the volumetric method of analysis, of which he is undoubtedly to be regarded as the originator, although its wide practical application is the result of the labors of numerous after-chemists. The earlier of Dalton's papers are the most important and complete; one of his latest, however, "On a New and Easy Method of Analyzing Sugar," describes a discovery of much interest, viz., that the volumes of highly hydrated salts when dissolved are equal to those of their volumes of water, the volume of he salt itself disappearing. Before Dalton had become known as the propounder of the atomic theory, he had already attained a considerable reputation by his scientific labors, and in 1804 he was chosen to give a course of lectures on natural philosophy at the Royal Institution in London. Subsequent discourses were delivered by him at the same place in the winter of 1809-10. He was, it would seem, deficient in many of those qualities that go to form an

<sup>1</sup> The figures for nitrous gas (nitric oxide) and nitrous oxide should have been 9·7 and 13·9, i.e., 5·5 + 4·2 and 5·5 + 4·2 × 2.

attractive public lecturer. His voice is said to have been harsh, indistinct, and unemphatic, and his manner of dealing with his subject ineffective; he is described, moreover, as an indifferent experimenter, and as "singularly wanting in the language and power of illustration." An imaginative or brilliant style of diction, it is to be supposed, can scarcely have been at the command of one whose hours of leisure from the routine of tuition were unceasingly devoted to laboratory work, and who eschewed, and even to some extent discouraged, literary pursuits. His library, he was once heard to declare, he could carry on his back, and yet he had not read half the books which constituted it. In the autumn of 1805 Dalton went to live in George Street, Manchester, with his friend, the Rev. W. Johns, and with him and his family he continued to reside, in the greatest harmony, for the next twenty-six years. Engaged in his favorite studies, he passed a quiet and almost uneventful life, interrupted only by occasional visits to London and other cities, and by annual excursions to the Lake country. Into society he rarely went, and amusement he had none, with the exception of a game at bowls on Thursday afternoons. In 1810 he was asked by Davy to offer himself as a candidate for the fellowship of the Royal Society, but he declined, possibly from pecuniary considerations. In 1822 he was proposed without his knowledge, was elected, and paid the usual fee. Four years later he received the king's medal of the society for the development of the chemical theory of Definite Proportions usually called the Atomic Theory, and for his labors and discoveries in physical and chemical science."

In the summer of 1822, in company with Mr. Benjamin Dockray and Mr. W. D. Crewdson, Dalton spent a short time at Paris, where he met Ampère, Arago, Berthollet, Biot, Brèquet, Cuvier, Fourier, Gay-Lussac, Laplace, Thénard, Vauquelin, and other distinguished men of science. Six years previously he had been made a corresponding member of the Academy of Sciences, and in 1830 he was elected by that body to fill the place of Davy as one of its eight foreign associates. Dalton was present at the first meeting of the British Association, held at York in 1831. On the occasion of the second meeting, at Oxford in 1832, the honorary degree of D.C.L. was conferred upon him. The scarlet hue of his doctor's gown was to him, he said, "that of nature," the color of "green leaves."

In June, 1833, Lord Grey's Government conferred upon Dalton an annual pension of £150, which in 1836 was raised to £300. In the former year a subscription list was opened in Manchester to obtain funds for providing that city with a lasting memorial of its great chemist; and the sum of £2000 having been raised, Chantrey was intrusted with the execution of a bust, which was eventually placed in the entrance hall of the Manchester Royal Institution. During his stay in London, whither he had gone in 1834 to sit to the sculptor, Dalton was presented at court, and in the autumn he received from the university of Edinburgh the degree of LL.D. He officiated as vice-president of the chemical section of the British Association at Dublin in 1835, and at Bristol in 1836. On the 18th April, 1837, he was seized with an attack of paralysis, a disease of which his brother had died in December, 1834. In the following year, on the 15th February, he had a second attack, after which, though still able to make experiments, he was manifestly much enfeebled, both physically and mentally, and required constant medical attendance. On May 20, 1844, he suffered from another fit. On the 26th of July, 1844, he recorded, with trembling hand, his last meteorological observation, and on the morning of the 27th he fell from his bed, and was found lifeless by his attendant. He was publicly buried on the 12th of August at Ardwick cemetery, about a mile and a half from Manchester.

In person Dalton was robust and muscular, and his countenance was open and expressive of the earnestness, simplicity, and truth of his character. His height was about 5 feet 7 inches; he stooped slightly, and his gait was stiff and awkward, but rapid. In dress he adhered to the mode of the Quakers. His manners were singularly free from pedantry and ostentation, and he had a grave, quiet demeanor. Generally he enjoyed excellent health. His medical attendant, finding him once greatly recovered from an attack of catarrh, attributed the improvement to a dose of James's powder prescribed on the previous day. "I do not well see how that can be," said Dalton, "as I

kept the powder until I could have an opportunity of analyzing it." Dalton was somewhat silent in general company, but with his familiar friends he would often indulge in active conversation. His letters to his acquaintances evince no small power of observation. On religious topics he appears to have been peculiarly reserved, and his friends found it difficult to gain an idea of his doctrinal views. He "never had time" to get married, he said; but his correspondence, and the testimony of those who knew him, show that he delighted in the society of women of education and refinement. His pinched circumstances in early life were perhaps the chief cause why he remained single. He liked tobacco, and remarked of Davy, "The principal failing in his character as a philosopher is that he does not smoke." Dalton was careful, though not parsimonious, in his expenditure, and left at his death a small fortune; when occasion required he could show himself remarkably open-handed. Davy wrote of Dalton in 1829:—"He was a very coarse experimenter, and almost always found the results he required, trusting to his head rather than to his hands. Memory and observation were subordinate qualities in his mind; he followed with ardor analogies and inductions; and however his claims to originality may admit of question, I have no doubt that he was one of the most original philosophers of his time, and one of the most ingenious." Superadded to his natural talents and "his almost intuitive skill in tracing the relations of material phenomena," there was in Dalton, to use the words of Professor Sedgwick, "a beautiful moral simplicity and singleness of heart which made him go on steadily in the way he saw before him, without turning to the right hand or to the left, and taught him to do homage to no authority before that of truth."

Henry, *Life of Dalton*, Cavendish Society, 1854; Robert Angus Smith, *Memoir of John Dalton and History of the Atomic Theory*, 1856. A list of Dalton's papers and other publications is given on pp. 263-63 of the latter work. See also Roscoe, "On Dalton's First Table of Atomic Weights," in *Nature*, Nov. 19, 1874. (P. H. B.)

DAMAGES, the compensation to which a person is by law entitled who has been injured by another. The principle of compensation in law makes its first appearance as a substitute for personal retaliation. In primitive law something of the nature of the Anglo-Saxon *were-gild*, or the *ποινή* of the *Iliad*, appears to be universal.<sup>1</sup> It is a payment due from the offender to the person he has offended, or to his family or kin. The system relates to personal injuries. It marks out with great minuteness the measure of the compensation appropriate to each particular case. And there is sometimes a resemblance between the legal compensation, as it may be called, and the compensation which an injured person seeking his own remedy would be likely to exact for himself. In such a system the two entirely different objects of personal satisfaction and criminal punishment are not clearly separated, and even in modern law damages are still occasionally penal.

The object of legal compensation should be to place the injured person as nearly as possible in the situation in which he would have been but for the injury. In the law of England the two historical systems of common law and equity viewed this problem from two different points of view. The principle of the common law was that the amount of every injury might be estimated by pecuniary valuation. The object of equity was to place the injured party in the actual position to which he was entitled. This difference comes out most clearly in cases of breach of contract. The common law, with a few partial exceptions, would do no more than compel the defaulters to make good the loss of the other party by paying him an ascertained sum of money as damages. Equity, recognizing the fact that complete satisfaction was not in all cases to be obtained by mere money payments, compelled the defaulter to *specifically perform* his contract. Again, in those injuries which do not fall under the head of breach of contract, equity, on satisfactory proof that a wrong was contemplated, would interfere to prevent it by injunction, while at common law no action could be brought until the injury was accomplished, and then only pecuniary damages could be obtained. Common law and equity are now so far fused by the Judicature Act of 1873 that the appro-

<sup>1</sup> The *were* was the price of a man's life—the fine a murderer had to pay to the family or relations of the deceased, as the *wite* was the fine paid to the magistrates.

private remedy can be awarded in any of the divisions of the High Court of Justice.

The assessment of damages is peculiarly the business of the jury, and the court will only interfere with their decision on strong cause being shown. Thus a verdict may be set aside on the ground that damages are excessive, or that they are palpably insufficient. And if it appear that the result was arrived at by mere hazard, as, for instance, by each jurymen naming a sum and an average being struck, that would be an impropriety which would invalidate the verdict. There are, moreover, certain principles according to which the damages must be ascertained.

To take, first, cases of breach of contract. Here, it is said, the motive of the defendant is an irrelevant consideration. He has broken his contract, and all that has to be done is to fix the amount of the loss occasioned thereby. So wherever there has been a breach of contract, some damages, though they should be merely nominal, are recoverable. And when the contract was for a payment of a fixed sum of money, the damages recoverable for a breach thereof would be that sum with interest. Where, in other cases, the parties themselves have fixed the sum which should be due as damages in case of the contract not being fulfilled, such sum will be the proper damages to be awarded by a jury. On this point, however, the cases run rather fine. When a contract provides that a fixed sum shall be payable for breach, the law will ask whether it has been fixed as a penalty or as liquidated (i. e., ascertained) damages. In the former case it will not allow the fixed sum to be awarded, but will require evidence to show what the amount of loss actually was. In *Kemble v. Farren* (6 Bingham, 141), a contract between a manager and an actor provided that for a breach of any of the stipulations therein the sum of £1000 should be payable by the defaulter, not as a penalty, but as liquidated and ascertained damages. Yet even here, the court observing that under the stipulations of the contract the sum of £1000, if it were taken to be liquidated damages, might become payable for mere non-payment of a trifling sum, held that it was not fixed as damages, but as a penalty only. On the other hand, when the damage caused by a breach of contract is of its own nature uncertain, and the parties have positively fixed a sum as liquidating damages, that sum will be the proper damages. Where no such arrangement is made, the general rule for the assessment of damages is that the aggrieved party is to be placed in the same position, so far as money can do it, as if the contract had been performed. Thus, in a contract for the sale of goods when the vendor makes default in delivery, the proper measure of damages is the difference between the contract price and the market price of the goods on the day when they ought to have been delivered; so that if the price has not risen in the interval, the vendor can only get nominal damages. If he has in the meantime resold the goods to a sub-vendor, he cannot claim against his own vendor any damages which the sub-vendor may recover against him for breach of contract, because he ought to have gone into the market and purchased other goods. Again, if a buyer refuses to accept the goods when tendered to him, the measure of damages will be the difference between the contract price and the market price at the time of his refusal, if the latter is lower than the former. But in such cases the trouble and expense of finding a new purchaser or other goods may be taken account of in assessing the damages. It has been held that in a breach of contract to replace stock lent, the measure of damages will be the price of the stock on the day when it ought to have been delivered or on the day of trial, at the plaintiff's option. Where goods inferior in quality to those contracted for are delivered, the difference between the value at the time of delivery of the goods contracted for and the value of those actually delivered will be the proper damages. The controlling principle, in fact, is that compensation should be determined by the amount of the actual loss. In an American case, where a person had agreed with a boarding-house keeper for a year, and quitted the house within the time, it was held that the measure of damages was not the price stipulated to be paid, but only the loss caused by the breach of contract. In contracts to marry, a special class of considerations is recognized, and the jury in assessing damages will take notice of the conduct of the parties. The social position and means of the defendant

may be given in evidence to show what the plaintiff has lost by the breach of contract.

It is not every loss caused by the act or default complained of which can be taken in estimating the proper amount of damages. The remoteness of the consequences is a bar to their being recognized in the assessment, and it is a question of no little difficulty what damages are and what are not excluded for remoteness. The leading English case on this point is *Hadley v. Baxendale* (9 Exch., 341), in which damages were sought for the loss of profits caused by a steam mill being kept idle, on account of the delay of the defendants in sending a new shaft which they had contracted to make. The court held the damage to be too remote, and stated the true rule to be that

"Where two parties have made a contract which one of them has broken, the damages which the other party ought to receive in respect of such breach of contract should be either such as may fairly and substantially be considered as arising naturally, i. e., according to usual course of things, from such breach of contract itself, or such as may reasonably be supposed to have been in contemplation of both parties at the time they made the contract, as the probable result of the breach of it."

So also in cases of trust, the general rule is that the damages must be restricted to the "legal and natural consequences of the wrongful act imputed to the defendant." In an action by the proprietor of a theatre, it was alleged that the defendant had written a libel on one of the plaintiff's singers whereby she was deterred from appearing on the stage, and the plaintiff lost his profits; such loss was held to be too remote to be the ground of an action for damages. The line of remoteness cannot probably be drawn with much greater precision than in the rule in *Hadley v. Baxendale* quoted above, vague and ambiguous as the language may seem to be. A subsequent case shows the limitations of the rule on the other side. In *Smead v. Foord* (1 Ellis and Ellis, 802), the defendant contracted to deliver a thrashing-machine to the plaintiff, a farmer, knowing that it was needed to thrash the wheat in the field. Damages were sought for injury done to the wheat by rain in consequence of the machine not having been delivered in time, and also for a fall in the market before the grain could be got ready. It was held that the first claim was good, as the injury might have been anticipated, but that the second was bad. When, through the negligence of a railway company in delivering bales of cotton, the plaintiffs, having no cotton to work with, were obliged to keep their workmen unemployed, it was held that the wages paid and the profits lost were too remote for damages. On the other hand, the defendant having failed to keep funds on hand to meet the drafts of the plaintiff, so that a draft was returned dishonored, and his business in consequence was for a time suspended and injured, the plaintiff was held entitled to recover damage for such loss. The great difficulty of framing a rule which shall meet all cases is acknowledged by judges and legal writers. One judge declared that no rule could be made in the matter. Another declared that the rule in the majority of cases could have no application, because parties never contemplate the consequences of a breach of contract. The cases probably do not go beyond this, that, when from facts known to everybody, or from special facts proved to be known to the defendant, he ought to have anticipated the consequences of the breach of contract, he will be liable for them.

The rule that the contract furnishes the measure of the damages does not prevail in the case of unconscionable, i. e., unreasonable, absurd, or impossible contracts. The old school-book juggle in geometrical progression has more than once been before the courts as the ground of an action. Thus, when a man agreed to pay for a horse a barley-corn per nail, doubling it every nail, and the amount, calculated as 32 nails, was 500 quarters of barley, the judge directed the jury to disregard the contract, and give as damages the value of the horse. And when a defendant had agreed for £5 to give the plaintiff two grains of rye on Monday, four on the next Monday, and so on, doubling it every Monday, it was contended that the contract was impossible, as all the rye in the world would not suffice for it; but one of the judges said that, though foolish, it would hold in law, and the defendant ought to pay

<sup>1</sup> *Quodlibet alio die hinc, which was translated by some every Monday and by others every other Monday. The amount in the latter case would have been 126 quarters, in the former 524,288,000 quarters*



something for his folly. And when a man had promised £1000 to the plaintiff if he should find his owl, the jury were directed to mitigate the damages.

Interest is recoverable as damages only when an agreement that it should be paid can be proved or inferred (as in the case of bills of exchange), and under the statute 3 and 4 Will. IV. c. 42.

In American law interest is in the discretion of the court, and is made to depend on the equity of the case. In both England and America compound interest, or interest on interest, appears to have been regarded with the horror that formerly attached to usury. Lord Eldon would not recognize as valid an agreement to pay compound interest. And Chancellor Kent, and American lawyers generally, hold that compound interest cannot be taken except upon a special agreement made after the simple interest has become due. See INTEREST.

In actions of tort the discretion of the jury is not so strictly limited as in cases of breach of contract. The cases we have referred to show a general tendency to make the amount of damages a matter of legal certainty, and the jury can do little more than find the facts. If they travel beyond the contract the court will revise their verdict. But in estimating the damages for a civil injury, matter of aggravation may be taken into account. This position was strongly asserted in the cases arising out of the celebrated "General Warrants" in the time of Lord Camden, who is reported in one case to have said, "damages are designed not only as a satisfaction to the injured person, but as a punishment to the guilty, and as a proof of the detestation in which the wrongful act is held by the jury." In another case he mentioned the importance of the question at issue, the attempt to exercise arbitrary power, as a reason why the jury might give exemplary damages. Another judge, in another case, said, "I remember a case when the jury gave £500 damages for knocking a man's hat off; and the court refused a new trial." And he urged that exemplary damages for personal insult would tend to prevent the practice of duelling. The right of the jury to give exemplary or vindictive damages has been repeatedly confirmed in recent cases, and the same doctrine prevails generally throughout the United States. In Scotch law the distinction between compensation and punishment has been more carefully maintained. In *Baillie v. Bryson* (1 Murray's Reports), Lord Chief Commissioner Adams said that Lord Kenyon had "introduced into cases of this sort a principle as to damages extremely dangerous in its consequences. He considered such questions not merely as calculated to repair the injury done to the one party, but as a punishment of the other, and as intended to correct the morals of the country. The morals of the country have not been improved, and I am afraid its feeling has been much impaired. A civil court in matters of civil injury is a bad corrector of morals; it has only to do with the rights of parties."

When both parties are in fault, if the plaintiff's conduct has contributed to the injuries, his claim for damages will not be sustained. This has been carried so far that it has been held that, when a person in one carriage receives injuries from the management of another carriage, he cannot recover damages if any negligence, either on his own part or on the part of the owner or managers of the carriage in which he was, has contributed to the accident. (See NEGLIGENCE.) In the Court of Admiralty, where the question constantly arises in cases of collision, a different rule has been adopted. When both vessels are in fault the whole amount of loss is divided between them. And by a section of the Judicature Act, 1873, the Admiralty rule in such cases is to be adopted in all the courts.

In the old action of *criminal conversation*, exemplary damages might be given, and now the petitioner in a divorce suit may be awarded exemplary damages by the jury against a co-respondent. In this case, however, the disposition of the sum awarded as damages is in the discretion of the judge, who may apply it to the maintenance and education or otherwise to the benefit of children of the marriage.

Damages are said to be either *general* or *special*. The former are given for losses implied by law as the necessary consequences of the wrongful act. The latter are not implied by law, but are compensation for such loss as may be proved to have been in fact caused by the wrongful act. Thus, in an ordinary slander, special damage must be al-

leged and proved to entitle the plaintiff to pecuniary compensation. But if a slander touches a person in the way of his trade, the law will presume that it caused loss to the plaintiff, without calling on him to show what the loss actually was.

When a person was injured by the negligence of another, and died, the benefit of an action for damages did not survive to his representatives. But by the 9 and 10 Vict. c. 93 (commonly called Lord Campbell's Act), it is enacted that wherever the wrongful act is such as would have entitled the injured person to recover damages (if death had not ensued), the person who in such case would have been liable "shall be liable to an action for damages notwithstanding the death of the person injured, and although the death shall have been caused under such circumstances as amount in law to felony." Every such action shall be brought for the benefit of the husband, wife, parent, and child of the deceased. "Child" includes grandchild and step-child, but not illegitimate child.

Loss caused by an act which is not wrongful (*damnum absque injuria*) cannot be the ground of an action for damages—*e. g.*, if A's business is injured by his neighbor B starting the same business, this is not an actionable loss.

Reference may be made to Sedgwick on *The Measure of Damages*, or Mayne on the same subject. (n. n.)

DAMAN, or DAMAUN, in Portuguese DAMAO, a town in India. See DAMAUN.

DAMASCENUS, JOHANNES, an eminent theologian of the early Greek Church, derives his surname from Damascus, where he was born about the close of the 7th or the beginning of the 8th century. His Arabic name was Mansur, and he received the epithet Chrysoorrhoas (gold-pouring) on account of his eloquence. The principal account we have of his life is contained in a narrative of the 10th century, much of which is obviously legendary. His father, Sergius, was a Christian, but notwithstanding held a high office under the Saracen caliph, in which he was succeeded by his son. Damascenus owed his education in philosophy, mathematics, and theology to an Italian monk named Cosmas, whom Sergius had redeemed from a band of captive slaves. About the year 730 he wrote several treatises in defence of image-worship, which the Emperor Leo, the Isaurian, was making strenuous efforts to suppress. Leo in revenge is said to have forged a treasonable letter, purporting to be from Damascenus, and to have sent it to his caliph, who ordered the traitor's right hand to be cut off. According to the narrative, Damascenus immediately proceeded to prostrate himself before an image of the Virgin Mary, implored her intercession, and had the severed hand miraculously restored. The caliph was convinced by the miracle, and offered to replace Damascenus in his office, but the latter resolved to forsake the world, divided his fortune among his friends and the poor, and betook himself to the monastery of St. Sabas, near Jerusalem, where he spent the rest of his life. After the customary probation he was ordained priest by the patriarch of Jerusalem. In his last years he travelled through Syria, contending against the iconoclasts, and in the same cause he visited Constantinople at the imminent risk of his life during the reign of Constantine Copronymus. The date of his death is uncertain; the last notice of him is in 754. Damascenus is a saint both in the Greek and in the Latin Church, his festival being observed in the former on 29th November and 4th December, and in the latter on the 6th May. The works of Damascenus give him a foremost place among the theologians of the early Eastern Church, and, according to Dorner, he "remains in later times the highest authority in the theological literature of the Greeks." Several treatises have been attributed to him that are probably spurious, but his undoubted works are numerous and embrace a wide range. The most important contains three parts under the general title Πηγή γνώσεως (the fountain of knowledge). The first part, entitled *Κεφάλαια φιλοσοφικά*, is an exposition and application to theology of Aristotle's *Dialectic*. The second, entitled *Περί αἰρεσεων* (of heresies), is a reproduction of the earlier work of Epiphanius, with a continuation giving an account of the heresies that arose after the time of that writer. The third part, entitled *Ἐκδοσις ἀκριβής τῆς ὀρθοδόξου πίστεως* (an accurate exposition of the orthodox faith), is much the most important of the three, containing as it does a complete system of theology founded on the teaching of the fathers and church councils.

from the 4th to the 7th century. It thus embodies the finished result of the theological thought of the early Greek Church. Through a Latin translation made by Burgundio of Pisa in the 12th century, it was well known to Peter Lombard and Aquinas, and in this way it influenced the scholastic theology of the West. Damascenus himself has sometimes been called the "Father of Scholasticism," and the "Lombard of the Greeks," but these epithets are appropriate only in a limited sense. On the disputed question of Damascenus's authorship of the interesting Christian romance, *Barlaam and Josephat*, see note to the article *BARLAAM AND JOSAPHAT*, vol. iii. p. 324. The works of Damascenus were edited by Le Quien, and published with a valuable introduction in 2 vols. fol., Paris, 1712.

**DAMASCENUS, NICOLAUS**, a Greek historian and philosopher, born at Damascus, from which he is named. He flourished in the time of Augustus and Herod the Great, with both of whom he was on terms of friendship. He enjoyed the intimate confidence of Herod, who studied philosophy along with him, and employed him on an important political mission to Augustus. Nicolaus survived Herod, and it was through his influence that the succession was secured for Archelaus; but the date of his death, like that of his birth, is unknown. Of his principal work, a universal history in 144 books, composed at the request of Herod, only a few fragments remain. He wrote also an autobiography, of which a good deal has been preserved, a life of Augustus, a life of Herod, and several philosophical works, which are known to us only through a few extracts in other writers. The first edition of the fragments of Nicolaus in a Latin version appeared at Geneva in 1593. The standard edition is that of Orelli (Leipzig, 1804) with a supplement (1811). The volume published in 1804 contains a notice of the life of Nicolaus by the Abbé Sevin.

**DAMASCIUS**, a celebrated Neo-Platonic philosopher, who was born at Damascus about the middle of the 5th century. He studied at Alexandria, and thence removed to Athens, where he taught philosophy till the close of the heathen schools during the reign of Justinian. Of his works, which consisted chiefly of commentaries on Plato and Aristotle, and of a biography of his teacher Isidorus, some fragments exist in the writings of Photius. What has been preserved of his work entitled *Difficulties and Solutions of the First Principles* has been published by J. Kopp (Frankfort, 1828), and is of considerable value for the account it contains of several ancient philosophers. See Kopp's preface to his edition.

**DAMASCUS** (Arabic *Dimeškk eah-Sham*), the capital of Syria, and of a pashalik of the same name, an ancient town, 57 miles from the seaport of Beyrout, in 33° 30' N. lat. and 36° 18' E. long. It occupies a site of singular beauty. On the eastern side of the range of Antilibanus is a plain of vast extent, reaching far out into Arabia, and having an elevation of 2200 feet above the sea. The River Barada, the Abana of the Bible, rises in the centre of the mountain range, descends through a sublime ravine, enters the plain, flows across it eastward for 20 miles, and empties itself into a lake, which in the heat of summer becomes a morass. On the banks of the Abana, about a mile from the mouth of the ravine, stands Damascus. The river intersects the city, in a deep rapid current, averaging 60 feet wide. On its northern bank is a large and comparatively modern suburb; but the whole of the ancient walled city, and the principal buildings, are spread over the plain on the south. The Abana is the life of Damascus, and has made it perennial. By an admirable system of channels and pipes, many of them apparently of high antiquity, its waters are not only conveyed through every quarter, but into almost every house, supplying that first requisite of Eastern life and luxury. The river is also extensively used for irrigation. Canals are led off from it at different elevations above the city, and carried far and wide over the surrounding plain, converting what would otherwise be a parched desert into a paradise. The orchards, gardens, vineyards, and fields of Damascus cover a circuit of at least 60 miles, and they owe their almost unrivalled beauty and luxuriance to the Abana. The area irrigated and rendered fertile by it is upwards of 300 square miles in extent, and the River Awaj, the ancient Pharpar, irrigates nearly 100 more. There was truth, therefore, in the boastful words of Naaman (2 Kings v. 12), "Are not Abana and Pharpar, rivers of Damascus, better than all the waters of Israel?"

The view of Damascus from the crest of Antilibanus is scarcely surpassed in the world. The elevation is about 500 feet above the city, which is nearly two miles distant. The distance lends enchantment to the view; for while the peculiar forms of Eastern architecture do not bear close inspection, they look like an Arabian poet's dream when seen from afar. Tapering minarets and swelling domes, tipped with golden crescents, rise above the white-terraced roofs; while in some places their glittering tops appear among the green foliage of the gardens. In the centre of the city stands the Great Mosque, and near it are the grey battlements of the old castle. Away on the south the eye follows a long suburb, while below the ridge on which we stand is the *Merj*, the *Ager Damascenus* of early travellers—a green meadow extending along the river from the mouth of the ravine to the city. The gardens and orchards, which have been so long and so justly celebrated, encompass the whole city, sweeping the base of the bleak hills, like a sea of verdure, and covering an area more than 30 miles in circuit—not uniformly dense, but with open spots here and there. Beyond this circuit are large clumps of trees, dotting the plain almost to the horizon. The varied tints of the foliage greatly enhance the beauty of this picture.

The population of Damascus is estimated at 150,000. Of these about 19,000 are Christians, 6000 Jews, and the rest Mahometans. Of the Christians 8000 belong to the Greek or Eastern Church, and an equal number to the Catholic; and there are besides small communities of Syrians, Maronites, Armenians, and Protestants. In the plain round Damascus, watered by the Abana and Pharpar, there are 140 villages, with an aggregate population of 50,000, of whom about 1000 are Christians, and 2000 Druzes.

Until the capture of the city by Ibrahim Pasha of Egypt, in 1832, no foreign consul was permitted to enter it, and no Christian or Jew was suffered to ride through the streets. The massacre of 1860 showed that the spirit of the people had not changed, and was only kept in check by Turkish troops. A few of the Mahometans, however, are now more enlightened, and have gained a high position as merchants. The Christians are enterprising and industrious, and a large proportion of the trade of the city is in their hands. Until the massacre they were rapidly advancing in number, wealth, and influence; but that event gave a fatal blow to their prosperity. The Jews are the leading bankers and money-dealers. Both Christians and Jews occupy distinct quarters of the city.

The manufactures of the city consist principally of silks, which are exported to Egypt, Baghdad, and Persia; coarse woollen cloth for the *abbas*, or cloaks, worn by the peasants of Syria; cotton cloths, chiefly for home use; gold and silver ornaments, arms, and household utensils. An extensive trade is carried on with the Bedouins of the Arabian desert. The bazaars are always crowded; and on Friday, the market day, it is difficult to pass through them. On the arrival of the great pilgrim caravan, in going to or returning from Mecca, the city presents a gay and animated appearance. Vast multitudes of Persians, Circassians, Anatolians, and Turks throng the streets, and each pilgrim is a merchant for the time being, buying or selling as the case may be.

The bazaars have long been celebrated, and are among the best in the East. They are narrow covered lanes, with ranges of open stalls on each side. Each department of trade has its own quarter or section, where may be seen Manchester prints, Persian and Turkish carpets, French silks, Sheffield cutlery, amber mouth-pieces for pipes, antique China, Cashmere shawls, Mocha coffee, Dutch sugar, Damascus swords, and tobacco from Lebanon and Baghdad.

The khans of Damascus are spacious, and some of them splendid buildings. They are public marts where the leading merchants meet, and expose their wares for sale. The largest is Khan Asad Pasha, situated in the Bizurfiyeh, or "Seed Bazaar." It was erected about 125 years ago, and bears the name of its founder. The gate is a noble specimen of Moorish architecture. The interior is a quadrangle, with a gallery, and a domed roof supported on massive piers. Round it are ranges of small chambers, like cells, in which the goods are stored. All the khans are upon the same plan.

The private houses are the admiration of every visitor.

No contrast could be greater than that between the exterior and interior; the rough mud walls give poor promise of splendor within. The entrance is usually by a low door, and through a narrow winding passage which leads to the outer court where the master has his reception room. From this another winding passage leads to the harem, which is the principal part of the house. The plan of all is the same—an open court, with a tessellated pavement, and one or two marble fountains; orange and lemon trees, flowering shrubs, and climbing plants give freshness and fragrance. All the apartments open into the court; and on the south side is an open alcove, with a marble floor, and raised dais round three sides, covered with cushions; the front wall is supported by an ornamented Saracenic arch. The decoration of some of the rooms is gorgeous, the walls being covered in part with mosaics and in part with carved work, while the ceilings are rich in arabesque ornaments, elaborately gilt. A few of the modern Jewish houses have been embellished at an enormous cost, but they are wanting in taste.

*Antiquities.*—Although Damascus is one of the oldest cities in the world, its antiquities do not present such a striking appearance as those of many other places of far less note. This is in some measure owing to the fact that the old materials have been largely used in the erection of modern houses. The walls which inclosed the old city are about three miles in circuit, and their foundations are probably of the age of the Seleucids. Some of the Roman gateways are in tolerable preservation. Through the centre of the city, from the east to the west gate, ran the *Via Recta*, "the street called Straight," lined on each side with a double colonnade. It is now mostly built over, but many fragments of columns remain *in situ*.

The castle, which stands at the north-west corner, on the bank of the river, is a quadrangle 280 yards long by 200 wide, surrounded by a moat. The exterior walls are in good preservation, but the interior is a heap of ruins. It is not easy to determine the date of its erection, or to say whether Romans, Byzantines, or Saracens contributed most to it. The foundations are not later, and may be earlier, than the Roman age. A few vaults beneath the exterior battlements are used as magazines, and contain some pieces of old armor, with bows, arrows, and other weapons.

The Great Mosque is the most important building in the city. It stands near the castle, and is now, unfortunately, so closely hemmed in with bazaars and houses that its exterior is concealed from view. It occupies a quadrangle 163 yards long by 108 wide, facing the cardinal points. Along the north side is an open court surrounded by cloisters, resting on pillars of granite, marble, and limestone. The mosque itself extends along the whole southern side, and its interior dimensions are 431 feet by 125 feet. It is divided into three aisles of equal breadth, by two ranges of Corinthian columns 22 feet high, supporting round arches. In the centre is a dome resting on four massive piers. Underneath is said to be a cave in which the head of John the Baptist is preserved in a golden casket. The mosque has three minarets, one of which is 250 feet high, and upon it, according to Moslem tradition, Jesus will descend on the day of judgment.

The style and workmanship of three periods are distinguishable in the building. There are the massive foundations and exterior colonnades of a Greek or Roman temple. There are next the round-topped windows and ornamented doorway of an early Christian church. Over the door is an inscription in Greek to the following effect:—"Thy kingdom, O Christ, is an everlasting kingdom, and thy dominion endureth throughout all generations." Then there are the minarets, dome, and arcades of Saracenic origin.

Round the mosque are traces of a court, 1100 feet long by 800 feet wide, encompassed by colonnades similar to those of the temple of Herod in Jerusalem, and the temple of the sun at Palmyra. It seems highly probable that this was the site of the temple of Rimmon, mentioned in 2 Kings v. 18, and that it became in after times the seat of the worship of Jupiter. In the 4th century it was converted into a church, and dedicated to John the Baptist; and in the beginning of the 8th century it was seized by the Mahometans.

There are many other mosques in the city, some of them large and beautiful. Among them are the *Tebiyeh*, on the bank of the Abana at the western end of the city, founded

by Sultan Selim, in 1516, for the accommodation of poor pilgrims, the graceful dome of which, flanked by two slender minarets, is seen from afar, and the *Senanteyeh*, in the centre of the city, distinguished by a minaret coated with green tiles, for the manufacture of which Damascus was once celebrated. It was built by Senan Pasha in 1581, and has a splendid cloistered court. There are also small and richly decorated chapels, connected with the tombs of Saladin, Bibars, and some other great princes. Among the traditional holy places of Damascus are the sanctuary o. Abraham, at Burzeh, three miles north of the city; the house of Naaman, now a leper hospital; the scene of Paul's conversion, near the east gate; the house of Ananias; and the spot where the apostle was let down from the wall.

The *Haj*, or pilgrim caravan, is one of the great sights of Damascus. It starts for Mecca each year on the 15th of the month Shawal. The *muhmil*, a canopy of green silk containing the new covering sent by the sultan for the *Kaabah*, is carried on the back of a dromedary, and is followed by the pasha, and great dignitaries of the city, escorted by the military. The streets and house-tops along the line of the procession are crowded with people. The caravan returns after an absence of four months. It is rapidly declining in numbers and importance.

The *history* of Damascus reaches far back into the mists of antiquity. Josephus says the city was founded by Uz, the son of Aram; and the name of its territory, as given in the Bible, namely, *Aram Damesek* (2 Sam. viii. 6), is almost identical with its modern Arab name, which means "Damascus of Syria." It was already a noted place in the days of Abraham, whose steward was "Eliezer of Damascus" (Gen. xv. 2). Some centuries later, it became, under the rule of the Hadads, the rival of Israel (1 Kings xv., xx., and xxii.). During that period it was the scene of the romantic story of the leper Naaman (2 Kings v.). A change of dynasty took place in the time of the prophet Elisha, when Hadad was murdered by Hazael (2 Kings viii.); but it was soon afterwards captured by Tiglath-pileser, and its people carried away to Assyria (2 Kings xvi. 9; Isa. xvii. 1-3). Colonies from Assyria were then placed in the city, and it continued for many centuries a dependency of that empire. It was taken by Alexander the Great, and after his death was attached to the kingdom of the Seleucids. In 64 B. C. the Romans under Pompey captured it, and under their rule it remained till 37 A. D., when Aretas, king of Arabia, taking advantage of the death of the Emperor Tiberius, seized and held it during the time of St. Paul's visit (2 Cor. xi. 32; Acts ix.).

Christianity appears to have spread rapidly in and around Damascus, as its metropolitan, with seven of his suffragans, was present at the Council of Nice in 325 A. D. About seventy years later the great temple was converted into a Christian church. In 634 the city fell into the hands of the Mahometans; and a few years later it became for a short period the capital of the Mahometan empire. The caliphs who ruled it adorned the city with many splendid buildings, and changed the cathedral into a mosque. A stormy period of four centuries now passed over Damascus, and then an unsuccessful attempt was made to capture it by the crusaders under Baldwin. The reigns of Noured-din, and his more distinguished successor, Saladin, form bright epochs in the history of the city. Two centuries later came Tamerlane. Arab writers call him "the Wild Beast," and he deserves the name. After the city had surrendered to him, and every male had paid the redemption money which he himself had assessed, he urged his soldiers to an indiscriminate massacre. Never had the city so fearfully experienced the horrors of conquest. Its wealth, its stores of antiquities, and rich fabrics were seized; its palaces were pillaged and left in ashes; its libraries, filled with the literature of the period of the caliphs, and with the writings of the fathers of the Eastern Church, were destroyed. Tradition says that of the large Christian population only a single family escaped.

A century later Damascus fell into the hands of the Turks under Sultan Selim, and has since acknowledged their supremacy. In 1832 it was taken by the Egyptians under Ibrahim Pasha, the celebrated general and son of Mehemet Ali, and this conquest is chiefly remarkable for the effect it produced on the inhabitants. The city was then opened for the first time to the representatives of foreign powers. The British consul entered it mounted, and in full costume, escorted by Egyptian soldiers; and the first effect

qual check was given to Moslem fanaticism. In 1841 the Egyptians were driven out by the English, and Damascus with the rest of Syria reverted to the direct sway of the Sultan.

A Protestant mission was established in Damascus in 1843, and has succeeded, chiefly by its schools and the distribution of books, in greatly advancing the cause of education in and around the city.

The only incident worthy of record since that time is the massacre of 1860. The Moslem population, taking advantage of disturbances among the Druzes in Lebanon, rose against the Christians on the afternoon of Monday, the 9th of July, and on that and the two following days burned the whole Christian quarter, and massacred in cold blood about 3000 adult males. But no estimate of the numbers actually murdered can give any adequate idea of the terrible results of the massacre. Thousands who escaped the sword, died of wounds, or famine, or subsequent privation. The Christian quarter has been mostly rebuilt, but many of the most eminent and enterprising Christian merchants removed to Beyrout and Egypt. Yet notwithstanding the fanaticism of its people, and the misgovernment of the Turks, Damascus is progressing. Schools have been established; the streets have been cleared of rubbish, and widened; sanitary regulations are enforced; and the fine new road recently made by a French company over Lebanon to Beyrout has given a great impetus to trade and manufacture.

(J. L. F.)

DAMASK is a technical term applied to several distinct manufactures or manufacturing operations, from the fact that such products or operations were intimately connected with Damascus when that city was a great manufacturing centre. The principal application of the term is to variegated textile manufactures; and at the present day it generally indicates a twilled linen texture richly figured in the weaving with flowers, fruits, or ornamental scrolls, or with large designs of any description. The texture to which the name, however, was originally applied was of silk, with patterns elaborately woven in colors and sometimes in gold thread.

"China, no doubt," says Dr. Rook (*Catalogue of Textile Fabrics, South Kensington Museum*), "was the first country to ornament its silken webs with a pattern. India, Persia, and Syria, then Byzantine Greece followed, but at long intervals between, in China's footsteps. Stuffs so figured brought with them to the West the name 'diaspron' or diaper, bestowed upon them at Constantinople. But about the twelfth century the city of Damascus, even then long celebrated for its looms, so far outstripped all other places for beauty of design, that her silken textiles were in demand everywhere; and thus, as often happens, traders fastened the name of Damascene or Damask upon every silken fabric richly wrought and curiously designed, no matter whether it came or not from Damascus."

Linen damasks, which are employed principally for table-cloths, napkins, and towels, are manufactured at Dunfermline, Kirkcaldy, and some other places in Fifeshire, Scotland; at Lisburn and Belfast, in Ireland; and in Holland, Belgium, and Russia. The fabric is usually woven in from four to eight leaf twills, that is, with the weft intersecting the warp from every fourth up to every eighth thread; and the pattern is produced by varying the interstices on principles which will be explained under WEAVING. Cotton damasks, in imitation of the linen manufactures, are now much woven and used for toilet covers and for similar purposes. Colors are frequently introduced in cotton damasks, manufactured in Glasgow and Paisley for dress purposes, and sent to the Indian and West Indian market. Silk damasks are manufactured for curtains and for other upholstery uses in all the great silk-weaving centres.

DAMASK STEEL, or DAMASCUS STEEL, has a peculiar watered or streaked appearance, as seen in the blades of fine swords and other weapons of Oriental manufacture. Several methods of producing the damask grain may be pursued successfully, one of which is described under CUTLERY. The art of producing damask steel has been generally practised in Oriental countries from a remote period, the most famous blades having come from Ispahan, Khorasan, and Shiraz in Persia. With great brightness and ductility the metal combines peculiar elasticity, and a capacity for taking and retaining a very fine edge.

DAMASKEENING, or DAMASCENING, is the art of incrusting wire of gold (and sometimes of silver) on the

surface of iron, steel, or bronze. The surface upon which the pattern is to be traced is finely undercut with a sharp instrument, and the gold thread by hammering is forced into and securely held by the minute furrows of the cut surface. This system of ornamentation is peculiarly Oriental, having been much practised by the early goldsmiths of Damascus. It is still eminently characteristic of Persian metal work.

DAMASUS, the name of two Popes.

DAMASUS I. stands thirty-ninth in the roll of bishops of Rome. Every one of the first fifty-six Popes has been canonized; and the subject of this notice is entitled to the style of St. Damasus. It is stated that he was by birth a Spaniard; but the more authentic account is that he was born at Guimaraens, in Portugal, in or about the year 304. Other writers have maintained that, though of Portuguese extraction, he was born in Rome. It seems certain that he went thither at an early age; and, though he was forty-eight years old when deacon's orders were conferred on him, he had at an early age been admitted to the ecclesiastical career as a "reader" and secretary of the church. And he is said in that capacity to have compiled the "Acts" of the martyrs Petrus and Marcellinus. The writer in the *Biographie Universelle* says that he succeeded St. Liberius on the Papal throne, but this is an error. On the death of St. Liberius, St. Felix II. succeeded him, and reigned one year and three months; and on his death Damasus was elected, in 366. When St. Liberius was exiled from Rome, Damasus accompanied him to Milan. He received priest's orders, was made cardinal during the pontificate of Felix II., and in 366 was elected by the Roman clergy to the Papacy in the sixty-second year of his age. He died in 384.

The most important event of his papacy was the publication of the law made by the Emperor Valentinian in 370, to restrain the clergy from influencing their penitents to enrich them. This law of 370 is most important and noteworthy from having been the first of the long series of attempts to effect the same object, which, revived by Frederick II. and by Edward I. of England, have occupied the attention of the legislators of so many generations from the time of Damasus even to the present day. Valentinian ordered that ecclesiastics and monks should not frequent the houses of widows and single women. Confessors were prohibited from receiving any gift or legacy from their penitents, and all donations or bequests made in contravention of this law were declared to be null and void. Catholic writers represent this law as having been suggested to the emperor by the Pope. Anti-Catholic authors say that it was imposed on the Pope by the emperor; and it is impossible to avoid feeling that the latter is by far the more probable statement. In any case the law in question furnishes a highly curious and suggestive picture of the church as it was under St. Damasus. And St. Jerome himself, who had been invited to come to Rome by Damasus, and acted as his secretary, confesses that the clergy had by their conduct merited a law which placed them under restraints such as were not found necessary for mimes, charioteers, and comedians.<sup>1</sup>

Damasus had to go through a severe struggle for his throne with an Anti-pope named Ursinus or Ursimus. Of course the ecclesiastical writers represent the successful one of the antagonists to have been animated by the most sincere and heavenly-minded desires for peace and concord. But the pagan historian Ammianus, as quoted by Gibbon, as well as another authority cited by him, would go to show that the two competitors for the position of vicar of Christ were equally savage and ferocious; and that the 137 dead bodies found in the Liberian Basilica (the church of St. Maria Maggiore), after a struggle between the parties, were due to the ferocity of the orthodox Pope's adherents rather than to those of the Anti-pope.

Gibbon says that Damasus "had the good sense or the good fortune to engage in his service the seal and abilities of the learned Jerome, and the grateful saint has celebrated the merit and purity of a very ambiguous character." The official ecclesiastical writers tell us nothing about the 137 dead bodies in the Liberian Basilica, but much of the sainted Pope's decisions as to the nature of the Trinity, and inquire learnedly whether or no it were he who first ordered

<sup>1</sup> "Pudet dicere, sacerdotes idolorum, mimi, et aurigen hereditates captant. Solis clericis ac monachis hac lege prohibetur. Et non prohibetur a persecutoribus, sed a principibus Christianis. Nec de lege queror, sed doleo cur memoriam hanc legem."

the Hallelujah to be sung in the Roman churches at Easter. It seems more certain that it was to him that the pagan prefect of Rome, Prætextatus, replied, that he would become a Christian to-morrow if they would make him a bishop!

**DAMASUS II.** was a native of Bavaria, of the name of Papon, who became bishop of Brixen in Tyrol, and was elected the 155th Pope on the death of Clement II. in 1047, mainly by the influence of the Emperor Henry III. He reigned but twenty-three days, having died on the 8th of August at Palestrina, whither he had gone to escape the heat of Rome. The shortness of his reign, and the fact that previously to his election he was an obscure stranger, have been the causes that very little is known about him.

**DAMAUN**, a seaport town of Western India, in the Surat district, is a Portuguese settlement, although included within the geographical limits of the presidency of Bombay, in 20° 24' N. lat. and 72° 53' E. long. It is situated on the Damaungangá river, which rises in the Western Gháts, about 40 miles to the eastward. The river has a bar at its mouth, with only 2 feet of water at low spring tides and 18 or 20 feet inside. Outside the bar is a roadstead in which vessels may anchor in 8 fathoms. A rampart with 10 bastions and 2 gateways surrounds the town. The surrounding country is fruitful and pleasant except in the rainy season, when it is extensively inundated. Damann was sacked and burnt by the Portuguese in 1531. It was subsequently rebuilt, and in 1558 was taken from the Indians by the Portuguese, who converted the mosque into a Christian church. From that time it has remained in their hands. The Portuguese territory surrounding the town is about ten miles in length from north to south, and about five in breadth.

**D'AMBOISE, GEORGE** (1460-1510), a French cardinal and minister of state, was born in the year 1460. He belonged to a noble family possessed of considerable influence, and he was only fourteen when his father procured for him the bishopric of Montauban, and Louis XI. appointed him one of his almoners. On arriving at manhood D'Amboise attached himself to the party of the duke of Orleans, in whose cause he suffered imprisonment, and on whose return to the royal favor he was elevated to the archbishopric of Narbonne, which after some time he changed for that of Rouen. On the appointment of the duke of Orleans as governor of Normandy, D'Amboise became his lieutenant-general; and he has the credit of having freed the province from the bandits which infested it, and of having diminished the oppression of the nobles, who consequently (during his absence in Italy) petitioned the king against him. In 1494 the duke of Orleans mounted the throne as Louis XII.; and D'Amboise was suddenly raised to the high position of cardinal and prime minister. His administration was, in many respects, well-intentioned and useful. Having the good fortune to serve a king who was both economic and just, he was able to diminish the imposts, to introduce order among the soldiery, to establish the Great Council for the trial of cases in which one of the parties possessed authority that overawed the ordinary courts, and otherwise to improve the execution of justice. He was also zealous for the reform of the church; and it is greatly to his credit that he did not avail himself of the extremely favorable opportunities he possessed of becoming a pluralist. He regularly spent a large income in charity, and he labored strenuously to stay the progress of the plague and famine which broke out in 1504. His foreign policy was animated by two aims—to increase the French power in Italy, and to seat himself on the Papal throne; and these aims he sought to achieve by diplomacy, not by force. He, however, sympathized with, and took part in, the campaign which was commenced in 1499 for the conquest of Milan. Soon after he was made legate *a latere*; and on the death of Alexander VI. he aspired to the Papacy. He had French troops at the gates of Rome, by means of which he could easily have frightened the conclave, and induced them to elect him; but he was persuaded to trust to his influence; the troops were dismissed, and an Italian was appointed as Pius III.; and again, on the death of Pius within the month, another Italian, Julius II., was chosen. In 1508 France, still under the ministry of D'Amboise, joined the league of Cambray against Venice; and it was on his journey into Italy that he was seized at the city of Lyons with a fatal attack of gout in the stomach. He died there at the age of fifty on the 25th May, 1510.

**DAMIENS, ROBERT FRANÇOIS** (1715-1757), who at-

tained notoriety by his attack on Louis XV. of France in 1757, was born in a village near Arras in 1715, and early enlisted in the army. After his discharge, he became a menial in the College of the Jesuits in Paris, and was dismissed from this as well as from other employments for misconduct. Indeed his conduct was such as to earn for him the name of Robert le Diable. During the disputes of Clement XI. with the Parliament of Paris, the mind of Damiens seems to have been excited by the ecclesiastical disorganization which followed the refusal of the clergy to grant the sacraments to the Jansenists and Convulsionnaires; and he appears to have thought that peace would be restored by the death of the king. He, however, asserted, perhaps with truth, that he only intended to frighten the king without wounding him severely. In January, 1757, as the king was entering his carriage, he rushed forward and stabbed him with a knife, inflicting only a slight wound. He made no attempt to escape, and was at once seized. He was condemned as a regicide, and sentenced to be torn in pieces by horses in the Place de Grève. Before being put to death he was barbarously tortured with red-hot pincers, and molten wax, lead, and boiling oil were poured into his wounds. After his death his house was razed to the ground, his brothers and sisters were ordered to change their names, and his father, wife, and daughter were banished from France.

**DAMIETTA**, or, as it is called by the natives, **DAMIAT**, a town of Lower Egypt, on the great eastern branch of the Nile, about six miles from its mouth (the ancient Ostium Phatniticum), and nearly 100 miles from Cairo, with which it is connected by rail. After the metropolis and Alexandria, Damietta is the largest town in Egypt, and contains a population of about 29,000, consisting for the most part of Egyptians, with a few Greeks and Syrians. The town, as a whole, is ill-built and straggling, and is only redeemed from meanness by the presence of some handsome mosques, bazaars, and public baths. The houses of the better classes are brick edifices situated on the water-edge, and furnished with terraces, on which the inmates enjoy the cool river-breezes of the evening. The general trade of Damietta was at one time considerable, but has in great part been absorbed by Alexandria. It has still, however, a considerable coasting trade with Syria and the Levant, and forms the outlet for the rice and flax grown in the surrounding country. The lake Menzaleh yields large supplies of fish, which are dried and salted, and furnish an important article of export trade. Coffee and dates are the other articles most largely exported. Mehemet Ali established a military school in the town with accommodation for 400 pupils, as also a cotton factory and an extensive rice-mill. Damietta is a corruption of the word *Thamiatia*. The original town was four miles nearer the sea than the modern city, and first rose into importance on the decay of Pelusium. When it passed into the hands of the Saracens it became a place of great wealth and commerce, and was therefore frequently attacked by the crusaders. The most remarkable of these sieges lasted eighteen months, from June, 1218, to November, 1219; another in 1249 was conducted in person by Louis IX. of France, who, however, was soon after taken prisoner and compelled to purchase his freedom by restoring the city to its Saracen owners. To obviate these attacks the Egyptian Sultan Bibars blocked up the Phatnitic mouth of the Nile (about 1260), razed old Damietta to the ground, and transferred the inhabitants to the site of the modern town. From this circumstance large ships cannot now sail up the Nile, and are obliged to discharge their cargoes outside the bar. The French took possession of the town in 1798, and in the following year beat the Turks in the neighborhood; but they were expelled by the English under Sir Sydney Smith.

**DAMIRI** (1341-1406), sometimes spelt **DOMAIRI**, or, with the Arabic article, **AD-DAMIRI**, is really an adjective of relation applied to a person or thing belonging to one of the two contiguous towns of North and South Damirah, near Damietta, in Egypt. Under this name is usually understood a well-known Arabian writer on canon law, who is at the same time the author of a treatise on natural history, which in the East has attained considerable celebrity. His full name and title is Kemal ad-den Abu'l Bagá Muhammed Ben Musa Ben Isa ad-Damiri Ash-Shakafel. He was born in Cairo in the year 742 of the Hegira (1341 A. D.), and died there in the year 808 (1405). Damiri's reputation, so far as the Western nations are con-

cerned, is not based upon his work as a jurist, but wholly upon his natural history, which is entitled *The Life of Animals* (Hayât'ul Haiwân). In this treatise the author gives the names of 931 beasts, birds, fishes, and insects with which he was (probably rarely by personal knowledge) acquainted, arranging these alphabetically, and giving a longer or shorter account of their nature and peculiarities, according as the data, actual or fabulous, in his possession would allow him. As might have been anticipated, he is more especially copious and minute when he comes to treat of animals like the lion and the camel; but in all cases he defines the orthography and vocalization of the name, gives the forms of the plurals and feminines, and supplies the local or vernacular titles by which the animals were known. It is unnecessary to say that Damirî does not treat natural history in the exact and systematic manner of the modern zoologist. Not only would that have been impossible at the time at which he lived, but he himself did not profess to be a scientific observer, and he was induced to prepare his work on natural history in consequence of the gross ignorance of this subject which was exhibited by many of the theologians of the period. His exposition of the natural history of his country is essentially the result of his interest in theological and legal matters, and his wide acquaintance with the learned culture of the Arabic language, and therefore is from a scientific point of view a mere compilation; and at the same time his literary knowledge induced him to interrupt the scientific continuity of his narrative by disquisitions of a totally irrelevant character. Thus, in the middle of his article on the Goose, he inserts a consecutive sketch of the history of the Caliphate, from the death of Ali to the accession of Al-Muktafi—a period of nearly 800 years—at the end of which historical interlude he resumes his article, as if it had not been interrupted. In spite, however, of its deficiencies, the *Life of Animals* has an interest of its own and a permanent value to scholars. All references in the *Sunnâ* to any particular animal are mentioned, anecdotes relating to it are introduced, its uses in supplying articles of the materia medica are pointed out, the means to counteract its noxious qualities are indicated, the lawfulness of using its flesh as food is discussed, the proverbs which allude to it are recounted, and citations from the poets who have noticed it are quoted. The amount of discursive reading shown in the work is very great, as it contains quotations from 560 prose authors, and from the divâns, or collected editions, of 199 poets. Upon the whole, therefore, the literary value of the treatise to scholars is by no means small, as it exhibits the natural history of his age and country surrounded by the associations with which the experience and literature of the Arabs had invested it.

After finishing his work on natural history, Damirî reproduced it in a compendious form, and it has thus come down to us in a large and a smaller recension. Others, moreover (such as Al-Uyûti), formed abridgments of it. Manuscript copies of the work exist in many public libraries, and the larger edition has been printed, in the original language, at Cairo, in 2 vols. folio, in 1278 A. H. (1861 A. D.). The European scholar who made the first and amplest use of this work was S. Bochart, in his *Hierozoicon*, which first appeared in 1663.

The other works of Damirî have not obtained, even in the East, the popularity accorded to his *Life of Animals*. His most prominent work on legal subjects is a commentary in four volumes on the *Minhajj* of An-Nawawî.

*Haji Chalfâ*, ed. Fluegel, vol. iii. p. 122; Nicoll, *Biblioth. Bodlei. MSS. Orient. Cat.*; Fluegel's *Arabische Hds. der K. K. Bibliothek zu Wien*; Wuestenfeld's *Arabische Aerzte und Naturforscher*, etc.

**DAMIRON, JEAN PHILIBERT** (1794-1862), a French writer on philosophy, was born at Belleville in 1794. At nineteen he entered the normal school, where he studied under Burnouf, Villemain, and Cousin. After teaching for several years in provincial towns, he came to Paris, where he lectured on philosophy in various institutions, and finally became professor in the normal school, and titular professor at the Sorbonne. In 1824 he took part with Dubois and Jouffroy in the establishment of the *Globe*; and he was also a member of the committee of the society which took for its motto *Aide-toi, le Ciel t'aidera*. In 1833 he was appointed chevalier of the Legion of Honor, and in 1836 member of the Academy of Moral Sciences. Damiron died at Paris on the 11th January, 1862.

The chief works of Damiron, of which the best are his accounts of French philosophers, are the following:—An edition of the *Nouveaux Mélanges Philosophiques de Jouffroy* (1843), with a notice of the author, in which Damiron softened and omitted several expressions used by Jouffroy, which were opposed to the system of education adopted by 'ne Sorbenna, an article which gave rise to a bitter controversy, and to a book by Pierre Leroux, *De la mutilation des Manuscrits de M. Jouffroy* (1843); *Essai sur l'histoire de la philosophie en France au XIX. siècle* (1828, 3d ed. 1834); *Essai sur l'histoire de la philosophie en France au XVII. siècle* (1846); *Mémoires à servir pour l'histoire de la philosophie en France au XVIII. siècle* (1858-64); *Cours de philosophie*; *De la Providence* (1849, 1850).

**DAMMAR, or DAMMER**, a resin, or rather series of resins of the copal kind, obtained from various trees in India and the islands of the Eastern Archipelago. The resin known as dammar in British commerce is the produce of a huge pine tree, *Dammara orientalis*, which grows in Java, Sumatra, Borneo, and other Eastern islands. It oozes in large quantities from the tree in a soft viscous state, with a highly aromatic odor, which, however, it loses as it hardens by exposure. The resin is much esteemed in Oriental communities for incense burning. Dammar is imported into England by way of Singapore; and as found in British markets it is a hard, transparent, brittle, straw-colored resin, destitute of odor. It is readily soluble in ether, benzole, and chloroform, and with oil of turpentine it forms a fine transparent varnish which dries clear, smooth, and hard. The Kauri gum, or Dammar of New Zealand, is closely allied, both in source and properties, being produced by *Dammara australis*. Much of the New Zealand resin is found fossil in circumstances analogous to the conditions under which the fossil copal of Zanzibar is obtained. Dammar is besides a generic Indian name for various other resins, which, however, are little known in western commerce. Of these the principal are Black Dammar (the Hindustanee Kala-damar), yielded by *Camarium strictum*, and White Dammar, or Piney Varnish (Sufed-damar), the produce of *Valeria indica*. Sal Dammar (Damar) is obtained from *Shorea robusta*; *Hopoa micrasatha* is the source of Rock Dammar (the Malay Dammar-batu); and other species yield resins which are similarly named, and differ little in physical properties.

**DAMOCLES**, one of the courtiers of Dionysius, tyrant of Syracuse. When he spoke in extravagant terms of the happiness of his sovereign, Dionysius is said to have placed him at a sumptuous banquet, with a naked sword suspended over his head by a single hair.

**DAMON**, a Pythagorean, celebrated for his disinterested affection for Pythias, or Phintias, a member of the same sect. Condemned to death by Dionysius I. of Syracuse, Pythias begged to be set at liberty for a short time that he might arrange his affairs. Damon pledged his life for the return of his friend; and Pythias faithfully returned before the appointed day of execution. The tyrant, to express his admiration of their fidelity, released both the friends, and begged to be admitted to their friendship.

**DAMOPHILA**, a poetess of Lesbos, celebrated as being the author of a hymn on the worship of Diana Pergæa. She was a friend and intimate of her better-known countrywoman, Sappho.

**DAMOPHON**, a Grecian sculptor, born in Messenia, some time between 300 and 400 B. C., whose abilities were of so high an order that he was thought worthy of being entrusted with the restoration or repairing of Phidias's famed master-piece, the ivory statue of Jupiter at Elis.

**DAMOXENUS**, a noted pugilist of Syracuse, whose name has come down to us from anti-Christian times, in connection with a remarkably fine specimen of antique sculpture. Damoxenus, we are told, was excluded from the Nemean games for having slain his antagonist in a pugilistic encounter. The combatants, after having fought an entire day without either seeming to gain an advantage, finally agreed each to stand and take from the other a blow without flinching. The opponent of Damoxenus, having the first blow, struck the latter on the head. Then Damoxenus, with his fingers unfairly outstretched, struck his rival on the side, and such was the hardness of his nails and the force of the blow that the unfortunate man was actually disembowelled. It is this encounter which forms the subject of the piece of sculpture alluded to.

**DAMPE, JACOB JACOBSON**, a Danish philosopher of the present century, distinguished not only for his talents, but also for his sufferings for freedom of opinion. He was born at

Copenhagen in 1790; died in 1850. His literary and philosophical reputation rests mainly on his work entitled *On the Harmony of Liberty with the Spirit of Christianity*, published in 1819. The liberal sentiments to which he gave expression in his lectures on philosophy caused him to be imprisoned for a period of twenty years, from 1821 to 1841, when he was set at liberty by Christian VIII. Dampier was the author of numerous other writings, both in prose and verse, and for a time was principal of a school in his native city.

DAMPER, the name given in Australia to a peculiar kind of bread, formed very simply of wheat-flour and water, without leaven, and then baked among the ashes of a fire kindled for it. The simplicity of this kind of bread, and the readiness with which it may be prepared, recommend it strongly to travellers in the bush, who very generally make use of it.

DAMPIER, WILLIAM (c. 1652—c. 1712), an English navigator, was born at East Coker, Somersetshire, about 1652. Having early become an orphan, he was removed from the Latin school, and placed with the master of a ship at Weymouth, in which he made a voyage to Newfoundland. On his return he engaged himself as a common sailor in a voyage to the East Indies. He served in 1673 in the Dutch war under Sir Edward Sprague, and was present at two engagements; but the declining state of his health induced him to come on shore, and remove to the country, where he remained some time. In the year following he became an under-manager of a Jamaica estate, but continued only a short time in this situation. He afterwards engaged in the coasting trade, and thus acquired an accurate knowledge of all the ports and bays of the island. He made two voyages to the Bay of Campeachy, and remained for some time with the logwood-cutters, as a common workman. Of this residence he published an interesting account in the work noted below.

Satisfied with the knowledge which he had obtained of the nature of the trade and country, he returned to Jamaica, and thence proceeded to England, where he arrived in 1678. About the beginning of the year following he went out to Jamaica as a passenger, with the intention of revisiting the Bay of Campeachy; but he was persuaded to join a party of buccaniers, with whom he crossed the Isthmus of Darien, spent the year 1680 on the Peruvian coast, and was occasionally successful in plundering the towns. After serving with another privateering expedition in the Spanish Main, he engaged with a captain named Cook for a privateering voyage against the Spaniards in the South Seas. They sailed in the month of August, 1683, touched at the coast of Guinea, and then proceeded round Cape Horn into the Pacific Ocean. Having fallen in with a ship from London, which had sailed on a similar expedition, they joined company; and, touching at the island of Juan Fernandez, they made the coast of South America, cruising along Chili and Peru. They took some prizes; and with these they proceeded to the Mexican coast, which they fell in with near Cape Blanco. While they lay here Captain Cook died, and the command devolved on Captain Davis. Having separated from the London ship, they were joined by another commanded by Captain Swan. An attempt to plunder the town of Guayaquil was unsuccessful, but at the mouth of the river they took some vessels which had about 1000 slaves on board. They next attacked a Spanish fleet which was laden with the treasure of the Peruvian mines, but were unsuccessful, being ill supported by some French ships which had joined them.

The English ships, afterwards cruising along the coast of Mexico, landed, took the town of Puebla Nova, and burnt two others. Dampier, leaving Davis, went on board Swan's ship, and proceeded with him along the northern parts of Mexico, as far as the southern part of California. During this expedition they frequently landed for the purpose of plunder; but the loss of fifty of the party during one of these incursions so discouraged them that they relinquished all further attempts on these coasts. Swan then proposed to run across the Pacific Ocean, and return by the East Indies; and, in hopes of a successful cruise off the Manillas, the crew were persuaded, with a very slender stock of provisions, to risk this long passage. They started on the 31st March, 1686. On reaching Mindanao the majority mutinied, and Dampier, joining them, sailed with the ship, leaving Swan and some others

on the island. After cruising some time off Manilla, and having careened their vessel at Pulo Condore, in 1687, they were driven to the Chinese coast, made the circuit of Luzon and Mindanao, passed through the group of Spice Islands, and reached the coast of Australia in the beginning of 1688. In March they cruised along the west coast of Sumatra, and touched at the Nicobar Islands, where Dampier, at his own request, and two other Englishmen, a Portuguese, and some Malays, were set on shore. Dampier's object was to establish a trade in ambergris. He and his companions contrived to navigate a canoe from Achin to Sumatra; but the fatigues and distress of the voyage proved fatal to several of them, who were carried off by fever, while Dampier himself had scarcely recovered at the end of a twelvemonth. After making several voyages to different places of the East Indies, he acted for some time as gunner to the English fort of Bencoolen. In 1691, wishing to revisit his native country, he embarked on board a ship bound for England, where he arrived in September.

It appears that afterwards Dampier was engaged in the king's service. He had the command of the "Roebuck," a sloop of 12 guns and 50 men. This vessel was believed to have been fitted out for some voyage of discovery, for she had twenty months' provisions on board. He sailed from Britain in 1699, touched at the coast of Brazil, and then ran across to the coast of Australia, arriving there on 1st August, somewhere about 26° lat. Proceeding northwards along the coast, he explored the country in different places where he landed. To procure provisions he found it necessary to direct his course towards Timor; and thence he sailed to the coast of New Guinea, where he arrived December 3. By sailing along to its easternmost extremity he discovered that it was terminated by an island, which he circumnavigated, and named New Britain.

Here it would appear from his own journal that he was prevented from prosecuting his discoveries by the small number of his men, and their eager desire to return home. In May he was again at Timor, and thence he proceeded homeward by Batavia and the Cape of Good Hope. In February, 1701, he arrived off the island of Ascension, when the vessel sprung a leak and foundered; and it was with much difficulty that the crew reached the island. They remained at Ascension till they were taken away by an East Indiaman, and conveyed to England. This closes the account of Dampier's life and adventures as it is detailed by himself. It appears, however, from the preface to the third volume, that he was preparing in 1703 for another voyage. It is mentioned also in Woodes Rogers's *Voyage Round the World*, that Dampier had the command of a ship in the South Seas about the year 1705, along with Captain Stradling, whose vessel foundered at sea. Dampier accompanied Woodes Rogers in his voyage round the world in the years 1708—11 in the capacity of pilot. During this expedition Guayaquil was taken, and Dampier had the command of the artillery. The place and time of his death are unknown.

The works of Dampier are well known, and have been often reprinted. They consist of—*A Voyage round the World*, 3 vols 8vo (1847); *A Supplement to it, describing the countries of Tonquin, Malacca, etc.*; *Two Voyages to Campeachy*; *A Discourse of Trade-winds, Seasons, Tides, etc., in the Torrid Zone* (1707); and *A Voyage to New Holland* (1709). His observations are curious and important, and are conveyed in a plain manly style. His nautical remarks show a great deal of professional knowledge. His knowledge of natural history, though not scientific, appears to be accurate and worthy of trust as a record of facts.

DAN, a town of ancient Judea, near the head-waters of the Jordan, inhabited at the time of the Israelitish conquest by a peaceful and commercial population whose name for their city was Laish, or Leshem. It appears to have been even at this early period a sacred city, and hence it was naturally chosen long after by Jeroboam as the seat of one of his golden calves. The Jewish name, which it derived from the tribe to whose lot it fell, became proverbial in the expression "from Dan to Beersheba." The town was plundered by Benhadad of Damascus, and appears from that time to have gradually declined. Its site is probably marked by the mound called Tell-el-Kady, "the hill of the judge," or "the hill of Dan."

DANA, the name of an American family of which several members have attained eminence. (Richard Dana

(1699-1772) was a leading barrister of Boston, and a prominent opponent of the Stamp Act. His son, Francis Dana, born in Charlestown in 1743, also began life as a barrister. In 1774 he was chosen to represent Cambridge in the first provincial congress of Massachusetts; and in the following year he visited England, bearing letters to Dr. Franklin from several of the patriot leaders. From 1776 to 1780 he was a member of the Massachusetts council; and in 1777 and 1778 he represented Massachusetts in the National Congress. He was also one of the committee appointed to administer military affairs. In 1779 he was appointed secretary of legation to John Adams, the ambassador to England; and for two years (1781-83) he was envoy to St. Petersburg. He took an active part in politics till 1791, when, being appointed chief-justice of Massachusetts, he devoted himself to his judicial duties. He died at Cambridge, April 25, 1811. Francis Dana was the father of Richard Henry Dana, born in 1787, the author of *The Buccaneer and other Poems*, and a number of essays, many of which first appeared in the *North American Review*, of which Dana was one of the founders. His son, also named Richard Henry Dana, is an authority on maritime law, and the author of the true narrative *Two Years before the Mast*, which is founded on personal experience, and of *The Seaman's Friend*, or *The Seaman's Manual*.<sup>1</sup>

DANAE, in Greek legend, is known only in connection with her son Perseus (*Iliad*, xiv. 319), and in particular from the circumstances of his birth. Her father Acrisius, king of Argos, having been warned by an oracle that his daughter would bear a son who would put him to death and rule in his stead, sought to prevent this by confining Danae in an underground chamber lined with bronze like the underground treasuries still visible at Mycenae. But Zeus descended to her in a shower of gold, and she gave birth to Perseus, upon which Acrisius placed her and her infant in a wooden box and consigned them to the sea. After long floating about they were picked up by Dictys, a fisherman who lived with his brother Polydectes on the small island of Seriphus. There she remained till her son had grown up and returned from his expedition of cutting off Medusa's head, when, finding his mother persecuted by Polydectes, Perseus first turned her tormentor and those with him into stone by exhibiting Medusa's head, and then set out with her for Argos. From this point she has no part in the Greek legend. In Latin legend she goes to Italy and marries Piliumnus or Picumnus. It has been pointed out that Perseus was a solar hero, and his birth in the dark chamber has been compared with the birth of Apollo from Leto, a goddess of the darkness of night. The wooden box in which mother and son floated safely is also compared with the boat of Helios, and the golden rain of Zeus may be the beams of sunlight.

DANAUS, in Greek legend, was the founder of Argos and of the race of Danai, by which name the Argives are designated in Homer. A local feature of Argos was the drought which in summer sealed its numerous small springs, and with this feature Danaus was identified as having made the first well, while his fifty daughters (Danaides), seem to represent the many springs of the district. In the lower world they had to carry water in broken vases. It was in searching for water that his daughter Aymone was pursued by a satyr and rescued by Poseidon, the god of that element, who struck out a spring for her with his trident. But while the legend of Danaus thus seems to have been of native Argive origin, he was, in accordance with the tendency at one time of tracing genealogies to Egypt, described as a son of Belus, king of Egypt, and Anchirrhoe, a daughter of the Nile, having a brother Egyptus. This brother had fifty sons, while Danaus had fifty daughters, and because the latter would not marry their cousins, they were obliged to escape from Egypt with their father Danaus. The sons of Egyptus pursued them to Argos and besieged them there, till it was agreed by Danaus that they should marry his daughters. But to each of his daughters he gave a knife with injunctions to slay her husband on the marriage night. Except Hypermnestra they all obeyed, and it was for this that they had to carry water in the lower world. Afterwards he gave them in marriage to the noblest youths of the district who could prove their claims by the greatest speed in the race course.

DANBURY, a town of the United States, in Fairfield county, Connecticut, situated on the Still river, a tributary

<sup>1</sup> [He (1815-1882) was born in Cambridge, educated at Harvard

of the Housatonic, about 53 miles N.N.E. of New York, with which it is connected by rail. Besides the county buildings, it has two national banks, nine churches, a public library, and a high school capable of accommodating 600 pupils. There is a monument, erected in 1854 to the memory of General Wooster, who was mortally wounded in 1777, when the town was burned by the English under General Tryon, and another, of more recent date, to commemorate the other citizens who perished on the same occasion. The principal industry is the manufacture of hats, which was introduced in 1780, and is carried on by ten separate companies; shirts are also largely produced, and sewing machines are constructed. The town, which was incorporated in 1696, had in 1870 a population of 8753. Its Indian name was Pahquoique.

DANBY, FRANCIS (1793-1861), a painter of poetical landscape, who possesses some significance and importance in the English school, was born in the south of Ireland, November 16, 1793. His father farmed a small property he owned near Wexford, and Francis began life in the country, but the death of his father caused the family to remove to Dublin, while he was still a schoolboy, and there his bias to art very quickly developed itself, and superseded any other education. He began to practise drawing at the Royal Dublin Society's schools; and under a Mr. O'Connor, an erratic youth of his own age with national peculiarities, he began painting landscape. The capital of Ireland has never shown very much interest in the arts, but there was a youth then rising who afterwards made his mark in archæology, if not in his profession of landscape painting, George Petrie, with whom Danby formed an acquaintance; and all three left for London together in 1813. This expedition, undertaken with very inadequate funds, and no aid, quickly came to an end, and they had to get home again by walking all the way. At Bristol they made a pause, and Danby finding he could get trifling sums for water-color drawings, remained there working diligently and sending to the London exhibitions pictures of importance. There his large pictures in oil quickly attracted attention. They were very powerful in effect and imaginative in invention; and, had his *Upas Tree* and the *Delivery of the Israelites from Egypt* been produced before a greater man, John Martin, had shown the way to express multitude, vastness, and fabulous wonders in architecture, Danby would be properly considered one of the great men in modern painting. The *Upas Tree* (1820), his most independent and original picture, is, however, a very noble work, not only in invention but in execution; the poison tree, surrounded by the remains of slaves who have been sent to gather its gum, grows alone in a valley of rocks lit by a ghastly moonlight, which is itself a triumph of art. The *Delivery of the Israelites* (1825) is much more strictly a derivation from Martin. The Royal Academy, however, elected him into their body on the strength of it, thinking by his means to checkmate that master, who did not aspire to Academic honors. He now left Bristol for London, and in 1823 exhibited his *Opening of the Sixth Seal* at the British Institution, receiving from that body an honorary premium of 200 guineas; and this picture, which was admirably painted, was followed by two others from the *Apocalypse* both productions of surprising power, though certainly indebted to the works of a similar species of invention appearing a few years earlier. These were the last of his important and large pictures. He suddenly left London, declaring that he would never live there again, and that the Academy, instead of aiding him, had, somehow or other, used him badly. Some insurmountable domestic difficulty overtook him also, and for eleven or twelve years he lived on the Lake of Geneva, a Bohemian with boat-building fancies, painting only now and then. He returned to England in 1841, when his sons James and Thomas, who have both followed the art with considerable advantage, were growing up. The only additional pictures it is necessary to mention are the *Golden Age* and the *Evening Gun*, the first begun before he left England, the second painted after his return, when he had taken up his abode at Exmouth, where he died February 9, 1861, in his sixty-eighth year. His *Upas Tree* is now in the South Kensington National Collection by the Townshend bequest, and is held in general respect, but such of his other works as have been lately seen have not maintained his reputation. They have the hot tone and opacity of bronze, and reveal

was an eminent jurist and anti-slavery man, edited Whiston's *American National Law*.—AM. ED.]



the secret that they have been produced in a darkened studio, and irrespective of the facts and even of the sentiment of living nature. Notwithstanding these drawbacks, they must be always interesting from their imaginative motives, and undoubtedly play a noticeable part in the history of English landscape art.

**DANCE.** The term dancing in its widest sense includes three things:—(1) the spontaneous activity of the muscles under the influence of some strong emotion, such as social joy or religious exultation; (2) definite combinations of graceful movements performed for the sake of the pleasure which the exercise affords to the dancer or to the spectator; (3) carefully-trained movements which are meant by the dancer vividly to represent the actions and passions of other people. In the highest sense it seems to be for prose-gesture what song is for the instinctive exclamations of feeling. Pantomime in the emphatic form of dancing scarcely exists in this century, but it has had an important history. Regarded as the outlet or expression of strong feeling, dancing does not require much discussion, for the general rule applies that such demonstrations for a time at least sustain and do not exhaust the flow of feeling. The voice and the facial muscles and many of the organs are affected at the same time, and the result is a high state of vitality which among the spinning Dervishes or in the ecstatic worship of Bacchus and Cybele amounted to something like madness. Even here there is traceable an undulatory movement which, as Mr. Spencer says, is "habitually generated by feeling in its bodily discharge." But it is only in the advanced or volitional stage of dancing that we find developed the essential feature of *measures*, which has been said to consist in "the alternation of stronger muscular contractions with weaker ones," an alternation which, except in the case of savages and children, "is compounded with longer rises and falls in the degree of muscular excitement." In analyzing the state of mind which this measured dancing produces, we must first of all allow for the pleasant glow of excitement caused by the excess of blood sent to the brain. But, apart from this, there is an agreeable sense of uniformity in the succession of muscular efforts, and in the spaces described, and also in the period of their recurrence. If the steps of dancing and the intervals of time be not precisely equal, there is still a pleasure depending on the gradually increasing intensity of motion, on the undulation which uniformly rises in order to fall. As Florizel says to Perdita, "When you do dance, I wish you a wave of the sea" (*Winter's Tale*, iv. 3). The mind feels the beauty of emphasis and cadence in muscular motion, just as much as in musical notes. Then, the figure of the dance is frequently a circle or some more graceful curve or series of curves,—a fact which satisfies the dancer as well as the eye of the spectator. But all such effects are intensified by the use of music, which not only brings a perfectly distinct set of pleasurable sensations to dancer and spectator, but by the control of dancing produces an inexpressibly sweet harmony of sound and motion. This harmony is further enriched if there be two dancing together on one plan, or a large company of dancers executing certain evolutions, the success of which depends on the separate harmonies of all the couples. The fundamental condition is that throughout the dance all the dancers keep within their bases of gravity. This is not only required for the dancers' own enjoyment, but, as in the famous Mercury on tiptoe, it is essential to the beautiful effect for the spectator. The idea of much being safely supported by little is what proves attractive in the modern posturing ballet. But this is merely one condition of graceful dancing, and if it be made the chief object, the dancer sinks into the acrobat. These psychological principles have still to be applied to the phenomena presented by the dances of different nations. (See Read's *Characteristic National Dances*, 1853.)

We shall first consider the varieties of dance which without any apparent mimetic object seem to be suggested by the mere pleasure of movement felt by the performer or by the spectator. In Tigrè the Abyssinians dance the *chassés* step in a circle, and keep time by shrugging their shoulders and working their elbows backwards and forwards. At intervals the dancers squat on the ground, still moving the arms and shoulders in the same way. The Bushmen dance in their low-roofed rooms, supporting themselves by sticks; one foot remains motionless, the other dances in a wild irregular manner, while the hands are occupied with

the sticks. The Gonos, a hill-tribe of Hindustan, dance generally in pairs, with a shuffling step, the eyes on the ground, the arms close to the body, and the elbows at an angle with the closed hand. Advancing to a point, the dancer suddenly erects his head, and wheels round to the starting-point. The women of the Pultooah tribe dance in a circle, moving backwards and forwards in a bent posture. The Santal women, again, are slow and graceful in dance; joining hands, they form themselves into the arc of a circle, towards the centre of which they advance and then retire, moving at the same time slightly towards the right, so as to complete the circle in an hour. The Kukis of Assam have only the rudest possible step, an awkward hop with the knees very much bent. The national dance of the Kamchadale is one of the most violent known, every muscle apparently quivering at every moment. But there, and in some other cases where men and women dance together, there is a trace of deliberate obscenity; the dance is, in fact, a rude representation of sexual passion. It has been said that some of the Tasmanian *corrobories* have a phallic design. The Yucatan dance of *nasal* may also be mentioned. The Andamans hop on one foot and swing the arms violently backwards and forwards. The Veddahs jump with both feet together, patting their bodies, or clapping their hands, and make a point of bringing their long hair down in front of the face. In New Caledonia the dance consists of a series of twistings of the body, the feet being lifted alternately, but without change of place. The Fijians jump half round from side to side with their arms akimbo. The only modulation of the Samoan dance is one of time—a *crescendo* movement, which is well known in the modern ball-room. The Javans are perhaps unique in their distinct and graceful gestures of the hand and fingers. At a Mexican feast called Huitzilopochtli, the noblemen and women danced tied together at the hands; and embracing one another, the arms being thrown over the neck. This resembles the dance variously known as the Greek Bracelet or Brawl, *Opus*, or Bearsfeet; but all of them<sup>1</sup> probably are to a certain extent symbolical of the relations between the sexes. Actual contact of the partners, however, is quite intelligible as matter of pure dancing; for, apart altogether from the pleasure of the embrace, the harmony of the double rotation adds very much to the enjoyment. In a very old Peruvian dance of ceremony before the Inca, several hundreds of men formed a chain, each taking hold of the hand of the man beyond his immediate neighbor, and the whole body moving forwards and backwards three steps at a time as they approached the throne. In this, as in the national dance of the Coles of Lower Bengal, there was perhaps a suggestion of "l'union fait le force." In Yucatan stunts were occasionally used for dancing.

It seldom happens that dancing takes place without accompaniment, either by the dancer or by others. This is not merely because the feelings which find relief in dancing express themselves at the same time in other forms; in some cases, indeed, the vocal and instrumental elements largely predominate, and form the ground-work of the whole emotional demonstration. Whether they do so or not will of course depend on the intellectual advancement of the nation or tribe, and upon the particular development of their æsthetic sensibility. A striking instance occurs among the Zulus, whose grand dances are merely the accompaniment to the colloquial war and hunting songs, in which the women put questions which are answered by the men. So also in Tahiti there is a set of national ballads and songs, referring to many events in the past and present lives of the people. The fisherman, the woodman, the canoe-builder, has each his trade song, which on public occasions at least is illustrated by dancing. But the accompaniment is often consciously intended, by an appeal to the ear, to regulate and sustain the excitement of the muscles. And a close relation will be found always to exist between the excellence of a nation's dancing and the excellence or complexity of its music and poetry. In some cases the performer himself sings or marks time by the clanking of ornaments on his person. In others the accompaniment consists sometimes of a rude chant improvised by those standing round, or of music from instruments, or of mere clapping of the hands, or of striking one stick against another or on the ground,

<sup>1</sup> Compare the Chica of South America, the Fandango of Spain, and the Angramens or la Fachée of modern Greece. See also *Revue de la Esce*, v. 776.

or of "marking time," in the technical sense. The Tasmanians beat on a rolled up kangaroo-skin. The Kamchadales make a noise like a continuous hiccup all through the dance. The Andamans use a large hollow dancing-board, on which one man is set apart to stamp. Sometimes it is the privilege of the tribal chief to sing the accompaniment while his people dance. The savages of New Caledonia whistle and strike upon the hip.

The rude imitative dances of early civilization are of extreme interest. In the same way, the dances of the Ostyak tribes (Northern Asiatic) imitate the habitual sports of the chase and the gambols of the wolf and the bear and other wild beasts, the dancing consisting mainly of sudden leaps and violent turns which exhaust the muscular powers of the whole body. The Kamchadales, too, in dancing, imitate bears, dogs, and birds. The *Kru* dances of the Coast Negroes represent hunting scenes; and on the Congo, before the hunters start, they go through a dance imitating the habits of the gorilla and its movements when attacked. The Damara dance is a mimic representation of the movements of oxen and sheep, four men stooping with their heads in contact, and uttering harsh cries. The canter of the baboon is the humorous part of the ceremony. The Bushmen dance in long irregular jumps, which they compare to the leaping of a herd of calves, and the Hottentots not only go on all-fours to counterfeit the baboon, but they have a dance in which the buzzing of a swarm of bees is represented. The Kennowits in Borneo introduce the mias and the deer for the same purpose. The Australians and Tasmanians in their dances called *corrobories* imitate the frog and the kangaroo (both leaping animals). The hunt of the emu is also performed, a number of men passing slowly round the fire and throwing their arrows about so as to imitate the movements of the animal's head while feeding. The Gonds are fond of dancing the bison hunt, one man with skin and horns taking the part of the animal. Closely allied to these are the mimic fights, almost universal among tribes to which war is one of the great interests of life. The Bravery Dance of the Dahomans and the Hoolee of the Bhill tribe in the Vindhya Hills are illustrations. The latter seems to have been reduced to an amusement conducted by professionals who go from village to village,—the battle being engaged in by women with long poles on the one side, and men with short cudgels on the other. There is here an element of comedy, which also appears in the Fiji club-dance. This, although no doubt originally suggested by war, is enlivened by the presence of a clown covered with leaves and wearing a mask. The monotonous song accompanying the club-dance is by way of commentary or explanation. So also, in Guatemala there is a public *baile* or dance, in which all the performers, wearing the skins and heads of beasts, go through a mock battle, which always ends in the victory of those wearing the deer's head. At the end the victors trace in the sand with a pole the figure of some animal; and this exhibition is supposed to have some historical reference. But nearly all savage tribes have a regular war-dance, in which they appear in fighting costume, handle their weapons, and go through the movements of challenge, conflict, pursuit or defeat. The women generally supply the stimulus of music. There is one very picturesque dance of the Natal Kaffirs, which probably refers to the departure of the warriors for the battle. The women appeal plaintively to the men, who slowly withdraw, stamping on the ground and darting their short spears or *assegis* towards the sky. In Madagascar, when the men are absent on war, the women dance for a great part of the day, believing that this inspires their husbands with courage. In this, however, there may be some religious significance. These war-dances are totally distinct from the institution of military drill, which belongs to a later period, when social life has become less impulsive and more reflective.<sup>1</sup> There can be little doubt that some of the characteristic movements of these primitive hunting and war-dances survive in the smooth and ceremonious dances of the present day. But the early mimetic dance was not confined to these two subjects; it embraced the other great events of savage life—the drama of courtship and marriage, the funeral dance, the consecration of labor, the celebration of harvest or vin-

tage;<sup>2</sup> sometimes, too, purely fictitious scenes of dramatic interest, while other dances degenerated into games. For instance, in Yucatan one man danced in a cowering attitude round a circle, while another followed, hurling at him *bokordos* or canes, which were adroitly caught on a small stick. Again, in Tasmania, the dances of the women describe their "clamber for roots, nursing children, and quarrelling with husbands." Another dance, in which a woman by gesture taunts a chieftain with cowardice, gives him an opportunity of coming forward and recounting his courageous deeds in dance. The funeral dance of the Todas (another Indian hill tribe), consists in walking backwards and forwards without variation, to a howling tune of "ha! hoo!" The meaning of this is obscure, but it can scarcely be solely an outburst of grief. In Dahomey the blacksmiths, carpenters, hunters, braves, and bards, with their various tools and instruments, join in a dramatic dance. We may add here a form of dance which is almost precisely equivalent to the spoken incantation. It is used by the professional devil-dancer of the wild Veddahs for the cure of diseases. An offering of eatables is put on a tripod of sticks, and the dancer, decorated with green leaves, goes into a paroxysm of dancing, in the midst of which he receives the required information. This, however, rather belongs to the subject of religious dances.

It is impossible here to enumerate either the names or the forms of the sacred dances which formed so prominent a part of the worship of antiquity. A mystic philosophy found in them a resemblance to the courses of the stars. This Pythagorean idea was expanded by Sir John Davies, in his epic poem *Orchestra*, published in 1596. They were probably adapted to many purposes,—to thanksgiving, praise, supplication, and humiliation. It is only one striking illustration of this wide-spread practice, that there was at Rome a very ancient order of priests especially named *Salii*, who struck their shields and sang *arsamenta* as they danced. The practice reappeared in the early church, special provision being made for dancing in the choir. Scaliger, who astonished Charles V. by his dancing powers, says the bishops were called *Præsulæ*, because they led the dance on feast-days. According to some of the fathers, the angels are always dancing, and the glorious company of apostles is really a *chorus* of dancers. Dancing, however, fell into discredit with the feast of the *Agape*. St. Augustine says, "Melius est fodere quam saltare;" and the practice was generally prohibited for some time. No church or sect has ragged so fiercely against the cardinal sin of dancing as the Albigenses of Languedoc and the Waldenses, who agreed in calling it the devil's procession. After the middle of the 18th century, there were still traces of religious dancing in the cathedrals of Spain, Portugal, and Roussillon, especially in the Mussarabian Mass of Toledo. An account of the numerous secular dances, public and private, of Greece and Rome will be found in the classical histories, and in Mr. Weaver's *Essay towards a History of Dancing*, London, 1712, which, however, must be revised by more recent authorities. The Pyrrhic (derived from the Memphitic) in all its local varieties, the Bacchanalia, and the Hymenæa were among the more important. The name of Lycurgus is also associated with the Trichoria. Among the stage dances of the Athenians, which formed interludes to the regular drama, one of the oldest was the Delian dance of the Labyrinth, ascribed to Theseus, and called *Ἰεραὸν*, from its resemblance to the flight of cranes, and one of the most powerful was the dance of the Eumenides. A farther development of the art took place at Rome, under Augustus, when Pylades and Bathyllus brought serious and comic pantomime to great perfection. The subjects chosen were such as the labor of Hercules, and the surprise of Venus and Mars by Vulcan. The state of public feeling on the subject is well shown in Lucian's amusing dialogue *De Saltatione*. Before this Rome had only very inferior buffoons, who attended dinner-parties, and whose art traditions belonged not to Greece but to Etruria.<sup>3</sup> Apparently, however, the Romans, though fond of ceremony and of the theatre, were by temperament not great dancers in private. Cicero says,

<sup>1</sup> The Greek *κροστία* represented the surprise by robbers of a warrior ploughing a field. The gymnopædic dances imitated the sterner sports of the palaestra.

<sup>2</sup> The Greek *Λοναία* and *Διονυσία* had a distinct reference to the seasons.

<sup>3</sup> The Pantomimus was an outgrowth from the *comædians* or *chorists*, singing of the older comedies and *fabulae Atellanæ*.

"Nemo fere saltat sobrius, nisi forte insanit." But the Italic Dance of the Imperial theatre, supported by music and splendid dresses, supplanted for a time the older dramas. It was the policy of Augustus to cultivate other than political interests for the people, and he passed laws for the protection and privilege of the pantomimists. They were freed from the *jus virgatum*, and they used their freedom against the peace of the city. Tiberius and Domitian oppressed and banished them; Trajan and Aurelius gave them such titles as decurions and priests of Apollo; but the pantomime stage soon yielded to the general corruption of the empire.

The modern ballet seems to have been first produced on a considerable scale in 1480, at Tortona, before Duke Galeazzo of Milan. It soon became a common amusement on great occasions at the European courts. The ordinary length was five acts, each containing several *entrées*, and each *entrée* containing several quadrilles. The accessories of painting, sculpture, and movable scenery were employed, and the representation often took place at night. The allegorical, moral, and ludicrous ballets were introduced to France by Baif in the time of Catherine de' Medici. Balthasar of Beaujeu appears also as a director of court ballets, in which amusement the royal families of France continued for long to take an active part. The complex nature of these exhibitions may be gathered from the title of one played at Turin in 1634—*La verità nemica della apparenza, sollevata dal tempo*. Of the ludicrous, one of the best known was the Venetian ballet of *La verità vana*. Now and then, however, a high political aim may be discovered, as in the "Prosperity of the Arms of France," danced before Richelieu in 1641, or "Religion uniting Great Britain to the rest of the World," danced at London on the marriage of Princess Elizabeth to the Elector Frederick. Outside the theatre, the Portuguese revived an ambulatory ballet which was played on the canonization of Carlo Borromeo, and to which they gave the name of the Tyrrhenic Pomp. During this time also the ceremonial ball (with all its elaborate detail of *courante*, minuet, and saraband) was cultivated. The fathers of the church assembled at Trent gave a ball in which they took a part. Masked balls, too, resembling in some respects the Roman Saturnalia, became common towards the end of the 17th century. In France a ball was sometimes diversified by a masquerade, carried on by a limited number of persons in character-costume. Two of the most famous were named "au Sauvage" and "des Sorciers." In 1715 the regent of France started a system of public balls in the opera-house, which did not succeed. Dancing, also, formed a leading element in the *Opéra Français* introduced by Quinault. His subjects were chiefly marvellous, drawn from the classical mythologies; and the choral dancing was not merely *divertissement*, but was intended to assist and enrich the dramatic action of the whole piece. The ideas of military evolution and of magic incantation reappear. Although Lully wrote the music, and the representation was supported by splendid decoration and mechanical effects, the success of this new "tragedy" was short-lived, and since then the modern ballet has never been more than a lyrical interlude. In this humbler function, however, it was greatly improved by La Motte, whose piece *L'Europe Galante* (1697) is a sparkling and elegant production. The lyrical ballet draws much from Fairyland and Arcadia. The possibility of theatrical dance has been strenuously maintained by M. de Cahusac in his *La Danse, Ancienne et Moderne*, 3 vols., 1754; by M. de Noverre in his *Lettres sur les Arts Imitateurs*; and by Diderot in the *Encyclopédie Méthodique*, 1786. It was illustrated by the performance of *Pygmalion* by Mdlle. Sallé in London (1732).<sup>1</sup>

Among the antiquities of this subject chorography, or orchestography, the art of dancing notation, deserves a place. The idea is as old as 1598; but about 1700 M. Feuillet published a complicated system, which was twice translated into English at the beginning of the 18th century by Mr. Weaver and Mr. Essex. A separate sign was used for each position, bend, rising, step, leap, cabriole, falling, slide, turn, and cadence; and the track of the dance was represented by curved lines. These were sometimes printed along with the music. Such diagrams as still exist are

interesting enough as visible history of extinct dances; but as a practical aid in teaching or composing dances chorography was entirely thrown aside as too cumbersome by Noverre, and by Sir John Gallini, the proprietor of the ancient concert rooms in Hanover Square, who wrote on this subject in 1726. The difficulty of the process may be seen by applying it to so comparatively simple a dance as the Scotch reel, which contains no less than 10 single steps—the *ceum-siubhaile* (forward step), the *ceum-coisiche* (footing step), the *leum-trasd* (cross-spring,—French, *sissonne*), the *siabadh-trasd* (chasing step), the *aiseag-trasd* (cross-passes), the *fogladh* (open step), the *cuartag* (turning step), and others. As may be seen from the technical language of dancing (*assemblée, jetée, chassée, glissade, contre-danse, contre-temps, coupé, entrechat, bourrée, gailarde, fleuret*, etc.) it has undoubtedly been brought to greatest perfection in France. But space does not permit us to explain the steps or to describe the picturesque forms of dance which are still practised in town and country.

One sentence in conclusion upon dancing or musical gymnastics as an important branch of physical education. Long ago Locke pointed out (*Education*, sec. 67, 196) that the effects of dancing are not confined to the body; it gives to children, he says, not mere outward gracefulness of motion, but manly thoughts and a becoming confidence. Only lately, however, has the advantage been recognized of making gymnastics attractive by connecting it with what Homer calls "the sweetest and most perfect of human enjoyments." The practical principle against heavy weights and intense monotonous exertion of particular muscles is thus stated by Mr. Smiles (*Physical Education*, p. 148):—"The greatest benefit is derived from that exercise which calls into action the greatest number of muscles, and in which the action of these is intermitted at the shortest intervals." It required only one further step to see how, if light and changing movements were desirable, music would prove a powerful stimulus to gymnastics. It touches the play-impulse, and substitutes a spontaneous flow of energy for the mechanical effort of the will. The force of imitation or contagion, one of the most valuable forces in education, is also much increased by the state of exhilaration into which dancing puts the system. This idea was embodied by Froebel in his *Kindergarten* plan, and has been developed by Jahn and Schreber in Germany, by Dio Lewis in the United States, and by Ling (the author of the *Swedish Cure Movement*) in Sweden. It is of course not merely on æsthetic grounds (though these are sufficient) that musical gymnastics, as distinguished from the process of manufacturing a shell of muscle, are invaluable. They are, according to the testimony of all competent persons, indispensable to complete development and general health.

For the old division of the *Are Gymnastica* into *palestrica* and *saltatoria*, and of the latter into *cubistica*, *spheristica*, and *orchestica*, see the learned work of Hieronymus Mercurialis, *De arte Gymnastica*, Amsterdam, 1672. Cubistic was the art of throwing somersaults, and is described minutely by Tuccero in his *Trois Dialogues*, Paris, 1599. Spheristic included several complex games at ball and tilting—the Greek *σφαίρα*, and the Roman *trigonalis* and *paganica*. Orchestic, divided by Plutarch into *latio*, *figura*, and *indicatio*, was really imitative dancing, and the "silent poetry" of Simonides. The importance of the *χεροποιία* or hand-movement is indicated by Ovid:—"Si vox est, cante; si mollia brachia, salta." For further information as to modern dancing, see Rameau's *Le Maître à Danser*, 1726, and Querlon's *Le Triomphe des Graces*, 1774. In the earlier part of this article considerable use has been made of the "Æsthetic Products" of Mr. Herbert Spencer's *Sociological Tables*.

DANCE, the name of a family group important in English art, at least in architecture, during the latter half of the last century.

GEORGE DANCE, SENIOR, the father of the two others, was born early in the century, at a time when neither Gothic nor classic architecture was properly studied in England, the former being looked upon simply as a barbarism, and the latter known only through the Italian. On his return from the continent, after a short period of study, he obtained the appointment of architect to the city of London, and immediately had a chance of distinction by building the Mansion-house. This was in 1739, and his plans gave great satisfaction. It was followed by the churches of St. Botolph, Aldgate, and St. Leonard, Shore-ditch, and by other city works of some importance. He continued to practise till his death, January 11, 1768, at

<sup>1</sup> Among the last *demi-caractère* ballets may be mentioned the *Fille au Gardin* of Dauberval; among the anacreontic, the *Dansomanie* of Gardel.

which time the former excise offices, Broad Street, were approaching completion, and his son George was installed in his place, both his sons being already in considerable repute. Of these the eldest was

NATHANIEL DANCE, born in 1734, who left a father's office and was placed under Hayman, the genre-historical painter. Here he showed great quickness, but principally in portraits, and after a few years he left that painter and went abroad. His residence in Italy, which was prolonged for many years, brought him in contact with Angelica Kauffmann, among whose devoted admirers he long remained, at first following her about in all her changes of abode, travelling as she did under the protection of her loving old father. From Italy he sent home historical pictures occasionally, of the quasi-classic sort,—Dido and Æneas in 1763, for example. These he continued to produce all through his career,—Paris and Helen (1771), Orpheus lamenting Eurydice (1774), Death of Mark Antony (1776),—all of which have long ago utterly disappeared. He was settled in London in 1768, as his name appears among the founders of the Royal Academy, and must have been in the country some time, as he exhibits two full-length portraits of George III. and the queen in the first exhibition of that body. These are now existing at Up Park, Sussex; and in the Greenwich Hospital picture gallery is a portrait of Captain Cook by him. Many of his pictures are known in family collections throughout the country, and some of his works, now lost sight of, are known by engravings. At the age of fifty-six, when he had himself made a large fortune, he married a widow possessing a jointure of £15,000 a year, entirely dropt his profession, and became a member of Parliament, representing East Grinstead. He even changed his name, and when made a baronet in 1800 he appeared as Sir N. D. Holland. He now lived at Carnborough House, near Winchester, his only practice in art being occasional landscapes in the manner of the day; and at that place he died suddenly on the 15th October, 1811, leaving a private fortune of £200,000. His brother,

GEORGE DANCE, JUNIOR, by far the ablest of the three, was born in 1740, and remained his father's pupil, succeeding him as city surveyor and architect in 1768. At that time the office, then as now somewhat lucrative, was purchasable, and it was in that way he acquired the appointment. He was then only twenty-eight, and had spent several years abroad, most of the time with his brother in Italy, yet he had already distinguished himself by designs for public works, particularly that for Blackfriars Bridge. He was associated with his brother in the foundation of the Royal Academy, and, living till 1825, he was for a number of years the last survivor of the original members. Knowing every one connected with art in London for a long period, he must have outlived a great many changes in taste, and seen many novelties pass away in all the divisions of art. In his own sphere the revolution from his father's style to the study of Gothic by the elder Pugin and others, following the period of Stuart and Revett, showed a wonderful development, especially in the precise knowledge of ornamental details. In sculpture, the passage from Carlini to Flaxman was even more rapid, and in painting he must have known all the important professors from Hogarth to Wilkie. That he was much interested in all these changes is proved by the series of portraits of his friends, principally artists, he drew from the life, which are now preserved in the library of the Academy. Seventy-two of these, engraved in imitation of chalk, were published in 1808-14, and form a very interesting collection. In his own profession his time was mainly occupied by his duties as city architect, and his principal works are such as came to him in that way. Of these, the prison gate of Newgate, rebuilt in 1770, a building unique in design, is the most conspicuous and able. The front of Guildhall is also his. He died January 14, 1825, and was buried in St. Paul's.

DANCOURT, FLORENT CARTON (1661-1725), French dramatist and actor, was born at Fontainebleau on the 1st November, 1661. He belonged to a family of rank, and his parents entrusted his education to Father De la Rue, a Jesuit, who made earnest but fruitless efforts to induce him to join the order. Preserving his freedom, he studied law, became an advocate, and engaged for a short time in the practice of his profession. His marriage to the daughter of the celebrated comedian La Thorillière led him to adopt

the career of an actor, and in 1685, in spite of the strong opposition of his family, he appeared on the stage of the Théâtre Français. His power of facial expression, vivacity of manner, and fluency of utterance gave him immediate and marked success, both with the public and with his fellow actors. The latter chose him for their spokesman on occasions of state, and in this capacity he frequently appeared before Louis XIV., who treated him with great favor. As a dramatic author Dancourt was exceedingly prolific, and as an almost necessary consequence somewhat unequal. His first play, *Le Notaire obligeant*, produced in 1685, was so well received as to lead its author speedily to repeat the experiment. *La Dévolution des Jouesses* (1686) was still more successful; and *Le Chevalier à la Mode* (1687) is generally regarded as his best work, though his claim to original authorship in this and some other cases has been disputed. These were followed by others in constant succession till 1718, when he terminated his career both as an actor and as an author. Retiring to a château at Courcelles le Roi, in Berry, he employed himself in making a poetical translation of the psalms and in writing a sacred tragedy. He died on the 6th December, 1725, and was buried in a tomb he had caused to be constructed during his lifetime in the chapel of his château. The plays of Dancourt are true in the main to nature. The characters have a vraisemblance that has led to his being styled the Teniers of comedy. He is most successful in his delineation of low life, and especially of the peasantry. The dialogue is sparkling, witty, and natural. Many of the incidents of his plots were derived from actual occurrences in the "fast" and scandalous life of the period, and several of his characters were drawn from well-known personages of the day. Most of the plays incline to the type of farce rather than of pure comedy.

The complete works of Dancourt were published in 1760 (12 vols. 12mo). An edition of his *Œuvres Choies* in 5 vols. appeared in 1810.

DANDELION (*Taraxacum Dens Leonis*), a perennial herb belonging to the sub-order *Cichoraceæ*, of the natural order *Compositæ*. The plant has a wide range, being found in Europe, Central Asia, North America, and the Arctic regions. The leaves are smooth, of a bright shining green, sessile, and tapering downwards. The name dandelion is derived from the French *dent-de-lion*, an appellation given on account of the tooth-like lobes of the leaves. The long tap-root has a simple or many-headed rhizome; it is black externally, and is very difficult of extirpation. The flower-stalks are smooth, brittle, leafless, hollow, and very numerous. The flowers bloom from April till August, and remain open from 5 or 6 in the morning to 8 or 9 at night. The flower-heads are of a golden yellow, and 1½ inches in width; the florets are strap-shaped, and longer than the phyllaries. The achenes are olive or dull yellow in color, and are each surmounted by a long beak; on this rests a pappus of white and delicate hairs, which occasions the ready dispersal of the seed by the wind. The globe formed by the plumed seeds are nearly 2 inches in diameter. The involucre consists of an outer spreading (or reflexed) and an inner and erect row of bracts. In all parts of the plant a milky juice is contained, the principle of which, *taraxacin*, has diuretic properties. On exposure to the air the juice coagulates, deposits caoutchouc, and turns of a violet-brown color. The leaves are bitter, but when blanched are sometimes eaten as a salad; they serve as food for silkworms when mulberry leaves are not to be had. The root is roasted as a substitute for coffee, and its infusion, decoction, and extract are employed medicinally as a tonic and aperient, especially in disorders of the digestive organs and liver. Several varieties of the dandelion are recognized by botanists, in the commonest of which the leaves are broad and runcinate, and the outer bracts of the involucre have a downward flexure. The variety *T. palustre*, which affects boggy situations, and flowers in late summer and autumn, has nearly entire leaves, and the outer bracts of its involucre are erect.

DANDOLO is the name of one of the most illustrious patrician families of Venice. But the first doge of the name, Enrico Dandolo, who ruled the republic from 1192 to 1205, occupies the largest space in history of any of the name. He is the "blind old Dandolo" of Byron, whose passing mention of the well-nigh forgotten hero, in *Childe*

*Harold*, has rendered the old name familiar to a larger number of ears than it ever was, even in the day when the prowess of the octogenarian doge changed the face of Europe. Enrico Dandolo was born of a family already illustrious, which had ruled in Gallipoli, Andros, Riva, and other places in Greece; and his uncle was patriarch of Grado. The story goes that he lost his sight from having been subjected by Manuel, the emperor of Constantinople, to whom he had been sent by Venice as ambassador, to the ancient punishment of "abbasination,"—to adopt a foreign word for a thing which happily is nameless in our language. This torture consisted in compelling the victim to gaze into a polished metal basin, which concentrated the rays of the sun till the excess of light destroyed the eye. Some of the Venetian historians, however, deny this story, and represent his blindness as having resulted from a wound received in fight. When he was elected doge, at the age of seventy-two, Venice was involved in a war with Pisa, which he brought in two naval battles to a successful conclusion. But the events which have made his name a marked one in history occurred yet nearer to the end of his long career. In 1201 the chivalry of Christendom was about to embark in the 4th crusade,—by some historians reckoned the 5th,—and a request was made to Venice to give the crusaders passage, and furnish them with vessels for transport. Dandolo received the messengers who came with those demands favorably. There is reason to think that the Venetian was not moved by any great degree of crusading enthusiasm; but Zara had thrown off the yoke of Venice, and, as Venetian writers add, the old doge had not forgiven the infamous treatment he had received at the hands of the Greeks. There does not, however, seem to be any necessity for supposing that any personal considerations of such a kind were needed to impel him to a policy which was doubtless animated by far larger and wider views. The old doge made a hard bargain with the emissaries of the crusaders for the use of the galleys of the republic; and when, at the moment of departure, it turned out, as he had expected, that they had not money enough to pay the stipulated price, he insisted that, in lieu of it, the expedition should first reduce Zara. Dandolo himself, on this being with some difficulty agreed to, took the cross and assumed the command of the fleet. Zara was besieged, taken, pillaged, and restored to the dominion of the republic. The expedition then proceeded to the greater enterprise of attacking Constantinople, in which, led by Dandolo, it was equally successful. But it was not till the young Emperor Alexis had been murdered in a revolt of the Greeks of Constantinople that Dandolo opened to the crusading expedition a proposal that they should seize on the city and on the Greek empire. The counsel was accepted, with a success due, in a great measure, to the conduct and valor of the blind octogenarian doge. Constantinople was pillaged, and booty to an incredible amount was divided among the Venetians and the French.<sup>1</sup> Dandolo might have been crowned emperor instead of Baldwin of Flanders. Whether he declined in accordance with his own judgment, or whether Venice would not permit a citizen of hers to become an emperor, is uncertain. At all events the old doge showed himself once again as good at a bargain as at a fight. He obtained for Venice a very full share of the plunder, both of dominions and of movable property, as well as of useful privileges exacted, with a shrewd and far-seeing eye, to future advantages. Among the booty secured for Venice were the celebrated four horses, now once more, after their journey to Paris, on the west front of the church of St. Mark. Enrico Dandolo, first doge of the name, died in 1205, one year after the establishment of the Latin empire at Constantinople. (See Gibbon, *Decline and Fall*, ch. 60.)

The eldest son of this Enrico, Fantino, was patriarch of Constantinople; and the second, Rainieri, was procurator di St. Marco. He was killed in Candia in 1213. Giberto, known in Venetian history as successful in naval warfare against the Genoese in 1260, was the son of Rainieri, and his son Giovanni, elected doge in 1280, ruled the republic till 1289, and was the father of that Andrea Dandolo of whom it is related, that having been unsuccessful in a naval fight against the Genoese, and being prisoner on board one

of the enemy's galleys, he knocked his brains out by beating his head against the mast.

The Dandolo family gave two other doges to the republic. Francisco was elected in 1313, and died in 1339, and is known in history as Dandolo "Cane," "Dog Dandolo," not from having humiliated himself before Clement V., when imploring the pontiff to become reconciled to Venice, as Siamondi writes in the *Biographie Universelle*, but from "Cane" having been an old family name. Andrea Dandolo was elected doge in 1342, at the exceptionally youthful age of thirty-six, and ruled the republic till 1354. This Andrea was a student and a man of letters, and an intimate friend of Petrarch, some of whose letters to him are extant. He wrote two chronicles of Venice, one of which was published in the 12th volume of the *Rerum Italicarum Scriptores* of Muratori, while the other is extant in MS. He is said to have died of a broken heart, caused by the successes of Paganino Doria and the Genoese fleet in the Adriatic.

DANDOLO, VINCENZO, COUNT (1758—1819), an Italian scientist, was born at Venice in 1758, of good family, though not of the same house as the doges above noticed, and commenced life as a physician in his native city. He was a prominent opponent of the oligarchical party in the revolution which took place on the approach of Napoleon; and he was one of the envoys sent to seek the protection of the French. When the request was refused, and Venice was placed under Austria, he removed to Milan, where he was made member of the great council. In 1799, on the invasion of the Russians and the overthrow of the Cisalpine republic, Dandolo retired to Paris, where, in the same year, he published his treatise *Les Hommes nouveaux, ou moyen d'opérer une régénération nouvelle*. But he soon after returned to the neighborhood of Milan, to devote himself to scientific agriculture. In 1805 Napoleon made him governor of Dalmatia, with the title of *providéiteur général*, in which position Dandolo distinguished himself by his efforts to remove the wretchedness and idleness of the people, and to improve the country by draining the pestilential marshes and introducing better methods of agriculture. When, in 1809, Dalmatia was re-annexed to the Illyrian provinces, Dandolo returned to Venice, having received as his reward from the French emperor the title of count and several other distinctions. He died in his native city on the 13th December, 1819.

Dandolo published in Italian several treatises on agriculture, vine-cultivation, and the rearing of cattle and sheep; a work on silk-worms, which was translated into French by Fontanelle; a work on the discoveries in chemistry which were made in the last quarter of the 18th century (published 1796); and translations of several of the best French works on chemistry.

DANIEL, according to the book which bears his name, was a Jew carried captive in the reign of Jehoiakim to Babylon, where, by his preternatural wisdom, and as the reward of his fidelity to his religion, he attained the highest rank in the state, and the presidency of the wise men of Babylon.

DANIEL, BOOK OF. The controversy as to the origin and significance of this book has passed through so many phases, and the collateral arguments are so apt to obscure those on which the question really hinges, that a simpler mode of treatment than is customary in theological works seems to be here desirable. Instead of beginning with the second part of Daniel (vii.—xii.), which professes to contain circumstantial predictions, and is consequently difficult to treat without some reference to "burning questions" of theology, we shall first survey the narrative portion (i.—vi.) from an historical point of view, and inquire how far the names, ideas, customs, and historical allusions in it agree with the facts known to us from other sources. Our chief guide will be a critical study of the cuneiform inscriptions.

(1.) As to the names. The writer of Daniel evidently supposes that Belteshazzar is compounded with the name of Bel, or Merodach, the favorite god of Nebuchadnezzar (see iv. 8). It appears, however, that the word has no connection with Bel, and it is most probably a corruption of Balatsu-usur, "his life protect." Ashpenaz, Shadrach, and Meshach are quite out of keeping with Babylonian scenery; they cannot be explained at all. Arioch, on the other hand, may be from the primitive Accadian name Erlaku (Lenormant), though the revival of such a name is rather surprising. Hamelsar (i. 11) may perhaps be a corrupt form of a Babylonian name, as Abed-nego (from

<sup>1</sup> The account of the taking of the city given by Ville Hardouin, who was one of the crusaders, is a very one-sided narrative. A more correct notion of the terrible details may be obtained by comparing the Frenchman's account with that of Nicetas Acominatus, the Greek historian.

Abed-nebo) certainly is. The form Nebuchadnezzar, for Nebuchadrezzar, is not peculiar to Daniel, and can hardly be used in argument. (2.) Traces of Babylonian ideas have been most industriously sought for by Mr. Fuller, but they are too uncertain to be of any appreciable value. Who can believe that that fine appellation, "the Ancient of days" (vii. 22), is derived from the eternally self-begotten Hea (the god of the waters), when there is so obvious a source for the phrase in the second part of Isaiah, or that "like a son of the gods" (iii. 25) means, "like the divine fire-god Bar"? Nor is M. Lenormant much more fortunate in his supposed discovery of a reference to Nebuchadnezzar's equally supposed recognition of one supreme deity. The fact is that the greater gods of Babylonia at this period were two in number, viz., Maruduk (Merodach) and Nabu (Nebo), who are coupled, for instance, by Nebuchadnezzar in the great inscription translated by M. Oppert. (3.) There are in Daniel three undoubted points of agreement with Babylonian custom, viz., the punishment of burning alive (iii. 6), the description of the dress of the courtiers (iii. 21), and the mention of the presence of women at feasts (v. 2). On the other hand, there is (a) a striking inaccuracy in the use of the term "Chaldeans" for "astrologers." This use is directly opposed by the cuneiform inscriptions, and it is useless (in the face of Hebrew etymology) to meet this fact by an imaginary correspondence of the three names for the wise men in the book of Daniel to the three leading classes of magicians, etc., mentioned in the inscriptions. (b) There is also (as M. Lenormant has observed) an error in the use of the Assyrian *saknu* (reproduced in the Aramaic of ii. 48), which really means "a high civil officer," but is used in Daniel in the sense of arch-magician. (4.) The points of disagreement between the book of Daniel and Babylonian history have probably been exaggerated. It is true the former tells us many strange things of Nebuchadnezzar, who is only known in history as a great warrior, a great builder, and a great patron of learning. His lycanthropy is not mentioned in any historical documents as yet discovered; to quote Berosus (ap. Josephus, *contr. Ap. i. 20*) is entirely beside the mark, as Hilgenfeld and Mr. Fuller have convincingly shown. The statements respecting Belshazzar have been in part confirmed. Bilusarra-usur is the name of the eldest son of Nabu-nahid or Nabonadius, and a dated tablet in the British Museum, recently obtained from Babylon, proves that the last king of Babylon was Maruduk-sarra-usur, which may be the same name as Belshazzar, since Maruduk is identical with Bel-Merodach. It must be confessed, however, that Belshazzar was not the son of Nebuchadnezzar, as appears to be stated in Dan. v. 2, 11, 18, 22. This has been met by the assertion that "son" in Dan. v. means "grandson;" but that Belshazzar was even the grandson of Nebuchadnezzar is still unproved, not to mention the strangeness of interpreting "thy father" in v. 11 as — "my father" (on the hypothesis that Belshazzar's mother was daughter of Nebuchadnezzar). The most puzzling discrepancy, however, relates to the name of the Medo-Persian king, who "received" from God's hands the "distributed" Babylonian empire (v. 28, 31). The book of Daniel states (v. 31) that this was Darius the Mede; profane history asserts that it was Cyrus the Persian. Many attempts have been made to reconcile these opposing statements. Some think that Darius the Mede was Astyages, but there is a chronological difficulty; others, Cyaxares II., but we are not certain that such a king existed; while Des Vignoles and M. Lenormant would make him a Median prince, rewarded by Cyrus for his fidelity with the vassal kingship of Babylon. Unfortunately this Median prince is at present even more shadowy than Cyaxares II. "The inscriptions," remarks Mr. G. Smith, "have as yet afforded no information on this point." But this is not the only difficulty about Darius the Mede. In ix. 1 we are told that he was the son of Ahasuerus, who on philological grounds must be identified with Xerxes. This, when taken in conjunction with the facts concerning Belshazzar, suggests that the author or editor fell into three errors, by supposing (1) that the conqueror of Babylon was not Cyrus but Darius I.; (2) that Darius I. came after, instead of before, Xerxes; and (3) that he was son, whereas he was really father, of that monarch. There are two "undesigned coincidences," to be mentioned presently, which appear to confirm this view.

Thus far the evidence preponderates against the theory that the narratives in the book of Daniel—or, to be quite

safe, let us say the narratives in their present form—were written by a resident in Babylon. Two other historical inaccuracies ought not to be slurred over, though they are certainly unfavorable to the authorship of Daniel. One is the chronological statement in i. 1. It may fairly be urged (a) that, if the battle of Carchemish took place in the fourth year of Jehoiakim (Jer. xli. 2), Jerusalem cannot have been captured in the third; and (b) that our one certainly contemporary authority, the prophet Jeremiah, nowhere alludes to a captivity at this period. The other is the statement (vi. 1) that Darius the Mede appointed 120 satraps (so in the Hebrew), whereas Darius Hystaspis only mentions 23 satrapies (*Records of the Past*, vii. 88). A similar apparent confusion between satrapies and inferior governments appears in the Alexandrine translation of 1 Kings x. 15. This translation was made in the Greek period; presumably, therefore, the book of Daniel was written (or edited) in the Greek period. This, it should be added, is one of the "undesigned coincidences" which confirm a view mentioned above respecting "Darius the Mede."

We now go on to a class of arguments, which, even more obtinately than those based upon history, refuse to lend themselves to theological prepossession. From the Hebrew of the book of Daniel no important inference as to its date can safely be drawn. It is true, Aramaisms abound, but this feature is common to all the later books of the Old Testament. Nor, in spite of the assertions of controversial writers on both sides, can any argument be based on the fact (strange as it seems) that the book of Daniel is written in two languages or dialects, i. 1–ii. 4a and viii.–xii. being in Hebrew, and ii. 4b–vii. 28 in Aramaic (miscalled Chaldee). The philological data (which will be found collected in Dr. Pusey's *Daniel the Prophet*, pp. lxxvii. 44–57) have been most variously interpreted. Hitzig inferred that the Aramaic of Daniel was later than that of Ezra; Hengstenberg, Dr. Pusey, and especially the late Professor McGill, that Ezra's was later than Daniel's. But the truth seems to be that the evidence is insufficient to determine the question. The Massorites aimed at making the language of the Old Testament (Aramaic as well as Hebrew) uniform, though they did not carry out their plan thoroughly, and allowed not a few vestiges of older stages of the language to remain. It is impossible therefore to decide *ex cathedra* that the later forms in Daniel or Ezra have not arisen from this levelling procedure of the Jewish critics. A similar controversy has arisen as to the relation of the Aramaic of the Old Testament to that of the Targums. Dr. Pusey and others maintain that they are separated by a wide interval of time; but recent researches have shown that the official Targum, or Aramaic translation, of the Pentateuch, the earlier historical books, and the prophets, was thrown into its present form at Babylon on the basis of a work composed in Palestine. Now the Aramaic of Babylon was different from that of Palestine; still, on the whole, as Nöldeke rightly says, the Aramaic of the official Targum is only a rather later development of the Aramaic of Daniel and Ezra, which is therefore presumably Palestinian. It does not, however, follow that the whole book was written in Palestine. The correct translation of Dan. ii. 4 seems to be—"And the Chaldeans spoke unto the king (Aramaic);" i. e., that which follows from this point to the end of chap. vii. is extracted from an Aramaic document. Now, considering the careless treatment extended to the book of Daniel (see the Septuagint version of it), it is quite possible, as M. Lenormant suggests, that the original Hebrew of Dan. ii. 4b–vii. 28 was lost, and its place supplied by the Aramaic translation. There is an exact parallel (not mentioned by M. Lenormant) in Jer. x. 11, which appears only to exist in an Aramaic version.

The remaining linguistic evidence is supplied by certain Persian and Greek words in the book of Daniel. This will retain its importance, even if we adopt M. Lenormant's theory of a substituted Aramaic translation, for a translator writing in a kindred dialect would be tolerably precise in reproducing technical terms,—at any rate would not succeed in expunging all traces of the original. (1) The book contains (see Mr. Fuller's second excursus) at least nine words which are referred, in most cases with certainty, to a Persian origin. It must be remembered that no Persian words occur in Daniel's supposed contemporary—Ezekiel, nor even in Haggai, Zechariah, and Malachi. There are some, it is true, in Ezra and in Esther, but those

books were written long after the beginning of the Persian rule. (2) The three Greek words in Daniel admitted by Delitzsch are all names of musical instruments—*κίθαρς*, *ψαλτήριον*, *συσφώνια*. The reproduction is (philologically) so exact that they must have been taken from the lips of a Greek, and this, according to M. Lenormant's presentation of the facts, was impossible before the age of the Seleucidae, since the commercial intercourse between Greece and Babylonia was not "considerable nor consecutive enough" to admit of it at an earlier period.

The third class of facts to be reckoned with are the internal difficulties in the admission of the authorship of Daniel. Putting aside those which raise questions of theology, we may mention the two following as specimens:—(a) In ii. 25 Arioch speaks of Daniel as merely "one of the captives of Judah," and as personally unknown to the king. This seems inconsistent with chap. i., and consequently unlikely to have been written by Daniel. (b) No subsequent mention is made of the offices to which Daniel and his three friends, according to ii. 48, were promoted, not even in the narrative in chap. iii. The former of these seems the more important. An exact parallel occurs in 1 Sam. xvii. 55-6, where Saul professes himself entirely unacquainted with David, and this after the latter had been constantly playing the harp before him (chap. xvi. 23). Now, critics of such opposite opinions as Thenius and Nägelbach agree that the solution of the difficulty in 1 Sam. is the reference of the respective passages to different documents. It has been urged, therefore, that the same theory will at once account for the inconsistencies in Daniel, and that the narratives at any rate were most likely written at different times, possibly by different authors, and certainly not by Daniel himself (as Mr. Russell Martineau has cogently shown). These various narratives would naturally be connected by an editor, and to this editor we may be indebted for the second of the "undesigned coincidences" referred to above as confirming the supposition of a mistake as to the date and the acts of Darius the Mede; for the name of Cyrus only occurs in three passages (i. 21; vi. 28; x. 1), and may have been inserted by the editor (who knew that Cyrus, not Darius, conquered Babylon) with the object of bringing the book into somewhat closer accordance with profane history. It is gratifying to state that the fundamental principle of this theory has been conceded by such orthodox writers as Mr. Fuller and M. Lenormant. "In its present form," says the former "the book possesses peculiarities of an internal character which seem to suggest a certain extraneous aid perfectly compatible with the recognition of its unity and authority" (*Speaker's Commentary*, vi. 229). M. Lenormant's view has already been mentioned; we need only add that he puts down all the errors of the narrative chapters in Daniel to the copyists or translators, and that he finds a truthfulness of Babylonian coloring piercing through the injuries of time, which can only be accounted for by ascribing the original work to the prophet Daniel. Colder and more critical students will naturally go further. They will not perhaps deny the unity of authorship. The inconsistencies of the narratives are at most a proof of their separate origin; and the 12th chapter of Enoch (an apocalyptic work like Daniel) supplies a parallel which has been hitherto overlooked to the transition from the third person to the first in Dan. vii. 1, 28. There is, further, a general similarity of style between the Hebrew and the Aramaic portions, and (especially) a marked parallelism of contents between chaps. vii. and ii., which is not favorable to a diversity of authorship. But there is a growing feeling that the narratives in the book before us could not have been the work of a resident in Babylon. There may, it is allowed, be an element of historical tradition in them; but, if so, we have not at present the means of detecting it. The narratives, however, have quite sufficient merit regarded from the point of view of edification. If we only place ourselves in the position of the later Jews, we shall perhaps faintly realize the stirring effect they must have produced. We shall then no longer be surprised at the improbability of many of the details, which has given rise to so much unnecessary ridicule. Admiration will be our only feeling, when we consider the author's comparative success in reproducing a distant past. It is possible, no doubt, that he derived some part of these narratives from Jewish or Babylonian popular stories, for we find a Daniel already celebrated for his wisdom in Ezekiel (xxviii. 3, cf.

xiv. 14, 20), and the Babylonian Abydenus has a legend distantly resembling Dan. iv. But even if we admit this conjecture, the historical setting, the moral purpose, and the skill in presentation are all his own, and reflect dimly as it may be the spirit and the power of the writers of the Pentateuchal history.

We may now proceed to the next stage in the argument, and inquire which is the earliest period to which the narrative of Daniel can apply? The third chapter of the book suggests an answer. There (see ver. 5) we meet with a Greek musical instrument called *symphonia* (probably a kind of bag-pipe; A. V., wrongly "dulcimer"), which, as we learn from Polybius (*Athen.*, x. 52), was a special favorite of Antiochus Epiphanes, king of Syria, the notorious persecutor of the Jews. If, therefore, the period of this king (175-164 B.C.) suits the remainder of the work, the clue to the book of Daniel has been found. One reserve must, however, be made. If any historical evidence should be forthcoming in favor of M. Lenormant's view stated above,—if, in a word, an earlier recension of the book of Daniel should be discovered,—it will become necessary to revise or abandon the foregoing argument.

The difficulty of the second part of Daniel (vii.-xii.) is greatly increased by the necessity of making some assumptions with a view to its interpretation. Those of one class of critics are based upon a tradition, reaching back as far as the Christian era (see Josephus, *Antiq.*, x. 11, 7), that the statements of the book of Daniel are literally true; those of another class upon the theory, resulting from the study of the undisputed prophecies on the one hand and of the apocalyptic literature on the other, that the prominence of minute circumstantial prediction, and the absence of a moral, hortatory element, are the distinguishing marks of an artificial, apocalyptic imitation of prophecy. (See APOCALYPTIC LITERATURE.) The latter class of critics hold that the "analogy of prophecy" is an exegetical argument equal in importance to that of the "analogy of faith" in dogmatics. The only attempt to mediate between the two positions is that of Zöckler, who, while believing that the book as a whole is the work of Daniel, is of opinion that the most circumstantial passage (xi. 5-39) has been in some parts interpolated by a contemporary of Antiochus Epiphanes. He thus unintentionally supplements the theory as to the narrative-chapters held by M. Lenormant. The second part of Daniel is occupied with a series of visions and angelic communications, chiefly descriptive of the stages through which the empire of the world had passed, or was about to pass, between Nebuchadnezzar and the latter days. Of these visions, the last (x.-xii.) is the most important. In the form of prediction, the angel who discourses with Daniel communicates the history of the kingdoms to which Palestine was attached from the time of Cyrus to that of Antiochus Epiphanes. This is followed by a description of the deliverance and glorification of the Israelites in the Messianic period (using the word in a wide sense), which is here represented as immediately supervening on the Syrian persecution. The second vision (chap. viii.) has an equally clear reference to Antiochus Epiphanes (the "little horn"). What the writer can have meant by "2300 evening-mornings" is confessedly most obscure; and the statement that the "shameless king" (Antiochus, ver. 23) should fall by a sudden divine interposition (ver. 25, cf. Job xxxiv. 20) is one of those inconsistencies with profane history which mark the second as well as the first part of Daniel. To the second "beast" of the second vision corresponds, by its description, the fourth beast of the first (chap. vii.); consequently both signify the Greek empire of Alexander and his successors. This is now becoming the prevalent view; it is that of Delitzsch and Dr. Westcott, no less than of Ewald and Bleek, but is opposed by the "traditional" theory still upheld by Dr. Pusey, which makes the fourth empire that of Rome. Of the dream of the image in chap. ii., the interpretation of which depends on that of chap. vii., our limits preclude us from speaking. The 9th chapter is as instructive as it is difficult. At the very outset it suggests a very late origin for the book by the way in which the prophets are looked back upon (ver. 6, 10); and the minute study of the works of the prophets described in ver. 2 seems to many to point to a time when prophetic inspiration had ceased, and the prophetic writings (here called "the books") were already collected. Meditating, like one of the later scribes, over the letter of Scripture, Daniel (or the writer who assumed his name)

came to the conclusion that the seventy years appointed by Jeremiah for "the desolations of Jerusalem" must have meant seventy weeks of years, i. e., 490 years. The point from which and to which these "weeks" are to be reckoned is, however, keenly debated. Hengstenberg, following most of the fathers, takes the *terminus a quo* to be the 20th year of Artaxerxes (445 B. C.), and the *terminus ad quem* the public appearance of Christ. Dr. Pusey prefers for the one the return of Ezra to Jerusalem, in 457 B. C., and for the other the martyrdom of St. Stephen, 33 A. D. Dr. Kuenen reckons the seventy weeks from the date of Jeremiah's prediction of the rebuilding of Jerusalem (604 B. C.) to the murder of the high priest Onias III. (170 B. C.). It is true that this does not produce exactly the required number of years, but we ought not, contends Dr. Kuenen, to assume that the author was a perfect master of chronology. We need not, however, dwell further on this "perplexed subject," as it is more than probable that the Hebrew text is unsound. Our view of the second part of the book must be determined by the distinct, not by the obscure, passages. These show that the real centre of the thoughts of the author is Antiochus Epiphanes, and exonerate those critics from the charge of willfulness, who suppose the book to have been written in the reign of that king. For why, these critics ask, should one of the Jewish exiles at Babylon single out the episode of Antiochus in preference to the far more important crisis of the struggle with Rome? And how is it that the revelation of future events ceases to be in accordance with history precisely when we come to the passage (xi. 40-45) which relates to the closing years of the Syrian king?

It would be unjust, however, to writers of the school of Dr. Kuenen to slur over the fact that they can offer plausible historical proofs, unconnected with exegesis, which appear to favor a late date for the book of Daniel. Just as in reviewing the first part of the book we found philological evidence of a post-Babylonian origin, so in the second part there are (according to this school) references to beliefs confessedly post-Babylonian. The doctrine of angels in Daniel is developed to a degree which, it is said, implies a long continuance of Persian influences. In Zechariah we see this doctrine in a less advanced stage. Even the "accuser" angel in Zechariah is still an appellative ("the Satan"), whereas the book of Daniel not only contains a full system of "first princes" or angels, to whom the government of the world is intrusted, but gives names to two of them (Michael and Gabriel), which, as Dr. Kohut has shown, correspond to those of the two Persian archangels, Vohumanô and Craoshô. The book of Daniel, too, contains the first distinct prediction of a resurrection of the dead (see Cheyne's *Book of Isaiah Chronologically Arranged*, p. 130, par. 5), and the researches of Windischmann, Haug, and Spiegel appear to have shown that this is a genuine Zoroastrian doctrine, traces of it being found in the earliest portions of the Avesta. Now, it is both natural and right to look with suspicion on theories of the importation of foreign ideas among the Old Testament writers, for experience shows that they will rarely stand a critical examination. Still the evidence for a Persian origin (or share in the origin) of the doctrine of the resurrection is so strong as to unite the suffrages of the most opposite writers. Mr. Fuller, it is true, has tried to make Babylonian influences equally plausible in the development of this doctrine. But his authority, M. Lenormant, candidly admits that the Babylonian literature only contains the "first germ" of the doctrine which in Daniel has attained an advanced degree of development (*La Magie chez les Chaldéens*, pp. 155-6).

We have thus endeavored to give the leading facts on which the criticism and interpretation of this most interesting book depend. In the present phase of the controversy, two positions only would appear to be philologically tenable. One is that so confidently maintained by M. Lenormant, the eminent Assyriologue, for the first part, and to some extent by Dr. Zöckler for the second part, which consists in assuming that the original book of Daniel has been interpolated by later hands. The other, that the work is still mainly in the form in which it was written, that its date is in the Maccabean period, and that, as in the case of Deuteronomy (according to most critics) in earlier times, and the apocalyptic writings which preceded and followed the rise of Christianity, the author, in the service of truth, assumed a name which would more than his own command the respect of his countrymen. "Such a writer," thought

the late Professor Weir, "however much we may disapprove his procedure, yet, regarding him in the light of his age, we cannot so unhesitatingly condemn. It was not unnatural that the cessation of the voices of the old prophets should have been followed by what may be described as echoes waked up from time to time, and chiefly at critical periods of the national history, in the breasts of sympathizing and enthusiastic disciples" (*Academy*, vol. i. p. 70). From this point of view, we may perhaps say that the book of Daniel is in part an attempted echo of Jeremiah (see Dan. ix. 2).

Still if we accept this as the more natural alternative, we must not suppose that every detail in the narratives of the first part was planned with reference to the Syrian persecution,—Nebuchadnezzar is not a mere double of Antiochus. There is a parallelism, it is true, between the circumstances of the persecuted Jews and the pious friends at Babylon, but it must not be pressed too far. Nor need we suppose that the book was circulated at once as a whole or among all classes of the Jews. The two parts of the work are separable, and the former part displays perhaps too much antiquarian research to be perfectly suitable for general circulation. The "wise men," who formerly sat "in the gate," had withdrawn since the time of the Captivity to the student's chamber; and in the author of Daniel we behold the prototype of the scholar-martyrs and confessors of the Christian church.

Among the more important modern works on Daniel are Hitzig, *Das Buch Daniel*, 1850; Delitzsch, article "Daniel" in *Herzog's Real-Encyclopädie*, Bd. iii., 1855; Hilgenfeld, *Die jüdische Apokalyphe*, 1857; Zündel, *Kritische Untersuchungen*, etc., 1861; Pusey, *Daniel the Prophet*, 2d ed., 1868; Perowne, review of Pusey, in *Contemporary Review*, vol. i.; R. Martineau, "Daniel," in *Theological Review*, 1865; Zöckler, "Der Prophet Daniel," in *Lange's Bibelwerk*, 1870; Lenormant, *La divination, etc., chez les Chaldéens*, (pp. 169-227), 1875; Fuller, "Commentary on Daniel" in *Speaker's Commentary*, vol. vi., 1876; Kuenen, *The Prophets and Prophecy in Israel*, 1877.

(T. K. C.)

DANIEL, GABRIEL (1649-1728), a French Jesuit historian, was born at Rouen in 1649. He was educated by the Jesuits, entered the order at the age of eighteen, and became superior at Paris. He is best known by his *Histoire de France depuis l'établissement de la Monarchie Française*, which appeared first in 1713, and has since been published in 1758 and in 1755-60, the last edition with notes by P. Griffet. Daniel published an abridgment in 1728; and another abridgment was published by Dorival in 1751. Though full of prejudices, which affect his accuracy, Daniel had the advantage of consulting valuable original sources, and his book has been praised by such authorities as Henri Martin and Thierry. Daniel also wrote a by no means successful reply to Pascal's *Provincial Letters*, entitled *Entretiens de Clément et d'Édouard sur les Lettres Provinciales; a Histoire de la Milice Française depuis l'établissement de la monarchie française jusqu'à la fin de la règne de Louis le Grand* (1721); two treatises on the Cartesian theory as to the intelligence of the lower animals, and other works.

DANIEL, SAMUEL (1562-1619), an English poet and historian, was the son of a music-master, and was born near Taunton, in Somersetshire, in 1562. In 1579 he was admitted a commoner of Magdalen College, Oxford, where he remained for about three years, and then gave himself up to the unrestrained study of poetry and philosophy. He succeeded in being appointed tutor to Anne Clifford, daughter of the earl of Northumberland, and thus commenced a life of not ignoble dependence on several of the great houses of that day. He was first encouraged and, if we may believe him, taught in verse, by the famous countess of Pembroke, whose honor he was never weary of proclaiming. His first known work, a translation of Paulus Jovius, to which some original matter is appended, was printed in 1585. His first known volume of verse is dated 1592; it contains the cycle of sonnets to *Delia* and the romance called *The Complaint of Rosamond*. It has been plausibly conjectured that an earlier edition of the latter at one time existed; if so, it seems to be lost beyond all hope. Several editions of the sonnets appeared in 1592, and they were very frequently reprinted during Daniel's lifetime. We learn by internal evidence that *Delia* lived on the banks of Shakespeare's river, the Avon, and that the sonnets to her were inspired by her memory when the



poet was in Italy. To an edition of *Delia and Rosamond*, in 1594, was added the tragedy of *Cleopatra*, a severe study in the manner of the ancients, in alternately rhyming heroic verse, diversified by stiff choral interludes. *The First Four Books of the Civil Wars*, an historical poem in ottava rima, appeared in 1595. The bibliography of Daniel's works is attended with great difficulty, but as far as is known it was not until 1599 that there was published a volume entitled *Poetical Essays*, which contained, besides the "Civil Wars," "Musophilus," and "A letter from Octavia to Marcus Antonius," poems in Daniel's finest and most mature manner. On the death of Spenser, in the same year, Daniel received the somewhat vague office of poet-laureate, which he seems, however, to have shortly resigned in favor of Ben Jonson. In 1601 he published his *Epistles to Great Personages in verse*. Whether it was on this occasion is not known, but about this time, and at the recommendation of his brother-in-law John Florio, he was taken into favor at court, and published, in 1602,<sup>1</sup> a *Panegyric offered to the King at Burleigh Harrington in Rutlandshire*, written in ottava rima, a second edition of which, in 1603, contained an elegant prose essay called *A Defence of Rime*, as against the classic measures proposed by Webbe and Gosson. In 1603, moreover, Daniel was appointed Master of the Queen's Revels. In this capacity he brought out a series of masques and pastoral tragicomedies,—of which were printed *A Vision of the Twelve Goddesses*, in 1604; *The Queen's Arcadia*, in 1606; and *Hymen's Triumph*, in 1615. Meanwhile had appeared, in 1605, *Certain short poems, with the tragedy of Philotas*, which latter was a study in the same style as *Cleopatra*. In 1604 the *Civil Wars* had been completed in eight books. In 1612 Daniel published a prose *History of England*, from the earliest times down to the end of the reign of Edward III. This work was afterwards continued, and published towards the close of Daniel's life, without a date. He was made a gentleman-extraordinary and groom of the chamber to Queen Anne, sinecure offices which offered no hindrance to an active literary career. He was now acknowledged as one of the first writers of the time. Shakespeare, Selden, and Chapman are named among the few intimates who were permitted to intrude upon the seclusion of a garden-house in Old Street, St. Luke's, where, Fuller tells us, he would "lie hid for some months together, the more retiredly to enjoy the company of the Muses, and then would appear in public to converse with his friends." Late in life Daniel threw up his titular posts at court and retired to a farm-house, which he rented at Beckington, in his native county of Somerset, where he died on the 14th of October, 1619. The poetical writings of Daniel are very numerous, and in spite of the eulogies of all the best critics, they have never yet been collected or reprinted. This is the more singular since, during the last century, when so little Elizabethan literature was read, Daniel retained his poetical prestige. In later times Coleridge, Charles Lamb, and others have expended some of their most genial criticisms on this poet. Of his multifarious works the sonnets are now, perhaps, most read. As second in date to none but Sidney's, they possess a special interest; they mark the first legalization of the great error of our sonneteers, in closing with a couplet, but they have a grace and tenderness all their own. Of a higher order is *The Complaint of Rosamond*, a soliloquy in which the ghost of the murdered woman appears and bewails her fate in stanzas of exquisite pathos. Among the *Epistles to Distinguished Persons* will be found some of Daniel's noblest stanzas and most polished verse. The epistle to the countess of Bedford is remarkable among these as being composed in genuine *terza rima*, till then not used in English. Daniel was particularly fond of a four-lined stanza of solemn alternately rhyming iambs, a form of verse distinctly misplaced in his dramas. These, inspired it would seem by like attempts of the countess of Pembroke's, are hard and frigid; his pastorals are far more pleasing; and *Hymen's Triumph* is perhaps the best of all his dramatic writings. In elegiac verse he always excelled, but most of all in his touching address *To the Angel Spirit of the Most Excellent Sir Philip Sydney*. We must not neglect to quote *Musophilus* among the most characteristic writings of Daniel. It is a general defence of learning, and in particular of poetic learning, addressed to Fulk Greville, and written, with much sententious melody, in a sort of *terza rima* or, more properly, *ottava rima* with the couplet omitted. Daniel was a great

reformer in verse, and the introducer of several valuable novelties. It may be broadly said of his style that it is full, easy, and stately, without being very animated or splendid. It attains a high average of general excellence, and is content with level flights. As a gnomic writer Daniel approaches Chapman, but is far more musical and coherent. He is wanting in fire and passion, but he is pre-eminent in scholarly grace and tender, mournful reverie. (E. W. G.)

DANIELL, JOHN FREDERICK (1790-1845), an eminent chemist and physicist, was born in London on the 12th March, 1790. From his father, a barrister, he received an excellent classical education; but having from his early years displayed a preference for natural science, he entered a sugar refinery, where he soon effected important improvements in the process. He studied chemistry under Professor Brande, in conjunction with whom he started in 1816 the journal which, shortly after its commencement, became favorably known to scientific men as the *Quarterly Journal of Science and Art*. To this he contributed numerous articles on chemistry and meteorology, including, under the latter head, an interesting account of the ingenious and delicate dew-point hygrometer which is known by his name. In 1823 he collected and published his *Meteorological Essays*, which excited much interest as one of the first attempts to explain the phenomena of the weather on the broad and sure basis of physical science. In 1824 he published an *Essay on Artificial Climate considered in its Applications to Horticulture*, which was the means of effecting a radical change in the treatment of tropical plants in colder regions, by showing the necessity of a humid atmosphere in hot-houses. As managing director of the Continental Gas Company he interested himself in the manufacture of gas for illuminating purposes, and invented a method of extracting it from resin, which was in practical use for a time. He was one of the founders of the Society for Promoting Useful Knowledge, for which he wrote a treatise on chemistry. In 1831 he was appointed first professor of chemistry in the newly founded King's College, London. During the succeeding years he was engaged in a series of investigations on heat and electricity, which were of great value in their practical applications. For his register pyrometer, devised to measure high temperatures, he was awarded in 1832 the Rumford medal of the Royal Society. Soon afterwards he received the Copley medal for his invention of the sulphate of copper or constant battery, which, as a substitute for Wollaston's, effected an immense improvement in the apparatus of voltaic electricity. The Royal medal, the only other honor of the kind in the gift of the society, was bestowed upon him in 1842. In 1839 appeared his *Introduction to the Study of Chemical Philosophy*, which dealt very ably with the theory of molecular forces. Four years later the honorary degree of D. C. L. was conferred upon him by the University of Oxford. He had received in 1839 another honor of a different kind in being chosen foreign secretary of the Royal Society. He died suddenly of apoplexy while attending a meeting of the council of the society on the 13th March, 1845.

DANIELL, THOMAS, WILLIAM, and SAMUEL. This family of landscape painters forms a group which has left one record, so to speak, in our annals of art, not by their pictures exactly, but by the three having been all travellers in the East, and publishing, by means of engraving, works illustrating the scenery of the countries they visited.

THOMAS DANIELL (1749-1840), to whom the others were indebted for everything, was a man of versatile ability and enormous energy. He was the maker of his own fortune, having been born at the Chertsey Inn, kept by his father, in 1749, and apprenticed to an heraldic painter, a trade then dying out, like that of stay-maker or perukier at a later time. However profitable it had been, probably Daniell would not have adhered to it, as he was animated, at a time when the representation of natural scenery under atmospheric conditions of effect was merely struggling into existence, with a love of the romantic and beautiful in architecture and nature. The sentimental affectation for landscape, so cleverly satirized by Lord Macaulay, did not indeed influence him; his bias was towards archaeology and botany, and led him at last to India. Up to 1784 he painted topographical subjects and flower pieces. By this time his two nephews had come under his influence, the youngest being apprenticed to Medland the landscape engraver, and the elder, William, was under his own care. In this year (1784) he embarked for India accompanied by set foot in England, he was at Cecil's place in Rutlandshire May 1,

<sup>1</sup>[On his way to London to be crowned, the first time James I. 1603, which is the probable date of the *Panegyric*.—AM. ED.]

the boy, and found at Calcutta ample encouragement. Here he remained ten years, and on returning to London he published his largest work, *Oriental Scenery*, in six large volumes, not completed till 1808. From 1795 till 1828 he continued to exhibit Eastern subjects, temples, jungle-hunts, etc., and at the same time continued the publication of illustrated works. These are—*Views of Calcutta; Oriental Scenery*, 144 plates; *Views in Egypt; Excavations at Ellora; Picturesque Voyage to China*. These were for the most part executed by an engraving process now almost forgotten, called aquatint, and, although they do not show the accuracy of detail now understood, are valuable authorities. He was made Royal Academician in 1799, fellow of the Royal Society about the same time, and at different times member of several minor societies. His nephews both died before him; his Indian period had made him independent, and he lived a bachelor life in much respect at Kensington till the age of ninety-one, dying 19th March, 1840.

**WILLIAM DANIELL** (1769–1837), nephew of Thomas, was born 1769, and was therefore fourteen when he accompanied his uncle to India. His own publications, engraved in aquatint, were—*Voyage to India; Zoography; Animated Nature; Views of London; Views of Bootan*, a work prepared from his uncle's sketches; and a *Voyage Round Great Britain*, which occupied him several years. The British Institution made him an honorary award of £100 for a *Battle of Trafalgar*, and he was elected R. A. in 1822. He turned to panorama painting before his death, beginning in 1832 with *Madras*, the picture being enlivened by the Hindu mode of taming wild elephants. He died 16th August, 1837.

**SAMUEL DANIELL**, William's younger brother, born 1775, was brought up as an engraver, and first appears as an exhibitor in 1792. A few years later he went to the Cape and travelled into the interior of Africa, with his sketching materials in his haversack. The drawings he made there were published, after his return, in his *African Scenery*. He did not rest long at home, but left for Ceylon in 1806, where he spent the remaining years of his life, publishing *The Scenery, Animals, and Natives of Ceylon*. Camping out and malaria from the swamps cut him off after a few days' illness in December, 1811.

**DANNECKER, JOHANN HEINRICH VON** (1758–1841), one of the best German sculptors. He was born at Stuttgart, where his father was employed in the stables of the duke of Würtemberg, 15th October, 1758. The boy was entered in the military school at the age of thirteen, and continued there two years, when, his bias and his talent having manifested themselves, he was allowed to take his own way, although there had been some idea of making him a dancer. Once freed from his juvenile difficulties his success was pretty secure, and we find him at once associating with the young sculptors Scheffauer and Le Jeune, the painters Guibal and Harper, and also with Schiller, and the much-admired musician Zumsteeg. His busts of some of these are good; that of Schiller is well known. In his eighteenth year he carried off the prize at the Concours with his model of Milo of Crotona, the strong man who died by having his hand caught in the rent stump of a tree, a favorite subject with young sculptors. On this the duke made him sculptor to the palace (1780), and for some time he was employed on child-angels and caryatides for the decoration of the reception rooms. This work did not please him very much, and in 1783, in his twenty-fourth year, he left for Paris with Scheffauer, and placed himself under Pajou for a time. His Mars, a sitting figure sent home to Stuttgart, marks this period; and we next find him, still travelling with his friend, at Rome in 1785, where he settled down to work hard for five years, during which his position in the future art history of his native land was securely made. Goethe and Herder were then in Rome and became his friends, as well as Canova, who was the hero of the day, and who had undoubtedly a great authoritative influence on his style. His marble statues of Ceres and Bacchus were done at this time. These are now to be seen in the Residenz-schloss, at Stuttgart. While in Rome his study of the antique was very careful and intelligent, although Canova was so much admired by him, and on his return to Stuttgart, which he never afterwards quitted except for short trips to Paris, Vienna, and Zurich, the double influence of these opposite forces is apparent in his works. We may mention some of these. The first was

a Girl Lamenting her Dead Bird, which pretty light motive was much admired. Afterwards, Sappho, in marble for the Lustschloss, and two Offering-bearers for the Jagdschloss; Hector, now in the museum, not in marble; the Complaint of Ceres, from Schiller's poem; a statue of Christ, worthy of mention for its nobility, which has been skilfully engraved by Amaler; Psyche; Kneeling Water Nymph; Love, a favorite he had to repeat. These stock subjects with sculptors had freshness of treatment: and the Ariadne, done a little later, especially had a charm of novelty which has made it a European favorite in a reduced size. It is perhaps the contrast between the delicacy of the female human form and the subdued rude force of the panther she rides that attracts our admiration; but it is probable that this group, like Canova's Graces, will always retain its popularity. It was repeated for the banker Von Bethman in Frankfurt, where it now appears the ornament of the Platz. Many of the illustrious men of the time were modelled by him. The original marble of Schiller is now at Weimar; after the poet's death it was again modelled in colossal size. Lavater, Metternich, Countess Stephanie of Baden, General Benkendorf, and others are much prized. Dannecker was director of the Gallery of Stuttgart, and received many academic and other distinctions. So far his life had been prosperous, but as the evening drew on his mind became troubled and at last obscured. His health had suffered while working very closely on a large monumental statue, and long before his final year he was altogether prostrated. During this sad period he rallied, but his memory and power of observation faded again, and his death was long expected. This took place at last in 1841, in his eighty-third year.

**DANTE**, Dante (or Durante) Alighieri (1265–1321) was born at Florence about the middle of Family and birth. May, 1265. He was descended from an ancient family, but not one of the highest rank. His biographers have attempted on very slight grounds to deduce his origin from the Frangipani, one of the oldest senatorial families of Rome. We can affirm with greater certainty that he was connected with the Elisei who took part in the building of Florence under Charles the Great. Dante himself does not, with the exception of a few obscure and scattered allusions, carry his ancestry beyond the warrior Cacciaguida, whom he met in the sphere of Mars (*Par.* xv. 87, foll.). Cacciaguida there tells his descendant that he was born in the year 1106, that he married an Aldighieri from the valley of the Po, that he had two brothers, Morote and Eliseo, and that he accompanied the Emperor Conrad III. upon his crusade into the Holy Land, where he died among the infidels. From Eliseo was descended the branch of the Elisei; from Aldighiero, son of Cacciaguida, the branch of the Alighieri. Bellincione, son of Aldighiero, was the grandfather of Dante. His father was a second Aldighiero, a lawyer of some reputation. By his first wife, Lapa di Chiarissimo Cialuffi, this Aldighiero had a son Francesco; by his second, Donna Bella, whose family name is not known, Dante and a daughter. Thus the family of Dante held a most respectable position among the citizens of his beloved city; but had it been reckoned in the very first rank they could not have remained in Florence after the defeat of the Guelfs at Montaperti in 1260. It is clear, however, that Dante's mother at least did so remain, for Dante was born in Florence in 1265. The heads of the Guelf party did not return till 1267.

Dante was born under the sign of the Twins, Education. "the glorious stars pregnant with virtue, to whom he owes his genius such as it is." Astrologers considered this constellation as favorable to literature and science, and Brunetto Latini, his instructor, tells him in the *Inferno* (xv. 25, foll.) that, if he follows its guidance, he cannot fail to reach the harbor of fame. Boccaccio relates that before his birth his mother dreamed that she lay under a very lofty laurel, growing in a green meadow, by a very clear fountain, when she felt the pangs of childbirth,—that her child, feeding on the berries which fell from the laurel, and on the waters of the fountain, in a very short time became a shepherd, and attempted to reach the leaves of the laurel, the fruit of which had nurtured him,—that, trying to obtain them he fell, and rose up, no longer a man, but in the guise of a peacock. We know little of Dante's boyhood except that he was a hard student and a pupil of Brunetto Latini. Boccaccio tells us that he became very familiar with Virgil, Horace, Ovid, and Statius, and all other famous

poets; and that, "taken by the sweetness of knowing the truth of the things concealed in heaven, and finding no other pleasure dearer to him in life, he left all other worldly care and gave himself to this alone, and, that no part of philosophy might remain unseen by him, he plunged with acute intellect into the deepest recesses of theology, and so far succeeded in his design that, caring nothing for heat or cold, or watchings or fastings, or any other bodily discomforts, by assiduous study he came to know of the divine essence and of the other separate intelligences all that the human intellect can comprehend." Leonardo Bruni says that "by study of philosophy, of theology, astrology, arithmetic, and geometry, by reading of history, by the turning over many curious books, watching and sweating in his studies, he acquired the science which he was to adorn and explain in his verses." Of his teacher Brunetto Latini, of whom he speaks with the most loving gratitude and affection, but whose gross vices he does not hesitate to brand with infamy, Giovanni Villani has left us a graphic picture:—"He was a great philosopher, and a consummate master of rhetoric, not only in knowing how to speak well, but how to write well. He it was who explained the rhetoric of Tully and made the good and useful book called *Tesoro*, and the *Tesoretto* and the *Chiave del Tesoro*, and other works in philosophy and of vices and virtues, and he was secretary of our commune. He was a worldly man; but we have made mention of him because he both began and directed the growth of the Florentines, both in making them ready in speaking well and in knowing how to guide and direct our republic according to the rules of politics." Under this guidance Dante became master of all the science of his age at a time when it was not impossible to know all that could be known. He was a skilful draughtsman, and tells us that on the anniversary of the death of Beatrice he drew an angel on a tablet. He

was an intimate friend of Giotto, who has immortalized his youthful lineaments in the chapel of the Bargello, and who is recorded to have drawn from his friend's inspiration the allegories of Virtue and Vice which fringe the frescoes of the Scrovegni Chapel at Padua. Nor was he less sensible to the delights of music. Milton had not a keener ear for the loud uplifted angel trumpets and the immortal harps of golden wires of the cherubim and seraphim; and our English poet was proud to compare his own friendship with Henry Lawes with that between Dante and Casella, "met in the milder shades of purgatory." Most dear to him of all were the companions Cino di Pistoia, Lapo Gianni, Guido Cavalcanti, and others, similarly gifted and dowered with like tastes, who lived in the lively streets of the city of the flowers, and felt with him the first warm flush of the coming renaissance. He has written no sweeter or more melodious lines than those in which he expresses the wish that he with Guido and Lapo, might be wafted by enchantment over the sea wheresoever they might list, shielded from fortune and evil times, and living in such contentment that they should wish to live always, and that the good enchanter should bring Monna Vanna and Monna Vice and that other lady into their barque, where they should for ever discourse of love and be for ever happy. It is a wonderful thing (says Leonardo Bruni) that, though he studied without intermission, it would not have appeared to any one that he studied, from his joyous mien and youthful conversation. Like Milton he was trained in the strictest academical education which the age afforded; but Dante lived under a warmer sun and brighter skies, and found in the rich variety and gayety of his early life a defence against the withering misfortunes of his later years. Milton felt too early the chill breath of Puritanism, and the serious musing on the experience of life, which saddened the verse of both poets, deepened in his case into grave and desponding melancholy.

We must now consider the political circumstances in which lay the activity of Dante's manhood. From 1115, the year of the death of Matilda countess of Tuscany, to 1215, Florence enjoyed a nearly uninterrupted peace. Attached to the Guelph party it remained undivided against itself. But in 1215 a private feud between the families of Buondelmonte and Uberti introduced into the city the horrors of civil war. Villani (lib. v. cap. 38) relates how Buondelmonte de Buondelmonti, a noble youth of Florence, being engaged to marry a lady of the house of Amidei, allied himself

instead to a Donati, and how Buondelmonte was attacked and killed by the Amidei and Uberti at the foot of the Ponte Vecchio, close by the pilaster which bears the image of Mars. "The death of Messer Buondelmonte was the occasion and beginning of the accursed parties of Guelphs and Ghibellines in Florence." Of the seventy-two families then in Florence thirty-nine became Guelph under the leadership of the Buondelmonte, and the rest Ghibelline under the Uberti. The strife of parties was for a while allayed by the war against Pisa in 1222, and the constant struggles against Siena; but in 1248 Frederick II. sent into the city his natural son Frederick, prince of Antioch, with 1600 German knights. The Guelphs were driven away from the town, and took refuge, part in Montevarchi, part in Caspraia. The Ghibellines, masters of Florence, behaved with great severity, and destroyed the towers and palaces of the Guelph nobles. At last the people became impatient. They rose in rebellion, deposed the podesta, elected in his place a captain of the people, established a more democratic constitution, and, encouraged by the death of Frederick in December, 1250, recalled the exiled Guelphs. Manfred, the bastard son of Frederick, pursued the policy of his father. He stimulated the Ghibelline Uberti to rebel against their position of subjection. A rising of the vanquished party was put down by the people, in July, 1258, the Ghibellines were expelled from the town, and the towers of the Uberti razed to the ground. The exiles betook themselves to the friendly city of Siena. Manfred sent them assistance. The Florentines, after vainly demanding their surrender, despatched an army against them. On September 4, 1260, was fought the great battle of Montaperti, which dyed the Arbia red, and in which the Guelphs were entirely defeated. The hand which held the banner of the republic was sundered by the sword of a traitor. For the first time in the history of Florence the Caroccio was taken. Florence lay at the mercy of her enemies. A parliament was held at Empoli, in which the deputies of Siena, Pisa, Arezzo, and other Tuscan towns consulted on the best means of securing their new war power. They voted that the accursed Guelph city should be blotted out. But Farinata of the Uberti stood up in their midst, bold and defiant as when he stood erect among the sepulchres of hell, and said that if, from the whole number of the Florentines, he alone should remain, he would not suffer, whilst he could wield a sword, that his country should be destroyed, and that, if it were necessary to die a thousand times for her, a thousand times would he be ready to encounter death. Help came to the Guelphs from an unexpected quarter. Clement IV., elected Pope in 1265, offered the crown of Apulia and Sicily to Charles of Anjou. The French prince, passing rapidly through Lombardy, Romagna, and the Marches, reached Rome by way of Spoleto, was crowned on January 6, 1266, and on February 23 defeated and killed Manfred at Benevento. In such a storm of conflict did Dante first see the light. In 1267 the Guelphs were recalled, but instead of settling down in peace with their opponents they summoned Charles of Anjou to vengeance, and the Ghibellines were driven out. The meteor passage of Conradin gave hope to the imperial party, which was quenched when the head of the fair-haired boy fell on the scaffold at Naples. Pope after Pope tried in vain to make peace. Gregory X. placed the rebellious city under an interdict; Nicolas III. in 1280 patched up a hollow truce. In 1282 the constitution of Florence received the final form which it retained till the collapse of freedom. From the three *arti maggiori* were chosen six priors, in whose hands was placed the government of the republic. They remained in office for two months, and during that time lived and shared a common table in the Public Palace. We shall see what influence this office had upon the fate of Dante. The success of the Sicilian Vespers, the vacancy of the Holy See, the death of Charles of Anjou, roused again the courage of the Ghibellines. They took possession of Arezzo, and threatened to drive out the Guelphs from Tuscany. The historian Ammirato has left us a lively account of the skirmishes against Arezzo in the year 1288, a prelude to the great battle of Campaldino in the following summer. Then it was that Dante saw "horsemen moving camp and commencing the assault, and holding muster, and the march of foragers, the shock of tournaments, and race of jousts, now with trumpets and now with bells, with drums and castle signals, with native things and

foreign" (*Inf.* xxii. 1, foll.). On June 11, 1289, at Campaldino near Poppi, in the Casentino, the Ghibellines were utterly defeated. They never again recovered their hold on Florence, but the violence of faction survived under other names. Dante fought with distinction at Campaldino, was present shortly afterwards at the battle of Caprona (*Inf.* xxi. 95, foll.), and returned in September, 1289, to his studies and his love. His peace was of short duration. On June 9, 1290, died Beatrice, whose mortal love had guided him for thirteen years, and whose immortal spirit purified his later life, and revealed to him the mysteries of Paradise.

Dante had first met Beatrice Portinari at the house of her father Folco on May-day, 1274. In his own words, "already nine times after my birth the heaven of light had returned as it were to the same point, when there appeared to my eyes the glorious lady of my mind, who was by many called Beatrice who knew not what to call her. She had already been so long in this life that already in its time the starry heaven had moved towards the east the twelfth part of a degree, so that she appeared to me about the beginning of her ninth year, and I saw her about the end of my ninth year. Her dress on that day was of a most noble color, a subdued and goodly crimson, girdled and adorned in such sort as best suited with her tender age. At that moment I saw most truly that the spirit of life which hath its dwelling in the secretest chamber of the heart began to tremble so violently that the least pulses of my body shook therewith; and in trembling it said these words, 'Ecco deus fortior me qui veniens dominabitur mihi.'" In the *Vita Nuova* is written the story of his passion from its commencement to within a year after the lady's death. He saw Beatrice only once or twice, and she probably knew little of him. She married Simone de' Bardi. But the worship of her lover was stronger for the remoteness of its object. The last chapter of the *Vita Nuova* relates how, after the lapse of a year, "it was given me to behold a wonderful vision, wherein I saw things which determined me that I would say nothing further of this blessed one until such time as I could discourse more worthily concerning her. And to this end I labor all I can, as she in truth knoweth. Therefore if it be His pleasure through whom is the life of all things that my life continue with me a few years, it is my hope that I shall yet write concerning her what hath not before been written of any woman. After the which may it seem good unto Him who is the master of grace that my spirit should go hence to behold the glory of its lady, to wit, of that blessed Beatrice who now gloriously gazes on the countenance of Him qui est per omnia secula benedictus." In the *Convito* he resumes the story of his life: "When I had lost the first delight of my soul (that is, Beatrice) I remained so pierced with sadness that no comforts availed me anything, yet after some time my mind, desirous of health, sought to return to the method by which other disconsolate ones had found consolation, and I set myself to read that little-known book of Boetius in which he consoled himself when a prisoner and an exile. And hearing that Tully had written another work, in which, treating of friendship, he had given words of consolation to Lælius, I set myself to read that also." He so far recovered from the shock of his loss that in 1292 he married Gemma, daughter of Manetto Donati, a connection of the celebrated Corso Donati, afterwards Dante's bitter foe. It is possible that she is the lady mentioned in the *Vita Nuova* as sitting full of pity at her window and comforting Dante for his sorrow. By this wife he had seven children, and although he never mentions her in the *Divina Commedia*, and although she did not accompany him into exile, there is no reason to suppose that she was other than a good wife, or that the union was otherwise than happy. Certain it is that he spares the memory of Corso in his great poem, and speaks kindly of his kinsmen Piccarda and Forese.

Dante now began to take an active part in office and politics. He was inscribed in the *arte* of the

*Medici* and *Speziali*, which made him eligible as one of the six *priori* to whom the government of the city was intrusted in 1292. Documents still existing in the archives of Florence show that he took part in the deliberations of the several councils of the city in 1295, 1296, 1300, and 1301. Filelfo says that he served on fourteen embassies, a statement not only unsupported by

evidence, but impossible in itself. Filelfo does not mention the only embassy in which we know for certain that Dante was engaged, that to the town of San Gemignano in 1299. From June 15 to August 15, 1300, he held the office of prior, which was the source of all the miseries of his life. The spirit of faction had again broken out in Florence. The two rival families were the Cerchi and the Donati,—the first of great wealth but recent origin, the last of ancient ancestry but poor. A quarrel had arisen in Pistoia between the two branches of the Cancellieri,—the Bianchi and Neri, the Whites and the Blacks. The quarrel spread to Florence, the Donati took the side of the Blacks, the Cerchi of the Whites. Pope Boniface was asked to mediate, and sent Cardinal Matteo d'Acquasparta to maintain peace. He arrived just as Dante entered upon his office as prior. The cardinal effected nothing, but Dante and his colleagues banished the heads of the rival parties in different directions to a distance from the capital. The Blacks were sent to Città della Pieve in the Tuscan mountains; the Whites, among whom was Dante's dearest friend Guido Cavalcanti, to Serreznano in the unhealthy Maremma. After the expiration of Dante's office both parties returned, Guido Cavalcanti so ill with fever that he shortly afterwards died. The Blacks sought for vengeance. The journey of Charles of Valois to Rome gave them an opportunity. At a meeting held in the church of the Holy Trinity the Whites were denounced as Ghibellines, enemies of France and of the pope, and the French prince was invited to the town as peacemaker, to defend the Guelphs against their machinations. The priori sent at the end of September four ambassadors to the Pope, one of whom was Dante. He never again saw the towers of his native city. Charles of Valois marched from Pavia and took up his abode in the Oltr' Arno. Corso Donati, who had been banished a second time, returned in force and summoned the Blacks to arms. The prisons were broken open, the podestà driven from the town, the Cerchi confined within their houses, a third of the city was destroyed with fire and sword. By the help of Charles the Blacks were victorious. They appointed Cante de' Gabrielli of Gubbio as podestà, a man devoted to their interests. More than 600 Whites were condemned to exile and cast as beggars upon the world. On January 27, 1302, Dante with three others was condemned to pay a fine of 5000 lire of small florins. If the money was not paid within three days their property was to be destroyed and laid waste; if they did pay the fine they were to be exiled for two years from Tuscany; in any case they were never again to hold office in the republic. On March 10 Dante and fourteen others were condemned to be burned alive if they should come into the power of the republic. Similar sentences were passed in September, 1311, and October, 1315. The sentence was not formally reversed till 1454, under the government of the Medici.

Dante received the news of his banishment in Siena. The exiles met first at Gargonza, a castle between Siena and Arezzo, and then at Arezzo itself. They joined themselves to the Ghibellines, to which party the podestà Ugucione della Faggiuola belonged. The Ghibellines, however, were divided amongst themselves, and the Green Ghibellines were not disposed to favor the cause of the White Guelphs. They found a more sympathetic defender in Scarpetta degli Ordelfaffi at Forlì. From this place Dante probably went to Bartolommeo della Scala, lord of Verona, where the country of the great Lombard gave him his first refuge and his first hospitable reception. Can Grande, to whom he afterwards dedicated the *Paradiso*, was then a boy. Bartolommeo died in 1304, and it is possible that Dante may have remained in Verona till his death. In September, 1303, the fleur-de-lis had entered Anagni, and Christ had a second time been buffeted in the person of his vicar. Boniface VIII. did not survive the insult long, but died in the following month. He was succeeded by Benedict XI., who did his best to give peace to his distracted country. Immediately after his accession he sent the Cardinal da Prato to Florence, who arrived there in March, 1304. The people received him with enthusiasm; ambassadors came to him from the Whites; and he did his best to reconcile the two parties. But the Blacks resisted all his efforts. He shook the dust from off his feet, and departed leaving the city under an interdict. Foiled by the calumnies and machinations of the one party, the cardinal gave his countenance to the other. It happened that

Corso Donati and the heads of the Black party were absent at Pistoia. Da Prato advised the Whites to attack Florence, deprived of its heads and inspired by fire. An army was collected of 16,000 foot and 9000 horse. Communications were opened with the Ghibellines of Bologna and Romagna. But the forces of the exiles, badly led, reached the gates of the city only to find themselves unsupported from within. They were driven to retreat, all hope of return became impossible, and Dante felt for the first time the full bitterness of exile. It was after the failure of this ill-conceived attempt that Dante's wanderings really began. Filled with contempt at the baseness and incapacity of his fellow-sufferers, he wished that, disdainful of the support of their companionship, he had stood alone and made a party by himself. This, indeed, we must consider Dante to have done, if we would understand the real nature

Dante's  
Ghibellin-  
ism.

of his Ghibellinism. Dante had been born and bred a Guelf, and it was only under the pressure of inevitable necessity that he and his friends allied themselves with the other side. If we rise beyond the limits of mere local quarrels, we find in Italian history that the Guelf party was generally speaking favorable to liberty. The municipal privileges of the great Italian cities rose under the protection of the Popes, while the emperors only crossed the Alps to crush their ancient independence, and depress them beneath the yoke of some feudal representative. The horse of Barbarossa trampled upon the ashes of Milan, whereas the straw-built fortress of the Lombard league bore the name of Alexander. Had it not breathed the air of freedom the life of Florence could not have survived the period of its infancy, stifled as it afterwards was by the preponderance of the Medici. Dante could not have been indifferent or ungrateful to the cause which had given to his beloved Italy all that made it valuable to the world. But he saw that the conditions of the time were altered, and that other dangers menaced the welfare of his country. There was no fear now that Florence, Siena, Pisa, Arezzo should be razed to the ground in order that the castle of the lord might overlook the humble cottages of his contented subjects; but there was danger lest Italy should be torn in sunder by its own jealousies and passions, and lest the fair domain bounded by the sea and the Alps should never properly assert the force of its individuality, and should present a contemptible contrast to a united France and a confederated Germany. Sick with petty quarrels and dissensions Dante strained his eyes towards the hills for the appearance of a deliverer, who should hush the jar of discord, discipline into effectiveness the luxuriant forces of the peninsula, and, united in spiritual harmony with the vicar of Christ, show for the first time to the world an example of a government where the strongest force and the highest wisdom were interpenetrated by all that God had given to the world of piety and justice. In this sense and in no other was Dante a Ghibelline. The vision was never realized—the hope was never fulfilled. Not till our own day has Italy become united and the "greyhound of deliverance" has chased from city to city the "wolf" of the papacy. But is it possible to say that the dream did not work its own realization, or to deny that the high ideal of the poet, after inspiring a long succession of minds as lofty as his own, has become after five hundred years embodied in the constitution of a state which acknowledges no stronger bond of union than a common worship of the exile's indignant and impassioned verse?

Wander-  
ings.

It is very difficult to determine with exactness the order and the place of Dante's wanderings. Many cities and castles in Italy have claimed the honor of giving him shelter, or of being for a time the home of his inspired muse. He certainly spent some time with Count Guido Salvatico in the Casentino near the sources of the Arno, probably in the castle of Porciano, and with Uguccione in the castle of Faggiuola in the mountains of Urbino. After this he is said to have visited the university of Bologna; and in August, 1306, we find him at Padua. Cardinal Napoleon Orsini, the legate of the French Pope Clement V., had put Bologna under a ban, dissolved the university, and driven the professors to the northern city. In May or June, 1307, the same cardinal collected the Whites at Arezzo and tried to induce the Florentines to recall them. The name of Dante is found attached to a document signed by the Whites in the church of St. Gaudenzio in the Mugello.

This enterprise came to nothing. Dante retired to the castle of Moroello Della Spina in the Lunigiana, where the marble ridges of the Apennines descend in precipitous slopes to the Gulf of Spezzia. From this time till the arrival of the emperor Henry VII. in Italy, October, 1310, all is uncertain. His old enemy Corso Donati had at last united himself with Uguccione della Faggiuola, the leader of the Ghibellines. Dante thought it possible that this might lead to his return. But in 1308 Corso was declared a traitor, attacked in his house, put to flight, and killed. Dante lost his last hope. He left Tuscany, and went to Can Grande della Scala at Verona. From this place we may believe that he visited the university of Paris, studied in the Rue Fouarre, became acquainted with the Low Countries, and not improbably crossed the Channel and went to Oxford, and saw where the heart of Prince Harry was worshipped upon London Bridge. The election of Henry of Luxembourg as emperor stirred again his hopes of a deliverer. He left Paris and returned hastily to Italy. At the end of 1310, in a letter to the princes and people of Italy, he proclaimed the coming of the savior; at Milan he did personal homage to his sovereign. The Florentines made every preparation to resist the emperor. Dante wrote from the Casentino a letter dated March 31, 1311, in which he rebuked them for their stubbornness and obstinacy. Henry still lingered in Lombardy at the siege of Cremona, when Dante, on April 16, 1311, in a celebrated epistle, upbraided his delay, argued that the crown of Italy was to be won on the Arno rather than on the Po, and urged the tarrying emperor to hew the rebellious Florentines, like Agag, in pieces before the Lord. Henry was as deaf to this exhortation as the Florentines themselves. After reducing Lombardy he passed from Genoa to Pisa, and on June 29, 1312, was crowned in Rome. Then at length he moved towards Tuscany by way of Umbria. Leaving Cortona and Arezzo, he reached Florence on September 19. He did not dare to attack it, but returned in November to Pisa. In the summer of the following year he prepared to invade the kingdom of Naples; but in the neighborhood of Siena he caught a fever, and died at the monastery of Buonconvento, August 24, 1313. The hopes of Dante and his party were buried in his grave.

After the death of the emperor Henry (Bruni tells us), Dante passed the rest of his life in <sup>Old age</sup> <sup>and death.</sup> great poverty, sojourning in various places throughout Lombardy, Tuscany, and the Romagna, under the protection of various lords, until at length he retired to Ravenna, where he ended his life. Very little can be added to this meagre story. There is reason for supposing that he stayed at Gubbio with Bosone dei Rafeilli, and tradition assigns him a cell in the monastery of St. Croce di Fonti Avellana in the same district, situated on the slopes of Catria, one of the highest of the Apennines. After the death of Pope Clement V. he addressed a letter, dated July 14, 1314, to the cardinals in conclave, urging them to elect an Italian Pope. About this time he came to Lucca, then lately conquered by his friend Uguccione, completed the last cantos of the *Purgatory*, and became enamored of the courteous Gentucca, whose name had been whispered to him by her countryman on the slopes of the Mountain of Purification. In August, 1315, was fought the battle of Monte Catini, a day of humiliation and mourning for the Guelfs. Uguccione made but little use of his victory, and the Florentines marked their vengeance on his adviser by condemning Dante yet once again to death if he ever should come into their power. In the beginning of the following year Uguccione lost both his cities of Pisa and Lucca. At this time Dante was offered an opportunity of returning to Florence. The conditions given to the exiles were that they should pay a fine and walk in the dress of humiliation to the church of St. John, and there do penance for their offences. Dante refused to tolerate this shame, and the letter is still extant in which he declines to enter Florence except with honor, secure that the means of life will not fail him, and that in any corner of the world he will be able to gaze at the sun and the stars, and meditate on the sweetest truths of philosophy. He preferred to take refuge with his most illustrious protector Can Grande della Scala of Verona, then a young man of twenty-five, rich, liberal, and the favored head of the Ghibelline party. His name has been immortalized by an eloquent panegyric in the seventeenth canto of the *Paradiso*. Whilst at the court of Verona he

maintained in the neighboring city of Mantua the philosophical thesis *De Aqua et Terra*, which is included in his minor works. The last two years of his life were spent at Ravenna, under the protection of Guido da Polenta. In his service Dante undertook an embassy to the Venetians. He failed in the object of his mission, and, returning disheartened and broken in spirit through the unhealthy lagoons, caught a fever, and died in Ravenna September 14, 1321. His bones still repose there. His doom of exile has been reversed by the union of Italy, which has made the city of his birth and the various cities of his wanderings component members of a common country. His son Piero, who wrote a commentary on the *Divina Commedia*, settled in Verona. His daughter Beatrice lived as a nun in Ravenna. His direct line became extinct in 1509, but the blood still runs in the veins of the Marchesi Serego Alighieri, a noble family of the city of the Scaligers.

Dante may be said to have concentrated in himself the spirit of the Middle Age. Whatever there was of piety, of philosophy, of poetry, of love of nature, and of love of knowledge in those times is drawn to a focus in his writings. He is the first great name in literature after the night of the Dark Ages. The Italian language in all its purity and sweetness, in its aptitude for the tenderness of love and the violence of passion, or the clearness of philosophical argument, sprang fully grown and fully armed from his brain. The *Vita Nuova* is still the best introduction to the study of the Tuscan tongue; the astronomy and science of the *Divine Comedy* are obscure only in a translation. Dante's reputation has passed through many vicissitudes, and much trouble has been spent by critics in comparing him with other poets of established fame. Read and commented upon in the Italian universities in the generation immediately succeeding his death, his name became obscured as the sun of the renaissance rose higher towards its meridian. In the 17th century he was less read than Petrarch, Tasso, or Ariosto; in the 18th he was almost universally neglected. His fame is now fully vindicated. Translations and commentaries issue from every press in Europe and America. Dante societies are formed to investigate the difficulties of his works. He occupies in the lecture-rooms of regenerated Italy a place by the side of those great masters whose humble disciple he avowed himself to be. The *Divine Comedy* is indeed as true an epic as the *Aeneid*, and Dante is as real a classic as Virgil. His metre is as pliable and flexible to every mood or emotion, his diction as plaintive and as sonorous. Like him he can immortalize, by a single expression, a person, a place, or a phase of nature. Dante is even truer in description than Virgil, whether he paints the snow falling in the Alps, or the homeward flight of birds, or the swelling of an angry torrent. But under this gorgeous pageantry of poetry there lies a unity of conception, a power of philosophic grasp, an earnestness of religion which to the Roman poet were entirely unknown. Still more striking is the similarity between Dante and Milton. This may be said to lie rather in the kindred nature of their subjects, and in the parallel development of their minds, than in any mere external resemblance. In both the man was greater than the poet; the souls of both were "like a star and dwelt apart." Both were academically trained in the deepest studies of their age. The labor which made Dante lean, made Milton blind. The "Doric sweetness" of the English poet is not absent from the tender pages of the *Vita Nuova*. The middle life of each was spent in active controversy; each lent his services to the state; each felt the quarrels of his age to be the "business of posterity," and left his warnings to ring in the ears of a later time. The lives of both were failures. "On evil days though fallen and evil tongues," they gathered the concentrated experience of their lives into one immortal work, the quintessence of their hopes, their knowledge, and their sufferings. But Dante is something more than this. Milton's voice is grown faint to us—we have passed into other modes of expression and of thought. But if we had to select two names in literature who are still exercising their full influence on mankind, and whose teaching is still developing new sides to the coming generations, we should choose the names of Dante and Goethe. Goethe preached a new gospel to the world, the pagan virtue of self-culture, a sympathy which almost passed into indifference. There is no department of modern literature or thought which

does not bear upon it the traces of the sage of Weimar. But if we rebel against this teaching, and yearn once more for the ardor of belief, the fervor of self-sacrifice, the scorn of scorn and the hate of hate which is the meed of the coward and the traitor, where shall we find them but in the pages of the Florentine? The religion of the future, if it be founded on faith, will demand that faith be reconciled with all that the mind can apprehend of knowledge or the heart experience of emotion. The saint of those days will be trained, not so much on ascetic counsels of Imitation, or in Thoughts which base man's greatness on the consciousness of his fall, as on the verse of the poet, theologian, and philosopher, who stands with equal right in the conclave of the doctors and on the slopes of Parnassus, and in whom the ardor of study is one with the love of Beatrice, and both are made subservient to lift the soul from the abyss of hell, along the terraces of purgatory, to the spheres of paradise, till it gazes on the ineffable revelation of the existence of God himself, which can only be apprehended by the eye of faith.

It only remains now to give a short account *Vita Nuova* of Dante's separate works. The *Vita Nuova*, or *Young Life*, of Dante contains the history of his love for Beatrice. Like the *In Memoriam* of our own poet it follows all the varying phases of a deep and over-mastering passion from its commencement to its close. He describes how he met Beatrice as a child, himself a child, how he often sought her glance, how she once greeted him in the street, how he feigned a false love to hide his true love, how he felt ill and saw in a dream the death and transfiguration of his beloved, how she died, and how his health failed from sorrow, how the tender compassion of another lady nearly won his heart from its first affection, how Beatrice appeared to him in a vision and reclaimed his heart, and how at last he saw a vision which induced him to devote himself to study that he might be more fit to glorify her who gazes on the face of God for ever. This simple story is interspersed with sonnetti, ballate, and canzoni, chiefly written at the time to emphasize some mood of his changing passion. After each of these, in nearly every case, follows an explanation in prose, which is intended to make the thought and argument intelligible to those to whom the language of poetry was not familiar. The book was probably completed in 1307. It was first printed by Sermartelli in Florence, 1576. The latest and best edition is that by Witte, published by Brockhaus, Leipsic, 1876.

The *Convito*, or *Banquet*, is the work of Dante's manhood, as the *Vita Nuova* is the work of his youth. It consists, in the form in which it has come down to us, of an introduction and three treatises, each forming an elaborate commentary in a long canzone. It was intended, if completed, to have comprised commentaries on eleven more canzoni, making fourteen in all, and in this shape would have formed a *tesoro* or hand-book of universal knowledge, such as Brunetto Latini and others have left to us. It is perhaps the least well known of Dante's Italian works, but crabbed and unattractive as it is in many parts, it is well worth reading, and contains many passages of great beauty and elevation. Indeed a knowledge of it is quite indispensable to the full understanding of the *Divina Commedia*. The time of its composition is uncertain. Dante mentions princes as living who died in 1309; he does not mention Henry VII. as emperor, who succeeded in 1310. There are some passages which seem to have been inserted at a later date. The canzoni upon which the commentary is written were clearly composed between 1292 and 1300, when he sought in philosophy consolation for the loss of Beatrice. The present text is very defective. The *Convito* was first printed in Florence by Buonaccorsi in 1490.

*Rime di Dante*.—Besides the smaller poems contained in the *Vita Nuova* and *Convito* there are a considerable number of canzoni, ballate, and sonnetti bearing the poet's name. Of these many undoubtedly are genuine, others as undoubtedly spurious. Some which have been preserved under the name of Dante belong to Dante da Maiano, a poet of a harsher style; others which bear the name of Aldighiero are referable to Dante's sons Jacopo or Pietro, or to his grandsons; others may be ascribed to Dante's contemporaries and predecessors Cino da Pistoia and others. Those which are genuine secure Dante a place among lyrical poets scarcely if at all inferior to that of Petrarch. The best edition of the *Can-*

Minor poems.

soniere of Dante is that by Fraticelli published by Barbéra at Florence. His collection includes seventy-eight genuine poems, eight doubtful, and fifty-four spurious. To these are added an Italian paraphrase of the seven penitential psalms in *terza rima*, and a similar paraphrase of the Credo, the seven sacraments, the ten commandments, the Lord's Prayer, and the Ave Maria.

The Latin treatise, *De Monarchia*, in three books, contains the creed of Dante's Ghibellinism. In it he propounds the theory that the supremacy of the emperor is derived from the supremacy of the Roman people over the world, which was given to them direct from God. As the emperor is intended to assure their earthly happiness, so does their spiritual welfare depend upon the Pope, to whom the emperor is to do honor as to the first-born of the Father. The date of its composition is almost universally admitted to be the time of the descent of Henry VII. into Italy, between 1310 and 1313, although attempts have been made to assign it to a much earlier period. The book was first printed by Oporinus at Basel in 1559.

The treatise *De Vulgari Eloquentia*, in two books, also in Latin, is mentioned in the *Convivio*. Its object was first to establish the Italian language as a literary tongue, and to distinguish between the noble speech which might become the property of the whole nation, at once a bond of internal unity and a line of demarcation against external nations; and secondly, to lay down rules for poetical composition in the language so established. The work was probably intended to be in four books, but only two are extant. The first of these deals with the language, the second with the style and with the composition of the canzone. The third was probably intended to continue this subject, and the fourth was destined to the laws of the ballata and sonnetto. This work was first published in the Italian translation of Trissino at Vicenza in 1529. The original Latin was not published till 1729 at Verona. The modern editions both of this work and of the *De Monarchia* by Fraticelli are very admirable. The work was probably left unfinished in consequence of Dante's death.

Boccaccio mentions in his life of Dante that he wrote two eclogues in Latin in answer to Johannes de Virgilio, who invited him to come from Ravenna to Bologna and compose a great work in the Latin language. The most interesting passage in the work is that in the first poem, where he expresses his hope that when he has finished the three parts of his great poem his grey hairs may be crowned with laurels on the banks of the Arno. Although the Latin of these poems is superior to that of his prose works, we may feel thankful that Dante composed the great work of his life in his own vernacular. These eclogues have also been printed with notes by Fraticelli.

The *Letters* of Dante are among the most important materials for his biography. Giovanni Villani mentions three as specially remarkable—one to the Government of Florence, in which he complains of undeserved exile; another to the Emperor Henry VII., when he lingered too long at the siege of Brescia; and a third to the Italian cardinals to urge them to the election of an Italian Pope after the death of Clement V. The first of these letters has not come down to us, the two last are extant. Besides these we have one addressed to the Cardinal da Prato, one to a Florentine friend refusing the base conditions of return from exile, one to the princes and lords of Italy to prepare them for the coming of Henry of Luxembourg, another to the Florentines reproaching them with the rejection of the emperor, and a long letter to Can Grande della Scala, containing directions for interpreting the *Divina Commedia*, with especial reference to the *Paradiso*. Of less importance are the letters to the nephews of Count Alessandro da Romagna, to the Marquis Moroello Malaspina, to Cino da Pistoia, and to Guido da Polenta. There are many other letters mentioned by early biographers which may yet be lying hidden in Italian archives.

A treatise *De Aqua et Terra* has come down to us, which Dante tells us was delivered at Mantua in January, 1320 (perhaps 1321) as a solution of the question which was being at that time much discussed—whether on any place in the earth's surface water is higher than the earth. There is no doubt about its genuineness, and it affords us a valuable insight into Dante's studies and modes of thought.

We have reserved all mention of the *Divina Commedia* till the last. It would be useless in this place to attempt any account of the contents and scope of this wonderful poem. Those who would learn what it is without studying the poem itself could have no better guide than the *Shadow of Dante* by Maria Rossetti. It will be enough here to say a few words about the date of its composition. The time of the action is strictly confined to the end of March and the beginning of April, 1300. It is not improbable that it was commenced shortly after this date. In the *Inferno*, xix. 79, there is an allusion to the death of Pope Clement V., an event which occurred in 1314. This probably marks the date of the completion of this cantica. The *Purgatorio* was completed before 1318, as we learn from the Latin poem addressed to Johannes de Virgilio, which speaks of the *Inferno* and *Purgatorio* as completed, the *Paradiso* as yet to be written. The date of the poem is 1318. The last cantos of the *Paradiso* were probably not finished until just before the poet's death.

A complete bibliography of Dante literature would require an article to itself. Of the many separate works on this subject perhaps the most complete is that in the fourth volume of the *Manuale Danteo* by Professor Ferrazzi Bassano, 1871. The chief secondary authorities for the preceding biography have been the article in *Erach und Gruber's Encyclopædia* by Blanc, the *Vita di Dante* by Fraticelli, *Dante Alighieri, seine Zeit sein Leben, und seine Werke*; by Scartazzini, and the excellent treatise of Dr. Theodor Paur *Ueber die Quellen zur Lebensgeschichte Dante's*, Görlitz, 1862. The edition of Dante, with Italian notes by Scartazzini published by Brockhaus at Leipzig, of which only two volumes have as yet appeared, promises to supersede all others. Grave doubts have of late years been thrown on the authenticity of the chronicle of Dino Compagni, which has hitherto been regarded as one of the chief authorities for the life of Dante. A summing up of the evidence by W. Bernhardt, who concludes against the genuineness of the book, is to be found in Von Sybel's *Historische Zeitschrift*, the first number for 1877. A more copious bibliography of Dante literature is subjoined, taken mainly from Scartazzini's German work.

*Editions of Dante's Works.*—*Divina Commedia con l'esposizione di Chr. Landino e di Aless. Velutello*, 1 vol. fol., Venet., 1564. The same, *Giunta la lezione del Codice Bertoliniano*, 4 vols., Udine, 1823-27. The same, *Fottimo Commento*, 3 vols., Pisa, 1827-29. The same, *col. comm. di G. Baglioli*, 3 vols., Mil. 1829. The same, *colla prefazione degli editori della Minerva*, 1 vol. 4to, Fir., 1838. The same, *col. comm. di Fr. da Buti*, 3 vols., Pisa, 1858-62. The same, *ricorretta sopra quattro dei più autorevoli testi a penna da Carlo Witte*, 1 vol. 4to, Berl., 1862. The same, *nuovam. riv. nel testo e dichiarata da Brunone Bianchi*, 1 vol., Fir., 1863. The same, *col. comm. di P. Fraticelli*, 1 vol., Fir., 1864. The same, *il codice Cassinese*, 1 vol. fol., Monte Cassino, 1865. The same, *col. comm. di Anonimo Fiorentino, ed. P. Fanfani*, 1 vol., Bologna, 1866. The same, *col. comm. di G. A. Scartazzini*, Brockhaus, Leipzig. [The volumes containing the *Inferno* and *Purgatorio* are published; a fourth volume is to contain the life of Dante and Prolegomena.]

*Opere Minori, con le Annotaz. di A. M. Friscioni*, 2 vols., Venez., 1741. The same, *con note e illustr. di P. Fraticelli*, 3 vols., Fir., 1861-62. *Vita Nuova e Canzoniere commentati da G. R. Giustani*, 1 vol., Fir., 1868. *Monarchia (Liber I.)*, Carl Witte, 4to, Halis, 1863. The same (Liber II.), Carl Witte, 4to, Halis, 1867. *Epistole ed. e ined. per cura di Aless. Torri*, 1 vol., Livorno, 1842. *Amori e Rime di Dante*, 1 vol., Mantova, 1823.

*Translations.*—The principal translations into English are those of Carey (1806), Dayman (1843), F. Pollock, J. A. Carlyle (the *Inferno* only, 1849), and Longfellow, 1867. The best German translation is by King John of Saxony, under the name of Philaethes. Those of Witte, Blanc, and Kannegiesser are also to be recommended.

Of *Illustrative Writings* the principal are—the article by L. G. Bianco on Dante Alighieri in *Erach und Gruber's Encyclopædia*; *Vocabolario Danteo*, 1 vol., Leipzig, 1852; *Versuch eines philol. Erkl. mehrerer dunklen Stellen d. Göttl. Kom.*, 2 vols., Halle, 1861-65; *Dante e il suo secolo*, 1 vol. fol., Fir., 1865; Fraticelli, *Storia della Vita di Dante A.*, 1 vol., Fir., 1861; Giuliani, G. B., *Metodo di comm. la Comm. di D. A.*, Fir., 1861. Ozanam, *Dante et la philosophie catholique au treizième siècle*, Par., 1845; Paur, Th., *Ueber die Quellen zur Lebensgeschichte Dante's*, Görlitz, 1862; Wegeler, Fr. X., *Dante Al.'s Leben und Werke*, 1 vol., Jena, 1866; the various writings of Carl Witte, *Ueber Dante*, Breslau, 1831; *Quando e da chi sia composto l'ottimo commento a Dante*, Lips., 1847; *De Bartolo a*

*Saxoferrato Dante Allig. studioso, Halis, 1861; Dante und die Ital. Fragen, Halle, 1861; Dante-Forschungen, Halle, 1869; Scartazzini, Dante Allighieri, seine Zeit, sein Leben, und seine Werke, Biel, 1869.* To these must be added the *Jahrbuch of the Dante Gesellschaft* founded in 1866. (o. v.)

DANTON, GEORGE JACQUES (1759-1794), one of the most conspicuous actors in the decisive episodes of the first French Revolution. He was born at Arcis-sur-Aube in 1759. His family was of respectable quality, though of very moderate means. They contrived to give him a good education, and he was launched in the career of an advocate at the Paris bar. When the Revolution broke out, it found Danton following his profession with apparent success, leading a cheerful domestic life, and nourishing his intelligence on good books. He first appears in the revolutionary story as president of the popular club or assembly of the district in which he lived. This was the famous club of the Cordeliers, so called from the circumstance that its meetings were held in the old convent of the order of the Cordeliers, just as the Jacobins derived their name from the refectory of the convent of the Jacobin brothers. It is an odd coincidence that the old rivalries of Dominicans and Franciscans in the democratic movement inside the Catholic Church should be recalled by the names of the two factions in the democratic movement of a later century away from the church. The Cordeliers were from the first the centre of the popular principle in the French Revolution carried to its extreme point; they were the earliest to suspect the court of being irreconcilably hostile to freedom; and it was they who most vehemently proclaimed the need for root and branch measures. Danton's robust, energetic, and impetuous temperament made him the natural leader in such a quarter. We find no traces of his activity in the two great insurrectionary events of 1789—the fall of the Bastille and the forcible removal of the court from Versailles to the Tuileries. In the spring of 1790 we hear his voice urging the people to prevent the arrest of Marat. In the autumn we find him chosen to be the commander of the battalion of the national guard of his district. In the beginning of 1791 he was elected to the post of administrator of the department of Paris. This interval was for all France a barren period of doubt, fatigue, partial reaction, and hoping against hope. It was not until 1792 that Danton came into the prominence of a great revolutionary chief.

In the spring of the previous year (1791) Mirabeau had died, and with him had passed away the only man who was at all likely to prove a wise guide to the court. In June of that year the king and queen made a disastrous attempt to flee from their capital and their people. They were brought back once more to the Tuileries, which from that time forth they rightly looked upon more as a prison than a palace or a home. The popular exasperation was intense, and the constitutional leaders, of whom the foremost was Lafayette, became alarmed and lost their judgment. A bloody dispersion of a popular gathering, known afterwards as the massacre of the Champ-de-Mars (July, 1791), kindled a flame of resentment against the court and the constitutional party which was never extinguished. The Constituent Assembly completed its infertile labors in September, 1791. Then the elections took place to its successor, the short-lived Legislative Assembly. Danton was not elected to it, and his party was at this time only strong enough to procure for him a very subordinate post in the government of the Parisian municipality. Events, however, rapidly prepared a situation in which his influence became of supreme weight. Between January and August, 1792, the want of sympathy between the aims of the popular assembly and the spirit of the king and the queen became daily more flagrant and beyond power of disguise. In April war was declared against Austria, and to the confusion and distraction caused by the immense civil and political changes of the past two years was now added the ferment and agitation of war with an enemy on the frontier. The distrust felt by Paris for the court and its loyalty at length broke out in insurrection. On the memorable morning of the 10th of August, 1792, the king and queen took refuge with the Legislative Assembly from the apprehended violence of the popular forces who were marching on the Tuileries. The share which Danton had in inspiring and directing this momentous rising is very obscure. Some look upon him as the head and centre of it. Apart from documents, support is given to this view by the fact that

on the morrow of the fall of the monarchy Danton is found in the important post of minister of justice. This sudden rise from the subordinate office which he had held in the commune is a proof of the impression that his character had made on the insurrectionary party. To passionate fervor for the popular cause he added a certain broad steadfastness and an energetic practical judgment which are not always found in company with fervor. Even in those days, when so many men were so astonishing in their eloquence, Danton stands out as a master of commanding phrase. One of his fierce sayings has become proverb. Against Brunswick and the invaders, "*il nous faut de l'audace, et encore de l'audace, et toujours de l'audace*,"—we must dare, and again dare, and for ever dare. The tones of his voice were loud and vibrant. As for his bodily presence, he had, to use his own account of it, the athletic shape and the stern physiognomy of the Liberty for which he was ready to die. Jov the Thunderer, the rebel Satan, a Titan, Sardanapalus, were names that friends or enemies borrowed to describe his mien and port. He was thought about as a coarser version of the great tribune of the Constituent Assembly; he was called the Mirabeau of the sans-culottes, and Mirabeau of the markets.

In the executive Government that was formed, on the king's dethronement, this strong revolutionary figure found himself the colleague of the virtuous Roland and others of the Girondins. Their strength was speedily put to a terrible test. The alarming successes of the enemy on the frontier, and the surrender of two important fortresses, had engendered a natural panic in the capital. But in the breasts of some of the wild men whom the disorder of the time had brought to prominent place in the Paris commune this panic became murderously heated. Some hundreds of captives were barbarously murdered in the prisons. There has always been much dispute as to Danton's share in this dreadful transaction. At the time, it must be confessed, much odium on account of an imputed direction of the massacres fell to him. On the whole, however, he cannot be fairly convicted of any part in the plan. What he did was to make the best of the misdeed, with a kind of sombre acquiescence. He deserves credit for insisting against his colleagues that they should not flee from Paris, but should remain firm at their posts, doing what they could to rule the fierce storm that was raging around them.

The elections to the National Convention took place in September, when the Legislative Assembly surrendered its authority. The Convention ruled France until October, 1795. Danton was a member; resigning the ministry of justice, he took a foremost part in the deliberations and proceedings of the Convention, until his execution in April, 1794. This short period of nineteen months was practically the life of Danton, so far as the world is concerned with him.

He took his seat in the high and remote benches which gave the name of the Mountain to the thoroughgoing revolutionists who sat there. He found himself side by side with Marat, whose exaggerations he never countenanced; with Robespierre, whom he did not esteem very highly, but whose immediate aims were in many respects his own with Camille Desmoulins and Phélippeaux, who were his close friends and constant partisans. The foes of the Mountain were the group of the Girondins,—eloquent, dazzling, patriotic, but unable to apprehend the fearful nature of the crisis, too full of vanity and exclusive party-spirit, and too fastidious to strike hands with the vigorous and stormy Danton. The Girondins dreaded the people who had sent Danton to the Convention; and they insisted on seeing on his hands the blood of the prison massacres of September. Yet in fact Danton saw much more clearly than they saw how urgent it was to soothe the insurrectionary spirit after it had done the work of abolition which to him, as to them too, seemed necessary and indispensable. Danton discerned what the Girondins lacked the political genius to see, that this control of Paris could only be wisely effected by men who sympathized with the vehemence and energy of Paris, and understood that this vehemence and energy made the only force to which the Convention could look in resisting the Germans on the north-east frontier, and the friends of reaction in the interior. "Paris," he said, "is the natural and constituted centre of free France. It is the centre of light. When Paris shall perish, there will no longer be a republic."



Danton was among those who voted for the death of the king (January, 1793). He had a conspicuous share in the creation of the famous revolutionary tribunal, his aim being to take the weapons away from that disorderly popular vengeance which had done such terrible work in September. When all executive power was conferred upon a Committee of Public Safety, Danton had been one of the nine members of whom that body was originally composed. He was despatched on frequent missions from the Convention to the republican armies in Belgium, and wherever he went he infused new energy into the work of national liberation. He pressed forward the erection of a system of national education, and he was one of the legislative committee charged with the construction of a new system of government. He vainly tried to compose the furious dissensions between Girondins and Jacobins. The Girondins were irreconcilable, and made Danton the object of deadly attack. He was far too robust in character to lose himself in merely personal enmities, but by the middle of May (1793) he had made up his mind that the political suppression of the Girondins had become indispensable. The position of the country was most alarming. Dumouriez, the victor of Valmy and Jemmappes, had deserted. The French arms were suffering a series of checks and reverses. A royalist rebellion was gaining formidable dimensions in the west. Yet the Convention was wasting time and force in the vindictive recriminations of faction. There is no positive evidence that Danton directly instigated the insurrection of May 31 and June 2, which ended in the purge of the Convention and the proscription of the Girondins. He afterwards spoke of himself as in some sense the author of this revolution, because a little while before, stung by some trait of factious perversity in the Girondins, he had openly cried out in the midst of the Convention, that if he could only find a hundred men, they would resist the oppressive authority of the Girondin Commission of Twelve. At any rate, he certainly acquiesced in the violence of the commune, and he publicly gloried in the expulsion of the men who stood obstinately in the way of a vigorous and concentrated exertion of national power. Danton, unlike the Girondins, accepted the fury of popular passion as an inevitable incident in the work of deliverance. Unlike Billaud de Varrennes, or Hébert, or any other of the Terrorist party, he had no wish to use this frightful two-edged weapon more freely than was necessary. Danton, in short, had the instinct of the statesman. His object was to reconcile France with herself; to restore a society that, while emancipated and renewed in every part, should yet be stable; and above all to secure the independence of his country, both by a resolute defence against the invader, and by such a mixture of vigor with humanity as should reconcile the offended opinion of the rest of Europe. This, so far as we can make it out, was what was in his mind.

The position of the Mountain had now undergone a complete change. In the Constituent Assembly its members did not number more than 30 out of the 578 of the Third Estate. In the Legislative Assembly they had not been numerous, and none of their chiefs had a seat. In the Convention for the first nine months they had an incessant struggle for their very lives against the Girondins. They were now (June, 1793) for the first time in possession of absolute power. It was not easy, however, for men who had for many months been nourished on the ideas and stirred to the methods of opposition, all at once to develop the instincts of government. Actual power was in the hands of the two committees—that of Public Safety and of General Security. Both were chosen out of the body of the Convention. The drama of the nine months between the expulsion of the Girondins and the execution of Danton turns upon the struggle of the committee to retain power—first, against the insurrectionary commune of Paris, and second, against the Convention, from which the committees derived an authority that was regularly renewed on the expiry of each short term.

Danton, immediately after the fall of the Girondins, had thrown himself with extraordinary energy into the work to be done. The first task in a great city so agitated by anarchical ferment had been to set up a strong central authority. In this genuinely political task Danton was prominent. He was not a member of the Committee of Public Safety when that body was renewed in the shape that speedily made its name so redoubtable all over the world. This was the result of a self-denying ordinance

which he imposed upon himself. It was he who proposed that the powers of the committee should be those of a dictator, and that it should have copious funds at its disposal. In order to keep himself clear of any personal suspicion, he announced his resolution not to belong to the body which he had thus done his best to make supreme in the state. His position during the autumn of 1793 was that of a powerful supporter and inspirer, from without, of the Government which he had been foremost in setting up. Danton was not a great practical administrator and contriver, like Carnot, for instance. But he had the gift of raising in all who heard him an heroic spirit of patriotism and fiery devotion, and he had a clear eye and a cool judgment in the tempestuous emergencies which arose in such appalling succession. His distinction was that he accepted the insurrectionary forces, instead of blindly denouncing them as the Girondins had done. After these forces had shaken down the throne, and then, by driving away the Girondins, had made room for a vigorous Government, Danton perceived the expediency of making all haste to an orderly state. Energetic prosecution of the war, and gradual conciliation of civil hatreds, had been, as we have said, the two marks of his policy ever since the fall of the monarchy. The first of these objects was fulfilled abundantly, partly owing to the energy with which he called for the arming of the whole nation against its enemies. His whole mind was now given to the second of them. But the second of them, alas, was desperate.

It was to no purpose that, both in his own action and in the writings of Camille Desmoulins (*Le Vieux Cordelier*), of whom he was now and always the intimate and inspirer, he worked against the iniquities of the bad men, like Carrier and Collot d'Herbois in the provinces, and against the severity of the revolutionary tribunal in Paris. The black flood could not at a word or in an hour subside from its storm-lashed fury. The commune of Paris was now composed of men like Hébert and Chaumette, to whom the restoration of any sort of political order was for the time indifferent. They wished to push destruction to limits which even the most ardent sympathizers with the Revolution condemn now, and which Danton condemned then as extravagant and senseless. These men were not politicians, they were fanatics; and Danton, who was every inch a politician, though of a vehement type, had as little in common with them as John Calvin of Geneva had with John of Leyden and the Münster Anabaptists. The committee watched Hébert and his followers uneasily for many weeks, less perhaps from disapproval of their excesses than from apprehensions of their hostility to the committee's own power. At length the party of the commune proposed to revolt against the Convention and the committees. Then the blow was struck, and the Hébertists were swiftly flung into prison, and thence under the knife of the guillotine (March 24, 1794). The execution of the Hébertists was the first victory of the revolutionary Government over the extreme insurrectionary party. But the committees had no intention to concede anything to their enemies on the other side. If they refused to follow the lead of the anarchists of the commune, they were none the more inclined to give way to the Dantonian policy of clemency. Indeed, such a course would have been their own instant and utter ruin. The Terror was not a policy that could be easily transformed. A new policy would have to be carried out by new men, and this meant the resumption of power by the Convention, and the death of the Terrorists. In Thermidor, 1794, such a revolution did take place, with those very results. But in Germinal, feeling was not ripe. The committees were still too strong to be overthrown. And Danton seems to have shown a singular heedlessness. Instead of striking by vigor in the Convention, he waited to be struck. In these later days a certain discouragement seems to have come over his spirit. His wife had died during his absence on one of his expeditions to the armies; he had now married again, and the rumor went that he was allowing domestic happiness to tempt him from the keen incessant vigilance proper to the politician in such a crisis. He must have known that he had enemies. When the Jacobin club was "purified" in the winter, Danton's name would have been struck out as a moderate, if Robespierre had not defended him. The committees had deliberated on his arrest soon afterwards, and again it was Robespierre who resisted the proposal. Yet though he had been warned of the lightning that was thus playing

round his head, Danton did not move. Either he felt himself powerless, or he rashly despised his enemies. At last Billaud de Varennes, the most prominent spirit of the committee after Robespierre, succeeded in gaining Robespierre over to his designs against Danton. Robespierre was probably actuated by motives of selfish policy, which soon proved the greatest blunder of his life. The Convention, aided by Robespierre and the authority of the committee, assented with ignoble unanimity. On March 30 Danton, Desmoulins, and others of the party were suddenly arrested. Danton displayed such vehemence before the revolutionary tribunal, that his enemies feared lest he should excite the crowd in his favor. The Convention, in one of its worst fits of cowardice, assented to a proposal made by St. Just that, if a prisoner showed want of respect for justice, the tribunal might pronounce sentence without further delay. Danton was at once condemned, and led, in company with fourteen others, including Camille Desmoulins, to the guillotine (April 5, 1794). "I leave it all in a frightful welter," he said; "not a man of them has an idea of government. Robespierre will follow me; he is dragged down by me. Ah, better be a poor fisherman than meddle with the government of men!"

Events went as Danton foresaw. The committees presently came to quarrel with the pretensions of Robespierre. Three months after Danton, Robespierre fell. His assent to the execution of Danton had deprived him of the single great force that might have supported him against the committee. The man who had "saved France from Brunswick" might perhaps have saved her from the White reaction of 1794.

(J. MO.)

DANTZIC (or, according to the German form, which is often used, DANZIG), an important seaport of Prussia, the

east of Berlin, in 54° 21' N. lat. and 18° 41' E. long. In 1875 the inhabitants, most of whom are Protestants, numbered 98,181. The town is traversed by the Motlau, a small branch of the Vistula. It ranks as a fortress of the first class, the fortifications including ramparts, bastions, wet ditches, and works for laying the surrounding country under water. There is a harbor in the town, but the principal port is at Neufahrwasser, at the mouth of the Vistula.

Dantzic is entered by four gates, one of which dates from the 16th century, and another from the 17th. The streets are narrow and winding, but in the Langgasse, the chief street, reaching from the Hohe Thor to the Langenmarkt, there are many interesting specimens of ancient architecture. The high gables, often elaborately ornamented, give the houses a very picturesque aspect. There are 13 Protestant churches, 5 Catholic churches, and 2 synagogues. Of these the most important is St. Mary's, one of the largest Protestant churches in existence, begun in 1343, completed in 1503. It possesses a famous painting of the Last Judgment, known as the Dantzic picture, formerly attributed to Jan van Eyck, but probably by Memling. The town hall, founded in 1379, is a fine Gothic structure, the interior of which has recently been restored. Among other noteworthy buildings are the exchange, built in the 14th century, the citadel, built in 1605, and the theatre, of recent date. To the west of the town is a suburban district of considerable extent, with wide, pleasant streets.

The Government of West Prussia, and a Board of Commerce and of Admiralty, have their seat in Dantzic. It is also a naval station, with docks, magazines, and a marine dépôt. The educational institutions of the town, besides providing amply for elementary education, include a gymnasium, founded in 1558, two real schools of the highest class, a commercial academy, a technical school, and a school of navigation. There are a public library, containing 50,000 volumes, a collection of paintings, chiefly modern, and several societies for the promotion of science, art, and literature. The manufacture of arms and artillery is carried on to a large extent, and the imperial and private docks give employment to a great number of workmen. The town is still famous for its amber, beer, brandy, and the liqueur known as Danziges Goldwasser; and its transit trade makes it one of the most important commercial towns in the north of Europe. Its harbors are visited annually by about 2000 sea-going vessels, besides an immense number of smaller craft employed in river navigation. The chief exports are grain, especially wheat, which comes for the most part from Poland and is of excellent quality, and timber. The principal imports are herring, coal, petroleum, salt, and wine. The annual value of the imports by sea is from £2,500,000 to £3,000,000, by river about £2,250,000, by railway from £2,400,000 to £2,750,000; that of exports by sea from £2,500,000 to £2,750,000, by river from £750,000 to £1,250,000, by railway about £2,500,000.

*History.*—The origin of Dantzic is unknown, but it is mentioned in 997 as an important town. At different times it was held by Pomerania, Poland, Brandenburg, and Denmark, and in 1308 it fell into the hands of the Teutonic knights, under whose rule it long prospered. It was one of the four chief towns of the Hanseatic League. In 1453, when the Teutonic Order had become thoroughly corrupt, Dantzic shook off its yoke and submitted to the king of Poland, to whom it was formally ceded, along with the whole of West Prussia, at the Peace of Thorn. Although nominally subject to Poland, and represented in the Polish diets and at the election of Polish kings, it enjoyed the rights of a free city, and governed a considerable territory with more than thirty villages. It suffered severely through various wars of the 17th and 18th centuries, and in 1734, having declared in favor of Stanislas Leszczynski, was besieged and taken by the Russians and Saxons. At the first partition of Poland, in 1772, Dantzic was separated from that kingdom; and in 1793 it came into the possession of Prussia. In 1807, during the war between France and Prussia, it was bombarded and captured by Marshal Lefebvre, who was rewarded with the title of Duke of Dantzic; and at the Peace of Tilsit Napoleon declared it a free town, under the protection of France, Prussia, and Saxony, restoring to it its ancient territory. A French Governor, however, remained in it, and by compelling



Plan of Dantzic.

- |                              |                          |
|------------------------------|--------------------------|
| 1. Library.                  | 7. Government Buildings. |
| 2. St. Bartholomew's Church. | 8. St. Barbara's Church. |
| 3. St. Bridget's Church.     | 19. Town Hall.           |
| 4. St. Catharine's Church.   | 20. Barracks.            |
| 5. Old Armory.               | 11. New Armory.          |
| 6. St. Mary's Church.        |                          |

capital of West Prussia, is situated on the left bank of the Vistula, about three miles from its mouth, 253 miles north-

Prussia, and Saxony, restoring to it its ancient territory. A French Governor, however, remained in it, and by compelling

it to submit to the Continental system almost ruined its trade. It was given back to Prussia in 1814.

**DANUBE** (German, *Donau*; Hungarian, *Duna*; Latin, *Danubius*, or *Danuvius*, and in the lower part of its course, *Ister*), the largest river of Europe next to the Volga, traversing the southern part of Germany, Austria, Hungary, and the northern part of Turkey, and falling into the Black Sea after a course of about 1750 (or, including its windings, 2000) miles. Its basin, which comprises a territory of nearly 300,000 square miles, is bounded by the Black Forest, some of the minor Alpine ranges, the Bohemian Forest, and the Carpathian mountains on the north, and by the Alps and the range of the Balkan on the south. The Danube is generally considered to be formed by the union, at Donaueschingen, of the Brigach and the Brege, two mountain streams from the Black Forest; though a third stream, originating in a spring in the palace garden of Donaueschingen, at a height of about 2350 feet above the sea, is by some held to be the true source. It seems probable, according to the investigations of Professor Knop of Carlsruhe, that at Immdarlingen the infant river loses a good part of its waters in the fissures of the soil, and thus gives rise to the Aach, which flows south and joins the Rhine. After passing N. E. through the kingdom of Württemberg and part of Bavaria to Ratisbon, it turns to the S. E., and maintains that direction till it approaches Linz in Austria. From this town its course is in the main easterly to Hungary, which it enters a little above Presburg. From Presburg it flows S. E. through the lesser Hungarian plain to its confluence with the Raab, whence it runs E. to Waitzen. At Waitzen it turns S., and flows with a slow current and numerous windings through the greater plain of Hungary for nearly  $2\frac{1}{2}$  degrees of latitude. After its junction with the Drave it again takes a general S. E. direction to Orsova, where it leaves the Austrian territories by the famous pass of the Iron Gate, with once formidable rapids. From Orsova, its course is generally S. by E. to Kalafat, thence mostly E. by S. to Sistova; it there takes an E. by N. direction to Rassova, then turns N. to Galatz, and finally eastward to the Black Sea. Among its 400 tributaries, of which upwards of 100 are navigable, the principal are—on the right, the Iller, Lech, Iser, Inn, Ens, Raab, Drave, Save, Morava, Timok, Isker, Vid, and Jantra; and on the left, the Altmühl, Nab, Regen, March, Waag, Gran, Theiss, Temes, Chyl, Aluta, Jalomniza, Sereth, and Pruth. The Danube communicates with the Rhine by means of the Ludwigs-Canal, which unites the Altmühl with the Main, with the Elbe by means of the Moldau and other canals, and with the Theiss, its own tributary, by means of the Franzens-Canal. The upper course of the river is regularly frozen over all winter; and even the lower reaches are usually closed for a considerable period. According to a British consular report in 1873, the river at Galatz during the thirty-seven years from 1837 to 1873 remained open all winter only eight times, namely, in 1839, 1846, 1852, 1853, 1854, 1860, 1867, and 1873; the date of the complete freezing over varied from Dec. 7 to Feb. 14; and the breaking up of the ice occurred as early as Jan. 18, and as late as March 21. This last event always causes great anxiety to the inhabitants; for, if the thaw begins in the upper part of the stream, the waters rush down with tremendous fury, and frequently do incalculable damage. When such a catastrophe is apprehended, watchmen are stationed on eminences along the banks of the river, to give notice by alarm guns when the ice is broken.

At Ulm the Danube receives the Iller, and thus, at a height of 1400 feet above the sea, becomes navigable for flat-bottomed boats of 100 tons. From Donaauwörth to Passau it traverses the Bavarian plain, leaving which it intersects a mountainous region till it reaches Vienna. At Passau it is 800 feet above the level of the sea, and at Vienna 450. From Vienna to the mouth of the Drave it flows through an expanse of plain country, broken only in a few places, as at Presburg, Buda, and Waitzen. At Isakcha the channel is 1700 feet broad and 50 feet deep. At extreme low water the total current is 70,000 cubic feet per second, at ordinary low water 125,000, at ordinary high water 324,000 and during extraordinary flood 1,000,000, and thus, on a general average from the observations of 10 years, 207,000 feet per second. The total amount of alluvium annually carried down by the river is calculated at 67,760,000 cubic feet; and, according to M. Desjardins, the

advance of the coast thus produced during the Christian era is about 9 or 10 miles. About 15 miles below Isakcha the river breaks up into two branches, of which the northern or Kilia branch forms an irregular network of channels on its way to the sea, and, after reuniting into one, gives rise to a secondary delta with nine or ten arms; while the southern or Tultcha branch subdivides before long into the central or Sulina branch and the southmost or St. George's. The delta thus formed comprises an area of about 1000 square miles, almost totally destitute of cultivation, and broken in all directions by swamps and fresh-water lakes. Of the total burden of the river it was calculated in 1857 that the Kilia branch carried down seventeen twenty-sevenths, the Sulina branch two twenty-sevenths, and the St. George's eight twenty-sevenths; but since that date the Tultcha St. George's branch has grown shallower, and the volume of the Kilia has increased to about eighteen twenty-sevenths, or two-thirds of the whole discharge.

In the course of the present century a good deal has been done to render the Danube more available as a means of communication. In 1816 Austria and Bavaria made arrangements for the common utilization of the river; and since then both Governments have been liberal in their outlays for its improvement. In 1830 steamboats were introduced between Vienna and Pesth, under the encouragement of Count Szechenyi, a steamboat company having been started in 1823 by two Englishmen, Andrews and Prichard. In 1834 the boats descended as far as Orsova, and in 1835 they began to reach Galatz. About the same time the draining of the Donaumoos, between Neuburg and Ingolstadt, which had been commenced in 1791, was successfully prosecuted. In 1844 the Ludwigs-Canal was completed at a cost of 400,860,000 dollars; and in 1845 and 1853 the removal of the rocks which still, in spite of the labors of Joseph II., obstructed the river below Grein was finally achieved. In 1866 an imperial commission was established for the rectification of the river bed in the neighborhood of Vienna; and the proposal to construct a new channel, supported by the engineers Abernethy and Sexauer, was ultimately chosen as the most promising scheme. In terms of the Peace of Paris, March, 1856, the river not only was placed under the protection of international law, and declared free to the ships of all nations, but a commission was constituted in November of that year for the purpose of putting the deltaic portion in the best possible state for navigation. It took the title of "European Commission of the Danube," and consisted of the following representatives of the seven powers who had signed the treaty:—the Chevalier de Becke for Austria, Major Stokes, R. E., for England, Monsieur Engelhardt for France, Herr Bitter for Prussia, Baron d'Offenburg for Russia, the Marquis d'Aste for Sardinia, and Omar Fetzi Pasha for Turkey. Sir Charles Hartley was appointed engineer-in-chief. The commission fixed its seat at Galatz, and began its labors by establishing an engineering factory and dépôt at Tultcha, and constructing a telegraph line between Sulina, Tultcha, and Galatz; but, after a discussion which lasted from December, 1857, to April, 1858, the delegates could not come to an agreement in regard to the relative claims of the St. George's and the Sulina mouths, and had to refer the question to their respective Governments. A technical commission appointed by France, England, Prussia, and Sardinia decided unanimously in favor of St. George's, but recommended, instead of the embankment of the natural channel, the formation of an artificial canal closed by sluices at its junction with the river, and reaching the sea at some distance from the natural embouchure. The choice of St. George's made by this commission was adopted at Galatz in December, 1858, and six of the seven representatives voted for the canalization; but, owing to various political and commercial considerations, it was ultimately decided to do nothing more in the meantime than render permanent and effective the provisional works already commenced at the Sulina mouth. These consisted of two piers, forming a seaward prolongation of the fluvial channel, and had been commenced in 1858, according to Sir Charles Hartley's plan calculated for a period of six or eight years. In their permanent form they were completed on 31st July, 1861, having required for their construction 200,000 tons of stone, and 12,500 piles. The northern pier had a length of 4631 feet, the southern of 3000, and the depth of water in which they were built varied from 6 feet to 20 feet. At

the commencement of the works the depth of the channel was only 9 feet, but by their completion it had increased to 19 feet. Ten years afterwards it was found expedient to make the total length of the piers 5332 and 3457 feet. Various minor rectifications of the channel were also effected, and in 1865 a lighthouse was established in 44° 51' N. lat. and 29° 36' 32" E. long. The expenses of 1857, 1858, 1859, and part of 1860 were provided by the Ottoman Empire; but since that year the commission has been mainly indebted to a tax on the shipping of the river. Of what value the works of Sulina have proved may be shown by the fact that of 2928 vessels navigating the lower Danube in 1855, 36 were shipwrecked, while of 2676 in 1865 only 7 were thus unfortunate. By the treaty of March 13, 1871, signed at London by the seven powers, the commission is to exist for twelve years, and the works accomplished under its superintendence are declared permanently neutral. It is independent of the Roumanian Government, and has various sovereign powers over the Danube below Isakcha, such as the control of the police, the collection of taxes, and the disposal of its revenue. The same treaty authorizes the permanent commission of riparian states (Austria, Bavaria, Württemberg, Turkey, Moldavia, Wallachia, and Servia), which commenced its labors at Vienna in 1856, to collect a tax from all the vessels navigating the river, in order to pay the expenses of the proposed removal of the obstructions that still render dangerous the passage of the Iron Gate.

*Literature.*—Mariglius, *Danubius Pannonico-Mysicus*, The Hague, 1726; Schulte's *Donaufahrten*, 1819-29; Planche, *Descence de la Danube*, 1823; Szechenyi, *Ueber die Donauschiffahrt*, 1836; A. Müller, *Die Donau vom Ursprunge bis zu den Mündungen*, 1839-41; J. G. Kohl, *Austria, the Danube, etc.*, London, 1844, and *Die Donau*, Trieste, 1853-4; G. B. Rennie, *Suggestions for the Improvement of the Danube*, 1856; Sprat, *Report on the Delta of the Danube*, 1857; Sir C. A. Hartley, *Description of the Delta of the Danube*, 1862; Wallace, *Auf den Donau von Wien nach Constantinopel*, Vienna, 1864; *Mémoire sur le Régime Administratif établi aux embouchures du Danube*, Galatz, 1867; *Mémoire sur les travaux d'amélioration*, 1867; Desjardins, *Rhône et Danube*, Paris, 1870 (a defence of the canalization scheme); Sir C. A. Hartley, *Description of the Delta of the Danube*, 1874; *Carte du Danube entre Braila et la Mer*, Leipzig, 1874, published by the European Commission; Peters, *Die Donau und ihr Gebiet*, 1876. (H. A. W.)

DANVERS, a town of the United States, in the county of Essex, in Massachusetts, about two miles from Salem and fifteen miles N. N. E. of Boston, with which it is connected by rail. The principal industry is the manufacture of boots and shoes, which employs a large proportion of the inhabitants, and annually puts into the market upwards of a million pairs. There are also brickyards, tanneries, and a carpet factory. The most interesting building is the Peabody Institute, with its library and art-collections, founded in 1852 by George Peabody, the philanthropist, who was born at Danvers in 1795. Population in 1870, 5600.

DANVILLE, a town of the United States, the administrative centre of Montour county, Pennsylvania, is situated on the north branch of the Susquehanna river, fifty miles north-east of Harrisburg. To its position in the neighborhood of Montour Ridge, with its abundant supplies of iron ore, anthracite, and limestone, it owes its prosperity as one of the principal seats of the iron trade. The railroad iron of the Montour Iron Works is specially celebrated. The town was founded about 1780. Its population in 1870 was 8436.

DANVILLE, a city of the United States, the administrative seat of Vermilion county, Illinois, on the Vermilion river, a tributary of the Wabash, about 125 miles south of Chicago. Situated in a rich and populous district, in the vicinity of an extensive coal-field, and well supplied with building materials and water, it forms a flourishing manufacturing centre with foundries, wagon works, locomotive works, and various other industrial establishments. It was founded in 1828, and in 1873 had about 7000 inhabitants.

D'ANVILLE, JEAN BAPTISTE BOURGUIGNON (1697-1782), a French geographer of the highest eminence, was born at Paris on the 11th July, 1697. His passion for geographical research displayed itself from his earliest years. At the age of twelve, while reading the Latin authors at college, he amused himself with drawing maps of the countries which they described. While he was thus busily employing himself one day in the class, his master

observed and was about to punish him; but upon casting his eye upon the performance, he immediately judged him to be deserving rather of encouragement. After leaving college he derived much instruction from intercourse with the Abbé Longuerue, the celebrated antiquarian. D'Anville from this time devoted himself entirely to geography, particularly that of the ancient world. His first map, that of Ancient Greece, was published when he was fifteen, and at the age of twenty-two he was appointed one of the king's geographers, and began to delineate maps which attracted the attention of the most eminent authorities.

The course of study on which D'Anville entered was of great extent. Works professedly geographical formed the least part of it; those of all the ancient and modern historians, travellers, narrators of every description, were assiduously examined. He studied also the philosophers, orators, and poets, but only for the sake of the occasional geographical lights which they afforded, for it was remarked that in perusing their works he was totally indifferent to everything which did not tend to fix a geographical position. The object of this immense labor was to effect a complete reform in the science of geography by banishing the system of copying blindly from preceding maps, and never fixing a single position without a careful examination of all the authorities upon which it rested. By this process he detected many serious errors in the works of his most celebrated predecessors, while his own accuracy was soon attested on all sides by the travellers and mariners who had taken his works as their guide. His principles led him also to another innovation, which was that of omitting every name for which there existed no sufficient authority. Vast spaces, which had before been covered with countries and cities, were thus suddenly reduced to a perfect blank; but it was speedily perceived that this was the only accurate course, and that the defect lay in the science, not in the geographer.

D'Anville was at first employed in the humbler task of illustrating by maps the works of different travellers, such as Marchais, Charlevoix, Labat, and Duhalde. For the history of China by the last-named writer he was employed to make an atlas, which was published by itself at the Hague in 1737. The question respecting the figure of the earth coming to be much agitated, he published in 1735 and 1736 two treatises, with a view to illustrate it. But this attempt to solve a geometrical problem by historical materials was eminently unsuccessful. Maupertuis having gone to measure a degree within the polar circle, the result was found directly opposite to D'Anville's prediction. Any loss of reputation which this failure might have occasioned was completely retrieved by his map of Italy, published in 1743. It was marked by a method of investigation often employed by D'Anville with peculiar success, which consisted in the application of ancient materials to correct the existing geography. By the diligent study of the Latin authors he was enabled to trace numerous errors which had crept into the delineation of that country. A trigonometrical survey which Pope Benedict XIV. almost immediately after caused to be made in the States of the Church confirmed, in a surprising degree, all these alterations. On this occasion he first set the example of accompanying the map with a memoir exhibiting the data on which it had been constructed.

He now applied himself to ancient geography, always his favorite department, the aspect of which, under his hands, was soon completely changed. He illustrated successively, by maps, all the countries known to the ancients, among which Egypt attracted his peculiar attention. To render these labors more extensively useful, he published in 1768 his *Géographie Ancienne Abrégée*, of which an English translation, entitled *Compendium of Ancient Geography*, appeared in 1791. His attention was finally turned to the Middle Ages, which were illustrated by his *États formés en Europe après la Chute de l'Empire Romain en Occident* (1771), and by some other works equally learned. Entirely devoted to geographical inquiries, the appearance of his successive publications formed the only events by which his life was diversified. From causes which are not explained, he was late in being admitted into the literary societies. In 1754, at the age of sixty, he became a member of the Academy of Inscriptions and Belles Lettres, whose transactions he enriched with many papers. In 1775 he received the only place in the Academy of Sciences which is allotted to geography; and in the same

year he was appointed, without solicitation, first geographer to the king. But these honors came too late to gladden a life which was now drawing to its utmost verge. His last employment consisted in arranging his collection of maps, plans, and geographical materials. It was the most extensive in Europe, and had been purchased by the king, who, however, left him the use of it during his life. The task performed, he sunk into a total imbecility both of mind and body, which continued for two years, and ended only with his death in January, 1782.

D'Anville's published memoirs and dissertations amounted to 78, and his maps to 211. A complete edition of his works was announced in 1806 by De Manne in 6 vols. quarto, only two of which had appeared when the editor died in 1832. See Dacier's *Éloge de D'Anville* (Paris, 1802).

DAPHNE, in Greek mythology, was the daughter of a river-god, usually the Arcadian Ladon, sometimes the Thessalian Peneus, her mother being Gea, the goddess of the earth. As usual with nymphs of springs or rivers she was pursued by lovers,—first by Leucippus, a son of Ænomus, who disguised himself as a girl to be able to follow her better, but was discovered and killed by the nymphs with Daphne, and secondly by Apollo, from whom she escaped, being transformed into a laurel tree (*δάφνη*).

DAPHNEPHORIA, a festival held every nine years at Thebes, in Bœotia, in honor of Apollo, consisting of a procession in which the chief figure was a boy chosen on each occasion for his beauty and strength, who at the same time was of a good family and had both parents alive. He was styled Daphnephoros "laurel-bearer." In front of him walked one of his nearest relatives, carrying an olive branch hung with laurel and flowers and having on the upper end a bronze ball from which hung several smaller balls. Another smaller ball was placed on the middle of the branch or pole, which was then twined round with purple ribbons, and at the lower end with saffron ribbons. These balls were said to indicate the sun, stars, and moon, while the ribbons referred to the days of the year, being 365 in number. This object was called the Kopo. The Daphnephorus, wearing a golden crown, or, as Pausanias (ix. 10, 4) says, a wreath of laurel, richly dressed and partly holding the Kopo, was followed by a chorus of maidens carrying suppliant branches and singing a hymn to the god. The Daphnephoros dedicated a bronze tripod in the temple of Apollo, and Pausanias (*loc. cit.*) mentions the tripod dedicated there by Amphitryon when his son Hercules had been Daphnephoros.

DARABJIRD, or DARAB-GHERA, a city of Persia in the province of Farsistan, 140 miles south-east of Shiraz. It is situated in a very fertile district at the foot of mountains, and is embellished by luxuriant orchards of orange, lemon, and date trees. Though greatly fallen from its former prosperity, it is still one of the most important cities of the province. Its name signifies the city or residence of Darius, and by Von Hammer it was identified with the ancient Pasargade. In the neighborhood there are various remains of antiquity, the most important of which, 3½ miles to the south, is known as the Khaleh-Darâb, or citadel of Darius, and consists of a series of earthworks arranged in a circle round an isolated rock. Nothing remains, however, to fix the date or explain the history of the fortification. Another monument of the vicinity is a gigantic bas-relief carved on the vertical face of a rock, apparently representing the victory of Sapor I. of Persia over the Emperor Valerian. A full description of both will be found in Flandin, *Voyage en Perse*, vol. ii.

DARANG. See DURANG.

D'ARBLAY, MADAME (1752—1840). Frances Burney, daughter of Charles Burney, D.Mus., was born at Lynn Regis, in Norfolk, 1752. Her mother was a Miss Esther Sleepe, distantly of French descent. In 1760 the Burneys moved to London; and in 1761 Mrs. Burney died, leaving six children, of whom Fanny, the third, was but nine years old. Her sisters were sent to school, but she, as she tells us herself, "never was placed in any seminary, and never was put under any governess or instructor whatsoever." At ten years old she had taught herself to read and write, and became an incessant scribbler both of prose and verse, and ardently fond of reading. Six years after his wife's death Dr. Burney married again; and from her fifteenth year onwards Fanny lived in the midst of an exceptionally brilliant social circle, gathered round her father in his house in St. Martin's Street, Leicester Fields, which in-

cluded the chief musicians, actors, and literary men of the day, and not a few of his aristocratic patrons. Her father's drawing-room was in fact Fanny's only school, and not a bad one. Her stepmother, although a spirited and sensible woman, did not encourage Fanny's habits of scribbling, which she considered dangerously unfeminine. Fanny, therefore, when she was fifteen, solemnly burnt all her manuscripts,—among them *The History of Caroline Evelyn*, a story of which her first published novel, *Evelina*, was the sequel. At the same time she began her famous *Diary*, which extended over seventy-two years of her life. She was not much more than fifteen when she planned the story of *Evelina*; but it was not written till some years later, and was not published till the year 1778, when its authoress was six-and-twenty. Having, she tells us, an "odd inclination" to see her work in print, she confided her secret to her sisters, copied out part of her manuscript in a feigned hand, and persuaded her younger brother, Charles, to be her agent with the booksellers, the interviews being held at a coffee-house in the evening, and young Charles being disguised in a big cloak and hat for the purpose. Dodaley refused her MS. as anonymous, but Lowndes, after its completion, accepted it, and gave her £20 for it. Dr. Burney was told of what was going on, and good-naturedly favored his daughter's whim, without so much as asking the name of her book. *Evelina*, or *a Young Lady's Entrance into the World*, was therefore published quite clandestinely, and Miss Burney herself knew the event only through an advertisement in the papers, while it had been six months in print, and had been reviewed and praised everywhere, before her father held the three little volumes in his own hand. Dr. Burney proudly told Mrs. Thrale the secret of the authorship, and Miss Burney was at once taken to Streatham, and admitted into a coterie of which Johnson was the great centre. Her fame spread. Johnson had declared that there were passages in *Evelina* which might do honor to Richardson; Sir Joshua Reynolds could not be persuaded to eat till he had finished the story; and Burke had sat up all night to read it. Miss Burney was introduced to Mrs. Montagu and the *Basbleus*, to Sheridan, who wanted her to write for the stage, and to her special admirers Mrs. Cholmondeley and the beautiful Mrs. Bunbury. But the chief feature in her early literary life was Dr. Johnson's friendship for her, which excited the jealousy of Boswell, and ended only with Johnson's death. The second story, *Cecilia*, or *Memoirs of an Heiress*, in five volumes, 1782, greatly increased her popularity, and brought her a letter from Burke, in which he said, "In an age distinguished by having produced extraordinary women, I hardly dare to tell you where my opinion would place you amongst them." In 1786, through the influence of the good old Mrs. Delany, known as the correspondent of Swift and Young, Miss Burney obtained the post of second keeper of the robes of Queen Charlotte, consort of George III., with a salary of £200. For five years (from her thirty-fourth to her thirty-ninth year) it was her duty to attend at the queen's daily *toilettes*, to take care of her lap-dog and her snuff-box, to read to her now and then, and to preside over the tea-table of the equeries. Her *Diary and Letters* of this time abound in amusing court gossip; but the post was an uncongenial one, and she resigned it in 1791 on account of ill-health. The queen allowed her a pension of £100 a year, the king saying, "It is but her due; she has given up five years of her pen." In 1793 Miss Burney became the wife of M. D'Arblay, a French officer of artillery, who, with Madame de Staël, Talleyrand, and other refugees, lived at "Juniper Hall," Dorking. In the same year she published a pamphlet on the emigrant French clergy. Her only child, afterwards the Rev. A. D'Arblay, was born in 1794; and in 1795 appeared her third novel, *Camilla*, or *a Picture of Youth*, in five vols. This book was published by subscription, and brought her more than £3000. From 1802 to 1812 Madame D'Arblay was in France with her husband and son, and in 1814 she published *The Wanderer*, or *Female Difficulties*, another five-volume story, a comparative failure, though at the time it realized £1500. Madame D'Arblay was in France and Belgium through the war of 1814—15, her husband having regained the post of *maréchal de camp*, which he had formerly held under Louis XVI. They returned to England, and General D'Arblay died at Bath in 1818.

In Sir Walter Scott's diary for November 18, 1826, he

describes his being taken to see Madame D'Arblay by Mr. Rogers, and says, "I have been introduced to Madame D'Arblay, the celebrated authoress of *Evelina* and *Cecilia*,—an elderly lady, with no remains of personal beauty, but with a simple and gentle manner, and pleasing expression of countenance, and apparently quick feelings." In 1832, when she was eighty years of age, Madame D'Arblay published the memoirs of her father, who died in 1814. This book, the rambling recollections of an old lady, is full of imperfections and extraordinary affectations of style. Madame D'Arblay died at Bath, 1840, aged eighty-eight, and her *Journal and Letters* were edited by her niece, and published in seven volumes, 1842-6.

Madame D'Arblay was not remarkable for personal beauty. She was small, retiring, and rather prudish, delighting to be lionized, while she dreaded nothing more than to be thought unfeminine or eccentric. Her style in writing was considered remarkable for its sprightliness and humor. Some of her most vivid characters were extremely popular. "You are a perfect *Broughton*!" exclaimed Dr. Johnson, when Boswell was about to quit Mrs. Thrale's table before the guests had finished eating. And Miss Burney tells us how "the Doctor" was one day seen laughing to himself, and suddenly turned to her, quoting from *Evelina*, with "Only think, Polly, Miss has danced with a lord!" Her best character-sketches and most spirited dialogues are, however, to be found, not in her novels, but in her *Journal and Letters*. The drawback of everything which she wrote of an autobiographic kind was her painful self-consciousness and astounding egotism. It was her great ambition to write for the stage. She made three attempts to write a play; and her tragedy, entitled *Edwy and Elgiva*, was acted by Mrs. Siddons and Kemble at Drury Lane in 1795, but had to be withdrawn as a failure, and was never printed. (F. M.)

DARBOY, GEORGES (1813-1871), archbishop of Paris, was born at Fayl-Billot, in Haute-Marne, on the 16th January, 1813. He studied with distinction at the seminary at Langres, and was ordained priest in 1836. After filling a charge at St. Dizier, near Vassy, he was appointed in 1839 professor of philosophy at Langres, and in 1841 he was transferred to the chair of dogmatics. A change in the direction of the seminary caused him to leave for Paris, where in 1846 he was appointed almoner of the college of Henry IV. and honorary canon of Notre Dame. The confidence thus shown in him by Archbishop Affre was continued by Archbishop Sibour, who appointed him editor of the *Moniteur Catholique*. In November, 1854, the archbishop took Darboy with him to Rome and presented him to the Pope, who gave him the rank of protonotary apostolic. In 1855 he became titular vicar-general of Paris, and inspector of religious instruction in the various schools of the diocese. He was appointed bishop of Nancy in 1859, and in January, 1863, he was raised to the archbishopric of Paris. The favor of the court was indicated by his appointment to the post of grand almoner to the emperor in 1866, and to that of grand officer to the Legion of Honor in 1868. The archbishop was a strenuous upholder of episcopal independence in the Gallican sense, and involved himself in a controversy with Rome by his endeavors to suppress the jurisdiction of the Jesuits and other religious orders within his diocese. At the Vatican Council he vigorously maintained the rights of the bishops, and offered a decided opposition to the infallibility dogma, against which he voted as inopportune. When the dogma had been finally adopted, however, he was one of the first to set the example of submission. Immediately after his return to Paris the war with Prussia broke out, and his conduct during the disastrous year that followed was marked by a devoted heroism which has secured for him an enduring fame. He was active in organizing relief for the wounded at the commencement of the war, remained bravely at his post during the siege, and refused to seek safety by flight during the brief triumph of the commune. On the 4th April, 1871, he was arrested by the communists as a hostage, and confined in the prison at Mazas, from which he was transferred to La Roquette on the advance of the army of Versailles. On the 27th May, he was shot within the prison along with several other distinguished hostages. He died in the attitude of blessing and uttering words of forgiveness. His body was recovered with difficulty, and having been embalmed was buried with imposing ceremony at the public expense on the 7th June.

It is a noteworthy fact that Darboy was the third archbishop of Paris who perished by violence in the period between 1848 and 1871. Darboy was the author of a number of works, of which the most important are a *Vie de St. Thomas Becket* (1859), a translation of the works of St. Denis the Areopagite, and a translation of the *Imitation of Christ*.

DARDANELLES, the ancient Hellespont, and in Turkish *Bahr-Sefed Boghazi*, the strait uniting the Sea of Marmora with the *Ægean*, so called from the two castles by which the narrowest part is protected, and which preserve the name of the city of Dardanus in the Troad, famous for the treaty between Sulla and Mithridates in 84 B. C. Its shores are formed by the peninsula of Gallipoli on the N.W. and by the mainland of Asia Minor on the S.E.; and it extends for a distance of about 47 miles with an average breadth of 3 or 4 miles. At the *Ægean* extremity stand the castles of Sedil Bahr and Kum Kaleh, the former in Europe and the latter in Asia; and near the Marmora extremity are situated the important town of Gallipoli (Kallipolis) on the northern side, and the less important though equally famous Lamsaki, or Lampeaca, on the southern. The two castles of the Dardanelles *par excellence* are Chanak-Kalesi, Sultanieh-Kalesi, or the Old Castle of Anatolia, and Kiliid-Bahr, or the Old Castle of Rumelia, which were long but erroneously identified with Sestos and Abydos, now located farther to the north. The strait of the Dardanelles is famous in history for the passage of Xerxes by means of a bridge of boats, and for the similar exploit on the part of Alexander. Nor is its name less widely known from the story of Hero and Leander, and from Lord Byron's successful attempt to rival the ancient swimmer. The passage of the strait is easily defended, but in 1807 the English Admiral Duckworth made his way past all the fortresses into the Sea of Marmora. In terms of the treaty of July, 1841, confirmed by the Paris peace of 1856, no foreign ship of war may enter the strait except by Turkish permission, and even merchant vessels are only allowed to pass the castle of Chanak-Kalesi during the day. For details regarding the currents of the Dardanelles, see BLACK SEA, vol. iii. p. 692.

DARDANUS, in Greek mythology, is said to have crossed over from Samothrace to the Troad by swimming on an inflated skin, and to have there founded the kingdom of Dardania previous to the existence of Troy. Apparently this was invented to account for the existence in the Troad of a worship of the Cabiri similar to that of Samothrace. Dardanus is called a son of Zeus and the Pleiad Electra, and in the *Iliad* (x. 304) Zeus is said to have loved him more than his other sons.

DARES, a Trojan priest of Hephestus, who lived at the time of the Trojan war, and to whom was attributed an ancient account of that war which was extant in the time of *Ælian*. A work in Latin, purporting to be a translation of this account, and entitled *Dareti Phrygii de Bœcidiis Trojæ Historia*, was much read in the Middle Ages, and was then ascribed to Cornelius Nepos; but the language is extremely corrupt, and it belongs to a period much later than the time of Nepos. It is commonly published together with the work of Dictys Cretensis. See the edition (which has an essay upon Dares) by A. Dederich, who is inclined to ascribe the work to a Roman of the 5th, 6th, or 7th century (Bonn, 1837).

DARFUR, or DARFOR, *i. e.*, the land of the Fur or For, a country of the Soudan in Africa, formerly an independent kingdom, but in 1874 conquered and incorporated by Egypt. It extends from 9° to 16° N. lat., and from 25° 30' to 28° 30' E. long., thus including an area of about 105,000 square miles, with a population roughly estimated at four millions. On the W. it would be conterminous with Wadai were it not for a strip of independent territory; on the N. it passes off into the desert of Sahara; on the E. it is separated from Kordofan by a barren steppe; and on the S. it is bounded by Darferit and several petty states.

The centre of the country is occupied by the Marra Mountains, which lift their granite peaks to a height of 3500 or 4000 feet, and extend about 180 miles from north to south, with an average breadth of 70 miles. The northern portion of the range is also known as the Kerakeri Mountains, on account of the huge boulders with which their flanks are strewn; the southern portion turns to the west and takes the name of Jebel Zerlai. On all sides this

mountain-mass is channelled by numerous wadis, which for the most part dry up in the hot season, but in many cases measure from 200 to 300 paces in breadth. Of these the most important (as the Sunot, and the Azum, with their numerous affluents) have a south-west direction, and ultimately contribute their waters to the Bahar-es-Salamat, which passes westward through Wadal. Some of those that rise in the eastern slopes seem to find their way to the Bahr-el-Arab; but the greater number are absorbed or stop short in their course.

The climate, except in the south, where the rains are unusually heavy and the soil is a damp clay, is regarded as healthy. The rainy season lasts for three months, from the middle of June to the middle of September. In the neighborhood of the wadis the vegetation is fairly rich, but elsewhere it is rather scant and steppe-like. The prevailing trees are the acacias—more particularly the *hazara* and the *Acacia nilotica*—the hachub, the sayal, the kittir, the hommed, the jakjak, and the makhtit; while the sycamore, the ochar, the hadjilidj, and, in the Marra Mountains, the *Euphorbia candelabrum* are also to be found. In the highlands the culture of wheat, elsewhere so rare in Central Africa, is pretty extensive; but doukhn (*Penicillaria*) and dura are the usual cereals. In the south and west onions, pepper, bananas, citrons, and various fruits are grown freely; and in several places an indigenous kind of tobacco of great strength is cultivated. The deleb palm is abundant in the south, and on the eastern frontiers the monkey-bread or baobab compensates for the deficiency of water.

Copper is obtained in sufficient quantity to make it a matter of export; antimony was worked in the time of Mohammed-el-Fadhli; lead occurs in Gebel Kuttum in the Dar el Gharb; iron is wrought in the south-west province; and deposits of rock-salt are met with in various places.

Cattle, sheep, and camels are both numerous and of excellent breeds. Horses are comparatively rare; and, with the exception of those imported from Dongola, they belong to a small but sturdy native race. The elephant has been exterminated; but the ostrich is common in the east in the country of the Hamr Arabs.

The population of Darfur is of very varied origin. The *Fur* occupy the central highlands and part of the Dar Dima and Dar Uma districts, speak a special language, and are subdivided into numerous tribes, of which the most influential are the Dugunga, the Kanjara, and the Kera. They are of middle height, have rather irregular features, and display a disagreeable character. Dr. Nachtigal found them proud, treacherous, and very ill-disposed to strangers; but it must be remembered that he had to encounter not only the religious antipathy of Mahometan bigotry against a Christian, but also the political antipathy of irritated national feeling against a supposed Egyptian. The *Massabdi* are a tribe which, breaking off from the *Fur* some centuries back, are now largely mingled with Arab blood, and use the Arabic language; while, on the contrary, the *Tanjur* are an Arab tribe which must have arrived in the Soudan at a very early date, as it has incorporated a large Furian element, and no longer professes Mahometanism. The *Dadjo* formerly inhabited Mount Marra, but they have been driven to the south and west, where they maintain a certain independence in Dar Sula, but are treated as inferiors by the *Fur*. The *Zoghawa*, who inhabit the northern borders, are on the contrary regarded by the *Fur* as their equals, and have all the prestige of a race that at one time made its influence felt as far as Bornu. As holding a less important place in the population may be mentioned the *Berti*, the *Birgirid*, the *Beraunas*, the *Fellatas*, the *Jel-labas*, and immigrants from Wadal, *Baghirmi*, etc. Genuine Arab tribes are numerous, and they are partly nomadic and partly fixed. The country was divided under the "Sultan" into the five provinces of Dar Tokofani or the northern province, Dar Dali or the eastern, Dar Uma or the southern, Dar Dima or the south-western, and Dar el Gharb or the western, each governed by a separate chief with the exception of the last, which stood directly under the authority of the king. Each province was subdivided into so many departments, and each department was under the control of a *shertaya* (plural, *sheratis*). The central district of the Marra Mountains, called Dar Torra, was under a special *shertaya*, dependent on the king; and the western slopes, which form the most fertile tract in the whole country, belonged to the king and the members of the royal

family. The most important towns are Kobe and Kabkaba, on the caravan-route across the north of the country.

*History.*—Of the *Dadjo* dynasty, which appears to have been dominant in the Marra mountains, no history has been left except a list of royal names. Next succeeded the *Tanjur* dynasty—Ahmed-el-Magur, Saref, Kuni, Bate, Rufa's, and Shaou. From the marriage of Rufa's with the daughter of the chief of the Kera tribe sprang Dali or Dalil, who founded the Furian kingdom, divided the country into provinces, and established a penal code, which, under the title of *Kitab Dali* or Dali's Book, is still preserved, and shows principles essentially different from those of the Koran. His grandson Soleiman (usually distinguished by the Furian epithet *Solon*, the Arab of the Red) reigned from 1596 to 1637, and was a great warrior and a devoted Mussulman. Soleiman's grandson Ahmed Bokr (1682–1722) made Islam the religion of the state, and increased the prosperity of the country by encouraging immigration from Bornu and Baghirmi. His rule extended as far east as the Nile, or even to the banks of the Atbara. The next occupant of the throne, Daura or Darut, is infamous for his cruelty; and the capture of his successor Omer Lele during a war with Wadal saved the country from an equally detestable tyrant. Abu-el-Ghassem, the next monarch, was lost in a battle against the same enemy, and when after a time he reappeared amongst his people, he was put to death by Mahommed Tirab, who had meanwhile ascended the throne. Abd-er-Rahman surnamed el-Raschid or the Just, a poor priest of great learning and piety, was chosen king instead of Tirab's son Ishaga, and though revengeful and fond of intrigue, he proved himself on the whole not unworthy of the choice. It was during his reign that Napoleon was campaigning in Egypt; and the European potentate responded in 1799 to the congratulatory address of his barbarian ally by an order for the despatch of 2000 black slaves upwards of 16 years old, strong and vigorous. To Abd-er-Rahman likewise is due the present situation of the *Fasher*, or royal township, near the Rahat (or Lake) Tendelti. Mahommed-el-Fadhli, his son, was for some time under the control of an energetic eunuch, Mahommed Kurra; but he ultimately made himself independent, and his reign lasted till 1839, when he died of leprosy, leaving behind him the fame of a violent and blood-thirsty tyrant, who had been disgraced by the loss of the important province of Kordofan. Of his 40 sons the third, Mahommed Hassin, was appointed his successor. He is described as a religious but avaricious man. The chief events of his reign were his fourteen expeditions against the Rasagat Arabs, the whole result of which was that the last years of his life were spent in fairly peaceful terms with that restless tribe. He died in 1873, blind, and advanced in years, and the succession passed to his youngest son Ibrahim, who soon found himself engaged in a conflict with Egypt, which resulted in the destruction of the kingdom. He was slain in the battle of Menovatchi, in the autumn of 1874, and his uncle Hassab Alla, who sought to maintain himself, was captured in 1875 by the troops of the Khedive, and removed to Cairo with his family.

*Exploration.*—The first European traveller who visited Darfur was James Browne, who spent two years at Kobeyh or Cobbe, at that time the capital. The next addition to our knowledge was due to the Sheikh Mahommed-el-Tounsy, who travelled in 1803 through the north of Africa in search of Omar, his father, and afterwards gave to the world an account of his wanderings, which was translated into French in 1845 by M. Perron. Dr. Nachtigal, in 1873, spent some months at Tendelti; and since the incorporation with Egypt, the country has been reconnoitred by Purdy and other Egyptian generals.

See Count D'Escazyrac de Lanture, *Notices sur le Darfur*, 1859, Nachtigal's communications to the *Bulletin de la Société de Géographie*, March, 1846, and to Petermann's *Mittheilungen*, 1875; Behm's *Geographisches Jahrbuch*, 1876.

DARIEN, a district of South America, of special interest in the history of geographical discovery, which gives its name to the great inlet of the Colombian coast otherwise known as the Gulf of Uraba, and to the great neck of land more familiarly designated the Isthmus of Panama. It was first reconnoitred in the first year of the 16th century by Rodrigo Bastidas of Seville; and the first settlement was Santa Maria del Antigua, situated on the small Darien river, north-west of the mouth of the Atrato. In 1513 Vasco Nufiez Balboa stood "silent upon a peak in Darien," and saw the Pacific at his feet stretching inland in the Gulf of San Miguel; and ever since that date this narrow stretch of terra-firma has alternately seemed to proffer and refuse a means of transit between the two oceans. The first serious attempt to turn the isthmus to permanent account as a trade-route dates from the beginning of the 18th century, and forms an interesting chapter in Scottish history. In 1695 an Act was passed by the Scottish Parliament for a company trading to Africa and the Indies; and this company, under the advice of one of the most re-

markable economists of the period,—William Paterson, a Scotchman, and the founder of the Bank of England,—determined to establish a colony on the Isthmus of Darien as a general emporium for the commerce of all the nations of the world. The project was taken up in Scotland with the enthusiasm of national rivalry towards England, and the "subscriptions sucked up all the money in the country." On the 26th of July, 1698, the pioneers set sail from Leith amid the cheers of an almost envious multitude; and on the 4th of November, with the loss of only fifteen out of 12,000 men, they arrived at Darien, and took up their quarters in a well-defended spot, with a good harbor and excellent outlook. The country they named New Caledonia, and two sites selected for future cities were designated respectively New Edinburgh and New St. Andrews. At first all seemed to go well; but by and by lack of provisions, sickness, and anarchy reduced the settlers to the most miserable plight; and in June, 1699, they re-embarked in three vessels, a weak and hopeless company, to sail whithersoever Providence might direct. Meanwhile a supplementary expedition had been prepared in Scotland; two vessels were dispatched in May, and four others followed in August. But this venture proved even more unfortunate than the former. The colonists arrived broken in health; their spirits were crushed by the fate of their predecessors, and embittered by the harsh fanaticism of the four ministers whom the General Assembly of the Church of Scotland had sent out to establish a regular presbyterial organization. The last addition to the settlement was the company of Captain Campbell of Finab, who arrived only to learn that a Spanish force of 1500 or 1600 men lay encamped at Tubacanti, on the River Santa Maria, waiting for the appearance of a Spanish squadron in order to make a combined attack on the fort. Captain Campbell, on the second day after his arrival, marched with 200 men across the isthmus to Tubacanti, stormed the camp in the night-time, and dispersed the Spanish force. On his return to the fort on the fifth day he found it besieged by the Spaniards from the men-of-war; and, after a vain attempt to maintain its defence, he succeeded with a few companions in making his escape in a small vessel. A capitulation followed, and the Darien colony was no more. Of those who had taken part in the enterprise only a miserable handful ever reached their native land.

See J. H. Burton, *The Darien Papers* (Bannatyne Club, 1849), and *History of Scotland*, vol. viii., also the article "CANAL," vol. iv., p. 700.

DARIUS I., the son of Hystaspes, was the true consolidator of the Persian empire. His administrative ability founded a new type of government, and organized the crude mass of conquered states bequeathed him by his predecessors. His military talents, though considerable, have been thrown into the shade by his legislative and financial ones. The originator of imperial centralization and unity, the inventor of a well-regulated system of taxation, and the introducer of an alphabetic system of writing, he found a half-dissolved amalgamation of discordant populations on his accession, and left a firmly-welded empire at his death.

In the great inscription on the rock of Behistun, where he has recorded his struggles and victories, Darius traces his descent from Achæmenes, through four ancestors all kings like himself. He seems to have stood next to the line of Cyrus in succession to the throne; and Cyrus, when setting out on his campaign against the Massageteæ, already suspected him of aiming at the crown. He accompanied Cambyses to Egypt, but was recalled by his father to the capital at the time the conspiracy was being formed against the Magian usurper Gomates, who professed to be Bardes (Smerdis in Herodotus), the brother of Cambyses. With six other Persian nobles Darius succeeded in overthrowing the Magian usurpation, and pursued the pseudo-Smerdis to Sikhuyvatis, a fortress in Nisea, where he was put to death, April 2, 521 B. C. The friends of Gomates were massacred, the yearly festival of the Magophonia instituted, and the religion of Zoroaster, which had been suppressed in favor of the idolatrous worship of the Turanian (as opposed to the Aryan) Medes, was solemnly restored. Darius, now twenty-eight years old, was proclaimed king.

The first six years of his reign were occupied in suppressing the revolts which broke out throughout the empire, occasioned partly, perhaps, by the zeal with which the new monarch maintained the Zoroastrian faith, and which led

him to look with special favor on the monotheistic Jews. Pretender after pretender appeared—Atrines and afterwards Martes, in Susiania; Nidintabel, who called himself Nebuchadrezzar son of Nabonidus, in Babylonia; Phraortes, who claimed to be Xathrites son of Cyaxares, in Media and Parthia; Triantachmes, in Sagartia; Phraates, in Margiana; Cœsdates, a second pseudo-Smerdis, in Persia itself; and an Armenian, Aracus, in Babylon; but they were all successively crushed by Darius or his generals. The most serious of these revolts were those in Media and Babylonia, and it was probably during the first Babylonian revolt that the long siege of Babylon mentioned by Herodotus took place, resulting in the attempted plunder of the image of Bel (518 B. C.). This siege may have introduced the otherwise unknown "Darius the Mede" into the book of Daniel (see article on DANIEL). The Median Phraortes, who probably belonged to the Turanian part of the population, proved more than a match for three generals of Darius, and the king had to leave Babylon, which he had just succeeded in capturing, and take the field in person, before the war was finished by the seizure and crucifixion of Phraortes at Ecbatana. The second capture of Babylon was followed by the execution of the Behistun inscription, 515 B. C., in which Darius declares that he had translated "the Ancient Book," "the Text of the Divine Law (*Avesta*) and a Commentary of the Divine Law and the Prayer (*Zend*)" from Bactrian into the old Persian, and had restored it to the nations of the empire (see Oppert's translation of the Median version of the Behistun inscription in *Records of the Past*, vol. vii.). It must have been for the sake of this translation that the Assyrian cuneiform syllabary was simplified into an alphabet of forty characters. A revolt of Iskunka, a chief of the Sacæ, was suppressed shortly after the inscription was engraved. Before this, Orontes, governor of Sardis, who had murdered Polycrates of Samos, and aimed at making himself independent, had been put to death, as well as Arvandes, satrap of Egypt, who had issued a silver coinage of his own.

Darius now set about consolidating and organizing his empire. An elaborate bureaucratic system was instituted, and the empire divided into a varying number of provinces, each under a governor or satrap (*akshatrapada*), appointed by the king for an indefinite time, and responsible for a fixed tribute. The power of the satrap was checked by "royal clerks," who sent annual reports of the satrap and his actions to the king, by retaining the old chiefs or kings of the province by the side of the satrap wherever possible, and by sending members of the royal family to the satrapies. Except in the border satrapies, the military power was intrusted to a separate officer, and it was only in the border provinces, accordingly, that a revolt was to be feared. It is said that the chief fortresses had each an independent commander, while in Persia proper "royal judges" went on circuit. The satrap represented the king, and had the power of life and death. The money tribute, raised probably by a land-tax, amounted, according to Mr. Grote's calculation, to £4,254,000,—7740 talents (£2,964,000) being paid in silver, and the rest in gold. The Indian satrapy contributed by far the most, and Persia proper paid nothing. Part of the tribute was paid in kind, Babylonia and Assyria furnishing one-third. There were, besides, water-rates, and taxes for the use of such crown property as fisheries and the like, but the amount to be paid to the imperial treasury was in all cases fixed. It was otherwise, however, with the exactions the satraps were allowed to make on their own account, and which must have pressed heavily on the people. The tribute enabled Darius to issue a coinage of extreme purity, and his gold darics were worth about 22s. of our money. An incised bar was the imperial stamp. The satrapies were connected with one another by high-roads and posting-stations, at which relays of horses were kept for the royal messengers.

After building a palace at Susa, the new capital of the empire, and founding the *Chehl Minar* at Persepolis, Darius overran the Punjab, and had the Indus navigated by a naval expedition under Scylax of Caryanda. Under the guidance of Democedes, a physician of Crotona, the Greek seas were also explored as far as Magna Græcia, and the northern frontier was strengthened by a campaign against the Scythians. Ariamnes of Cappadocia first examined the northern shores of the Black Sea, after which Darius, with



600 ships and the aid of the Asiatic Greeks, crossed the Bosphorus by a bridge constructed by the Greek Mandrocles, conquered the Getæ, and threw a bridge of boats across the Danube. Leaving the defence of the bridge to the Greeks, he pursued the Scythians as far as the 50th parallel, burning Gelonus (perhaps the modern Voronej), and recrossed the bridge in safety, thanks to the fidelity of Histæus of Miletus. Megabazus, or Megabyzus, next reduced Thrace and made Amyntas of Macedon tributary (506). In the following year Otanes subjugated Byzantium, Chalcædon, Antandros, Lemnos, and Imbros.

In 500 B. C. the Ionic revolt broke out. The allies of the Ionians from Athens and Eretria landed in Asia Minor and burnt Sardis, an event which led the Greeks of the Hellespont, as well as the Carians and the Cyprians, to join the insurrection. The revolt was crushed in 495 B. C. by the battle of Lade and the sack of Miletus; and a terrible punishment was taken upon the Greek cities on the coasts and islands of the Ægean. Miltiades, the tyrant of the Chersonese, escaped with difficulty to Athens, while Darius prepared to avenge the burning of Sardis. His son-in-law, Mardonius, was accordingly sent against Athens and Eretria with a powerful force. But after establishing democracies in the place of tyrants in various Greek cities, and capturing Thasos and its gold mines, Mardonius lost 300 ships and more than 20,000 men in a storm off Mount Athos, and, being further surprised by the Thracian Bryges, returned to Asia Minor. Two years afterwards (490 B. C.) Darius sent another expedition under Datis, which destroyed Eretria, but was ingloriously defeated at Marathon by the Athenians under Miltiades. Darius now made preparations for an attack upon a scale which the Greeks would have found it hardly possible to withstand while an able prince like Darius was at the head of the empire; but in the fourth year of the preparations (487 B. C.), just before everything was ready, Egypt broke out into revolt. Before the revolt could be put down Darius died, 486 B. C., in the sixty-third year of his age according to Herodotus, or the seventy-second according to Ctesias, who, however, curtails his reign by three years. Darius had already nominated Xerxes, his son by Atossa, the daughter of Cyrus, as his successor,—his eldest son, Artobazanes, whose mother was a daughter of Gobryas, being set aside as born before his father was king.

Long before his death Darius had excavated a richly-ornamented tomb with four pillars and other sculptures out of the rocks of Naksh-i-Rustam, about four miles from Persepolis. In an inscription on the façade of the tomb he enumerates 28 different countries or satrapies, including India and "the Scythians beyond the sea," over which he bore sway. His name Dāryavush is rendered *εργείης*, "worker" or "organizer," by Herodotus; but the true meaning of the word is rather "the maintainer," from *dari* (Sanskrit, *dāri*, "conserve"). (A. H. S.)

DARIUS II., called Ochus before his accession, and Nothos after it (on account of his being one of the 17 bastard sons of Artaxerxes Longimanus), was ninth king of the Persian empire. He was made satrap of Hyrcania, and married to Parysatis, the daughter of Xerxes I., by whom he had several children, amongst them two daughters, Amestris and Artosta, as well as Arsaces or Arsicas, who succeeded him under the name of Artaxerxes (Mnemon), and Cyrus the younger. Sogdianus or Secydianus, the murderer of Xerxes II., was defeated in battle by Darius, through the desertion of the two satraps of Egypt and Armenia, and afterwards put to death, Darius assuming the diadem (424 B. C.). Darius was completely under the power of three eunuchs and his wife Parysatis, and his reign of 19 years was characterized by little except insurrections and revolts. The first of these was raised by his brother Arsites and Artyphius the son of Megabyzus, with the help of Greek mercenaries, and was only put down by a liberal employment of gold, the leaders of the insurrection being betrayed by their followers and burned alive. The next was raised by Pisuthnes, satrap of Lydia (414 B. C.), but was also crushed by the bribes offered to his Athenian mercenaries by his antagonist Tissaphernes. Amorges, the son of Pisuthnes, however, continued to maintain himself as a kind of independent monarch in Caria for many years afterwards. Another plot was formed by the chief eunuch, Artaxares, but quickly suppressed. In 411 B. C. Egypt rebelled under Amyrtæus, and Darius was compelled to recognize Pausiris the son of the latter as his successor in

401 B. C. Media, which revolted about the same time, according to Xenophon, was not so fortunate as Egypt in recovering its independence. With the revolt of Media may be connected the rebellion of Terituchmes, a son-in-law of the king. The latter part of the reign of Darius was occupied in supporting Sparta against Athens by means of Persian gold.

DARIUS III., surnamed Codomannus, the last of the Persian monarchs, succeeded Artaxerxes III. (Ochus) 336 B. C., after a short interval during which Arsēs was nominally king. He was the son of Arsames, a nephew of Artaxerxes II. according to one account, and his wife Sisygambis was a daughter of the same monarch. His powers in the war against the Cadisii had been rewarded by Artaxerxes III. with the satrapy of Armenia. The eunuch Bagoas had poisoned Artaxerxes, and placed his creature Arsēs on the throne, in order that he might rule in his name, but after two years he deposed him and put Darius in his place. Darius, however, soon got rid of Bagoas, whom he suspected of conspiracy, by making him drink poison. The character of Darius was mild and amiable, and he was famed for his personal beauty, but he did not possess the qualities necessary for the struggle with Alexander of Macedon which commenced shortly after his accession. In 343 B. C. Alexander crossed the Hellespont, and defeated the Persians, first at the river Granicus (now Ustvola), and then at Issus in Cilicia, where the mother and family of Darius fell into his hands. The death of the Rhodian Memnon, the best of the Persian generals, the conquest of Phœnicia, and the dissipation of the Persian fleet sealed the fate of Darius. He engaged in person, however, in the battle at Gangamela (or Arbela), October, 331 B. C., but was defeated with immense slaughter, and fled to Ecbatana, while Babylon, Susa, and Persepolis opened their gates to the conqueror. In the following year Alexander marched into Media, where Darius had collected a new force. He fled towards Bactria, however, at the approach of the Macedonians, and was being pursued through the deserts of Parthia when he was murdered by Bessus, the satrap of Bactria, and his associates, in the 50th year of his age. His body was sent to Persepolis by Alexander, to be buried with the other monarchs of Persia, while Bessus, who had assumed the royal title, was taken prisoner, and barbarously put to death.

DĀRJĪLING, or DARJEEILING, a district of British India, in the Rājshāhi Kuch-Bihar commissionership, under the lieutenant-governor of Bengal, is situated between 26° 30' 50" and 27° 13' 5" N. lat., and 88° 2' 45" and 88° 56' 35" E. long. It is bounded on the N. by independent Sikkim, on the E. and S. by Jalpaiguri district, and on the W. by Nepāl, and has an area of 1234 square miles. Dārjiling consists of two well-defined tracts,—viz., the lower Himālayas to the south of Sikkim, and the *tarāi*, or plains, which extend from the south of these ranges as far as the northern borders of Purniah district. The plains from which the hills take their rise are only 300 feet above sea level; the mountains ascend abruptly in spurs of from 6000 to 10,000 feet in height. The scenery throughout the hills is picturesque, and in many parts magnificent. The two highest mountains in the world, Kānchanjāngā in Sikkim, and Everest in Nepāl, are visible from the town of Dārjiling. The principal peaks within the district are—Phalālum (12,042 feet), Subargum (10,430), Tanglu (10,084), Situng, and Sinchāl Pahār (8607). The chief rivers are the Tistā, Great and Little Ranjīt, Rammān, Mahānanda, Balāsān, and Jaldhākā. None of them are navigable in the mountain valleys; but the Tistā, after it debouches on the plains, can be navigated by cargo boats of considerable burthen. Bears, leopards, and musk deer are found on the higher mountains, deer on the lower ranges, and a few elephants and tigers on the slopes nearest to the plains. In the lowlands, tigers, rhinoceroses, deer, and wild hogs are abundant. A few wolves are also found. Of small game, hares, jungle fowl, peacocks, partridges, snipe, woodcock, wild ducks and geese, and green pigeons are numerous in the *tarāi*, and jungle fowl and pheasants in the hills. The *mahār* fish is found in the Tistā.

Population.—The Bengal census of 1872 returned the population of the district at 94,712 persons (males, 53,057; females, 41,655), thus classified:—Hindus, 69,831; Mahometans, 6248; Buddhists, 1368; Christians, 556; others, 16,709. The inhabitants of the hilly tract consist to a large extent of Nepālī immigrants and of aboriginal high-

land races; in the *taráí* the people are chiefly Hindus and Mahometans. The Lepchás are considered to be the aboriginal inhabitants of the hilly portion of the district. They are a fine, frank race, naturally open-hearted and free-handed, fond of change and given to an out-door life; but they do not seem to improve on being brought into contact with civilization. It is thought that they are now being gradually driven out of the district, owing to the increase of regular cultivation, and to the Government conservation of the forests. They have no word for plough in their language, and they still follow the nomadic form of tillage known as *jám* cultivation. This consists in selecting a spot of virgin soil, clearing it of forest and jungle by burning, and scraping the surface with the rudest agricultural implements. The productive powers of the land become exhausted in a few years, when the clearing is abandoned, a new site is chosen, and the same operations are carried on *de novo*. The Lepchás are also the ordinary out-door laborers on the hills. They have no caste distinctions, but speak of themselves as belonging to one of nine septs or clans, who all eat together and intermarry with each other. In the upper or northern *taráí*, along the base of the hills, the Mechs form the principal ethnical feature. This tribe inhabit the deadly jungle with impunity, and cultivate cotton, rice, and other ordinary crops, by the *jám* process described above.

The agricultural products consist of rice, cotton, pulses, oil seeds, and jute, principally grown in the *taráí*, and Indian corn, *márua*, and rice in the hills. Tea cultivation is the great industrial feature of Dárjiling district,—conducted almost entirely by means of English capital, and under European supervision. This industry dates from about 1856. The first planters did not meet with success; but the past ten years have been a period of steadily increasing prosperity. In 1866 there were 39 tea gardens in Dárjiling, with a total cultivated area of 10,392 acres, and an out-turn of 433,715 lb of tea. In 1874 the gardens had increased to 113, the area under cultivation to 18,888 acres, and the out-turn of tea to 3,927,911 lb. The cultivation of cinchona was introduced by Government about 1862, and the undertaking has now attained a point which promises success. The Government reserved forest extends to 44,800 acres, scattered over an area of about 700 square miles. India-rubber of excellent quality is obtained from these forests.

Coal of good quality seems to exist, but the supply has not hitherto been utilized. A little iron is manufactured, and copper mining is carried on to a somewhat greater extent; but the methods adopted by the natives are of a very primitive kind. Lime is obtained in large quantities, building stone is abundant, and slate is found. The principal line of communication is the imperial cart road to Dárjiling, which has a course of 48 miles through the district. The Northern Bengal State Railway, now (1877) in course of construction, will bring the district in closer connection with Calcutta, and materially promote the development of its resources.

In 1870-71 the Government revenue of the district amounted to £18,797, and the civil expenditure to £23,869. Three magisterial and three civil and revenue courts are at work in the district; the strength of the police force in 1872 was 213 men. The principal educational institution is St. Paul's school, intended to provide good education at a moderate cost for the sons of Europeans and East Indians. The higher elevations of the district may be pronounced free from endemic disease of every kind except goitre, and this is by no means widely spread. In the *taráí*, however, and in the lower valleys, malarious fevers, often of a severe and fatal type, prevail.

The British connection with Dárjiling dates from 1816, when, at the close of our war with Nepal, we made over to the Sikkim rájá the *taráí* tract, which had been wrested from him and annexed by Nepal. In 1835 the nucleus of the present district of British Sikkim or Dárjiling was created by a cession of a portion of the hills by the rájá of Sikkim to the British as a sanatorium. A military expedition against Sikkim, rendered necessary in 1850 by the imprisonment of Dr. Campbell, the superintendent of Dárjiling, and Dr. Hooker, resulted in the stoppage of the allowance granted to the rájá for the cession of the hill station of Dárjiling, and in the annexation of the Sikkim *taráí* at the foot of the hills and of a portion of the hills beyond. In August, 1866, the hill territory east of the Tistá,

acquired as the result of the Bhután campaign of 1864, was added to the jurisdiction of Dárjiling.

DARJILING TOWN, the well-known sanatory station, is situated in 27° 2' 48" N. lat. and 88° 18' 36" E. long., near the northern boundary of the district, and is 7167 feet above the sea-level. It contains an ordinary population of about 4000 souls, but being a great summer resort from the heat of the plains, the number fluctuates according to the season of the year. The mean temperature of the place is about 24° below that of Calcutta, and only 2° above that of London. (w. w. H.)

DARLINGTON, a parliamentary and municipal borough, parish, and township of England, in the southern division of the county of Durham, is situated on the main line of the North-Eastern Railway, 39 miles south of Newcastle and 235 miles north of London. The town extends east and west to a considerable distance from the River Skerne, a small tributary of the Tees, which traverses it from north to south.

The traditional history of Darlington commences about 1000 years ago, when, as is asserted, the monks who fled with the body of St. Cuthbert from the invading Danes rested for a short time on the site of the present town. This circumstance led Styr the son of Ulphus, prince of Deira, to bestow upon St. Cuthbert, early in the 11th century, "Dearnington with its appendages." At this early date Darlington passed into the hands of the church, and from that time till the middle of the 19th century its history and its government were closely connected with the see of Durham. The bishop appointed a borough bailiff to manage the affairs of the town until 1867, when the office was abolished by the Act of Incorporation. Towards the close of the 11th century a collegiate church was established in Darlington by Bishop Carilepho, and nearly 100 years later Bishop Pudsey built St. Cuthbert's Collegiate Church, which is still deservedly esteemed the most notable ecclesiastical edifice in the county after the cathedral at Durham. The bishop of the diocese had a manor house at Darlington, and a deanery was established in connection with the church by Bishop Neville. So closely identified was the town with the church that it is not surprising that its inhabitants looked with a scant sympathy upon the Reformation. In both the ill-fated attempts to restore the ancient rites, which filled the north with bloodshed, Darlington sided with the rebels. Apart from ecclesiastical affairs there is little of general interest in the early history of the town. Its later history is closely associated with that of the small but enthusiastic sect, in whose eyes all war is criminal. Under the later Stuarts, the Society of Friends, which had effected a settlement here, was subjected to an intermittent persecution; but after the Revolution the Friends laid the foundations of that prosperity which has enabled them for more than a century to occupy the most prominent position in Darlington. To them, and especially to Edward Pease, Darlington owes the distinction of having been the birthplace of the modern railway. The Stockton and Darlington Railway, a short line of twenty-seven miles in length, seven of which were worked by stationary engines on the summit of inclines, and the other twenty by locomotives and by horses, was primarily constructed to cheapen the cost of carrying coal from the Auckland pits to Stockton and Darlington. This railway, of which George Stephenson was the engineer, was projected in 1818, and opened on the 27th of September, 1825. The latter date marks the new birth of Darlington. Prior to 1825 it was a small market town, chiefly remarkable for the manufacture of linen, worsted, and flax. After that date it rapidly increased in population and importance, and became the centre of the industrial district of South Durham, which it did much to develop. At the census of 1821, when the construction of the railway was commenced, the population of Darlington, including some outlying villages, was returned as 6551. Twenty-five years thereafter the population had nearly doubled, the return being 12,452. At the census of 1871 the population was 27,730, and when the fiftieth anniversary of the opening of the railway was celebrated in 1875, it was estimated that the population had increased to 34,000. The ratable value of property showed an even greater proportionate increase, having risen from £26,137 in 1829 to £125,017 in 1875. The government of Darlington—after having been vested in the hands of a borough bailiff, appointed by the bishop, a board of commis-

tioners, and a local board of health—was in 1867 transferred by the Charter of Incorporation to a town council composed of 6 aldermen and 18 councillors. The streets of the borough are wide and well laid out. The gas and water supply are both in the hands of the corporation. The covered market, with the town hall and clock tower, occupies part of the spacious market place, where markets are held every Monday for the sale of agricultural produce, live stock, etc., and on Friday afternoon for butter. There are two spacious and tastefully laid-out cemeteries and a public park in the possession of the municipality, which also owns the public baths and the fever hospital. The union workhouse is situated in Darlington. Among the educational establishments may be mentioned a new grammar school, erected at a cost of £10,000 on a foundation which dates from the reign of Elizabeth, and the British and Foreign School Society's training college for female teachers. A mechanics' institute, a small theatre, a subscription library, and reading rooms are among the other local institutions. Including St. Cuthbert's Collegiate Church already mentioned, the Church of England has five places of worship in the town, and there are numerous chapels belonging to the nonconformist denominations. Petty sessions are held here weekly, and the county courts monthly. In antiquities the town is not rich. Excepting the collegiate church, which dates from the beginning of the 13th century, almost the only relic of the past is the engine "Locomotive No. 1," the first that ever ran on a public railway, which stands on a pedestal of stone at the North Road station. There is a monument in the town erected to Joseph Pease, "the first Quaker member of Parliament." Before 1825 the Pease family were wealthy mill-owners, and they still own mills containing 270 looms and employing 700 hands; but their mining undertakings, which were not commenced until after that date, throw the mills completely into the shade. They employ 6500 workmen, and raise more than 3,000,000 tons of minerals per annum. The Darlington Iron Company, with a nominal capital of £350,000, employs 2000 hands, and turns out 90,000 tons of iron rails per annum. The Skerne Iron Company manufactures iron plates for shipbuilding, boiler-making, bridge construction, and other purposes. The South Durham Iron Works, with a capital of £130,000, are exclusively smelting works, producing from their three furnaces about 40,000 tons of pig-iron per annum. Among other industries of the town may be mentioned wagon-building, malting, and tanning.

DARMSTADT, the capital of the grand duchy of Hesse-Darmstadt, in the province of Starkenburg, is situated on the River Darm, fifteen miles south of Frankfort-on-the-Maine. It is the residence of the grand duke, and the seat of the Government of the province and of the grand duchy. In 1875 there was a population of 37,253; including the neighboring village of Bessungen, it was 44,088. Darmstadt consists of an old and a new town, the streets of the former being narrow and gloomy. The latter, which includes the greater part of the city, contains broad streets and several fine squares, in one of which is a column surmounted by the statue of the grand duke Louis I., the founder of the new town. There are four churches, the Roman Catholic church being the most imposing, and a synagogue recently built. Of the remaining buildings the most noteworthy are the two grand ducal palaces, the arsenal, and the theatre. The Grand Ducal Museum includes a library of nearly 500,000 volumes, with 4000 MSS., a gallery of 700 pictures, a valuable natural history collection, besides coins, drawings, engravings, etc. In the Cabinet Museum there is a library of 60,000 volumes. The town possesses a gymnasium, two Real schools, and a technical school; and there are various societies, such as the Agricultural Society, the Historical Society, the Middle Rhine Geological Society, and the Society of Architects. Among the chief manufactures are carpets, hats, jewelry, and tobacco; and there is a considerable trade in seeds of different kinds, and in wine. There are many pleasant walks in the neighborhood, which is well wooded, and several of the palace gardens are open to the public.

Darmstadt is mentioned in the 11th century, but in the 14th century it was still a village, held by the Counts of Katzenell-

bogen. It came by marriage into the possession of the house of Hesse in 1479, the male line of the house of Katzenellbogen having in that year become extinct. The imperial army took it in the Schmalkaldic war, and destroyed the old castle. In 1567, after the death of Philip the Magnanimous, his youngest son George received Darmstadt and chose it as his residence. He was the founder of the line of Hesse-Darmstadt.

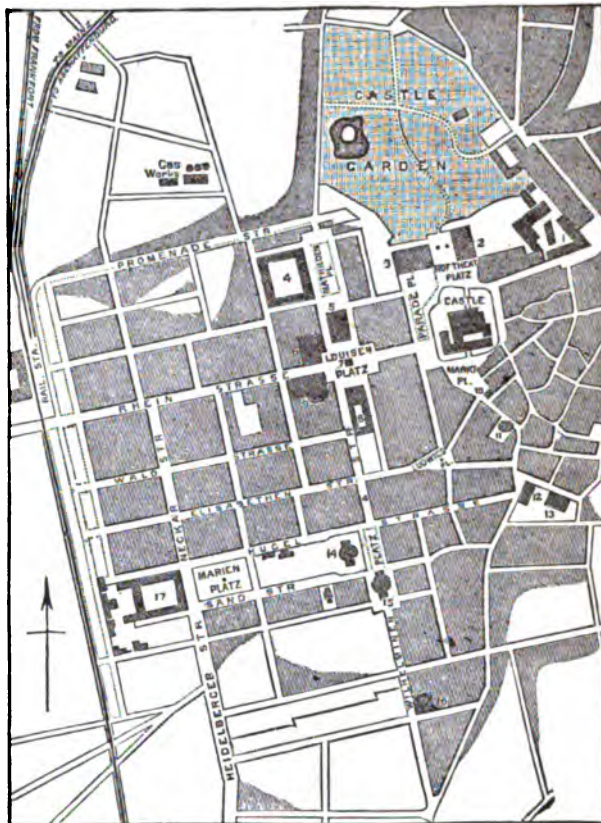

Plan of Darmstadt.

- |   |                               |
|---|-------------------------------|
| 1. Infantry Barracks.                       | 9. Ständehaus.                |
| 2. Theatre.                                 | 10. Town Hall.                |
| 3. Armory.                                  | 11. Town Church.              |
| 4. Grand Duke's Stables.                    | 12. Gymnasium.                |
| 5. Chancery.                                | 13. Polytechnium.             |
| 6. Prince Alexander's Palace.               | 14. Palace of Prince Louis.   |
| 7. Statue of Grand Duke Louis I.            | 15. Catholic Church.          |
| 8. Grand Ducal Palace, Museum, and Library. | 16. Palace of Prince Charles. |
|   | 17. Cavalry Barracks.         |

DARNÉTAL, a town of France, in the department of Seine-Inférieure, and 2½ miles east of Rouen, on two small streams called the Aubette and the Robec. It has a fine Gothic church, and manufactures woollens, flannels, cottons, and paper. Population in 1871, 5636.

DARTFORD, an English market-town, parish, and local board district of West Kent, 16 miles east of London, on the Darent, which enters the Thames about 2½ miles north of the town. The town lies low, flanked by two chalky eminences, called East and West Hills, and consists of one main street, crossed by two or three smaller streets. It possesses a town hall, a grammar school, and a county court-house. The most noteworthy building, however, is the parish church, repaired and restored, which contains a curious old fresco and several interesting brasses. The prosperity of the town depends on the important public works in its immediate vicinity, including powder works, paper mills, and engineering works. One of the first attempts at the manufacture of paper in England was made here by Spilman, who was jeweller to Queen Elizabeth, and that industry has been identified with the place ever since. Dartford was the scene, in 1235, of the marriage, celebrated by proxy, between Isabella, sister of Henry III., and the Emperor Frederick II.; and in 1331 a famous tournament was held in the place by Edward III. The same monarch established an Augustinian nunnery on West Hill in 1355, of which, however, almost no

remains now exist. It was here also that Wat Tyler's outbreak occurred in 1377, and the house he resided in is pointed out by the townspeople. The area of the parish is 4251 acres; the population (1871), 8298.

**DARTMOOR FOREST.** See DEVONSHIRE.

**DARTMOUTH**, an ancient municipal borough and seaport town of England, in South Devon, 31 miles south of Exeter and 229 miles south-west of London by rail, is situated nearly opposite the town of Kingswear, at the mouth of the Dart, which here forms a secure harbor in the English Channel. The town stretches along the shore of the harbor, overhung by steep acclivities, and presents a picturesque appearance. Many of the houses belong to the Elizabethan period. Its principal building is St. Saviour Church, a cruciform edifice of ancient date, containing a graceful rood-screen, a stone pulpit, and some interesting monuments. Dartmouth castle stands at the entrance of the harbor. As a seaport Dartmouth is now little used, but it occupied an important place in the early history of England. It was the rendezvous of the crusaders' fleet in 1190; and in 1346-47 it contributed 31 ships to the siege of Calais under Edward III. In later times several expeditions left its harbor for the exploration of the New World; and during the civil wars of the 17th century its occupation was hotly contested. The borough is governed by a mayor, 4 aldermen, and 12 councillors. It contains an area of 1847 acres (including part of the parish of Stokefleming), and in 1871 had a population of 5388 persons. Formerly it returned a member to Parliament, but it was disfranchised in 1868.

**DARU, PIERRE-ANTOINE, COMTE DE (1767-1829)**, a distinguished author and statesman of France, was born at Montpellier, where his father held the office of secretary to the intendency of Languedoc. From the Oratorians of the military school at Tournon he imbibed an enthusiasm for study, and an admiration of the master-pieces of ancient literature, which remained with him for life. At the age of sixteen he entered the army, and in the following year, though under the legal age, he obtained the rank of commissary. In 1791, in spite of his attachment to the principles of the Revolution, he was accused before the "Club" of treasonable relations with the marquis of Bouzou; but the eloquence of his defence secured his acquittal. In the following year, however, while he was serving in Brittany, the senseless suspicion of the times was such that his use of the ironical expression *nos amis les Anglais* caused him to be thrown into prison. The eighteen months of durance spent at Rennes and Orleans were mainly devoted to the study and translation of Horace, in imitation of whose style he also produced an *Épître à mon Sans-Culotte*, as he designates the keeper to whom he was intrusted. After his release he served under Pétiet and Massena in several important situations in the commissariat and in the office of the ministry of war. His generous love of justice was strikingly displayed by the appeal which he made in favor of Ferrand, whom he believed to have been wrongfully removed from a post to which he himself was appointed. The first consul made him secretary to the ministry at war; and, the day after the battle of Marengo, nominated him one of the commissioners for the execution of the convention concluded between General Berthier and General Melas. In 1805 he was made a counsellor of state and intendant-general of the emperor's military household. In the following year he received the appointment of intendant-general of the Brunswick territory, and subsequently of commissioner for the execution of the treaties of Tilsit and Vienna, as well as minister plenipotentiary at Berlin. In 1806 he was elected a member of the Institute, and in 1808 an honorary member of the Berlin Academy. In 1811 he was appointed minister secretary of state; and shortly afterwards he received the portfolio of the war department. He accompanied Napoleon in his Russian campaign. When the retreat from Moscow had commenced, he had to assume the functions of intendant-general of the army; and his iron constitution, and capacity for labor, enabled him to fulfil, with apparent ease, duties which might have killed several men of ordinary strength. *C'est un lion pour le travail*, said Napoleon himself. After the restoration of the Bourbons he was made intendant-general to the king, an appointment which he received in December, 1814. But on the return of Napoleon from Elba he joined the standard of his old master, subscribed a considerable sum for

the purpose of arming the Parisian fédérés, and in his capacity of councillor of state attached his signature to the celebrated declaration of the 25th March. His conduct towards the emperor displays a frank and simple independence of character combined with a genuine devotion to Napoleon's cause. "They don't speak well of my *arc de triomphe*," said Napoleon one day. "There are two persons whom I have heard praise it," replied Daru,—"your majesty and his architect." The second restoration found him compromised by his connection with the Government of the Hundred Days; and he retired for a time into private life, and devoted himself to literary pursuits. But in 1819 he was summoned by royal ordinance to the Chamber of Peers, where his rectitude of judgment and administrative knowledge signalized him as one of the most powerful defenders of the national liberties. In 1821 he published his *Histoire de Venise*, which is by far the most important of his works, and is regarded as the most complete and impartial history of that singular republic equally remarkable for its strength and duration. His subsequent work, the *Histoire de Bretagne* (3 vols. 1826), displays great labor and accuracy, but is devoid of interest except to historical antiquaries. His other productions consist of a poetical translation of Horace, which, in spite of the malicious epigram of Le Brun, *Je ne lis point Daru, j'aime trop mon Horace*, has enjoyed in France a well-merited reputation; a variety of occasional poems, discourses, and *éloges* pronounced in the Academy; and speeches delivered in the Chamber of Peers. He died at his residence near Meulan, September 5, 1829, aged sixty-two. His remains were deposited in the Cimetière Montmartre, and five discourses were pronounced over his tomb by MM. Mirbel, Cuvier, Silvestre de Sacy, Ternaux, and Leroy.

See the "Notice" by M. Viennet prefixed to the fourth edition of the *Histoire de Venise*, 9 vols., 1853, and three articles by Sainte-Beuve in *Causeries du Lundi*, vol. ix.

**DARWIN, ERASMUS (1731-1802)**, man of science and poet, was born at Elton, in Nottinghamshire, on the 12th December, 1731. Having studied at St. John's College, Cambridge, and at Edinburgh, and taken the degree of M.D. at the latter university, he settled as a physician at Lichfield, and gained a large practice. While here he is said to have done much, both by his own example and by more direct effort, to diminish drunkenness among the lower classes. In 1781 he removed to Derby, where he remained till his death, which took place on the 18th April, 1802. The fame of Erasmus Darwin as a poet rests upon his *Botanic Garden*, though he also wrote *The Temple of Nature, or the Origin of Society, a Poem, with Philosophical Notes* (1803), and *The Shrines of Nature* (posthumously published). The *Botanic Garden* (the second part of which—*The Loves of the Plants*—was published anonymously in 1789, and the whole of which appeared in 1791) is a long poem in the deca syllabic rhymed couplet. Its merit lies in the genuine scientific enthusiasm and interest in nature which pervade it; and of any other poetic quality—except a certain, sometimes felicitous but oftener ill-placed, elaborated pomp of words—it may without injustice be said to be almost destitute. It was for the most part written laboriously, and polished with unsparing care, line by line, often as he rode from one patient to another, and it occupied the leisure hours of many years. The diction is artificial to a degree which renders it in emotional passages stilted and even absurd, and which makes Canning's clever caricature—*The Loves of the Triangles*—often remarkably like the poem it satirizes; in some passages, however, it is not without a stately appropriateness. Gnomes, sylphs, and nereids are introduced on almost every page, and personification is carried to an extraordinary excess. Thus he describes the *Loves of the Plants* according to the Linnæan system by means of a most ingenious but misplaced and amusing personification of each plant, and often even of the parts of the plant. It is significant that botanical notes are added to the poem, and that its eulogies of scientific men are frequent. Darwin's mind was in fact rather that of a man of science than that of a poet. His most important scientific work is his *Zoonomia* (1794-6), which contains a system of pathology, and a treatise on generation, in which Darwin, in the words of his famous grandson, "anticipated the views and erroneous grounds of opinions of Lamarck." The essence of Darwin's views is contained in the following passage, which he follows up with the conclusion "that one and the same

kind of living filaments is and has been the cause of all organic life:—

“Would it be too bold to imagine that, in the great length of time since the earth began to exist, perhaps millions of ages before the commencement of the history of mankind,—would it be too bold to imagine that all warm-blooded animals have arisen from one living filament, which the great First Cause endued with animality, with the power of acquiring new parts, attended with new propensities, directed by irritations, sensations, volitions, and associations, and thus possessing the faculty of continuing to improve by its own inherent activity, and of delivering down these improvements by generation to its posterity, world without end?”

*Observations on the Zoonomia* were published by Thomas Brown, the psychologist (Edinburgh, 1798). In 1799 Darwin published his *Phytologia, or the Philosophy of Agriculture and Gardening* (1799), in which he states his opinion that plants have sensation and volition. A paper on *Female Education in Boarding Schools* (1797) completes the list of his works. A slight account of Darwin's life was published by Anna Seward in 1804.

DASHKOFF, CATHERINA ROMANOFNA WORONZOFF, PRINCESS (1744–1810), was the third daughter of Count Roman Woronzoff, a member of the Russian senate, distinguished for his intellectual gifts. She received an exceptionally good education, having displayed from a very early age the masculine ability and masculine tastes which made her whole career so singular. She was well versed in mathematics, which she studied at the university of Moscow, and in general literature her favorite authors were Bayle, Montesquieu, Boileau, Voltaire, and Helvetius. While still a girl she was connected with the Russian court, and became one of the leaders of the party that attached itself to the Grand Duchess (afterwards Empress) Catherine. Before she was sixteen she married Prince Dashkoff, a prominent Russian nobleman, and went to reside with him at Moscow. In 1762 she was at St. Petersburg and took a leading part, according to her own account the leading part, in the *coup d'état* by which Catherine was raised to the throne. (See CATHERINE II., vol. v. p. 203). Another course of events would probably have resulted in the elevation of the Princess Dashkoff's elder sister, Elizabeth, who was the imbecile and unfortunate emperor's mistress, and in whose favor he made no secret of his intention to depose Catherine; but this fact, by inflaming the princess's jealousy, rather impelled her to the action she took than deterred her from it. Her relations with the new empress were not of a cordial nature, though she continued devotedly loyal. Her blunt manners, her unconcealed scorn of the male favorites that disgraced the court, and perhaps also her sense of unrequited merit, produced an estrangement between her and the empress, which ended in her asking permission to travel abroad. The cause of the final breach was said to have been the refusal of her request to be appointed colonel of the imperial guards. Her husband having meanwhile died, she set out in 1763 on an extended tour through Europe. She was received with great consideration at foreign courts, and her literary and scientific reputation procured her the *entrée* to the society of the learned in most of the capitals of Europe. In Paris she secured the warm friendship and admiration of Diderot and Voltaire. She showed in various ways a strong liking for England and the English. She corresponded with Garrick, Dr. Blair, and Principal Robertson; and when in Edinburgh, where she was very well received, she arranged to intrust the education of her son to Principal Robertson. In 1782 she returned to the Russian capital, and was at once taken into favor by the empress, who strongly sympathized with her in her literary tastes, and especially in her desire to elevate Russia to a place among the literary languages of Europe. Immediately after her return the princess was appointed “directeur” of the St. Petersburg Academy of Arts and Sciences; and in 1784 she was named the first president of the Russian Academy, which had been founded at her suggestion. In both positions she acquitted herself with marked ability. She projected the Russian dictionary of the Academy, arranged its plan, and executed a part of the work herself. She edited a monthly magazine, and wrote at least two dramatic works, *The Marriage of Fabian*, and a comedy entitled *Toisniokoff*. Shortly before Catherine's death the friends quarrelled over a tragedy which the princess had allowed to find a place in the publications of the Academy, though it contained revolutionary principles, according to the empress. A part al-

conciliation was effected, but the princess soon afterwards retired from court. On the accession of the Emperor Paul in 1796 she was deprived of all her offices, and ordered to retire to a miserable village in the government of Novgorod, “to meditate on the events of 1762.” After a time the sentence was partially recalled on the petition of her friends, and she was permitted to pass the closing years of her life on her own estate near Moscow, where she died on the 4th January, 1810.

The *Memoirs of the Princess Dashkoff written by herself* were published in 1840, in London, in two volumes. They were edited by Mrs. W. Bradford, who, as Miss Wilmot, had resided with the Princess between 1803 and 1808, and had suggested their preparation.

DASS, PETTER (1647–1708), styled the Father of modern Norwegian poetry, was the son of Peter Dundas, a Scotch merchant of Dundee, who left his country about 1630 to escape the troubles of the Presbyterian church. He settled in Bergen, and in 1646 married a Norse girl of good family. Petter Dass was born in 1647 on the island of Nord Herø, on the north coast of Norway. Seven years later his father died, and his mother placed him with his aunt, the wife of the priest of another little island parish. In 1660 he was sent to school at Bergen, in 1665 to the university, and in 1667 he began to earn his daily bread as a private tutor. In 1672 he was ordained priest, and remained till 1681 as under chaplain at Nesne, a little parish near his birth-place; for eight years more he was resident chaplain at Nesne; and at last in 1689 he received the living of Alstahoug, the most important in the north of Norway. The rule of Alstahoug extended over all the neighboring districts, including Dass's native island of Herø, and its privileges were accompanied by great perils, for it was necessary to be constantly crossing stormy firths of sea. Dass lived here in quietude, with something of the honors and responsibilities of a bishop, brought up his family in a God-fearing way, and wrote endless reams of verses. In 1700 he asked leave to resign his living in favor of his son Anders Dass, but this was not permitted; in 1704, however, Anders became his father's chaplain. About this time the old poet refreshed himself by a visit to Bergen, where he made the acquaintance of the poetess Dorothea Engebretsdatter, the most admired writer of the day, with whom he had been for many years in correspondence. He continued to write till 1707, and died in August, 1708. The materials for his biography are very numerous; he was regarded with universal curiosity and admiration in his lifetime; and, besides, he left a garrulous autobiography in verse. A portrait, painted in middle age, now in the church of Melhus, near Trondhjem, represents him in canonicals, with deep red beard and hair, the latter wavy and silky, and a head of massive proportions. The face is full of fire and vigor. His writings passed in MS. from hand to hand, and few of them were printed in his lifetime. *Nordlands Trompet* (The Trumpet of Nordland), his greatest and most famous poem, was not published till 1739; *Den norske Dale-Vise* (The Norwegian Song of the Valley) appeared in 1696; the *Aandelig Tidfordriv* (Spiritual Pastime), a volume of divine pieces, was published in 1711. *The Trumpet of Nordland* remains, after nearly two centuries, as fresh as ever in the memories of the inhabitants of the north of Norway; boatmen, peasants, priests will alike repeat long extracts from it at the slightest notice, and its popularity is unbounded. It is a rhyming description of the province of Nordland, its natural features, its trades, its advantages, and its drawbacks, given in dancing verse of the most breathless kind, and full of humor, fancy, wit, and quaint learning. The other poems of Petter Dass are less universally read; they abound, however, in queer turns of thought, and fine homely fancies. The collected writings of Dass have lately been published at Christiania in a very handsome form, edited by Dr. A. E. Eriksen.

DATE PALM. The dates of commerce are the fruit of a species of palm, *Phoenix dactylifera*, a tree which ranges from the Canary Islands through Northern Africa and the south-east of Asia to India. It has been cultivated and much prized throughout most of these regions from the remotest antiquity. In Arabia, indeed, it is the chief source of national wealth, and its fruit forms the staple article of food in that country. The tree has also been introduced along the Mediterranean shores of Europe; but as its fruit does not ripen so far north, the European plants

are only used to supply leaves for the festival of Palm Sunday among Christians, and for the celebration of the Passover by Jews. The date palm is a beautiful tree, growing to a height of from 60 to 80 feet, and its stem, which is strongly marked with old leaf-scars, terminates in a crown of graceful shining pinnatisect leaves. The flowers spring in branching spadices from the axils of the leaves, and as the trees are unisexual, it is necessary in cultivation to fertilize the female flowers by artificial means. The fruit is an oblong drupe, which varies as much in size, color, and quality under cultivation, as does the apple in temperate regions, while the recognized and named varieties of the one fruit are quite as numerous as those of the other. Regarding this fruit Mr. W. G. Palgrave (*Central and Eastern Arabia*) remarks—"Those who, like most Europeans at home, only know the date from the dried specimens of that fruit shown beneath a label in shop-windows, can hardly imagine how delicious it is when eaten fresh and in Central Arabia. Nor is it, when newly gathered, heating,—a defect inherent to the preserved fruit everywhere; nor does its richness, however great, bring satiety; in short it is an article of food alike pleasant and healthy." In the oases of Sahara, and in other parts of Northern Africa, dates are pounded and pressed into a cake for food; and it is said that there the fruit is the food of man and beast, and is eaten by horses and camels, and even by dogs. The dried fruit used for dessert in European countries contains more than half its weight of sugar, about 6 per cent. of albumen, and 12 per cent. of gummy matter. All parts of the date palm yield valuable economic products. Its trunk furnishes timber for house-building and furniture; the leaves supply thatch; their footstalks are used as fuel, and also yield a fibre from which cordage is spun.

*Date sugar* is a valuable commercial product of the East Indies, obtained from the sap or toddy of *Elate sylvestris*, a tree so closely allied to the date palm that it has been supposed to be the parent stock of all the cultivated varieties. The juice, when not boiled down to form sugar, is either drunk fresh, or fermented and distilled to form arrack. The uses of the other parts and products of this tree are the same as those of the date palm products. *Date palm meal* is obtained from a small species, *Elate farinifera*, growing in the hill country of southern India; it is occasionally resorted to in times of distress or famine.

DAUBENTON, LOUIS-JEAN-MARIE (1716–1800), a distinguished naturalist, was born at Montbar, in the department of the Côte d'Or, in France, May 29, 1716. His father, Jean Daubenton, a notary, who destined him for the church, after putting him through a course of instruction under the Dominicans of Dijon, sent him to Paris to learn theology. The secret study of medicine, however, and the lectures of Baron, Martineng, and Col de Villars, of Winslow, Hinnault, and Antoine de Jussieu, were more attractive to young Daubenton. The death of his father in 1736 set him free to follow his own inclinations, and he accordingly in 1741 took the degree of doctor at Rheims, and returned to his native town with the intention of following the practice of medicine. But fortune destined him for a more brilliant career. It was about this time that Buffon, also a native of Montbar, had formed the plan of bringing out a grand treatise on natural history, and in 1742 he invited Daubenton to assist him by providing the anatomical descriptions for that work. The characters of the two philosophers were opposed in almost every respect. Buffon was violent and impatient; Daubenton, gentle and patient; Buffon was rash in his judgments, and imaginative, seeking rather to divine than to discover truths; Daubenton was cautious, and believed nothing he had not himself been able to see or ascertain. From nature each appeared to have received the qualities requisite to temper those of the other; and a more suitable coadjutor than Daubenton it would have been difficult for Buffon to obtain. In the first section of the natural history Daubenton gave descriptions and details of the dissection of 132 species of quadrupeds, thus procuring for himself a high reputation, and exciting the envy of Réaumur, who considered himself as at the head of the learned in natural history in France. A feeling of jealousy induced Buffon to dispense with the services of Daubenton in the preparation of the subsequent parts of his work, which, as a consequence, lost much in precision and scientific value. Buffon afterwards perceived and acknowledged his error, and renewed his intimacy with his former associate. The number of dissertations on natural

history which Daubenton published in the memoirs of the French Academy is very great. Zoological descriptions and dissections, the comparative anatomy of recent and fossil animals, vegetable physiology, mineralogy, experiments in agriculture, and the introduction of the merino sheep into France gave active occupation to his energies; and the cabinet of natural history in Paris, of which in 1744 he was appointed keeper and demonstrator, was arranged and considerably enriched by him. From 1775 Daubenton lectured on natural history in the College of Medicine, and in 1783 on rural economy. He was appointed professor of mineralogy by the Convention at the Jardin du Roi; and he gave lectures at the Normal School during the ephemeral existence of that institution. He was likewise one of the editors of the *Journal des Savans*, and contributed to two encyclopedias. As a lecturer he was in high repute, and to the last retained his popularity. In the winter of 1799 he was appointed a member of the Conservative Senate, but at the first meeting which he attended he fell from his seat in an apoplectic fit. After a short illness he died at Paris, January 1, 1800.

DAUBENY, CHARLES GILES BRIDLE (1795–1867), an English chemist, botanist, and geologist, was the third son of the Rev. James Daubeny, and was born at Stratton, in Gloucestershire, February 11, 1795, and died December 12, 1867. In 1808 he entered Winchester School, and in 1810 he was elected to a demyship at Magdalen College, Oxford. The lectures of Dr. Kidd at that university first awakened in him a desire for the cultivation of natural science. In 1814 he graduated with second class honors, and in the next year he obtained the prize for the Latin essay. From 1815 to 1818 he studied medicine in London and Edinburgh; and in the latter city he attended the lectures of Professor Jameson on natural science. At that time the rival theories of the Huttonians and Wernerians, were occupying the attention of geologists. In 1819 Daubeny, in the course of a tour through France, made the volcanic district of Auvergne a special study. By subsequent journeys in Hungary, Transylvania, Italy, Sicily, France, and Germany he extended his knowledge of volcanic phenomena; and in 1826 the results of his observations were given in a work entitled *A Description of Active and Extinct Volcanoes*, a second edition of which was printed in 1848. An earlier treatise was *An Essay on the Geology and Chemical Phenomena of Volcanoes*, published at Oxford in 1824. Daubeny, in common with Gay-Lussac and Davy, held subterraneous thermic disturbances to be probably due to the contact of water with metals of the alkalies and alkaline earths. In November, 1822, Daubeny succeeded Dr. Kidd as professor of chemistry at Oxford, and twelve years later he was appointed to the chair of botany there. At the Oxford Botanic Garden he conducted numerous experiments upon the effect of changes in soil, light, and the composition of the atmosphere upon vegetation. In 1830 he published in the *Philosophical Transactions* a paper on the iodine and bromine of mineral waters. In the following year appeared his *Introduction to the Atomic Theory*, which was succeeded by a supplement in 1840, and in 1850 by a second edition. In 1831 Daubeny represented the universities of England at the first meeting of the British Association, which at his request held their next session at Oxford. In 1836 he communicated to the Association a report on the subject of mineral and thermal waters. In 1837 he visited the United States, and acquired there the materials for papers on the thermal springs and the geology of North America, read in 1838 before the Ashmolean Society and the British Association. In 1856 he became president of the latter body at its meeting at Cheltenham. In 1841 Daubeny published his *Lectures on Agriculture*; in 1857 his *Lectures on Roman Husbandry*; and in 1865 an *Essay on the Trees and Shrubs of the Ancients*, and a *Catalogue of the Trees and Shrubs indigenous to Greece and Italy*. His last literary work was the collection of his miscellaneous essays, published in two volumes, in 1867. In all his undertakings Daubeny was actuated by a practical spirit and a desire for the advancement of knowledge; and his personal influence on his contemporaries was in keeping with the high character of his various literary productions.

D'AUBIGNÉ, JEAN-HENRI MERLE (1794–1872), was born 16th August, 1794, at Eaux Vives, near Geneva. The ancestors of his father, François Merle, were French Protestant refugees; his paternal grandmother's name

D'Aubigné, which Jean-Henri Merle subsequently added to his own, was a name well known in the service of Henry IV. Jean-Henri was destined by his parents to a commercial life, but the new interests awakened by his course at college led him to fix his choice on the office of the Christian ministry. The influence of Robert Haldane, a Scottish evangelist sojourning in Geneva, told powerfully and permanently on the divinity student, and kindled in him a hitherto unknown zeal for the distinctively evangelical truths of the Christian faith. When in 1817 Merle went abroad to further his education, Germany was about to celebrate the tercentenary of the Reformation; and thus early he conceived the ambition to write the history of that great epoch. At Berlin he received stimulus from teachers so unlike as were Neander and De Wette. After presiding for five years over the French Protestant church in Hamburg, he was in 1823 called to become pastor of a congregation in Brussels, and preacher to the court. At the Belgian revolution, he preferred pastoral work at home to an educational post in the family of the Dutch king; and shortly after his return to Switzerland events rendered it impossible for those like-minded with him in religious matters to remain in the national Genevese Church. The separation took place finally in 1833, and Merle D'Aubigné became one of the founders of the new evangelical church; and, whether as pastor or as professor of church history in its theological seminary, he continued to be till the last days of his life an unwearied and influential laborer in the cause of his church and of evangelical Protestantism. In him the Evangelical Alliance found a hearty promoter. He made many friends in other lands, and repeatedly visited England. He was made a D. C. L. by Oxford University, and received civic honors from the city of Edinburgh. His many labors never impaired his healthy frame. In his seventy-ninth year he still enjoyed perfect vigor of mind and body; sudden death during the night of the 20th October, 1872, removed him from the midst of academic and literary work.

It was as their historian that Merle D'Aubigné was most powerfully to serve the cause of the Protestant churches. The first section of his *History of the Reformation*, having for its central subject the earlier period of the work in Germany, gave its author at once a foremost rank amongst modern French ecclesiastical historians, was translated into most European tongues, and was much more widely read and admired in English-speaking lands than at home. It is said that 200,000 copies of the English translation were sold in Great Britain alone, and about twice as many in the United States. The second series of volumes, dealing with reform in the time of Calvin, was not less thorough than the former series, and had a subject hitherto less exhaustively treated; but it did not meet with a success so marked. This part of the subject, with which the Genevese professor was most competent effectively to deal, was all but completed at the time of his death. Along with the great work of his life, he had written many minor treatises on the themes he had most closely at heart. Of these the most important are a vindication of the character and aims of Oliver Cromwell, and a sketch of the contentings of the Kirk of Scotland.

Dr. Merle D'Aubigné was in many ways well fitted to be a powerful and popular expositor of history, and especially of that history to which he devoted the studies of a lifetime. Indefatigable in exploring and sifting original documents, he had amassed a vast wealth of authentic information; but a desire to give everywhere a full and graphic picture, assisted by a gift of warm and genial imaginative power, betrayed him into aiming at fulness of picturesque detail concerning events and processes necessarily hidden from the eye of a strict historiographer. In a few cases he seems by inference from his knowledge of a later period to have filled up a narrative not sustained by documentary evidence. He was able in a marvellous manner to identify himself with the Reformers; but while his sympathies enabled him to do justice to great aims of good men, he too frequently becomes their apologist. His expressed desire everywhere to trace the working of God's Spirit in the work of the Reformers leads him to pass too lightly over secondary but weighty influences, and in his heroes' opponents continually to discover the foes of God; and the devout purpose with which he confessedly wrote inspires his pages with much that is rather religious admonition than history, and causes a style otherwise simple

and dignified to pass into fervid rhetoric. But his work remains a noble monument of painstaking sincerity and reverential love for a great subject. In the main it unquestionably brings us into direct contact with the genuine spirit of the most momentous period in the modern history of the Christian Church.

D'Aubigné's principal works are—*Discours sur l'Étude de l'Histoire de Christianisme* (Gen. 1832); *Le Luthéranisme et la Réforme* (Par. 1844); *Germany, England, and Scotland, or Recollections of a Swiss Pastor* (Lond. 1848); *Trois Siècles de Lutte en Écosse, ou deux Rois et deux Royaumes; Le Protecteur de la République d'Angleterre aux jours de Cromwell* (Par. 1848); *Le Concile et l'Infaillibilité* (1870); *Histoire de la Réformation au XVI<sup>ème</sup> Siècle* (Par. 1835-53; new ed. 1861-62 in 5 vols.); and *l'Histoire de la Réformation en Europe au temps de Calvin* (8 vols., 1862-1877).

D'AUBIGNÉ, THEODORE AGRIPPA (1550-1630) French historian and poet, was born at St. Maury, in Saintonge, on the 8th February, 1550. In his childhood he showed a great aptitude for languages. According to his own account he knew Latin, Greek, and Hebrew at six years of age; and he had translated the *Crito* of Plato before he was eleven. His father, a Huguenot, who had been one of the conspirators of Amboise, strengthened his Protestant sympathies by showing him, while they were passing through that town on their way to Paris, the heads of the conspirators exposed upon the scaffold, and adjuring him not to spare his own head in order to avenge their death. After a brief residence he was obliged to flee from Paris to avoid persecution, but was captured and condemned to death. Escaping through the intervention of a friend, he went to Montargis. In his fourteenth year he was present at the siege of Orleans, at which his father was killed. His guardian sent him to Geneva, where he studied for a considerable time under the direction of Beza. In 1567 he made his escape from tutelage, and attached himself to the Huguenot army under the prince of Condé. Subsequently he joined Henry of Navarre, to whom he rendered valuable service, both as a soldier and a counsellor, in the wars that issued in his elevation to the throne as Henry IV. His career at camp and court, however, was a somewhat chequered one, owing to the roughness of his manner and the keenness of his criticisms, which made him many enemies, and severely tried the king's patience. In his tragedy *Circé*, which was played before the court, he did not hesitate to indulge in the most outspoken sarcasm against the king and other members of the royal family. Though he more than once found it expedient to retire into private life, he never entirely lost the favor of Henry, who made him governor of Maillezais. After the conversion of the king to Roman Catholicism, D'Aubigné remained true to the Huguenot cause, and a fearless advocate of the Huguenot interests. The first two volumes of the work by which he is best known, his *Histoire Universelle depuis 1550 jusqu'à l'an 1601*, appeared in 1616 and 1615 respectively. The third volume was published in 1619, and, being still more free and personal in its satire than those which had preceded it, was immediately ordered to be burned by the common hangman. The work is a lively chronicle of the incidents of camp and court life, and forms a very valuable source for the history of France during the period it embraces. In September, 1620, its author was compelled to take refuge in Geneva, where he found a secure retreat for the last ten years of his life, though the hatred of the French court showed itself in procuring a sentence of death to be recorded against him more than once. He devoted the period of his exile to study, and the superintendence of works for the fortifications of Bern and Basel, which were designed as a material defence of the cause of Protestantism. He died at Geneva on the 29th April, 1630. He had two sons, one of whom, Constant D'Aubigné, was the father of Madame de Maintenon.

The chief works of D'Aubigné besides those already mentioned are—*Vers funèbres sur la mort d'Étienne Jodelle* (Paris, 1574), *Les Tragiques données au public par le laïcain de Prométhée* (1616), *Aventures du Baron de Fumeste*, and *La Confession Catholique du Sieur de Sancy*.

D'AUBUSSON, PIERRE (1423-1503), a grand-maître of the order of St. John of Jerusalem, celebrated for the zeal and ability with which he opposed the Turks, was born in 1423. He belonged to a noble French family, and early devoted himself to the career of a soldier; but his his-

tory is involved in obscurity till he entered the order of which he was to become the head. Having distinguished himself greatly against the pirates of the Levant, in 1458 he was chosen to conduct an embassy to Charles VII., a duty which he performed with much success. He was after this appointed to the most important offices in the order, and, finally, in 1476, was by an almost unanimous vote elected grand-master. It was the period of the conquests of Mahomet II., who, supreme in the East, now began to threaten Europe. In December, 1479, a large Turkish fleet, under Misach Palæologus, appeared in sight of Rhodes; a landing was effected, and a vigorous attack made upon the city. But in July of the next year, being reinforced from Spain, the knights forced the Mussulmans to retire. D'Aubusson had been dangerously wounded in one of the numerous and severe fights which had taken place; but in a few weeks he had so far recovered as to be able to address to the emperor of the East an account of the siege, which raised his renown to the highest point throughout Europe. Soon after, Mahomet II. died, leaving his kingdom to be disputed between his sons Bajazet and Zizim. The latter, finding himself unable to achieve success, sought the aid of D'Aubusson, who, in 1482, received him with great display, but took advantage of his confidence to detain him a prisoner. He was afterwards sent to France, and finally handed over to the Pope, who rewarded D'Aubusson with a cardinal's hat, and with the power of conferring all benefices connected with the order without the sanction of the papacy, and also suppressed the orders of St. Sepulchre and St. Lazarus, and bestowed their wealth on the order of St. John. For some years D'Aubusson devoted himself to regulating the affairs of his order, so that it might retain the spirit of lofty enthusiasm which originally animated it, and by which he was himself inspired, and defending its interests from the bad faith of the Popes; but in 1501, being appointed generalissimo of the Christian armies against the Turk, he sailed to attack Mitylene. The forces he commanded, however, he found it impossible to bring into agreement; and the expedition proved a failure. The measure to which the rest of his life was mainly devoted was an attempt to expel Judaism from Rhodes, by banishing the adult Jews and forcibly baptizing the children. He died in the summer of 1503.

See P. Bonhours, *Histoire de Pierre d'Aubusson* (1676); Rossio, *Dell' Istoria della Religione e Militia de S. Giovanni Gerusalemmitano* (1594-1602), translated by Baudouin and Naberat (1643); Villeneuve Bargemont, *Monuments de l'ordre de Saint Jean* (1829).

DAUN, LEOPOLD JOSEF MARIA, COUNT VON (1705-1766), field-marshal and commander-in-chief of the Austrian army during the Seven Years' War, was born at Vienna on the 26th September, 1705. He was intended for the church, and studied in his youth at Rome; but his natural inclination for the army, in which his father and grandfather had been distinguished generals, proved irresistible. In 1718 he served in the war in Sicily, in his father's regiment; in 1734-5, having risen to the rank of major-general, he was engaged in the wars in Italy and on the Rhine. He continued to add to his distinctions in the war against the Turks (1737-9), and in the war of the Austrian succession. In 1745 he was placed in the supreme command of the artillery, and in the same year he confirmed himself in the favor of his sovereign, Maria Theresa, by marrying her protégée, the Countess Fuchs. In 1746-8 he held a command in the Netherlands. In 1754 he was elevated to the rank of field-marshal. During the interval of peace that preceded the Seven Years' War he was engaged in carrying out an elaborate scheme for the reorganization of the Austrian army; and it was chiefly through his instrumentality that the military academy was established at Wiener-Neustadt in 1751. During the Seven Years' War he was the most formidable opponent that Frederick the Great encountered. On the 18th June, 1757, he inflicted a decisive defeat on the greatest general of the age at the battle of Kolin. In commemoration of this brilliant exploit the queen immediately instituted a military order bearing her name, of which Daun was nominated first grand cross. In December, 1757, he succeeded Prince Charles of Lorraine as commander-in-chief, and he gained fresh fame by the victories of Hochkirchen (14th October, 1758), and Maxen (20th November, 1759). On the latter occasion he took General Fink and his whole

army prisoners. These successes were counterbalanced by the defeat of Laudon at Leignitz, which was attributed to the dilatoriness of Daun, and the defeat near Torgau (2d November, 1760) by Ziethen's cavalry in a night surprise. In this engagement Daun was so severely wounded that he had to return to Vienna to recruit. He resumed his command in 1761, but did not again achieve any marked success. He retired finally in 1763, at the close of the war. In the previous year he had been appointed president of the Aulic Council. He died on the 5th February, 1766. By the order of Maria Theresa a monument to his memory was erected in the church of the Augustinians, with an inscription styling him the Saviour of the State. As a general Daun has been reproached for the dilatoriness of his operations, but this was only the wariness required in opposing a general like Frederick, who was quick and unexpected in his movements beyond all precedent. A more indisputable fault was his inability to secure the full results of a victory.

DAUPHINE, an ancient province of south-eastern France, now forming the departments of Isère, Drôme, and Hautes Alpes. It was bounded on the E. by Piedmont, N.E. by Savoy, S. by Provence, S.W. by the Comté Venaissin, and N. and W. by the Rhone. The western portion was known as Lower, and the eastern portion as Upper Dauphiné,—the latter including the districts of Matesine, Champ-saur, Oisans, Diâis, Gapençais, Embrunais, and Briançonnais; and the former, Gressivaudan, Viennois, Valentinois, Royannex, the Baronies, and Tricastiniais. When it first appears in history the district was inhabited by the Allobroges, the Caturiges, and other Celtic tribes, who were gradually incorporated in the Roman Empire. It was afterwards successively comprised in the first Burgundian kingdom, the Carolingian empire, the second Burgundian kingdom, and the German empire. In the course of the 9th, 10th, 11th, and 12th centuries it was broken up into several small principalities, ecclesiastical and secular; of which the most important proved that of the lords of Albon, who, first as counts and afterwards as dauphins of Vienna, gradually extended their influence and possessions. The Burgundian line dying out in 1281, the lordship passed to the house of La Tour du Pin, which in the person of Guiges VIII. was offered the royal dignity by Louis the Bavarian. Guiges's successor, Hubert II., having lost his only son in 1335, made over his lands to Charles of Valois, the grandson of Philip VI., in return for an annual payment, and on condition that the independence and the privileges of the countship should be maintained. From this time the eldest son of the king of France bore the title of Dauphin. The history of Dauphiné down to the Revolution consists mainly of the struggles of its inhabitants to maintain their liberties against the gradual encroachments of the Crown. Louis XI. was the first to demand the payment of an annual tax. Richelieu abolished their estates; but the constitutional spirit of the people continued alive, and in 1788 displayed itself in violent resistance to the dissolution of the provincial parliament and in the convocation of the three orders in the castle of Vizille, where the popular rights were boldly asserted.

See Chappuis-Montlville, *Histoire du Dauphiné*, 1827; Colomba de Batines, *Bibliographie des patois du Dauphiné*, 1835; *Catalogue des Dauphinois dignes de mémoire*, 1840, and *Mélanges biographiques relatifs à l'histoire littéraire du Dauphiné*, 1837-40; Raverat, *A travers le Dauphiné*; Charles Lory, *Description géologique du Dauphiné*, 1861.

DAURAT, JEAN (or DORAT; in Latin, AURATUS), French poet of the renaissance, and founder of the Pléiade, was born at Limoges in 1507. He was of illustrious family, and, after studying at the college of Limoges, came up to Paris to be presented to Francis I., who made him tutor to his pages. He rapidly gained an immense reputation, especially for proficiency in classical learning. As private tutor in the house of Lazare de Baif, he had J. A. de Baif, afterwards famous as a poet, for his pupil. His son, Louis, was of a marvellous precocity, and at the age of ten translated into French verse one of his father's Latin pieces; his poems were published with his father's. Jean Daurat became the director of the Collège de Coqueret, where he had among his pupils, besides Baif, Ronsard, Remy Belleau, and Pontus de Thyard. Du Bellay was added by Ronsard to this group; and these five young poets, under the direction of Daurat, formed a species of society for the



reformation of the French language and literature. They increased their number to seven by the initiation of the dramatist Étienne Jodelle, and thereupon they named themselves "La Pléiade" in emulation of the seven Greek poets of Alexandria. The election of Daurat as their president proved the weight of his personal influence, but as a writer of French verse he is the least important of the seven. Meanwhile he collected around him a sort of Academy, and stimulated the students on all sides to a passionate study of Greek and Latin poetry. He himself wrote incessantly in both those languages, and was styled the Modern Pindar. In 1560 he was appointed professor of Greek at the Collège Royale, a post which he continued to hold until, in his extreme old age, he resigned it in favor of his nephew, Nicolas Goulou. Charles IX. gave him the title of *poète regius*. His flow of language was the wonder of his time; he is said to have composed more than 15,000 Greek and Latin verses. What he considered the best of these were comprised in a volume of *Poemata*, published at Paris in 1586. He died at Paris on the 1st of November, 1588, having survived all his illustrious pupils of the Pléiade, except Pontus de Thyard. He was a little, restless man, of untiring energy, rustic in manner and appearance. His unequalled personal influence over the most graceful minds of his age gives him an importance in the history of literature for which his own somewhat vapid writings do not fully account.

DAUREÉ, a small town of the province of Malvah, in Hindoestan, lat. 22° 12' N., long. 76° 23' E. Its chief claim to notice consists in the fact that here the navigation of the Nurbudda River is impeded by a fall 30 feet in height.

DAUSS, an island in the Persian Gulf, in a bay of the Arabian coast, lat. 10° N., long. 53° 3' E. It is not far from the famous pearl-fisheries.

DAUW, or ZEBRA OF THE PLAINS (*Equus Burchelli*), in the Bechuanan tongue, *Feetsi*, and sometimes called the *Striped* or *Bonte Quagga*, a quadruped of South Africa, generally regarded as forming a link between the Zebra and Quagga. A very similar, if not the same, species has been encountered as far north as the Congo River. The Dauw is a gregarious animal, ranging in large herds the broad plains north of the Orange River. It is somewhat larger and more robust than the Zebra, and its hoofs are less concave beneath, thus adapting it to a level country, as those of the Zebra fit that animal for the rugged surface of mountainous districts. In color the Dauw is a light bay; the face, head, and body are striped with black, and the belly, legs, and tail, the latter of which is tufted near its root, are white.

DAVANZATI BOSTICHI, BERNARDO, an Italian merchant, born at Florence in 1529, distinguished as a writer whose literary labors contributed largely towards bringing the Tuscan language to perfection. During the active portion of his life he occupied various civil stations in his native city with credit and honor. His death took place in 1606. Among his original writings is a treatise entitled *The Tuscan Cultivation of the Vine and other Trees*, which was published a few years before his death. His literary reputation, however, rests in a great measure on his translation of Tacitus, which is said to be a masterpiece of strength, precision, and elegance, even surpassing the original in conciseness.

DAVENANT, SIR WILLIAM (1605-1668), poet and dramatist, was born in February, 1605, at the Crown Inn, Oxford, where his father was a wealthy vintner. It was stated that Shakespeare always stopped at this house in passing through the city of Oxford, and out of his known or rumored admiration of the hostess, a very fine woman, there sprang a scandalous story which attributed Davenant's paternity to the greatest of poets, a legend which there is reason to believe Davenant himself encouraged, but which later criticism has cast aside as spurious. In 1621 the vintner was made mayor of Oxford, and in the same year his son left the grammar-school of All Saints, where his master had been Edward Sylvester, and was entered an undergraduate of Lincoln College. He did not stay at the university, however, long enough to take a degree, but was hurried away to appear at court as a page, in the retinue of the gorgeous duchess of Richmond. From her service he passed into that of Fulke Greville, Lord Brooke, in whose house he remained until the murder of that eminent man in 1628. This blow threw him upon the world, not alto-

gether without private means, but greatly in need of a profitable employment. He turned to the stage for subsistence, and in 1629 produced his first play, the tragedy of *Albovina*. It was not a very brilliant performance, but it pleased the town, and decided the poet to pursue a dramatic career. The next year saw the publication of *The Cruel Brother*, a tragedy, and *The Just Italian*, a tragi-comedy. Inigo Jones, the court architect, for whom Ben Jonson had long supplied the words of masques and complimentary pieces, quarrelled with his great colleague in the year 1634, and applied to William Davenant for verses. The result was *The Temple of Love*, performed by the queen and her ladies at Whitehall on Shrove Tuesday, 1634, and printed in that year. Another masque, *The Triumphs of the Prince D'Amour*, followed in 1635. The poet returned to the legitimate drama by the publication of three of his cleverest and most successful pieces, the tragi-comedy of *Love and Honor*, in 1635, and the tragi-comedy of *The Platonic Lovers*, and the famous comedy of *The Wits*, in 1636. The masque of *Britannia Triumphans* brought him into some trouble, for it was suppressed, as a punishment for its first performance having been arranged for a Sunday. By this time Davenant had, however, thoroughly ingratiated himself with the court; and on the death of Ben Jonson in 1637 he was rewarded with the office of poet-laureate, to the exclusion of May, who considered himself entitled to the honor. It was shortly after this event that Davenant collected his minor lyrical pieces into a volume entitled *Madagascar and other Poems*, 1638; and in 1639 he became manager of the new theatre in Drury Lane. The civil war, however, put a check upon this prosperous career; and he was among the most active partisans of royalty through the whole of that struggle for supremacy. As early as May, 1642, Davenant was accused before the Long Parliament of being mainly concerned in a scheme to seduce the army to overthrow the Commons. He was accordingly apprehended at Faversham, and imprisoned for two months in London; he then attempted to escape to France, and succeeded in reaching Canterbury, where he was recaptured. Escaping a second time, he made good his way to the queen, with whom he remained in France until he volunteered to carry over to England some military stores for the army of his old friend the earl of Newcastle, by whom he was induced to enter the service as lieutenant-general of ordnance. He acquitted himself with so much bravery and skill that, after the siege of Gloucester, in 1643, he was knighted by the king. After the battle of Naseby he retired to Paris, where he became a Roman Catholic, and spent some months in the composition of his epic poem of *Gondibert*. In 1650 he took the command of a colonizing expedition that set sail from France to Virginia, but was captured in the Channel by a Parliamentary man-of-war, which took him back to the Isle of Wight. Imprisoned in Cowes Castle until 1651, he tempered the discomfort and suspense of his condition by continuing the composition of *Gondibert*. He was sent up to the Tower to await his trial for high treason, but just as the storm was about to break over his head, all cleared away. It is believed that the personal intercession of Milton led to this result. Davenant, released from prison, immediately published *Gondibert*, the work on which his fame mainly rests, a chivalric epic in the stanza of *Nosce Teipsum*, the influence of which poem is strongly marked in its philosophical passages. It is a cumbrous, dull poem, but is relieved with a multitude of fine and felicitous passages, and lends itself most happily to quotation. During the civil war one of his plays had been printed, the tragedy of *The Unfortunate Lovers*, in 1643. He found that there were many who desired him to recommence his theatrical career. Such a step, however, was absolutely forbidden by Puritan law. Davenant, therefore, by the help of some influential friends, obtained permission to open a sort of theatre at Rutland House, in Charterhouse Yard, where, on the 21st of May, 1656, he began a series of representations, which he called *operas*, as an inoffensive term. This word was then first introduced into our language. The opening piece was his own *Siege of Rhodes*, printed the same year, which was performed with stage-decorations and machinery of a kind hitherto quite unthought of in England. He continued until the Restoration to produce ephemeral works of this kind, only one of which, *The Cruelty of the Spaniards in Peru*, in 1658, was of sufficient literary merit to survive. In 1660 he had the infinite satisfaction of being able to

preserve the life of that glorious poet who had, nine years before, saved his own from a not less imminent danger. The mutual relations of Milton and Davenant do honor to the generosity of two men who, sincerely opposed in politics, knew how to forget their personal anger in their common love of letters. Under Charles II., Davenant flourished in the dramatic world; he opened a new theatre in Lincoln's Inn Fields, which he called the Duke's; and he introduced a luxury and polish into the theatrical life which it had never before known in England. Under his management the great actors of the Restoration, Betterton and his coevals, took their peculiar French style and appearance; and the ancient simplicity of the English stage was completely buried under the tinsel of decoration and splendid scenery. Davenant brought out six new plays in the Duke's Theatre, *The Rivals*, *The Man's the Master*, comedies translated from Scarron, *News from Plymouth*, *The Distresses*, *The Siege*, *The Fair Favorite*, tragi-comedies, all of which were printed after his death, and not one of which survived their author on the stage. He died on the 17th of April, 1668, and two days afterwards was buried in Poet's Corner, Westminster Abbey, with the inscription, "O rare Sir William Davenant!" In 1672 his writings were collected in folio. His last work had been to travesty Shakespeare's *Tempest*, in company with Dryden.

The personal character, adventures, and fame of Davenant, and more especially his position as a leading reformer, or rather debaser, of the stage, have always given him a prominence in the history of literature which his writings hardly justify. His plays are utterly unreadable, and his poems are usually stilted and unnatural. With Cowley, he marks the process of transition from the poetry of the imagination to the poetry of the intelligence; but he had far less genius than Cowley, and his influence on our drama must be condemned as wholly deplorable.

(E. W. G.)

DAVENPORT, a city of the United States, capital of Scott county, Iowa, is situated on the west bank of the Upper Mississippi, opposite Rock Island, about 110 miles above Keokuk (following the course of the river), and 160 miles west of Chicago. The city, which is regularly laid out, contains a city hall, a county court-house, an opera house, and a number of churches. Among the educational institutions may be mentioned Griswold College, belonging to the Episcopal denomination, and the Catholic Academy of the Immaculate Conception. There is also an academy of natural science. The trade of Davenport is considerable, consisting chiefly of grain and domestic produce, while its manufactures are not unimportant, comprising wagons, agricultural implements, joinery and cabinet work, tobacco, etc. The city is governed by a mayor and 12 aldermen. It was first settled in 1836, and was incorporated as a town in 1842 and as a city in 1851. Population in 1860, 11,267; and in 1870, 20,038.

DAVID (Hebrew, דָּוִד *beloved*), son of Jesse, second king of Israel, and founder of the dynasty which continued to reign at Jerusalem until the Babylonian captivity. According to the usual chronology, he reigned 1055-1015 B. C., but the computations which produce this date by counting back from the destruction of Jerusalem, 588 B. C., or the fall of Samaria, 722 B. C., contain numerous precarious elements. Ewald puts the date ten years earlier, but recent investigations on the contrary make it not improbable that David flourished as much as from thirty years to half a century later than is usually assumed.<sup>1</sup>

David is the greatest of the kings of Israel, and his reign changed the whole face of Hebrew history. During the period of the Judges, the Hebrews were weakened by an exaggerated love of personal independence, divided by tribal jealousies, and oppressed by a succession of foreign enemies, of whom the latest and most dangerous were the Philistines, an immigrant people whose main settlements

<sup>1</sup> The admitted confusion in the chronology of the books of Kings can hardly be cleared up without the aid of synchronisms with the history of foreign nations, Egypt and Assyria. The Assyrian synchronisms seem to bring down the date of Jehu, and hence of all who preceded him, by nearly forty years. This is at least not contradicted by the only available Egyptian synchronism, the war of Shishak with Bahobam. (See Schröder, *Königschroniken und A. T. Glansen*, 1872, and in control of his conclusions Wellhausen in the *Jahrbücher für Deutsche Theologie*, 1875, p. 607, seq., and G. Smith's *Assyrian Synchronism*, 1875.) An additional element of uncertainty lies in the forty years' reign ascribed to Solomon. Forty is often used as an indefinite number, and the marriage of Bahobam to Absalom's daughter seems inconsistent with so long a reign, as Bahobam came to the throne at the age of forty-one.

in the fruitful coastland of southern Canaan appear to have taken place after the Hebrews were established in the land. Forcing their way inland, the Philistines struck a decisive blow in the battle of Ebenezer (1 Sam. iv.), when the collapse of the ancient hegemony of Ephraim, and the destruction of the sanctuary of the ark at Shiloh, left the Hebrews without national leaders and without a centre of national action. Then arose Samuel, whose prophetic activity rallied the Israelites around Jehovah God of Hosts, and brought about a great national and religious revival. The struggle with the Philistines was renewed with better success, though without decisive issue, and at length the election of Saul as king embodied in a permanent institution the stronger sense of national unity which had grown up under Samuel. But Saul was not equal to the task set before him. He broke with the prophetic party, which was the mainstay of the national revival which the king was called to lead. He felt himself forsaken by Jehovah, and his last years were clouded by accessions of a furious melancholy which destroyed his vigor and alienated his subjects. When at length he was defeated and slain at Gilboa, the Philistines appeared to be absolute masters of the position. They even moved forward and occupied the cities in the plain of Jezreel and on the Jordan, which the Israelites forsook in terror—a movement which cut the country as it were in two, and apparently made it impossible for the Hebrews again to unite under a single head. From this humiliation David in a few years raised his country to the highest state of prosperity and glory, subduing his enemies on every side, and extending his suzerainty, as he expresses himself in Psalm xviii., even over nations that he had not known. To do this work other qualities than mere military capacity were required. David was not only a great captain,—he was a national hero, who united in his own person the noblest parts of Hebrew genius, and drew to himself by an unerring personal attraction the best valor, patriotism, and piety of the nation; while his political tact and inborn talent for rule enabled him to master the old tribal particularism, and to shape at Jerusalem a kingdom which, so long as he lived, represented the highest conception of national life that was possible under the rude social conditions then existing. The structure erected by David was, in truth, too much in advance of the times, and too wholly the creation of unique genius to be permanent. Under a successor whose wisdom lacked the qualities of personal force and sympathy with popular feeling, the kingdom of David began to decay, and in the next generation it fell asunder, and lived only in the hearts of the people as the proudest memory of past history, and the prophetic ideal of future glory.

The books of Samuel, which are our principal source for the history of David, show how deep an impression the personality of the king, his character, his genius, and the romantic story of his early years had left on the mind of the nation. Of no hero of antiquity do we possess so life-like a portrait. Minute details and traits of character are preserved with a fidelity which the most sceptical critics have not ventured to question, and with a vividness which bears all the marks of contemporary narrative. But the record is by no means all of one piece. The history, as we now have it, is extracted from various sources of unequal value, which are fitted together in a way which offers considerable difficulties to the historical critic. In the history of David's early adventures the narrative is not seldom disordered, and sometimes seems to repeat itself with puzzling variations of detail, which have led critics to the almost unanimous conclusion that the First Book of Samuel is drawn from at least two parallel histories. It is indeed easy to understand that the romantic incidents of this period were much in the mouths of the people, and in course of time were written down in various forms which were not combined into perfect harmony by later editors, who gave excerpts from several sources rather than a new and independent history. These excerpts, however, have been so pieced together that it is often impossible to separate them with precision, and to distinguish accurately between earlier and later elements. It even appears that some copies of the books of Samuel incorporated narratives which other copies did not acknowledge. From the story of Goliath the Septuagint omits many verses—1 Sam. xvii 12-31, xvii. 55-xviii. 5. The omission makes the narrative consistent, and obviates serious difficulties involved in the Hebrew text. Hence some have supposed that the

Greek translators arbitrarily removed passages that puzzled them. But this hypothesis does not meet the facts, and is inconsistent with what we know of the manner of this part of the Septuagint. There can be little doubt that both here and in other cases the shorter text is original, and that the disturbing additions came in later from some other documents, and were awkwardly patched on to the older text. So too the history of the gradual estrangement of Saul from David is certainly discontinuous, and in the opinion of most critics the two accounts of David sparing Saul's life are duplicate narratives of one event. Even in the earlier part of the history these minor difficulties do not affect the essential excellence of the narrative preserved to us; and for the period of David's kingship the accounts are still better. All that relates to personal and family matters at the court of Jerusalem (2 Sam. xi.-xx.) seems to come from some writer who had personal cognizance of the events recorded. It does not appear that the plan of this author included the history of David's foreign campaigns. The scanty account of great wars in ch. viii. is plainly from another source, and in general our information is less adequate on public affairs than on things that touched the personal life of the king. The narrative is further enriched with poetical pieces, of which one at least (2 Sam. i. 19-27) is known to be extracted from an anthology entitled *The Book of the Upright*. Several brief lists of names and events seem also to have been taken from distinct sources, and sometimes interrupt the original context (e.g., 2 Sam. iii. 2-5). Some important lists were still accessible to the author of Chronicles in a separate form. 1 Chron. xi. 10-47 is fuller at the end than the corresponding list in 2 Sam. xxiii.; and 1 Chron. xii. contains valuable matter altogether wanting in Samuel. See also 1 Chron. xxvii. Besides the books of Samuel (with 1 Kings i. ii.), and the parallel narrative of the Chronicles, we have a few hints for the history of David in 1 Kings xi. and in the titles of Psalms (especially Pss. vii. and lx.) and of course such psalms as can be made out to be really by David are invaluable additions to the Davidic poems incorporated in the books of Samuel.

Jesse, the father of David, was a substantial citizen of Bethlehem. He claimed descent through Boaz from the ancient princes of Judah (Ruth iv. 18, *seq.*), but the family connection was not of note in Israel (1 Sam. xviii. 18). As the youngest son of the house David spent his youth in an occupation which the Hebrews as well as the Arabs seem to have held in low esteem. He kept his father's sheep in the desert steppes of Judah, and there developed the strength, agility, endurance, and courage which distinguished him throughout life, and are referred to in Ps. xviii. 32, *seq.* (comp. 1 Sam. xvii. 34, xxiv. 2; 2 Sam. xvii. 9). There, too, he acquired that skill in music which led to his first introduction to Saul. Then he became Saul's armor-bearer, and in this capacity, according to the shorter and more consistent form of the narrative, David took part in the campaign in which he slew the Philistine champion Goliath, and became by one exploit a popular hero, and an object of jealousy to Saul. According to the Massoretic text of 1 Sam., Saul's jealousy leaped at once to the conclusion that David's ambition would not stop short of the kingship. Such a suspicion would be intelligible if we could suppose that the king had heard something of the significant act of Samuel, which now stands at the head of the history of David in witness of that divine election and unction with the spirit of Jehovah on which his whole career hung (1 Sam. xvi. 1-13). But there is not the least trace in the history that even David and David's family understood at the time the meaning that underlay his unction by Samuel, which would naturally be taken as a special mark of favor and a part of the usual "consecration" of the guests in a sacrificial feast.<sup>1</sup> The shorter text of 1 Sam. xviii., represented by the Septuagint, gives an account of Saul's jealousy, which is psychologically more intelligible.<sup>2</sup> According to this text

Saul was simply possessed with such a personal dislike and dread of David as might easily occupy his disordered brain. To be quit of his hateful presence he gave him a military command. In this charge David increased his reputation as a soldier and became a general favorite. Saul's daughter Michal loved him; and her father, whose jealousy continued to increase, resolved to put the young captain on a perilous enterprise, promising him the hand of Michal as a reward of success, but secretly hoping that he would perish in the attempt. David's good fortune did not desert him; he won his wife, and in this new advancement continued to grow in the popular favor, and to gain fresh laurels in the field.

At this point it is necessary to look back on an episode which is found in the Hebrew text but not in the Greek—the proposed marriage of David with Saul's eldest daughter Merab, who at the time when the proposal was made was already the wife of a certain Adriel.<sup>3</sup> What is said of this affair interrupts the original context of chap. xviii., to which the insertion has been clumsily fitted by an interpolator in v. 21. We have, therefore, a notice drawn from a distinct source, and of uncertain value. Merab and Michal are confounded in 2 Sam. xxi. 8, and perhaps the whole episode of Merab and David rests on a similar confusion of names.

As the king's son-in-law, David was necessarily again at court. He became chief of the body-guard, as Ewald rightly interprets 1 Sam. xxii. 14, and ranked next to Abner (1 Sam. xx. 25), so that Saul's insane fears were constantly exasperated by personal contact with him. On at least one occasion the king's frenzy broke out in an attempt to murder David with his own hand.<sup>4</sup> At another time Saul actually gave commands to assassinate his son-in-law, but the breach was made up by Jonathan, whose chivalrous spirit had united him to David in a covenant of closest friendship (1 Sam. xix. 1-7). The circumstances of the final outburst of Saul's hatred, which drove David into exile, are not easily disentangled. The narrative of 1 Sam. xx., which is the principal account of the matter, cannot originally have been preceded by chap. xix. 11-24, for in chap. xx. David appears to be still at court, and Jonathan is even unaware that he is in any danger, while the preceding verses represent him as already a fugitive. It may also be doubted whether the narrative of David's escape from his own house by the aid of his wife Michal (chap. xix. 11-17) has any close connection with verse 10, and does not rather belong to a later period.<sup>5</sup> David's daring spirit might very well lead him to visit his wife even after his first flight. The danger of such an enterprise was diminished by the reluctance to violate the apartments of women and attack a sleeping foe, which appears also in Judges xvi. 2, and among the Arabs.<sup>6</sup> In any case it is certain that chap. xx. must be taken by itself; and it seems safer to conclude that chap. xix. 11-24 are fragments which have been misplaced by an editor, than to accept the opinion of those critics who hold that we have two distinct and quite inconsistent accounts of the same events.

According to chap. xx. David was still at court in his usual position when he became certain that the king was aiming at his life. He betook himself to Jonathan, who thought his suspicions groundless, but undertook to test them. A plan was arranged by which Jonathan should draw from the king an expression of his feelings, and a tremendous explosion revealed that Saul regarded David as the rival of his dynasty, and Jonathan as little better than a fellow conspirator. The breach was plainly irreparable. Jonathan sought out his friend, and after mutual pledges of unbroken friendship, they parted and David fled. His first impulse was to seek the sanctuary at Nob, where he had been wont to consult the priestly oracle (chap. xxii. 15), and where, concealing his disgrace by a fictitious story, he also obtained bread from the consecrated table and the sword of Goliath. It was perhaps after this that David

elusive, the first and last clauses of ver. 8, verses 9 to 11 inclusive, the reason given for Saul's fear in ver. 12, verses 17-19 inclusive, the second half of ver. 21. It also modifies ver. 23, and omits the second half of ver. 29 and the whole of ver. 30.

<sup>1</sup> This seems to be the true meaning of 1 Sam. xviii. 19.

<sup>2</sup> 1 Sam. xix. 9. The parallel narrative, ch. xviii. 10, 11, may refer to a different occasion. But as the text of ch. xviii. is disordered and the verses are wanting in the Greek, this is not certain.

<sup>3</sup> The close of ver. 10 in the Hebrew is corrupt, and the words "that night" seem to belong to next verse. So the Greek reads.

<sup>4</sup> Wellhausen cites a closely parallel case from Sprenger's *Mohammed*, vol. ii. p. 543.

<sup>1</sup> The proof of this turns in good measure on arguments that cannot be reproduced here. But the discussion in Wellhausen's *Test der Bücher Samuels*, Göttingen, 1871, appears to be conclusive.

<sup>2</sup> The remarks of Samuel as the sons of Jesse passed before him were presumably not audible. The words "unto Jesse" in ver. 10 are not in the LXX. It is not therefore necessary to conclude with some critics that this story is to be taken as a mere figurative embodiment of the idea of David's election by God. When the true sense of the act was divined it is not easy to determine. David appears still unconscious of his destiny in 1 Sam. xviii. 23, but Abigail, 1 Sam. xxv. 30, knows that the prophetic word has marked him out as king. Compare 2 Sam. iii. 9, v. 2.

<sup>3</sup> From ch. xviii. the LXX. omits ver. 1 to the middle of ver. 6 in-

made a last attempt to find a place of refuge in the prophetic circle of Samuel at Ramah, where he was admitted into the prophetic consobium, and was for a time protected by the powerful, and almost contagious influences, which the religious exercises of the prophets exerted on Saul's emissaries, and even on the king himself. The episode now stands in another connection (chap. xix. 18, seq.), where it is certainly out of place. It would, however, fit excellently into the break that plainly exists in the history at xxi. 10 after the affair at Nob. Deprived of the protection of religion as well as of justice, David tried his fortune among the Philistines at Gath. But he was recognized and suspected as a redoubtable foe. Escaping by feigning madness, which in the East has inviolable privileges,<sup>1</sup> he returned to the wilds of Judah, and was joined at Adullam<sup>2</sup> by his father's house and by a small band of outlaws, of which he became the head. Placing his parents under the charge of the king of Moab, he took up the life of a guerrilla captain, cultivating friendly relations with the townships of Judah (1 Sam. xxx. 26), which were glad to have on their frontiers a protector so valiant as David, even at the expense of the blackmail which he levied in return. A clear conception of his life at this time, and of the respect which he inspired by the discipline in which he held his men, and of the generosity which tempered his fiery nature, is given in 1 Sam. xxv. His force gradually swelled, and he was joined by the prophet Gad and by the priest Abiathar, the only survivor of a terrible massacre by which Saul took revenge for the favors which David had received at the sanctuary of Nob. He was even able to strike at the Philistines, and to rescue Keilah, in the low country of Judah, from their attack. Had he been willing to raise the standard of revolt against Saul, he might probably have made good his position, for he was now openly pointed to as divinely designed for the kingship. But though Saul was hot in pursuit, and though he lived in constant fear of being betrayed,<sup>3</sup> David refused to do this. His blameless conduct retained the confidence of Jonathan (1 Sam. xxiii. 16), and he deserved that confidence by sparing the life of Saul.<sup>4</sup> But at length it became plain that he must either resist by force or seek foreign protection. He went to Achish of Gath, and was established in the outlying town of Ziklag, where his troops might be useful in chastising the Amalekites and other robber tribes who made forays on Philistia and Judah without distinction.<sup>5</sup>

At Ziklag David continued to maintain amicable relations with his friends in Judah, and his little army received accessions even from Saul's own tribe of Benjamin (1 Chron. xii. 1). At length, in the second year, he was called to join his master in a great campaign against Saul. The Philistines directed their forces towards the rich valley of Jezreel; and Saul, forsaken by Jehovah, already gave himself up for lost. It may be doubted whether the men of Judah took part in this war; and on his march David was joined by influential deserters from Israel (1 Chron. xii.). The prestige of Saul's reign

<sup>1</sup> An interesting parallel in Barthelemy *Chron.*, ed. Brunet et Kirsch, p. 222.

<sup>2</sup> The cave of Adullam is traditionally placed at Charatan, two hours' journey south of Bethlehem. But the town of Adullam, which has not been identified with any certainty, lay in the low country of Judah (Josh. xv. 26). The "cave" is also spoken of as a "hold" or mountain fortress, and perhaps "hold" is everywhere the true reading (Wallhausen, Nöldeke). Compare Theodoron in 1 Sam. xxiii. 15, xxiv. 1.

<sup>3</sup> 1 Sam. xxiii. 12, 19, Psalm vii., 1 Chron. xii. 17. 1 Sam. xxvi. 1 seems to refer to the same event as ch. xxiii. 19.

<sup>4</sup> We have seen that this act of generosity either was repeated or is twice recorded, 1 Sam. xxiv. and xxvi. Neither narrative suggests the existence of the other, and the two are not more divergent than the two forms of the story of Goliath. But it is hard to comprehend how Ewald can give the preference to ch. xxiv. The *kur-de-foros* by which he changes Saul's cruise of water into a basin, and adduces legendary parallels, ignores obvious features of truthfulness in ch. xxvi. Compare Thomson's *Land and Book*, p. 267. The conversation in ch. xxvi. is full of antique and characteristic ideas wanting in ch. xxiv. That David is recognized by his voice is meaningless in xxiv. (comp. ver. 8), but appropriate in xxvi. 17.

<sup>5</sup> 1 Sam. xxiv. 7-12 must be compared with ch. xxx. 14, 16. The Cherethites whom the Amalekites attacked were Philistines. It must not therefore be supposed, as ch. xxvii. might seem to imply, that David systematically attacked populations friendly to Achish, and then pretended that he had been making forays against Judah. Such a policy could not have been long kept secret, and as it is pretty plain that the Philistines acquiesced in David's sovereignty in Hebron, it is not easy to see that they ever had an interest in embroiling him with the men of Judah. They coveted the richer lands of northern Canaan (1 Sam. xxxi. 7), and it would be their wise policy to detach Judah from Israel. The details of the text and meaning of 1 Sam. xxvi. 7-12 are very obscure.

was gone; and the Hebrews were again breaking up into parties, each ready to act for itself. Under such circumstances David might well feel that loyalty to his new master was his first duty. But he was providentially saved from the necessity of doing battle with his countrymen by the jealousy of the Philistine lords, who demanded that he be sent back to Ziklag. He returned to find the town pillaged by the Amalekites; but pursuing the foe he inflicted upon them a signal chastisement and took a great booty, part of which he spent in politic gifts to the leading men of the Judean towns.

Meantime Saul had fallen, and northern Israel was in a state of chaos. The Philistines took possession of the fertile lowlands of Jezreel and the Jordan; and the shattered forces of Israel were slowly rallied by Abner in the remote city of Mahanaim in Gilead, under the nominal sovereignty of Saul's son Ishbaal. The tribe of Judah, always loosely attached to the northern Hebrews, was in these circumstances compelled to act for itself. David saw his opportunity and advanced to Hebron, where he was anointed king of Judah at the age of thirty, and continued to reign for seven years and a half. His noble eulogy on the death of Saul and Jonathan, and his message of thanks to the men of Jabesh Gilead for their chivalrous rescue of the bodies of the fallen heroes, show how deeply he sympathized with the disasters of his nation; and even in northern Israel many now looked to him as their only helper (2 Sam. iii. 17). But David was not lacking in the caution and even craftiness proper to an Oriental hero; and he appears to have been careful not to irritate the Philistines by any premature national movement. As he retained Ziklag we must suppose that he had some agreement with his former suzerain Achish. Abner gradually consolidated the authority of Ishbaal in the north, and at length his forces met those of David at Gibeon. A sham contest was changed into a fatal fray by the treachery of Ishbaal's men; and in the battle which ensued Abner was not only defeated, but, by slaying Asahel, drew upon himself a blood feud with Joab. The war continued. Ishbaal's party waxed weaker and weaker; and at length Abner quarrelled with his nominal master and offered the kingdom to David. The base murder of Abner by Joab did not long defer the inevitable issue of events. Ishbaal was assassinated by two of his own followers, and all Israel sought David as king.

The Biblical narrative is not so constructed as to enable us to describe in chronological order the thirty-three years of David's reign over all Israel. Let us look at (1) his internal policy, (2) his relations to foreign nations, (3) other events.

1. Under the judges all authority was at bottom local or tribal, and the wider influence wielded by the more famous of these rulers took the form of a temporary pre-eminence or hegemony of the judge's own tribe. The kingdom of Saul was not radically different in character. There was no national centre. Saul ruled as a Benjamite from his paternal city of Gibeon (cf. 1 Sam. xxii. 7). At the risk of alienating the men of Judah, who in fact appear as the chief malcontents in subsequent civil disturbances, David resolved to break through these precedents, and to form a truly national kingdom independent of tribal feeling. The success of so bold a conception was facilitated by the circumstance that, unlike previous kings, he was surrounded by a small but thoroughly disciplined standing army, having gradually shaped his troop of freebooters into an organized force of 600 "mighty men" (Gibborim), always under arms, and absolutely attached to his person. The king began the execution of his plan by a stroke which at once provided a centre for future action, and gave the necessary prestige to his new kingdom. He stormed the Jebusite fortress of Jerusalem, which its inhabitants deemed impregnable, and here, in the centre of the country, on the frontier between Judah and Benjamin, he fortified the "city of David," the stronghold of Zion, and garrisoned it with his Gibborim. His next aim was to make Jerusalem the religious as well as the political centre of the kingdom. The ark of Jehovah, the only sanctuary of national significance, had remained in obscurity since its return from the Philistines in the early youth of Samuel. David brought it up from Kirjath-Jearim with great pomp, and pitched a tent for it in Zion, amidst national rejoicings. No action of David's life displayed truer political insight than this. (See ARK.) But the whole narrative (2 Sam. vi.) shows

that the insight was that of a loyal and God-fearing heart, which knew that the true principle of Israel's unity and strength lay in national adherence to Jehovah (comp. Ps. xv. and xxiv., one or both of which may refer to this occasion). It was probably at a later period, when his kingdom was firmly established, that David proposed to erect a permanent temple to Jehovah. The prophet Nathan commanded the execution of this plan to be delayed for a generation; but David received at the same time a prophetic assurance that his house and kingdom should be established for ever before Jehovah.

In civil and military affairs David was careful to combine necessary innovations with a due regard for the old habits and feelings of the people, which he thoroughly understood and turned to good account. The 600 Gibeonites, and a small body-guard of foreign troops from Philistia (the Cherethites and Pelethites), formed a central military organization, not large enough to excite popular jealousy, but sufficient to provide officers and furnish an example of discipline and endurance to the old national militia, exclusively composed of foot-soldiers.<sup>1</sup> In civil matters the king looked heedfully to the execution of justice (2 Sam. viii. 15), and was always accessible to the people (2 Sam. xiv. 4). But he does not appear to have made any change in the old local administration of justice, or to have appointed a central tribunal (2 Sam. xv. 2, where, however, Absalom's complaint that the king was inaccessible is merely factious). A few great officers of state were appointed at the court of Jerusalem (2 Sam. viii.), which was not without a splendor hitherto unknown in Israel. The palace was built by Tyrian artists. Royal pensioners, of whom Jonathan's son Mephibosheth was one, were gathered round a princely table. The art of music was not neglected (2 Sam. xix. 35). A more dangerous piece of magnificence was the harem, which, though always deemed an indispensable part of Eastern state, did not befit a servant of Jehovah, and gave rise to public scandal as well as to fatal disorders in the king's household. Except in this particular, David seems to have ventured on only one dangerous innovation, which was undertaken amidst universal remonstrances, and was checked by the rebukes of the prophet Gad and the visitation of a pestilence. To us the proposal to number the people seems innocent or laudable. But David's conscience accepted the prophetic rebuke, and he tacitly admitted that the people were not wrong in condemning his design as an attempt upon their liberties, and an act of presumptuous self-confidence (2 Sam. xxiv.).

2. David's wars were always successful, and, so far as we can judge from the brief record, were never provoked by himself. His first enemies were the Philistines, who rose in arms as soon as he became king of all Israel. We read of two great battles in the valley of Rephaim, westward from Jerusalem (2 Sam. v.); and a record of individual exploits and of personal dangers run by David is preserved in 2 Sam. xxi. and xxiii. At length the Philistines were entirely humbled, and the "bridle" of sovereignty was wrested from their hands (chap. viii. 1, Heb.). But the long weakness of Israel had exposed the nation to wrongs from their neighbors on every side; and the Tyrians, whose commerce was benefited by a stable government in Canaan, were the only permanent allies of David. Moab, an ancient and bitter foe, was chastised by David with a severity for which no cause is assigned, but which may pass for a gentle reprisal if the Moabites of that day were not more humane than their descendants in the days of King Mesha.<sup>2</sup> A deadly conflict with the Ammonites was provoked by a gross insult to friendly ambassadors of Israel; and this war, of which we have pretty full details in 2 Sam. x. 1-xi. 1, xii. 26-31, assumed dimensions of unusual magnitude when the Ammonites procured the aid of their Aramean neighbors, and especially of Hadadezer, whose kingdom of Zoba seems to have held at that time a pre-eminence in Syria at least equal to that which was afterwards gained by Damascus. The defeat of Hadadezer in two great campaigns brought in the voluntary or forced submission of all the lesser kingdoms of Syria as far as the Orontes and the Euphrates.<sup>3</sup> The glory of this victory was

increased by the simultaneous subjugation of Edom in a war conducted by Joab with characteristic severity. After a great battle on the shores of the Dead Sea the struggle was continued for six months. The Edomites contested every inch of ground, and all who bore arms perished (2 Sam. viii. 13; 1 Kings xi. 15-17; Ps. lx., title). The war with Ammon was not ended till the following year, when the fall of Rabbah crowned David's warlike exploits. But the true culminating point of his glory was his return from the great Syrian campaign, laden with treasures to enrich the sanctuary; and it is at this time that we may suppose him to have sung the great song of triumph preserved in 2 Sam. xxii. (Ps. xviii.). Before the fall of Rabbah this glory was clouded with the shame of Bathsheba, and the blood of Uriah.

3. As the birth of Solomon cannot have been earlier than the capture of Rabbah, it appears that David's wars were ended within the first half of his reign at Jerusalem, and the tributary nations do not seem to have attempted any revolt while he and Joab lived (comp. 1 Kings xi. 14-25). But when the nation was no longer knit together by the fear of danger from without, the internal difficulties of the new kingdom became more manifest. The inveterate jealousies of Judah and Israel reappeared; and, as has been already mentioned, the men of Judah were the chief malcontents. In this respect, and presumably not in this alone, David suffered for the very excellence of his impartial rule. In truth all innovations are dangerous to an Eastern sovereign, and all Eastern revolutions are conservative. On the other hand David continued to tolerate some ancient usages inconsistent with the interests of internal harmony. The practice of blood-revenge was not put down, and by allowing the Gibeonites to enforce it against the house of Saul, the king involved himself in a feud with the Benjamites (comp. 2 Sam. xxi. with chap. xvi. 8, which refers to a later date). Yet he might have braved all these dangers, but for the disorders of his own family, and his deep fall in the matter of Bathsheba, from which the prophet Nathan rightly foresaw fatal consequences, not to be averted even when divine forgiveness accepted the sincere contrition of the king. That the nation at large was not very sensitive to the moral enormities which flow from the system of the harem is clear from 2 Sam. xvi. 21. But the kingdom of David was strong by rising above the level of ordinary Oriental monarchy, and expressing the ideal of a rule after Jehovah's own heart (1 Sam. xiii. 14), and in the spirit of the highest teaching of the prophets. This ideal, shattered by a single grievous fall, could be restored by no repentance. Within the royal family the continued influence of Bathsheba added a new element to the jealousies of the harem. David's sons were estranged from one another, and acquired all the vices of Oriental princes. The severe impartiality of the sacred historian has concealed no feature in this dark picture,—the brutal passion of Amnon, the shameless counsel of the wily Jonadab, the black scowl that rested on the face of Absalom through two long years of meditated revenge,<sup>4</sup> the panic of the court when the blow was struck and Amnon was assassinated in the midst of his brethren. Three years of exile and two of further disgrace estranged the heart of Absalom from his father. His personal advantages and the princely lineage of his mother gave him a pre-eminence among the king's sons, to which he added emphasis by the splendor of his retinue, while he studiously courted personal popularity by a pretended interest in the administration of kingly justice. Thus ingratiated with the mass he raised the standard of revolt in Hebron, with the malcontent Judeans as his first supporters, and the crafty Ahithophel, a man of southern Judah, as his chief adviser. Arrangements had been made for the simultaneous proclamation of Absalom in all parts of the land. The surprise was complete, and David was compelled to evacuate Jerusalem, where he might have been crushed before he had time to rally his faithful subjects. Ahithophel knew better than any one how artificial and unsubstantial was the enthusiasm for Absalom. He hoped to strike David before there was time for second thoughts; and when Absalom rejected this plan, and acted on the assumption that he could count on the whole nation, he despaired of success and put an end to his own life.

<sup>1</sup> For the manner in which this national force was called out compare 1 Chron. xviii.

<sup>2</sup> David destroyed two-thirds of the Moabites—presumably of their fighting men (2 Sam. viii. 2). Mesha destroys every inhabitant of cities captured in honor of his god Chemosh.

<sup>3</sup> Hadadezer is also mentioned in 2 Sam. viii. in the general sum-

mary of David's wars, but we can hardly suppose that a different Syrian war is here meant.

<sup>4</sup> We owe this graphic touch to Ewald's brilliant interpretation of an obscure word in 2 Sam. xiii. 32.

David in fact was warmly received by the Gileadites, and the first battle destroyed the party of Absalom, who was himself captured and slain by Joab. Then all the people except the Judeans saw that they had been befooled; but the latter was not conciliated without a virtual admission of that prerogative of kinship to the king which David's previous policy had steadily ignored. This concession involved important consequences. The precedence claimed by Judah was challenged by the northern tribes even on the day of David's solemn return to his capital, and a rupture ensued, which but for the energy of Joab might have led to a second and more dangerous rebellion. The remaining years of David's life appear to have been untroubled, and according to the narrative of Chronicles the king was much occupied with schemes concerning the future temple. He was already decrepit and bed-ridden under the fatigues of seventy years, when the last spark of his old energy was called forth to secure the succession of Solomon against the ambition of Adonijah. It is noteworthy that, as in the case of Absalom, the pretensions of the latter, though supported by Joab and Abiathar, found their chief stay among the men of Judah (1 Kings i. 9).

The principles that guided David's reign are worthily summed up in his last words, 2 Sam. xxiii. 1, *seq.*, with which must be compared his great song of triumph, 2 Sam. xxii. The foundation of national prosperity is a just rule based on the fear of Jehovah, strong in His help, and swift to chastise wrong doers with inflexible severity. That the fear of Jehovah is viewed as receiving its chief practical expression in the maintenance of social righteousness is a necessary feature of the Old Testament faith, which regards the nation rather than the individual as the subject of the religious life. Hence the influence upon his life of David's religious convictions is not to be measured by the fact that they did not wholly subdue the sensuality which is the chief stain on his character, but rather by his habitual recognition of a generous standard of conduct, by the undoubted purity and lofty justice of an administration which was never stained by selfish considerations or motives of personal rancor,<sup>1</sup> and was never accused of favoring evil doers, and finally by the calm courage, rooted in faith in Jehovah's righteousness, which enabled him to hold an even and noble course in the face of dangers and treachery. That he was not able to reform at a stroke all ancient abuses appears particularly in relation to the practice of blood revenge; but even in this matter it is clear from 2 Sam. iii. 28, *seq.*, xiv. 1-10, that his sympathies were against the barbarous usage. Nor is it just to accuse him of cruelty in his treatment of enemies. Every nation has a right to secure its frontiers from hostile raids; and as it was impossible to establish a military cordon along the borders of Canaan, it was necessary absolutely to cripple the adjoining tribes. From the lust of conquest for its own sake David appears to have been wholly free.

The generous elevation of David's character is seen most clearly in those parts of his life where an inferior nature would have been most at fault,—in his conduct towards Saul, in the blameless reputation of himself and his band of outlaws in the wilderness of Judah, in his repentance under the rebuke of Nathan, and in his noble bearing on the revolt of Absalom, when calm faith in God and humble submission to His will appear in combination with masterly command over circumstances, and swift wisdom in resolution and action. His unflinching insight into character, and his power of winning men's hearts and touching their better impulses, appear in innumerable traits of the history (e.g., 2 Sam. xiv. 18-20; iii. 31-37; xxiii. 15-17). His knowledge of men was the divination of a poet rather than the acquired wisdom of a statesman, and his capacity for rule stood in harmonious unity with the lyrical genius that was already proverbial in the time of Amos (Amos vi. 5). To the later generations David was pre-eminently the Psalmist. The Hebrew titles ascribe to him 73 psalms; the Septuagint adds some 15 more; and later opinions, both Jewish and Christian, claimed for him the authorship of the whole Psalter (so the Talmud, Augustine, and others). That the tradition of the titles requires careful sifting is no longer questionable, as is admitted in such cases as Psa. lxxxvi., lxxxix., cxli. even by the cautious and conservative

<sup>1</sup> That Kuenen still follows Bayle in assigning revenge as the motive of David's charge to Solomon in 1 Kings ii. 8, 9, can only be matter of surprise. A young and untried sovereign could not afford to continue the clemency which his father was strong enough to extend to dangerous enemies.

Delitzsch. The biographer must therefore use the greatest circumspection in drawing from the Psalter material for the study of David's life and character. On the other hand, the tradition expressed in the titles could not have arisen unless David was really the father of Hebrew psalmody. As a psalmist he appears in 2 Sam. xxii., xxiii. in two poems, which are either Davidic or artificial compositions written in his name. If we consider the excellent information as to David which appears throughout the books of Samuel, the intrinsic merits and fresh naturalness of the poems, and the fact that Ps. xviii. is an independent recension of 2 Sam. xxii., the hypothesis that these pieces are spurious must appear very forced, though it has received the support of some respectable critics, especially of Kuenen,<sup>2</sup> who maintains that the religion of David is far below the level of the Psalter. If we reject this position, which can hardly be made good without doing great violence to the narrative of the books of Samuel, we cannot well stop short of the admission that the Psalter must contain Davidic psalms, some of which at least may be identified by judicious criticism, such as has been exercised by Ewald with singular insight and tact in his *Dichter des Alten Bundes*. Ewald claims for David Psa. iii., iv., vii., viii., xi., (xv.), xviii., xix., xxiv., xxix., xxxii., ci., and probably this list should rather be extended than curtailed. Compare Hitzig's *Psalmen*, Leipzig, 1863.

*Literature.*—The earliest notices of David in profane history are found in the fragments of Eupolemus preserved by Eusebius [Müller, *Fragm. Hist. Græc.* iii. 225; Freudenthal, *Alexander Polyhistor* (Breslau, 1875), p. 120 p. 225] and in Nicolaus of Damascus as quoted by Josephus, *Arch.* vii. 5. 2. [Müller l. c. iii. 373]. Josephus, *Arch.* vi. 8-vii. 15, has no sources independent of the Bible. Modern discussion of the life of David was stimulated in the first instance by the unfavorable judgment passed on his character by Bayle, the English free-thinkers, and Voltaire. Chandler's *Life of David* is mainly directed against Bayle (first edition 1766). The history of David is one of the best parts of Ewald's *Geschichte*. Stanley's picturesque narrative (*Lectures on the Jewish Church*, second series, 1805), and Dillman's lucid article in Schenkel's *Bibel-Lexikon*, rest mainly on Ewald. Stähelin's *Leben Davids* (Basel, 1866) is valuable for the numerous parallels adduced from Oriental history. Compare also Grätz's *Geschichte der Juden*, vol. i., Leipzig, 1874, and Hitzig's *Geschichte des Volkes Israel*, Leipzig, 1869. (w. n. s.)

DAVID (Welsh, *Dewi*), St., the patron saint of Wales, flourished in the 6th century. Various dates have been assigned for his birth and death, the earliest being that of Geoffrey of Monmouth, who fixes his death in 542, and the latest that of the *Annales Cambrie*, which fixes it in 601. Many writers follow Ussher in stating that he died in 544, aged eighty-two; but the latest authorities, Jones and Freeman (*History of St. David's*) and Haddan and Stubbs (*Councils and Ecclesiastical Documents*), accept the date of the *Annales Cambrie*. The narrative of St. David's life is overlaid with legendary matter to an unusual extent, and it is impossible to determine accurately what is historical and what is fictitious. Such stories as that he possessed the power of working miracles, even before his birth, that he was eighteenth in descent from the Virgin Mary, and that he was attended by an angel in his infancy, may obviously be referred at once to the latter category; but there are many other details which, even though not obviously improbable, must be regarded as extremely doubtful. According to the account given by Rice Rees (*Welsh Saints*) as historical, St. David was the son of Sandde or Xantus, prince of Ceretica (Cardiganshire), and was born at Hen-Menen or Menevia (now St. David's). After spending a number of years at the college of a celebrated teacher, Paulinus, he founded a college or monastery in the Vale of Rhos, near his native place, which was distinguished for the severity of its rule. His fame as a theologian led to his being summoned to the synod of Bresi to confute the Pelagian heretics. So well did he acquit himself of this task that the synod elected him archbishop of Caerleon and primate of Wales,—Dubricius, the occupant of the see, having resigned to make room for him. Soon after his election St. David found it necessary to convene another synod, which is styled in the annals the Synod of Victory, so complete was the triumph obtained over the Pelagians. Somewhat later the primate obtained leave to transfer his seat from Caerleon to Menevia (St. David's). He died at an advanced age, and was buried in the church.

<sup>2</sup> *Historisch-kritisch Onderzoek* (Leiden, 1865), vol. iii. p. 149.

of St. David's. His shrine is to be seen in the existing cathedral. Recent criticism, while admitting that St. David founded a see at Menevia, and that he probably took an active part in the undoubtedly historical synod of Breff, has discredited his archiepiscopal jurisdiction. This is almost certainly the invention of those in a later age who wished to maintain the independence of the Welsh church, and supremacy in that church of the see of St. David's. It was the view that naturally commended itself to the author of the earliest life of St. David, Rhythmark, or Rice-marchus, bishop of St. David's in the 11th century, who wrote at a time when the independence of the Welsh church was seriously threatened. His narrative is followed in the main by Giraldus Cambrensis and later authorities. St. David was canonized by Pope Calixtus II. in the 12th century. His festival is celebrated on the 1st March.

DAVID, FÉLIX-EN CÉSAR (1810-1876), a French composer, was born at Cadenet, in the department of Vaucluse, March 8, 1810. As a child he exhibited proofs of unusual precocity, and at the age of four had made considerable progress in his musical studies. Being early left an orphan, and totally unprovided for, he obtained, through the influence of relatives, admission to the choir of Saint-Sauveur at Aix. Subsequently he entered into the employment of an attorney, but quitted his service to become successively *chef-d'orchestre* in the theatre at Aix, and chapel-master of the church in which he had formerly appeared as a humble chorister. He next proceeded to Paris, where he subsisted for some time on a pittance of 50 francs a month, afforded him by a rich but miserly uncle. After pursuing diligently a course of studies at the Conservatoire under Fétis, Reber, and others, he cast in his lot with the Saint-Simonians, and on the dispersion of that sect in 1833 accompanied several of the brethren on a fruitless expedition to the East. The immediate result of this tour was the publication, on his return to Paris, of the *Melodies Orientales*, which met with little encouragement. Nine years after this, however, the musical world was suddenly startled by the production of the *Désert*, a work abounding in graceful melodies, and affording proof of an extensive acquaintance with orchestral effects. This ode-symphony, as it was called, rapidly gained for the composer a widespread reputation. It was, after some vexatious delays, first performed at the Conservatoire in 1844, and quickly found a hearing in every European capital. Enthusiasts were not slow to predict for David a brilliant career, but their hopes were scarcely realized. Nothing the composer afterwards wrote at all equalled the *Désert*. In the *Christophe Colomb* (1847) there are noble passages, and the comic opera of *Lalla Rookh* possesses numbers graced by a captivating delicacy of orchestration, but neither for these nor for his other principal works—*Moïse au Mont Sinai* (1846), *La Perle du Brésil* (1851), and *Herculanæum* (1859)—can a place be claimed in the foremost ranks of composition. They were of sufficient merit, however, to gain for him the biennial prize of the emperor, which was awarded by the French Institute in 1868. In the following year he was appointed to the post of librarian at the Conservatoire, vacated by M. Berlioz, whom he afterwards succeeded as a member of the Institute. He died on the 29th of August, 1876, aged sixty-six.

DAVID, JACQUES LOUIS (1748-1825), historical painter, was born in Paris in 1748. His father having been killed in a duel, a maternal uncle first placed him in the Collège des Quatre-Nations and afterwards in an architect's office. An accidental visit to the studio of his great-uncle, Boucher, led him to leave his adopted profession; and Boucher, observing the boy's distaste for his own erotic style, sent him to Vien, who, having succeeded to the directorship of the French Academy in Rome just at the time his pupil had taken the grand prize (1775), carried the youth with him to that city. At this time Winckelmann was writing, Raphael Mengs painting, and the taste for classic severity was a necessary reaction on what had gone before. This is shown by Carstens and the younger Germans very shortly after following a quite independent movement of the same nature. David's classicism was directly derived from the antique, and easily understood. The spirit of the day made the first picture, "Date Obolum Belisario," painted according to his new principles, a complete success, and this was followed by others more perfect—The Grief of Andromache, The Oath of the Horatii, the Death of Socrates, and the Rape of the

Sabine Women, now in the Louvre. In the French drama an unimaginative imitation of ancient models had long prevailed; even in art Poussin and Le Sueur were successful by expressing a bias in the same direction; and in the first years of the revolutionary movement, the fashion of imitating the ancients even in dress and manners went to the most extravagant length. At this very time David returned to Paris; he was now painter to the king, Louis XVI., who had been the purchaser of his principal works. It is not possible to overestimate the popularity of the young painter, who was himself carried away by the flood of enthusiasm that made all the intellect of France believe in a new era of equality and emancipation from all the ills of life.

Sent to the Convention in September, 1792, by the Section du Musée, he quickly distinguished himself by the defence of two French artists in Rome who had fallen into the merciless hands of the sbirri of the Inquisition; and as the behavior of the authorities of the French Academy in Rome had been in obedience to old slavish ideas, he had the influence to get it suppressed. In January following his election into the Convention his vote was given for the king's death. Thus the man who was so greatly indebted to the Roman Academy and to Louis XVI. assisted resolutely in the destruction of both. This line of action was no doubt a kind of self-sacrifice to him. It was in obedience to a principle, like the dreadful act of Brutus condemning his sons,—a subject he painted with all his powers. Cato and Stoicism were the order of the day. Hitherto the actor had walked the stage in modern dress. Brutus had been applauded in red-heeled shoes and *culottes jarretées*; but Talma, advised by David, appeared in the toga and sandals before an enthusiastic audience. At this period of his life Mdle. de Noailles thought to make a good impression upon him by insisting on his painting a sacred subject, with Jesus Christ as the hero. When the picture was done, the Saviour was found to be another Cato. "I told you so," he replied to the expostulations of the lady; "there is no inspiration in Christianity now!" He accordingly developed the scheme of the *Fête à la Ebre Suprême*, and he remained the master of pageants for a long period, escaping the guillotine only by the regard paid to his character as an artist. When Napoleon destroyed the new-found liberty, and expunged the novel gospel, David succumbed to the military spirit and well-nigh worshipped him. His picture of Napoleon on horseback pointing the way to Italy is now in Berlin.

We have mentioned the principal classic subjects painted by David. They are hard and dry in execution, painted on a white ground with opaque but splendid color, which has, however, really little charm. The other class of works which came from his easel was commemorative of the Revolution. When Lepelletier was assassinated in the Palais Royal, after the vote for the death of the king, David painted the subject, and the picture was exhibited in the Convention with much emotion. Marat Dead in the Bath is a work of a very impressive kind. The Oath in the Tennis Court is another very important production, both historically and in relation to the artist. His extensive commissions from the emperor are still objects of attraction at Versailles. On the return of the Bourbons our painter was exiled with the other remaining regicides, and retired to Brussels, where he recommenced his classic series by the Loves of Paris and Helen. Here he remained till his death, 29th December, 1825, at the age of seventy-seven, having rejected the offer made through Baron Humboldt of the office of minister of fine arts at Berlin. His end was true to his whole career and to his nationality. While dying, a print of the Leonidas, one of his favorite subjects, was submitted to him. It was placed conveniently, and after vaguely looking at it a long time, "Il n'y a que moi qui pouvais concevoir la tête de Léonidas," he whispered, and died. His friends and his party thought to carry the body back to his beloved Paris for burial, but the Government of the day arrested the procession at the frontier, an act which caused some scandal, and furnished the occasion of a terrible song of Beranger's. Gros, Girodet, and Gérard were David's best pupils.

DAVID, JEAN PIERRE (1789-1856), usually called David d'Angers, a much-admired French sculptor, and, like David the painter, to whom he was in no other way related, a demonstrative partisan of advanced ideas in

politics and religion, was born at Angers, 12th March, 1789. His father was a sculptor, or rather a carver, but he had thrown aside the mallet and taken the musket, fighting against the Chouans of La Vendée. He returned to his trade at the end of the civil war, to find his customers gone, so that young David was born into poverty. As the boy grew up his father wished to force him into some more lucrative and certain way of life. At last he succeeded in surmounting the opposition to his becoming a sculptor, and in his eighteenth year left for Paris to study the art upon a fund of eleven francs. As far as we know his works, the genius on which he relied was not very great; but after struggling against want for a year and a half, he succeeded in taking the prize at the Ecole des Beaux Arts. Energy and perseverance stood in the place of natural ability, and now fortune aided him in the shape of an annuity of 600 francs (£24), granted by the municipality of his native town, by the name of which he was proud to be called ever after. This was in 1809, and in 1811 his Epaminondas gained the prize of Rome, where he spent five years, rather too much impressed by the works of Canova.

Returning from Rome about the time of the restoration of the Bourbons, he would not remain in the neighborhood of the Tuileries, swarming with foreign conquerors and returned royalists; he found his way to London, having made several English acquaintances in Rome. Here, if we are to believe the statement in his biography, he was offered the commission to erect a monument commemorative of Waterloo,—more probably he received an invitation to offer a design for some such work, which he might misunderstand from his ignorance of English. At the same time his resources were exhausted, and Flaxman and others visited upon him the sins of David the painter, to whom he was supposed to be related. With great difficulty he made his way to Paris again, where a comparatively prosperous career opened upon him. His medallions and busts were in much request, and monumental works also came to him. One of the best of these was that of Gutenberg at Strasburg; but those he himself valued most were the statue of Barra, a drummer-boy who fell in the war in La Vendée, who continued to beat his drum till the moment of death, and the monument to the Greek liberator, Bozzaris. This was a young female figure he called "Reviving Greece," of which his friend Victor Hugo says rather absurdly, "It is difficult to see anything more beautiful in the world; this statue joins the grandeur of Phidias to the expressive manner of Puget." His busts and medallions were very numerous, and among his sitters may be found not only the illustrious men and women of France, but many others both of England and Germany—countries which he visited professionally in 1827 and 1829. His medallions, it is affirmed, number 500. He died on the 4th of January, 1856.

David d'Angers was respected for his consistency and benevolence. As an example of the latter may be mentioned his rushing off to the sickbed of Rouget de Lisle, the author of the *Marseillaise Hymn*, modelling and carving him in marble without delay, making a lottery of the work, and possibly saving the poet's life by sending him the proceeds, £72, when in the extremity of need.

DAVID HA-COHEN, a learned Rabbín, was born at Lara, in Spain, about the beginning of the 17th century, and died at Hamburg in 1674. He was chief of the synagogue at Amsterdam, and he afterwards held the same office at Hamburg. From this he was deposed on a suspicion of an intention to become a Christian, which seems to have been unfounded. It probably originated in the fact that he held more liberal sentiments than those which prevailed in the Jewish community of his time. David was the author of several works of value in the department of rabbinical literature. The most important is the *Corona Sacerdotum* (Hamburg, 1667), a Talmudic and rabbinical dictionary, which was printed only as far as the letter *Yod*, though the author carried on the work to the letter *Resh* after forty years' labor. A small portion of the dictionary was printed at Amsterdam in 1648 as a specimen, with the title *Civitas David*.

DAVIDISTS, a name borne by two distinct sects in the history of the Christian church. 1. It is sometimes applied to the followers of David of Dinant, whose work entitled *Quaternarii* was condemned at the Synod of Paris in 1209. The works of Amalric of Bena were condemned

at the same synod, but this is scarcely a sufficient ground for classing David of Dinant among his followers. Our information as to the views of the latter is derived from the *Summa* of Albertus Magnus and the *Summa* of Thomas Aquinas. He founded upon the Platonists and the Arabian philosophers his fundamental doctrine that the Deity alone has any real existence, being the *materia prima* of all things. 2. The name Davidists, or David-Georgians, is more commonly applied to the followers of David George, or Joris, who was born at Delft in 1501. In 1530 he was punished by whipping, the boring of his tongue, and imprisonment for obstructing a Catholic procession in his native town. In 1534 he joined the Anabaptists, but soon afterwards he founded a sect of his own. In 1542 he published his *Book of Wonders*, containing an account of visions and revelations he professed to have had. Two years later he settled down as a merchant at Basel, where he lived in prosperity for twelve years under the assumed name of Johann von Brügg. After his death his son-in-law, offended probably at the disposition he made of his property, instituted a process of heresy against him; and his body was exhumed and burnt by order of the senate of Basel. The Davidists, under the leadership of Henry Nicolas, afterwards became known in Holland and England as the Familists. They interpreted the whole of Scripture allegorically, and maintained that as Moses had taught hope, and Christ had taught faith, it was their mission to teach love. The service of love was the highest and best of the dispensations. The result was an extreme Antinomianism in practice, which attracted the notice of the civil authorities in both countries. The sect was suppressed or absorbed in other sects early in the 17th century.

DAVIES, SIR JOHN (1669-1826), philosophical poet of the age of Elizabeth, was baptized on the 16th of April, 1669, at Tisbury, in Wiltshire, where his parents lived in the manor-house of Chickagrove. He was sent first to Winchester College, and afterwards to New College, Oxford. In 1685 he became a commoner of Queen's College, Oxford, and in 1687 entered at the Middle Temple. Bereft of both his parents at a very early age, he seems to have plunged into all the dissipations that London could offer in those days to a rich young man of fashion. It is amusing to find the future attorney-general of Ireland, and grave Christian poet, connected, beyond all concealment, with one of the worst literary scandals of the period. One would be very glad to know what circumstances led to the publication of the notorious and now excessively rare little volume that bears the title *All Ovid's Elegiacs, 3 Books, by C. M. Epigrams by J. D. At Middleburgh*, in which Marlowe had a share, and which was condemned by the archbishop to be burned. The *Epigrams* are far from edifying or promising, and we may, in the absence of a date, be permitted to put the earliest possible 1592 or 1593, on their unseemly boisterousness. In 1593 was ready for the printer, though not, it would seem, published till 1596, a far more worthy work, the charming and singular fragment called *Orchestra*, a little epic written in praise of dancing, in fifteen consecutive days. The poet seeks to prove that every harmonious movement of nature, every action of the elements, every motion in the firmament, is a conscious and well-ordered dance; also that plants in growing, men in all their familiar and noble exercises, the angels themselves, and all the mysterious translunary world effect a solemn dancing in their motion. *Orchestra* was dedicated to the author's "very friend," Master Richard Martin, a riotous youth whom, in the winter of 1597, Davies, the friends having quarrelled, attacked with a cudgel in the hall of the Middle Temple. For this offence he was expelled and degraded. Rusticating at Oxford, he spent the first year after his expulsion in the composition of his great philosophical poem, *Nosce Teipsum*, which appeared in 1599. It is on this work that his fame mainly rests. The style was entirely novel in that age; and its force, eloquence, and ingenuity, no less than the modern and polished tone of the periods, made it at once extremely popular. It was to its own age all that Pope's *Essay on Man* was to the Georgian period. In the same year, 1599, there saw the light a little book of exquisite lyrics from the same hand, *Hymns to Astræa*, twenty-six acrostics on the words *Elizabetha Regina*, which all warble with the most delightful sweetness. In 1601 Davies was restored to his position at the bar, without loss of seniority. About the same time he sat in Elizabeth's last Parliament, as



member for Corfe Castle. At Elizabeth's death he was instantly received with great favor by James I., and sent to Ireland as solicitor-general in 1603. On December 18 of that year he was knighted at Dublin. From this time forth he abandoned poetry in favor of the most active statesmanship. His activities in Ireland were almost ubiquitous. In 1606 he was further promoted to be attorney-general for Ireland, and created sergeant-at-arms. In the disordered condition of the country he was required to be stirring at all times, and his abilities seem to have been as conspicuous as his trustworthiness and uprightness. He married Eleanor, daughter of the earl of Castlehaven, but she unfortunately became insane. In 1612 Davies published his valuable prose work, *A Discourse of the True Reasons why Ireland has never been entirely subdued*. The same year he represented the county of Fermanagh in the Irish Parliament, and was elected speaker. In 1614 he represented Newcastle-under-Lyne in the English Parliament, and in 1619 he threw up his appointments in Ireland. In 1622 he issued a collected edition of his poetical works. In 1626 Davies was appointed lord chief justice of England, but ere he could enter on the office, he was found dead in his bed (December 8), the victim, it was supposed, of apoplexy.

The prose writings of this remarkable man were mainly posthumous, and no attempt was made to collect them, until they were republished in four volumes by the Rev. A. B. Grosart, in 1876, with a full and interesting biography. The poetical works have often been reproduced since the author's lifetime.

Sir John Davies is not to be confounded with JOHN DAVIES of Hereford, a contemporary author of a great quantity of verse, of which *The Holy Roods* (1609), *The Scourge of Folly* (1611), and *The Muses' Sacrifice* (1612) are fair typical examples. Gifted with extraordinary volubility and self-confidence, but with no delicacy or taste, the writings of this John Davies have survived more by reason of their bulk and their accidental interest of reference or dedication than from any intrinsic merit.

DAVILA, HENRICO CATERINO (1576-1631), historian, was descended from a Spanish noble family. His immediate ancestors had been constables of the kingdom of Cyprus for the Venetian republic, from father to son, since 1464. But in 1570 the island was taken by the Turks; and Antonio Davila, the father of the historian, had to leave it, despoiled of all he possessed. He travelled into Spain and France, and finally returned to Padua, where, in 1576, his youngest son was born, whom he named Henrico Caterino, in gratitude for the kindness received from Catherine de' Medici at the French court. At the age of seven the father took this son to France, where he became a page in the service of Catherine. In due time he entered the service, and fought through the civil wars till the peace in 1598. He then returned to Padua, where, and subsequently at Parma, he led a studious life, till on the breaking out of war he entered the military service of the republic of Venice, in which he served with distinction. But during the whole of this active life—many details of which are very interesting as illustrative of the life and manners of the time,—he never lost sight of a design which he had formed at a very early period, of writing the history of those civil wars in France, in which he had borne a part, and had so many opportunities of closely observing the leading personages and events. The manuscript of this work was completed in, or a little previous to, 1630, and was offered in vain by the author to all the publishers in Venice, and this city was then a great publishing centre. At last one Tommaso Baglioni, who had no work for his presses, undertook to print the manuscript on condition that he should be free to leave off if more promising work offered itself. The printing of the *Istoria delle Guerre Civili di Francia* was, however, completed, and the success and sale of the work were immediate and enormous. Many other editions rapidly followed, of which perhaps the best altogether is that of Milan, in 6 vols. 8vo, 1807. Davila was murdered, while on his way to take possession of the government of Crema for Venice in July, 1631, by a ruffian, with whom some dispute seems to have arisen as to the furnishing of the relays of horses ordered for his use by the Venetian Government.

The *Istoria* was translated into French by J. Baudouin, Paris, 1642; into Spanish by Varen de Soto, Madrid, 1651, and Antwerp, 1686; twice into English by W. Aylesbury, London, 1647,

and by Charles Cottarel, London, 1666, and into Latin by Pietro Francesco Cornassano, Rome, 1745. The best account of the life of Davila is that by Apostolo Zeno, prefixed to an edition of the history printed at Venice in 2 vols. fol. in 1732. Tiraboschi may also be consulted with advantage. Bayle is severe on certain historical inaccuracies of Davila. And it is true that Davila must be read with due remembrance of the fact that he was not only a Catholic but the especial protégé of Catharine de' Medici. Also it is not to be forgotten that Bayle was so strongly Protestant. As to the literary merits of Davila, his lucidity, purity of style, abundance of information, there has never been, and never can be, any difference of opinion.

DAVIN, FELIX, a French novelist of most brilliant promise, the fulfilment of which, however, was in a great measure prevented by his early death. Born at St. Quentin, in 1807; died in 1836.

DAVINI, GIOVANNI BATTISTA, an Italian physician of considerable note in his day, was born in 1562, at Cam-porgiano; died in 1633.

DAVIS, JOHN, a celebrated English navigator of the 16th century. The date of his birth is unknown; the place was Sandridge, about 8 miles N. of Dartmouth, in Devonshire. He made three voyages under the auspices of the English Government in search of the north-west passage to the Pacific. In the first, in 1585, he pushed his way round the southern end of Greenland, across the strait that now bears his name, and along the coast of what is now known as Baffin's Land, to the Cape of God's Mercy, which he thus designated in the fond belief that his task was practically accomplished; in the second (1586) he made but little further progress; in the third (1587) he reached the entrance to the strait afterwards explored by Hudson. Four years later he joined Cavendish in his second voyage to the South Sea; and after the rest of the expedition returned unsuccessful, he continued to attempt on his own account the passage of the Strait of Magellan; he was defeated, but became the discoverer of the Falkland Islands. The passage home was extremely disastrous, and he brought back only 16 of the 76 men whom he had taken with him. In 1598 he took a merchant fleet from Middleburg in Holland to the East Indies; in 1601 he accompanied Sir James Lancaster as first pilot on his voyage in the service of the East India Company; and in 1605 he sailed again for the same destination along with Michelbourn. On his way home he was killed by pirates off the coast of Malacca.

*A Traverse Book made by John Davis in 1587, an Account of his Second Voyage in 1586, and a Report of Master John Davis of his three voyages made for the Discoverie of the North West Passage* were printed in Hakluyt's collection. Davis himself published *The World's Hydrographical Description, whereby it appears that there is a short and speedie Passage into the South Seas, to China, etc., by Northerly Navigation*, London, 1596, and *The Seaman's Secrets, divided into two parts*, London, 1596.

DAVY, SIR HUMPHRY (1778-1829), the eminent natural philosopher, was born on the 17th of December, 1778, at Penzance, in Cornwall. After receiving there the rudiments of his education, he was in 1792 sent for a year to the grammar school of Truro, then under the direction of the Rev. Dr. Cardew. There is little to record of Davy's early life except his retentive memory, facility in versification, and skill in story-telling. At the age of nine he went to live with Mr. John Tonkin, who had formerly adopted Davy's mother and her sisters. In 1794 Davy lost his father, and in the following year he was apprenticed to Mr. Borlase, then a surgeon-apothecary, and afterwards a physician in Penzance. During his apprenticeship he spent much of his leisure in a systematic course of self-education. While yet young he had exhibited an inclination for devising experiments, and for examining natural products. At the end of 1797, when in his nineteenth year, he turned his attention to chemistry, and read Lavoisier's and Nicholson's treatises on that subject. His experiments were conducted in the garret of his friend Mr. Tonkin, who, alarmed by unexpected explosions would exclaim, "This boy Humphry is incorrigible!"—"Was there ever so idle a dog!"—"He will blow us all into the air!" One of his investigations at this time was the nature of the air contained in the vesicles of sea-weed. To supply the place of an air-pump in his experiments he had an old French injecting syringe, and this he actually employed in his first scientific paper "On the Nature of Heat and Light," published in 1799. Though Davy's natural talents would not have permitted him to remain long in obscurity, he was in some degree

indebted for an early emergence into publicity to the accidental notice of Mr. Davies Giddy Gilbert, who, learning that the strange-looking boy, whom he observed hanging over the hatch of Mr. Borlase's house, was a son of Davy the carver, and fond of making chemical experiments, sought his acquaintance, and was ever afterwards his steady friend. Another early friend of Davy's was Mr. Gregory Watt, who, having visited Penzance in 1797 for change of air, took lodgings at the house of Mrs. Davy. By him and Gilbert he was introduced to the notice of Dr. Beddoes, who in the autumn of 1798 engaged him to superintend a pneumatic medical institution, which he had just established at Bristol. Davy was now placed in a sphere where his genius could expand; he was associated with men of education and scientific attainments, and was provided with excellent apparatus; thus he speedily entered upon that career of discovery which has rendered his name illustrious. He had intended, after the termination of his engagement with Dr. Beddoes, to study medicine at Edinburgh, but the all-engrossing interest of his chemical discoveries caused him eventually to abandon this scheme.

In an essay "On Heat, Light, and Respiration," written before he left Cornwall, but published soon after his removal to Bristol, in Beddoes's *West Country Contributions*, Davy endeavored to prove the immateriality of heat, by showing its generation through the friction of two pieces of ice under an exhausted receiver. His first scientific discovery was that of the existence of silica in the epidermis of the stems of reeds, corn, and grasses. The intoxicating effects of nitrous oxide when respired were discovered by him on April 9, 1799; and in the following year he published a volume entitled *Researches, Chemical and Philosophical, chiefly concerning Nitrous Oxide and its Respiration*. Whilst the impression created by this publication was still fresh on the public mind, Davy was recommended to Count Rumford by Mr. Underwood and Dr. Hope as a suitable person to succeed Dr. Garnet as lecturer on chemistry at the Royal Institution recently established in London; and accordingly, on February 16, 1801, he was chosen assistant lecturer to the Institution, and director of the laboratory; his appointment to the lectureship took place six weeks later. A minute on the records of the Royal Institution shows that he was appointed professor of chemistry on the 31st of May, 1802.

The ungainly exterior and peculiar manner of Davy on his first appearance in London prejudiced Rumford and others against him; when, however, he began to lecture, he won the approbation of all. His ingenuity and happy facility of illustration gained him a high reputation; his company was courted by the choicest society of the metropolis; and soon his presence was regarded as indispensable in the soirées of the fashionable world. His style of lecturing was well adapted to command attention—it was animated, clear, and impressive, notwithstanding the naturally inharmonious tones of his voice; his experiments, moreover, were both ingeniously conceived and neatly executed. The young chemist was fortunate in the time in which he commenced his metropolitan career. Experimental chemistry was beginning to be the fashion of the day; and the discovery of the decomposition of chemical substances by voltaic electricity had excited the greatest interest amongst the votaries of science. The liberality of the committee of the Royal Institution supplied to Davy what few private individuals could afford—a battery of 400 five-inch plates, and one of 40 plates a foot in diameter. With these were conducted the brilliant investigations which resulted in his discovery of potassium and sodium.

The earliest of Davy's communications to the Royal Society, and the first of his contributions to electro-chemistry, was "An Account of some Galvanic Combinations formed by an arrangement of single Metallic Plates and Fluids," read in June, 1801. In all hitherto constructed piles, plates of two metals, or one plate of metal and another of charcoal, and some interposed fluid had been employed. Davy showed in this paper that a battery might be constructed of a single metal and two fluids, provided one of the fluids was capable of causing oxidation on one of the surfaces of the metal. In addition to the duties of his situation in the Royal Institution, to which those of joint editor of the *Journal* had been added, Davy for ten successive years gave courses of lectures for the Board of Agriculture on the connection between agriculture and chemistry. In 1803 he was admitted a member of the Royal Society, of which he, in January,

1807, became the secretary. The most valuable of all his scientific writings are his communications to the Royal Society, scarcely one of which does not announce some new and important fact, or elucidate some principle of experimental philosophy. In February, 1803, he read to the society an essay "On Astringent Vegetables, and their Operation in Tanning;" and in 1805 "An Account of some Analytic Experiments on Wavellite," and a paper "On the Method of Analyzing Stones containing a Fixed Alkali, by Boracic Acid." This method is founded on the strong affinity of that acid for different substances at a high temperature, and on the ease with which borates are decomposed by mineral acids.

In his first Bakerian lecture, delivered to the Royal Society in November, 1806, Davy showed that electro-chemical phenomena were explicable by one general law, and illustrated his theory of voltaic action by numerous happily-devised experiments. After pointing out that in all voltaic decompositions acids appeared at the positive and bases at the negative pole, he generalized his results by stating that hydrogen, the alkalis, earth, metals, and certain oxides are attracted by negatively electrified and repelled by positively electrified metallic surfaces, and that oxygen and acids are attracted by positively and repelled by negatively electrified metallic surfaces. He then proceeded to investigate the law of electro-chemical action, and concluded that electro-chemical combinations and decompositions are referable to the law of electric attractions and repulsions, and that both "chemical and electrical attractions are produced by the same cause, acting in the one case on the particles, in the other on the masses." For these researches the French Institute awarded him the prize of 3000 francs offered by the first consul for the experiment most conducive to the progress of science. Davy's discovery of the production of potassium and sodium by the electrical decomposition of their alkalis was made in October, 1807, and an account of the new metals was given to the Royal Society on the 19th of November in the second Bakerian lecture. On the 23d of that month a severe fever attacked him, and he was unable to resume his professorial duties at the Royal Institution till March 12, 1808. In the meanwhile barium and calcium, the existence of which had been predicted by Davy, were discovered by Berzelius and Pontin. In 1808 Davy announced to the Royal Society his discovery of magnesium and strontium. Alumina, silica, and zirconia he was unable to decompose, but he showed it to be highly probable that they contained metallic bases. Various opinions as to the nature of the new metals of the alkalis and alkaline earths were at first entertained, some chemists considering them to be compounds of hydrogen with unknown bases. In the third Bakerian lecture, read in December, 1808, and its appendix of next spring, Davy adduced conclusive evidence of the elementary nature of potassium; he discussed also the nature of sulphur, phosphorus, and carbon, and described the preparation of boron, which he then regarded as a metal. The original galvanic batteries used by Davy having become un-serviceable through wear, a liberal voluntary subscription among the members of the Royal Institution, in July, 1808, put him in possession of a battery of 2000 double plates, with a surface equal to 128,000 square inches. His electro-chemical discoveries had, however, all been made before this new power was provided. The fourth Bakerian lecture, read in November, 1809, brings forward proofs that oxymuriatic acid, contrary to Davy's previous supposition, is a simple body, termed by him chlorine (see vol. v. p. 589), and that muriatic acid is a compound of that element and hydrogen.

Davy's reputation had now reached its zenith; and his audience in the theatre of the Royal Institution numbered little less than 1000. At the invitation of the Dublin Society he gave, in November, 1810, a course of lectures on electro-chemical science, and in the following year other courses on the elements of chemical philosophy and on geology. For the first of these he received £525, and for the two latter £750; and before he left Dublin, Trinity College conferred upon him the degree of LL.D. On the 8th of April, 1812, Davy was knighted by the Prince Regent; on the next day he gave his farewell lecture at the Royal Institution; and on the 11th he married Mrs. Apreece, daughter and heiress of Charles Kerr of Kelso, with whom he had a considerable fortune. His usual employments were in great measure suspended during the

winter of 1812 in consequence of an injury to an eye, resulting from an explosion of chloride of nitrogen, which he had begun to experiment upon after receiving intelligence of its discovery by Dulong. The first and, as it proved, the only volume of Davy's *Elements of Chemical Philosophy* appeared in 1812; and in 1813 he published his *Elements of Agricultural Chemistry*, the substance of his lectures delivered to the Board of Agriculture.

Having obtained from the French emperor permission to travel in France, Davy, on October 13, 1813, went thither with his wife and Faraday, the latter in the capacity of "assistant in experiments and writing." Faraday had been engaged on the 1st of March previous to help Davy in the laboratory of the Royal Institution. On the 29th of October, after a detention of six or seven days at Morlaix, Davy arrived in Paris, where he stayed two months, and began the course of investigation on iodine which enabled him to prove its elementary character. This body had hitherto been regarded as a compound by the French chemists. On the 18th of December Davy was elected a corresponding member of the first class of the Imperial Institute at Paris. From Paris he proceeded, in the end of December, to Montpellier, and thence to Italy. At Genoa and Florence he continued his experiments on iodine; and at the latter place he effected the combustion of the diamond by means of the great lens in the cabinet of natural history, and discovered that, when once ignited, it will continue to burn in pure oxygen. He next proceeded by Rome to Naples, where he collected specimens of the colors used by the ancients in their pictures, which formed the subject of a memoir presented to the Royal Society. After spending the winter in Italy, he returned to London on April 23, 1815.

The year 1815 is memorable in the history of Davy, as that in which he turned his attention to the frequent occurrence of accidents from explosions of fire-damp in coal-mines. At his request specimens of the gas were sent from Newcastle to London for him to examine. He ascertained that it would not explode when mixed with less than six or more than fourteen times its volume of air, with one-seventh its volume of carbonic acid gas, or with one-sixth its volume of nitrogen; that in tubes one-seventh of an inch in diameter explosive mixtures of air and fire-damp could not be fired; and that metallic tubes prevented explosions better than glass tubes. On November 9, 1815, Davy made known to the Royal Society these results of his experiments; and before the close of the year he had completed the invention of what has since been known as the Davy safety-lamp (see p. 68 of the present volume). In this a cage of wire-gauze, by its cooling action, prevents the flame from igniting an explosive atmosphere exterior to the lamp, even though the flame reach as far as the gauze. Of this invaluable aid to the miner the coal-owners of Newcastle and its vicinity were not slow in availing themselves; and on the 11th of October, 1817, they testified their appreciation of the boon disinterestedly conferred upon them by Davy, who had taken out no patent for his invention, by presenting him with a suitably inscribed service of plate. In the succeeding year Davy was created a baronet. For his various communications to the Royal Society on the subject of fire-damp, and on the nature of flame, in 1815, 1816, and 1817, he received the Rumford medals.

In 1818 and 1819 he produced four memoirs, "On the Fallacy of the Experiments in which Water is said to have been produced by the Decomposition of Chlorine," "On some Combinations of Phosphorus," "Observations on the Formation of Mists over Lakes and Rivers," and "On Electro-Magnetism." In 1818 he was sent by the British Government to examine the papyri of Herculaneum in the Neapolitan Museum, his remarks on which are contained in a paper in the *Philosophical Transactions* for 1821. In 1820 Davy returned to England, and on the death of Sir Joseph Banks, in that year, he was elected president of the Royal Society; in this position, however, it cannot be said that he always appeared to advantage, or on every occasion acted in a manner calculated to render himself popular amongst the members. In 1821 he busied himself with electrical experiments, and in 1822 with the investigation of the fluids contained in the cavities of crystals in rocks. In 1823 he read before the Royal Society a paper "On the Application of Liquids formed by the Condensation of Gases as Mechanical Agents." In the same year he investigated the cause of the rapid destruction of the copper sheathing of sea-going ships. It occurred to him that, as

sea-water acts only on positively electrified copper, the sheathing would be protected if he could render it slightly negative. He found that plates of copper having portions of iron or zinc attached remained unchanged after prolonged immersion in sea-water. In consequence of this discovery directions were given by the Government, after some preliminary experiments, to apply plates of iron, or "protectors" as they were called, to several ships of the royal navy; many merchantmen also were supplied with them. Experience, however, showed that the bottoms of the protected ships soon became extremely foul—seaweed and shell-fish accumulating in such quantities as seriously to impede sailing; so that in June, 1825, much to the mortification of the inventor, orders were issued for the removal of the protectors.

In 1826 Davy's health had so far declined that he was with difficulty able to indulge in his favorite sports of angling and shooting; and on returning to London from Somersetshire he was unable to attend the anniversary dinner of the Royal Society. In January, 1827, he published his six anniversary discourses, delivered on awarding the Royal and Copley medals. Early in 1827 he was seized with an apoplectic attack, which rendered his removal to the Continent advisable. After some short stay at Ravenna he removed to Salzburg, whence on account of the continuance of his illness, he sent in his resignation of the presidency of the Royal Society. At the end of autumn he returned to England, and in the winter he published his *Salmonia*, a book of some interest, written in imitation of Isaac Walton's *Complete Angler*.

In 1828 Davy quitted England, and spent most of the summer and autumn at Laybach. In the winter he fixed his residence at Rome, whence he sent to the Royal Society "Remarks on the Electricity of the Torpedo," written in Illyria in October. This, with the exception of a posthumous work, entitled *Consolations in Travel, or the Last Days of a Philosopher*, was the final production of his pen. While at Rome, he was attacked by paralysis, from which he had already suffered. His wife and brother having hastened to his assistance, he left Rome for Geneva, where he died on the 29th of May, 1829. His remains were deposited on the 1st of June in the burying-ground outside the walls of that city.

Davy was of a sanguine, somewhat irritable temperament. To all his pursuits he devoted himself with a characteristic enthusiasm and firmness of purpose. His tone of mind, as indicated by his poems, was highly imaginative. "I attend Davy's lectures," said Coleridge, "to increase my stock of metaphors." The power and perspicacity of his intellect is sufficiently attested by his numerous and brilliant discoveries. He was not 21 years of age when he wrote—"It is only by forming theories, and then comparing them with facts, that we can hope to discover the true system of nature." As an experimenter he was remarkably quick; "with Davy," it has been remarked, "rapidity was power." Of the minor observances of etiquette he was careless, and his great frankness of disposition sometimes exposed him to annoyances which the exercise of tact and caution might have obviated. His manner in society, which gave to many the impression of a haughty consciousness of superiority, is ascribed by Dr. Paris to "an ungraceful timidity, which he could never conquer."

See Dr. J. A. Paris, *The Life of Sir Humphry Davy, 1831*; Dr. J. Davy, *Works of Sir Humphry Davy, 1839*. The former (vol. ii. pp. 450-456) contains a list of Davy's publications.

(P. H. S.)

DAWLISH, a watering-place of England, on the south coast of Devonshire, situated a little beyond the mouth of the Exe, twelve miles south of Exeter. It lies in a cove of the English Channel formed by two projecting cliffs, and is admirably sheltered from the weather. A small stream, which flows through the town, is lined on both sides by pleasure-grounds. The town is much resorted to during spring and early summer by the seekers after health. The parish contains an area of 551½ acres, and a population (1871) of 4241 persons, 2492 of whom are females.

DAX, formerly AX, or ACOA, the ancient *Aqua Turbelliana*, a town of France, at the head of an arrondissement in the department of Landes, situated in a fertile plain on the left bank of the Adour, 28 miles north-east of Bayonne, and connected by a fine stone bridge with the suburb of Sablar. It is still partially surrounded by its old tower-flanked

walls, which present, if not a genuine specimen, at least an interesting mediæval imitation, of Roman masonry; and it has a cathedral (rebuilt in the 18th century, but preserving a sculptured doorway and porch of the 13th), an old episcopal palace, a court-house, a prison, a mineralogical museum, and a training college. It manufactures earthenware, pitch, oil, chocolate, salt, and liqueurs, and carries on cork-cutting, ham-curing, and a trade in wine, brandy, grain, and timber. Its prosperity is further increased by its thermal springs, of which the most remarkable, rising in a great reservoir 20 feet deep in the Central Square, has a temperature of 155–166° Fahr., and sometimes discharges such volumes of steam as to envelop the whole town in a mist. **Dax**, as its ancient name implies, was the capital of the Tarbellii, and during the Roman period it ranked as the second town of Novempopulonia. For some time it was the seat of a viscount, and its bishopric was preserved till the Revolution. The church of St. Vincent derives its name from the first occupant of the see, and is interesting for its connection with the more famous St. Vincent de Paul. Population in 1871, 8154.

DAY. See ASTRONOMY and CALENDAR.

DAY, JOHN, a lyrical dramatist of the age of Elizabeth, of whose life no particulars have been transmitted to us, except that he was a student of Caius College, Cambridge. The first work which he is known to have produced is *The Isle of Gulls*, printed in 1606, a comedy founded upon Sir Philip Sidney's *Arcadia*. In 1607 he published a curious drama, written by him in conjunction with William Rowley and George Wilkins, *The Travels of Three English Brothers*, which detailed the adventures of Sir Thomas, Sir Anthony, and Robert Shirley. In the same year appeared *The Parliament of Bees*, the work on which Day's reputation mainly rests. This exquisite and unique drama, or rather masque, is entirely occupied with "the doings, the births, the wars, the wooings" of bees, expressed in a style at once most singular and most charming. In 1608 Day published two comedies, *Law Tricks* and *Humor out of Breath*. In 1610 there was licensed by him a comedy of *The Mad Franks of Merry Moll*, which has not survived. It is not known when he died, but his works were frequently reprinted before the civil wars, and as late as 1659 one of them, *The Blind Beggar of Bethnal Green*, first saw the light. The six dramas by John Day which we possess testify to a talent somewhat out of sympathy with the

main poetic current of his day. Except *The Parliament of Bees*, which is all in rhyme, his plays are in prose, with occasional rhymed passages of great lyrical sweetness. He preserved, in a great measure, the dramatic tradition of John Lyly, and affected a kind of subdued euphuism. It is, indeed, not impossible that the *Maid's Metamorphosis*, 1600, wrongly supposed to be a posthumous work of Lyly's, may be attributable to the youth of Day. It possesses, at all events, many of his marked characteristics. The beauty and ingenuity of *The Parliament of Bees* were noted and warmly extolled by Charles Lamb; but no effort has been made in our generation to revive his fame, and the works of this writer of very distinct and peculiar genius remain still unedited.

DAYTON, a city of the United States, the capital of Montgomery county, Ohio, situated on the east bank of the Great Miami, which is there joined by the Mad, 46 miles north of Cincinnati, and 135 miles south of Toledo. The Miami canal, which connects the Ohio river with Lake Erie, passes by the town; and this means of communication, along with that of the railroads which converge here from different points, has contributed greatly to the prosperity of the place. The city is very regularly laid out, and the houses and public edifices are better than in many other Western cities, partly owing to the comparatively moderate price of the white limestone, or marble, which abounds in its neighborhood. The principal public buildings are the county court-house—designed after the Parthenon at Athens, and erected at a cost of about £30,000—and the market-house, containing within its walls a city hall and the council chamber. There are, besides numerous churches, a high school, and the Cooper Academy, belonging to the Presbyterian body, for the instruction of females. Of charitable institutions the orphan asylum, the alms-house, and a lunatic asylum may be mentioned, and in the vicinity there is the Central National Soldiers' Home. A considerable manufacturing industry is carried on, which is facilitated by a copious supply of water conveyed from the Mad. There are several machine shops, and works for the manufacture of agricultural implements, railway carriages, paper, cotton, etc. The place, which was first settled in 1796, was incorporated as a town in 1805, and as a city in 1841. Population in 1850, 10,977; in 1860, 20,081; and in 1870 30,473.





NOT TO BE TAKEN  
FROM THE LIBRARY

